

SINCE 1889



ECONOMY INCUBATOR

Model: IC403CR/IC603CR/IC803CR
IC413CR/IC613CR/ IC813CR

Third edition

- Thank you very much for purchasing this Yamato ICR series incubator.
 - Please read the “Operating Instructions” and “Warranty” before operating this unit to assure proper operation. After reading these documents, be sure to store them securely together with the “Warranty” in a handy place for future reference.
- ⚠ Warning** : Before operating the unit, be sure to read carefully and fully understand important warnings in the operating instructions.

Yamato Scientific America Inc.

Table of contents

1. Safety precautions	1
Explanation of pictograms	1
List of symbols.....	2
Warning • Cautions.....	3
2. Before operating the unit	4
Precautions when installing the unit	4
Installation procedures • precautions	7
Operation panel.....	12
Explanation of characters	13
4. Operating procedures	14
List of operation modes and functions	14
Operation mode • function setting keys and characters	16
Operating procedures (settings for overheat prevention device).....	17
Operating procedures (fixed temperature operation).....	18
Operating procedures (quick auto stop operation).....	19
Operating procedures (auto stop operation).....	21
Operating procedures (auto start operation).....	23
Useful functions (calibration offset function).....	25
Useful function (setting lock function).....	26
5. Cautions on handling	27
6. Maintenance procedures	29
Daily inspection/maintenance	29
7. When the unit is not to be used for a long time or when disposing	30
When the unit is not to be used for a long time or when disposing.....	30
Notes about disposition	30
8. Troubleshooting	31
Safety device and error codes	31
When a malfunction is suspected	32
9. After sales service and warranty	33
When requesting a repair	33
10. Specifications	34
11. Wiring diagram	35
12. List of replacement parts	37
13. List of dangerous materials	38
14. Standard installation manual	39

1. Safety precautions

Explanation of pictograms

About pictograms

A variety of pictograms are indicated in this operation manual and on products to assure safe operation. Possible results from improper operation or disregard for these warnings is listed below.

Be sure to fully understand the descriptions below before proceeding to the text.



Warning

Indicates a situation which may result in death or serious injury (Note 1)



Caution

Indicates a situation which may result in minor injury (Note 2) and property damage (Note 3).

- (Note 1) Serious injury means a wound, an electrical shock, a bone fracture or intoxication that may leave after effects or require hospitalization or outpatient visits for a long time.
- (Note 2) Minor injury means a wound or an electrical shock that does not require hospitalization or outpatient visits for a long time.
- (Note 3) Property damage means damage to facilities, devices and buildings or other properties.

Meanings of pictograms



This pictogram indicates a matter that encourages the user to adhere to warning ("caution" included).
Specific description of warning is indicated near this pictogram.



This pictogram indicates prohibitions
Specific prohibition is indicated near this pictogram.



This pictogram indicates matters that the user must perform.
Specific instruction is indicated near this pictogram.

1. Safety precautions

List of symbols

Warning



General warnings



Danger!: High voltage



Danger!: High temperature



Danger!: Moving part

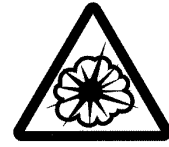

Danger!: Hazard of explosion

Caution



General cautions



Electrical shock!



Burning!



Caution for no liquid heating!



Caution for water leak!



For water only



Poisonous material

Prohibitions



General Prohibition



Fire Prohibited



Do not disassemble



Do not touch

Compulsions



General compulsions



Connect ground wire



Install levelly

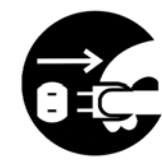

Pull out the power plug



Regular inspection

1. Safety precautions

Warning · Cautions

Warning



Never operate the unit in an atmosphere containing flammable or explosive gas

Never operate the unit in an atmosphere containing flammable or explosive gas. Otherwise, an explosion or a fire may result since the unit is not explosion-proof. See section "13. List of dangerous materials" on page 38.



Be sure to connect the ground wire.

Be sure to connect the ground wire correctly. Otherwise, electrical leak may result and cause an electrical shock or a fire.



Ban on operation when an abnormality occurs

When smoke or an unusual odor is seen or smelled, immediately turn the ground fault interrupter on the main unit off and pull out the power plug. A fire or an electrical shock may result.



Never use electrical power cords bundled.

When these are used bundled, they might overheat causing a fire.



Take care not to damage electrical power cords.

Avoid tightly bending, pulling with a strong force or twisting to prevent electrical power cords from damage. A fire or an electrical shock may result.



Never use an explosive or a flammable material with this unit.

Never use an explosive material, a flammable material or a material containing explosive or flammable elements. An explosion or an electrical shock may result. See section "13. List of dangerous materials" on page 38



Never try to touch a hot part.

Some parts of the unit are hot during and immediately after operation. Take special care to avoid burns.



Never try to disassemble or alter the unit.

Never try to disassemble or alter the unit. A malfunction, a fire or an electrical shock may result.



Caution



When thunder is heard.

When thunder is heard, turn the main power off immediately. A malfunction, fire or an electrical shock may result.

2. Before operating the unit

Precautions when installing the unit

1. Carefully select an installation site.



Take special care not to install the unit at a place described below:

- Uneven surfaces or dirty surfaces
- Where flammable gas or corrosive gas exists
- Where the ambient temperature is 35°C or more
- Where temperature changes severely
- Where humidity is high
- Where subject to direct sunlight
- Where vibration is severe



Install this unit at a place with spaces shown below.

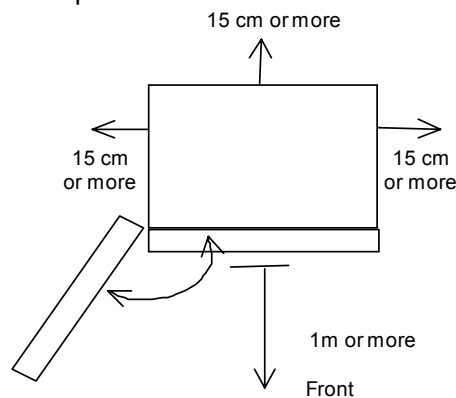

2. Install the unit on a level surface.



Install the unit on a level surface. If the whole bottom surface of the unit does not contact the surface evenly, vibrations or noises may result. This might cause unexpected troubles or malfunctions.

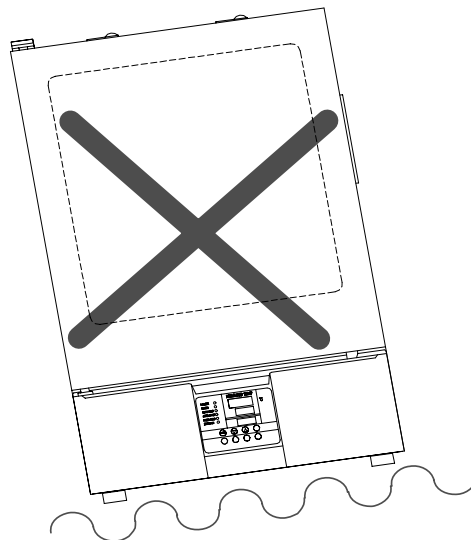

Weight of the units is: Model IC403CR/413CR: approx. 45 kg;
Model IC603CR/613CR: approx. 65 kg; Model IC803CR/813CR: approx. 102 kg.
When lifting the unit for transportation and installation, carefully handle it by at least two people.

3. Installation



The unit might fall down or move by an earthquake or an impact resulting in a personal injury. We recommend taking safety measures such as to avoid installing the unit in a high traffic area.

2. Before operating the unit

Precautions when installing the unit

4. Secure sufficient ventilation for the unit.

- Do not operate the unit when its vent holes on the side and rear panels are covered or blocked. Internal temperature of the unit will rise, degrading the performance, and an accident, a malfunction or a fire may result.

5. Do not operate the unit at such a place that may subject to splashing liquids.

- Do not operate the unit at such a place that may subject to splashing liquids. Liquid entering the inside may cause an accident, a malfunction, an electrical shock or a fire.

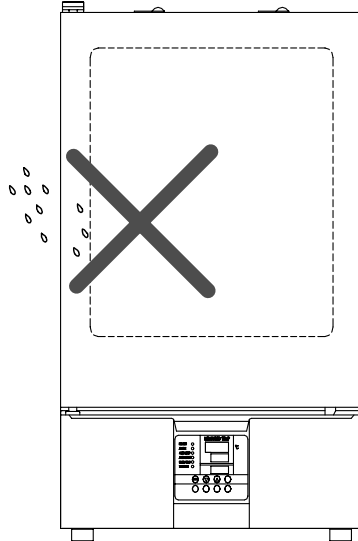

6. Never operate the unit in an atmosphere containing flammable or explosive gas.

- Never operate the unit in an atmosphere containing flammable or explosive gas. Since the unit is not explosion-proof, an arc is discharged when switching the circuit breaker "ON" and "OFF" and during operation, could cause a fire or an explosion. See the section "13. List of dangerous materials" on page 38 for flammable and explosive gases.

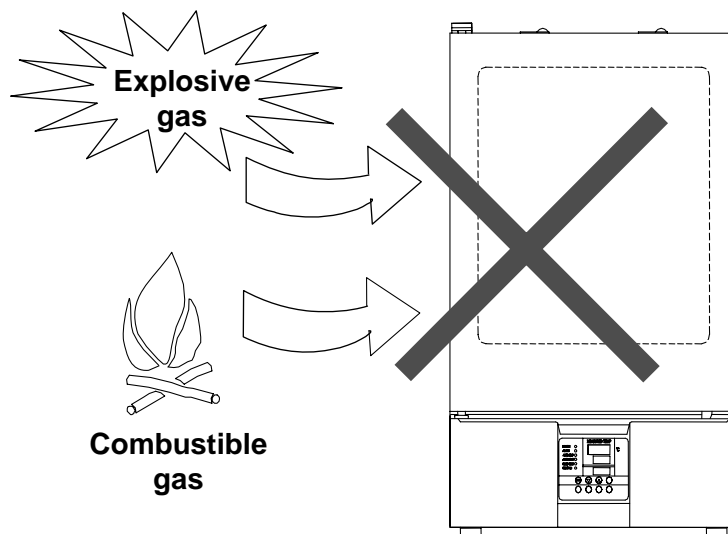

2. Before operating the unit

Precautions when installing the unit

7. Be sure to connect the power plug to the dedicated power distribution panel or a wall outlet.

! Use a power distribution panel or a wall outlet that meets the electrical capacity of the unit.

Electrical capacity:	IC403CR	VAC115	2.8A	IC413CR	VAC220	1.4A
	IC603CR	VAC115	3.7A	IC613CR	VAC220	1.8A
	IC803CR	VAC115	6.6A	IC813CR	VAC220	3.3A

- * When the unit will not start even when you turn the ground fault interrupter to "ON", check for low main voltage or if the unit is connected to the same power supply line as other devices and connect it to another line if necessary.

Avoid connecting too many devices using a branching outlet or extending a wire with a cord reel or temperature controlling function may degrade due to voltage drop.

! Do not connect the unit to a gas pipe, a water pipe or a telephone line or any parts or lines, other than a correct power supply line. Otherwise, an accident or a malfunction may result.

8. Handling of a power cord

⊘ Never use electrical power cords bundled. When these are used bundled, they might overheat causing a fire.

Do not convert, forcibly bend, twist or pull the power cord. Otherwise, a fire or an electrical shock may result.

Do not place the power cord under a desk or a chair, or sandwich between objects to avoid it from being damaged. Otherwise, a fire or an electrical shock may result.

Do not place the power cord close to a stove or other heat generating device. Sheath of the cord may burn and result in a fire or an electrical shock.

! If the power cord should be damaged (exposure of core wire or disconnection), immediately turn the power switch off, pull out the power cord (plug) out of the power supply and ask your dealer to replace the cord. Otherwise, a fire or an electrical shock may result.

Connect the power cord to an appropriate wall outlet.

9. Be sure to connect the ground wire.

- !** When the unit has no ground terminal, class D grounding work is necessary and please consult your dealer or our nearest sales office.
- !** Securely connect to an outlet.

We recommend use of a ground type outlet tap.

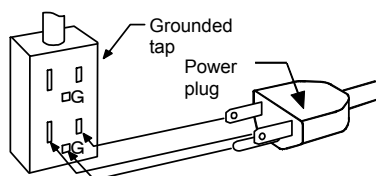

When there is no ground terminal.

In this case, class D grounding work is necessary and please consult your dealer or our nearest sales office.

When a bipolar type outlet tap is used

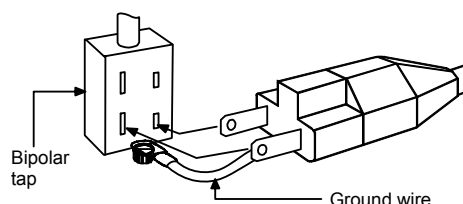

Insert the ground adaptor included as an option, into a power plug confirming the polarity of the outlet. Connect the grounding wire (green) of the ground adaptor to the ground terminal on the power supply equipment.

⊘ Do not connect the grounding wire to a gas pipe, a water pipe or a telephone line or any parts or lines other than a correct grounding terminal. Otherwise, an accident or a malfunction may result.

2. Before operating the unit

Installation procedures • precautions

(1) Transportation of the product

- Lift and transport the model IC403CR/413CR/603CR/613CR by at least two people.

*Take care for protrusions on the unit.

- Move the model IC803CR/813CR after push two stoppers up to unlock the casters on the front side of the main unit as shown in the figure right. Make sure casters at the four points move smoothly before trying to move the unit.

* Note that moving the unit over a bump may give an excessive impact to and break the casters. Where there is such a bump, move the unit by lifting it by at least two people.

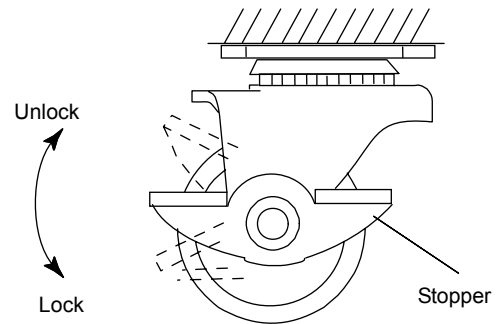

(2) Select an installation site.

Make sure that four caster wheels for right, left, front and rear securely rest on a flat surface as well as there is no loosened part or inclination of the unit and push down the caster stopper to lock for the model IC803CR/813CR.

(3) Install shelf boards.

- The lowest shelf board has been secured with screws at the time of shipping from the factory.

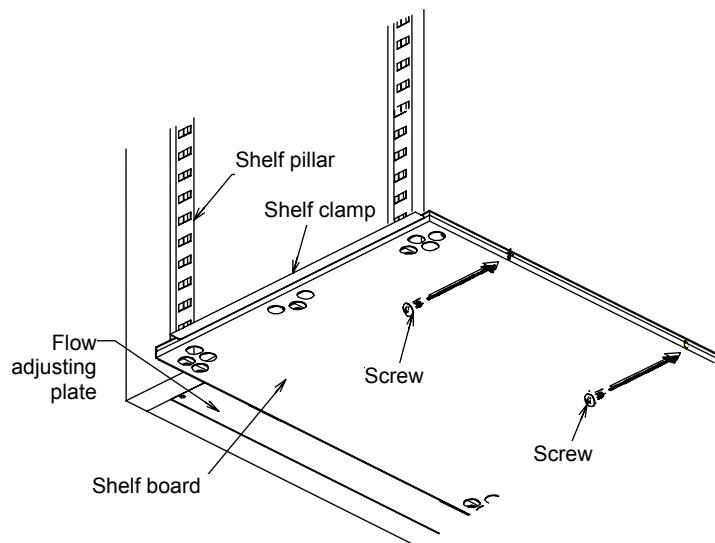

2. Before operating the unit

Installation procedures • precautions

- Install shelf pegs at heights you want on the right and left shelf posts in the internal chamber of the main body.
- Completely push shelf boards by sliding to the end.
 - *Take care to put each shelf board on correct pairs of right and left shelf pegs.
- Make sure that shelf boards will not fall nor rattle.
- Withstand load of each shelf board is 15kg in even loading. When putting samples, arrange them as dispersed as possible.

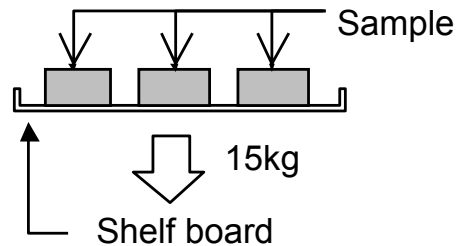

- Put samples with spaces between them. Too many samples may prevent proper temperature control. To assure proper temperature control, put samples with a space at least 30% of the shelf board area.

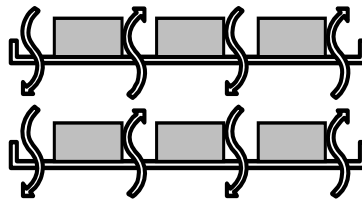

Make at least 30% of space

- (4) Do not put a sample on the bottom of the internal chamber.
- Operating the unit with a sample directly put on the bottom of the internal chamber might degrade its temperature characteristics. Also it may cause corrosion, damage or rusting of the internal chamber and burning of samples or a fire. Never put any sample on the bottom surface.
 - When putting samples, take care not to allow them touching the wall, where sensor or other devices are installed. Put samples on the shelf board included with the unit.

2. Before operating the unit

Installation procedures • precautions

- (5) Take special care for samples shown below:
- ① Samples that contain flammable or explosive components
 - The unit is not explosion proof. Never attempt to dry or process materials that contain flammable or explosive components.
 - ② Corrosive samples
 - Take care for handling of corrosive samples. Although stainless steel is used for major components, note that they might corrode with strong acid. Note that packing may corrode with acid, alkali, oil or organic solvents.
 - ③ Operation with devices with a larger heat load installed.
 - Note that temperature in the chamber may rise when operating the unit within a device.
- (6) About exhaust ports.
- IC403CR/413CR/603CR/613CR model : Located on the top of the unit, IC803CR/813CR model : Located on either side of the unit.
- Adjust the open amount according to the water content of a specific sample.

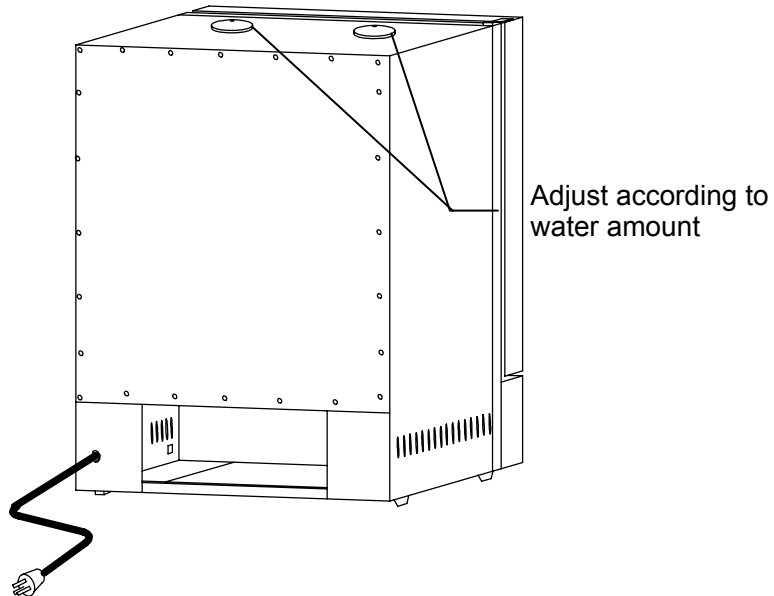

(403CR/413CR/603CR/613CR model is shown in the diagram above.)

3. Names and functions of parts

Main body

Front view of IC403CR/413CR/603CR/613CR

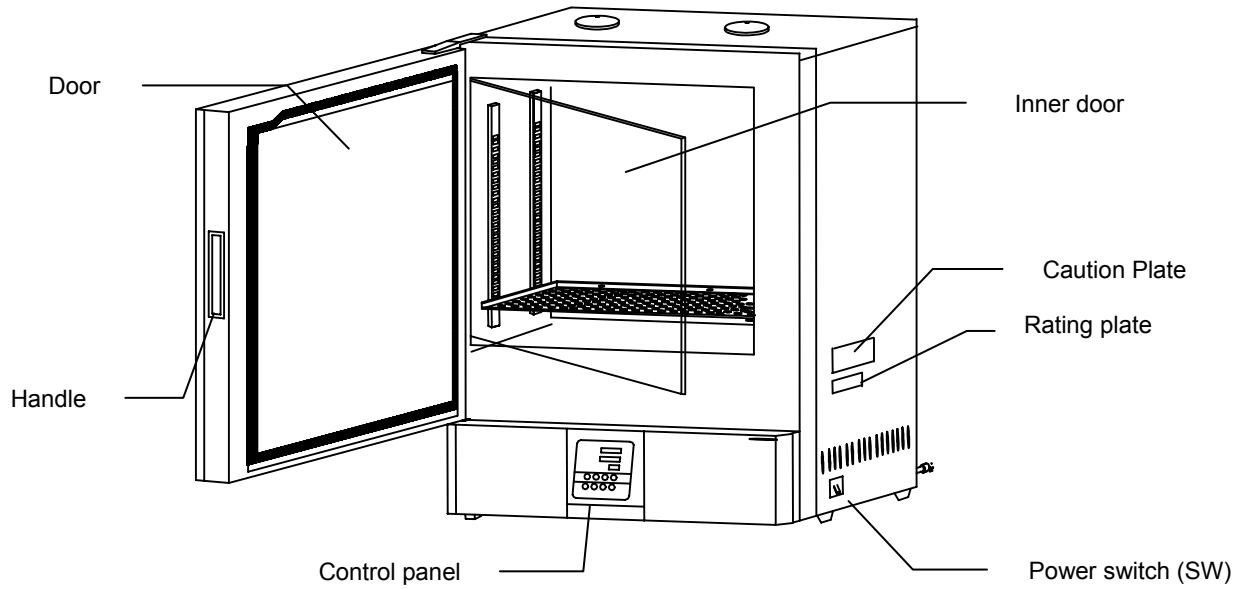

Rear view of IC403CR/413CR/603CR/613CR

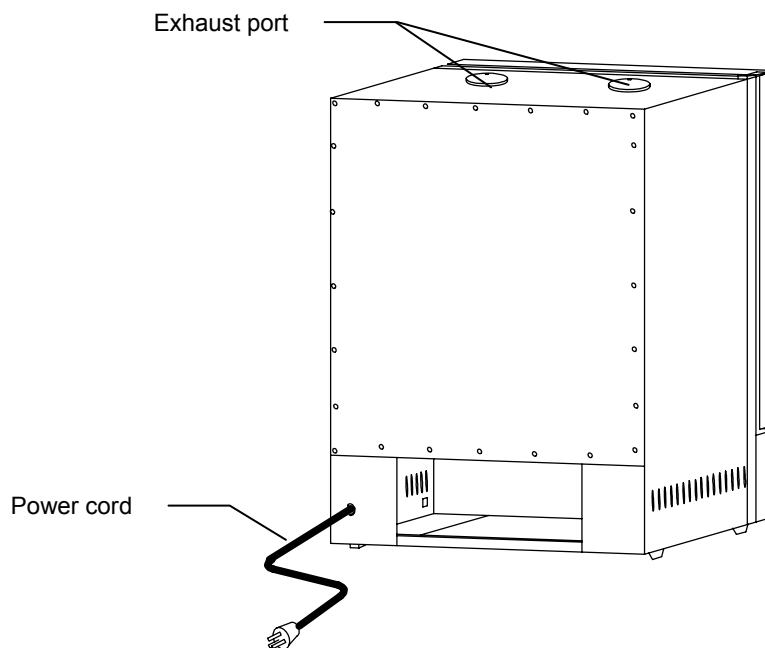

3. Names and functions of parts

Main body

Front view of IC803CR/813CR

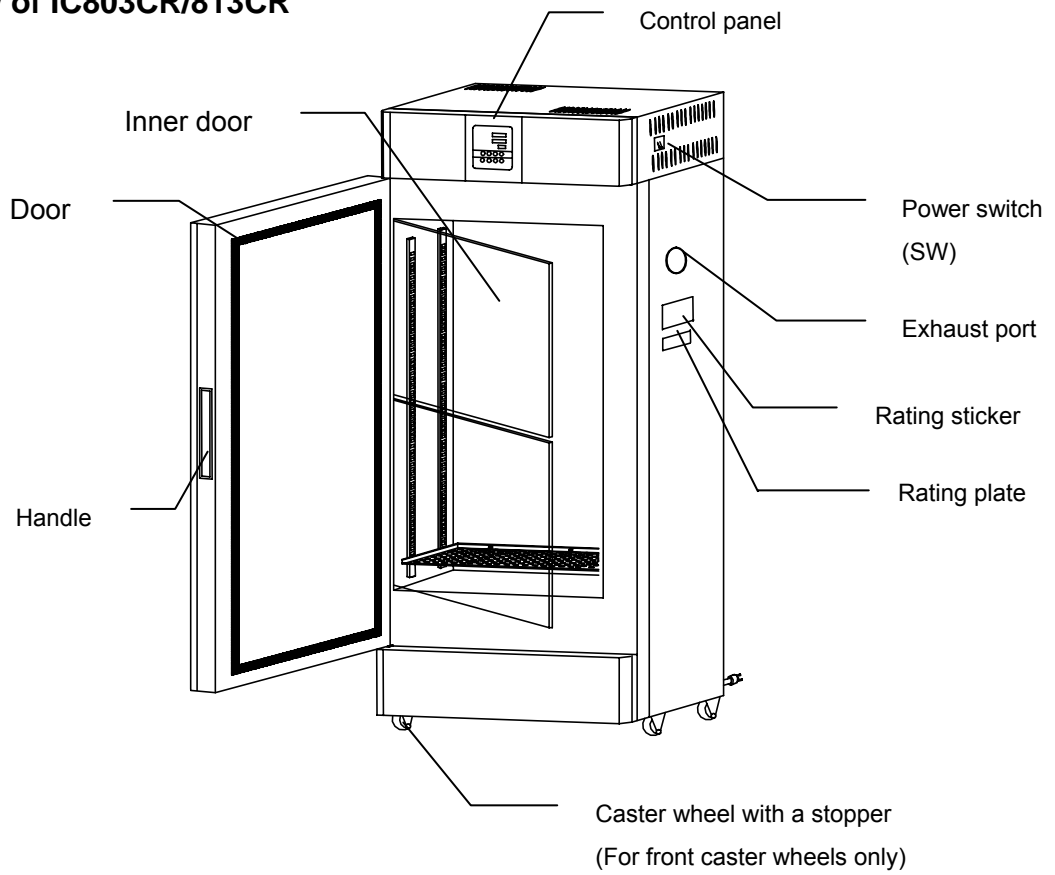

Rear view of IC803CR/813CR

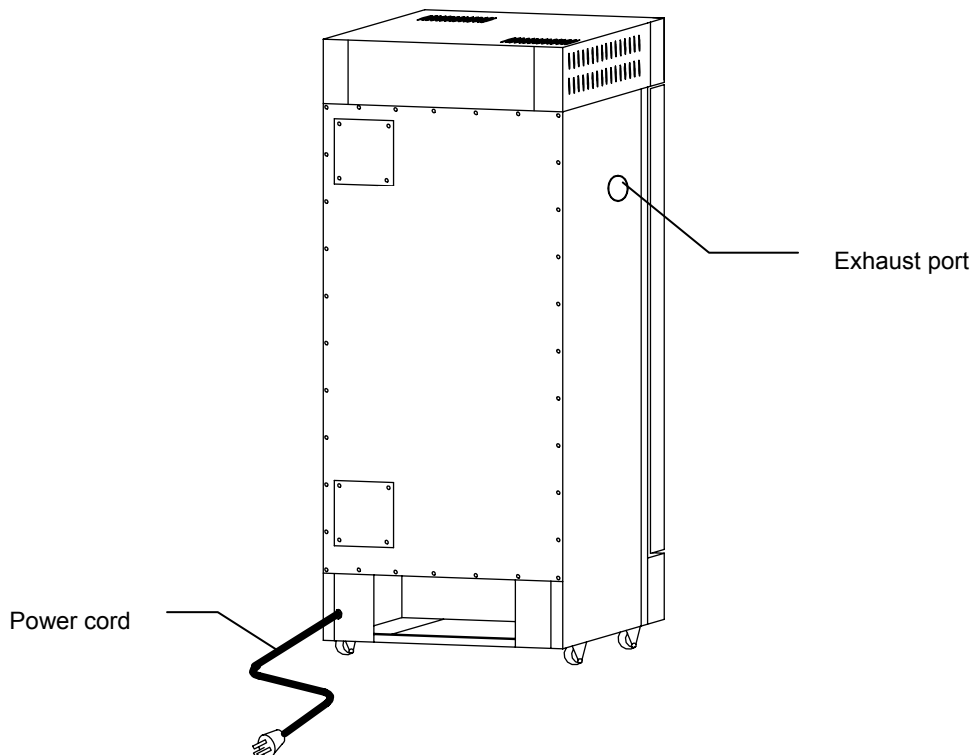

3. Names and functions of parts

Operation panel

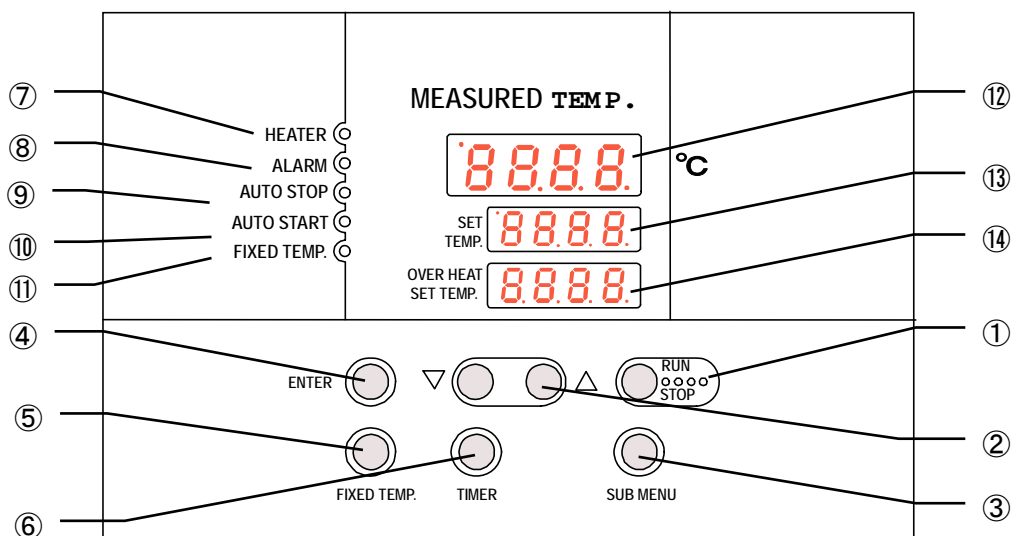







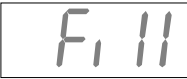

No.	Name	Operation/action
①	RUN/STOP key	Used for starting/stopping operation.
②	▼▲ keys	Used for selecting settings.
③	SUB MENU key	Key for setting temperature of the overheat prevention device, calibration offset temperature, or the key lock function.
④	ENTER key	Used for determining a selected setting.
⑤	FIXED TEMP. key	Key for selecting fixed temperature operation.
⑥	TIMER key	Key for selecting timer operation settings. Quick auto stop operation, auto stop operation or auto start operation can be selected.
⑦	HEATER lamp	Illuminates while heater power is on.
⑧	ALARM lamp	When an error occurs, the lamp illuminates with an audible buzzer.
⑨	AUTO STOP lamp	Flashes while the quick auto stop timer is being set and illuminates while the unit is in operation. Flashes while the auto stop timer is being set and illuminates while the unit is in operation.
⑩	AUTO START lamp	Flashes while the auto start timer is being set and illuminates while the unit is in operation.
⑪	FIXED TEMP. lamp	Flashes while fixed temperature operation is being set and illuminates while the unit is in operation.
⑫	MEASURED TEMP.screen	Displays measured temperature in the bath • set characters • alarm information.
⑬	SET TEMP. screen	Displays a set temperature, timer settings and timer remaining time.
⑭	OVER HEAT SET TEMP. screen	Displays the set temperature for the overheat prevention device.

3. Names and functions of parts

Explanation of characters

Characters on the controller are explained in this section.

Characters	Identifier	Name	Application
	FiX	Fixed temperature operation setting	Used for setting fixed temperature operation.
	Sv	Temperature setting	Used for setting a temperature.
	ASTP	Auto stop setting	Used for setting auto stop operation.
	ASTr	Auto start setting	Used for setting auto start operation.
	tim	Time setting	Used for setting a time.
	End	Time up	Displayed when timer operation has ended. See page 19, 22.
	cAL	Calibration Offset setting	Used for inputting a calibration offset temperature See section "Using the calibration offset function" on page 25.
	oH	Setting overheat protection temperature	Used for setting an overheat protection device temperature. See section "Operating procedures (settings for overheat prevention device)" on page 17.
	Lock	Key lock of settings	Key locks settings to prevent their alteration See section "Using the lock function" on page 26.

*See the section "Operation mode · function setting keys and characters" on page 16 for characters of operation modes and functions.

4. Operating procedures

List of operation modes and functions

Operation modes of the unit are as shown below:

No.	Name	Description	Page
1	Fixed temperature operation	Pressing the FIXED TEMP. key to enter the Fixed temperature operation setting mode. Pressing the FIXED TEMP. key again to enter the temperature setting mode. Set a temperature with the ▼▲ keys. Pressing the RUN/STOP key to start operation, and pressing the RUN/STOP key again to stop operation.	P.18
2	Quick auto stop operation	Used when you want to “stop fixed temperature operation being performed automatically in several hours.” Pressing the TIMER key during the fixed temperature operation to enable setting a time before operation stops. Set a duration before stop with the ▼▲ keys. Pressing the RUN/STOP key starts quick auto stop operation and activates the timer in the middle of it to automatically stop it after the set period of time.	P.19
3	Auto stop operation	Used when you want to “set automatic stop for fixed temperature operation when making settings for it.” Press the TIMER key to display “AStP.” Pressing the ENTER key to set the temperature setting “Sv.” Pressing the ENTER key again to enable setting of the operation time “tim.” Pressing the RUN/STOP key starts auto stop operation.	P.21
4	Auto start operation	Used when you want to “start operation automatically after several hours” after power is turned on. Press the TIMER key to display “AStr.” Pressing the ENTER key to set the temperature setting “Sv.” Pressing the ENTER key again to enable setting of the operation time “tim.” Pressing the RUN/STOP key starts auto start operation.	P.23
* Operation mode cannot be changed while the unit is in operation. First stop operation before changing the mode.			

4. Operating procedures

List of operation modes and functions

Functions of the unit are as shown below:

No.	Name	Description	Page
1	Overheat prevention function	<p>Automatic overheat prevention function: This function is linked to the unit set temperature and has been set to so that it is automatically activated (returned automatically) at a temperature 6°C higher than the set temperature in the bath.</p> <p>Overheat prevention device: Although the power supply, the display and the key input assembly are in common with the controller, the device consists of the standalone temperature measurement circuit, the CPU, the sensor, and the output circuit enabling to set to a temperature you want on the operation panel. If the overheat prevention device is triggered, the unit will stop and will not recover until the ELB is turned on again. (Manual recovery) This compensation can be set with the SUB MENU keys.</p>	P.17
2	Calibration offset function	<p>Calibration offset function compensates any differences between the target temperature in the bath and the control temperature of the controller (sensor temperature.) The function can compensate to either plus or minus side for the whole temperature band of the unit. This compensation can be set with the SUB MENU keys.</p>	P.25
3	Setting lock function	<p>This function locks the set operation status. The lock can be set or released with the SUB MENU key.</p>	P.26
4	Power outage compensation function	<p>When power outage occurs in the middle of operation, the operation resumes from the settings immediately before the power outage.</p>	—

4. Operating procedures

Operation mode - function setting keys and characters

Key operations and characters in the diagram below are used for operation mode and function settings.

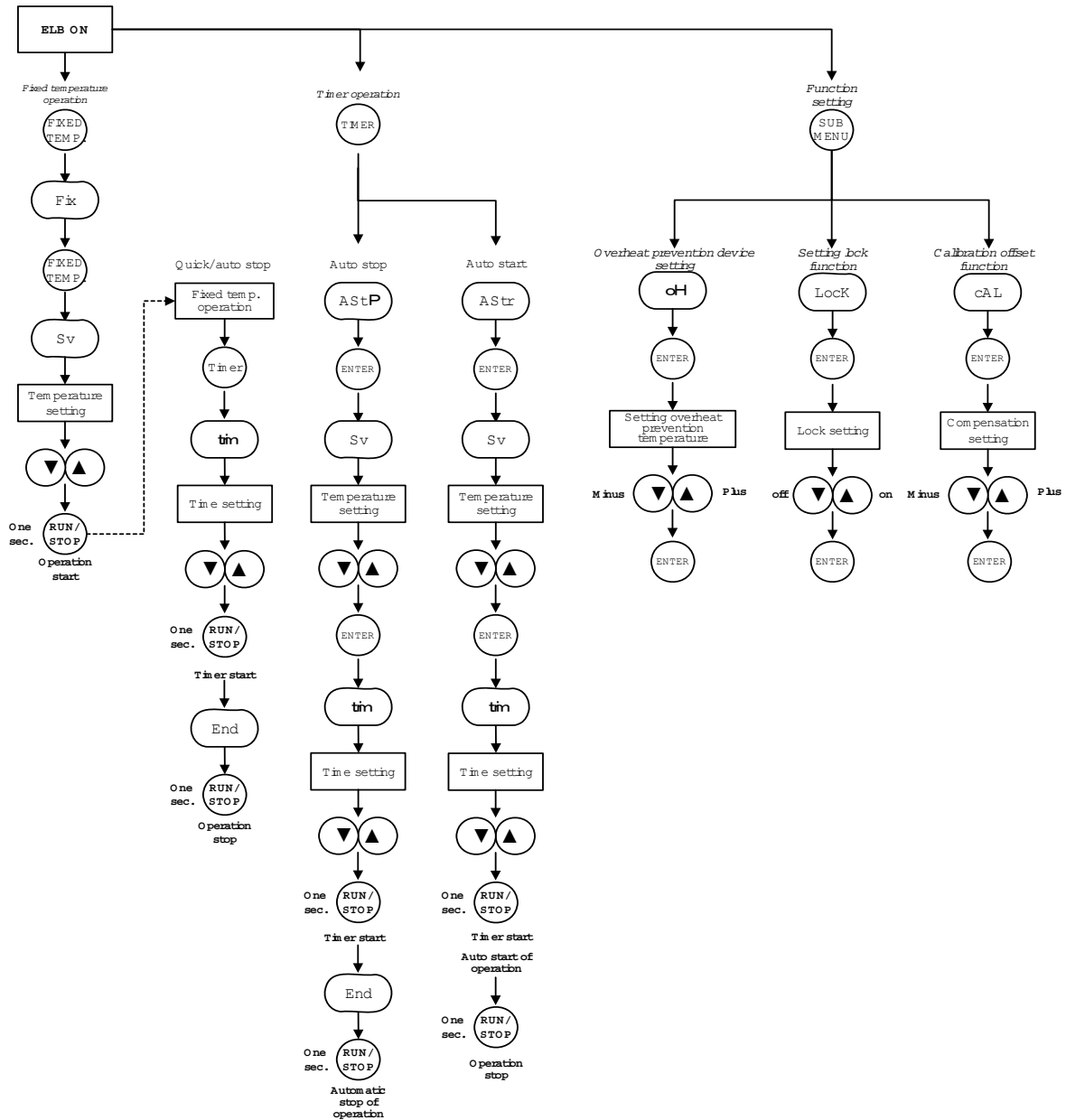

4. Operating procedures

Operating procedures (settings for overheat prevention device)

The safety device for preventing overheat has the automatic overheat prevention function for the controller (automatic recovery) and has the power supply, the display and the key input assembly in common with the controller as well as it has an overheat prevention device (manual recovery) as a secondary safety measures that consists of separate temperature measurement circuit, the CPU, the sensor and the output circuit.

Temperature setting range and functions

The device has overheat prevention function in double. One is the function integrated in the controller, which is designed to be activated automatically at a temperature 6°C above the set temperature of the temperature controller (the heater is turned OFF at +6°C) at the time of shipping from the factory.

Another is integrated with the controller and is set with the keys on the controller.

The secondary overheat prevention function is added by this setting.

The temperature range settable for the overheat prevention device integrated with the controller is "0°C to the 50°C + the highest set temperature for the device."

When the temperature in the bath keeps rising beyond the controller set temperature and reaches the set temperature of the overheat prevention device, the circuit trips, Er19 flashes on the controller screen, and the buzzer continues to sounds.

When the overheat prevention device is activated, Er19 will not be released until the ELB is turned on.

How to set temperature

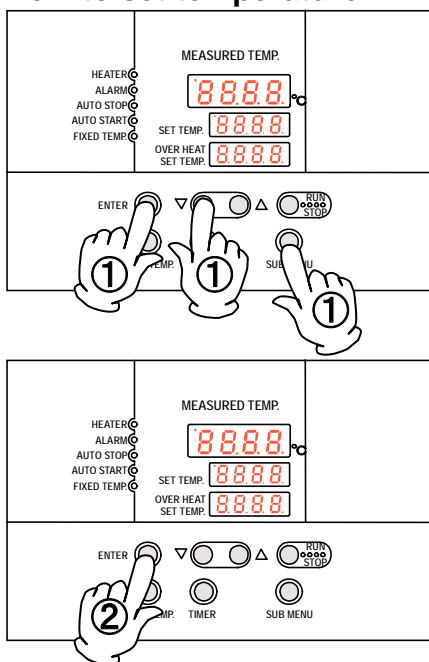

1. Turn the ELB ON. (Turn the ELB to "ON.")

When the ELB is turned ON, the initial values will be displayed for about four seconds, then the initial screen will appear and the current bath temperature, operation mode character and the overheat prevention set temperature are displayed on each of the display screens.

2. Setting the overheat prevention temperature

① Press the **SUB MENU** key, select the character

oH that indicates overheat prevention using the **▼▲** keys and press the **ENTER** key.

The current set time is displayed blinking on the SET TEMP. screen.

Caution: In general, set to a temperature at least 10°C higher than the controller set temperature to prevent the device from malfunctioning.

② When the temperature you want is obtained with the **▼▲** keys, press the **ENTER** key to complete setting.

Caution

- ① Set temperature as "highest operation temperature for the unit +10°C" or "set temperature +10°C" as a rough standard and add 5°C to the setting if the device functions improperly.
- ② The temperature range settable for the overheat prevention device is "0°C to the 50°C + the highest set temperature for the device." Be sure to set the overheat prevention activation temperature correctly otherwise the device may not start, the overheat prevention device is activated before temperature in the bath increases completely, or a fire or other unexpected accidents may result.
The temperature is set at 90°C on shipping from the factory.
- ③ The overheat prevention device has been designed to prevent overheating of devices not to protect samples. The device does not prevent accidents caused from use of explosive or flammable substances.

4. Operating procedures

Operating procedures (fixed temperature operation)

How to start fixed temperature operation

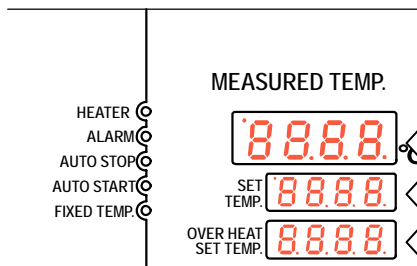

1. Turn the ELB ON. (Turn the ELB to “ON.”)

When the ELB is turned ON, the initial values will be displayed for about four seconds, then the initial screen will appear and the current bath temperature, operation mode character and the overheat prevention set temperature are displayed on each of the displays.

Measured temperature screen: Indicates the current bath temperature

Set temperature screen: Indicates operation mode characters

Overheat prevention set temperature screen: Indicates the set temperature for the overheat prevention device.

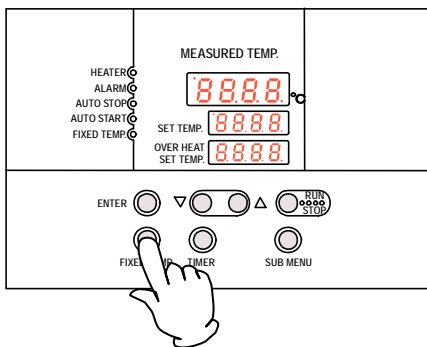

2. Selecting an operation mode

Characters FiX Fi || blink on the SET TEMP. screen to indicate the fixed temperature operation is active.

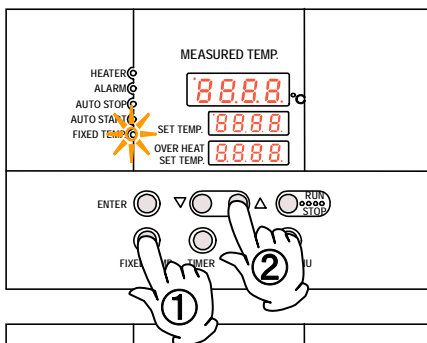

3. Setting the temperature

① Press the FIXED TEMP. key.

The character Sv 50 that indicate a set temperature is displayed on the MEASURED TEMP. screen on which the current set temperature flashes and the FIXED TEMP. lamp flashes.

② Set a temperature using the ▼▲ keys.

Temperature can be set to the first decimal point.

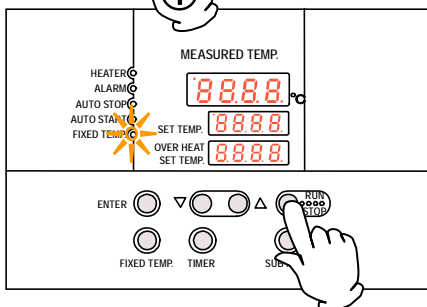

4. Starting operation

Press the RUN/STOP key for about one second.

Operation starts and status of the FIXED TEMP. lamp changes from flashing to illuminated.

5. Stopping operation

Press the RUN/STOP key for about one second.

Operation stops, the FIXED TEMP. lamp goes off and the screen switches to the initial setting screen.

When you want to correct setting errors or confirm settings

When you made a mistake during setting or reconfirm settings you made, press the FIXED TEMP. key again to resume setting.

When you want to change set temperature during operation, press the FIXED TEMP. key to enter the setting mode and change the set temperature. After change has been made, press the ENTER key to complete the process.

4. Operating procedures

Operating procedures (quick auto stop operation)

Used when you want to “stop fixed temperature operation being performed automatically in several hours. Quick auto stop operation is a function to enable auto stop timer setting during operation.

Procedures for quick auto stop operation

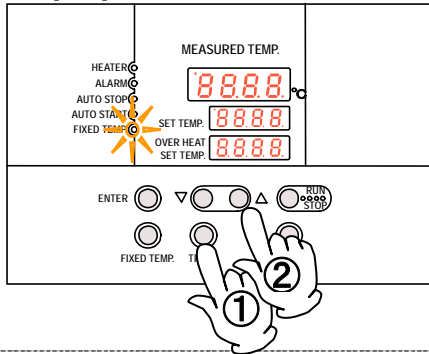

1. Setting time period before stop during fixed temperature operation

① Make sure that the FIXED TEMP. lamp is illuminated to indicate the unit is in operation.

Press the **TIMER** key.

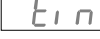
The character tim  that indicates the timer is displayed on the MEASURED TEMP. screen and the current set time flashes on the SET TEMP. screen.

② Set a duration you want using the ▼▲ keys.

About the timer function

The maximum time that can be set for the timer is 999 hours 50 minutes.

Up to 99 hours 59 minutes, time can be set in minutes.

One hundred hours and over are set only in 10 minutes.

Keep the ▼▲ keys pressed to continuously change set time and you can quickly reach the time you want. Press the ▼▲ keys once at a time for fine adjustment.

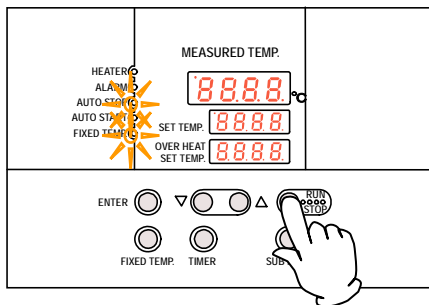

2. Starting timer operation

When you have set a time you want, start the **RUN/STOP** key for about one second.

Timer operation starts with the FIXED TEMP. lamp and the AUTO STOP lamp are illuminated.

Timer starts counting when the **RUN/STOP** key is pressed.

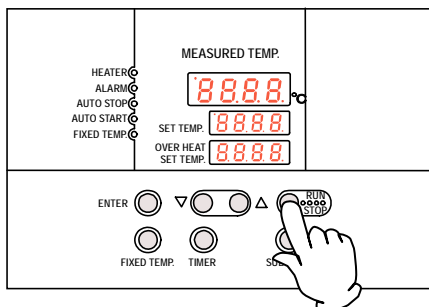

3. Stopping and ending timer operation

Operation stops automatically when the set temperature has elapsed.

The buzzer sounds for about five seconds to indicate operation has stopped. At this time, the character

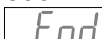
End  that indicates operation end is displayed on the SET TEMP. screen with the FIXED TEMP. lamp and the AUTO STOP lamp are illuminated. Press the **RUN/STOP** key for approx. one second to end the timer operation mode. The screen switches to the initial setting screen.

4. Operating procedures

Operating procedures (quick auto stop operation)

When you want to correct set temperature or set time, or confirm settings

When you want to change set temperature during operation, press the **FIXED TEMP.** key to enter the setting mode and change the set temperature. After change has been made, press the **ENTER** key to complete the process. When you want to change set time during operation, press the **TIMER** key to enter the setting mode and change the set time. Note, however, you need to set a time calculated by adding the time already passed to the time to be added. After change has been made, press the **RUN/STOP** key to complete the process.

Pressing the **▼** key will display the set temperature, the operation mode and the remaining time on the SET TEMP. display.

4. Operating procedures

Operating procedures (auto stop operation)

Procedures for auto stop operation

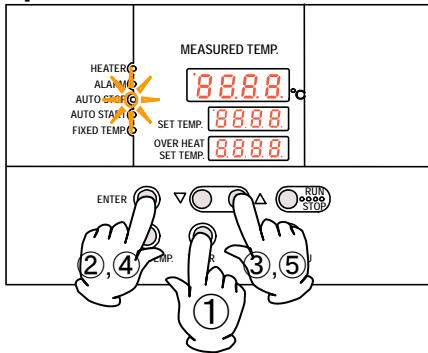

1. Setting a stop time

① Press the **TIMER** key when you are in the initial screen to blink characters **ASStP** on the SET TEMP. screen that indicate auto stop operation.

② Press the **ENTER** key.

The character **Sv** **50** that indicate a set temperature is displayed on the MEASURED TEMP. screen on which the current set temperature and the AUTO STOP lamp blink.

③ Set a temperature using the **▼▲** keys.

Temperature can be set to the first decimal point.

④ Press the **ENTER** key.

The character **tim** **610** that indicates the timer is displayed on the MEASURED TEMP. screen and the set time flashes on the SET TEMP. screen.

⑤ Set a time you want using the **▼▲** keys.

About the timer function

The maximum time that can be set for the timer is 999 hours 50 minutes.

Up to 99 hours 59 minutes, time can be set in minutes.

One hundred hours and over are set only in 10 minutes.

Keep the **▼▲** keys pressed to continuously change set time and you can quickly reach the time you want. Press the **▼▲** keys once at a time for fine adjustment.

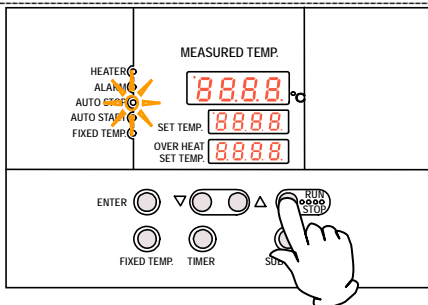

2. Starting timer operation

When you have set a time you want, start the **RUN/STOP** key for about one second.

Timer operation starts with the AUTO STOP lamp is illuminated.

Timer starts counting when the temperature in the bath (measured temperature) reaches the set temperature.

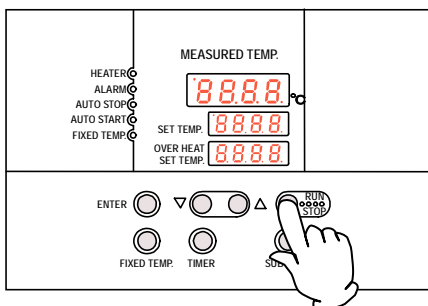

3. Stopping and ending timer operation

Operation stops automatically when the set temperature has elapsed.

The buzzer sounds for about five seconds to indicate operation has stopped. At this time, the character

End that indicates operation end is displayed on the SET TEMP. screen with the FIXED TEMP. lamp and the AUTO STOP lamp are illuminated. Press the **RUN/STOP** key for approx. one second to end the timer operation mode. The screen switches to the initial setting screen.

4. Operating procedures

Operating procedures (auto stop operation)

When you want to correct set temperature or set time, or confirm settings

When you want change the set temperature or a set time, press the **TIMER** key during operation, set temperature and time for the auto stop operation with the ▼▲ keys and press the **ENTER** key to complete.

Note, however, when you change the set time you need to set a time calculated by adding the time already passed to the time to be added.

Pressing the ▼ key during operation will display the set temperature, the operation mode and the remaining time on the SET TEMP. display.

In terms of the remaining time display  a blinking dot indicates count down and an illuminating dot indicates a wait status (while temperature is increasing or decreasing to the set temperature) during which the timer has stopped counting.

4. Operating procedures

Operating procedures (auto start operation)

Procedures for auto start operation

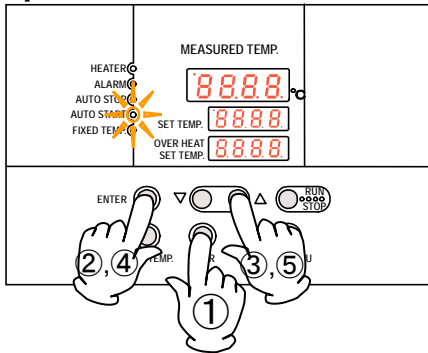

1. Setting an operation start time

① Press the **TIMER** key when you are in the initial screen to blink characters AStr **AStr** on the SET TEMP. screen that indicate auto start operation.

② Press the **ENTER** key.

The character SV **SV** that indicate a set temperature is displayed on the MEASURED TEMP. screen on which the current set temperature flashes and the AUTO START lamp flashes.

③ Set a temperature you want using the **▼▲** keys.

Temperature can be set to the first decimal point.

④ Press the **ENTER** key.

The character tim **tim** that indicates the timer is displayed on the MEASURED TEMP. screen and the set time flashes on the SET TEMP. screen.

⑤ Set a time you want using the **▼▲** keys.

About the timer function

The maximum time that can be set for the timer is 999 hours 50 minutes.

Up to 99 hours 59 minutes, time can be set in minutes.

One hundred hours and over are set only in 10 minutes.

Keep the **▼▲** keys pressed to continuously change set time and you can quickly reach the time you want. Press the **▼▲** keys once at a time for fine adjustment.

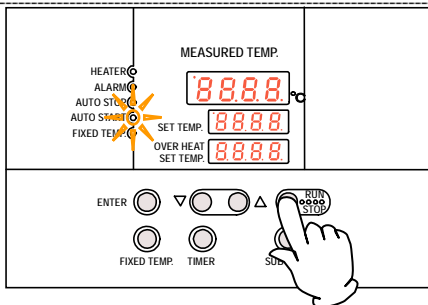

2. Starting timer operation

When you have set a time you want, start the **RUN/STOP** key for about one second.

Timer operation starts with the AUTO START lamp is illuminated.

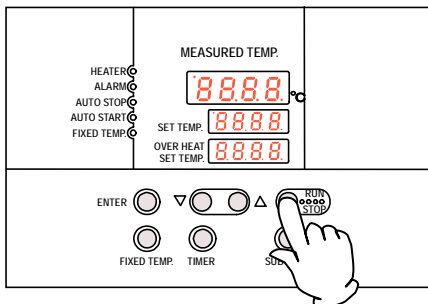

3. Stopping and ending timer operation

Operation stops automatically when the set temperature has elapsed.

To stop or finish operation, press the **RUN/STOP** key for approx. one second to end the timer operation mode.

The screen switches to the timer setting screen.

4. Operating procedures

Operating procedures (auto start operation)

When you want to correct set temperature or set time, or confirm settings

When you want change the set temperature or a set time, press the **TIMER** key during operation, set temperature and time for the auto start operation with the ▼▲ keys and press the **ENTER** key to complete.

Note, however, when you change the set time you need to set a time calculated by adding the time already passed to the time to be added.

Pressing the ▼ key during operation will display the set temperature, the operation mode and the remaining time on the SET TEMP. display.

When operation has started after the auto start time, you cannot change the set time. In this case, first stop operation with the **RUN/STOP** key and repeat all settings.

4. Operating procedures

Useful functions (calibration offset function)

Using the calibration offset function

Calibration offset function compensates any differences between the target temperature in the bath and the control temperature of the controller (sensor temperature.) The function can compensate in parallel to either plus or minus side for the whole temperature band of the unit.

The lock can be set or released with the **SUB MENU** keys. **The temperature is set at “0” on shipping from the factory.**

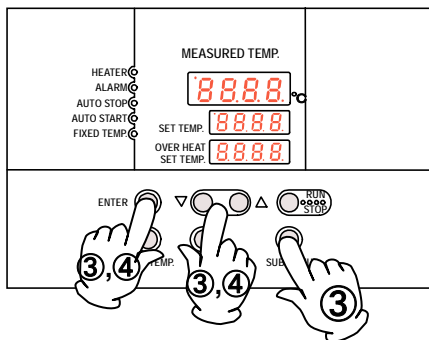
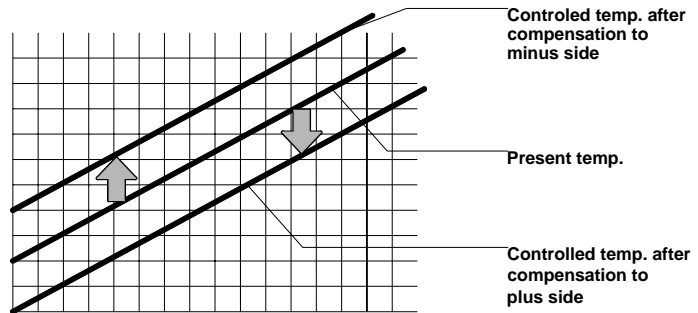

- ① Start operation at the target set temperature and confirm the temperature in the bath with a temperature recorder after temperature has stabilized.
- ② Confirm the difference between the set temperature and that in the bath.
- ③ Press the **SUB MENU** key, select the character **cAL** that indicates the calibration offset function using the **▼▲** keys and press the **ENTER** key.
- ④ Input the difference between the set temperature and that in the bath using the **▼▲** keys and press the **ENTER** key to complete setting.

* You can set either of + or – side for the offset compensation temperature.

When compensation is set for the – side, the **MEASURED TEMP.** display decreases by the compensation temperature while the temperature in the bath increases by the same amount.

When compensation is set for the + side, the **MEASURED TEMP.** display increases by the compensation temperature while the temperature in the bath decreases by the same amount.

* Since too large a compensation value may result in larger difference between the actual and indicated temperatures and may present a danger, consult our nearest sales office before entering a large compensation value.

* The device has, in addition to the calibration offset function, the two-point compensation function that adjusts offset for the lower temperature range and higher temperature range, for which adjustment temperatures have been input on shipping from the factory.

* Consult the nearest sales office before attempting validation work for the temperature adjusting device.

4. Operating procedures

Useful function (setting lock function)

Using the lock function

This function locks the set operation status.

The temperature is set at “off” on shipping from the factory.

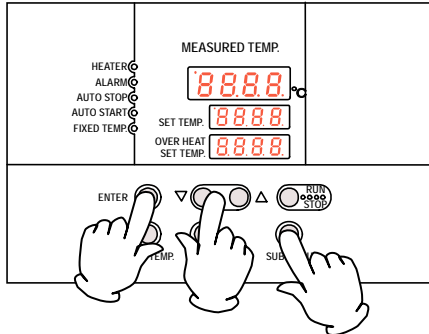

- ① Press the **SUB MENU** key, select the character Lock that indicates setting lock using the ▼▲ keys and press the **ENTER** key.

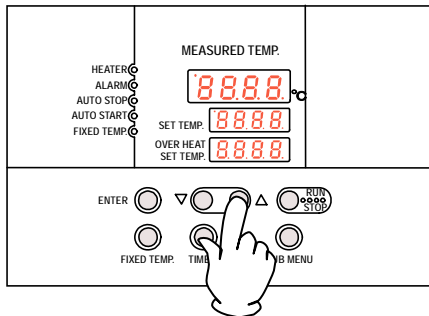

- ② “Off” is displayed on the SET TEMP. screen. To lock settings, change to “on” using the ▲ key.

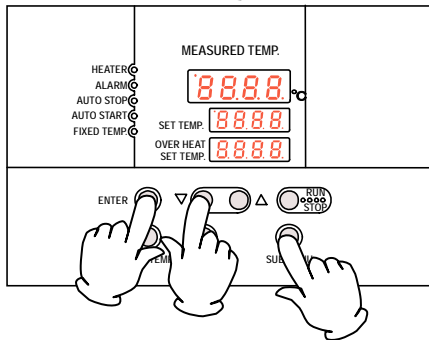

- ③ To release lock, press the **SUB MENU** key, select the character Lock **Lock** that indicates setting lock using the ▼▲ keys and press the **ENTER** key. Lock is released when “off” is selected using the ▼ key and the **ENTER** key is pressed.

* When the lock function is “on”, keys other than the **RUN/STOP** key and the **SUB MENU** key are locked.

5. Cautions on handling



Warning

1. About handling of flammable or combustible solution

-  The unit is not explosion proof. Take special care for handling samples on which explosive substances, combustible substances or substances containing them. Flammable or combustible solution will evaporate when left at a room temperature (or at a lower temperature for some types of solutions) and may be ignited and explode from switches, lights and other ignitable sources. Be sure to assure sufficient ventilation when using these materials.
See section "13. List of dangerous materials" on page 38.

2. Ban on use/countermeasures when an error occurs

-  If smoke emerges from the unit or an odd odor is felt, immediately turn the power switch on the main unit off, turn the power supply off and contact your dealer or a Yamato sales office for inspection. Otherwise, a fire or an electrical shock may result. The user shall never attempt to repair the unit to avoid any possible dangers.

3. Secure sufficient ventilation for the unit.

-  Do not operate the unit when its vent holes on the side and rear panels covered or blocked. Internal temperature of the unit will rise degrading the performance and an accident, a malfunction or a fire may result.

4. Do not allow liquid to spill over the unit.

-  Do not allow liquid to spill over the unit. Pay special attention not to allow liquid to enter into the vent holes on the side and rear panels of the unit. If liquid is spilt over or into the unit, do not try to operate it any further. Other wise, an accident, a malfunction, a fire or an electrical shock may result.

5. Do not allow a metal piece to fall into the unit.

-  Do not allow a clip, a staple, a screw or other metal pieces to fall into the unit. Stop operating the unit if a metal piece has dropped into the unit. Other wise, an accident, a malfunction, a fire or an electrical shock may result.

6. Do not open the cabinet.

-  Do not open panels or covers fixed on the unit, or do not operate the unit with any of those open. Other wise, an accident, a malfunction, or an electrical shock may result.

7. Always operate the unit at a correct ambient temperature.

-  The operating temperature range is room temperature range from +5~80°C above room temperature. Never try to operate the unit outside the operating temperature range.

8. Do not attempt to modify the unit.

-  The user shall never try to modify the unit; other wise, an accident, a malfunction, a fire or an electrical shock may result.

5. Cautions on handling



Caution

1. Do not step on the unit.



Do not step on the unit. Otherwise, the unit may trip over or be damaged resulting in a personal injury or a malfunction.

2. Do not put or drop an object on the unit.



Do not put or drop an object on the unit. Since the unit contains high precision devices, vibrations or shock may cause a malfunction.

3. When a thunder is heard.



When a thunder is heard, turn the power switch on the main unit off then turn the main power off immediately. Otherwise, a lightning strike may result and cause a fire.

4. During night and not to be operated for a long period of time.



During the night and when you want to stop the unit for a longer period of time, turn the power switch to "off" and pull out the power cord from the power supply.

5. About recovery from power outage.



When the power is applied again after the unit has stopped due to power outage, the unit will automatically return to the status immediately before the power outage and resumes operation.
Turn the power switch off if you do not want to resume operation by automatic recovery.

6. About two-tier stacking



Use the dedicated optional parts to stack units in two tiers. Contact your dealer or the nearest sales office for the dedicated optional part.

7. When opening or closing the door



When opening or closing the door, do not put your hand or face close to the area the door moves (space).
The door may touch your hand or face and causing an injury.

8. Do not operate the unit with the door open.



When the unit is operated with the door open, proper temperature control is not possible and the heater may overheat causing a possible danger. Be sure to operate the unit with the door closed.

9. About installation of shelf boards and samples



Place shelf boards and samples according to "Installation procedures · precautions" on page 7. Otherwise, the optimal performance of the unit will not be obtained and an accident or a malfunction may result.

10. Do not attempt to do anything other than specified in this operation manual.



Do not attempt to do anything other than specified in this operation manual. Otherwise, an unexpected accident may result.

6. Maintenance procedures

Daily inspection/maintenance

Be sure to perform daily inspection and maintenance to assure reliable operation of the unit.

Warning

- Be sure to pull out the power cord unless necessary before trying to do inspection and maintenance works.
- Start these works after the device has returned to the normal temperature.
- Never try to disassemble the unit.

Caution

- Wipe off any dirt with a tightly wrung soft cloth. Never try to clean the unit with benzene, thinner or scouring powder, or rub with a scrubbing brush. Deformation, degradation or discoloration may result.

Maintenance of the internal chamber

Stop operation and turn the power switch to OFF. Pull out the power cord off the distribution board and the wall outlet. Confirm the temperature in the device and remove shelf boards and clamps.

The internal chamber, shelf boards and shelf clamps are made of stainless steel and reinforced glass is used for the inner door. To clean these items, thoroughly wipe with a cloth moistened with cleaning alcohol then wipe gently with a dry cloth.



Never use acid detergent, alkaline detergent, oil or organic solvent, which may cause corrosion or damage to the products.



There are sharp protrusions inside the internal chamber, shelf boards and shelf pillars and shall be handled with special care to avoid personal injury. Be sure to wear gloves since handling with bare hands may present danger.

7. When the unit is not to be used for a long time or when disposing

When the unit is not to be used for a long time or when disposing

 Caution	 Warning
<p>When the unit is not going to be used for a long time</p> <ul style="list-style-type: none"> ● Turn the power switch to off and pull out the power cord. 	<p>When disposing the unit</p> <ul style="list-style-type: none"> ● Do not leave the unit in the area where children may have access. ● Be sure to remove handles before disposing the unit to prevent the doors from locking. ● In general, dispose the unit as a bulky waste.

Notes about disposition

Always pay attention to the preservation of the global environment.

- We highly recommend taking the unit apart as far as possible for separation or recycling to contribute to the preservation of the global environment. Major components and materials for the unit are as follows:

Names of major components	Major materials
Major exterior components	
Exterior	Steel plate SPCC (powder coating)
Internal chamber	Stainless steel
Packing, gaskets, etc.	Neoprene rubber
Major electric parts	
Switches and relays	Resin, copper
Boards	Glass fiber
Heater	Iron-chrome
Power cord	Synthesized rubber sheath, copper, nickel

8. Troubleshooting

Safety device and error codes

The unit has the self diagnostic function with a controller and a separate safety device. Table below shows possible causes and measures when the safety device is triggered.

[Error codes]

When a functional or mechanical abnormality occurs, the alarm lamp on the control panel comes on, an error code will be displayed and the alarm buzzer sounds. When an abnormality occurs, confirm the error code and immediately stop operation.

Safety device	Symptom	Possible causes and measures
Sensor error	Alarm lamp on Er.01 appears	<ul style="list-style-type: none"> ● Error in the temperature input circuit ● Disconnection or other errors in the temperature sensor ● Measured temperature is outside the displayable range Contact our service department.
SSR short circuit	Alarm lamp on Er.02 appears	<ul style="list-style-type: none"> ● SSR shortage Contact our service department.
Heater disconnection detected	Alarm lamp on Er.03 appears	<ul style="list-style-type: none"> ● Heater disconnection Contact our service department.
Memory error	Alarm lamp on Er.15 appears	<ul style="list-style-type: none"> ● Memory setting error Contact our service department.
Internal communication error	Alarm lamp on Er.17 appears	<ul style="list-style-type: none"> ● Internal communication or the temperature input circuit error Contact our service department.
Overheat	Alarm lamp on Er.19 appears	<ul style="list-style-type: none"> ● Activation of overheat prevention device Reset power once and check the temperature in the bath and the overheat prevention device set temperature. Contact our service department if the unit will not recover.
Measured temperature error	Alarm lamp on ---- ---- appears	<ul style="list-style-type: none"> ● When the measured temperature is outside the displayable range Contact our service department.

8.Troubleshooting

When a malfunction is suspected

If any of the symptoms below occurs

Symptom	Check
Turning the MCB to on will not activate the unit.	<ul style="list-style-type: none">● If the power cord is connected to the power supply securely.● If power outage is not occurring.● If the standalone overheat prevention device is working.
Temperature does not rise.	<ul style="list-style-type: none">● If the set temperature is below that in the device.● If the power supply voltage has declined.● If the ambient temperature is not low.● If cooling load for inside the chamber is not too large.
Temperature fluctuates during operation.	<ul style="list-style-type: none">● If the set temperature is appropriate.● If the power supply voltage has declined.● If ambient temperature fluctuates widely.● If cooling load for inside the chamber is not too large.
Displayed temperature differs from the measurement.	<ul style="list-style-type: none">● If the calibration offset setting is not other than "0". Set it to "0."

If power outage occurs

When the power is applied again after the unit has stopped due to power outage, the unit will automatically return to the status immediately before the power outage and resumes operation. Turn the SW off if you do not want to resume operation by automatic recovery.

- ◆ If the symptom does not match any of the above, immediately turn the power switch on the main unit off, pull out the power cord from the power supply and contact your dealer or one of our sales offices.

9. After sales service and warranty

When requesting a repair

When requesting a repair

If any trouble occurs, immediately stop operation, turn the power switch off, pull out the power plug and contact your dealer or our sales office.

Information necessary for requesting a repair

- Model name of the product
 - Serial number
 - Date (y/m/d) of purchase
 - Description of trouble (as in detail as possible)
- } See the warranty card or the nameplate installed on the unit.
See 3. Names and functions of parts on page 11.

Be sure to indicate the warranty card to our service representative.

Warranty card (attached separately)

- Warranty card is given by your dealer or one of our sales offices and please fill in your dealer, date of purchase and other information and store securely.
- Warranty period is one full year from the date of purchase. Repair service for free is available according to the conditions written on the warranty card.
- For repairs after the warranty period consult your dealer or one of our sales offices. Paid repair service is available on your request when the product's functionality can be maintained by repair.

Minimum holding period of repair parts

The minimum holding period of repair parts for this product is seven years after end of production.

Repair parts here refer to parts necessary for maintaining performance of the product.

10. Specifications

Model		IC403CR IC413CR	IC603CR IC613CR	IC803CR IC813CR
Performance	Operating temperature range	Room temperature +5°C~80°C (no load at an ambient temperature of 23°C)		
	Temperature control precision	±0.5°C (setting: 37°C)		
	Temperature distribution precision	±1°C (setting: 37°C)		
Mechanism	Heater	0.3 kW	0.4 kW	0.73 kW
		Iron-chrome wire heater		
Control part	Controller	Model VS3/4 PID control		
	Control system	PID control with a micro computer		
	Setting system	Digital setting using up/down keys		
	Operation mode	Fixed temperature operation, quick auto stop operation Auto stop operation, auto start operation		
	Sensor	K-thermocouple		
	Auxiliary functions	Lock function, power outage compensation function, calibration offset function		
Safety device	Controller Self diagnostic function	Temperature sensor error, memory error, auto overheat prevention, measured temperature error		
	Protection device	An over current fuse		
Standard	Outer dimensions (mm) (w x d x h)	560 × 606 × 820	710 × 656 × 870	710 × 656 × 1619
	Internal dimensions (mm) (w x d x h)	450 × 480 × 450	600 × 530 × 500	600 × 530 × 1000
	Internal volume	97ℓ	159ℓ	318ℓ
	Inner door	Reinforced glass door x 1		Reinforced glass door x 2
	Weight (tentative value)	Approx. 45 kg	Approx. 65 kg	Approx. 102 kg
	Power supply	VAC115 50/60Hz 2.8A VAC220 50/60Hz 1.4A	VAC115 50/60Hz 3.7A VAC220 50/60Hz 1.8A	VAC115 50/60Hz 6.6A VAC220 50/60Hz 3.3A
Included items	Shelf board x 2		Shelf board x 4	
	Shelf withstand load Approx. 15kg/each board			
	Operating instructions, warranty card			

*Performance values are for the VAC115 power supply.

*Operating environmental temperature range for this device is 5°C~35°C.

11. Wiring diagram

IC403CR/603CR/803CR

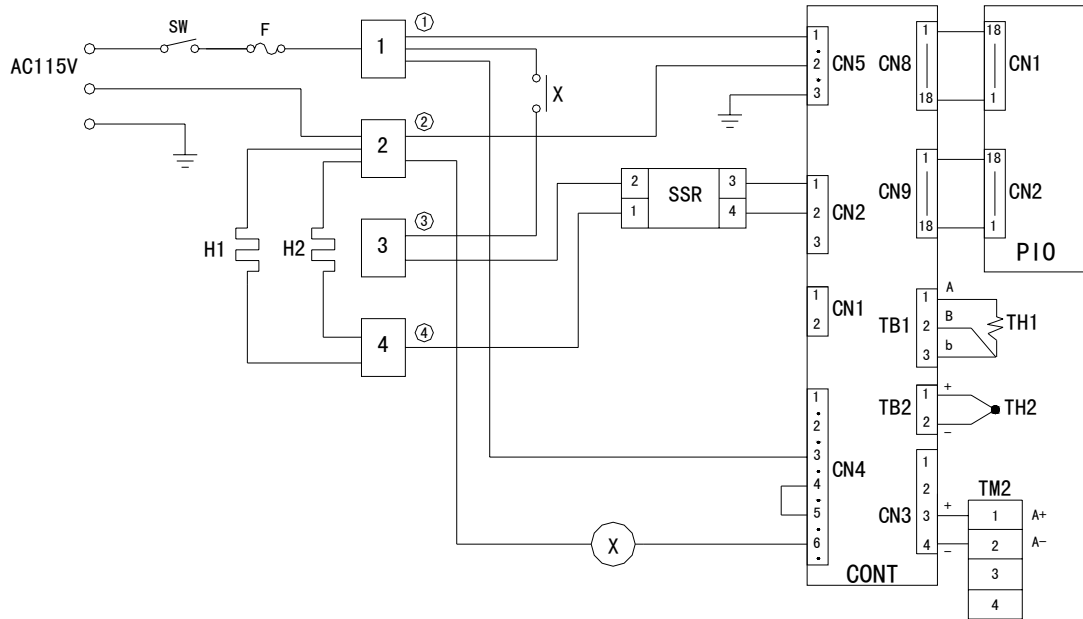

Symbol	Part name	Symbol	Part name
SW	power switch	CONT	Control circuit board
T	Terminal block	PIO	Display circuit board
H	Heater	TH1	Control sensor
X	Main relay	TH2	Overheat prevention sensor
SSR	No-contact relay	F	Fuse

11. Wiring diagram

IC413CR/613CR/813CR

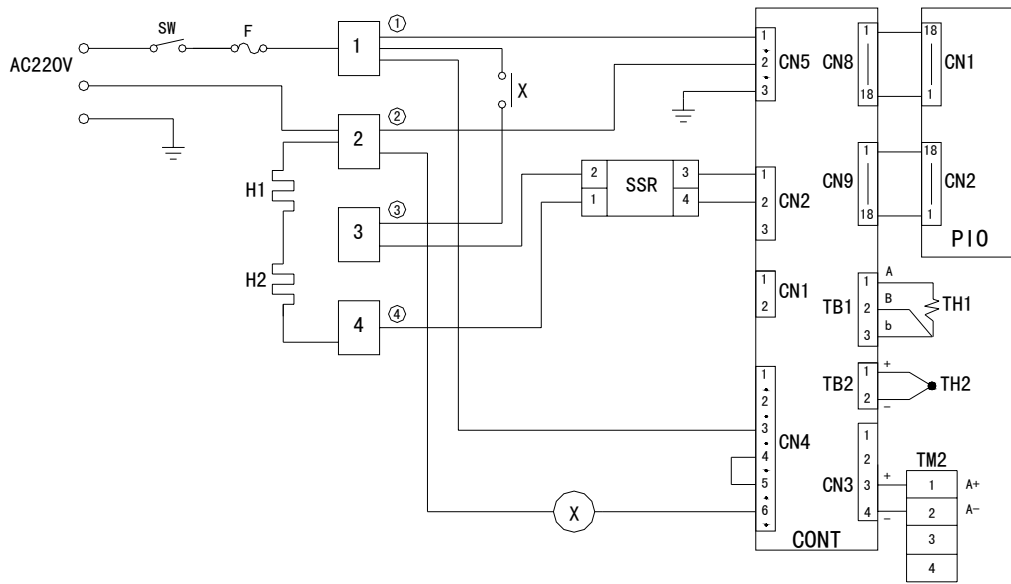

Symbol	Part name	Symbol	Part name
SW	power switch	CONT	Control circuit board
T	Terminal block	PIO	Display circuit board
H	Heater	TH1	Control sensor
X	Main relay	TH2	Overheat prevention sensor
SSR	No-contact relay	F	Fuse

12. List of replacement parts

Replacement parts

Symbol	Part name	Standard	Maker	Code No.
SW	power switch	250VAC 16A	YSJ	SJA07732
F	Fuse	250VAC 10A (IC403CR/413CR/603CR/613CR/803CR/813CR)	YSJ	SJA07733
TH1	Control sensor	NL-404RB-D0001 Pt single	YSC	LT00006788
TH2	Overheat prevention sensor	LCK-M1-2000Y K single	YSJ	SJA14012
CONT	Control circuit board	VS3	YSC	1020000052
PIO	Display circuit board	VS3/4	YSC	1020000051
	Tough card	15P 300 mm	YSC	1130000008
X	Main relay	JQX13F-2/A220V2Z1D	YSJ	SJA06063
SSR	No-contact relay	G3NE-220T-US 24VDC	YSJ	SJA06052
	Power cord kit	2.0sq 3P plug	YSJ	SJA04480
H1・2	Heater	115V 150W (IC403CR/413CR)	YSC	LT00020606
		115V 200W (IC603CR/613CR)	YSC	LT00020607
		115V 365W (IC803CR/813CR)	YSC	LT00020608

13. List of dangerous materials



Never use an explosive substance a flammable substance or a substance containing them for this device.

Explosive substance	Explosive substance	① Nitroglycol, glycerine trinitrate, cellulose nitrate and other explosive nitrate esters
		② Trinitrobenzen, trinitrotoluene, picric acid and other explosive nitro compounds
		③ Acetyl hydroperoxide, methyl ethyl ketone peroxide, benzoyl peroxide and other organic peroxides
Flammable substances	Explosive substances	Metal "lithium", metal "potassium", metal "natrium", yellow phosphorus, phosphorus sulfide, red phosphorus, celluloids, calcium carbide (a.k.a, carbide), lime phosphide, magnesium powder, aluminum powder, metal powder other than magnesium and aluminum powder, sodium dithionous acid (a.k.a., hydrosulphite)
	Oxidizing substances	① Potassium chlorate, sodium chlorate, ammonium chlorate, and other chlorates
		② Potassium perchlorate, sodium perchlorate, ammonium perchlorate, and other perchlorates
		③ Potassium peroxide, sodium peroxide, barium peroxide, and other inorganic peroxides
		④ Potassium nitrate, sodium nitrate, ammonium nitrate, and other nitrates
		⑤ Sodium chlorite and other chlorites
		⑥ Calcium hypochlorite and other hypochlorites
	Flammable substances	① Ethyl ether, gasoline, acetaldehyde, propylene chloride, carbon disulfide, and other substances with ignition point at a degree 30 or more degrees below zero.
		② n-hexane, ethylene oxide, acetone, benzene, methyl ethyl ketone and other substances with ignition point between 30 degrees below zero and less than zero.
		③ Methanol, ethanol, xylene, pentyl acetate, (a.k.a.amyl acetate) and other substances with ignition point between zero and less than 30 degrees.
④ Kerosene, light oil, terebinth oil, isopenthyl alcohol(a.k.a. isoamyl alcohol), acetic acid and other substances with ignition point between 30 degrees and less than 65 degrees.		
Combustible gas		Hydrogen, acetylene, ethylene, methane, ethane, propane, butane and other gases combustible at 15 degrees at one air pressure.

14. Standard installation manual

*Install the product according to the following: (Confirm separately for optional items or special specifications)

Model	Serial number	Date	Installation mgr. (company name)	Installation mgr.	Judgment

No.	Item	Implementation method	TOC No. Reference page of the operating instruction manual	Judgment
Specifications				
1	Included items	Check for number of staffs against the included item field	10.Specifications field P.34	
2	Installation	<ul style="list-style-type: none"> • Visual check of environmental conditions Caution: Take care for environment 	2. Before operating the unit P.4 <ul style="list-style-type: none"> • On the installation site 	
		<ul style="list-style-type: none"> • Securing a space 		
Operation-related matters				
1	Source voltage	<ul style="list-style-type: none"> • Measure the user side voltage (outlet) with a tester • Measure voltage during operation (shall meet the standard) Caution: Always use a plug that meets the specification for attaching to the power switch. 	2. Before operating the unit P.6 <ul style="list-style-type: none"> • Be sure to connect the ground wire. • Power supply is P.6 10. Specifications <ul style="list-style-type: none"> • Specification-power supply P.34 	
2	Operation start	<ul style="list-style-type: none"> • Starts operation Performs fixed temperature operation, auto stop operation or auto start operation 	2. Before operating the unit P.4~9 <ul style="list-style-type: none"> • Installation procedures... 4. Operating procedures P.14 ~ 26	
Description				
1	Operational descriptions	Explain operations of each component according to the operational instructions	4. Operating procedures P.14 ~ 26 <ul style="list-style-type: none"> • Operating procedures 1. Safety precautions P.1 ~ 38 ~13. List of dangerous materials	
2	Error codes	Explain the customer about error codes and procedures for release according to the operational instructions	8. Troubleshooting P.31 ~ 33 ~9. After sales service and warranty	
3	Maintenance and inspection	Explain operations of each component according to the operational instructions	6. Maintenance procedures P.29 <ul style="list-style-type: none"> • Daily inspection/maintenance 	
4	Completion of installation Entries	<ul style="list-style-type: none"> • Fill in the installation date and the installation mgr. on the nameplate of the main unit • Fill in necessary information to the warranty card and hand it over to the customer • Explanation of the route for after-sales service 	9. After sales service and warranty P.33	

Limited liability

Be sure to use the unit strictly following the handling and operating instructions in this operating instruction.

Yamato Scientific Chongqing Co., Ltd. assumes no responsibility for an accident or a malfunction caused by use of this product in any way not specified in this operating instruction.

Never attempt to perform matters prohibited in this operation instruction.

Otherwise, an unexpected accident may result.

Notice

- Descriptions in this operating instruction are subject to change without notice.
- We will replace a manual with a missing page or paging disorder.

Operating instruction
Economy incubator
IC403CR/603CR/803CR
IC413CR/613CR/813CR
Third edition 10 December 2010

Yamato Scientific America, Inc.
925 Walsh Ave, Santa Clara, CA 95050
Tel:408-235-7725
For technical information
and service, call: 1-800-292-6286
<http://www.yamato-usa.com>