

SINCE 1889



ECONOMY INCUBATOR

Model

IC903C/903CW

First edition

- Thank you very much for purchasing this Yamato IC series incubator.
 - Please read the “Operating Instructions” and “Warranty” before operating this unit to assure proper operation. After reading these documents, be sure to store them securely together with the “Warranty” in a handy place for future reference.
- ⚠ Warning** : Before operating the unit, be sure to read carefully and fully understand important warnings in the operating instructions.

Yamato Scientific America Inc.

Table of contents

1. Safety precautions	1
Explanation of pictograms	1
List of symbols.....	2
Warning • Cautions.....	3
2. Before operating the unit	4
Precautions when installing the unit	4
Installation procedures • precautions	7
Operation panel.....	12
Explanation of characters	13
4. Operating procedures	14
List of operation modes and functions	14
Operation mode • function setting keys and characters	16
Operating procedures (fixed temperature operation).....	17
Operating procedures (quick auto stop operation).....	18
Operating procedures (auto stop operation).....	20
Operating procedures (auto start operation).....	22
Useful functions (calibration offset function).....	24
Useful function (setting lock function).....	25
Useful function (power outage compensation function).....	26
5. Cautions on handling	27
6. Maintenance procedures	29
Daily inspection/maintenance	29
7. When the unit is not to be used for a long time or when disposing	30
When the unit is not to be used for a long time or when disposing.....	30
Notes about disposition	30
8. Troubleshooting	31
Safety device and error codes.....	31
When a malfunction is suspected.....	32
9. After sales service and warranty	33
When requesting a repair	33
10. Specifications	34
11. Wiring diagram	35
12. List of replacement parts	36
13. List of dangerous materials	37
14. Standard installation manual	38



1. Safety precautions

Explanation of pictograms

About pictograms



A variety of pictograms are indicated in this operation manual and on products to assure safe operation. Possible results from improper operation or disregard for these warnings is listed below.

Be sure to fully understand the descriptions below before proceeding to the text.

 Warning	Indicates a situation which may result in death or serious injury (Note 1)
 Caution	Indicates a situation which may result in minor injury (Note 2) and property damage (Note 3).

- (Note 1) Serious injury means a wound, an electrical shock, a bone fracture or intoxication that may leave after effects or require hospitalization or outpatient visits for a long time.
- (Note 2) Minor injury means a wound or an electrical shock that does not require hospitalization or outpatient visits for a long time.
- (Note 3) Property damage means damage to facilities, devices and buildings or other properties.

Meanings of pictograms

-  This pictogram indicates a matter that encourages the user to adhere to warning ("caution" included).
Specific description of warning is indicated near this pictogram.
-  This pictogram indicates prohibitions
Specific prohibition is indicated near this pictogram.
-  This pictogram indicates matters that the user must perform.
Specific instruction is indicated near this pictogram.

1. Safety precautions

List of symbols

Warning



General warnings



Danger!: High voltage



Danger!: High temperature



Danger!: Moving part

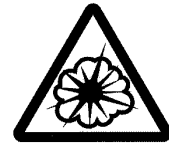

Danger!: Hazard of explosion

Caution



General cautions



Electrical shock!



Burning!



Caution for no liquid heating!



Caution for water leak!



For water only



Poisonous material

Prohibitions



General Prohibition



Fire Prohibited



Do not disassemble



Do not touch

Compulsions



General compulsions



Connect ground wire



Install levelly



Pull out the power plug



Regular inspection

1. Safety precautions

Warning · Cautions

Warning



Never operate the unit in an atmosphere containing flammable or explosive gas

Never operate the unit in an atmosphere containing flammable or explosive gas. Otherwise, an explosion or a fire may result since the unit is not explosion-proof. See section "13. List of dangerous materials" on page 37.



Be sure to connect the ground wire.

Be sure to connect the ground wire correctly. Otherwise, electrical leak may result and cause an electrical shock or a fire.



Ban on operation when an abnormality occurs

When smoke or an unusual odor is seen or smelled, immediately turn the ground fault interrupter on the main unit off and pull out the power plug. A fire or an electrical shock may result.



Never use electrical power cords bundled.

When these are used bundled, they might overheat causing a fire.



Take care not to damage electrical power cords.

Avoid tightly bending, pulling with a strong force or twisting to prevent electrical power cords from damage. A fire or an electrical shock may result.



Never use an explosive or a flammable material with this unit.

Never use an explosive material, a flammable material or a material containing explosive or flammable elements. An explosion or an electrical shock may result. See section "13. List of dangerous materials" on page 37



Never try to touch a hot part.

Some parts of the unit are hot during and immediately after operation. Take special care to avoid burns.



Never try to disassemble or alter the unit.

Never try to disassemble or alter the unit. A malfunction, a fire or an electrical shock may result.



Caution



When thunder is heard.

When thunder is heard, turn the main power off immediately. A malfunction, fire or an electrical shock may result.

2. Before operating the unit

Precautions when installing the unit

1. Carefully select an installation site.



Take special care not to install the unit at a place described below:

- Uneven surfaces or dirty surfaces
- Where flammable gas or corrosive gas exists
- Where the ambient temperature is 35°C or more
- Where temperature changes severely
- Where humidity is high
- Where subject to direct sunlight
- Where vibration is severe



Install this unit at a place with spaces shown below.

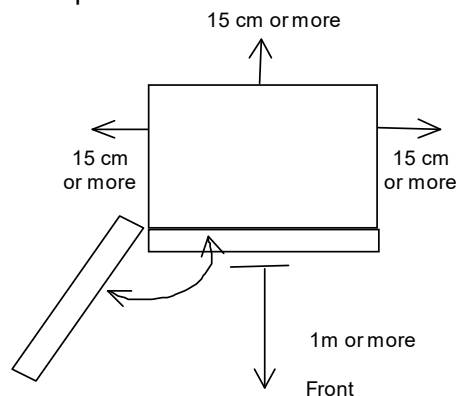

2. Install the unit on a level surface.



Install the unit on a level surface. If the whole bottom surface of the unit does not contact the surface evenly, vibrations or noises may result. This might cause unexpected troubles or malfunctions.

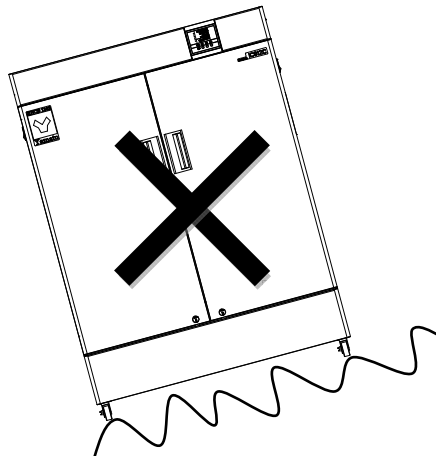

Weight of the units is: Model IC903C/903CW: approx. 166 kg;
When lifting the unit for transportation and installation, carefully handle it by at least two people.

3. Installation



The unit might fall down or move by an earthquake or an impact resulting in a personal injury. We recommend taking safety measures such as to avoid installing the unit in a high traffic area.

2. Before operating the unit

Precautions when installing the unit

4. Secure sufficient ventilation for the unit.

- Do not operate the unit when its vent holes on the side and rear panels are covered or blocked. Internal temperature of the unit will rise, degrading the performance, and an accident, a malfunction or a fire may result.

5. Do not operate the unit at such a place that may subject to splashing liquids.

- Do not operate the unit at such a place that may subject to splashing liquids. Liquid entering the inside may cause an accident, a malfunction, an electrical shock or a fire.

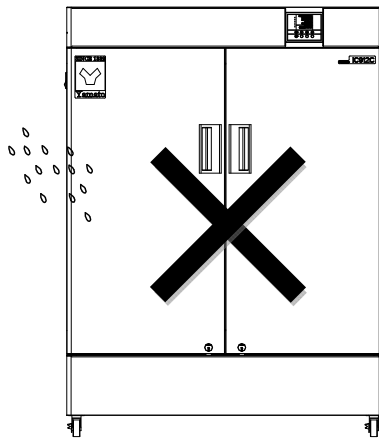

6. Never operate the unit in an atmosphere containing flammable or explosive gas.

- Never operate the unit in an atmosphere containing flammable or explosive gas. Since the unit is not explosion-proof, an arc is discharged when switching the circuit breaker "ON" and "OFF" and during operation, could cause a fire or an explosion. See the section "13. List of dangerous materials" on page 37 for flammable and explosive gases.

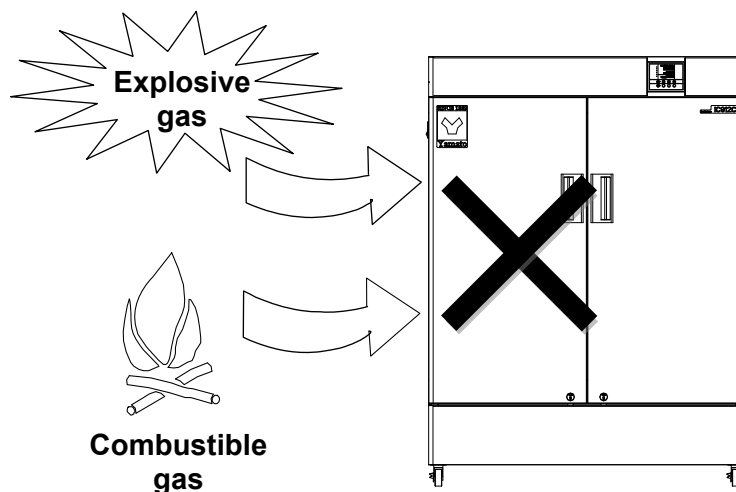

2. Before operating the unit

Precautions when installing the unit

7. Be sure to connect the power plug to the dedicated power distribution panel or a wall outlet.



Use a power distribution panel or a wall outlet that meets the electrical capacity of the unit.

Electrical capacity: IC903C/903CW AC115V 12A

- * When the unit will not start even when you turn the ground fault interrupter to "ON", check for low main voltage or if the unit is connected to the same power supply line as other devices and connect it to another line if necessary.

Avoid connecting too many devices using a branching outlet or extending a wire with a cord reel or temperature controlling function may degrade due to voltage drop.



Do not connect the unit to a gas pipe, a water pipe or a telephone line or any parts or lines, other than a correct power supply line. Otherwise, an accident or a malfunction may result.

8. Handling of a power cord



Never use electrical power cords bundled. When these are used bundled, they might overheat causing a fire.

Do not convert, forcibly bend, twist or pull the power cord. Otherwise, a fire or an electrical shock may result.

Do not place the power cord under a desk or a chair, or sandwich between objects to avoid it from being damaged. Otherwise, a fire or an electrical shock may result.

Do not place the power cord close to a stove or other heat generating device. Sheath of the cord may burn and result in a fire or an electrical shock.



If the power cord should be damaged (exposure of core wire or disconnection), immediately turn the power switch off, pull out the power cord (plug) out of the power supply and ask your dealer to replace the cord. Otherwise, a fire or an electrical shock may result.



Connect the power cord to an appropriate wall outlet.

9. Be sure to connect the ground wire.



- When the unit has no ground terminal, class D grounding work is necessary and please consult your dealer or our nearest sales office.
- Securely connect to an outlet.

We recommend use of a ground type outlet tap.

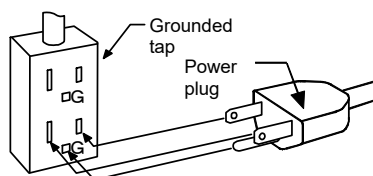

When there is no ground terminal.

In this case, class D grounding work is necessary and please consult your dealer or our nearest sales office.

When a bipolar type outlet tap is used

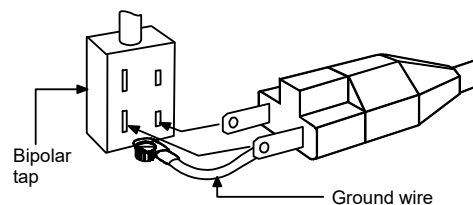

Insert the ground adaptor included as an option, into a power plug confirming the polarity of the outlet. Connect the grounding wire (green) of the ground adaptor to the ground terminal on the power supply equipment.



Do not connect the grounding wire to a gas pipe, a water pipe or a telephone line or any parts or lines other than a correct grounding terminal. Otherwise, an accident or a malfunction may result.

2. Before operating the unit

Installation procedures • precautions

- (1) Transportation of the product
- *Take care for protrusions on the unit.
 - Move the model IC903C/903CW after push two stoppers up to unlock the casters on the front side of the main unit as shown in the figure right. Make sure casters at the four points move smoothly before trying to move the unit.
 - * Note that moving the unit over a bump may give an excessive impact to and break the casters. Where there is such a bump, move the unit by lifting it by at least two people.

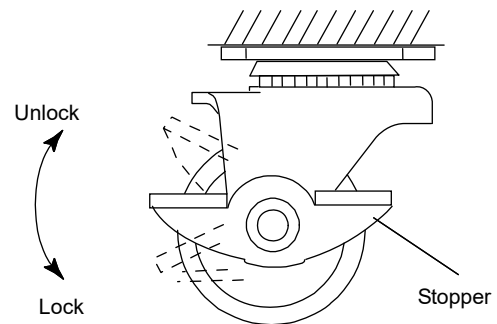

- (2) Select an installation site.
Make sure that four caster wheels for right, left, front and rear securely rest on a flat surface as well as there is no loosened part or inclination of the unit and push down the caster stopper to lock for the model IC803C.
- (3) Install shelf boards.
• The lowest shelf board has been secured with screws at the time of shipping from the factory.

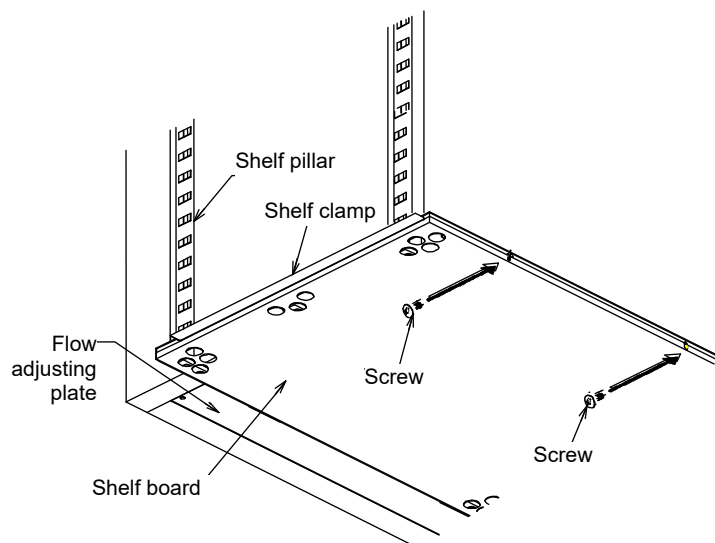

2. Before operating the unit

Installation procedures - precautions

- Install shelf pegs at heights you want on the right and left shelf posts in the internal chamber of the main body.
- Completely push shelf boards by sliding to the end.
 - *Take care to put each shelf board on correct pairs of right and left shelf pegs.
- Make sure that shelf boards will not fall nor rattle.
- Withstand load of each shelf board is 15kg in even loading. When putting samples, arrange them as dispersed as possible.

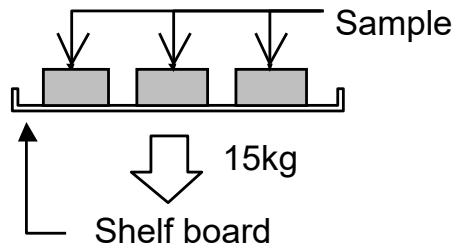

- Put samples with spaces between them. Too many samples may prevent proper temperature control. To assure proper temperature control, put samples with a space at least 30% of the shelf board area.

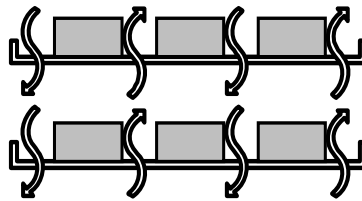

Make at least 30% of space

- (4) Do not put a sample on the bottom of the internal chamber.
- Operating the unit with a sample directly put on the bottom of the internal chamber might degrade its temperature characteristics. Also it may cause corrosion, damage or rusting of the internal chamber and burning of samples or a fire. Never put any sample on the bottom surface.
 - When putting samples, take care not to allow them touching the wall, where sensor or other devices are installed. Put samples on the shelf board included with the unit.

2. Before operating the unit

Installation procedures • precautions

- (5) Take special care for samples shown below:
- ① Samples that contain flammable or explosive components
 - The unit is not explosion proof. Never attempt to dry or process materials that contain flammable or explosive components.
 - ② Corrosive samples
 - Take care for handling of corrosive samples. Although stainless steel is used for major components, note that they might corrode with strong acid. Note that packing may corrode with acid, alkali, oil or organic solvents.
 - ③ Operation with devices with a larger heat load installed.
 - Note that temperature in the chamber may rise when operating the unit within a device.
- (6) About exhaust ports.
- IC903C/903CW model : Located on either side of the unit.
Adjust the open amount according to the water content of a specific sample.

Adjust according to
water amount

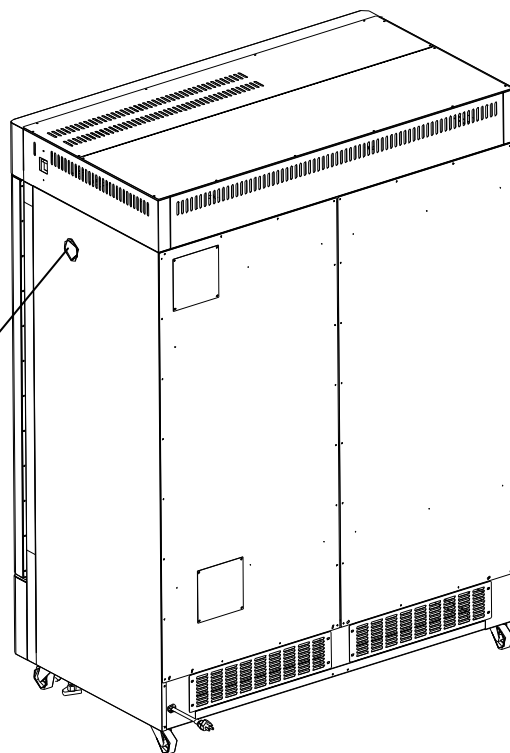

3. Names and functions of parts

Main body

Front view of IC903C

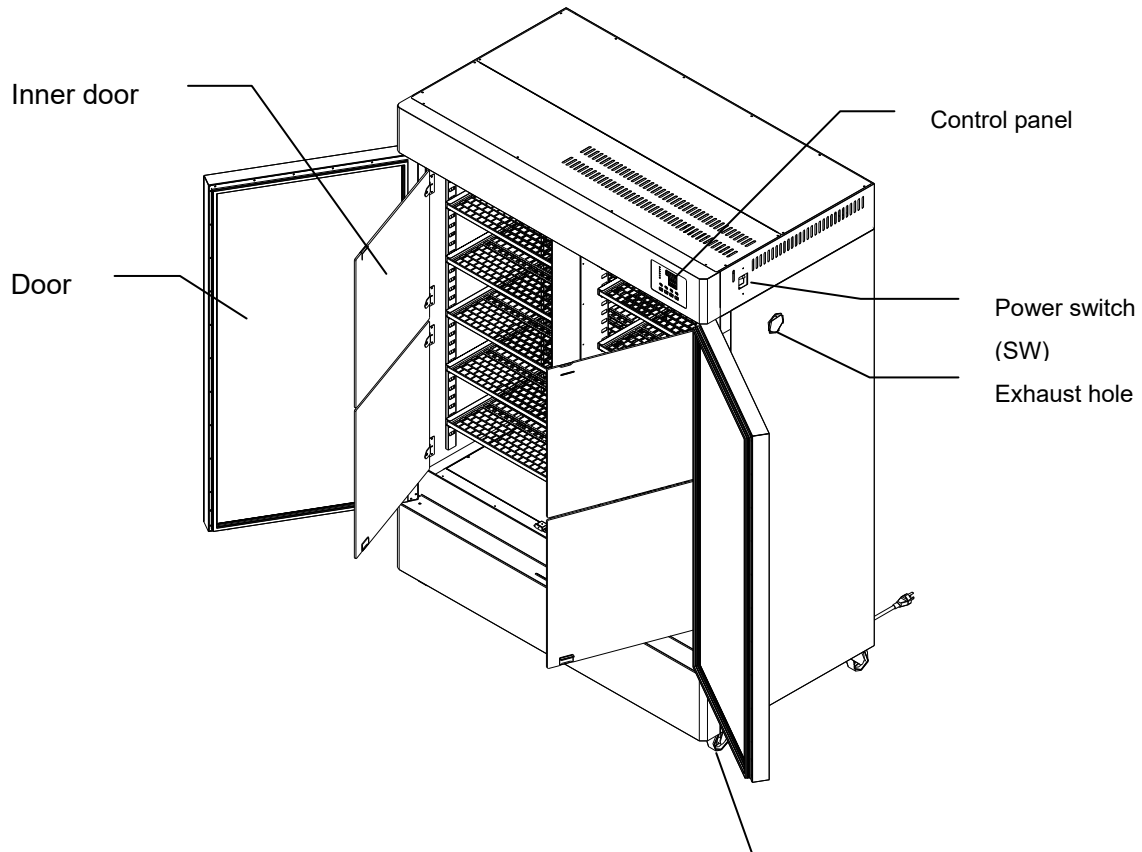

Rear view of IC903C

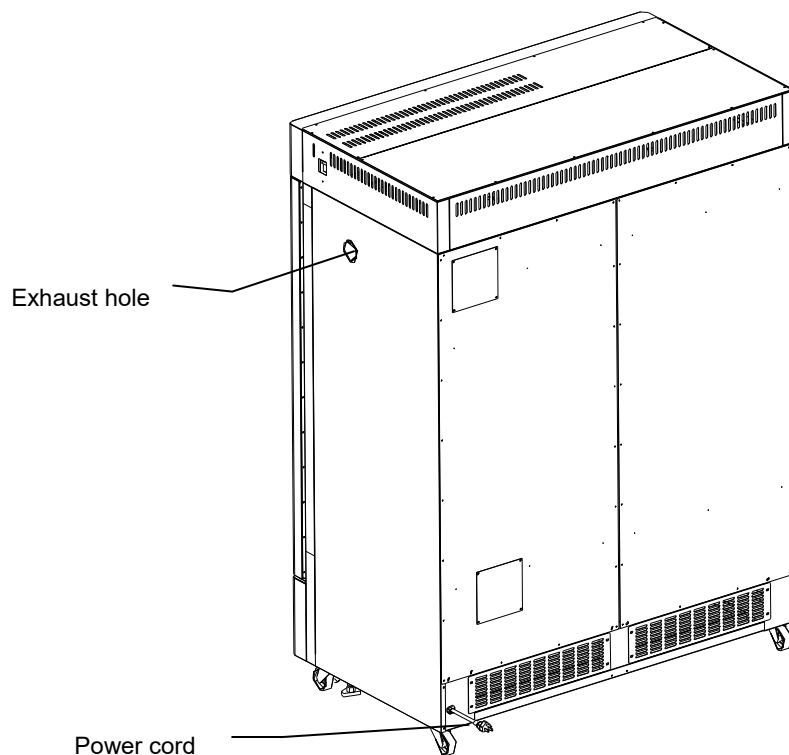

3. Names and functions of parts

Main body

Front view of IC903CW

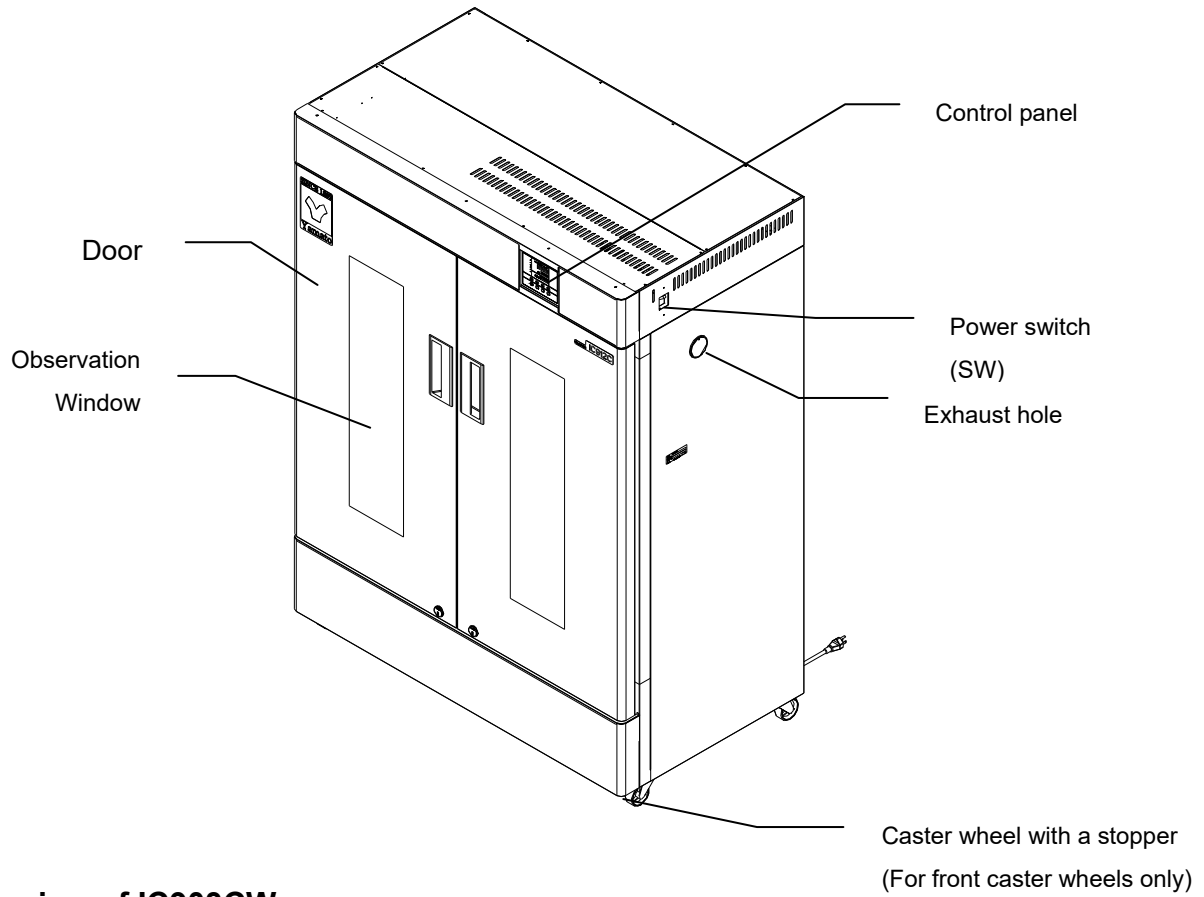

Rear view of IC903CW

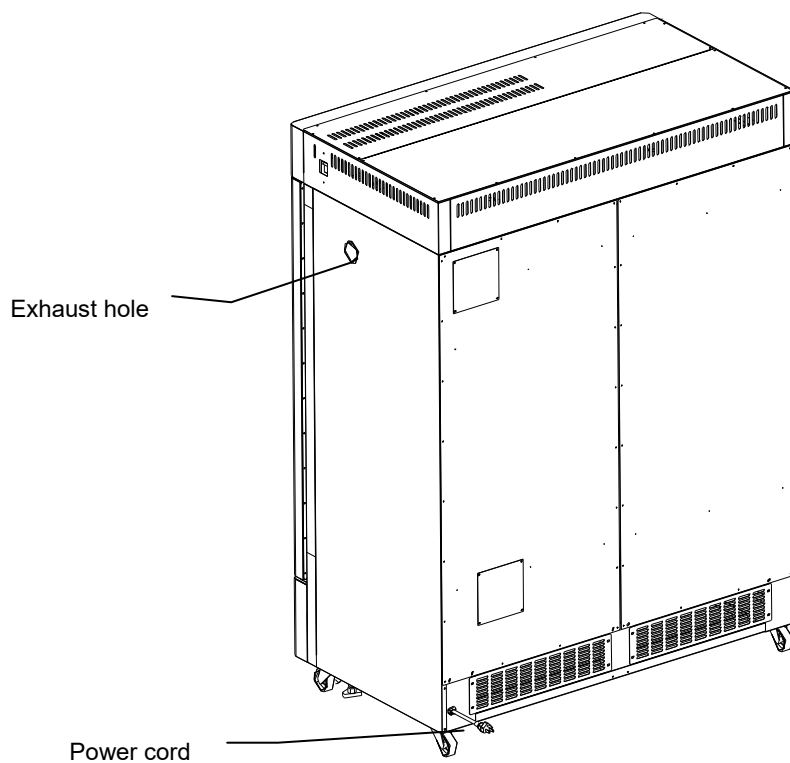

3. Names and functions of parts

Operation panel

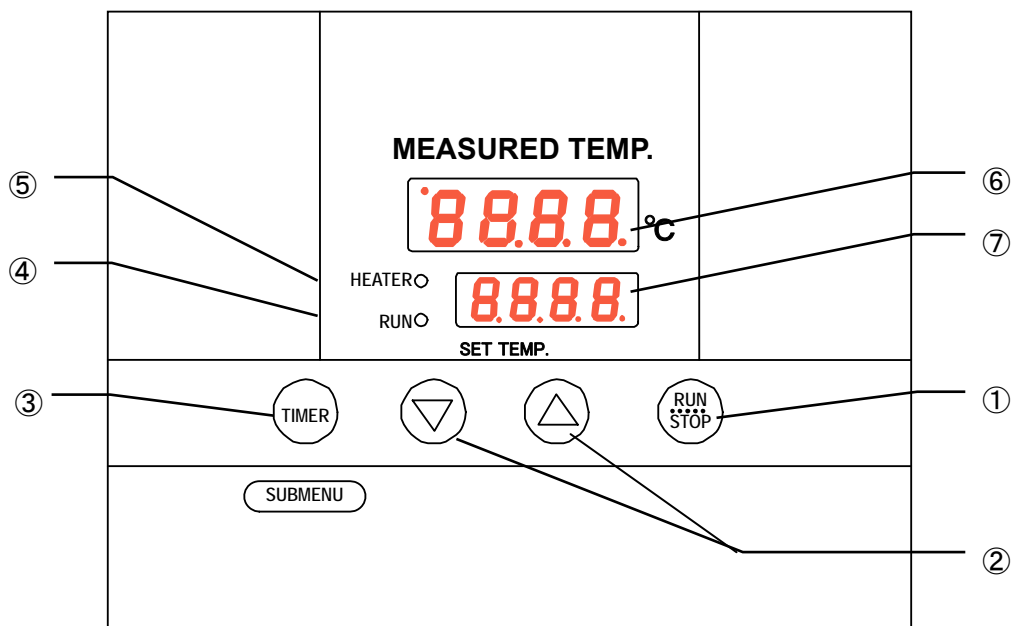







No.	Name	Operation/action
①	RUN/STOP key	Used for starting/stopping operation.
②	▼▲ keys	Used for selecting settings.
③	TIMER key	Key for selecting timer operation settings. Quick auto stop operation, auto stop operation or auto start operation can be selected.
	SUB MENU key (Long press of the Timer key)	Key for setting calibration offset temperature, the key lock function or the power outage compensation function.
④	RUN lamp	Illuminates during fixed temperature operation and blinks during timer operation.
⑤	HEATER lamp	Illuminates while heater power is on.
⑥	Measured temperature screen	Displays measured temperature in the chamber · set characters · alarm information.
⑦	Set temperature screen	Displays a set temperature, timer settings and timer remaining time.

3. Names and functions of parts

Explanation of characters

Characters on the controller are explained in this section.

Characters	Identifier	Name	Application
	AStP	Auto stop setting	Used for setting auto stop operation.
	AStr	Auto start setting	Used for setting auto start operation.
	End	Time up	Displayed when timer operation has ended. See pages 18 and 20.
	cAL	Calibration offset setting	Used for inputting a calibration offset temperature See section "Using the calibration offset function" on page 24.
	Lock	Key lock of settings	Key locks settings to prevent their alteration See section "Using the lock function" on page 25.
	Pon	Power outage compensation setting	Selects operations after recovery from power outage. See section "Using the power outage compensation function" on page 26.

*See the section "Operation mode · function setting keys and characters" on page 14 for characters of operation modes and functions.

4. Operating procedures

List of operation modes and functions

Operation modes of the unit are as shown below:

No.	Name	Description	Page
1	Fixed temperature operation	Turning the power switch on to enter the operation setting mode. Proceed to temperature setting that uses ▼▲ keys. Pressing the RUN/STOP key longer to start operation, and pressing the RUN/STOP key longer again to stop operation.	P.17
2	Quick auto stop operation	Used when you want to “stop fixed temperature operation being performed automatically in several hours.” Press the TIMER key during fixed temperature operation to display “AStP.” Set a duration before stop with the ▼▲ keys. Pressing the RUN/STOP key starts quick auto stop operation and activates the timer in the middle of it to automatically stop it after the set period of time.	P.18
3	Auto stop operation	Used when you want to “set automatic stop for fixed temperature operation when making settings for it.” Press the TIMER key to display “AStP.” Set a duration before stop with the ▼▲ keys. Pressing the RUN/STOP key starts auto stop operation.	P.20
4	Auto start operation	Used when you want to “start operation automatically after several hours” after power is turned on. Press the TIMER key to display “AStr.” Set a duration before stop with the ▼▲ keys. Pressing the RUN/STOP key starts auto start operation.	P.22
* Operation mode cannot be changed while the unit is in operation. First stop operation before changing the mode.			

4. Operating procedures

List of operation modes and functions

Functions of the unit are as shown below:

No.	Name	Description	Page
1	Calibration Offset function	Calibration offset function compensates any differences between the target temperature in the chamber and the control temperature of the controller (sensor temperature.) The function can compensate to either plus or minus side for the whole temperature band of the unit. This compensation can be set with the SUB MENU keys.	P.24
2	Setting lock function	This function locks the set operation status. The lock can be set or released with the SUB MENU key.	P.25
3	Power outage compensation function	This function returns the main unit operation to the resume status after recovery from power outage, or keeps the current stop status. This compensation can be set with the SUB MENU keys.	P.26

4. Operating procedures

Operation mode · function setting keys and characters

Key operations and characters in the diagram below are used for operation mode and function settings.

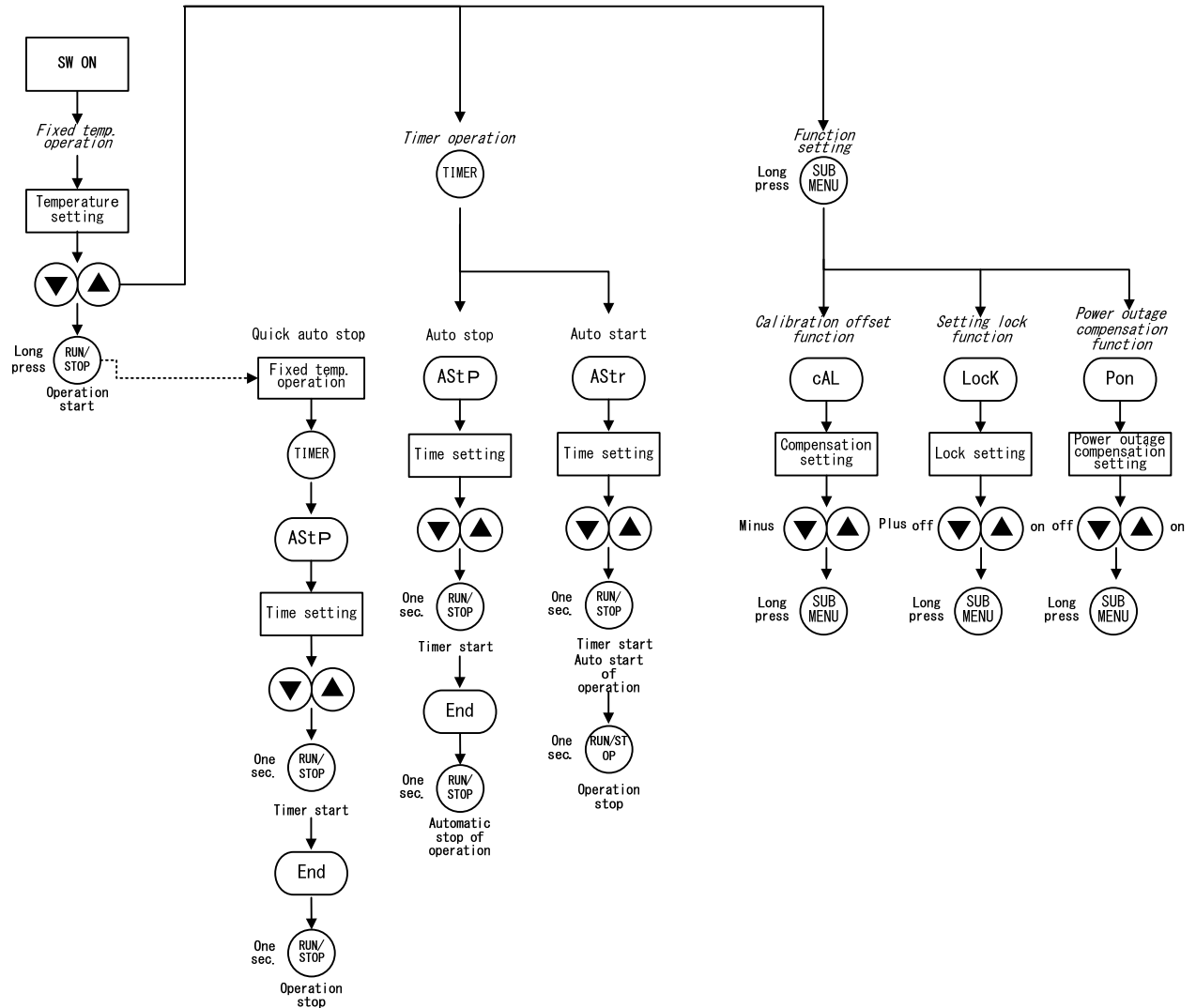

4. Operating procedures

Operating procedures (fixed temperature operation)

How to start fixed temperature operation

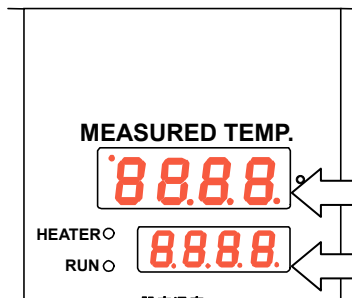

1. Turn the power switch ON. (Turn the power switch to “ON.”)

When the power switch is turned ON, the initial values will be displayed for about four seconds, then the initial screen will appear and the current chamber temperature and the previous set temperature are displayed on each of the indicators.

Measured temperature screen: Displays the current chamber temperature

Set temperature screen: Displays the previous set temperature

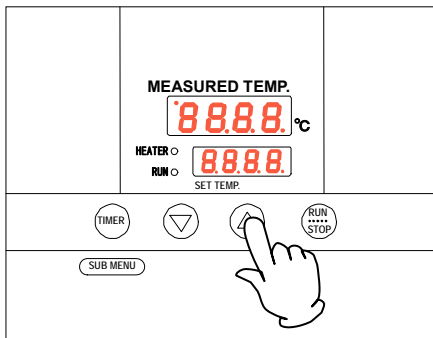

2. Setting the temperature

Set a temperature using the ▼▲ keys.

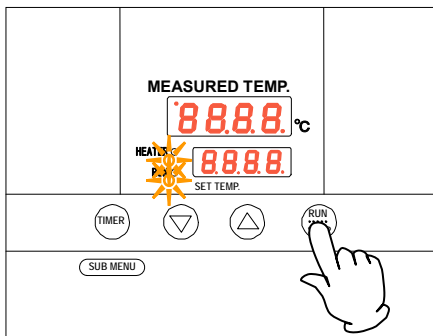

3. Starting operation

Press the **RUN/STOP** key longer.

Fixed value operation will start and the RUN lamp and the HEATER lamp come on.

4. Stopping operation

Press the **RUN/STOP** key longer.

Operation stops, the RUN lamp goes off and the screen switches to the initial setting screen.

When you want to correct setting errors or change settings

When you want to change settings, press the ▼▲ keys on the current screen to enter the setting mode where you can change settings. Blink stops three seconds after three seconds after change and setting is completed.



Caution

- ① When you want to lower the set temperature during fixed temperature operation, note that it takes some time to reach the reset temperature since the unit has no cooling capacity.
- ② Immediately after operation has been stopped, the temperature in the chamber is around the set temperature. Operation stop refers only to machine stop and time needed for decreasing the temperature in the chamber is not considered.

4. Operating procedures

Operating procedures (quick auto stop operation)

Used when you want to “stop fixed temperature operation being performed automatically in several hours. Quick auto stop operation is a function to enable auto stop timer setting during operation.

Procedures for quick auto stop operation

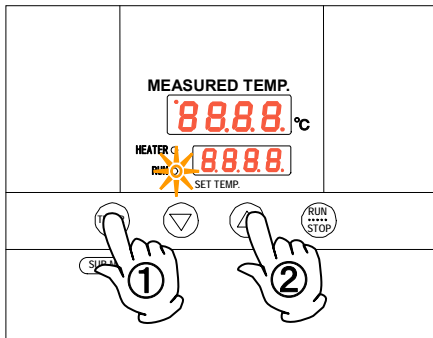

1. Setting time period before stop during fixed temperature operation

① Make sure that the RUN lamp is illuminated to indicate the unit is in operation.

Press the **TIMER** key.

Characters **ASTP** **85EP** are indicated on the measured temperature screen to indicate the auto stop operation mode and set duration blinks on the set temperature screen.

② Set a duration you want using the **▼▲** keys.

About the timer function

The maximum time that can be set for the timer is 999 hours 50 minutes.

Up to 99 hours 59 minutes, time can be set in minutes.

One hundred hours and over are set only in 10 minutes.

Keep the **▼▲** keys pressed to continuously change set time and you can quickly reach the time you want. Press the **▼▲** keys once at a time for fine adjustment.

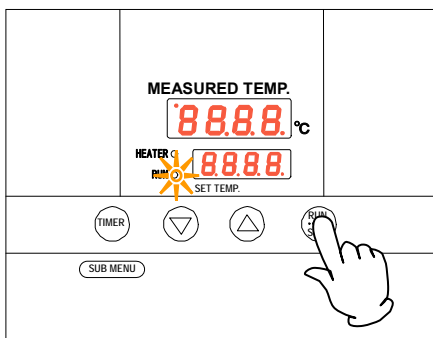

2. Starting timer operation

When the time you want is set, press the **RUN/STOP** key while the set temperature screen is blinking.

The RUN lamp blinks and timer operation is started.

Timer starts counting when the temperature in the chamber reaches the set temperature.

Once timer counting is started, the set temperature screen changes to the remaining time display.

3. Stopping and ending timer operation

Operation stops automatically when the set temperature has elapsed.

Characters **End** **End** blink on the set temperature screen to indicate operation has ended.

Press the **RUN/STOP** key for approx. one second to end the timer operation mode. The screen switches to the initial setting screen.

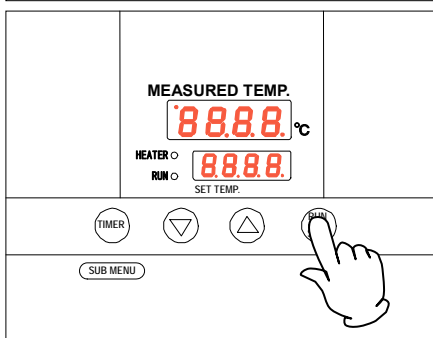

4. Operating procedures

Operating procedures (quick auto stop operation)

When you want to correct set temperature or set time, or change settings

When you want to change settings, press the ▼▲ keys on the current screen to enter the setting mode where you can change settings. Blinking stops three seconds after change and setting is completed. Note, however, that temperature changes after timer activation are counted also while temperature is changing.

When you want to change settings before timer activation, press the **TIMER** key on the current screen to enter the setting mode where you can change settings. Enter a time duration from when the set temperature is reached to the time the device shall be stopped.

When you want to change settings after timer activation, press the **TIMER** key on the current screen to enter the setting mode where you can change settings. Note, however, you need to set a time calculated by adding the time already passed to the time to be added.

After change has been made, press the **RUN/STOP** key to complete the process.

When you want to stop quick auto stop operation in the middle of it, press the **RUN/STOP** key long once to stop device control once, then make settings again in the appropriate mode.

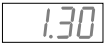
In terms of the remaining time display  a blinking dot indicates count down and an illuminating dot indicates a wait status (while temperature is increasing or decreasing to the set temperature) during which the timer has stopped counting.

4. Operating procedures

Operating procedures (auto stop operation)

This mode automatically stops fixed temperature operation after a certain time from its start set with the timer.

Procedures for auto stop operation

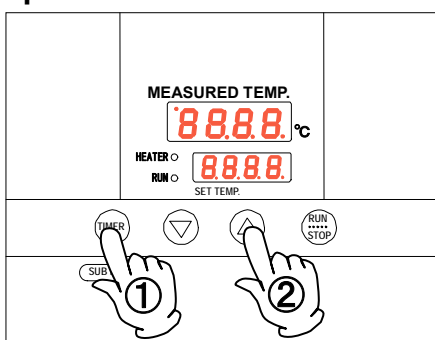

1. Setting a stop time

① After confirming the temperature you want is set, Press the **TIMER** key to display characters **AStP** **AStP** on the measured temperature screen that indicate auto stop operation.

The set time is displayed on the set temperature screen.

② Set a time you want using the **▼▲** keys. Pressing the **▼▲** keys makes the set time blink. The time is determined when blinking stops.

About the timer function

The maximum time that can be set for the timer is 999 hours 50 minutes.

Up to 99 hours 59 minutes, time can be set in minutes.

One hundred hours and over are set only in 10 minutes.

Keep the **▼▲** keys pressed to continuously change set time and you can quickly reach the time you want. Press the **▼▲** keys once at a time for fine adjustment.

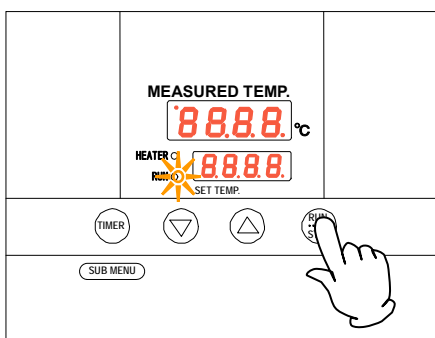

2. Starting timer operation

When the time you want is set, press the **RUN/STOP** key for about one second while characters **AStP** **AStP** that indicate auto stop operation are displayed on the measured temperature screen and the set time on the set temperature screen.

The **RUN** lamp blinks and timer operation is started.

Timer starts counting when the temperature in the chamber reaches the set temperature.

Once timer counting is started, the set temperature screen changes to the remaining time display.

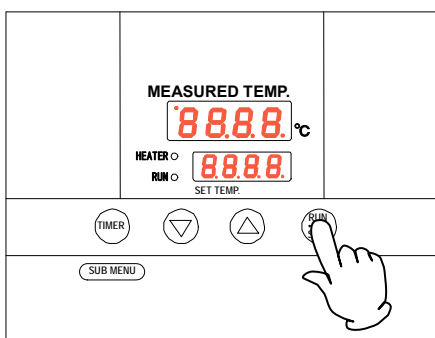

3. Stopping and ending timer operation

Operation stops automatically when the set temperature has elapsed.

Characters **End** **End** blink on the set temperature screen to indicate operation has ended.

Press the **RUN/STOP** key for approx. one second to end the timer operation mode. The screen switches to the initial setting screen.

4. Operating procedures

Operating procedures (auto stop operation)

When you want to correct set temperature or set time, or change settings

When you want to change settings, press the ▼▲ keys on the current screen to enter the setting mode where you can change settings. Blinking stops three seconds after change and setting is completed. Note, however, that temperature changes after timer activation are counted also while temperature is changing.

When you want to change settings before timer activation, press the **TIMER** key on the current screen to enter the setting mode where you can change settings. Enter a time duration from when the set temperature is reached to the time the device shall be stopped.

When you want to change settings after timer activation, press the **TIMER** key on the current screen to enter the setting mode where you can change settings. Note, however, you need to set a time calculated by adding the time already passed to the time to be added.

After change has been made, press the **RUN/STOP** key to complete the process.

Auto stop operation is not available together with auto start operation.

When you want to stop auto stop operation in the middle of it, press the **RUN/STOP** key long once to stop device control once, then make settings again in the appropriate mode.

In terms of the remaining time display **1.30** a blinking dot indicates count down and an illuminating dot indicates a wait status (while temperature is increasing or decreasing to the set temperature) during which the timer has stopped counting.

4. Operating procedures

Operating procedures (auto start operation)

This mode automatically starts fixed value operation after a certain time from its start set with the timer.

However, operation does not stop automatically but needs to be stopped manually.

Procedures for auto start operation

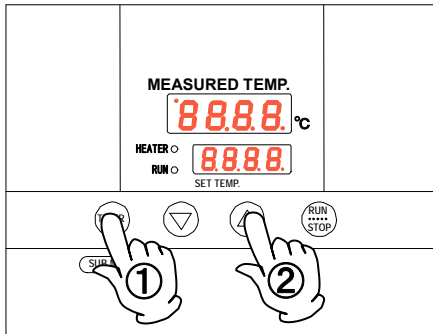

1. Setting an operation start time

- ① After confirming the temperature you want is set, Press the **TIMER** key to display characters AStr **AStr** on the measured temperature screen that indicate auto start operation. The set time is displayed blinking on the set temperature screen.
- ② Set a time you want using the **▼▲** keys. Pressing the **▼▲** keys makes the set time blink. The time is determined when blinking stops.

About the timer function

The maximum time that can be set for the timer is 999 hours 50 minutes.

Up to 99 hours 59 minutes, time can be set in minutes.

One hundred hours and over are set only in 10 minutes.

Keep the **▼▲** keys pressed to continuously change set time and you can quickly reach the time you want. Press the **▼▲** keys once at a time for fine adjustment.

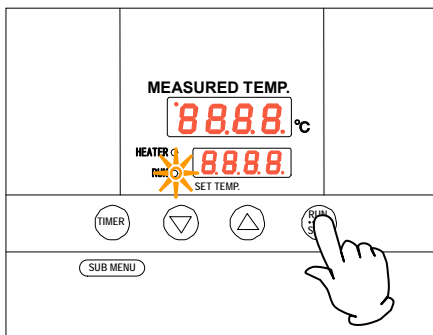

2. Starting timer operation

When the time you want is set, press the **RUN/STOP** key for about one second while characters AStr **AStr** that indicate auto start operation are displayed on the measured temperature screen and the set time on the set temperature screen.

Timer starts counting when the **RUN/STOP** key is pressed and RUN lamp blinks.

Display on the measured temperature screen switches from set time display to remaining time display.

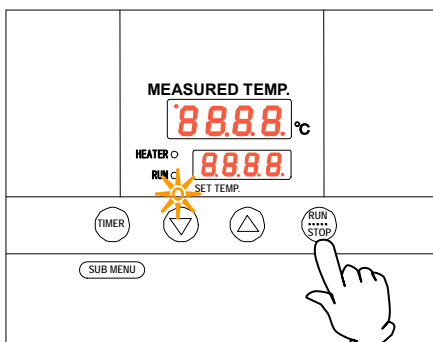

3. Stopping and ending timer operation

Operation automatically starts at the set time and the **RUN** lamp comes on.

To stop operation, press the **RUN/STOP** key for approx. one second to end the timer operation mode. The screen switches to the initial setting screen.

4. Operating procedures

Operating procedures (auto start operation)

When you want to correct set temperature or set time, or change settings

When you want to change the set temperature during timer counting, press the ▼▲ keys during that status to switch the set temperature screen to the set temperature input mode, which blinks to enable change of the set temperature with the ▼▲ keys.

When you want to change the set time during timer counting, press the **TIMER** key during that status to switch the set temperature screen to the set time input mode, which blinks to enable change of the set time with the ▼▲ keys.

In either case, the set temperature screen will stop blinking after a while and switch to the timer count mode and the change made is determined. Note, however, when you change the set time you need to set a time calculated by adding the time already passed to the time to be added.

When operation has started after the auto start time, you cannot change the set time.

When you want to stop auto start operation in the middle of it, press the **RUN/STOP** key long to stop device control once, then make settings again in the appropriate mode.

In terms of the remaining time display  a blinking dot indicates count down and an illuminating dot indicates a wait status (while temperature is increasing or decreasing to the set temperature) during which the timer has stopped counting.

4. Operating procedures

Useful functions (calibration offset function)

Using the calibration offset function

Calibration offset function compensates any differences between the target temperature in the chamber and the control temperature of the controller (sensor temperature.) The function can compensate in parallel to either plus or minus side for the whole temperature band of the unit.

The lock can be set or released with the **SUB MENU** keys.

The temperature is set at “0” on shipping from the factory.

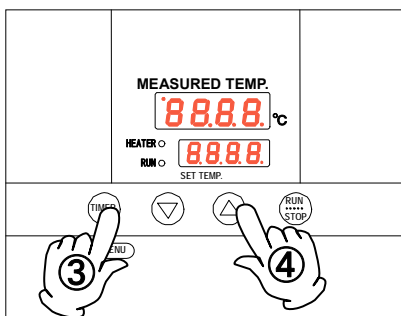
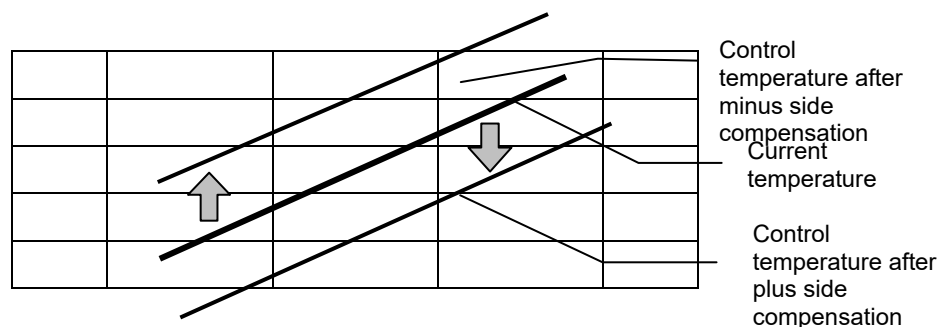

- ① Start operation at the target set temperature and confirm the temperature in the chamber with a temperature recorder after temperature has stabilized.
- ② Confirm the difference between the set temperature and that in the chamber.
- ③ Press the **TIMER** key (**SUB MENU** key) long to enter the sub menu mode. Press the **TIMER** key (**SUB MENU** key) several times to select the characters cAL **cAL** that indicates the calibration offset function.
- ④ Enter the difference between the set temperature and the temperature in the chamber using the **▼▲** keys and press the **TIMER** key (**SUB MENU** key) long to exit the sub menu mode. (When you want to set the key lock function, proceed to character selection process for the key lock function without pressing the **TIMER** key (**SUB MENU** key) long.)

- * You can set either of + or – side for the offset compensation temperature. When compensation is set for the – side, the measured temperature display decreases by the compensation temperature while the temperature in the chamber increases by the same amount. When compensation is set for the + side, the measured temperature display increases by the compensation temperature while the temperature in the chamber decreases by the same amount.
- * Since too large a compensation value may result in larger difference between the actual and indicated temperatures and may present a danger, consult our nearest sales office before entering a large compensation value.
- * The device has, in addition to the calibration offset function, the two-point compensation function that adjusts offset for the lower temperature range and higher temperature range, for which adjustment temperatures have been input on shipping from the factory.
- * Consult the nearest sales office before attempting validation work for the temperature adjusting device.

4. Operating procedures

Useful function (setting lock function)

Using the lock function

This function locks the set operation status.

The temperature is set at “off” on shipping from the factory.

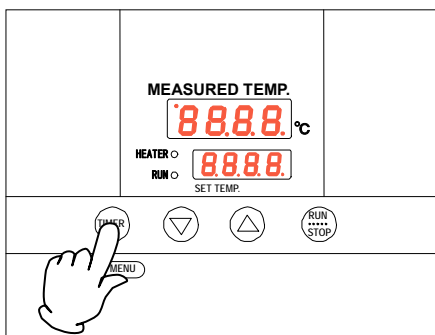

- (1) Press the **TIMER** key (**SUB MENU** key) long to enter the sub menu mode.

Press the **TIMER** key (**SUB MENU** key) several times to select the characters Lock **Loch** that indicate the setting lock function.

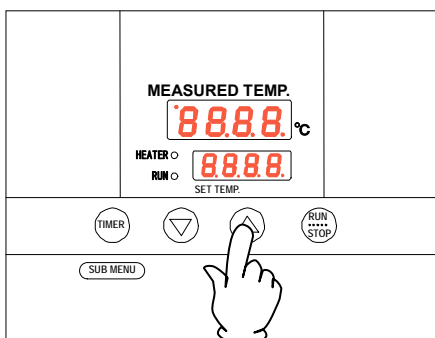

- (2) “Off” is displayed on the set temperature screen. To lock settings, change to “on” using the **▲** key.

Press the **TIMER** key (**SUB MENU** key) long to exit the sub menu mode.

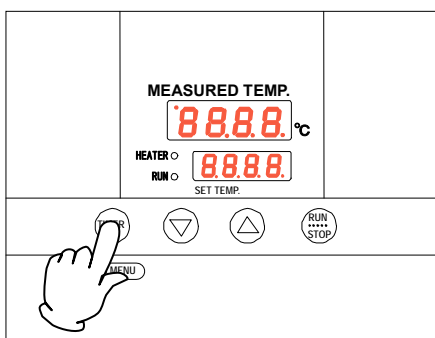

- (3) To release lock, press the **TIMER** key (**SUB MENU** key) long again and select the characters Lock **Loch** that indicate setting lock using the **▼▲** keys.

Lock is released when “off” is selected using the **▼** key.

* When the lock function is “on”, keys other than the **RUN/STOP** key and the **TIMER** key (**SUB MENU** key) are locked.

4. Operating procedures

Useful function (power outage compensation function)

Using the power outage compensation function

The power outage compensation function returns the main unit operation to the resume status after recovery from power outage, or keeps the current stop status.

The function is set at “on” on shipping from the factory.

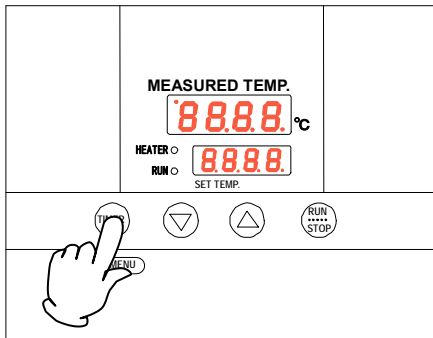

- (1) Press the **TIMER** key (**SUB MENU** key) long to enter the sub menu mode.

Press the **TIMER** key (**SUB MENU** key) several times to select the characters Pon **Pon** that indicate the power outage compensation function.

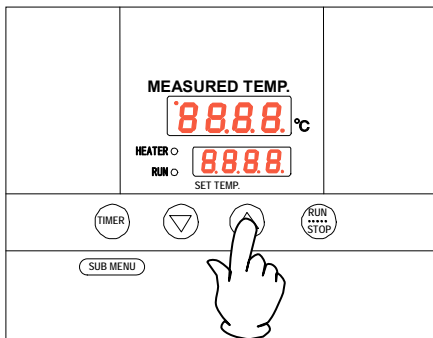

- (2) “On” is displayed on the set temperature screen. The device keeps stop status after recovery from power outage when this setting is set to “off” using the ▼ key.

Press the **TIMER** key (**SUB MENU** key) long to exit the sub menu mode.

5. Cautions on handling



Warning

1. About handling of flammable or combustible solution

-  The unit is not explosion proof. Take special care for handling samples on which explosive substances, combustible substances or substances containing them. Flammable or combustible solution will evaporate when left at a room temperature (or at a lower temperature for some types of solutions) and may be ignited and explode from switches, lights and other ignitable sources. Be sure to assure sufficient ventilation when using these materials.
See section "13. List of dangerous materials" on page 37.

2. Ban on use/countermeasures when an error occurs

-  If smoke emerges from the unit or an odd odor is felt, immediately turn the power switch on the main unit off, turn the power supply off and contact your dealer or a Yamato sales office for inspection. Otherwise, a fire or an electrical shock may result. The user shall never attempt to repair the unit to avoid any possible dangers.

3. Secure sufficient ventilation for the unit.

-  Do not operate the unit when its vent holes on the side and rear panels covered or blocked. Internal temperature of the unit will rise degrading the performance and an accident, a malfunction or a fire may result.

4. Do not allow liquid to spill over the unit.

-  Do not allow liquid to spill over the unit. Pay special attention not to allow liquid to enter into the vent holes on the side and rear panels of the unit. If liquid is spilt over or into the unit, do not try to operate it any further. Other wise, an accident, a malfunction, a fire or an electrical shock may result.

5. Do not allow a metal piece to fall into the unit.

-  Do not allow a clip, a staple, a screw or other metal pieces to fall into the unit. Stop operating the unit if a metal piece has dropped into the unit. Other wise, an accident, a malfunction, a fire or an electrical shock may result.

6. Do not open the cabinet.

-  Do not open panels or covers fixed on the unit, or do not operate the unit with any of those open. Other wise, an accident, a malfunction, or an electrical shock may result.

7. Always operate the unit at a correct ambient temperature.

-  The operating temperature range is room temperature range from +5~80°C above room temperature. Never try to operate the unit outside the operating temperature range.

8. Do not attempt to modify the unit.

-  The user shall never try to modify the unit; other wise, an accident, a malfunction, a fire or an electrical shock may result.

5. Cautions on handling



Caution

1. Do not step on the unit.



Do not step on the unit. Otherwise, the unit may trip over or be damaged resulting in a personal injury or a malfunction.

2. Do not put or drop an object on the unit.



Do not put or drop an object on the unit. Since the unit contains high precision devices, vibrations or shock may cause a malfunction.

3. When a thunder is heard.



When a thunder is heard, turn the power switch on the main unit off then turn the main power off immediately. Otherwise, a lightning strike may result and cause a fire.

4. During night and not to be operated for a long period of time.



During the night and when you want to stop the unit for a longer period of time, turn the power switch to "off" and pull out the power cord from the power supply.

5. About recovery from power outage.



When the power is applied again after the unit has stopped due to power outage, the unit will automatically return to the status immediately before the power outage and resumes operation.
Turn the power switch off if you do not want to resume operation by automatic recovery.

6. About two-tier stacking



Use the dedicated optional parts to stack units in two tiers. Contact you dealer or the nearest sales office for the dedicated optional part.

7. When opening or closing the door



When opening or closing the door, do not put your hand or face close to the area the door moves (space).
The door may touch your hand or face and causing an injury.

8. Do not operate the unit with the door open.



When the unit is operated with the door open, proper temperature control is not possible and the heater may overheat causing a possible danger. Be sure to operate the unit with the door closed.

9. About installation of shelf boards and samples



Place shelf boards and samples according to "Installation procedures · precautions" on page 7. Otherwise, the optimal performance of the unit will not be obtained and an accident or a malfunction may result.

10. Do not attempt to do anything other than specified in this operation manual.



Do not attempt to do anything other than specified in this operation manual. Otherwise, an unexpected accident may result.

6. Maintenance procedures

Daily inspection/maintenance

Be sure to perform daily inspection and maintenance to assure reliable operation of the unit.

Warning

- Be sure to pull out the power cord unless necessary before trying to do inspection and maintenance works.
- Start these works after the device has returned to the normal temperature.
- Never try to disassemble the unit.

Caution

- Wipe off any dirt with a tightly wrung soft cloth. Never try to clean the unit with benzene, thinner or scouring powder, or rub with a scrubbing brush. Deformation, degradation or discoloration may result.

Maintenance of the internal chamber

Stop operation and turn the power switch to OFF. Pull out the power cord off the distribution board and the wall outlet. Confirm the temperature in the device and remove shelf boards and clamps.

The internal chamber, shelf boards and shelf clamps are made of stainless steel and reinforced glass is used for the inner door. To clean these items, thoroughly wipe with a cloth moistened with cleaning alcohol then wipe gently with a dry cloth.

Never use acid detergent, alkaline detergent, oil or organic solvent, which may cause corrosion or damage to the products.



There are sharp protrusions inside the internal chamber, shelf boards and shelf pillars and shall be handled with special care to avoid personal injury. Be sure to wear gloves since handling with bare hands may present danger.

7. When the unit is not to be used for a long time or when disposing

When the unit is not to be used for a long time or when disposing



Caution

When the unit is not going to be used for a long time

- Turn the power switch to off and pull out the power cord.



Warning

When disposing the unit

- Do not leave the unit in the area where children may have access.
- Be sure to remove handles before disposing the unit to prevent the doors from locking.
- In general, dispose the unit as a bulky waste.

Notes about disposition

Always pay attention to the preservation of the global environment.

- We highly recommend taking the unit apart as far as possible for separation or recycling to contribute to the preservation of the global environment. Major components and materials for the unit are as follows:

Names of major components	Major materials
Major exterior components	
Exterior	Steel plate SPCC (powder coating)
Internal chamber	Stainless steel
Packing, gaskets, etc.	Neoprene rubber
Major electric parts	
Switches and relays	Resin, copper
Boards	Glass fiber
Heater	Iron-chrome
Power cord	Synthesized rubber sheath, copper, nickel



8. Troubleshooting

Safety device and error codes

The unit has the self diagnostic function with a controller and a separate safety device. Table below shows possible causes and measures when the safety device is triggered.

[Error codes]

When a functional or mechanical abnormality occurs, the alarm lamp on the control panel comes on, an error code will be displayed and the alarm buzzer sounds. When an abnormality occurs, confirm the error code and immediately stop operation.

Safety device	Symptom	Possible causes and measures
Sensor error	 appears	<ul style="list-style-type: none"> ● Error in the temperature input circuit ● Disconnection or other errors in the temperature sensor. ● Measured temperature is outside the displayable range Contact our service department.
Memory error	 appears	<ul style="list-style-type: none"> ● Memory setting error Contact our service department.
Measured temperature error	----- ----- appears	<ul style="list-style-type: none"> ● When the upper limit alarm of the temperature alarm function is triggered. Contact our service department.

8. Troubleshooting

When a malfunction is suspected

If any of the symptoms below occurs

Symptom	Check
Turning the MCB to on will not activate the unit.	<ul style="list-style-type: none">● If the power cord is connected to the power supply securely.● If power outage is not occurring.● If the standalone overheat prevention device is working.
Temperature does not rise.	<ul style="list-style-type: none">● If the set temperature is below that in the device.● If the power supply voltage has declined.● If the ambient temperature is not low.● If cooling load for inside the chamber is not too large.
Temperature fluctuates during operation.	<ul style="list-style-type: none">● If the set temperature is appropriate.● If the power supply voltage has declined.● If ambient temperature fluctuates widely.● If cooling load for inside the chamber is not too large.
Displayed temperature differs from the measurement.	<ul style="list-style-type: none">● If the calibration offset setting is not other than "0". Set it to "0." Confirm settings in "Useful functions (calibration offset function)" in page 24.

If power outage occurs

When the power is applied again after the unit has stopped due to power outage, the unit will automatically return to the status immediately before the power outage and resumes operation. Turn the SW off if you do not want to resume operation by automatic recovery.

- ◆ If the symptom does not match any of the above, immediately turn the power switch on the main unit off, pull out the power cord from the power supply and contact your dealer or one of our sales offices.

9. After sales service and warranty

When requesting a repair

When requesting a repair

If any trouble occurs, immediately stop operation, turn the power switch off, pull out the power plug and contact your dealer or our sales office.

Information necessary for requesting a repair

- Model name of the product
 - Serial number
 - Date (y/m/d) of purchase
 - Description of trouble (as in detail as possible)
- } See the warranty card or the nameplate installed on the unit.
See 3. Names and functions of parts on page

Be sure to indicate the warranty card to our service representative

Warranty card (attached separately)

- Warranty card is given by your dealer or one of our sales offices and please fill in your dealer, date of purchase and other information and store securely.
- Warranty period is one full year from the date of purchase. Repair service for free is available according to the conditions written on the warranty card.
- For repairs after the warranty period consult your dealer or one of our sales offices. Paid repair service is available on your request when the product's functionality can be maintained by repair.

Minimum holding period of repair parts

The minimum holding period of repair parts for this product is seven years after end of production.

Repair parts here refer to parts necessary for maintaining performance of the product.

10. Specifications

Model		IC903C/903CW
Performance	Operating temperature range	Room temperature +5°C~80°C (no load at an ambient temperature of 23°C)
	Temperature control precision	±0.5°C (setting: 37°C)
	Temperature distribution precision	±1°C (setting: 37°C)
Mechanism	Heater	0.6 kW*2
		Iron-chrome wire heater
Control part	Controller	Model CN40B-Y PID control
	Control system	PID control with a micro computer
	Setting system	Digital setting using up/down keys
	Operation mode	Fixed temperature operation, quick auto stop operation Auto stop operation, auto start operation
	Sensor	K-thermocouple
	Auxiliary functions	Lock function, power outage compensation function, calibration offset function
Safety device	Controller Self diagnostic function	Temperature sensor error, memory error, auto overheat prevention, measured temperature error
	Protection device	An over current fuse
Standard	Outer dimensions (mm) (w x d x h)	1180 × 656 × 1619
	Internal dimensions (mm) (w x d x h)	1070 × 530 × 1000
	Internal volume	567ℓ
	Inner door	Reinforced glass door x4
	Weight (tentative value)	Approx. 166 kg
	Power supply	AC115V 50/60Hz 12A
Included items	Shelf board x 8	
	Shelf withstand load Approx. 15kg/each board	
	Operating instructions, warranty card	

*Performance values are for the AC115V power supply.

*Operating environmental temperature range for this device is 5°C~35°C.

11. Wiring diagram

IC903C/903CW

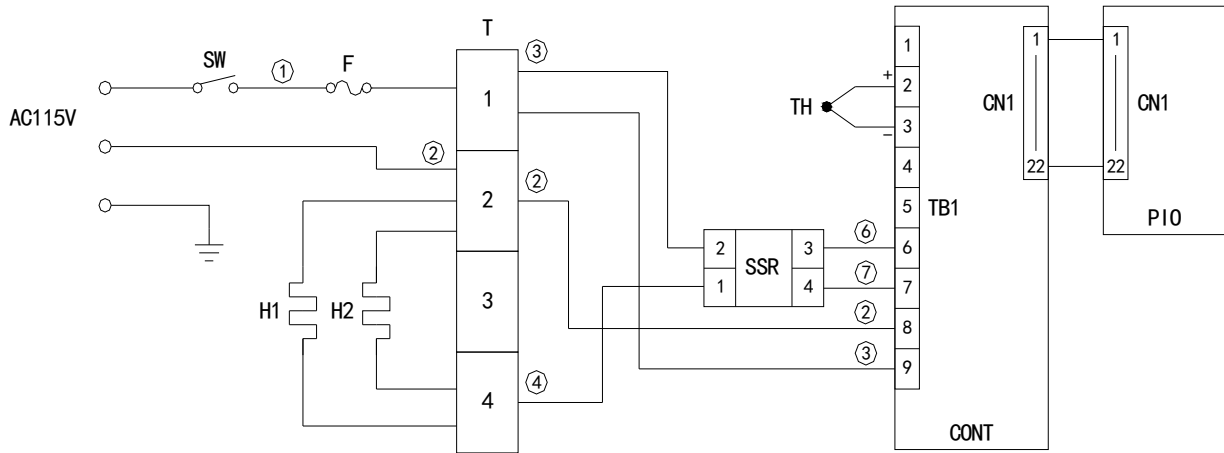

Symbol	Part name	Symbol	Part name
SW	power switch	SSR	No-contact relay
F	Fuse	CONT	Control circuit board
T	Terminal block	PIO	Display circuit board
H1, 2	Heater	TH	Control sensor

12. List of replacement parts

Replacement parts

Symbol	Part name	Standard	Maker	Code No.
SW	power switch	AC250V 16A	YSJ	SJA07732
F	Fuse	AC250V 15A (IC903C/903CW)	YSJ	SJK06492
TH	Control sensor	φ 3.2*55*2000	YSJ	SJA14012
CONT	Planar board	CN40B-Y	YSC	LT00007640
PIO	Display circuit board	CN40B-Y	YSC	LT00007639
SSR	No-contact relay	G3NB-225B-1 DC5~24V	YSJ	A011006011
H1 · 2	Heater	100V 600W (IC903C/903CW)	YSC	B080504006

13. List of dangerous materials



Never use an explosive substance a flammable substance or a substance containing them for this device.

Explosive substance	Explosive substance	① Nitroglycol, glycerine trinitrate, cellulose nitrate and other explosive nitrate esters
		② Trinitrobenzen, trinitrotoluene, picric acid and other explosive nitro compounds
		③ Acetyl hydroperoxide, methyl ethyl ketone peroxide, benzoyl peroxide and other organic peroxides
Flammable substances	Explosive substances	Metal "lithium", metal "potassium", metal "natrium", yellow phosphorus, phosphorus sulfide, red phosphorus, celluloids, calcium carbide (a.k.a, carbide), lime phosphide, magnesium powder, aluminum powder, metal powder other than magnesium and aluminum powder, sodium dithionous acid (a.k.a., hydrosulphite)
	Oxidizing substances	① Potassium chlorate, sodium chlorate, ammonium chlorate, and other chlorates
		② Potassium perchlorate, sodium perchlorate, ammonium perchlorate, and other perchlorates
		③ Potassium peroxide, sodium peroxide, barium peroxide, and other inorganic peroxides
		④ Potassium nitrate, sodium nitrate, ammonium nitrate, and other nitrates
		⑤ Sodium chlorite and other chlorites
		⑥ Calcium hypochlorite and other hypochlorites
	Flammable substances	① Ethyl ether, gasoline, acetaldehyde, propylene chloride, carbon disulfide, and other substances with ignition point at a degree 30 or more degrees below zero.
		② n-hexane, ethylene oxide, acetone, benzene, methyl ethyl ketone and other substances with ignition point between 30 degrees below zero and less than zero.
		③ Methanol, ethanol, xylene, pentyl acetate, (a.k.a.amyl acetate) and other substances with ignition point between zero and less than 30 degrees.
④ Kerosene, light oil, terebinth oil, isopenthyl alcohol(a.k.a. isoamyl alcohol), acetic acid and other substances with ignition point between 30 degrees and less than 65 degrees.		
Combustible gas		Hydrogen, acetylene, ethylene, methane, ethane, propane, butane and other gases combustible at 15 degrees at one air pressure.

14. Standard installation manual

*Install the product according to the following: (Confirm separately for optional items or special specifications)

Model	Serial number	Date	Installation mgr. (company name)	Installation mgr.	Judgment

No.	Item	Implementation method	TOC No. Reference page of the operating instruction manual	Judgment
Specifications				
1	Included items	Check for number of staffs against the included item field	10. Specifications field P.34	
2	Installation	<ul style="list-style-type: none"> Visual check of environmental conditions Caution: Take care for environment 	2. Before operating the unit P.4 <ul style="list-style-type: none"> On the installation site 	
		<ul style="list-style-type: none"> Securing a space 		
Operation-related matters				
1	Source voltage	<ul style="list-style-type: none"> Measure the user side voltage (outlet) with a tester Measure voltage during operation (shall meet the standard) Caution: Always use a plug that meets the specification for attaching to the power switch. 	2. Before operating the unit P.6 <ul style="list-style-type: none"> Be sure to connect the ground wire. P.6 Power supply is P.6 10. Specifications P.34 <ul style="list-style-type: none"> Specification-power supply 	
2	Operation start	<ul style="list-style-type: none"> Starts operation Performs fixed temperature operation, auto stop operation or auto start operation 	2. Before operating the unit P.4~9 <ul style="list-style-type: none"> Installation procedures... P.14~ 4. Operating procedures 26	
Description				
1	Operational descriptions	Explain operations of each component according to the operational instructions	4. Operating procedures P.14~26 <ul style="list-style-type: none"> Operating procedures 1. Safety precautions P.1~37 <ul style="list-style-type: none"> List of dangerous materials 	
2	Error codes	Explain the customer about error codes and procedures for release according to the operational instructions	8. Troubleshooting P.31~33 <ul style="list-style-type: none"> After sales service and warranty 	
3	Maintenance and inspection	Explain operations of each component according to the operational instructions	6. Maintenance procedures P.29 <ul style="list-style-type: none"> Daily inspection/maintenance 	
4	Completion of installation Entries	<ul style="list-style-type: none"> Fill in the installation date and the installation mgr. on the nameplate of the main unit Fill in necessary information to the warranty card and hand it over to the customer Explanation of the route for after-sales service 	9. After sales service and warranty P.33	

Limited liability

Be sure to use the unit strictly following the handling and operating instructions in this operating instruction.

Yamato Scientific Chongqing Co., Ltd. assumes no responsibility for an accident or a malfunction caused by use of this product in any way not specified in this operating instruction.

Never attempt to perform matters prohibited in this operation instruction.

Otherwise, an unexpected accident may result.

Notice

- Descriptions in this operating instruction are subject to change without notice.
- We will replace a manual with a missing page or paging disorder.

Instruction Manual
General purpose incubator
IC903C/903CW
Forth edition 13 Apr 2018
Revision

Yamato Scientific America, Inc.
925 Walsh Ave, Santa Clara, CA 95050
Tel:408-235-7725
For technical information
and service, call: 1-800-292-6286
<http://www.yamato-usa.com>