

SINCE 1889



LABORATORY REFRIGERATORS AND FREEZERS SLR AND SLF SERIES

MODEL

INSTRUCTION MANUAL

- FIRST EDITION -

- Thank you for purchasing SLR & SLF Series Laboratory Refrigerators and Freezers of Yamato Scientific.
 - To use this unit properly, read this "Instruction Manual" thoroughly before using this unit. Keep this instruction manual around this unit for referring at any time.
- !** **WARNING:** Carefully read and thoroughly understand the important warning items described in this manual before using this unit.

**Yamato Scientific America Inc.
Santa Clara, CA**

Index

1. STANDARDS AND GENERAL WARNINGS	3
1.1 TESTING AND INTENDED USE.....	4
1.2 INTRODUCTION.....	4
1.3 PRODUCT DESCRIPTION.....	4
1.4 CERTIFICATION.....	5
1.5 GENERAL SAFETY REGULATIONS.....	5
1.6 CUSTOMER'S RESPONSIBILITIES.....	6
1.7 CUSTOMER SERVICE REQUESTS.....	6
1.8 ORDERING OF SPARE PARTS.....	6
1.9 PRODUCT CONFIGURATION.....	6
1.10 MATERIALS AND REFRIGERANTS.....	6
1.11 WARNING LABELS.....	7
2. INSTALLATION	9
2.1 TRANSPORTATION AND HANDLING.....	9
2.2 POSITIONING.....	10
2.3 WIRING AND ELECTRICAL HOOK-UP.....	10
2.4 SET UP OPERATIONS.....	11
2.5 RE- INSTALLATION.....	11
2.6 STABILIZER BRACKET DETAILS.....	11
2.7 SCRAPPING AND DISPOSAL.....	13
2.8 REMOTE ALARM CONNECTION.....	13
3. OPERATION	14
3.1 CONTROLLER GENERAL DESCRIPTION.....	14
3.2 REGULATION.....	15
3.3 CONTROLLER USER INTERFACE AND MAIN FUNCTION.....	16
3.3.1 Switching the device ON/OFF.....	16
3.3.2 Use of LEDs.....	16
3.3.3 Keypad unlocking.....	17
3.3.4 Operational temperature settings.....	17
3.3.5 Manual defrost.....	17
3.3.6 Cabinet light ON/OFF (if the parameter u1=0).....	17
3.3.7 Buzzer.....	17
3.3.8 Overcooling/overheating cycle activation and Manual energy saving.....	17
3.3.9 Displaying/reset the compressor operational time.....	17
3.3.10 Displaying temperature probes.....	18
3.3.11 Setting operational parameters.....	18
3.3.12 Setting data and time.....	18
3.3.13 Alarms.....	19
3.3.14 Electrical connection.....	19
3.3.15 Default parameters value and description.....	20
4. MAINTENANCE AND REPAIR	25
4.1 ROUTINE MAINTENANCE.....	25
4.1.1 Cleaning the interior and exterior of the appliance.....	25
4.1.2 Condenser cleaning.....	25
4.1.3 Sliding door's rails cleaning.....	25
5. TROUBLESHOOTING	26
6. SPARE PARTS	27
7. WARRANTY	28

1. STANDARDS AND GENERAL WARNINGS

PRODUCTS APPLICABLE TO THIS MANUAL

The present manual is exclusively valid and applicable to the following products range:

Scientific upright refrigerators

Adjustable temperature control range: lowest T = +1°C (33,8°F), highest T = +12°C (53,6°F)

Operating temperature: +4°C to 6°C (39,2°F to 42,8°F)

Factory pre-set to: +4°C (39,2°F)

Models: *SLR301SG; SLR701SG; SLR701SS; SLR801SG; SLR801SS; SLR1301DG; SLR1301DS; SLR1301DGSL; SLR2001TG*

Scientific upright freezers

Adjustable temperature control range: lowest T = -25 °C (-13°F), highest T = -10 °C (14°F)

Operating temperature: -22 °C to -20 °C (-7,6°F to -4°F)

Factory pre-set to: -20 °C (-4°F)

Models: *SLF701SS; SLF1301DS*

Environmental Operating Conditions

- Nominal environmental operating condition: **Climatic class 4** (30°C, HR%=55%);
- Ambient temperature operating range: **10°C~40°C**;
- Humidity: **50% maximum, non-condensing**;
- Electrical supply: **110~127V/60Hz**;
- Altitude: **2000 meters MSL** (Mean Sea Level);
- Usage: **This product is intended for use indoors only.**

1.1 TESTING AND INTENDED USE

This equipment is tested in compliance with established regulations and then shipped ready for use. This equipment is intended for general purpose laboratory cold storage.

“If the equipment is used in a manner not specified by the manufacturer, the protection provided by the equipment may be impaired.”

1.2 INTRODUCTION

This manual provides all instructions required for the correct use of the equipment and to keep it in optimal condition. It also contains important user safety information. The following professional roles are explained in order to define individual responsibilities:

Installer: a qualified technician who installs the equipment in accordance with these instructions.

User: the person who, after having read this manual carefully, uses the equipment in accordance with the intended specification of use described in this manual. User's responsibilities: ensure that the product is kept at suitable temperatures in an ambient environment less than +40°C (104°F); be aware of the regulations governing the conservation of products to refrigerate and to observe any whatsoever hygiene indications that may be applicable. The user is obliged to carefully read the manual and refer to its information at all times. Particular attention must be paid to safety warnings (refer to Section 1.5).

Routine maintenance technician: qualified operator able to perform routine maintenance of the equipment by following the instructions in this manual.

Service engineer: qualified technician, authorized by the manufacturer to perform extraordinary maintenance of the equipment.

The symbol  appears at certain points in the manual to draw the reader's attention to important safety information. The manufacturer declines any responsibility in case of improper use of the equipment deviating from the reasonably construed intended use, and for all operations carried out that are not in compliance with the instructions reported in the manual.

This manual must be stored in an accessible and known place for all operators (installer, user, routine maintenance technician, service engineer).

1.3 PRODUCT DESCRIPTION

The equipment comprises a single body with paneling in various materials and insulation with expanded polyurethane foam. The equipment instruments are located on the front panel where the electrical wiring is housed. The motor unit and the evaporator unit are housed on the top of body. The interior parts are fitted with suitable supports for shelves. The doors are fitted with an automatic return device and magnetic seal elements. During the design and construction stage all measures have been adopted to implement total safety including radius interior corners, funnel-shaped base panel to convey condensate to exterior, no rough surfaces, fixed guards protecting moving or potentially dangerous parts.

1.4 CERTIFICATION

The appliances listed in this manual are manufactured in accordance with the following regulations:

- **UL/CSA 61010-1 3rd edition and IEC 61010-2-011** (file ref.: E498782)
- **Energy Star Certification: High Performance lab grade refrigerators and freezers-** according following Standards:10CFR Part 431 Subpart C,10 CFR Part 431.64 and 10CFR part 431.66(e)/NRCAN:CAN/CSA C657-15.
- **Packaging certification: ISTA 3E.**

1.5 GENERAL SAFETY REGULATIONS

Read this manual carefully and follow the instructions contained herein.

The user assumes full responsibility in case of operations carried out without observing the instructions in the manual.

 **Do not use this product with flammable gases or flammable solvents.**

 **Do not store flammable gases, flammable liquids or flammable solids in these units.**

Primary general safety regulations:

- Do not touch the unit with wet hands and/or feet. Do not use the equipment with bare feet;
- Do not insert screwdrivers or other pointed objects between guards or moving parts of the equipment;
- Do not pull the power cord to disconnect the equipment from the electrical mains Make sure that the equipment is not used by unsuitably qualified persons;
- Before performing any cleaning or maintenance on the equipment disconnect it from the electrical mains by switching off the main switch and extracting the plug;
- **Never** use any metallic scouring pads, brushes, abrasive cleaners or strong alkaline solution on any surface.
- The relocation of the unit must be performed by qualified personnel. Do not shift the refrigerator from side to side as this may create leakage point across the cooling unit piping.

- In case of faults or malfunctions, switch off the equipment and do not attempt to repair it by yourself as doing so may void the warranty. All service and repair operations must be performed exclusively by a manufacture's authorized engineer. (Authorized service technician, trained service personnel, authorized service personnel)
- Propane fridge/freezer, like any other appliance, must have access to fresh air/oxygen;

 **Do not use FLAME to check for gas leak.**

 **Do not under any circumstances** try to modify or repair valves, regulator, connectors, controls or any other appliance. Doing so creates the risk of a gas leak.

1.6 CUSTOMER'S RESPONSIBILITIES

The customer is required to:

- Execute the electrical connection of the equipment Prepare the place of installation;
- Provide consumable materials for cleaning Perform routine maintenance;
- In the case of power failures or malfunctions do not open the doors, in order to maintain the internal temperature for as long as possible. If the problem persists for more than a few hours, move the contents to a more suitable place.

1.7 CUSTOMER SERVICE REQUESTS

- For all technical problems and any requests for technical service, refer exclusively to the manufacturer's authorized personnel;

1.8 ORDERING OF SPARE PARTS

- Orders of spare parts should be made by consulting the part reference code and the serial number of your unit. Consult your dealer.

1.9 PRODUCT CONFIGURATION

- The unit is designed solely for the preservation of laboratory products, which requires various controls and warning in case of sudden alteration of temperature.









 **PRODUCTS MUST BE STORED IN ORDER TO ENSURE EFFICIENT AIR CIRCULATION INSIDE THE UNIT AND SHALL NOT COME OUT OF THE SHELF PERIMETER.**

- All uses outside of manufacturer's intended use in section 1.1 shall be construed as "improper use" for which the manufacturer declines all responsibility.
- It's allowed to accommodate on the shelf a maximum of 30kg per shelf in a 12 cu.ft.(400 liters) model and a maximum of 45 kg per shelf in a 25 cu.ft (700 liters), 30 cu.ft (900 liters), 49 cu.ft.(1400 liters) and 72 cu.ft.(2100 liters) models according to the **UL471** regulation. *[The most critical application in terms of weight (glass door/ stainless steel) has been tested following the Base standard UL 61010-1: The static weight was calculated considering a total load of 45 kg on each grid (exception 12cub.ft 30 kg). The dynamic load was considered only the weight in the cabinet without the load on the grids because the unit must be loaded when it is anchored to the wall, as reported in the user manual.]*

1.10 MATERIALS AND REFRIGERANTS

- Materials in contact or potentially in contact with products are in compliance with the relevant directives. The equipment designed and built so that contact parts can be cleaned before each use. The refrigerants utilized comply with established regulations.

1.11 WARNING LABELS

Electrical Shock	LABEL A
	Use of this equipment involves power supplies which convert line voltage to low voltage power. Do not modify or use power supplies other than OEM equipment. Connection of the power supply may require a properly grounded receptacle. Potential for electrical shock or equipment damage exists if precautions are not followed.
Hot Surface	LABEL B
	Avoid contact with the hot surfaces potential for skin's burns.
Cold Surface	LABEL C
	Avoid contact with cold freezer surfaces potential for cold burns or skin sticking to cold surfaces.
Safety Alert	LABEL D
	Important operating instructions. To reduce the risk of injury or poor performance of the unit read the user manual before putting the equipment into operation.
Warning	
	Indicates an immediately hazardous situation, which if not avoided, will result in death or serious injury.
Caution	
	Indicates an immediately hazardous situation, which if not avoided, may result in minor to moderate injury
Battery	LABEL E
	Indicates the location of the back-up battery
Risk of fire	LABEL F
	Risk of fire or explosion. Flammable refrigerant used. Follow handling instruction carefully. To be repaired only by trained service Personnel. Do not puncture Refrigerant Tubing.
Grounding	LABEL G
	Indicates that the electrical components are electrically grounded.

<p>Finger crashing</p>		
	<p>Risk of finger crashing</p>	
<p>This unit is intended for use in laboratories in commercial, industrial or institutional occupancies as defined in the Safety Standard for Refrigeration Systems,</p> <p>Conformément à la Norme de sécurité pour les systèmes de réfrigération (ASHRAE 15), cette unité est destinée à un usage dans les laboratoires d'établissements commerciaux,</p> <p><i>Refrigerating equipment</i></p>		<p>Refrigerating Equipment intended for laboratory use.</p>
<p>CAUTION - Risk Of Fire or Explosion due to Flammable Refrigerant Used. Follow Handling Instructions Carefully in Compliance with U.S. Government Regulations.</p> <p>AVERTISSEMENT - Risque d'incendie ou d'explosion dû au fluide frigorigène inflammable utilisé. Suivre les instructions de manutention conformément à la réglementation gouvernementale des États-Unis.</p> <p><i>Packaging markings</i></p>		<p>Packaging markings (Label attached upon the cartoon box)</p>
<p>DANGER - Risk Of Fire or Explosion. Flammable Refrigerant Used. To Be Repaired Only By Trained Service Personnel. Do Not Puncture Refrigerant Tubing.</p> <p>AVERTISSEMENT - Risque de fue ou d'explosion. Fluide frigorigène inflammable utilisé. Doit être réparé uniquement par le personnel de service formé. Ne pas perforer le tubage de réfrigérant.</p> <p><i>Service markings 1</i></p>		<p>Service markings. (Label located near the cooling unit compartment)</p>

INSTALLATION

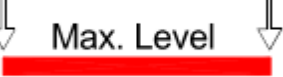
<p>CAUTION - Risk Of Fire or Explosion. Flammable Refrigerant Used. Consult Repair Manual/Owner's Guide Before Attempting To Install or Service This Product. All Safety Precautions Must be Followed.</p> <p>PRUDENCE - Risque de feu ou d'explosion. Fluide frigorigène inflammable utilisé. Consulter le manuel de réparation/guide du propriétaire avant de tenter d'installer ou de procéder a l'entretiene de ce produit. Toutes les</p> <p><i>Service markings 2</i></p>	<p>Service markings (Label located near the cooling unit compartment)</p>
<p>CAUTION - Risk Of Fire or Explosion. Dispose Of Properly In Accordance With Federal Or Local Regulations. Flammable Refrigerant Used.</p> <p>PRUDENCE - Risque de feu ou d'explosion. Éliminer correctement conformément aux règlements fédéraux ou locaux. Fluide frigorigène inflammable utilisé.</p> <p><i>Disposal</i></p>	<p>Disposal (Marking attached upon the exterior of the cabinet)</p>
<p>↓ Max. Level ↓</p> 	<p>Max high load</p>

2. INSTALLATION

2.1 TRANSPORTATION AND HANDLING



The equipment must be transported and handled exclusively in upright position, in observance of the instructions printed on the packing.

This precaution is necessary to avoid contamination of the refrigerant circuit with compressor lube oil with resulting valve and heat exchanger coil failure and problems starting the electric motor or the risk of a gas leak. The manufacturer is not responsible for any problems due to transport executed in conditions other than those specified herewith.

The equipment is secured to a wooden pallet base, wrapped in a plastic film and packaged into a three waves carton box.

The equipment must be handled using a forklift truck or a pallet truck with suitable forks (fork length at least equal to 2/3 length of unit).

2.2 POSITIONING

Incorrect positioning can cause damage to the equipment and generate hazardous conditions for personnel. The installer must therefore observe the following general regulations:

- Make sure you maintain a minimum of 2" (5 cm). clearance from the walls and 15" (40 cm) from the ceiling. The room must be well ventilated.
- Keep well away from sources of heat. Avoid direct sunlight
- Remove packing material.
- Remove accessories from inside the unit.
- Carton box or Wood base removal: using a hammer, tilt the cabinet to one side and loosen the two thread-forming screws, drag the cabinet from the back side holding the base still until the four castors have gone out from the containing holes, slightly tilt the cabinet backward and take the base away pulling it from the front side.



Use gloves when handling the 3 Waves carton box or the wooden base to protect the hands from splinters.

- Position the equipment with the help of a level. Remove the protective PVC film from the external surfaces of the unit.
- Position the shelf runners in the holes in the uprights. Insert the shelves in the runners.

2.3 WIRING AND ELECTRICAL HOOK-UP

Receptacle installation and electrical wiring operations must be performed by a qualified electrician. For safety reasons adhere to the following indications:

- Check that the electrical plant is suitably sized for the absorbed power of the unit.
- If the electrical socket and the plug on the equipment power cord are incompatible, call technical service or your local distributor.
- The power cord set included with the appliance meets the requirements for use in the country of purchase. Use the power cord that shipped with the appliance (*Nema 5-15*). If this appliance is to be used in another country, purchase an AC power cord set that is approved for use in that country



The power cord must be rated for the product and for the voltage and current marked on the product's electrical ratings label. The voltage and current rating of the cord should be greater than the voltage and current rating marked on the product.

- Do not use reductions or multi-way adapters (Fig.1)



It is important to connect the equipment correctly to an efficient earth system executed in compliance with the relevant legislation.

- The equipment must be positioned so that plug can be easily reached (Fig. 1)



Fig. 1

2.4 SET UP OPERATIONS

To avoid errors and accidents, perform a series of checks for possible damage sustained during transport, installation and hook-up operations before starting up the unit.

PRELIMINARY CHECKS

- Check the condition of the power cord (no cut or chaffing). Check that the door hinges and shelf support are stable.
- Check the door seals and shelves are not damaged (broken or scratched) and that the door closes and seals properly.
- Make sure all copper tubing, unions are in perfect condition.

FOR OPTIMAL PERFORMANCE

- Do not block the motor compartment air vents. Do not lay objects on the top of the equipment. Before storing products wait until they are cold.
- Arrange the products on suitable shelves or in containers. Do not place products directly on the base or against the walls, doors or fixed guards of the unit.
- Make sure doors are kept closed.
- Keep the defrost water drain outlet clear.
- Limit the frequency and duration of opening; each time the door is opened the internal temperature will alter.
- Load products at ambient temperature gradually to allow correct refrigeration. Perform routine maintenance regularly.

2.5 RE- INSTALLATION

Observe the following procedure:

- Switch off the equipment from the main switch.
- Disconnect the power cord from the electrical outlet.
- Handle the equipment in accordance with the instructions in Section 2.1.
- Follow the instructions in Section 2.2 for positioning and hook-ups in the new location.

2.6 STABILIZER BRACKET DETAILS



Warning: To offset any potential for unit tipping, the unit must not be used or loaded for use without being secured to the wall with the wall bracket included. To mount the unit to the bracket and wall, please procure the proper screw and anchor type suitable for the wall material being mounted to.

INSTALLATION INSTRUCTIONS:

Installation instructions are provided for Wood/Concrete/Masonry walls. Any other type of construction may require special installation techniques as deemed necessary to provide adequate fastening of the Anti-Tip bracket to the walls. For installation on walls other than wood/Concrete/Masonry walls, please contact technical support.

INSTALLATION

Step 1: Each Scientific model has a galvanized iron crossbar at the top rear side. This crossbar is shown in pic.1

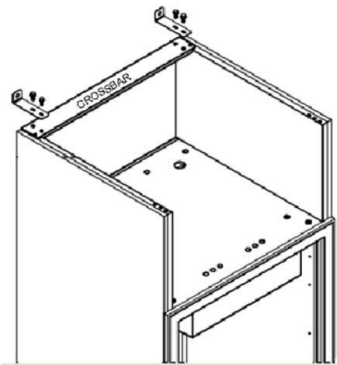

Pic 1 : Crossbar

Step 2: In pic.1 is shown the galvanized iron bracket that will be used to fix the cabinet at the building.



Pic 2 : Bracket

Step 3: This bracket must be linked to the crossbar by using two bolts as indicated. Provide 3 N-m torque for the bolts.

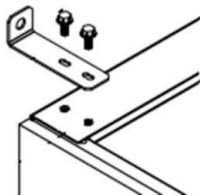

Pic.3 – Lag screw

Step 4: Mark the location of both holes on the wall

- wall
- b. Drill a hole in the base material (Masonary/Concrete wall or wooden wall) using a hammer drill and a carbide-tipped masonry bit of radius 3/8" to a depth equal to 1.5" or more.
- c. Clear the hole of all debris.
- d. Place the leadwood screw anchor into both of the holes and, with light hammer blows, tap the anchor until it is flush with the surface of the base material.

Step 5: Insert the lag screw through the bracket and into the anchor and tighten. Please provide appropriate torque for the screws.

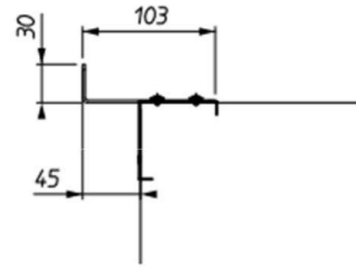

Pic 4 – Installation of bracket to the crossbar

2.7 SCRAPPING AND DISPOSAL

These units may contain materials, which at the end of the working life of the apparatus, must be disposed at one of the recycling centers nominated by your Local National Health Department or as specified by the law in force. Scrapping and disposal of the equipment must be carried out in full observance of established legislation in your country.

In particular, the apparatus may contain the following materials:

- Iron
- Copper
- Aluminium
- Non-biodegradable plastics
- Fibre glass for printed circuits
- Ferrite
- Batteries
- CFC-free refrigeration gas
- Electrical and electronic equipment (WEEE)

The manufacturer shall not be chargeable for any disposal of the apparatus at the end of its working life.



In line with EU Directive 2002/96/EC for waste electrical and electronic equipment (WEEE), this electrical product must not be disposed of as unsorted municipal waste. Please dispose of this product by returning it to your local municipal collection point for recycling.

2.8 REMOTE ALARM CONNECTION

These units are equipped with a remote alarm plug for the connection to a remote alarm network. The remote alarm plug is installed at the back of the cabinet near the main power plug enclosure and it is wired through a connection cable to the controller board.

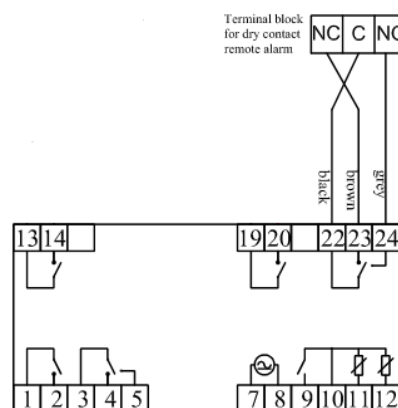

The Remote alarm contact is a Dry contact (low voltage: max 24VAc/VDc, 1A, SELV) and consist of three outputs: **C** (Common)/**N.O.** (Normally Opened Circuit) / **N.C.** (Normally Closed Circuit).

For the external network connection, fasten directly the pins according with the remote alarm network configuration. When an alarm occurs the contact relay switches from the N.C. position to N.O.

3. OPERATION

Before switching ON the unit, check that the electrical connections have been made correctly and above all, that the ground connection is available and working properly.

Please read before using this manual

- This manual is part of the product and should be kept near the instrument for easy and quick reference.
- Digital controller with defrost and fans management shall not be used for purpose different from those described hereunder. It cannot be used as a safety device.
- Check the application limits before proceeding.

Safety precautions

- Check the supply voltage is correct before connecting the instrument.
- Do not expose to water or moisture: use the controller only within the operating limits avoiding the temperature changes with high atmospheric humidity to prevent formation of condensation.



Warning

- Disconnect all the electrical connections before any kind of maintenance.
- In case of failure or faulty operation contact technical service or Dealer.
- Consider the maximum current which can be applied to each relay.
- Ensure that the wired for probes, loads and the power supply are separated and far enough from each other, without crossing or intertwining.

3.1 CONTROLLER GENERAL DESCRIPTION

The controller is a microprocessor based controller suitable for normal and low temperature air-ventilated application.

It has dimensions 75 x 33 x 73 mm, snap-in bracket to be fitted on the panel, four electro-mechanical relays to control the compressor, defrost hot gas valve, evaporator fan and an auxiliary relay used as a dry contact.

The controller is also provided with 2 probe inputs either NTC or PTC type: the probe “**Pb1**” defined as “*Control probe*” and used for the compressor activation, the “**Pb2**” defined as “*Evaporator probe*” and used to control the evaporator fan operation and the defrost cycle; The device has also an additional input configurable as analogue input (“*Auxiliary probe*” **Pb3**) or digital input (“*Door switch/multi-function input*”)

Technical Data

Case: Black color, self-extinguishing.

Heat and fire resistance category: D.

Case protection degree: IP65

Connections: Fixed screws terminal blocks for wires up to 2,5 mm²; removable screw terminal blocks for wires up to 2,5 mm² (by request); Micro-MaTch connectors.

Maximum length allowed to the connection cables: 10 meters (32,8ft) for power supply cord; 10 meters (32,8ft) for Analogue inputs; 10 meters (32,8ft) for Digital inputs; 10 meters (32,8ft) for Digital outputs.

Operating temperature: from 0°C to 55°C (from 32 to 131°F)

Operating humidity: Relative humidity without condensate from 10 to 90%.

Pollution status of the device: 2.

Power supply: 12-24 VAC/DC (+10% -15%) 50/60Hz (± 3 Hz) max 5VA/3W

Over voltage category: II.

Analogue input: 2 for NTC/PTC nodes (Cabinet probe and Evaporator probe)

Sensor range:

-PTC: from -50°C to 150°C (from -58 to 302°F)

-NTC: from -40°C to 105°C (from -40 to 221°F)

Sensitivity: 0,1°C (1°F)

Digital inputs: 1 (microport) for NO/NC contac (dry contact: 5VDC, 1,5mA)

Digital outputs: 4 electro-mechanical relays

Compressor relay: 16A res. @250VCA (NO contact)

Defrost relay: 8A res @250VCA (exchange contacts)

Evaporator fan relay: 5A res @250VCA (NO contact)

Auxiliary relay: 16A res @250VCA (Exchange contact)

Alarm buzzer: Incorporated.

The maximum current applicable to the loads is 24A.

Incorporated ports: Bluetooth Low Energy (by request)

Communication port: 1 TTL MODBUS slave port for EVconnect APP or BMS (by request)

3.2 REGULATION

Once set a desired temperature required for the products storage within the operational range of each models, the regulation of the cooling system is controlled by the temperature measured by the control probe with a positive differential from the set point: when the temperature rises up to the set point plus differential the compressor starts to pull down the temperature and it turns off when the desired set point is reached again.

In case of faulty probe the compressor activation is timed through the parameter "C4" and "C5"

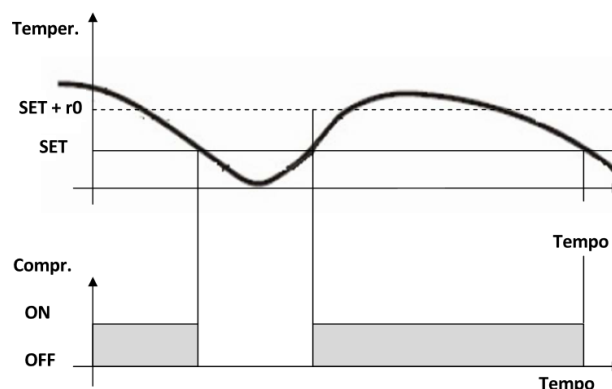



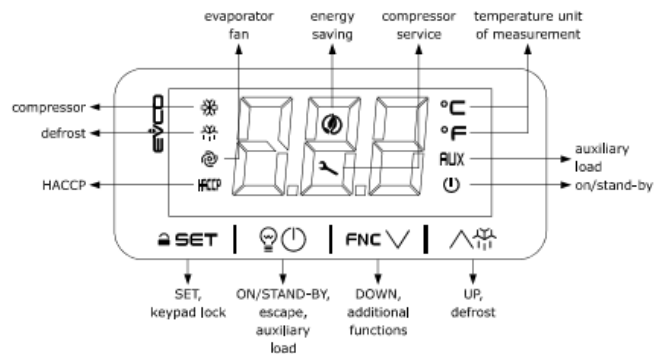

3.3 CONTROLLER USER INTERFACE AND MAIN FUNCTION



3.3.1 Switching the device ON/OFF

If the parameter POF=1, touch the ON/STAND-BY key  and hold it for 4 sec. Once the device is switched on the display will show temperature value according with the parameter P5 (Auxiliary probe from the factory).

3.3.2 Use of LEDs

LED	MODE	MEANING
	-ON -OFF -Blinking	-Compressor ON -Compressor OFF -Compressor protection activated/set point temperature menu
	-ON -OFF -Blinking	- Active Defrost/ pre-dripping cycle -No action. -Defrost delay time/active dripping cycle
	-ON -OFF -Blinking	-Evaporator fan ON -Evaporator fan OFF -Evaporator fan stop
HACCP	-ON -OFF -Blinking	-HACCP alarm recorded in EVlink module -no action -no action
	-ON -OFF -Blinking	-Active Energy saving mode -no action -no action
	-ON -OFF -Blinking	-request of compressor's servicing -no action -active settings mode/ active access to additional functions/ active connection with EVlink module
°C/°F	-ON -OFF -Blinking	-Normal temperature view -no action -Active overheating/overcooling cycle
AUX	-ON -OFF -Blinking	-Auxiliary load ON -Auxiliary load OFF -Auxiliary Load activated by digital input / Auxiliary Load activation delay

	-ON -OFF -Blinking	-Device OFF -Device ON -Device ON/OFF mode
---	--------------------------	--

3.3.3 Keypad unlocking

If the parameter **Loc=1** (default) after 30 sec without any keys of the display has been pressed, the display will show the label “**Loc**” and the keypad will lock automatically.

To unlock the keypad, touch the SET key  for 1 sec: the display will show the label “**UnL**”.

3.3.4 Operational temperature settings

If the keypad is locked, firstly unlock it.

Touch the SET key  then set the desired temperature by pressing the   or .

Up or DOWN key within 15s according with the limits range of the set point (parameters **r1** and **r2**).

Press  to confirm or do not operate for 15 sec.

3.3.5 Manual defrost

Firstly, check the keypad is not locked (and in case unlock it) and the overcooling cycle is not activated.

Press the UP key  holding it for 2 sec. If the parameter **P3=1** and the evaporator temperature value is lower than the parameter **d2**, the defrost cycle will start.



3.3.6 Cabinet light ON/OFF (if the parameter u1=0)

Touch the ON/STAND-BY key. 

3.3.7 Buzzer

If the parameters **u1=3** and **u4=1** touch any key to shut down the buzzer alarm.



3.3.8 Overcooling/overheating cycle activation and Manual energy saving

Check the keypad is unlock then press DOWN key  .

- If the parameter **r5=0**, **r8=1** and the defrost cycle is not activated the **Overcooling cycle** will start: the cooling unit runs a cycle with a set point of **r6** parameter for the time **r7**.
- If the parameter **r5=1** and **r8=1** the unit will perform an **Overheating cycle** having a operational temperature of “setpoint+**r6**” for a time fo **r7**.
- If the parameter **r5=0** and **r8=2** the device goes in “**Energy saving mode**”: the operation temperature becomes “setpoint+**r4**” with a duration of maximum the parameter **HE2**.

3.3.9 Displaying/reset the compressor operational time



Check the keypad is unlocked then press the   DOWN key for 4 sec.

Scroll through the menu’s labels by the UP or DOWN key   or  :

- **CH** label: displaying compressor operating hours.

- **rCH** label: compressor operating hours reset.
- **nS1** label: compressor star-up time.

To access the label press SET |  |.

In order to reset the compressor operating hours once selected the **rCH** label, insert the password “149” using the UP or DOWN keys  then confirm touching the SET key |  |.

Touch the ON/STAND-BY |  | key to exit the procedure or do not operate for 60 sec.

3.3.10 Displaying temperature probes

Ensure the keypad is unlocked then press the DOWN key |  | for 4 sec.

Scroll through the menu's labels by the Up or DOWN key  :

- **Pb1**: cabinet temperature probe (if parameter **P4=0,1 or 2**); inlet air temperature probe (if parameter **P4=3**).
- **Pb2**: Evaporator temperature probe (if parameter **P3=1 or 2**)
- **Pb3**: Auxiliary temperature probe (If **P4=1, 2 or 3**).

To access the label press SET |  |.

Touch the ON/STAND-BY |  | key to exit the procedure or do not operate for 60 sec.

3.3.11 Setting operational parameters

Touch the SET key |  | for 4 sec, the monitor will display the label “PA”.

Press SET key |  | and insert the password “-19”

Press SET key to confirm.

Scroll through the parameters list using the UP or DOWN key  .

For modifying a parameter value, press SET key at the parameter label then adjust the value by the UP or DOWN key.



Press SET key to confirm the changing.

Press SET key |  | for 4 sec or do not operate for 60 sec to exit the procedure.

3.3.12 Setting data and time

At the first start the controller monitor will blink the label “rtc” requiring data and time to be set.

Ensure the keypad is unlocked then press the DOWN key |  | for 4 sec.

Scroll through the menu's labels by the UP or DOWN key  up to the “rtc” label then press SET key |  | : the monitor will display “yy” followed by the two last digits of the year. Set the year using the UP or DOWN key then press SET key |  | to confirm.

Repeat the operation for the following labels:

- **n**: month (01 to 12)
- **d**: day (01 to 31)
- **h**: time (00 to 23)
- **n**: minutes (00 to 59)

Once set the minutes press SET key then the monitor will display the label referring to the day of the week (**Mon, Tue, Wed, Thu, Fri, Sat, Sun**). Select the correct day by pressing the UP or DOWN key. In conclusion touch SET to confirm, the device will exit the procedure automatically.

3.3.13 Alarms

Alarm code	Code description	Solution
Pr1	Cabinet probe alarm	-Check the parameter P0. -Check the status of the probe. -Check the electrical connection. -Replace the probe.
Pr2	Evaporator probe alarm	
Pr3	Auxiliary probe alarm	
rtc	Date and time alarm	Set date, time and day of the week.
AL	Low Temperature Alarm	Check the parameters AA, A1 and A2
AH	High Temperature Alarm	Check the parameter AA, A4 and A5
id	Door open alarm	Check the parameter i0 and i1
PF	Power failure alarm	-Check electrical connection -Touch any key to shut the buzzer off
COH	High condenser warning	-Check if the condenser probe is installed. -Check the parameter C6 -Check the condenser coil is clean.
CSd	High condensation alarm	Check if the condenser probe is installed. -Check the parameter C7 . -Check the condenser coil is clean. -Reboot the device.
iA	Multi-function input alarm	-Check the parameters i5 and i6
Cth	Compressor thermal switch alarm	-Check the parameters i5 and i6
th	Global thermal switch alarm	-Check the parameters i5 and i6 -Reboot the device
dFd	Defrost time out alarm	-Check the parameters d2, d3 and d11

3.3.14 Electrical connection

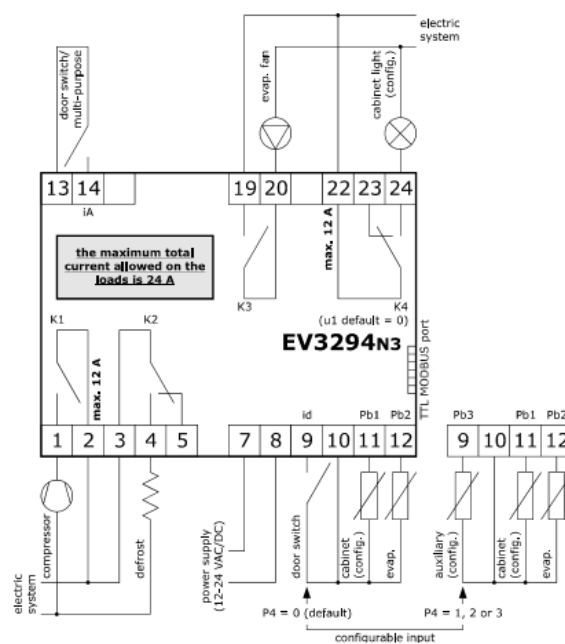

3.3.15 Default parameters value and description

N.	PAR.	DEF.	SETPOINT	MIN... MAX.
1	SP	0.0	setpoint	r1... r2
ANALOGUE INPUTS				
2	CA1	0.0	cabinet probe offset	-25... 25 °C/°F if P4 = 3, air in probe offset
3	CA2	0.0	evaporator probe offset	-25... 25 °C/°F
4	CA3	0.0	auxiliary probe offset	-25... 25 °C/°F
5	P0	1	probe type	0 = PTC 1 = NTC
6	P1	1	enable °C decimal point	0 = no 1 = yes
7	P2	0	temperature unit of measurement	0 = °C 1 = °F
8	P3	1	evaporator probe function	0 = disabled 1 = defrost + fan 2 = fan
9	P4	0	configurable input function	0 = digital input 1 = condenser probe 2 = critical temperature probe 3 = air out probe if P4 = 3, regulation temperature = product temperature (CPT)
10	P5	0	value displayed	0 = regulation temperature 1 = setpoint 2 = evaporator temperature 3 = auxiliary temperature 4 = air in temperature
11	P7	5	air in weight for calculated product temperature (CPT)	0... 10 % x 10 CPT = $\{[(P7 \times (\text{air in})) + ((100 - P7) \times (\text{air out})) : 100]\}$
12	P8	5	display refresh time	0... 250 s : 10
REGULATION				
13	r0	2.0	setpoint differential	1... 15 °C/°F
14	r1	-50	minimum setpoint	-99 °C/°F... r2
15	r2	50.0	maximum setpoint	r1... 199 °C/°F
16	r4	0.0	setpoint offset in energy saving	0... 99 °C/°F
17	r5	0	cooling or heating operation	0 = cooling 1 = heating
18	r6	0.0	setpoint offset in overcooling/overheating	0... 99 °C/°F
19	r7	30	overcooling/overheating duration	0... 240 min
20	r8	0	DOWN key additional function	0 = disabled 1 = overcooling/overheating 2 = energy saving
21	r12	0	position of the r0 differential	0 = asymmetric 1 = symmetric

N.	PAR.	DEF.	COMPRESSOR	MIN... MAX.
22	C0	0	compressor on delay after power-on	0... 240 min
23	C2	3	compressor off minimum time	0... 240 min
24	C3	0	compressor on minimum time	0... 240 s
25	C4	10	compressor off time during cabinet probe alarm	0... 240 min
26	C5	10	compressor on time during cabinet probe alarm	0... 240 min
27	C6	80.0	threshold for high condensation warning	0... 199 °C/°F differential = 2 °C/4 °F
28	C7	90.0	threshold for high condensation alarm	0... 199 °C/°F
29	C8	1	high condensation alarm delay	0... 15 min
30	C10	0	compressor hours for service	0... 999 h x 100 0 = disabled
31	C11	0	second compressor switch-on delay (not available in EV3... N3)	0... 240 s
32	C13	0	number of start-ups for compressor rotation (not available in EV3... N3)	0... 10 0 = disabled
N.	PAR.	DEF.	DEFROST (if r5 = 0)	MIN... MAX.
33	d0	8	automatic defrost interval	0... 99 h 0 = only manual if d8 = 3, maximum interval
34	d1	0	defrost type	0 = electric 1 = hot gas 2 = compressor stopped
35	d2	8.0	threshold for defrost end	-99... 99 °C/°F
36	d3	30	defrost duration	0... 99 min se P3 = 1, maximum duration
37	d4	0	enable defrost at power-on	0 = no 1 = yes
38	d5	0	defrost delay after power-on	0... 99 min
39	d6	2	value displayed during defrost	0 = regulation temperature 1 = display locked 2 = dEF label
40	d7	2	dripping time	0... 15 min
41	d8	0	defrost interval counting mode	0 = device on hours 1 = compressor on hours 2 = hours evaporator temperature < d9 3 = adaptive 4 = real time
42	d9	0.0	evaporation threshold for automatic defrost interval counting	-99... 99 °C/°F
43	d11	0	enable defrost timeout alarm	0 = no 1 = yes
44	d15	0	compressor on consecutive time for hot gas defrost	0... 99 min
45	d16	0	pre-dripping time for hot gas defrost	0... 99 min

46	d18	40	adaptive defrost interval	0... 999 min if compressor on + evaporator temperature < d22 0 = only manual
47	d19	3.0	threshold for adaptive defrost (relative to optimal evaporation temperature)	0... 40 °C/°F optimal evaporation temperature - d19
48	d20	180	compressor on consecutive time for defrost	0... 999 min 0 = disabled
49	d21	200	compressor on consecutive time for defrost after power-on and overcooling	0... 500 min if (regulation temperature - setpoint) > 10°C/20 °F 0 = disabled
50	d22	-2.0	evaporation threshold for adaptive defrost interval counting (relative to optimal evaporation temperature)	-10... 10 °C/°F optimal evaporation temperature + d22
N.	PAR.	DEF.	ALARMS	MIN... MAX.
51	AA	0	select value for high/low temperature alarms	0 = regulation temperature 1 = evaporator temperature 2 = auxiliary temperature
52	A1	-10.0	threshold for low temperature alarm	-99... 99 °C/°F
53	A2	2	low temperature alarm type	0 = disabled 1 = relative to setpoint 2 = absolute
54	A4	10.0	threshold for high temperature alarm	-99... 99 °C/°F
55	A5	2	high temperature alarm type	0 = disabled 1 = relative to setpoint 2 = absolute
56	A6	12	high temperature alarm delay after power-on	0... 99 min x 10
57	A7	15	high/low temperature alarms delay	0... 240 min
58	A8	15	high temperature alarm delay after defrost	0... 240 min
59	A9	15	high temperature alarm delay after door closing	0... 240 min
60	A10	10	power failure duration for alarm recording	0... 240 min
61	A11	2.0	high/low temperature alarms reset differential	1... 15 °C/°F
N.	PAR.	DEF.	FANS	MIN... MAX.
62	F0	1	evaporator fan mode during normal operation	0 = off 1 = on 2 = according to F15 and F16 if compressor off, on if compressor on 3 = thermoregulated (with F1) 4 = thermoregulated (with F1) if compressor on











63	F1	-4.0	threshold for evaporator fan operation	-99... 99 °C/°F differential = 1 °C/2 °F
64	F2	0	evaporator fan mode during defrost and dripping	0 = off 1 = on 2 = according to F0
65	F3	2	evaporator fan off maximum time	0... 15 min
66	F4	0	evaporator fan off time during energy saving	0... 240 s x 10
67	F5	10	evaporator fan on time during energy saving	0... 240 s x 10
68	F7	5.0	threshold for evaporator fan on after dripping (relative to setpoint)	-99... 99 °C/°F setpoint + F7
69	F9	0	evaporator fan off delay after compressor off	0... 240 s if F0 = 2
70	F11	15.0	threshold for condenser fan on	0... 99 °C/°F differential = 2 °C/4 °F
71	F12	30	condenser fan off delay after compressor off	0... 240 s if P4 ≠ 1
72	F15	0	evaporator fan off time with compressor off	0... 240 s if F0 = 2
73	F16	1	evaporator fan on time with compressor off	0... 240 s if F0 = 2

N.	PAR.	DEF.	DIGITAL INPUTS	MIN... MAX.
74	i0	5	door switch input function	0 = disabled 1 = compressor + evaporator fan off 2 = evaporator fan off 3 = cabinet light on 4 = compressor + evaporator fan off, cabinet light on 5 = evaporator fan off + cabinet light on
75	i1	0	door switch input activation	0 = with contact closed 1 = with contact open
76	i2	30	open door alarm delay	-1... 120 min -1 = disabled
77	i3	15	regulation inhibition maximum time with door open	-1... 120 min -1 = until the closing
78	i5	2	door switch/multi-purpose input function (options 7 and 8 not available in EV3... N9)	0 = disabled 1 = energy saving 2 = iA alarm 3 = button-operated load on 4 = device on/off 5 = Cth alarm 6 = th alarm 7 = compressor + evaporator fan off, cabinet light on 8 = evaporator fan off + cabinet light on



	79	i6	0	door switch/multi-purpose input	0 = with contact closed
	99	H09	0	Friday energy saving time	0... 23 h
	100	H10	0	Friday energy saving maximum duration	0... 24 h
	101	H11	0	Saturday energy saving time	0... 23 h
	102	H12	0	Saturday energy saving maximum duration	0... 24 h
	103	H13	0	Sunday energy saving time	0... 23 h
	104	H14	0	Sunday energy saving maximum duration	0... 24 h
	N.	PAR.	DEF.	REAL TIME DEFROST (if d8 = 4)	MIN... MAX.
	105	Hd1	h-	1st daily defrost time	h- = disabled
	106	Hd2	h-	2nd daily defrost time	h- = disabled
	107	Hd3	h-	3rd daily defrost time	h- = disabled
	108	Hd4	h-	4th daily defrost time	h- = disabled
	109	Hd5	h-	5th daily defrost time	h- = disabled
	110	Hd6	h-	6th daily defrost time	h- = disabled
	N.	PAR.	DEF.	SAFETIES	MIN... MAX.
	111	POF	1	enable ON/STAND-BY key	0 = no 1 = yes
	112	PAS	-19	password	-99... 999
	113	PA1	426	level 1 password	-99... 999
	114	PA2	824	level 2 password	-99... 999
	N.	PAR.	DEF.	REAL TIME CLOCK	MIN... MAX.
	115	Hr0	1	enable clock	0 = no 1 = yes
	N.	PAR.	DEF.	DATA-LOGGING EVLINK	MIN... MAX.
	116	bLE	1	enable Bluetooth	0 = no 1 = yes
	117	rE0	15	data-logger sampling interval	0... 240 min
	118	rE1	1	recorded temperature	0 = none 1 = cabinet 2 = evaporator 3 = auxilliary 4 = cabinet and evaporator 5 = all
	N.	PAR.	DEF.	MODBUS	MIN... MAX.
	119	LA	247	MODBUS address	1... 247
	120	Lb	2	MODBUS baud rate	0 = 2,400 baud 1 = 4,800 baud 2 = 9,600 baud 3 = 19,200 baud parity even
				duration	
	93	H03	0	Tuesday energy saving time	0... 23 h
	94	H04	0	Tuesday energy saving maximum duration	0... 24 h
	95	H05	0	Wednesday energy saving time	0... 23 h
	96	H06	0	Wednesday energy saving maximum duration	0... 24 h
	97	H07	0	Thursday energy saving time	0... 23 h
	98	H08	0	Thursday energy saving maximum duration	0... 24 h

4. MAINTENANCE AND REPAIR

Maintenance and repair must be carried out by qualified personnel authorized by the manufacturer.



The manufacturer declines any responsibility for jobs carried out by unauthorized personnel or the use of non-original spare parts.

4.1 ROUTINE MAINTENANCE



Prohibited to remove the guards and safety devices: It's strictly forbidden to remove guards or safety devices when performing routine maintenance operation. The manufacturer disclaims all liability that may arise this regulation is not observed.

In case of FIRE:

- Disconnect the unit from the electrical power socket.
- Do not use water to extinguish the fire.
- Use powder or foam extinguishers.

4.1.1 Cleaning the interior and exterior of the appliance

The appliance is designed for the laboratory product storage, so it is important to keep it clean. The equipment is thoroughly cleaned at the factory before being shipped. We recommend, however, to clean the interior cabinet before the first start up of the appliance. **Before attempt any cleaning operation make sure the power cord is disconnected.**

- Cleaning product: use soft clean cloth wet with water and neutral detergent only. **Do not use solvent or bleach.**
- Rinsing: use a cloth or sponge soaked with fresh clean water. **Do not use water jet.**
- Frequency: once a week or at different intervals in accordance with the type of product.

4.1.2 Condenser cleaning

The condenser is a heat exchanger. If it is dirty or clogged the air cannot circulate freely through the same, it cannot discharge heat properly so reducing proportionally the performance and the efficiency of the refrigeration system.

FOR THOSE REASONS IT IS IMPORTANT TO KEEP CLEAN THE CONDENSER COIL, TYPICALLY MONTHLY.



Always switch off the unit and disconnect power cord before cleaning, it is dangerous to do it with power ON: fan may start suddenly at any time.

Use a convenient ladder to reach the condenser. Use an air jet or vacuum with a soft dry brush if necessary and remove any dust or fluff from the heat exchanger fins.

After cleaning, start the equipment.



During the cleaning operation wear gloves and safety glasses to protect yourself from any injury

4.1.3 Sliding door's rails cleaning.

Keep clean the sliding door housing to avoid the door can't close completely. Use a soft clean cloth or a soft brush in order to remove any residuals can block the door to slide in the full closure position.



5. TROUBLESHOOTING

The Chart shows the most frequent break downs , possible causes and relative remedies:

PROBLEM DESCRIPTION	POSSIBLE CAUSE	SOLUTION
The appliance does not come on	The main switch is "off" There is no tension Other	Main switch "on" Check plug, socket, electric connection Contact technical assistance
The refrigerator unit does not start	Set temperature is reached Defrosting is in operation Control Panel is broken Other	Set new temperature Wait for end of cycle, switch off and switch back on Contact technical assistance Contact technical assistance
The refrigerator is continuously working but does not reach the set temperature	Room is too hot Condenser is dirty Refrigerant fluid is insufficient Condenser fan has stopped Door not properly closed Evaporator is frosted up Defrost valve is open	Air better Clean condenser Contact technical assistance Contact technical assistance Check door seals Manual defrosting Contact technical assistance
Refrigerator does not stop at set temperature	Control Panel is broken Temperature probe is broken Door is not airtight	Contact technical assistance Contact technical assistance Close door
Ice blocks on evaporator	Improper use Control Panel is broken	Contact technical assistance Contact technical assistance
Appliance is noisy	Appliance not levelled Contact with external bodies Screws or nuts loose Other	Check that appliance is level. Check that no tube or ventilator fan is in contact with external bodies. Tighten Contact technical assistance
Safety DC fan does not work	Fan disconnected Stuck fan Fan motor damaged	Re-wire the fan to the electrical strip contact Replace the fan Replace the fan

IN ORDER TO GUARANTEE THE EFFICIENCY OF THE APPLIANCE AND ITS CORRECT FUNCTIONING THE MANUFACTURER'S INSTRUCTIONS MUST BE FOLLOWED AND PERIODIC SERVICING MUST BE CARRIED OUT BY PROFESSIONALLY QUALIFIED PERSONNEL.

(LEGAL REQUIREMENT FOR THE PREVENTION OF ACCIDENTS AT WORK AND THE INSTALLATION OF ELECTRICAL APPLIANCES)

IT IS OBLIGATORY TO BE IN ACCORDANCE WITH POWER SUPPLY REGULATIONS

6. SPARE PARTS

SUPPLY OF ORIGINAL SPARE PARTS

For the substitution of any parts, spares can be obtained at manufacturer's authorised centres, on giving

- Serial number and year of manufacture (See picture of the data plate, pag.6);
- Component identification number (see Chapter 6).



Any malfunctioning due to non-original spare parts will not be recognised by our technicians.

The parts replacement must be carried out by personnel authorized by the manufacturer.

WARRANTY INFORMATION

WARRANTY POLICY

Yamato Scientific America warrants, from the date of shipment from warehouse in Cincinnati, Ohio, U.S.A., for a period of one (1) year. All products, parts and materials shall be free of defects in material and workmanship under normal use consistent with the product instructions. This product warranty does not apply to products purchased from unauthorized resellers/distributors.

Yamato reserves the right to inspect the product under claim before having an obligation to repair or replace the defective unit covered by this warranty. All costs of shipping to Yamato for inspection shall be borne solely by the purchaser. Products repaired or replaced under the terms of the warranty may be refurbished or new product will be provided at the discretion of Yamato.

Warranty Conditions

This warranty shall have force and effect only if all items are used with proper circuits, voltages, and frequencies and the operation thereof is in accordance with instructions furnished by the manufacturer.

This warranty shall not extend to such parts as refrigerants, finishes, belts, and dryers.

This warranty shall not extend to ordinary wear and tear, or ordinary refrigeration service and refrigeration adjustments, unless specifically included in the equipment purchase contract.

This warranty does not apply to equipment or parts which fail because of abuse, accident, alteration, misuse, erosion, improper installation, or improper replacement of a repaired item.

The buyer assumes all risks for results obtained from these products, whether used alone or in combination with other items. It is expressly understood that we are not responsible and will not be held liable for damage and/or injury caused using our products.

WARRANTY INFORMATION

WARRANTY POLICY CONTINUED

Product Return Policy

If you are not satisfied with your purchase and wish to make a return, contact our customer service to inquire about a Return of Merchandise Authorization Number (RMA). Merchandise returned without an RMA number will not be accepted and will be returned to the sender. Return requests must be made within 15 days of the customer's receipt of the merchandise.

All returns must be unused and in unopened original packaging and include all items and manuals originally shipped.

The purchaser is responsible for the shipping cost of return shipment. Insurance on the return shipment is required. Damage or loss of merchandise during shipping is the responsibility of the sender. Returned shipments that arrive damaged will be returned to the sender, and credit will not be rendered.

All returned products, parts and materials are subject to a 25% restocking fee. Shipping and handling cost are non-refundable. All retrofitted, customized and special order item sales are final and non-returnable.

In Case of Request for Repair

If the failure occurs, stop the operation, turn OFF the power switch, and unplug the power plug. Please contact the sales agency that this unit was purchased, or Yamato Scientific's sales office.

< Check following items before contact >

- ◆ Model Name of Product
- ◆ Serial Number
- ◆ Purchase Date
- ◆ Issue (as detailed as possible)

Responsibility

Please follow instructions in this document when using this unit. Yamato Scientific has no responsibility for accidents or breakdown of device due to failure to comply. Never conduct what this document forbids as unexpected accidents or breakdown may result.

Yamato Scientific America Inc.
925 Walsh Ave, Santa Clara, CA 95050
Tel: 1-800-292-6286 / 408-235-7725
<http://www.yamato-usa.com>

For customer service:
Email: customerservice@yamato-usa.com
For technical support:
Email: technical@yamato-usa.com