



**Water Bath
BM302-A/312-A
Oil Bath
BO302-A/312-A**

Instruction Manual

First Edition

- Thank you for choosing BM/BO series Baths from Yamato Scientific Co., Ltd.
- For proper equipment operation, please read and become thoroughly familiar with this instruction manual before use. Always keep equipment documentation safe and close at hand for convenient future reference.

 **Warning:** Read instruction manual warnings and cautions carefully and completely before proceeding.

Yamato Scientific Co., Ltd.

Printed on recycled paper

1. SAFETY PRECAUTIONS	1
Explanation of Symbols	1
Symbol Glossary	2
Warnings and Cautions.....	3
Residual Risk Map	5
List of Residual Risks.....	6
2. COMPONENT NAMES AND FUNCTIONS	8
Main Unit.....	8
Control Panel	10
Display Characters.....	10
3. PRE-OPERATION PROCEDURES	11
Installation Precautions	11
4. OPERATION PROCEDURES	16
Operation Procedure.....	16
User Setting	17
Calibration Offset	18
Auto-resume Function.....	19
Overshoot Alert.....	20
LED Brightness Setting	21
Independent Overheat Prevention Device Reset.....	22
5. HANDLING PRECAUTIONS	23
Warnings and Cautions.....	23
6. MAINTENANCE PROCEDURES	25
Precautions in Daily Maintenance.....	25
Maintenance and Inspection	25
7. EXTENDED STORAGE AND DISPOSAL	27
Extended Storage/Disposal	27
Disposal Considerations	27
8. TROUBLESHOOTING.....	28
Reading Error Codes	28
Troubleshooting Guide.....	29

9. SERVICE & REPAIR	30
Requests for Repair	30
10. SPECIFICATIONS	31
BM302-A/BO302-A	31
Temperature Rise Curve (reference data)	31
BM312-A/BO312-A	32
Temperature Rise Curve (reference data)	32
11. WIRING DIAGRAM	33
BM302-A/BO302-A	33
BM312-A/BO312-A	34
12. REPLACEMENT PARTS LIST	35
BM302-A/BO302-A	35
BM312-A/BO312-A	35
13. LIST OF HAZARDOUS SUBSTANCES	36
14. STANDARD INSTALLATION MANUAL	37

1. SAFETY PRECAUTIONS

Explanation of Symbols

A Word Regarding Symbols

Various symbols are provided throughout this text and on equipment to ensure safe operation. Failure to comprehend the operational hazards and risks associated with these symbols may lead to adverse results as explained below. Become thoroughly familiar with all symbols and their meanings by carefully reading the following text regarding symbols before proceeding

 **Warning** Signifies a situation which may result in serious injury or death (Note 1.)

 **Caution** Signifies a situation which may result in minor injury (Note 2) and/or property damage (Note 3.)

(Note 1) Serious injury is defined as bodily wounds, electrocution, bone breaks/fractures or poisoning, which may cause debilitation requiring extended hospitalization and/or outpatient treatment.

(Note 2) Minor injury is defined as bodily wounds or electrocution, which will not require extended hospitalization or outpatient treatment.

(Note 3) Property damage is defined as damage to facilities, equipment, buildings or other property.

Symbol Meanings

 Signifies warning or caution.
Specific explanation will follow symbol.

 Signifies restriction.
Specific restrictions will follow symbol.

 Signifies an action or actions which operator must undertake.
Specific instructions will follow symbol.

1. SAFETY PRECAUTIONS

Symbol Glossary

WARNING / CAUTION



General

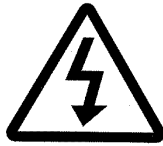

Danger!
High Voltage



Danger!
Extremely Hot



Danger!
Moving Parts



Danger!
Blast Hazard



Caution:
Water Only



Caution:
Shock Hazard!



Caution:
Burn Hazard!



Caution:
Do Not Heat
Without Water!



Caution:
May Leak Water!



Caution:
Toxic Chemicals

RESTRICTION



General
Restriction



No Open Flame



Do Not
Disassemble



Do Not Touch

ACTION



General Action
Required



Connect Ground
Wire



Level Installation

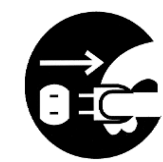

Disconnect Power



Inspect
Regularly

1. SAFETY PRECAUTIONS

Warnings and Cautions



Install in a location free of flammables and explosives.



Never install or operate unit in a flammable or explosive gas atmosphere. Unit is NOT fire or blast resistant. Simply switching the Power switch "ON (I)" or "OFF (o)" can produce a spark, which can then be relayed during operation, causing fire or explosion when near flammable or explosive fluids, chemicals or gases/fumes.

See "13. LIST OF HAZARDOUS SUBSTANCES" (P. 36) for information on flammable and explosive gases.



Implement proper fire extinguishing and ventilation measures.



【BO302-A/312-A】

The oily smoke and steam generated from heating silicon oil is flammable and may cause a fire hazard. Silicon oil also emits harmful gas when heated to high temperatures.

A ventilation hood must be installed above unit, with a fire extinguisher in close proximity.



Ground wire MUST be connected properly.



- Connect power cable to a grounded outlet in order to avoid electric shock.
- Never connect ground wire to gas lines or water pipes. Fire, accident or equipment malfunction may result.
- Never connect ground wire to telephone grounding lines or to lightning conductor rods. Fire or electric shock may result.
- Never insert multiple plugs into a single outlet. Doing so may result in power cable overheating, fire or drop in voltage.



Turn OFF (o) the Power switch immediately when an abnormality occurs.



If unit begins emitting smoke or abnormal odors for reasons unknown, turn OFF (o) the Power switch immediately, disconnect power cable from power supply, and contact original dealer of purchase for assistance. Continuing to operate without addressing abnormalities may cause fire or electric shock, resulting in serious injury or death. Never attempt to disassemble or repair unit. Repairs should always be performed by a certified technician.

1. SAFETY PRECAUTIONS

Warnings and Cautions



Handle power cable with care.



- Do not operate equipment with power cable bundled or tangled. Operating unit with power cable bundled or otherwise tangled, may cause power cable to overheat and catch fire.
- Do not modify, bend, forcibly twist or pull on power cable. Fire or electric shock may result.
- Do not risk damage to power cable by positioning it under desks or chairs, or by allowing it to be pinched in between objects. Fire or electric shock may result.
- Do not place power cable near kerosene/electric heaters or other heat-generating devices. Doing so may cause power cable insulation to overheat, melt and/or catch fire, which may result in electric shock.
- Turn off the Power switch immediately and disconnect from facility terminal or outlet, if power cable becomes partially severed or damaged in any way. Contact original dealer of purchase for information about replacing power cable. Failure to do so may result in fire or electric shock.
- Always connect power cable to appropriate facility outlet or terminal.



DO NOT disassemble or modify equipment.

Never attempt to disassemble or modify unit. Doing so may cause malfunction, fire, electric shock, or personal injury. Note that any malfunction resulting from unauthorized modifications or customizations to unit will void the warranty.



DO NOT touch hot surfaces.

Do not touch the reservoir around brim during operation or immediately after operation. Burn injury may result.



CAUTION



DO NOT operate equipment during thunderstorms.

In the event of a thunderstorm, turn OFF (○) the Power switch and disconnect power cable immediately. A direct lightning strike may cause equipment damage, fire or electric shock, resulting in serious injury or death.



Turn OFF (○) the Power switch in case of power failure.

Operation stops when power failures occur. For added safety however, turn OFF (○) the Power switch in the event of a power failure.

1. SAFETY PRECAUTIONS

Residual Risk Map

These figures indicate positions of caution labels.

The numbers shown in the figure indicate the numbers listed in the "List of Residual Risks" in this manual.

For details of individual residual risks, see the List of Residual Risks.

【BM302-A/BO302-A】

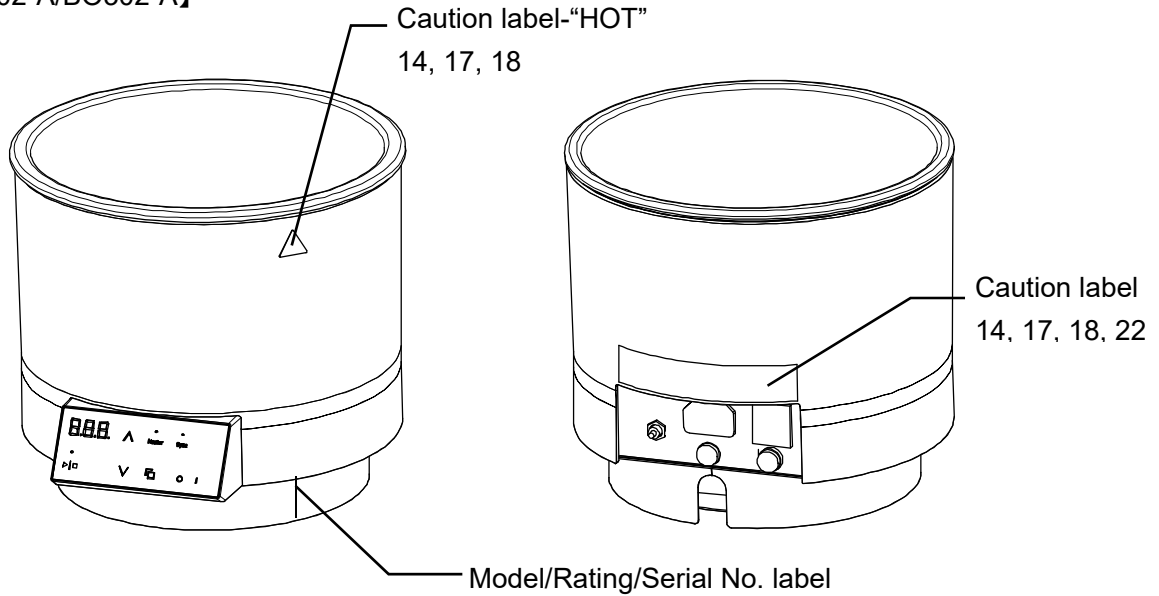

【BM312-A/BO312-A】

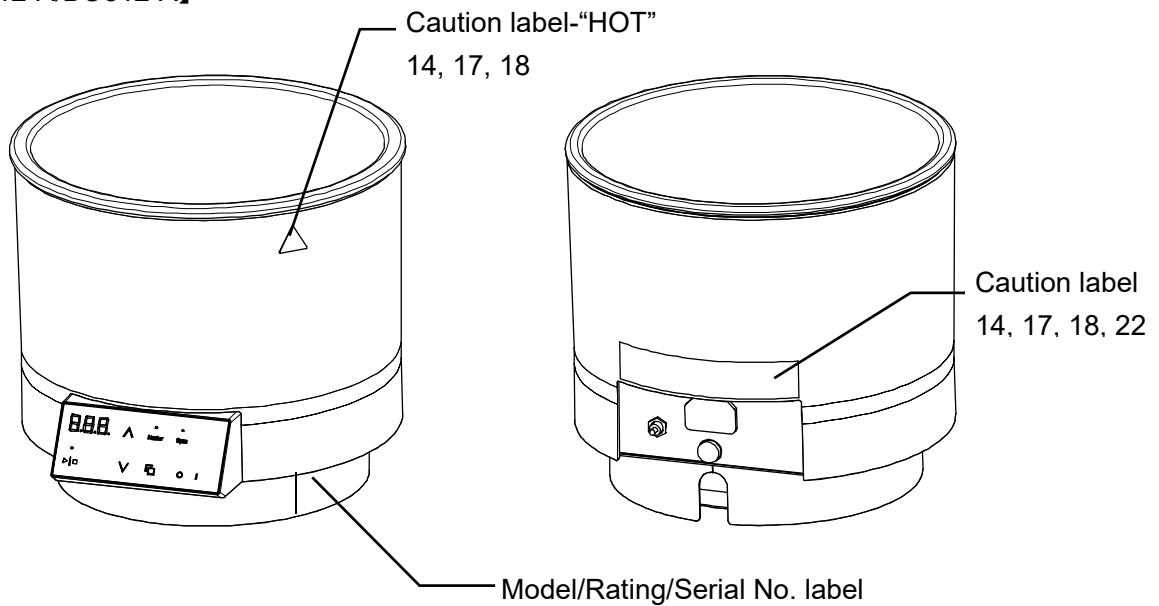

***Contact us if the caution signs are no more visible because nameplate is peeled off or texts are eliminated. We will send you a new nameplate. (for charge)**

1. SAFETY PRECAUTIONS

List of Residual Risks

List of residual risks (instructions for risk avoidance)

This list summarizes residual risks to avoid personal injuries or damages to properties during or related to the use of equipment.

Be sure to fully understand or receive instructions on how to use, maintain and inspect equipment before starting operation.

Loading/Installation				
No.	Degree of risks	Risk description	Protective measures taken by the user	Relevant page(s)
1	WARNING	Fire/ Electric shock	Choose an appropriate installation site.	P.11
2	CAUTION	Injury	Install unit on a level surface.	P.11
3	CAUTION	Electric shock	Make power connection properly.	P.12
4	WARNING	Fire/Electric shock	Always connect power cable to appropriate facility outlet or terminal.	P.12
5	WARNING	Fire/Electric shock	Install in a dry location.	P.13
6	WARNING	Injury	Use unit in fume hood whenever processing harmful solvents.	P.13
7	WARNING	Explosion/fire	Install in a location free of flammables and explosives.	P.3
8	WARNING	Fire/ Electric shock	Handle power cable with care.	P.4
9	WARNING	Fire/ Electric shock	Ground wire MUST be connected properly	P.3
10	WARNING	Fire/ Electric shock	DO NOT disassemble or modify equipment.	P.4
11	WARNING	Fire/Injury	Implement proper fire extinguishing and ventilation measures. (BO302-A/312-A)	P.3

1. SAFETY PRECAUTIONS

List of Residual Risks

Use				
No.	Degree of risks	Risk description	Protective measures taken by the user	Relevant page(s)
11	WARNING	Explosion/fire	DO NOT process explosive or flammable substances	P.23
12	WARNING	Fire/ Electric shock	Turn OFF (○) the Power switch immediately when an abnormality occurs.	P.3
13	CAUTION	Fire	When unit stops operation due to power failure etc., be sure to confirm the state of unit at the time of power recovery.	P.4
14	WARNING	Burn	DO NOT touch hot surfaces	P.23
15	WARNING	Fire	Be acquainted with property of heating medium in use.	P.13
16	WARNING	Fire	DO NOT operate equipment during thunderstorms.	P.4
17	CAUTION	Burn Injury	ALWAYS run equipment within specified temperature range.	P.24
18	WARNING	Burn	Exercise caution in handling heating medium after operation.	P.23
19	WARNING	Fire/ Electric shock	Do not use silicone oil mixed with any moisture. (BO302-A/312-A)	P.23
20	WARNING	Electric shock	Air-dry unit completely after using water below room temperature.	P.14
21	WARNING	Fire	DO NOT insert foreign objects into unit openings.	P.23
22	WARNING	Fire	When unit is not in operation during the night or for extended period of time, be sure to turn OFF (○) the Power switch and disconnect power cable.	P.24

Daily inspection/maintenance				
No.	Degree of risks	Risk description	Protective measures taken by the user	Relevant page(s)
23	WARNING	Fire/ Electric shock	Remove the power cable for inspection and maintenance.	P.25
24	WARNING	Burn	Perform inspections and maintenance when unit is at room temperature.	P.25
25	WARNING	Fire/Electric shock	NEVER disassemble or modify unit	P.25

Extended storage/disposal				
No.	Degree of risks	Risk description	Protective measures taken by the user	Relevant page(s)
27	WARNING	Fire/ Electric shock	Turn off the Power switch and disconnect power cable from facility outlet or terminal.	P.27
28	CAUTION	Injury	Do not leave unit in a location where children may have access	P.27

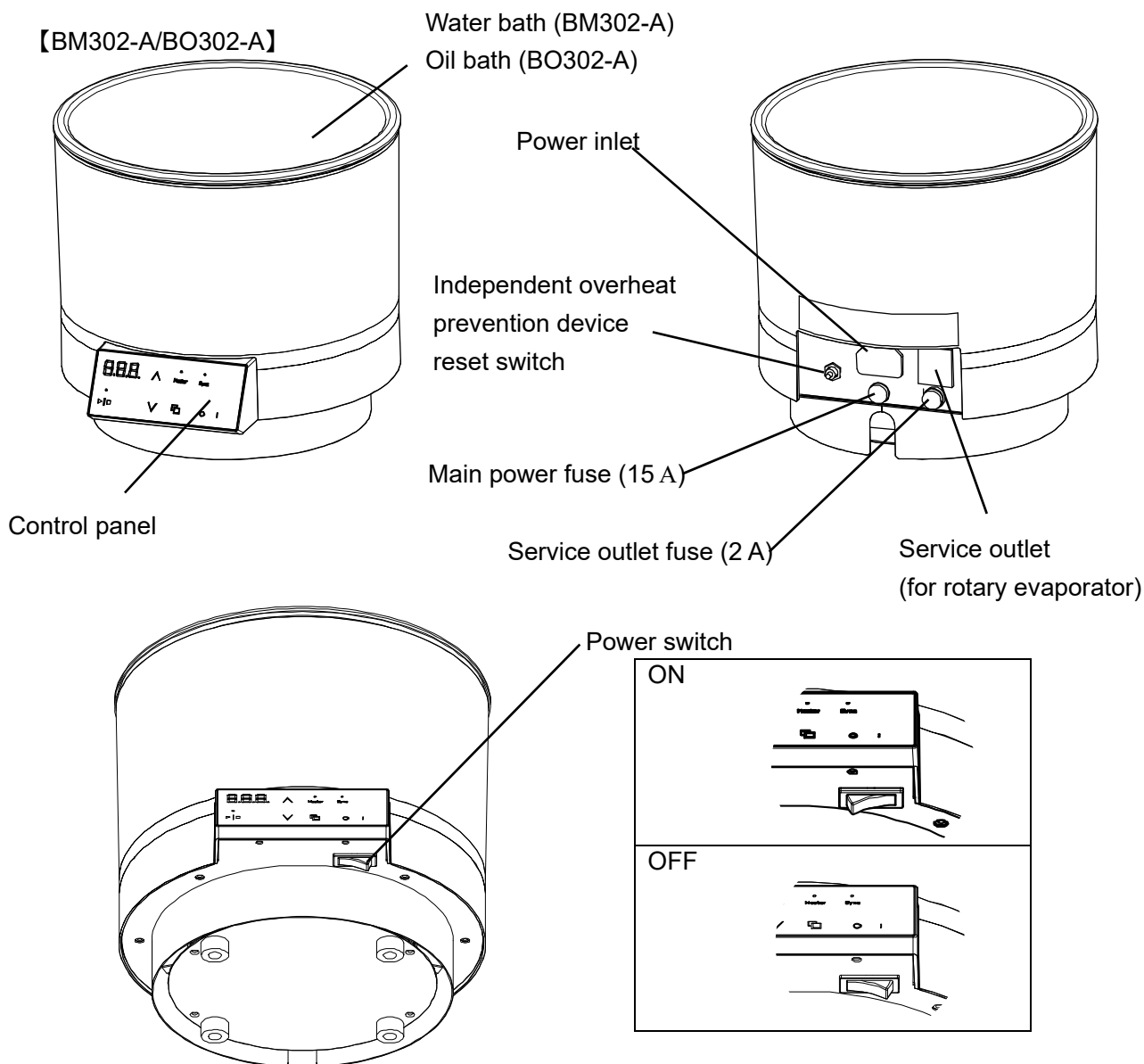

2. COMPONENT NAMES AND FUNCTIONS

Main Unit

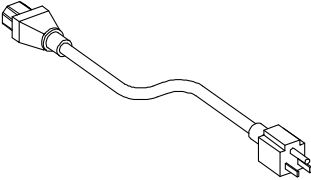
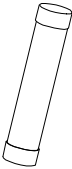

Accessories

Check before operation that all the accessories are complete. Contact original dealer of purchase if anything is missing.

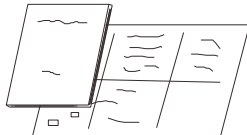
<p>(1) Power cable (3 m)</p> 	<p>(2) Spear fuse for main power 15 A (large)</p> 	<p>(3) Spear fuse for service outlet 2 A (small)</p> 	<p>(4) Instruction manual (5) Warranty card</p> 
--	---	--	---

2. COMPONENT NAMES AND FUNCTIONS

Main Unit

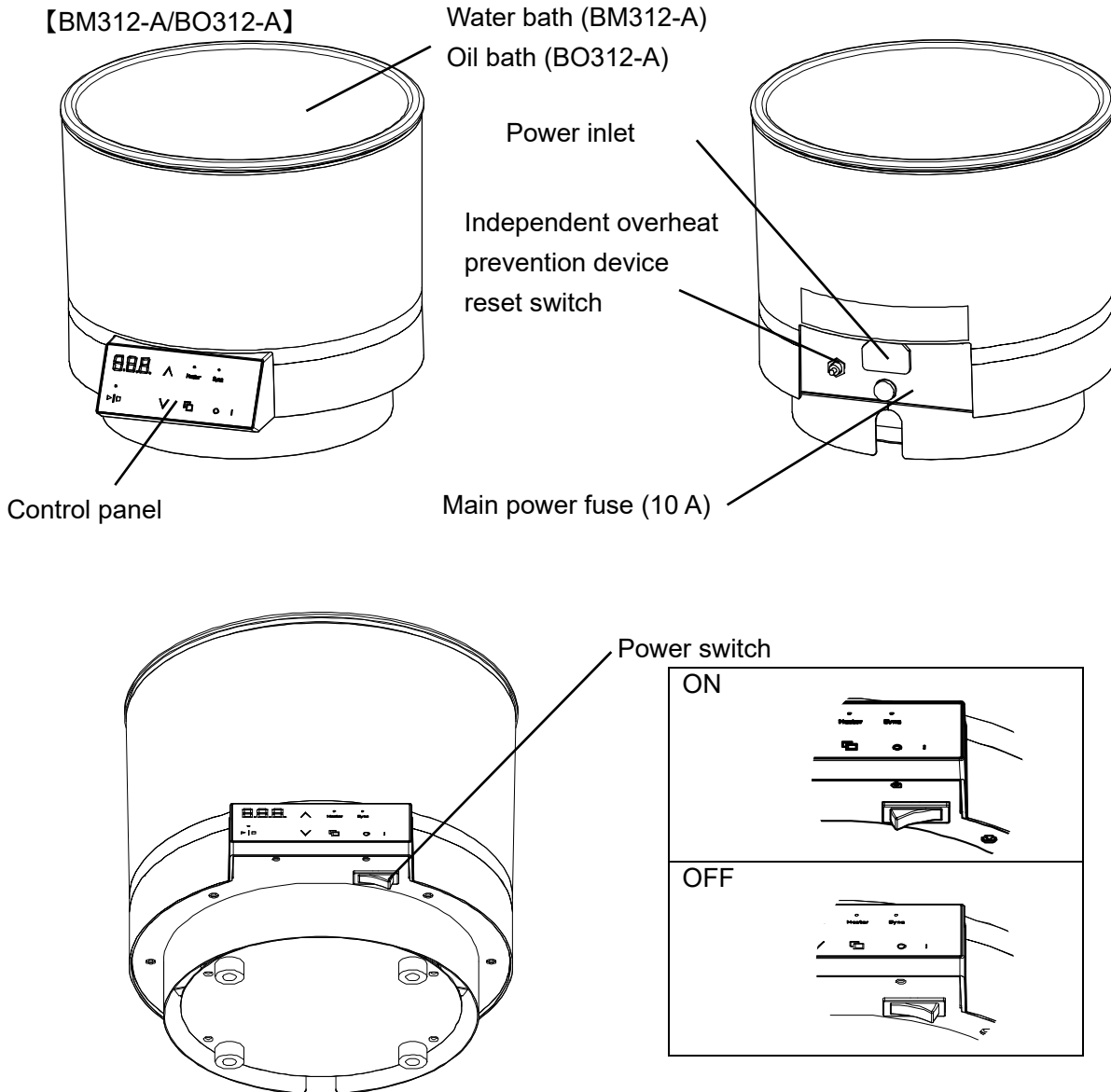

Accessories

Check before operation that all the accessories are complete. Contact original dealer of purchase if anything is missing.

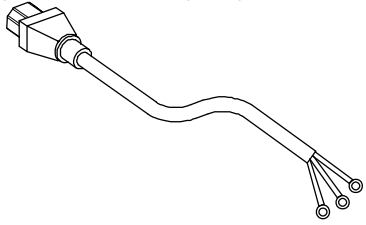
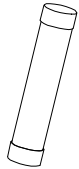
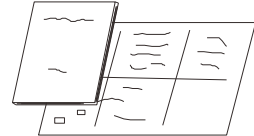
<p>(1) Power cable (3 m)</p> 	<p>(2) Spare fuse for main power 10 A (large)</p> 	<p>(3) Instruction manual (4) Warranty card</p> 
--	---	---

2. COMPONENT NAMES AND FUNCTIONS

Control Panel

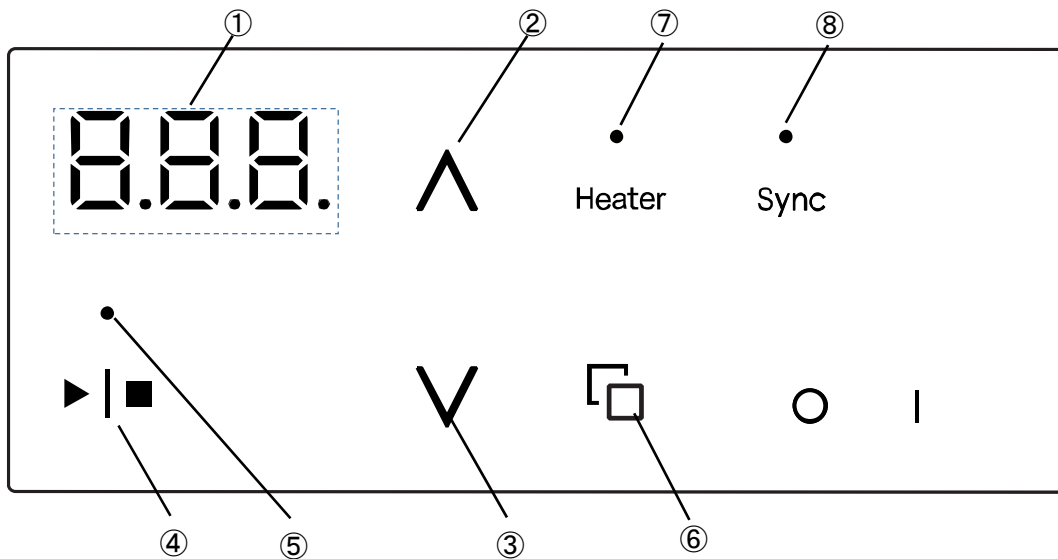

No.	Panel item	Description
①	Temperature display	Shows current temperature, temperature setting, and items in user setting.
②	Up key	Press to increase or decrease set value, scroll items in user setting, and switch settings.
③	Down key	
④	Run/Stop key	Press to start or stop an operation. Press one second to start operation, pressing it while unit is running will stop operation.
⑤	Run/Stop lamp	Illuminates during operation.
⑥	Set key	Press to switch screen between temperature reading and temperature setting. Press and hold to switch screen to user setting.
⑦	Heater lamp	Illuminates when heater is on and drawing power.
⑧	Syncro lamp	Not used for this unit.

Display Characters

All characters displayed when making settings and during operation are defined as follows:

Character	Letters	Description
CAL	CAL	Appears while entering offset temperature values. See "Calibration Offset" (P.18)
Pon	Pon	Appears when setting Auto-resume function. See "Auto-resume Function" (P.19)
tAH	tAH	Overshoot alert See "Overshoot Alert" (P.20)
dSP	dSP	Appears when setting LED brightness. See "LED Brightness Setting" (P.21)

3. PRE-OPERATION PROCEDURES

Installation Precautions



Choose an appropriate installation site.

DO NOT install unit:

- where installation surface is not completely level, not even or not clean.
- where flammable or corrosive gases/fumes may be present
- where external temperature will exceed 35°C, will fall below 5°C or will fluctuate largely.
- where liquid is assumed to splash on unit
- in excessively humid or dusty locations.
- in direct sunlight or outdoors.
- where there is constant vibration.
- in direct contact with the outside air
- where power supply is erratic.
- where there is combustible material nearby.
- in the proximity of, particularly right below a fire alarm.
- where there is a risk of freezing or condensation.



Install unit in a location with sufficient space, as specified below.

【BM302-A/312-A, BO302-A/312-A】

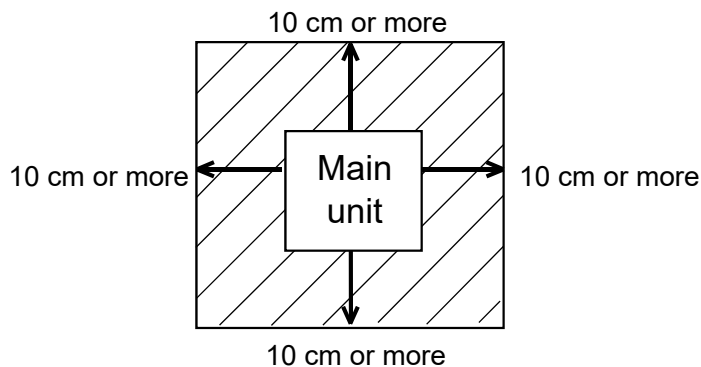

Install unit on a level surface.

Install unit on level and even surface. Failure to do so may cause abnormal vibrations or noise, possibly resulting in complications and/or malfunction.

3. PRE-OPERATION PROCEDURES

Installation Precautions



Make power connection properly.

【BM302-A, BO302-A】

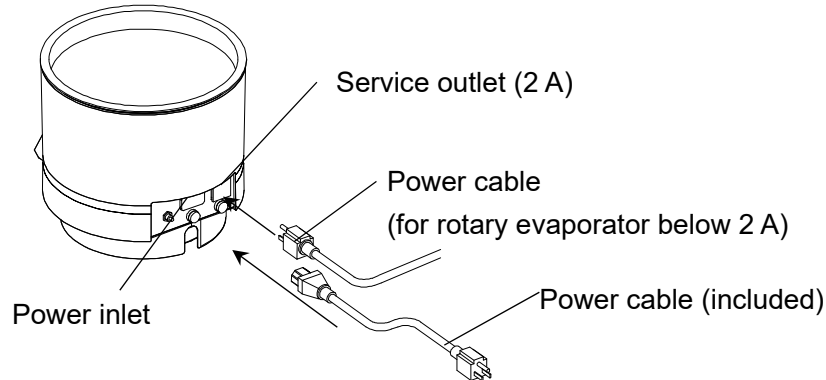

Insert supplied power cable into the power inlet. Rated capacity of the service outlet is 2 A.

❖ Service outlet carries power regardless of whether main power is ON (I) or OFF (O).

【BM312-A, BO312-A】

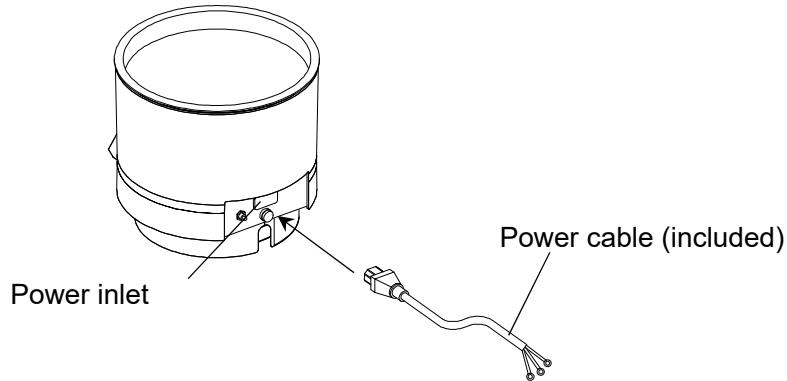

Insert supplied power cable into the power inlet.



Always connect power cable to appropriate facility outlet or terminal.

Connect power cable to a suitable facility outlet or terminal, according to the electrical requirements.

Power requirements BM302-A/BO302-A: 100-115 V AC single phase 50/60 Hz 10-12 A (fuse 15 A)*1
 BM312-A/BO312-A: 200-230 V AC single phase 50/60 Hz 5-6 A (fuse 10 A)*2

*1 BM302-A /BO302-A units are compatible with the voltage range of 100-115 V AC, by choosing a suitable power cable.

*2 BM312-A /BO312-A units are compatible with the voltage range of 200-230 V AC, by choosing a suitable power cable.

Operational voltage ranges are 90-125V(BM302-A/BO302-A) and 180V-250V(BM312-A/BO312-A), performance guarantee voltage ranges are 95V-120V(BM302-A/BO302-A) and 190V-241V(BM312-A/BO312-A), and frequency is $\pm 1\%$

* Rated current 10-12 A does not include that of service outlet (2 A). (BM302-A, BO302-A)

* Check the line voltage on distribution board and properly evaluate whether to utilize a line being shared by other equipment. If unit is not activated by turning the Power switch ON (I) take an appropriate course of action, such as connecting unit to a dedicated power source. Inserting multiple cords into a single outlet, using branch outlets or extension cords, may cause a drop in voltage, which may affect performance, resulting in failure to control or maintain proper temperature.

Model	Standard	Cable end processing
BM302-A, BO302-A	3-core 1.0 mm ² *1	Type A electrical plug
BM312-A, BO312-A	3-core 1.0 mm ² *1	M4 ring terminals

3. PRE-OPERATION PROCEDURES

Installation Precautions



Install in a dry location.

Install unit where it will be free from liquid spray and other moisture. Failure to do so may result in control mechanisms becoming wet, causing malfunction, electrical shock and/or fire.



Use unit in fume hood whenever processing harmful solvents.

A ventilation hood must be installed for processing harmful solvents at constant temperature.

Also obtain the safety data sheet (SDS) for safe use, and handle with extreme care.

【BO302-A/312-A】

Silicon oil when heated at more than 150°C will gradually generate trace amount of formaldehyde. Place unit in fume hood or provide good ventilation for safe operation.



Heating medium

【BM302-A/312-A】

For water only * Using a fluid other than water may result in fire or equipment malfunction.

【BO302-A/312-A】

For water and oil * Maximum operating temperature is up to 90 °C for water, and 180°C for oil. Use heat-resistant dimethyl silicon oil for open system heat transfer only, and kinematic viscosity of 50mm²/s (cSt) or less.

Recommended: KF-96-50cs silicon oil by Shinetsu Science Industries Co., Ltd.

Silicone oil characteristics	Appearance	Clear and colorless
	Kinematic viscosity (25°C)	50 mm ² /s
	Specific gravity (25°C)	0.960
	Volatile content (150 °C/24 h)	0.5% or less
	Viscosity temperature coefficient (V.T.C)	0.59
	Pour point	-50 °C or less
	Flash point	310 °C or more
	Specific Heat (25 °C)	1.5 J/g·°C
	Thermal conductivity (25 °C)	0.15 W/m·°C
	Expansion coefficient (25-150°C)	0.00096 cc/°C

- ❖ Deterioration rate of silicone oil varies depending on the operating temperature. For more information on the silicone oil characteristics, contact silicone oil maker at the time of purchase.
- ❖ Use KF-96-50cs from Shinetsu Science Industries Co., Ltd. or its equivalent oils. KF-96 series silicone oil includes various types of viscosity. Note that low-viscosity oils have low heat-resistance, and high-viscosity oils may cause local heating, possibly resulting in fire.

3. PRE-OPERATION PROCEDURES

Installation Precautions



Air-dry unit completely after using low-temperature water.

When using cold water below room temperature, operate unit under the condition of room temperature 20 ± 5 °C, humidity 60 % RH. After operating with low-temperature water, condensations may have formed inside unit. Leave unit in a well-ventilated place until it dries completely to prevent the possibility of electrical leakage.

Safety Functions

1	Independent overheat prevention (fixed temperature)	Unit has a separate overheat prevention device, independent of the CPU board for added safety. However, this is not designed to prevent empty heating. Do not run unit without sufficient amount of fluid. Bath reservoir is hot when the device is activated. Turn OFF (○) the Power switch and disconnect power cable. Avoid touching the reservoir until it cools. See "Independent Overheat Prevention Device Reset" (P.22) for procedure for resetting overheat prevention device.
2	Automatic overheat prevention	This function shuts off heater circuit when temperature reading exceeds set temperature to a certain degree. (Operation continues)
3	Temperature upper limit error (E06)	This function shuts off heater circuit when temperature reading exceeds maximum operating temperature. Activation temperature: approx. 105 °C (BM302-A/312-A) approx. 220 °C (BO302-A/312-A) Bath reservoir is hot when the device is activated. Turn OFF (○) the Power switch and disconnect power cable. Avoid touching the reservoir until it cools. Wait until the temperature of the reservoir falls below 60 °C, then turn the Power switch back ON (I). Unit will restart.
4	Overcurrent protection fuse	Unit is equipped with overcurrent protection fuse on the rear. The fuse blows when overcurrent occurs during operation. Check the fuse if unit does not turn on by turning the Power switch ON (I) while independent overheat prevention device is not activated. Replace the fuse by referring to "Maintenance and Inspection" (P.26).

* If overheat prevention device activation and temperature upper limit error frequently occurs, contact original dealer of purchase for inspection.

* Main function of overheat prevention function and temperature upper limit is to keep this unit from overheating, NOT to protect test samples from damage. Likewise, it is NOT intended for protection against accident or injury resulting from the negligent use of explosives and flammables.

3. PRE-OPERATION PROCEDURES

Installation Precautions



Supply of water/oil

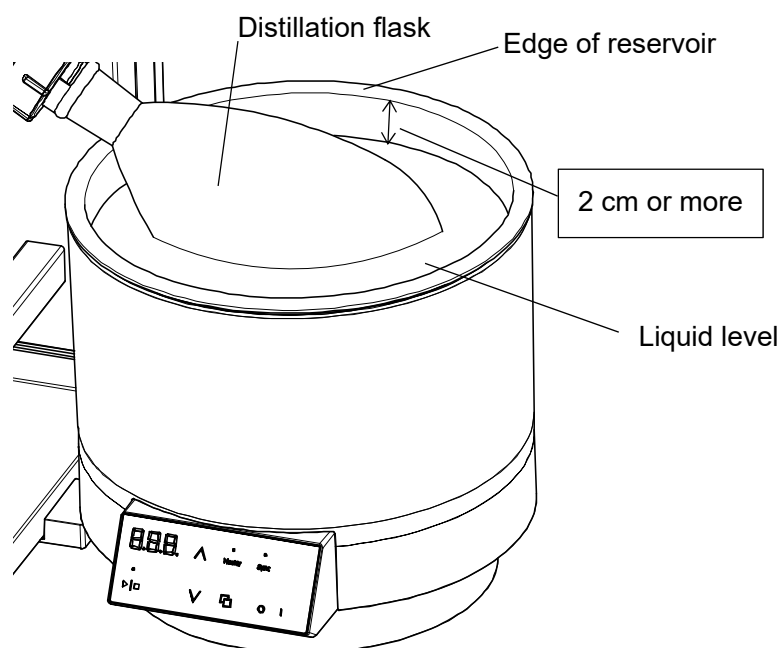

Maximum fluid level should be 2 cm from the edge of the reservoir with a flask or other container is placed in the bath. Use caution not to overflow the bath when supplying fluid. Pour at least 2 L of fluid in the reservoir.

【BO302-A/312-A】

Silicon oil has a broad thermal expansion capacity and may overflow from bath when heated.

Expansion should be subtracted prior to supply silicone oil to the reservoir.

Example) Supply amount of KF-96-50cs to the reservoir can be calculated based on the following formula.





Oil increment = (set temperature - temperature reading) × amount of silicone oil × 0.00096

With set temperature 180 °C, current temperature reading 23 °C, and required amount of silicone oil 4.5 L, increase amount of the oil will be: (180 °C-23 °C) × 4.5 L × 0.00096 = 0.68 L.

Thus, 3.8 L of silicone oil needs to be prepared in the case of example above.

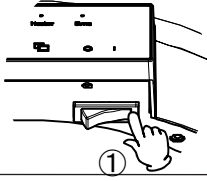
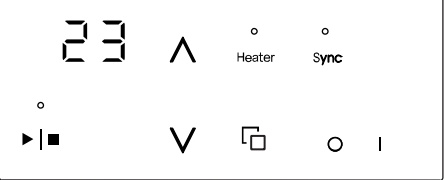
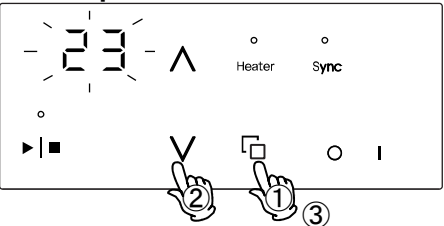
4. OPERATION PROCEDURES

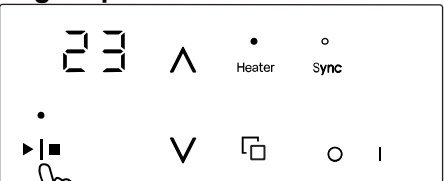

Operation Procedure

<p>1. Turn power on.</p>	 	<p>1. Turn ON (I) the Power switch on the lower right of the control panel.</p> <p>Temperature display: Temperature reading will show following firm ware version "V. o. o".</p>
<p>2. Set temperature</p>	 <p>☼ indicates flashing.</p>	<p>1. Press  key. Temperature display: Current set temperature flashes.</p> <p>2. Enter desired value by using the \wedge \vee keys. [BM302-A/312-A] Temperature setting range: 0-90 °C [BO302-A/312-A] Temperature setting range: 0-180 °C (oil) 0-90 °C (water)</p> <p>❖ Operate BO302-A/312-A unit below 90 °C when using water.</p> <p>3. Press  key. Temperature display: Temperature reading will show</p>
<p>3. Begin operation</p>	 <p>Press 1 sec.</p>	<p>Press and hold  key for one second.</p> <p>Run/Stop lamp : ON Heater lamp : On/Flashing</p> <p><To stop> Press  again. Run/Stop lamp : OFF Heater lamp : OFF</p>

4. OPERATION PROCEDURES

User Setting

List of user setting items

- Press and hold  key for four seconds to show user setting. Select an item by using \wedge \vee keys. Press  key again to make setting on the selected item.
- Holding down  key for two seconds while the user setting item is displayed, or leaving unit without key operation for about two minutes, will discard the changes, and the display returns to previous screen.
- Only calibration offset function "CAL" can be set or altered during operation (Run/Stop lamp ON). The other items must be set during standby.

Panel item	Description	Page
Calibration offset	Calibration offset is a function which can correct for any differences discovered between actual liquid temperature and the temperature displayed on the control panel. Offset function can correct to either the positive or negative side of the entire unit temperature range. Setting range: -5.0 to +5.0 °C Default setting is "0.0 °C"	P.18
Auto-resume function	Select operation for the time power is restored. OFF: Unit goes into idle at power recovery. ON: Unit automatically reverts to status just before power loss and begin operation once again from that point. Default setting is "OFF"	P.19
Overshoot alert	When temperature reading goes over "set temperature + alert setting value (°C)", the readout begins flashing to alert an overshoot. Alert setting range: 1-50 °C Default setting is "50 °C"	P.20
LED brightness setting	Change the LED brightness of the control panel. The brightness can be set in 8 levels from 0 to 7. Setting range: 0-7 Default setting is "3"	P.21

4. OPERATION PROCEDURES

Calibration Offset

Calibration offset is a function which can correct for any differences discovered between actual liquid temperature and the temperature displayed on the control panel.

Offset function can correct to either the positive or negative side of the entire unit temperature range.

- Run unit at desired temperature. Once temperature has risen and stabilized, gauge liquid temperature with a thermograph.

- Check the difference between the set temperature and the actual liquid temperature.

Setting range: -5.0 to +5.0 °C

Default setting is "0.0 °C"

❖ Setting change can also be made during operation.

Example

Actual temperature is 2 °C lower than control panel temperature reading of 60 °C.

Temperature reading can be calibrated by entering a calibration offset value of -2.0 to compensate against the actual temperature deficiency of 2 °C.

If the initial temperature reading was 60°C, it will read 58°C after offset calibration, and be brought into agreement with actual liquid temperature.

1. Enter user setting

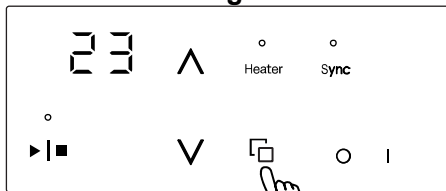

Press 4 sec.

Turn power ON (I) and press  key for four seconds while temperature reading is on the screen. Unit enters user setting.

2. Change offset value

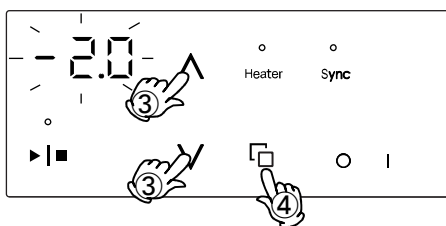
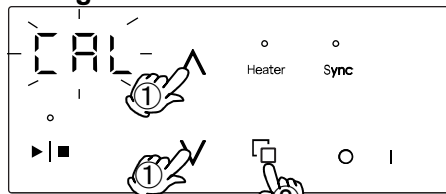

1. Select "CAL" using the \wedge \vee keys.

Temperature display: "CAL" flashes.

2. Press  key.

Temperature display: Current set value flashes.

3. Enter a value that brings set temperature and liquid temperature into agreement, using the \wedge \vee keys.

4. Press  key to finalize.

Temperature display: Set value is shown for about one second.

After completion, the screen returns to step 1.

3. Exit use setting

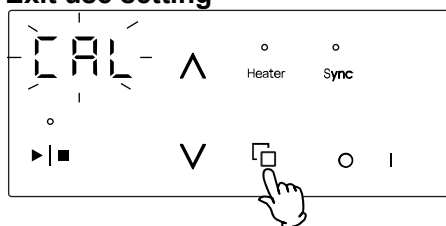

Press 2 sec.

After completing the setting, press and hold  key for two seconds. Display reverts to initial screen and shows temperature reading.

4. OPERATION PROCEDURES

Auto-resume Function

Select recovery mode for the event of a power failure.

OFF: Unit goes into idle at power recovery.

ON: Unit automatically reverts to status just before power loss and begin operation once again from that point.

Default setting is "OFF"

❖ Setting change can be made during standby only.

1 Enter user setting

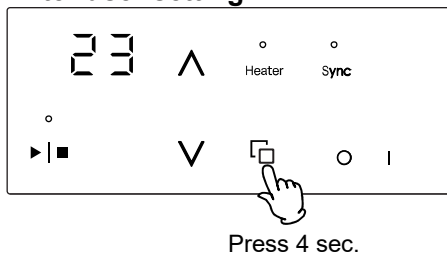

Turn power ON (I) and press  key for four seconds while temperature reading is on the screen. Unit enters user setting.

2 Change the Auto-resume setting

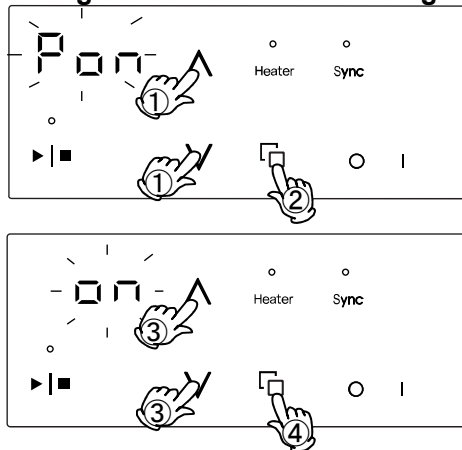

1. Select "Pon" using the \wedge \vee keys. Temperature display: "Pon" flashes.

2. Press  key. Temperature display: Current setting flashes.

3. Use the \wedge \vee keys to alter the setting.

4. Press  key to finalize. Temperature display: New setting is shown for about one second.

After completion, the screen returns to step 1.

3 Exit use setting

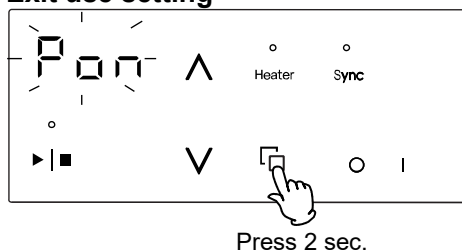

After completing the setting, press and hold  key for two seconds. Display reverts to initial screen and shows temperature reading.

4. OPERATION PROCEDURES

Overshoot Alert

When temperature reading goes over "set temperature + alert setting value (°C)", the readout begins flashing to alert an overshoot.

Alert setting range: 1 to 50°C

Default setting is "50 °C"

❖ Setting change can be made during standby only.

1 Enter user setting

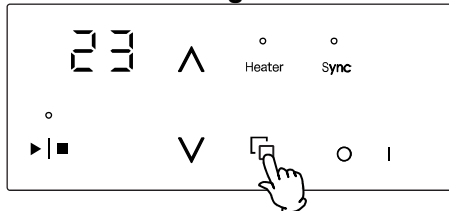

Press 4 sec.

Turn power ON (I) and press  key for four seconds while temperature reading is on the screen. Unit enters user setting.

2 Change alert setting value

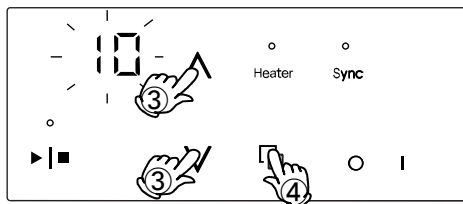
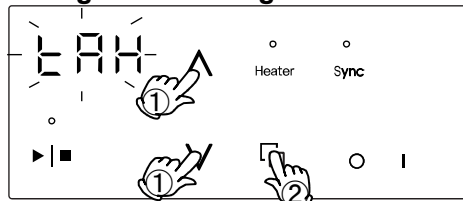

1. Select "tAH" using the \wedge \vee keys.

Temperature display: "tAH" flashes.

2. Press  key.

Temperature display: Current set value flashes.

3. Use the \wedge \vee keys to alter the setting.

4. Press  key to finalize.

Temperature display: Set value is shown for about one second.

After completion, the screen returns to step 1.

3 Exit use setting

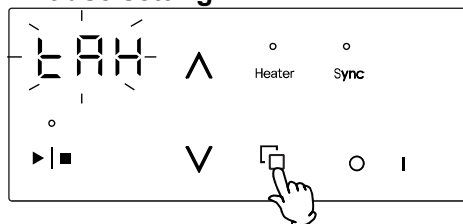

Press 2 sec.

After completing the setting, press and hold  key for two seconds. Display reverts to initial screen and shows temperature reading.

4. OPERATION PROCEDURES

LED Brightness Setting

Change the LED brightness of the control panel.

The brightness can be set in 8 levels from 0 to 7.

Default setting is "3"

❖ Setting change can be made during standby only.

1 Enter user setting

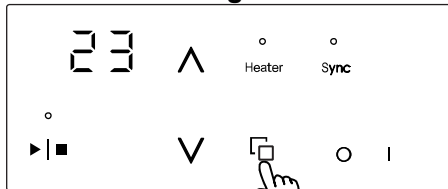

Press 4 sec.

Turn power ON (I) and press  key for four seconds while temperature reading is on the screen. Unit enters user setting.

2 Select the LED brightness level

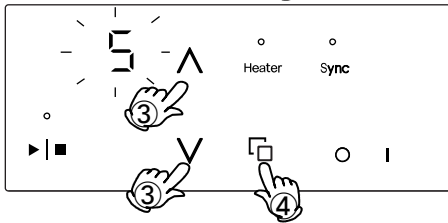
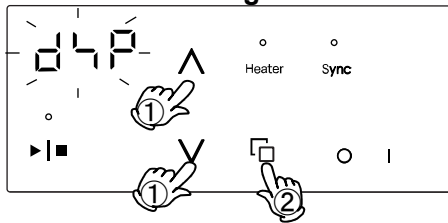

1. Select "dSP" using the \wedge \vee keys.

Temperature display: "dSP" flashes.

2. Press  key.

Temperature display: Current set value flashes.

3. Use the \wedge \vee keys to alter the setting.

4. Press  key to finalize.

Temperature display: Set value is shown for about one second.

After completion, the screen returns to step 1.

3 Exit use setting

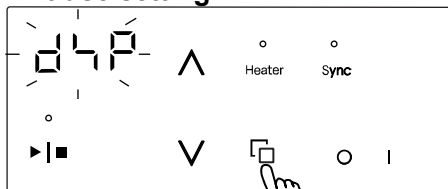

Press 2 sec.

After completing the setting, press and hold  key for two seconds. Display reverts to initial screen and shows temperature reading.

4. OPERATION PROCEDURES

Independent Overheat Prevention Device Reset



Be sure to reset independent overheat prevention device after confirming that temperature of the bath reservoir has become room temperature.

Unit is hot when the device is activated. Exercise vigilance in order to avoid getting burned.

Resetting independent overheat prevention device

Independent overheat prevention device shuts off power supply to the controller when bath temperature has risen beyond the device activation temperature (fixed). When independent overheat prevention device activates, the display will be blank despite the Power switch in the ON (I) position.

1 Turn power off

1. Turn the Power switch OFF (O).

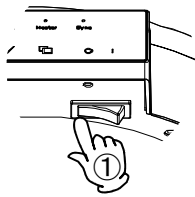

2 Reset independent overheat prevention device

2. Address the cause of independent overheat prevention device activation; low water/oil, ambient temperature exceeds 36 °C, etc.

3. Check that unit is cooled to room temperature and press the reset switch of independent overheat prevention device.

❖ The device cannot be reset while unit is hot. Wait until bath temperature falls below 60 °C.

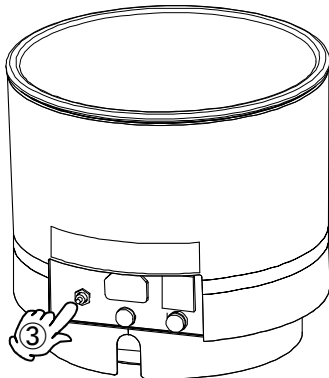

3 Turn power on

Turn the Power switch ON (I).
Control panel display will turn on.

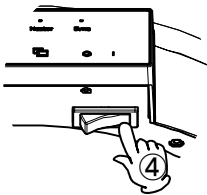

◆ Contact original dealer of purchase if unit will not restart.

5. HANDLING PRECAUTIONS

Warnings and Cautions



NEVER process explosive or flammable substances



Never attempt to process explosives, flammables or any items which contain explosives or flammables. Fire or explosion may result. See "13. LIST OF HAZARDOUS SUBSTANCES" (P.36)



Resin container advisory.

When using resin containers for processing, confirm that they conform to the heating specifications of this unit. Heating resin beyond capacity to withstand temperature will cause resin to melt and may result in fire or explosion.



DO NOT insert foreign objects into unit openings.

In the event that a foreign object accidentally falls inside, turn off the Power switch immediately, disconnect power cable and contact original dealer of purchase for assistance. Failure to do so may result in fire or electric shock.



DO NOT use silicone oil mixed with any moisture.

【BO302-A/312-A】

Moisture in oil evaporates explosively when heated to high temperatures, possibly resulting in fire or burn injury.

When changing the fluid between water and silicone oil, thoroughly wipe the moisture or oil content off the reservoir.



DO NOT touch bath reservoir while operating at high temperatures.



Bath reservoir becomes hot during high temperature operation.

When necessity dictates contacting hot surfaces, be sure to wear protective equipment against burn injury. Pay due attention not to spill heated medium.



Use extreme caution in handling fluids and samples following high temperature operation.

Bath reservoir, water/oil, and sample/process items are hot during operation or for some time after operation. Be careful with hot items in order to avoid burn injury.

Dispose of heating medium after it comes below 45 °C.



DO NOT process corrosive items.

Do not process items containing corrosive chemicals of any kind. Potent acids may corrode the reservoir despite stainless steel construction.

5. HANDLING PRECAUTIONS

Warnings and Cautions



ALWAYS run equipment within specified temperature range.

Never attempt to operate unit outside of specification range. Equipment malfunction or damage may result.



Overnight and extended storage.

When unit is not in operation during the night or for extended period of time, be sure to turn OFF (○) the Power switch and disconnect power cable.

Discharge water/oil and clean the reservoir if unit will be in storage for a long period of time. See "6. MAINTENANCE PROCEDURES" (P.25). Failure to do so may lead to buildup of scale, or malfunction due to corrosion.



Power loss recovery.

When a power loss occurs during operation and then restored, unit may resume operation or remain on standby. These actions can be selected through user setting. See "Auto-resume Function" (P.19) for setting procedure; default setting is "OFF".



Exercise caution when processing heat-generating substances.

Note that temperature reading may not be consistent when processing heat-generating samples.



Use calibration offset function to correct temperature reading.

If there is a discrepancy between temperature reading and actual liquid temperature, see "Calibration Offset" (P.18) to make a correction.



Inspect regularly.

Regular inspection and maintenance are highly recommended to ensure proper operation. See "6. MAINTENANCE PROCEDURES" (P.26) for detailed instructions.

6. MAINTENANCE PROCEDURES

Precautions before Inspection



WARNING

- Be sure to disconnect power cable before conducting inspection and maintenance.
- Perform inspections and maintenance when unit is at room temperature.
- Never attempt to disassemble unit.

Precautions in Daily Maintenance



CAUTION

- Clean unit using soft damp cloth. Never use benzene, paint thinner, scouring powder, scrubbing brush or other abrasives and solvents to clean unit. Superficial damage and/or discoloration, as well as deformity to some components may result.

Maintenance and Inspection

- Bath reservoir maintenance
 - Wash the reservoir regularly. Operating unit with scale formed on the reservoir may cause abnormal temperature rise, leading to equipment damage.
- Check power plug for damage
 - Check power plug for dust or dirt on its prongs, and clear off if any accretions found.
 - Confirm that the prongs of power plug are not bent or damaged. Replace if bent or damaged.
 - Check the power plug for discoloration or abnormal heat generation. If there is discoloration or abnormal heating, the internal contact of the outlet may be faulty.

6. MAINTENANCE PROCEDURES

Maintenance and Inspection

● Fuse replacement

- If overcurrent protection fuse has blown, eliminate the cause and replace with a spare.

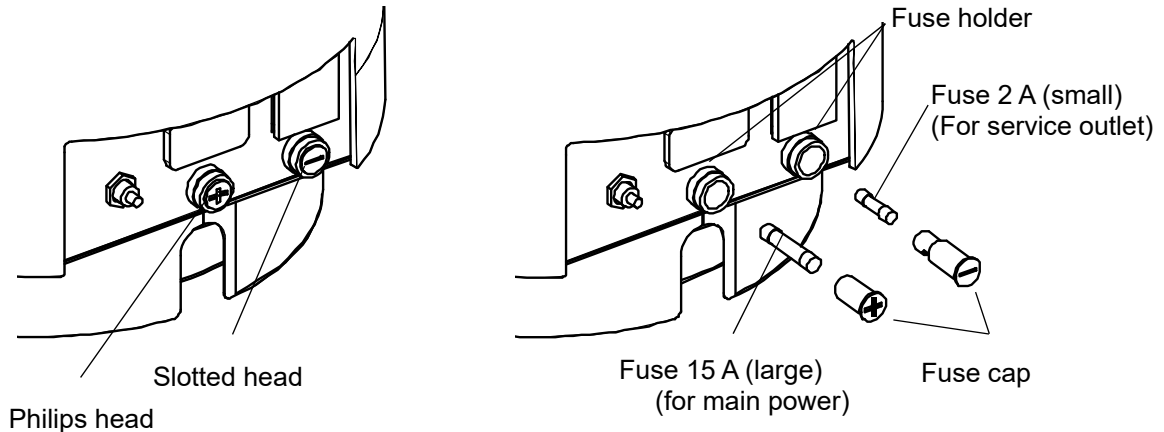



1. Turn OFF (○) the Power switch and disconnect power cable.
2. Remove fuse cap with a screwdriver.
Main power fuse (15 A): Capped with screw-on fuse cap. Turn counterclockwise until it comes off.
Service outlet (2 A): Turn 90 degrees counterclockwise to remove the cap.
3. Replace the blown fuse with a spare, and put the cap back on the fuse holder.
Main power fuse (15 A): Turn the cap all the way clockwise.
Service outlet (2 A): Fix the cap by pushing it lightly in the holder and turn it 90 degrees clockwise.
4. Insert power cable into facility outlet, and turn the Power switch ON (|) to confirm that unit draws power.

❖ BM312-A/BO312-A units are not equipped with a service outlet and a fuse for it.

- ◆ Contact original dealer of purchase for further assistance.

7. EXTENDED STORAGE AND DISPOSAL

Extended Storage/Disposal

 WARNING	 CAUTION
Extended storage Turn OFF (○) the Power switch and disconnect power cable.	Disposal Do not leave unit in a location where children may have access.

Disposal Considerations

Dispose of or recycle this unit in a responsible and environmentally friendly manner.

Yamato Scientific Co., Ltd. strongly recommends disassembling unit, as far as is possible, in order to separate parts and recycle them in contribution to preserving the global environment. Major components and materials, comprising BM/BO units are listed in the table below

Component Name	Material
Main Unit Components	
Exterior	Polybutylene terephthalate resin (with fiber glass), chromium-free electrogalvanized steel sheets, stainless steel, aluminum
Bath reservoir	Stainless steel, aluminum
Heat insulator	Glass wool
Electrical Parts	
Switches and relays	Composite of resin, copper and other materials
Control panel	Polybutylene terephthalate resin (with fiber glass) Polycarbonate resin
Printed circuit boards	Composite of fiber glass and other materials
Heater	Aluminum tube heater
Power cable	Composite of synthesized rubber coating, copper, nickel and other compounds
Wiring materials	Composites of fiber glass, fire-retardant vinyl, copper, nickel and other compounds
Seals	Resin material
Sensor	Stainless steel etc.

8. TROUBLESHOOTING

Reading Error Codes

This unit has a self-diagnostic function built into the CPU board and a separate safety function, independent of the CPU board. The table below shows possible causes and measures to take when a safety function is performed.

[Error Codes]

When an operational error or malfunction occurs, error code and temperature reading are alternately displayed on the control panel, and operation stops. When an error occurs, confirm the error code and turn OFF (○) the Power switch immediately.

Display code	Description	Possible causes and measures
E 0 1	Temperature sensor failure (E01)	<ul style="list-style-type: none"> ● Controller failure ● Defective temperature sensor (interrupted or short circuited) ● Temperature out of specification range. Contact original dealer of purchase for assistance.
E 0 6	Temperature upper limit error (E06)	<ul style="list-style-type: none"> ● When temperature reading rises beyond the limits specified below, operation will be terminated. BM302-A/312-A: approx. 105 °C BO302-A/312-A: approx. 220 °C ● Turn OFF (○) power supply and wait until the liquid temperature comes below 60 °C, and restart operation. If unit does not reset, contact original dealer of purchase
E 1 5	EEPROM failure (E15)	<ul style="list-style-type: none"> ● Error in a storage element EEPROM on the controller board ● Turn OFF (○) power and restart unit. If unit does not reset, contact original dealer of purchase

Other warnings

Display alert	Description	Possible causes and measures
Temperature reading flashes (only in operation)	Overshoot alert	<ul style="list-style-type: none"> ● When temperature reading goes over “set temperature + alert setting value (°C)”, the readout begins flashing to alert an overshoot. (Operation continues) Contact original dealer of purchase if temperature continues to significantly decrease after alert occurs.

When independent overheat prevention device is activated.

Display alert	Description	Possible causes and measures
Lamps on the control panel went out	Independent overheat prevention	<ul style="list-style-type: none"> ● Independent overheat prevention device shuts off power supply to the controller when bath temperature has risen beyond the device activation temperature (fixed). ● See “Independent Overheat Prevention Device Reset” (P.22) for procedure for resetting the device. If unit does not reset, contact original dealer of purchase

8. TROUBLESHOOTING

Troubleshooting Guide

Symptom	Possible causes	Possible measures
Unit does not turn on when the Power switch is turned ON (I).	<ul style="list-style-type: none"> ● Power supply failure ● Power cable disconnection 	<ul style="list-style-type: none"> ● Check power supply voltage [BM302-A, BO302-A] Must be 90-125 V AC ● Check power supply voltage [BM312-A, BO312-A] Must be 180-250 V AC ● Insert power cable firmly deep into the power inlet. See "Make power connection properly." (P.12)
	<ul style="list-style-type: none"> ● Power switch failure ● Controller failure ● Independent overheat prevention device is activated ● Overcurrent protection fuse (15 A) is blown 	<ul style="list-style-type: none"> ● Replace relevant parts ● Replace relevant parts ● Press the reset switch. See "Independent Overheat Prevention Device Reset" (P.22) ● Replace relevant parts
Temperature does not rise when the Run/Stop key is ON	<ul style="list-style-type: none"> ● External temperature is below 5 °C ● Independent overheat prevention device is activated 	<ul style="list-style-type: none"> ● Operating ambient temperature range is 5 to 35 °C ● Press the reset switch. See "Independent Overheat Prevention Device Reset" (P.22)
	<ul style="list-style-type: none"> ● Temperature sensor failure ● Controller failure ● Heater failure ● Power supply failure 	<ul style="list-style-type: none"> ● Replace relevant parts ● Replace relevant parts ● Replace relevant parts ● Check power supply voltage [BM302-A, BO302-A] Must be 90-125 V AC ● Check power supply voltage [BM312-A, BO312-A] Must be 180-250 V AC

Requests for Repair

If abnormalities remain after confirming "Troubleshooting Guide", terminate operation, turn OFF (○) the Power switch, and disconnect power cable. Contact original dealer of purchase for assistance.

The following information is required for all repairs.

- Product Name
 - Model
 - Serial Number
 - Date (year/month/day) of Delivery
 - Description of problem in as much detail as possible
- } Refer to warranty card.
- Repair this equipment for free of charge according to the contents on warranty card. Warranty period is 1 (one) year from date of purchase.
 - Consult with original dealer of purchase for any repair after warranty ended. Charged repair service of this equipment will be available on customer's request when it can be maintained functional by its repair.

* Be sure to present warranty card to the service representative.

Guaranteed Supply Period for Repair Parts

Guaranteed maximum supply period for repair parts is 7 (seven) years from date of discontinuation for this equipment.

"Repair parts" is defined as components which, when installed, allow for continued equipment operation.

10. SPECIFICATIONS

BM302-A/BO302-A

Model		BM302-A	BO302-A
Product Name		Water Bath	Oil Bath
Performance * 1	Operating ambient temperature range	5 to 35 °C	
	Temperature control range	Room temp +10°C to 90°C	Room temp +10°C to 180°C
	Temperature control accuracy	±1.0 °C	±2.0 °C
Configuration	Temperature control system	PID control	
	Controller	White LED digital display, key entry, minimum digit of 1 °C	
	Temperature sensor	Pt100 Ω	
	Heater	1000 W aluminum sheathed heater	
	Exterior	PBT (with fiber glass)	
	Bath reservoir	Stainless steel	
Safety functions		Automatic overheat prevention, independent overheat prevention (fixed temp.), temperature upper limit error Overcurrent protection fuse	
Other functions		Overshoot alert, Auto-resume (selectable) 2 A service outlet, calibration offset	
	External dimensions *2	φ262 (max. D286) x H240 mm	
	Reservoir capacity	Approx. 5 L	
	Power supply (Fuse capacity)	100-115 V AC 10-12 A (Service outlet excluded) (15 A)	
	Power cable	3 m long, with inlet plug *3	
	Weight	Approx. 4.5 kg	
Accessories		Instruction manual (1), warranty card (1), power cable (1) Spare fuse for main power 15 A (large)(1) Spare fuse for service outlet 2 A (small)(1)	

*1 Performance data above based on 95-120 V AC supplied power, 23 ±5 °C room temperature, 65%RH ±20% humidity, and no process load.

Operating temperature range for BM/BO series unit is between 5°C and 35°C. Be advised that maximum operating temperature may not be reached under low ambient temperatures, if source voltage is below 95 V.

Temperature control accuracy is measured based on JTM K05

*2 Dimensions do not include protrusions.

*3 BM302/BO302 units are compatible with the voltage range of 100-115 V AC, by choosing a suitable power plug.

Temperature Rise Curve (reference data)

Analysis provisions

Room temperature: 23±5 °C

Power supply: 115 V AC ±5 %

Measurement: reservoir center,

Fluid volume: 3 L, no load

Set temperature: BM302-A 90 °C. BO302-A 180 °C (oil) / 90 °C (water)

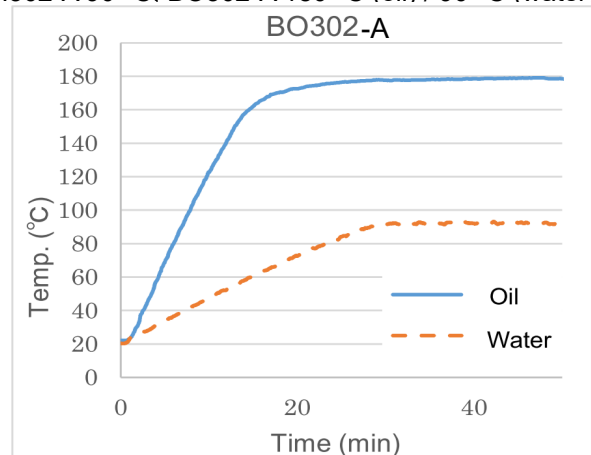
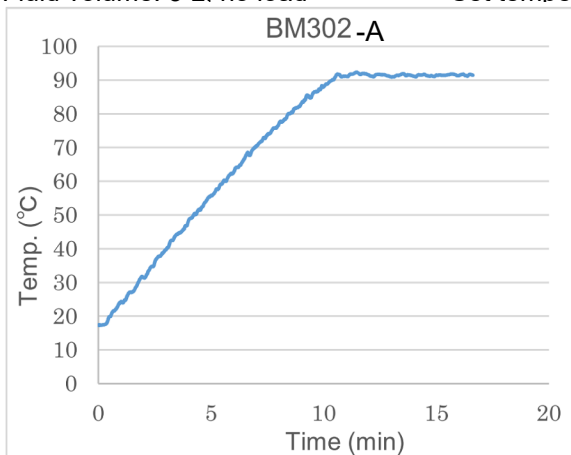

10. SPECIFICATIONS

BM312/BO312

Model		BM312-A	BO312-A
Product Name		Water Bath	Oil Bath
Performance * 1	Operating ambient temperature range	5 to 35 °C	
	Temperature control range	Room temp +10°C to 90°C	Room temp +10°C to 180°C
	Temperature control accuracy	±1.0 °C	±2.0 °C
Configuration	Temperature control system	PID control	
	Controller	White LED digital display, key entry, minimum digit of 1 °C	
	Temperature sensor	Pt100 Ω	
	Heater	1000 W aluminum sheathed heater	
	Exterior	PBT (with fiber glass)	
	Bath reservoir	Stainless steel	
Safety functions		Automatic overheat prevention, independent overheat prevention (fixed temp.), temperature upper limit error Overcurrent protection fuse	
Other functions		Overshoot alert, Auto-resume (selectable) Calibration Offset	
	External dimensions *2	φ262 (max. D286) x H240 mm	
	Reservoir capacity	Approx. 5 L	
	Power supply (Fuse capacity)	200-230 V AC 5-6 A (10 A)	
	Power cable	3 m long, with inlet plug *3	
	Weight	Approx. 4.5 kg	
Accessories		Instruction manual (1), warranty card (1), power cable (1) Spare fuse for main power 10 A (large)(1)	

*1 Performance data above based on 190-241 V AC supplied power, 23 ±5 °C room temperature, 65%RH ±20% humidity, and no process load.

Operating temperature range for BM/BO series unit is between 5°C and 35°C. Be advised that maximum operating temperature may not be reached under low ambient temperatures, if source voltage is below 190 V.

Temperature control accuracy is measured based on JTM K05

*2 Dimensions do not include protrusions.

*3 BM312/BO312 units are compatible with the voltage range of 200-230 V AC, by choosing a suitable power plug.

Temperature Rise Curve (reference data)

Analysis provisions

Room temperature: 23±5 °C

Power supply: 230 V AC ±5 %

Measurement: reservoir center,

Fluid volume: 3 L, no load

Set temperature: BM312-A 90 °C, BO312-A 180 °C (oil) / 90 °C (water)

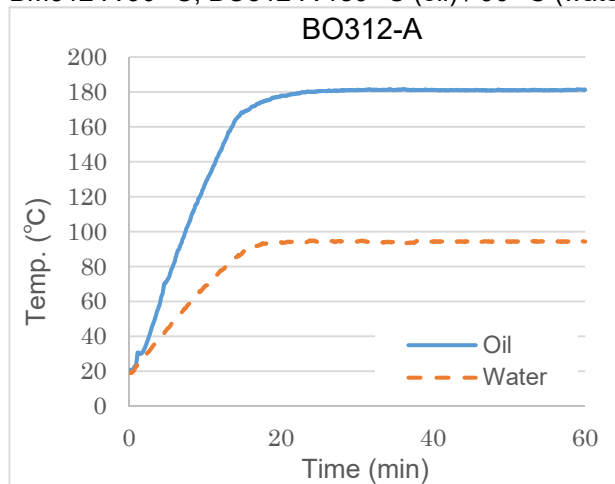
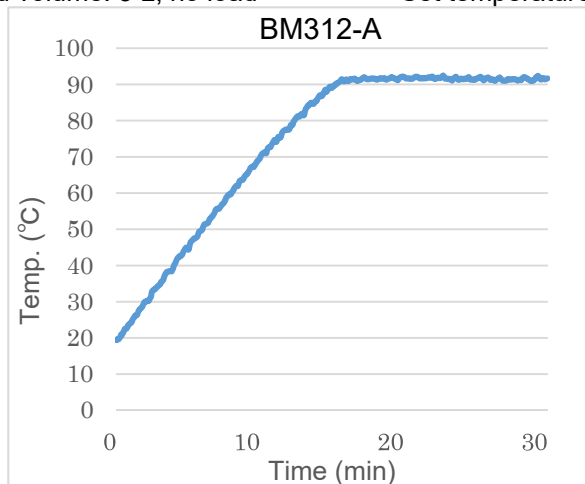

11. WIRING DIAGRAM

BM302-A/BO302-A

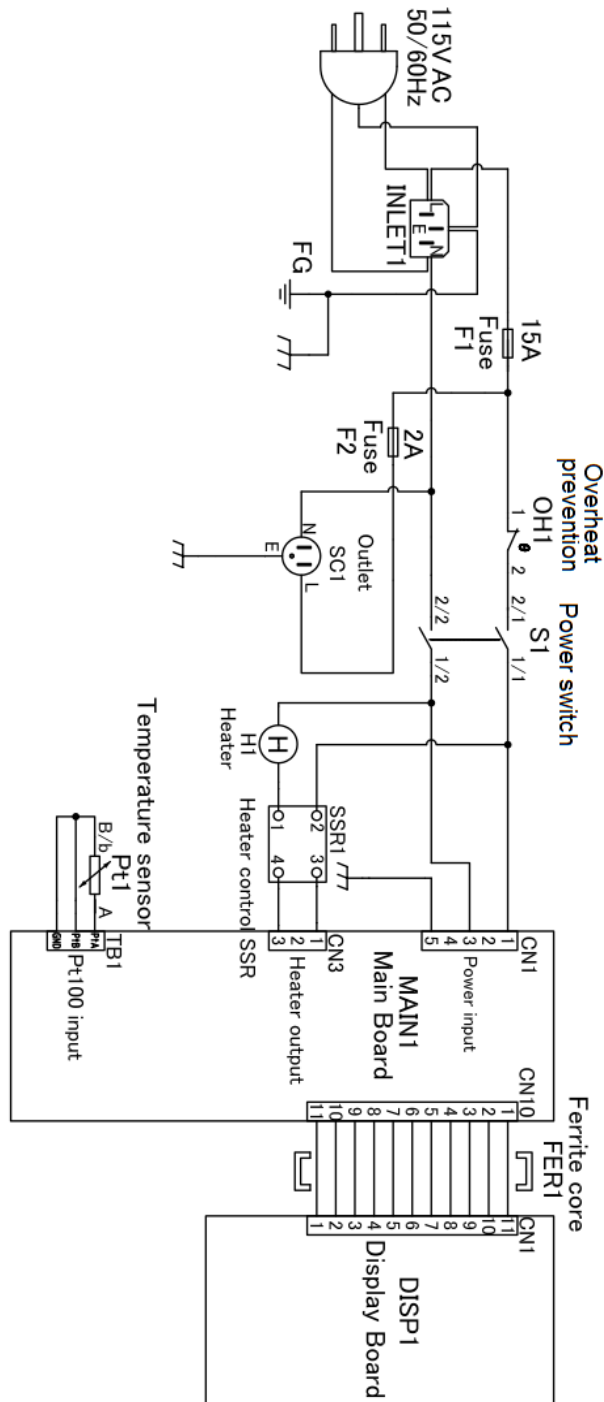

Symbol	Component	Symbol	Component
INLET1	Power inlet	SSR1	SSR for heater control
F1	Main power fuse	H1	Heater
F2	Service outlet fuse	Pt1	Temperature sensor
OH1	Overheat prevention device	MAIN1	CPU board
SC1	Service outlet	DISP1	Display Board
S1	Power switch	FER1	Ferrite core

11. WIRING DIAGRAM

BM312-A/BO312-A

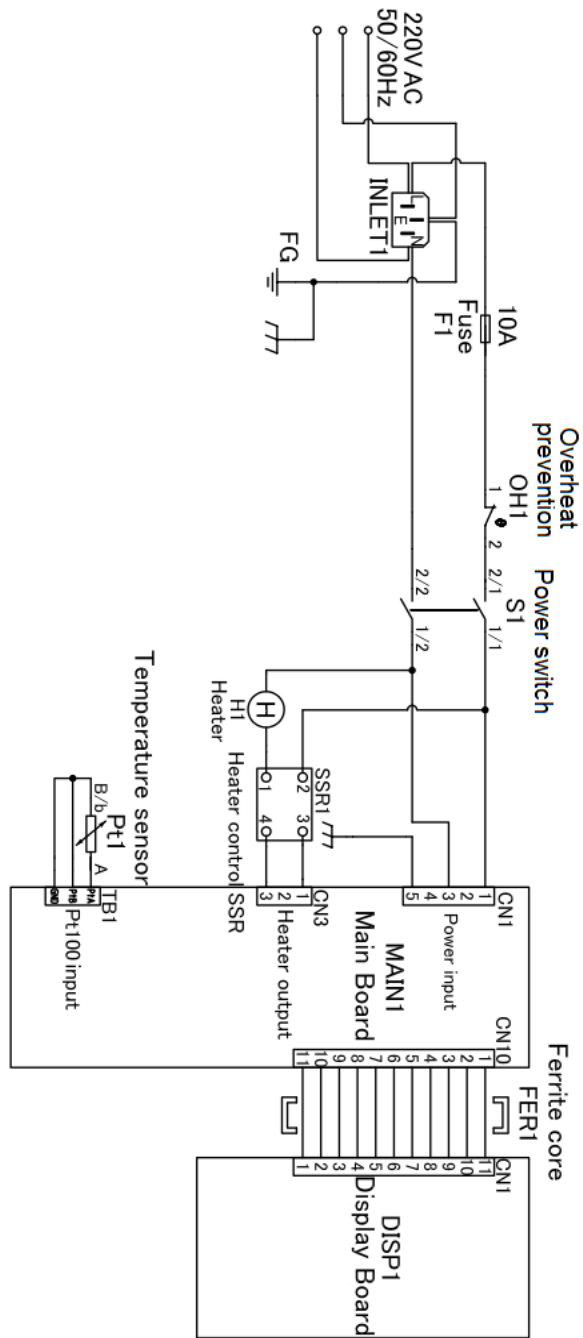

Symbol	Component	Symbol	Component
INLET1	Power inlet	SSR1	SSR for heater control
F1	Main power fuse	H1	Heater
OH1	Overheat prevention device	Pt1	Temperature sensor
S1	Power switch	MAIN1	CPU board
FER1	Ferrite core	DISP1	Display Board

12. REPLACEMENT PARTS LIST

BM302-A/BO302-A

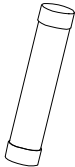
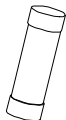
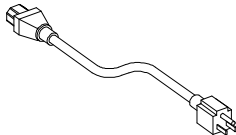
Part name		Part code	Standard	Manufacturer
Main power fuse 15 A (large)		LT00039643	250 V 15 A	Yamato Scientific
Service outlet fuse 2 A (small)		LT00039642	250 V 2 A	Yamato Scientific
Power cable		LT00039650	With a plug, 3 m	Yamato Scientific

BM312-A/BO312-A

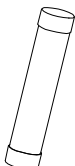
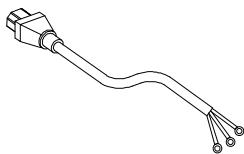
Part name		Part code	Standard	Manufacturer
Main power fuse 10 A (large)		LT00039644	250 V 10 A	Yamato Scientific
Power cable		LT00039652	With ring terminals, 3 m	Yamato Scientific

13. LIST OF HAZARDOUS SUBSTANCES



Never attempt to process explosives, flammables or any items which contain explosives or flammables.

Explosive substances	①Nitroglycol, Glycerine trinitrate, Cellulose Nitrate and other explosive nitrate esters
	②Trinitrobenzen, Trinitrotoluene, Picric Acid and other explosive nitro compounds
	③Acetyl Hydroperoxide, Methyl Ethyl Ketone Peroxide, Benzoyl Peroxide and other organic peroxides
	④Metallic Azide, including Sodium Azide, etc.
Combustible substances	①Metal "Lithium" ②Metal "Potassium" ③Metal "Natrium" ④Yellow Phosphorus ⑤Phosphorus Sulfide ⑥Red Phosphorus ⑦Phosphorus Sulfide ⑧Celluloids, Calcium Carbide (a.k.a, Carbide) ⑨Lime Phosphide ⑩Magnesium Powder ⑪Aluminum Powder ⑫Metal Powder other than Magnesium and Aluminum Powder ⑬Sodium Dithionous Acid (a.k.a., Hydrosulphite)
	①Potassium Chlorate, Sodium Chlorate, Ammonium Chlorate, and other chlorates
	②Potassium Perchlorate, Sodium Perchlorate, Ammonium Perchlorate, and other perchlorates
	③Potassium Peroxide, Sodium Peroxide, Barium Peroxide, and other inorganic peroxides
	④Potassium Nitrate, Sodium Nitrate, Ammonium Nitrate, and other nitrates
Oxidizing substances	⑤Sodium Chlorite and other chlorites
	⑥Calcium Hypochlorite and other hypochlorites
	①Ethyl Ether, Gasoline, Acetaldehyde, Propylene Chloride, Carbon Disulfide, and other substances having ignition point of 30 or more degrees below zero.
	②n-hexane, Ethylene Oxide, Acetone, Benzene, Methyl Ethyl Ketone and other substances with ignition point between 30 degrees below zero and less than zero.
	③Methanol, Ethanol, Xylene, Pentyl n-acetate, (a.k.a. amyl n-acetate) and other substances having ignition point of between zero and less than 30 degrees.
	④Kerosene, Light Oil, Terebinth Oil, Isopentyl Alcohol (a.k.a. Isoamyl Alcohol), Acetic Acid and other substances having ignition point of between 30 degrees and less than 65 degrees.
Flammable substances	
Combustible gas	Hydrogen, Acetylene, Ethylene, Methane, Ethane, Propane, Butane and other gases combustible at 15°C, ambient air pressure.

14. STANDARD INSTALLATION MANUAL

* Install this equipment according to following format (check options and special specifications separately)

Model	Serial Number	Installation Date	Charged Personnel or Company Name for Installation	Installation proved by	Judgment

No	Item	Implementation method	Chapter No. & Reference page of instruction manual	Judgment
Specifications				
1	Accessories	Quantity check according to the accessories column	10. SPECIFICATIONS P.31	
2	Installation	- Visual check of surrounding conditions Caution: Take care for environment - Securing a space	3. PRE-OPERATION PROCEDURES -Choose an appropriate... P.11	
		Put water/oil into the reservoir	3. PRE-OPERATION PROCEDURES -Heating medium P.13 -Supply of water/oil P.15	
Operation-related matters				
1	Power supply voltage	- Measure line voltage (power distribution board of facilities, outlet etc.) with a tester. - Measure line voltage during operation (must meet required voltage). Caution: Use a compliant device to install	1. SAFETY PRECAUTIONS -Ground wire MUST be ... P.3 -Handle power cable ... P.4 3. PRE-OPERATION PROCEDURES -Always connect ... P.12 10. SPECIFICATIONS -Power supply P.31	
2	Confirmation on operation	-Explain name and function of each component. -Implement an operation set temperature: 50°C	3. COMPONENT NAMES AND FUNCTIONS -Main Unit P.8-10 4. OPERATION PROCEDURES P.16-22	
Description				
1	Operational descriptions	Explain operations of each component and handling precautions according to instruction manual.	4. OPERATION PROCEDURES P.16-22 5. HANDLING PRECAUTIONS -Warnings and Cautions P.23 13. LIST OF HAZARDOUS SUBSTANCES -Table 15.1 List of ... P.36	
2	Error Codes	Explain about error codes and procedures for reset according to instruction manual.	8. TROUBLESHOOTING -Reading Error Codes P.28 -Troubleshooting Guide P.29	
3	Maintenance and Inspection	Explain about maintenance of equipment and each component according to instruction manual.	6. MAINTENANCE PROCEDURES P.26 -Inspection and Maintenance	
4	Completion of installation Matters to be Stated	-Enter the date of installation and name of the charged personnel in the main unit nameplate. -Write necessary information on warranty card and hand it over to customer -Explain how to contact with service personnel	9. SERVICE & REPAIR -Requests for Repair P.30	

Limited Liability

Always operate equipment in strict compliance to the handling and operation procedures set forth by this instruction manual.

Yamato Scientific Co., Ltd. assumes no responsibility for malfunction, damage, injury or death, resulting from negligent equipment use.

Never attempt to disassemble, repair or perform any procedure on BM/BO units which are not expressly mandated by this manual. Doing so may result in equipment malfunction, serious personal injury or death.

Notice

- Instruction manual descriptions and specifications are subject to change without notice.
- Yamato Scientific Co., Ltd. will replace flawed instruction manuals (pages missing, pages out of order, etc.) upon request.

Instruction Manual

Water Bath / Oil Bath

BM302-A/312-A BO302-A/312-A

First Edition: February 25, 2019

Revised:

Manufacturer

Yamato Scientific Co., Ltd.

Harumi Triton Square Office Tower Y (36F)

1-8-11 Harumi, Chuo-ku, Tokyo 104-6136, JAPAN

Yamato Scientific America Inc.

925 Walsh Avenue, Santa Clara,

CA 95050, U.S.A

<http://www.yamato-usa.com>

Toll Free: 1-800-2-YAMATO (1-800-292-6286)