

SINCE 1889



Vertical Pressure Steam Sterilizer

SM520/820

SM530/830

First Edition

- Thank you for purchasing SM series vertical pressure steam sterilizer of Yamato Scientific.
- To use this unit properly, read this "Instruction Manual" thoroughly before using this unit.
Keep this instruction manual around this unit for referring at anytime.

⚠ WARNING!:

Carefully read and thoroughly understand the important warning items described in this manual before using this unit.

Yamato Scientific America Inc.

Contents

1. Safety Precautions	1
Explanation	1
Table of Illustrated Symbols	2
Warning · Caution	3
2. Before Using	6
Installation precautions	6
Preparation before operation	10
3. Description and Function of Each Part	16
Main unit (front top back)	16
Main unit (internal structure)	17
Operation panel	18
4. Operation Method	19
Choose operation mode	19
Function list	20
Help function	22
User Set Function	23
Operation course (liquefy & retain temp.)	25
Operation course (sterilize & retain temp.)	34
Operation course (instrument sterilize)	43
Operation course (fluid sterilize)	49
Operation course (instrument dry)	55
Operation course (sterilize & dry)	61
Shortcut function (preheating)	69
Shortcut function (memory)	72
Shortcut function (schedule)	76
Shortcut function (initial setting value)	81
Shortcut function (optional connector)	82
External Output Terminal (optional)	83
5. Handling Precautions	85
6. Maintenance Method	88
Daily Inspection and Maintenance	88
7. Long storage and disposal	89
When not using this unit for long term / When disposing	89
Notes about disposal	89
8. In the Event of Failure	90
Safety Device and Error Code	90
Trouble Shooting	92
9. After-sales Service and Warranty	93
When need repair	93
10. Specification	94
11. Wiring Diagram	96
12. Piping Diagram	98
13. Replacement Parts Table	99
14. List of Dangerous Substances	101

15. Installation Standard Manual 102

16. Maintenance and Replacement 103

 Pressure gauge and safety valve 103

17. Regular Spot Check 104

 Regular self-checking of small pressure container 104

MEANING OF ILLUSTRATED SYMBOLS

Illustrated Symbols

Various symbols are used in this safety manual in order to use the unit without danger of injury and damage of the unit. A list of problems caused by ignoring the warnings and improper handling is divided as shown below. Be sure that you understand the warnings and cautions in this manual before operating the unit.

 **WARNING!** If the warning is ignored, there is the danger of a problem that may cause a serious accident or even fatality.

 **CAUTION!** If the caution is ignored, there is the danger of a problem that may cause injury/damage to property or the unit itself.

Meaning of Symbols



This symbol indicates items that urge the warning (including the caution). A detailed warning message is shown adjacent to the symbol.



This symbol indicates items that are strictly prohibited. A detailed message is shown adjacent to the symbol with specific actions not to perform.



This symbol indicates items that should be always performed. A detailed message with instructions is shown adjacent to the symbol.

1. Safety Precautions

Table of Illustrated Symbols

Warning



Warning,
high voltage



Warning,
high temperature



Warning,
drive train



Warning,
explosive

Caution



Caution,
generally



Caution,
electrical shock



Caution,
scald



Caution,
no load heating



Caution,
not to drench



Caution,
water only



Caution,
deadly poison

Prohibit



Prohibit,
generally



Prohibit,
inflammable



Prohibit,
to disassemble



Prohibit,
to touch

Compulsion



Compulsion,
generally



Compulsion,
connect to the
grounding
terminal



Compulsion,
install on a flat
surface

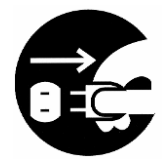

Compulsion,
disconnect the
power plug



Compulsion,
periodical
inspection

1. Safety Precautions

Warning • Caution

Warning



Do not use this unit in an area where there is flammable or explosive gas

Never use this unit in an area where there is flammable or explosive gas. This unit is not explosion-proof. An arc may be generated when the power switch is turned on or off, and fire/explosion may result. (Refer to page 104—14. List of Dangerous Substances)



Always ground this unit

Always ground this unit on the power equipment side in order to avoid electrical shock due to a power surge.



If a problem occurs

If smoke or strange odor should come out of this unit for some reason, turn off the circuit breaker right away, and then disconnect the power plug or power terminal. Immediately contact a service technician for inspection. If this procedure is not followed, fire or electrical shock may result. Never perform repair work yourself, since it is dangerous and not recommended.



Do not use the power cord if it is bundled or tangled

Do not use the power cord if it is bundled or tangled. If it is used in this manner, it can overheat and fire may be caused.



Do not process, bend, wring, or stretch the power cord forcibly

Do not process, bend, wring, or stretch the power cord forcibly. Fire or electrical shock may result.



Substances that can not be used

Never use explosive substances, flammable substances and substances that include explosive or flammable ingredients in this unit. Explosion or fire may occur. (Refer to page 104—14. List of Dangerous Substances)



Do not disassemble or modify this unit

Do not disassemble or modify this unit. Fire or electrical shock or failure may be caused.



Do not get close to the vapor outlet / Do not block the outlet

The vapor outlet is provided on the left face of equipment. Do not put your hands or face close to the outlet. Do not block the outlet. A burn injury or equipment failure may result in.

1. Safety Precautions

Warning • Caution

 **Caution**

 **When opening the cover...**

Make sure that the pressure of equipment has decreased to 0(zero) MPa before opening the cover. Generally the cover does not open due to the safety lock mechanism under the high pressure condition. The high-temperature and pressure vapor blows out if the cover is forced open under high pressure, which may cause a burn injury. A large amount of vapor blows out from inside of the chamber when opening the cover just after the sterilizing operation has completed (when the temperature inside the chamber is high). Do not put your hands and face close to the cover.

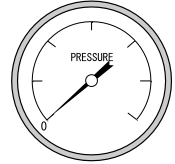

 **When draining water...**

Make sure that the pressure of equipment has decreased to 0(zero) MPa before draining the sterilizing water. The hot water blows out if the valve is opened under high pressure. The sterilizing water remains very hot just after the sterilizing operation has completed even the pressure reading is 0(zero) MPa. Drain the water after it is sufficiently cooled down.

 **Do not touch the drain bottle during operation**

A drain bottle, which contains hot water during and just after operation, is placed inside the door in the front face of equipment. To avoid a burn injury, remove the bottle after the water is sufficiently cooled down. Do not open the door during the operation of equipment.

 **Make sure to drain the water when the water level comes to the seal position**

The hot water or vapor may blow out from the drain bottle if the equipment is operated with too much drain water (water level above the seal position). (Refer to 15 of "Preparation before operation" in Page 13 for details.)

 **Securely fix the silicon plug of the drain bottle**

Securely fix the silicon plug when installing the drain bottle. The hot water or vapor may blow out from the drain bottle if the equipment is operated with the plug loosen. (Refer to 5 of "Preparation before operation" in Page **Error! Bookmark not defined.** for details.)

 **Do not touch the hot section**

Some sections on the equipment such as the circumference of cover or drain bottle are very hot during or just after the operation of equipment. Do not touch these sections to avoid burn injury.

1. Safety Precautions

Warning • Caution



Caution



When taking the sterile samples from the chamber...

Sufficiently remove the vapor inside the chamber before taking the sterile samples from the chamber. Wear heat-resistant leather gloves to take them from the chamber to protect your hands from high-temperature samples.



Do not touch the heat releasing outlet

Do not directly touch the heat releasing outlet located around the outer covering. The vapor may blow out from the safety valve by an accident during sterilizing operation. Do not block the outlet.



During a thunder storm

During a thunderstorm, turn off the power key immediately, then turn off the circuit breaker and the main power. If this procedure is not followed, fire or electrical shock may be caused.



When power failure occurs...

The lock lever on the cover goes into locked state for safety reasons when the power is turned off due to a power failure. The state is automatically cancelled when the power is turned on and the pressure inside the equipment decreases.



Do not operate the equipment without supplying sufficient amount of water

Do not operate the equipment without supplying sufficient amount of water. The heater is exposed to the open-air if the amount of water supplied is insufficient, which causes a deterioration or breakage of equipment. Make sure before operation that the appropriate amount of water is supplied inside the chamber. (Refer to 8 of "Preparation before operation" in Page 11 for details.)



Do not open the panel on the outer covering

Touching the interior portion of equipment may cause an electric shock, burn injury, fire disaster or equipment failure.



Do not touch the power plug with a wet hand

An electric shock may result in.



Do not place your hand over the top board

The hand may be stuck in the cover and injured.



Put samples after preheating

Do not open the cover during preheating due to steam pressure in cylinder. Before putting samples, press preheating key, switch the heater to OFF state, waiting for 20 seconds, open the cover after the cylinder pressure getting down.

2. Before Using

Installation precautions

1. Choose a proper place for installation

- ⊘ Do not install this unit in a place where:
 - ◆ Rough or dirty surface.
 - ◆ Flammable gas or corrosive gas is generated.
 - ◆ Ambient temperature 35°C and above or 5°C and below.
 - ◆ Atmospheric pressure without 70KPa~106KPa.
 - ◆ Altitude is higher than 3km.
 - ◆ Humidity is over 80%..
 - ◆ There is direct sunlight.
 - ◆ There is a constant vibration.
 - ◆ The power source is instable. (voltage fluctuation exceeds nominal voltage at $\pm 10\%$)
 - ◆ Pollution degree is over class 2.

- ❗ Install this unit on a stable place with the space as shown below.

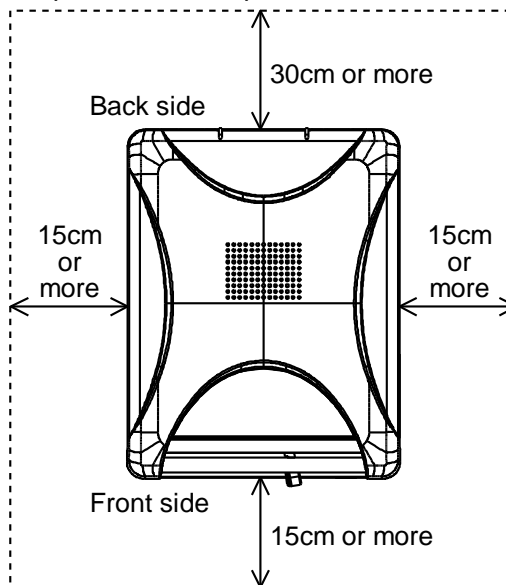

2. Installation on horizontal surface

Use the equipment on the horizontal and firm place to keep the water inside the chamber horizontal. If the equipment tilts and the heater appears from the water surface, the temperature on the area above the water rises and a heater failure or operation stop due to water level detector function may occur.

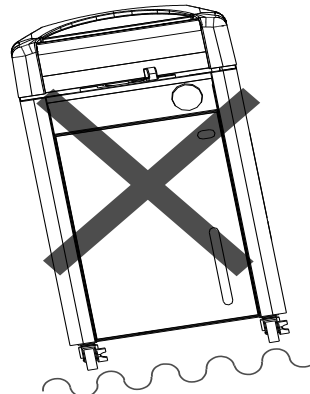

- ❗ The weight of main unit is approximately 110kg~140kg. Carry and install the equipment carefully by four or more persons.

2. Before Using

Installation precautions

3. Before/after installing



It may cause injury to a person if this unit falls down or moves by the earthquake and the impact. etc..To prevent, take measures that the unit cannot fall down, and not install at busy place.

4. Do not install the equipment near alarm device



The equipment releases large amount of vapor when the cover is opened just after the operation is completed. Accordingly, do not install the equipment on the site over which electrical equipment especially an alarm device is provided over it.

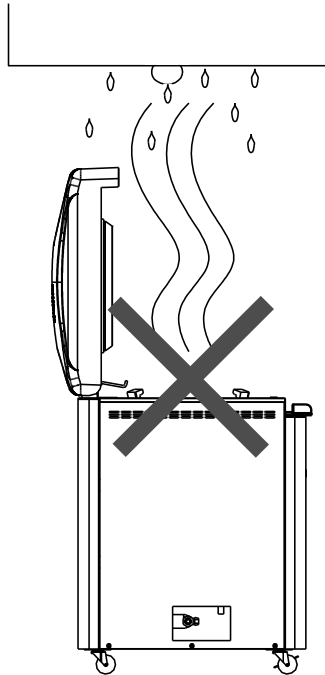

5. Ventilate the equipment sufficiently



Do not block the heat releasing outlets on the side face and back face of equipment during operation. The temperature inside the equipment rises, which may cause the deterioration or failure of equipment, accident, or fire disaster.

6. Do not use this unit in an area where there is flammable or explosive gas



Never use this unit in an area where there is flammable or explosive gas. This unit is not explosion-proof. An arc may be generated when the power switch is turned ON or OFF, and fire/explosion may result.



To know about flammable or explosive gas, refer to page 104—14. List of Dangerous Substances.

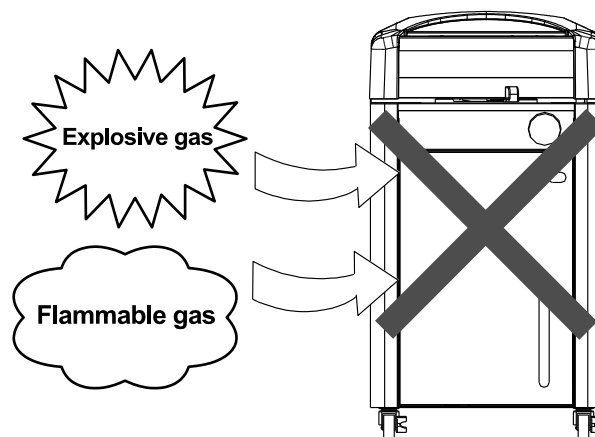

2. Before Using

Installation precautions

7. Choose a correct power distribution board or socket



Choose a correct power distribution board or socket that meets the unit's rated electric capacity

Operating voltage range for respective equipment models are as follows:

SM520 and SM820: AC100-120V

SM530 and SM830: AC200-240V

Electric SM520: AC100V-120V 20.5A-24.5A | SM530: AC200V-240V 10.5A-12.5A

capacity: SM820: AC100V-120V 20.5A-24.5A | SM830: AC200V-240V 10.5A-12.5A

- * There could be the case that the unit does not run even after turning ON the power. Inspect whether the voltage of the main power is lowered than the specified value, or whether other device(s) uses the same power line of this unit. If the phenomena might be found, change the power line of this unit to the other power line.
- * Connection with a branching receptacle or extended cable lowers electrical power voltage, which may cause the degradation of temperature adjusting capability.

8. Handling of power code



- Do not entangle the power cord. This will cause overheating and possibly a fire.
- Do not bend or twist the power cord, or apply excessive tension to it. This may cause a fire and electrical shock.
- Do not lay the power cord under a desk or chair, and do not allow it to be pinched in order to prevent it from being damaged and to avoid a fire or electrical shock.
- Keep the power cord away from any heating equipment such as a room heater. The cord's insulation may melt and cause a fire or electrical shock.







- If the power cord becomes damaged (wiring exposed, breakage, etc.), immediately turn off the power at the rear of this unit and shut off the main supply power. Then contact your nearest dealer for replacement of the power cord. Leaving it may cause a fire or electrical shock.
- Connect the power plug to the receptacle which is supplied appropriate power and voltage.

2. Before Using

Installation precautions

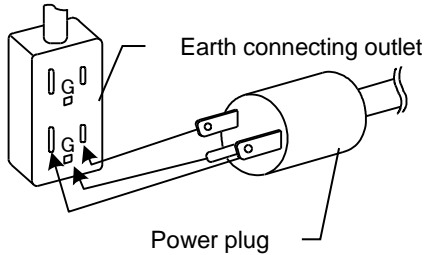
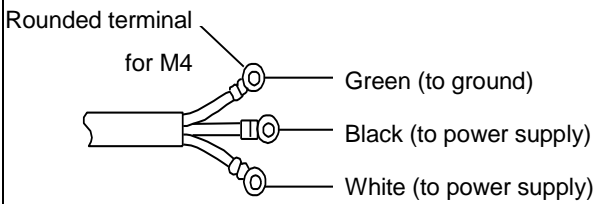
9. Always ground this unit

 <ul style="list-style-type: none"> The D class earth connecting works is required if no ground terminal is provided. In this case, consult with the selling office where you purchased or our sales office. 	 <ul style="list-style-type: none"> Securely connect the power plug to the switchboard or outlet.
<p style="text-align: center;">SM530/830</p>  <p style="text-align: center;">An earth connecting outlet is recommended to be used.</p>	<p style="text-align: center;">SM520/820</p>  <p style="text-align: center;">These models do not include the power plug. Correctly connect the ground to fit with the power supply facility to be connected.</p>
 <p>Do not connect the earth wire to gas or water pipes. If not, fire disaster may be caused.</p>	

10. Connect the power cord paying attention to the color of each core wire

 <p>When connecting the power cord, do check the breaker on the electric power equipment be "OFF".</p> <p>Note: SM520 and SM820 do not equip with the power plug. Select and connect the appropriate plug or terminal corresponding to the power capacity that is adjusted to the status of the power supply equipment side.</p>	<table border="1"> <thead> <tr> <th>Core Wire Color</th> <th>Interior Wiring</th> </tr> </thead> <tbody> <tr> <td>Brown</td> <td>Positive voltage</td> </tr> <tr> <td>Blue</td> <td>Negative voltage</td> </tr> <tr> <td>Yellow green</td> <td>Ground Wire Side</td> </tr> </tbody> </table>	Core Wire Color	Interior Wiring	Brown	Positive voltage	Blue	Negative voltage	Yellow green	Ground Wire Side
Core Wire Color	Interior Wiring								
Brown	Positive voltage								
Blue	Negative voltage								
Yellow green	Ground Wire Side								

2. Before Using

Preparation before operation

(1) **Determine the installation site**

If there is a bump on the floor, the casters may receive excessive load and get damaged. In this case, lift and move carefully by four or more persons.

Install the equipment referring to 1 to 5 of "Installation precautions" in Page **Error! Bookmark not defined.** and 7.

(2) **After the unit is placed in the desired position, lock the stopper button of the casters**

Only the two casters on the front side of the unit are equipped with a stopper.

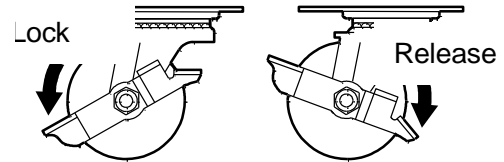

(3) **Connecting the power**

- Connect the power referring to 7 to 10 of "Installation precautions" in Page 8 and 9.

(4) **Open the cover**

- Turn on the electric leakage breaker at the right side of equipment and turn on the power to open the cover. The safety lock is released and the cover can be opened.
- Slide the lock lever on the cover to the right and grasp the handle of cover to open it.

Turn the lock lever to the left to close the cover.

Turn the lock lever to the right to open the cover.

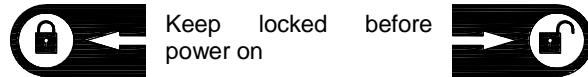

(5) **Pour water into the cooling water box**

- Pour 2000ml water into the cooling water box, 1-2mm higher than the red indicator line.
- After pouring water, please plug tightly the silicone stopper.

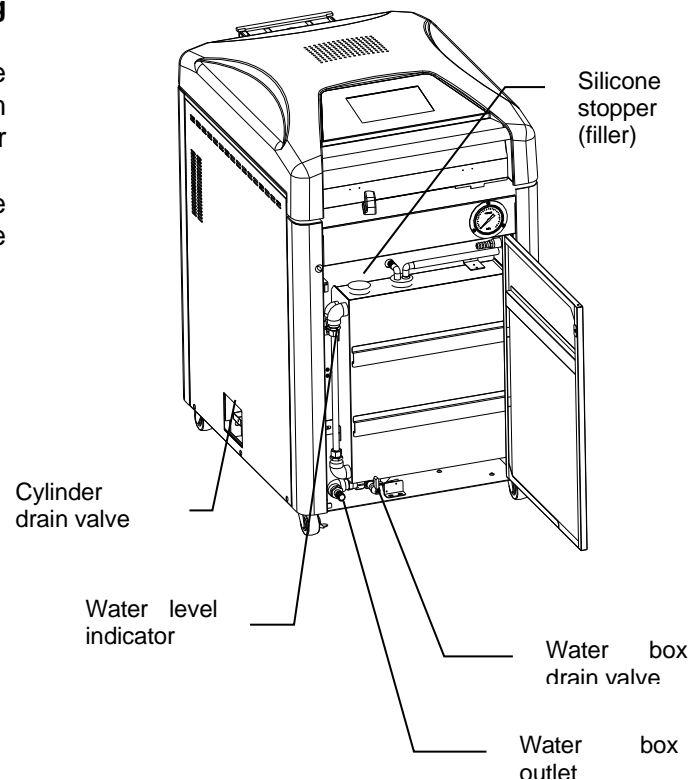

2. Before Using

Preparation before operation

(6) **Set the attached heater baffle onto the bottom surface inside the chamber**

- The heater baffle stabilizes the sterile samples inside the chamber as well as protects the heater and sensor. Make sure to set it.

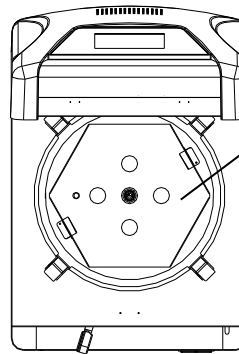

Set the heater baffle horizontally.

(7) **Close the drain valve**

- Close the drain valve at the bottom on the left side face of main unit. Water leak occurs if not fully closed, which may cause the burn injury or no-load (water) operation.
- Connect an appropriate hose (inner diameter: 12mm) to the rear water outlet and lead it to the draining site.

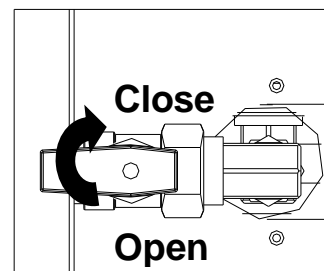

Water outlet

(8) **Pour water into the chamber**

- Before setting the sterile samples, pour water into the chamber to the water level gauge (notch) position.
- Insufficient water may cause the no-load (water) operation. Check the water level every time before operation. Refill it before the level becomes too low. Water is required to be poured at dissolution operation, as well as sterilizing operation.
- When the water level lowers, the equipment detects an abnormality ("Er20") and cuts off the heater. Depending on the conditions of equipment, however, the detection requires too much time, which may cause the heater deterioration. Refill water before the water level becomes too low.

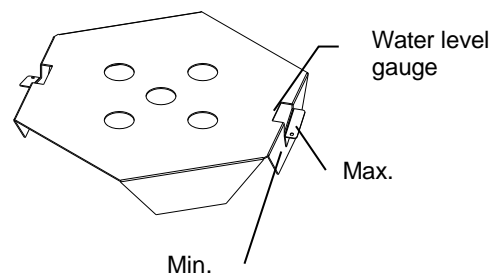

Water QTY for models

6500~6600 ml

(9) **Replace the water in cylinder**

- Fill distilled or purified water to conduct sterilization! Do not use tap water or well water directly!
- Confirm the water quality in cylinder before putting samples. If discolored or turbid, please clean the cylinder, and replace with new distilled or purified water!

2. Before Using

Preparation before operation

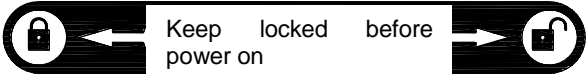
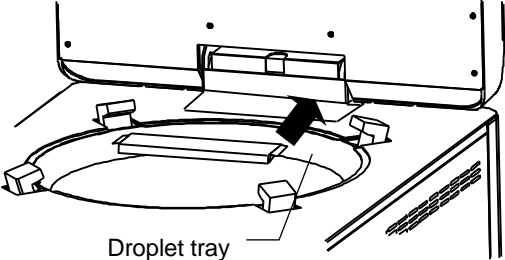
(10)	Set the sterile samples <ul style="list-style-type: none">• Set the samples to the chamber, putting them into the attached sample basket.• Put the sample or sterilization bag into the chamber so they should not block or cover the sensor inside the chamber, exhaust outlet and end connection to pressure gauge. If they are blocked or covered, the vapor cannot be discharged and the equipment cannot be operated correctly. Do not spill the samples when taking them out from/putting them into the chamber. The failure in piping system, bad smell or dirt may result in.• In case liquid such as medicinal solution or medium is sterilized, the amount of liquid should be 60% or less of the capacity of container. They may be boiled over if too much quantity is supplied.• Widely open the opening of sterilization bag when used. If it is closed, the samples are insufficiently sterilized.
(11)	Close the door before operation <ul style="list-style-type: none">• Make sure to close the door of equipment before operation. If the door is not fully closed, the cooling water box may be touched and may cause a burn injury. Do not open the door during operation.
(12)	Close the cover <ul style="list-style-type: none">• Make sure that no foreign objects exist on the packing of the cover and its contact area before closing the cover. If any foreign object exists, the vapor may leak from the inside.• Fully close the cover and slide the lock lever on the cover to the left side. If it is closed inappropriately, the vapor blows out from the inside, which may cause a burn injury.• Do not press the hook and operate the lock lever for purposes other than maintenance of equipment. <p>Turn the lock lever to the left to close the cover. Turn the lock lever to the right to open the cover.</p> 
(13)	Attach the droplet tray <ul style="list-style-type: none">• Attach the droplet tray to the equipment to prevent the water drops that are made from vapor that generate during air purge from dropping down from the packing onto the samples or onto the top board. Pour off the droplets inside the tray periodically.  <p>Droplet tray</p>

2. Before Using

Preparation before operation

(14)	Precautions for drainage <ul style="list-style-type: none">• Before draining the water, make sure that the pressure, equipment temperature and water temperature inside the chamber have decreased sufficiently.
(15)	Precautions for continuous operation <ul style="list-style-type: none">• When operating the equipment continuously after sterilization is completed, leave the equipment for about 15 minutes with the cover opened to sufficiently lower the temperature inside the chamber and then close the cover. If the temperature is high, the cover may not close due to high internal pressure of chamber caused by residual steam.• Before operating the equipment, check the water level of cooling water box is lower than water level lower limit at 1-2mm. In case the water level of water box is above the drain level seal, drain the water until the water level comes to the water level gauge scale. The hot water or vapor may blow out from the cooling water box if the equipment is operated with too much drain water (above the seal position).

2. Before Using

Preparation before operation

Reference data

Sterilizing operation using disposal bag for biochemically dangerous object

- ① Open the opening of sterilization bag so the vapor can be easily entered into it. Secure the bag with a wire rack so it should not fall down during operation.
- ② The height of bag should be about two-thirds of chamber. If it is too high, the vapor cannot be easily entered into it, or it blocks the vapor outlet at the upper part of chamber, which may cause insufficient sterilization.
- ③ The preset temperature should be lower than the upper temperature limit of bag.
- ④ The preset time varies depending on the quality and quantity of sterile samples. Refer to the following data for the preset time.



During liquid sterilization

- ① If the sterilization temperature exceeds the boiling temperature of the liquid, (under atmosphere pressure) the boiling point of the liquid should not be lower than water boiling point minus 5°C (under atmosphere pressure, if the water boiling point is 100°C, the boiling point of the liquid should not be lower than 95°C).

During sterilization, the liquid should be encapsulated by vessel, and its volume should not exceed 80% of the vessel (to prevent gas expansion due to boiling which may result in explosion).

- Reference example of SM520 model at room temperature of 25°C

Sterile sample	Sterilization temperature	Sterilization time	Note
Gauze	121°C	30 min.	Dry gauze 2.8*3m*5
Petri dish	121°C	40 min.	30 Petri dish with a cover

- ❖ The data above, however, is used as reference. The actual sterile condition varies depending on the characteristics and quantity of samples or type of vessels to be used. Confirm the sterile condition by using the biological indicator or chemical indicator.

The use of the sterilization test card (amlessories)

- When use the sterilization test card, please insert card in the center of the sample.
- Operating temp.: 121 °C (attached sterilization test card is 121 °C)
- After the operation, please confirm the sterilization state at the sterilization test card

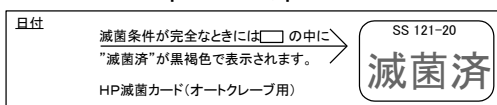

If poor sterilization, shallow dark brown 滅菌済 is shown in

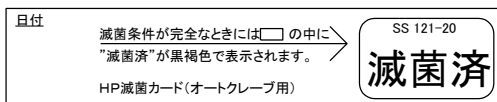

If normal sterilization, clear dark brown 滅菌済 is shown in

2. Before Using

Preparation before operation

Time lag

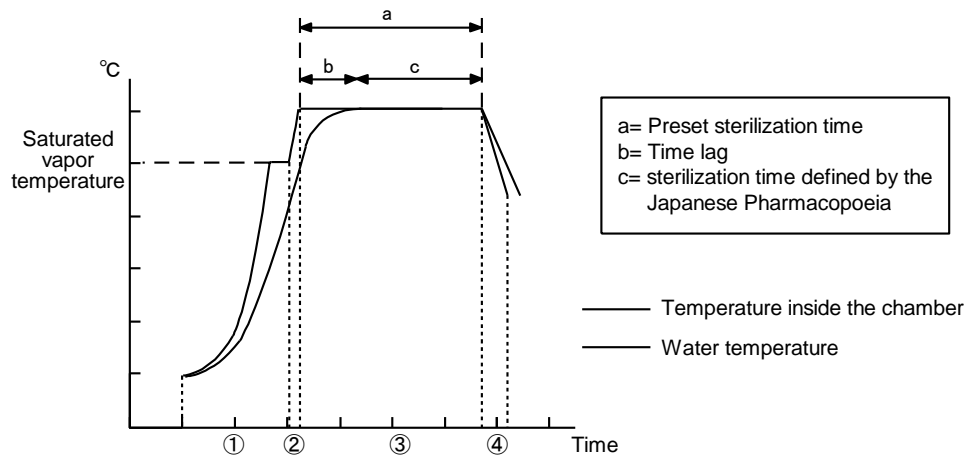

- Preset sterilization temperature: 121°C
- Room temperature: 25°C (using conical flask)

When sterilizing liquid samples, a time lag (b) is made between the temperature inside the chamber and actual temperature of liquid by the time when the liquid temperature reaches the preset sterilization temperature. For this reason, a longer time than defined by the Japanese Pharmacopoeia (c) is required to completely sterilize the samples. Consequently, the actual preset sterilization time (a) should be set to be extended.

The right table shows the time lag between the temperature inside the chamber and actual temperature of liquid (water). The table below shows the temperature rise and cooling time with no load (liquid).

	Time lag
Load	SM520/820
500ml	12min.
1000ml	15min.
2000ml	16min.
3000ml	20min.
4000ml	25min.
5000ml	30min.

3. Description and Function of Each Part

Main unit (front-top-back)

Front - top

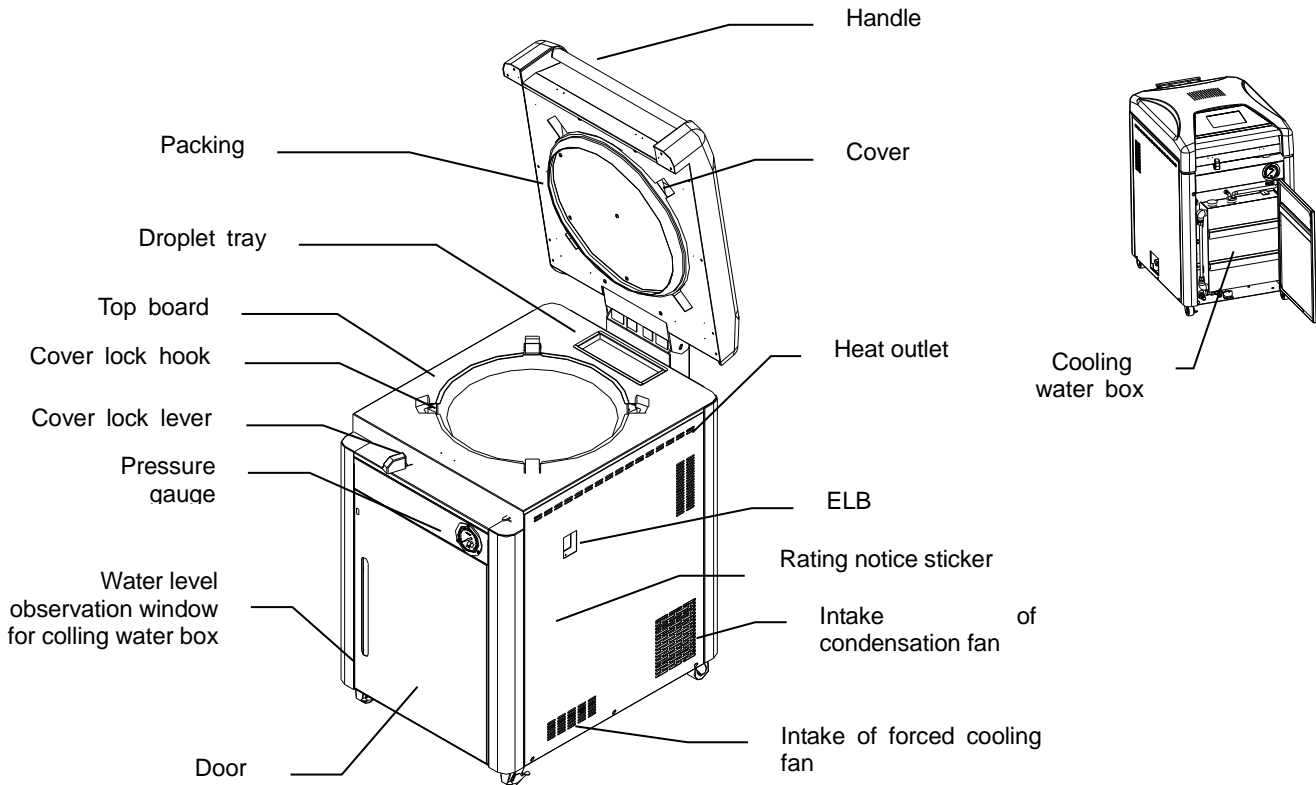

Back

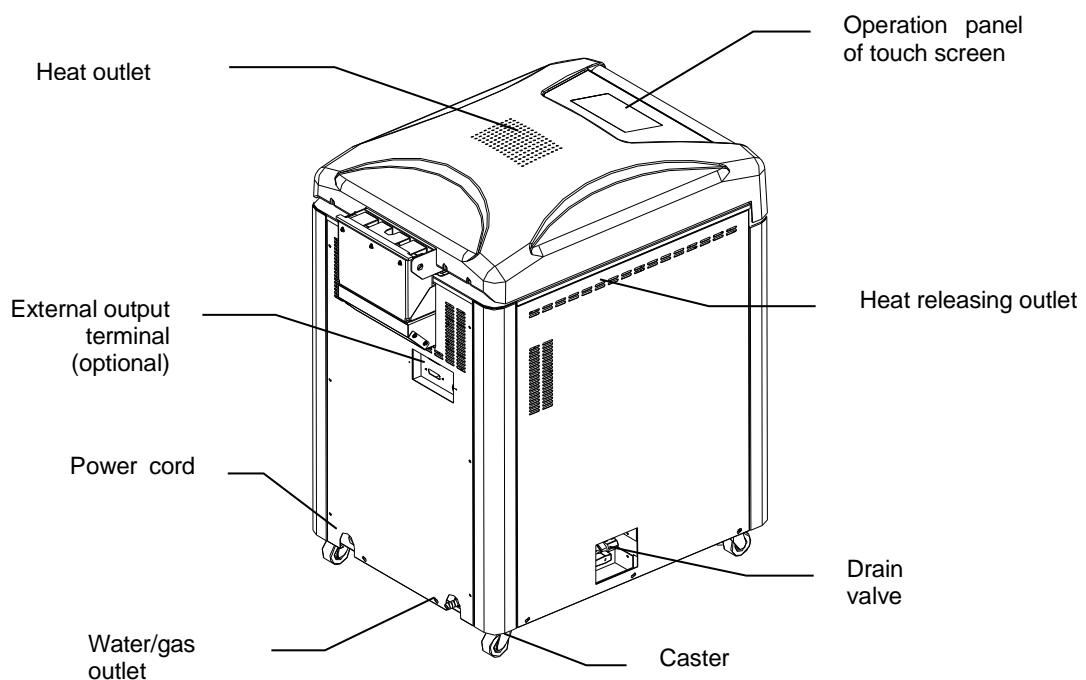

3. Description and Function of Each Part

Main unit (internal structure)

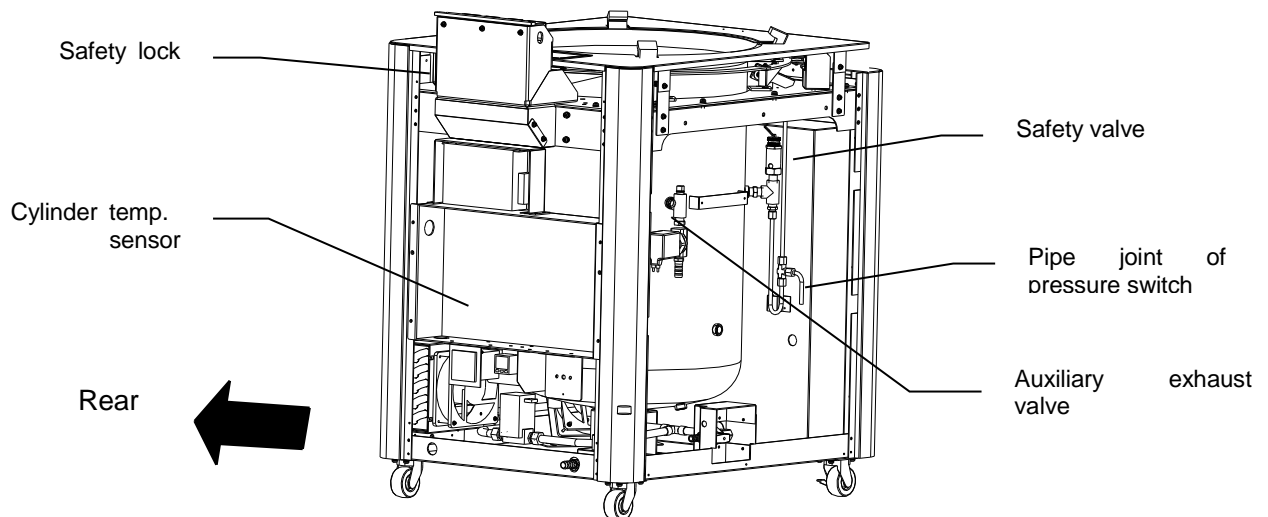
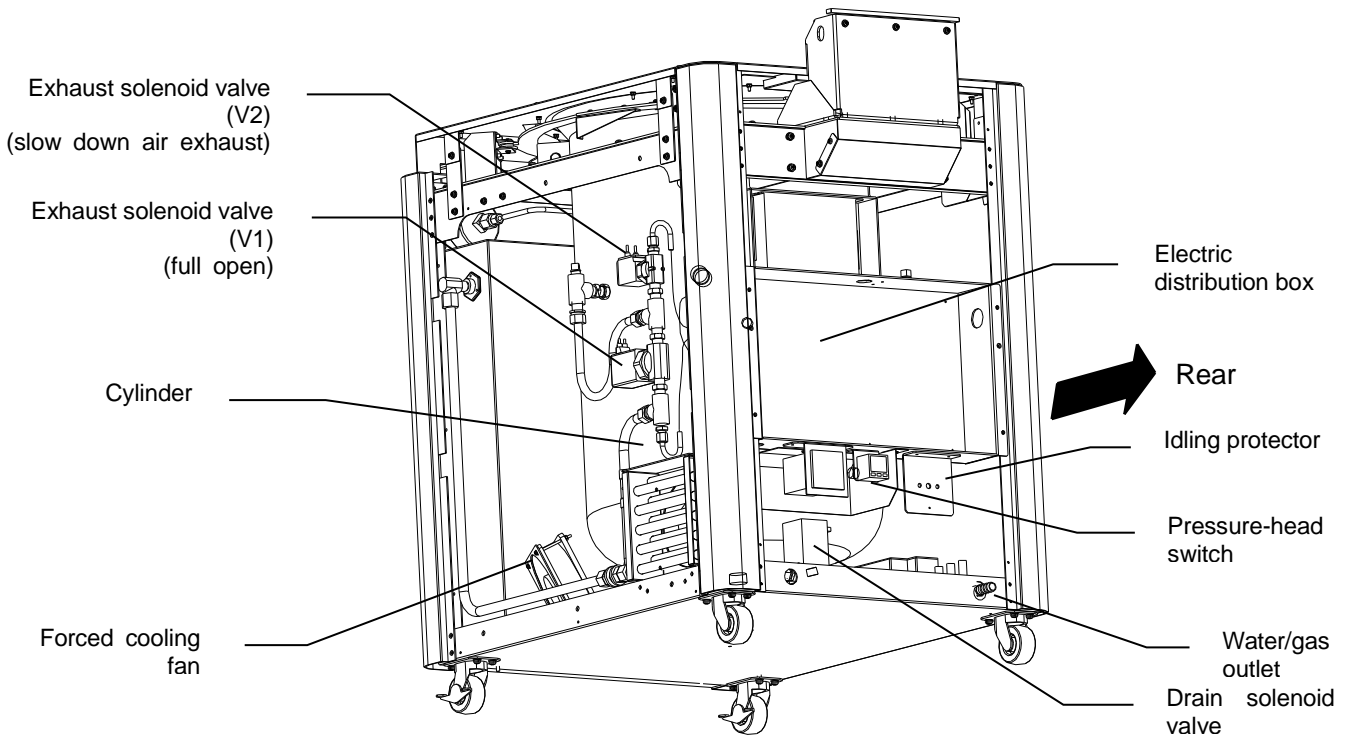

3. Description and Function of Each Part

Operation panel



No.	Name
1	Company LOGO
2	Product English name
3	Product model
4	Company English name
5	Software version No.

4. Operation Method

Choose operation mode

This product operation modes are as follows, please choose a proper mode.

Mode	Name	Usage
1	Instrument sterilize	Sterilize metal, glass, rubber and ceramic instruments
2	Fluid sterilize	Sterilize fluids such as water, culture media, test solutions, reagents, etc. (slow release valve prevents sudden boiling)
3	Sterilize & Retain temp.	Sterilize and keep culture media heated
4	Liquefy & Retain temp.	Liquefy and keep culture media heated
5	Instrument dry	Dry metal, glass, rubber and ceramic instruments
6	Sterilize & dry	Sterilize and dry metal, glass, rubber and ceramic instruments

Mode	Name	Course
1	Instrument sterilize	Heat → sterilize → air purge
2	Fluid sterilize	Heat → sterilize → air purge
3	Sterilize & Retain temp.	Heat → sterilize → air purge → retain temp.
4	Liquefy & Retain temp.	Heat → liquefy → retain temp.
5	Instrument dry	Heat → air purge → cool
6	Sterilize & dry	Heat → sterilize → air purge → drain → dry → cool

4. Operation Method

Function list

The equipment has the following functions:

No	Name	Description
1	Calendar setting	This function is included in the maintenance mode. It sets the dominical year, month, date and time.
2	Key lock function	This function is included in the maintenance mode. It disables all key operations, except the START/STOP key operation and cancellation of Key lock state. The “_Loc” is displayed if an unavailable key operation is done. (※)
3	Pattern lock function	This function is included in the maintenance mode. It disables the change related to operation course and memory. The “PLoc” is displayed if an unavailable key operation is done. (※)
4	Buzzer function	This function is included in the maintenance mode. It mutes the key operation sound except for the buzzer sounds at warning and operation end.
5	Error log display	This function is included in the maintenance mode. It displays up to 20 errors occurred in the past, including the error content and time of occurrence.
6	Setting of sample temperature sensor	This function is included in the maintenance mode. It enables the sample temperature function. If the setting is turned to ON when the optional sample sensor is not attached, the “Er.8”, which indicates disconnection of sample sensor, occurs.
7	Accumulated sterilization/dry/times/time	This function is included in the user set function.

4. Operation Method

Function list

No	Name	Description
8	Forced cooling function	<p>This function turns on the cooling fan during exhaust process to shorten the cooling time.</p> <p>The cooling fan is turned on during switching to the exhaust process in the instrument sterilize course. In other courses, it starts to run at the saturated vapor temperature of -2°C or less. It stops when the equipment goes into the standby state after operation is completed, or when the temperature inside the chamber reaches 60°C.</p> <p>The COOLING FAN key can be set anytime before and during operation of equipment.</p> <p>Pressing the COOLING FAN key lights the COOLING FAN lamp and makes the function available.</p>
9	Preheating function	<p>This function keeps the temperature of feed water inside the chamber with the preset temperature.</p> <p>The range of preset temperature is from 45°C to 80°C. The operation automatically ends after five hours.</p> <p>Pressing the PRE HEAT key lights the PRE HEAT lamp. The preset temperature is displayed with blinking. Set the desired value and then press the ENTER key. This enables the function.</p>
10	Memory function	<p>Each operation course has three memory banks, where registration and read of settings are possible. The following settings can be stored into the memory.</p> <ul style="list-style-type: none"> • Sterilize (liquefy) temp. • Sterilize (liquefy) time • Retain temp. temp. • Retain temp. time • Sterilize (dry) temp. • Sterilize (dry) temp. time • ON/OFF of forced cooling function
11	Schedule function	<p>This function automatically starts the operation of equipment at the specified time with the selected course.</p> <p>①The time can be set in increments of one minute within the range from 00 : 00 to 23 : 59, the same day is default set;</p> <p>②The time can be set in increments of one minute within the range from 00 : 00 to 23 : 59, year/month/date.</p>
12	Sample temperature function (optional)	<p>This function counts the sterilize/liquefy time by the temperature measured by the sample temperature sensor (optional).</p> <p>Pressing the SAMPLE key lights the SAMPLE lamp. The temperature display screen indicates the temperature measured with the sample temperature sensor.</p>
13	Temperature output terminal (optional)	<p>This function transmits and output the measured temperature of controller at 4~20 mA.</p>
14	Time up output terminal (optional)	<p>This function outputs the relay ("a" contact) at operation end.</p> <p>Contact spec: AC250V 1A (resistance load)</p>
15	Alarm output terminal (optional)	<p>This function outputs the relay ("a" contact) at warning of controller.</p> <p>Contact spec: AC250V 1A (resistance load)</p>

4. Operation Method

Help function

Help function

When the equipment is power on, at normal standby or operation state, this function is available!

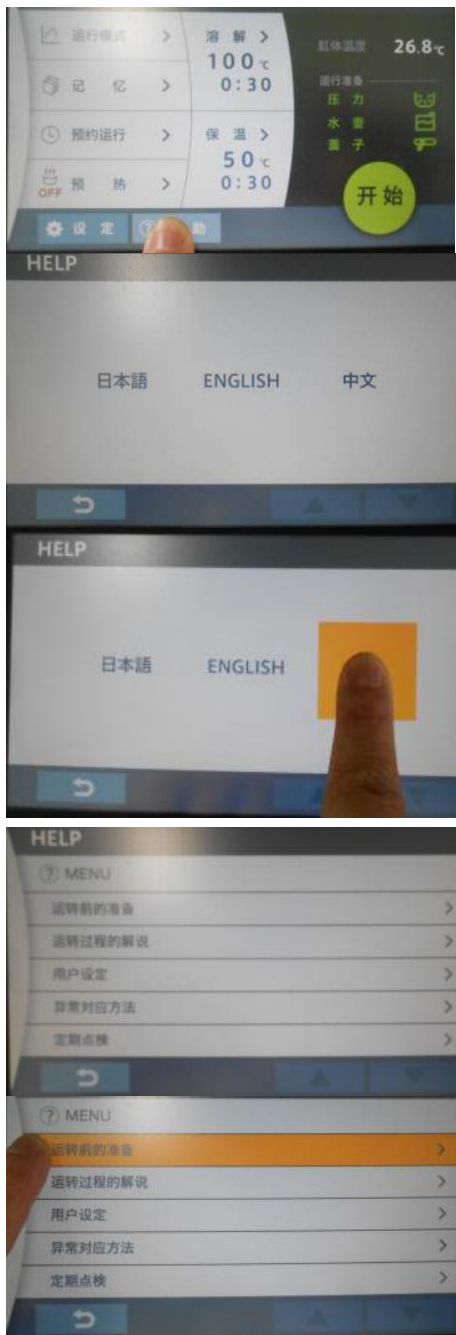

1. Use help function

Press  key to switch over the interface.

1.1 Language selection

Press  key to return, exit from help interface, and switch over to standby or operation interface.

1.2 Language selection

Press  key to select Chinese and switch over the interface.

1.3 HELP interface

Press  key to return, exit from help interface, and switch over to standby or operation interface.

2. Preparation before operation

Press *preparation before operation* item, the background color becomes yellow, switch over the interface, and enter into detailed introduction!
(explanation interface of operation course, user set interface, trouble shooting interface, regular spot check interface)

4. Operation Method

User Set Function

User set function

When the equipment is power on, at normal standby or operation state, this function is available!



1. Standby interface after the last operation ends

Press *** Set** key, switch over to user set mode interface 1.

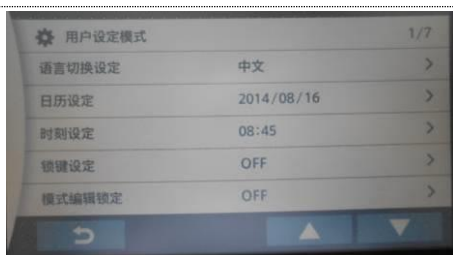

2.1 User set mode interface 1

Press **Return** to return to initial standby interface, switch over to standby or operation interface. Press **▲▼** for page turning.

Page content: Language (Chin, Eng and Jpn)

Calendar (calendar change)

Time (time change)

Key lock (lock the operation keys on operation interface except Set Help)

Mode edit lock (mode edit lock of memory interface)



2.2 User set mode interface 2

Page content: CO₂ consumption conversion factor

Buzzer set (ON/OFF)

Time set (time change)

Sample temp. sensor (ON/OFF)

Low analog scale setting 4mA temp. set

High analog scale setting 20mA temp. set



2.3 User set mode interface 3

Page content: Remote comm. ID

Remote comm. protocol

Remote comm. speed

Reply delay time

Parity

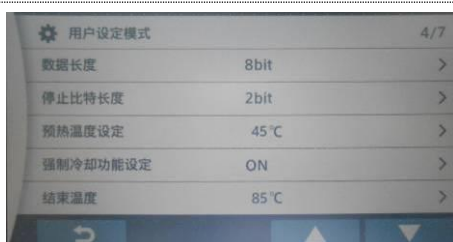

2.4 User set mode interface 4

Page content: Data length

Stop bit length

Preheat temp.

Forced cooling

End temp.

4. Operation Method

User Set Function

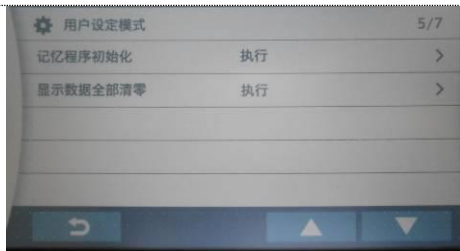

2.5 User set mode interface 5

Page content: Format memory program
Cumulative data reset



2.6 User set mode interface 6

Page content: Cumulative sterilization operation times
Cumulative dry operation times
Cumulative operation time
Cumulative power consumption
Cumulative CO₂ displacement

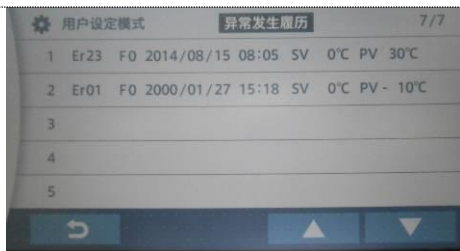

2.7 User set mode interface 7

Page content: Failure alarm (code, time, etc.) detailed list

4. Operation Method

Operation course (liquefy & retain temp.)

Follow the procedures below for the setting of liquefy & retain temp.:

1. Turn on the earth leakage breaker (switch ON).

Turn on the earth leakage breaker, touch screen displays the left interface for 3 secs, and then switch over to the next interface.



2. The touch screen displays the operation mode and program executed last time.

Sterilize & dry program: sterilize temp.121°C, sterilize time 10min. Dry temp.150°C, dry time 1h30min.

Current temp. in chamber 58.5°C,

Normal pressure (green character and icon)

Normal bottle (green character and icon)

Normal cover locking (green character and icon)

2.1 The touch screen displays the operation mode and program executed last time.

Press Operation mode area, the background color becomes yellow, switch over the interface

3. Mode selection interface

Sterilize & dry prog background color is blue that means it is the operation mode executed last time.

3.1 Mode selection interface

Press Liquefy & retain prog, the background color becomes yellow, switch over the interface

4. Operation Method

Operation course (liquefy & retain temp.)



3.2 Select operation mode

Press **Liquefy & retain prog** one time, the background color becomes blue, press green **开始** to confirm, switch over the interface to enter into liquefy & retain temp. interface.

4. Liquefy & retain temp. program interface

The liquefy & retain temp. program executed last time: liquefy 100°C, 10min; retain temp. 60°C, 20min.

4.1 Liquefy & retain temp. program interface

Press **Liquefy** area one time, the background color becomes yellow, switch over the interface.

5. Modify the liquefy setting

① No need to modify, press **取消** key to return to liquefy & retain temp. interface

5.1.1 Modify the liquefy setting

① Press temp. display area to modify the liquefy temp., the background color becomes yellow

4. Operation Method

Operation course (liquefy & retain temp.)



5.1.2 Modify the set liquefy temp.

The background color of temp. display area becomes blue, the numeric keypad is shown at right side, and the history set temp. value is shown at the top of keypad.

If no need to modify, press  key at right keypad to close the keypad.

5.1.3 Modify the set liquefy temp. value

① If type into wrong number, press CLR key to clear it

5.1.4 Numeric keypad input

Directly type into required numbers, it will display the max. available set value if exceed the range!

5.1.5 Modify the liquefy temp. value

① If no need to modify, press  key at right keypad to close the keypad.

② Type into required numbers at keypad, press green  to confirm.

5.1.6 Modify the liquefy temp. value

① After setting temp. value, the keypad will auto hide.

② If no need to modify liquefy time, press  key to return to liquefy & retain temp. interface

5.2.1 Modify the liquefy set interface

① Press time display area to modify the liquefy time, the background color becomes yellow

4. Operation Method

Operation course (liquefy & retain temp.)



5.2.2 Modify the liquefy time

The background color of time display area becomes blue, the numeric keypad is shown at right side, and the history set time value is shown at the top of keypad.

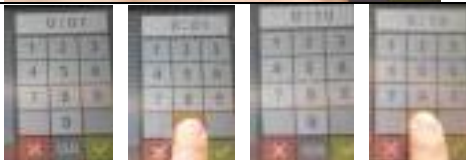

5.2.3 Numeric keypad input

Directly type into required numbers, it will display the max. available set value if exceed the range!



5.2.4. Modify the liquefy time value

If no need to modify, press  key at right keypad to close the keypad.



5.2.5. Modify the liquefy time value

Type into required numbers at keypad, press green  to confirm.

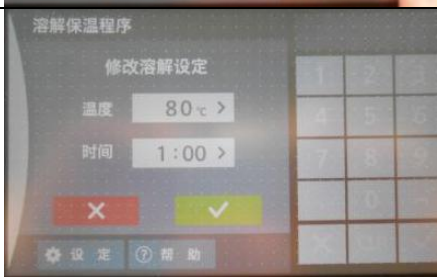

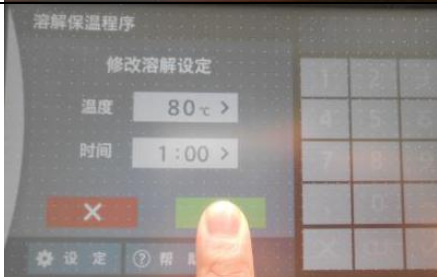

5.2.6 Modify the liquefy time value

①After setting time value, the keypad will auto hide.



5.3. Modify the liquefy time value

①If cancel modification, press  key to return to liquefy & retain temp. interface

②Press green  to confirm modification and return to liquefy & retain temp. interface

4. Operation Method

Operation course (liquefy & retain temp.)



6. Liquefy & retain temp. program interface

- ① Liquefy temp. and time parameters have been set!
Liquefy 80°C, 1h



6.1 Liquefy & retain temp. program interface

Press [Retain temp.] area one time, the background color becomes yellow, switch over the interface.



7. Modify the retain temp. setting

- ① No need to modify, press [X] key to return to liquefy & retain temp. interface



7.1.1 Modify the retain temp. setting

- ① Press temp. display area to modify the retain temp. setting, the background color becomes yellow



7.1.2 Modify the set retain temp. value

The background color of temp. display area becomes blue, the numeric keypad is shown at right side, and the history set temp. value is shown at the top of keypad.

If no need to modify, press [X] key at right keypad to close the keypad.



7.1.3 Modify the set retain temp. value

- ① If type into wrong number, press CLR key to clear it

4. Operation Method

Operation course (liquefy & retain temp.)

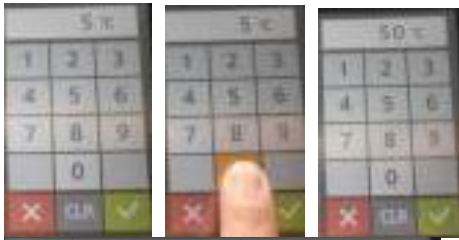

7.1.4. Liquefy & retain temp. program interface

Directly type into required numbers, it will display the max. available set value if exceed the range!

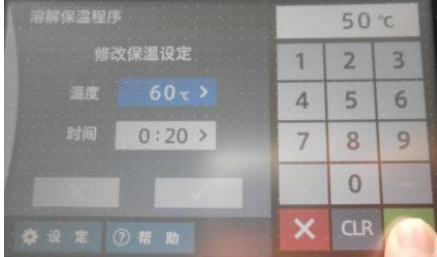

7.1.5 Modify the retain temp. value

① If no need to modify, press key at right keypad to close the keypad.

② Type into required numbers at keypad, press green to confirm.



7.1.6 Modify the retain temp. value

① After setting temp. value, the keypad will auto hide.

② If no need to modify retain temp. time, press key to return to liquefy & retain temp. interface



7.2.1 Modify the retain temp. set interface

① Press time display area to modify the retain temp. time, the background color becomes yellow



7.2.2 Modify the retain temp. time

The background color of time display area becomes blue, the numeric keypad is shown at right side, and the history set time value is shown at the top of keypad.

4. Operation Method

Operation course (liquefy & retain temp.)

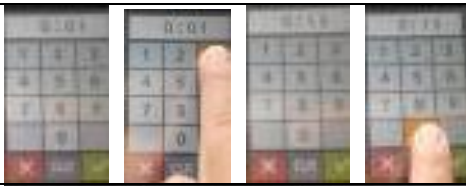

7.2.3 Numeric keypad input

Directly type into required numbers, it will display the max. available set value if exceed the range!



7.2.4. Modify the retain temp. setting

① If no need to modify, press key at right keypad to close the keypad.



7.2.5. Modify the retain temp. setting

Type into required numbers at keypad, press green to confirm.



7.2.6 Modify the retain temp. setting

① After setting time value, the keypad will auto hide.



7.3. Modify the liquefy setting

① If cancel modification, press key to return to liquefy & retain temp. interface

② Press green to confirm modification and return to liquefy & retain temp. interface



8. Liquefy & retain temp. program interface

The liquefy temp. and time, retain temp. temp. and time parameters have been finished setting.

4. Operation Method

Operation course (liquefy & retain temp.)



9. Liquefy & retain temp. program

Liquefy 80°C, 1h. Retain temp. 50°C, 1h30min

Current temp. in chamber 56.2°C

Normal pressure (green character and icon)

Normal bottle (green character and icon)

Normal cover locking (green character and icon)

Press the green START key one time to start operation! Temp. and time parameters cannot be changed in operation!



10. During operation of liquefy & retain temp. program

① Interface display setting: liquefy 80°C, 1h; retain temp. 50°C, 1h30min

② Current temp. in chamber 56.2°C

③ Running time 0h0min

④ During heating, heating curve segment indicates yellow

⑤ The green START key becomes red STOP key



10.1 Stop the operation of liquefy & retain temp. program

Press the red STOP key one time to stop.

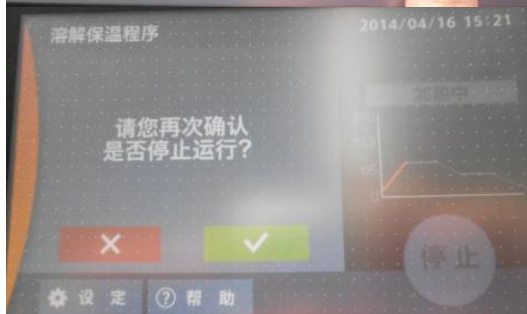

10.2 Stop the operation of liquefy & retain temp. program

Prompt box displays whether stop: press to confirm stop, and press to continue operation if misoperation.

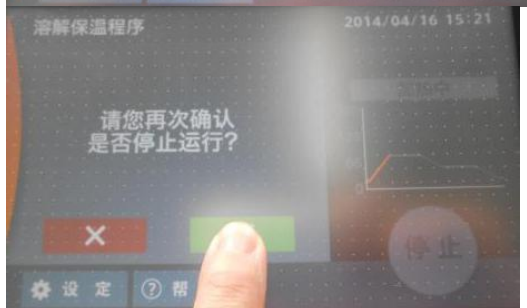

10.3 Stop the operation of liquefy & retain temp. program

Press to confirm to stop operation.



4. Operation Method

Operation course (liquefy & retain temp.)



10.4. Stop the operation of liquefy & retain temp. program

Prompt box of program operation stop

Note: when the chamber temp. is higher than finish temp.,  is gray and invalid; till it drops to finish temp.,  turn to be green, press it to end.

10.5 Stop the operation of liquefy & retain temp. program

Press  to confirm end

10.6 Stop the operation of liquefy & retain temp. program

The operation of liquefy & retain temp. program stops, able to unlock (red UNLOCK key appears)

11. Unlock the operation ring

Press UNLOCK key to unlock the operation ring, the top cover is able to open.

12. Enter into standby state

Press UNLOCK key to confirm, the equipment enters into standby state, the interface displays the program and parameters operated last time.

4. Operation Method

Operation course (sterilize & retain temp.)

Follow the procedures below for the setting of sterilize & retain temp.:



1. Turn on the earth leakage breaker (switch ON).

Turn on the earth leakage breaker, touch screen displays the left interface for 3 secs, and then switch over to the next interface.

2. The touch screen displays the operation mode and program executed last time.

Sterilize & retain temp. program: liquefy 100°C, 1h.
Retain temp. 50°C, 1h.

Current temp. in chamber 24.9°C,

Normal pressure (green character and icon)

Normal bottle (green character and icon)

Normal cover locking (green character and icon)

2.1 The touch screen displays the operation mode and program executed last time.

Press **Operation mode** area, the background color becomes yellow, switch over the interface.

3. Mode selection interface

Liquefy & retain temp. prog background color is blue that means it is the operation mode executed last time.

Press **Sterilize & retain temp. prog** one time, the background color becomes yellow, switch over the interface.

3.1 Mode selection interface

The background color of **Sterilize & retain temp. prog** becomes blue, it is the current operation mode.

4. Operation Method

Operation course (sterilize & retain temp.)



3.2 Select operation mode

The background color of **Sterilize & retain temp. prog** becomes blue.

Press green **开始** to confirm, switch over the interface to enter into liquefy & retain temp. interface.

Press **开始**, cancel setting, switch over the interface to return to liquefy & retain temp. interface.

4. Sterilize & retain temp. program interface

The sterilize & retain temp. program executed last time:

Sterilize 135°C, 1h; retain temp. 50°C, 1h

4.1 Sterilize & retain temp. program interface

Press **开始** area one time, the background color becomes yellow, switch over the interface.

5. Modify the sterilize setting

① No need to modify, press **开始** key to return to liquefy & retain temp. interface

5.1.1 Modify the sterilize setting

① Press temp. display area to modify the liquefy temp., the background color becomes yellow

4. Operation Method

Operation course (sterilize & retain temp.)



5.1.2 Modify the set sterilize temp.

The background color of temp. display area becomes blue, the numeric keypad is shown at right side, and the history set temp. value is shown at the top of keypad.

If no need to modify, press key at right keypad to close the keypad.

5.1.3 Modify the set sterilize temp. value

① If type into wrong number, press CLR key to clear it;

② Directly type into required numbers, it will display the max. available set value if exceed the range!

5.1.4 Modify the set sterilize temp. value

① If no need to modify, press key at right keypad to close the keypad.

② Type into required numbers at keypad, press green to confirm.

5.1.5 Modify the set sterilize temp. value

① After setting temp. value, the keypad will auto hide.

② If no need to modify liquefy time, press key to return to liquefy & retain temp. interface

5.2.1 Modify the sterilize set interface

① Press time display area to modify the time, the background color becomes yellow

4. Operation Method

Operation course (sterilize & retain temp.)



5.2.2 Modify the sterilize time

The background color of time display area becomes blue, the numeric keypad is shown at right side, and the history set time value is shown at the top of keypad.



5.2.3 Numeric keypad input

Directly type into required numbers, it will display the max. available set value if exceed the range!



5.2.4. Modify the sterilize setting

If no need to modify, press key at right keypad to close the keypad.



5.2.5. Modify the sterilize setting

① Type into required numbers at keypad, press green to confirm.
② After setting time value, the keypad will auto hide.



5.3. Modify the sterilize setting

① If cancel modification, press key to return to liquefy & retain temp. interface
② Press green to confirm modification and return to liquefy & retain temp. interface

4. Operation Method

Operation course (sterilize & retain temp.)



6. Sterilize & retain temp. program interface

- ① Sterilize temp. and time parameters have been set!
Sterilize 121°C, 30min

6.1 Sterilize & retain temp. program interface

Press [Retain temp.] area one time, the background color becomes yellow, switch over the interface.

7. Sterilize & retain temp. setting

- ① No need to modify, press [X] key to return to sterilize & retain temp. interface.

7.1.1 Modify the retain temp. setting

- ① Press temp. display area to modify the retain temp. setting, the background color becomes yellow

7.1.2 Modify the set sterilize value

The background color of temp. display area becomes blue, the numeric keypad is shown at right side, and the history set temp. value is shown at the top of keypad.

7.1.3 Modify the retain temp. value

- ① If no need to modify, press [X] key at right keypad to close the keypad.;
- ② If type into wrong number, press CLR key to clear it.



4. Operation Method

Operation course (sterilize & retain temp.)

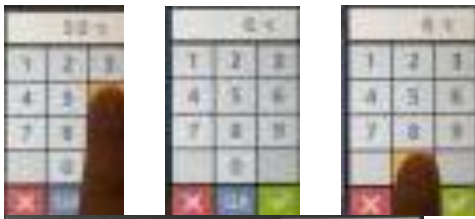



7.1.4. Liquefy & retain temp. program interface

Directly type into required numbers, it will display the max. available set value if exceed the range!



7.1.5 Modify the retain temp. value

① If no need to modify, press  key at right keypad to close the keypad.

② Type into required numbers at keypad, press green  to confirm.



7.1.6 Modify the retain temp. value

① After setting temp. value, the keypad will auto hide.

② If no need to modify retain temp. time, press  key to return to liquefy & retain temp. interface



7.2.1 Modify the retain temp. set interface

① Press time display area to modify the retain temp. time, the background color becomes yellow



7.2.2 Modify the retain temp. time

The background color of time display area becomes blue, the numeric keypad is shown at right side, and the history set time value is shown at the top of keypad.



4. Operation Method

Operation course (sterilize & retain temp.)

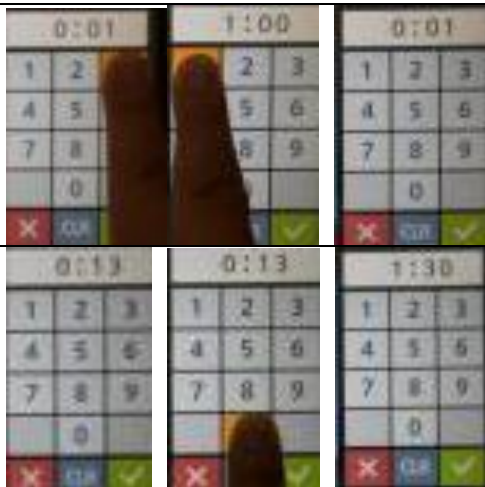

7.2.3 Numeric keypad input

Directly type into required numbers, it will display the max. available set value if exceed the range!
If cancel the modification, press key at right keypad to close the keypad.



7.2.4. Modify the retain temp. setting

Type into required numbers at keypad, press green to confirm.



7.2.5 Modify the retain temp. setting

①After setting time value, the keypad will auto hide.



7.3. Modify the retain temp. setting

①If cancel modification, press key to return to liquefy & retain temp. interface
②Press green to confirm modification and return to liquefy & retain temp. interface



8. Sterilize & retain temp. program interface

The sterilize temp. and time, retain temp. and time parameters have been finished setting.

4. Operation Method

Operation course (sterilize & retain temp.)



9. Sterilize & retain temp. program

Sterilize 121°C, 30min; Retain temp. 60°C, 1h30min

Current temp. in chamber 30°C

Normal pressure (green character and icon)

Normal bottle (green character and icon)

Normal cover locking (green character and icon)

Press the green START key one time to start operation! Temp. and time parameters cannot be changed in operation!

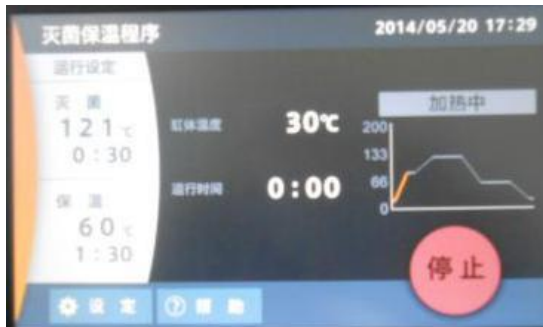

10. During operation of sterilize & retain temp. program

Interface display setting: sterilize temp.121°C, sterilize time 30min; retain temp. 60°C, 1h30min.

Current temp. in chamber 30°C. Running time 0h0min. During heating, heating curve segment indicates yellow.

The green START key becomes red STOP key.



10.1 Stop the operation of sterilize & retain temp. program

Press the red STOP key one time to stop. Prompt box displays whether stop: press to confirm stop, and press to continue operation if misoperation.

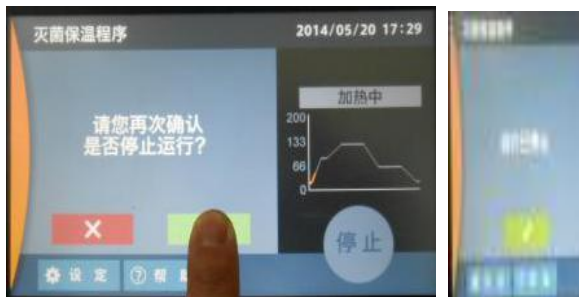

10.2 Stop the operation of sterilize & retain temp. program

Press to confirm to stop operation.



10.3 Stop the operation of sterilize & retain temp. program

Prompt box of program operation stop

Press to confirm end

4. Operation Method

Operation course (sterilize & retain temp.)



10.4 Stop the operation of sterilize & retain temp. program

The operation of liquefy & retain temp. program stops, able to unlock (red UNLOCK key appears)



10.5 End interface

Press UNLOCK key to unlock the operation ring, the top cover is able to open. The equipment enters into standby state, the interface displays the program and parameters operated last time.



11. Enter into standby state

Unlock the operation ring, the top cover is able to open

4. Operation Method

Operation course (instrument sterilize)

Follow the procedures below for the setting of instrument sterilize:



1. Turn on the earth leakage breaker (switch ON).

Turn on the earth leakage breaker, touch screen displays the left interface for 3 secs, and then switch over to the next interface.

2. The touch screen displays the operation mode and program executed last time.

Sterilize & retain temp. program: sterilize temp. 121°C, sterilize time 30min. retain temp. 60°C, retain temp. time 1h30min.

Current temp. in chamber 24.9°C,

Normal pressure (green character and icon)

Normal bottle (green character and icon)

Normal cover locking (green character and icon)

2.1 The touch screen displays the operation mode and program executed last time.

Press Operation mode area, the background color becomes yellow, switch over the interface



3. Mode selection interface

Liquefy & retain temp. prog background color is blue that means it is the operation mode executed last time.

Press Sterilize & retain temp. prog one time, the background color becomes yellow, switch over the interface.



3.1 Mode selection interface

The background color of Sterilize & retain temp. prog becomes blue, it is the current operation mode.



4. Operation Method

Operation course (instrument sterilize)



3.2 Select operation mode

The background color of **Sterilize & retain temp. prog** becomes blue.

Press green **开始** to confirm, switch over the interface to enter into liquefy & retain temp. interface.

Press **取消**, cancel setting, switch over the interface to return to liquefy & retain temp. interface.

4. Sterilize & retain temp. program interface

The sterilize & retain temp. program executed last time:

Sterilize 135°C, 1h; retain temp. 50°C, 1h

4.1 Sterilize & retain temp. program interface

Press **Sterilize** area one time, the background color becomes yellow, switch over the interface.

5. Modify the sterilize setting

① No need to modify, press **取消** key to return to liquefy & retain temp. interface

5.1.1 Modify the sterilize setting

① Press temp. display area to modify the liquefy temp., the background color becomes yellow

4. Operation Method

Operation course (instrument sterilize)



5.1.2 Modify the set sterilize temp.

The background color of temp. display area becomes blue, the numeric keypad is shown at right side, and the history set temp. value is shown at the top of keypad.

If no need to modify, press key at right keypad to close the keypad.

5.1.3 Modify the set sterilize temp. value

① If type into wrong number, press CLR key to clear it;

② Directly type into required numbers, it will display the max. available set value if exceed the range!

5.1.4 Modify the set sterilize temp. value

① If no need to modify, press key at right keypad to close the keypad.

② Type into required numbers at keypad, press green to confirm.

5.1.5 Modify the set sterilize temp. value

① After setting temp. value, the keypad will auto hide.

② If no need to modify liquefy time, press key to return to liquefy & retain temp. interface

5.2.1 Modify the sterilize set interface

① Press time display area to modify the time, the background color becomes yellow

4. Operation Method

Operation course (instrument sterilize)



5.2.2 Modify the sterilize time

The background color of time display area becomes blue, the numeric keypad is shown at right side, and the history set time value is shown at the top of keypad.



5.2.3 Numeric keypad input

Directly type into required numbers, it will display the max. available set value if exceed the range!



5.2.4. Modify the sterilize time setting

If no need to modify, press **X** key at right keypad to close the keypad.



5.2.5. Modify the sterilize setting

① Type into required numbers at keypad, press green **✓** to confirm.

② After setting time value, the keypad will auto hide.



5.3. Modify the sterilize setting

① If cancel modification, press **X** key to return to liquefy & retain temp. interface

② Press green **✓** to confirm modification and return to liquefy & retain temp. interface

4. Operation Method

Operation course (instrument sterilize)



6. Sterilize & retain temp. program

Sterilize 121°C, 30min; Retain temp. 60°C, 1h30min

Current temp. in chamber 30°C

Normal pressure (green character and icon)

Normal bottle (green character and icon)

Normal cover locking (green character and icon)

Press the green START key one time to start operation! Temp. and time parameters cannot be changed in operation!



7. During operation of sterilize & retain temp. program

Interface display setting: sterilize temp.121°C, sterilize time 30min; retain temp. 60°C, 1h30min.

Current temp. in chamber 30°C. Running time 0h0min.

During heating, heating curve segment indicates yellow. The green START key becomes red STOP key.



7.1 Stop the operation of sterilize & retain temp. program

Press the red STOP key one time to stop.

Prompt box displays whether stop: press to confirm stop, and press to continue operation if misoperation.



7.2 Stop the operation of sterilize & retain temp. program

Press to confirm to stop operation.



7.3 Stop the operation of instrument sterilize

Prompt box of program operation stop

Press to confirm end

4. Operation Method

Operation course (instrument sterilize)



7.4 Stop the operation of sterilize & retain temp. program

The operation of liquefy & retain temp. program stops, able to unlock (red UNLOCK key appears)

7.5 End interface

Press UNLOCK key to unlock the operation ring, the top cover is able to open. The equipment enters into standby state, the interface displays the program and parameters operated last time.

8. Enter into standby state

Unlock the operation ring, the top cover is able to open

4. Operation Method

Operation course (fluid sterilize)

Follow the procedures below for the setting of fluid sterilize:



1. Turn on the earth leakage breaker (switch ON).

Turn on the earth leakage breaker, touch screen displays the left interface for 3 secs, and then switch over to the next interface.

2. The touch screen displays the operation mode and program executed last time.

Instrument sterilize program: sterilize temp.126°C, sterilize time 30min

Current temp. in chamber 26°C,

Normal pressure (green character and icon)

Normal bottle (green character and icon)

Normal cover locking (green character and icon)

2.1 The touch screen displays the operation mode and program executed last time.

Press Operation mode area, the background color becomes yellow, switch over the interface

3. Mode selection interface

Instrument sterilize prog background color is blue that means it is the operation mode executed last time.

3.1 Mode selection interface

Press Fluid sterilize prog one time, the background color becomes yellow, switch over the interface.

4. Operation Method

Operation course (fluid sterilize)



3.2 Select operation mode

The background color of **Fluid sterilize prog** becomes blue.

Press green **Start** to confirm, switch over the interface to enter into fluid sterilize interface.

Press **Cancel**, cancel setting, switch over the interface to return to instrument sterilize interface.

4. Fluid sterilize program interface

The fluid sterilize program executed last time:
Sterilize temp. 135°C, sterilize time 1h

4.1 Fluid sterilize program interface

Press **Sterilize** area one time, the background color becomes yellow, switch over the interface.

5. Modify the sterilize setting

① No need to modify, press **Cancel** key to return to liquefy & retain temp. interface

4. Operation Method

Operation course (fluid sterilize)

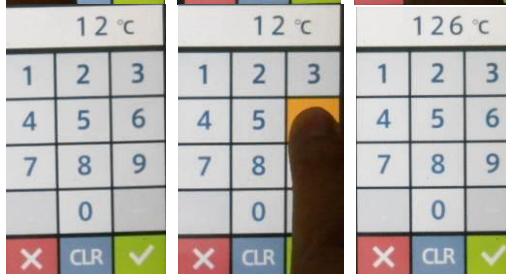

5.1.1 Modify the sterilize setting

① Press temp. display area to modify the liquefy temp., the background color becomes yellow

5.1.2 Modify the set sterilize temp.

The background color of temp. display area becomes blue, the numeric keypad is shown at right side, and the history set temp. value is shown at the top of keypad.

If no need to modify, press key at right keypad to close the keypad.

5.1.3 Modify the set sterilize temp. value

① If type into wrong number, press CLR key to clear it;

② Directly type into required numbers, it will display the max. available set value if exceed the range!

5.1.4 Modify the set sterilize temp. value

① If no need to modify, press key at right keypad to close the keypad.

② Type into required numbers at keypad, press green to confirm.

5.1.5 Modify the set sterilize temp. value

① After setting temp. value, the keypad will auto hide.

② If no need to modify liquefy time, press key to return to fluid sterilize interface.

5.2.1 Modify the sterilize set interface

① Press time display area to modify the time, the background color becomes yellow

4. Operation Method

Operation course (fluid sterilize)



5.2.2 Modify the sterilize time

The background color of time display area becomes blue, the numeric keypad is shown at right side, and the history set time value is shown at the top of keypad.



5.2.3 Numeric keypad input

Directly type into required numbers, it will display the max. available set value if exceed the range!



5.2.4. Modify the sterilize time setting

If no need to modify, press key at right keypad to close the keypad.



5.2.5. Modify the sterilize setting

- ① Type into required numbers at keypad, press green to confirm.
- ② After setting time value, the keypad will auto hide.



5.3. Modify the sterilize setting

- ① If cancel modification, press key to return to liquefy & retain temp. interface
- ② Press green to confirm modification and return to liquefy & retain temp. interface

4. Operation Method

Operation course (fluid sterilize)



6. Fluid sterilize program

Sterilize temp. 126°C, sterilize time 30min

Current temp. in chamber 28°C。

Normal pressure (green character and icon)

Normal bottle (green character and icon)

Normal cover locking (green character and icon)

Press the green START key one time to start operation! Temp. and time parameters cannot be changed in operation!

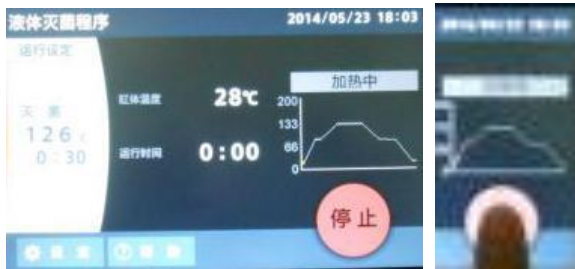

7. During operation of fluid sterilize program

Interface display setting: sterilize temp. 126°C, sterilize time 30min. Current temp. in chamber 30°C.

Running time 0h0min. During heating, heating curve segment indicates yellow.

The green START key becomes red STOP key.



7.1 Stop the operation of fluid sterilize program

Press the red STOP key one time to stop. Prompt box displays whether stop: press to confirm stop, and press to continue operation if misoperation.

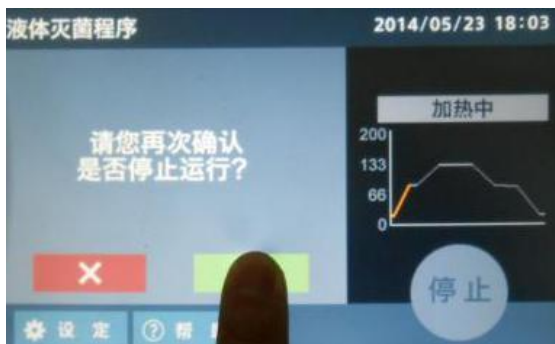

7.2 Stop the operation of fluid sterilize program

Press to confirm to stop operation.



7.3 Stop the operation of instrument sterilize

Prompt box of program operation stop

Press to confirm end

4. Operation Method

Operation course (fluid sterilize)



7.4 Stop the operation of sterilize & retain temp. program

The operation of liquefy & retain temp. program stops, able to unlock (red UNLOCK key appears)



7.5 End interface

Press UNLOCK key to unlock the operation ring, the top cover is able to open. The equipment enters into standby state, the interface displays the program and parameters operated last time.



8. Enter into standby state

Unlock the operation ring, the top cover is able to open

4. Operation Method

Operation course (instrument dry)

Follow the procedures below for the setting of instrument dry:



1. Turn on the earth leakage breaker (switch ON).

Turn on the earth leakage breaker, touch screen displays the left interface for 3 secs, and then switch over to the next interface.

2. The touch screen displays the operation mode and program executed last time.

Fluid sterilize program: sterilize temp.126°C, sterilize time 30min

Current temp. in chamber 26°C,

Normal pressure (green character and icon)

Normal bottle (green character and icon)

Normal cover locking (green character and icon)

2.1 The touch screen displays the operation mode and program executed last time.

Press Operation mode area, the background color becomes yellow, switch over the interface

3. Mode selection interface

Fluid sterilize prog background color is blue that means it is the operation mode executed last time.

3.1 Mode selection interface

Press Instrument dry prog one time, the background color becomes yellow, switch over the interface.

4. Operation Method

Operation course (instrument dry)



3.2 Select operation mode

The background color of **Instrument dry prog** becomes blue.

Press green **开始** to confirm, switch over the interface to enter into instrument dry interface.

Press **取消**, cancel setting, switch over the interface to return to fluid sterilize interface.

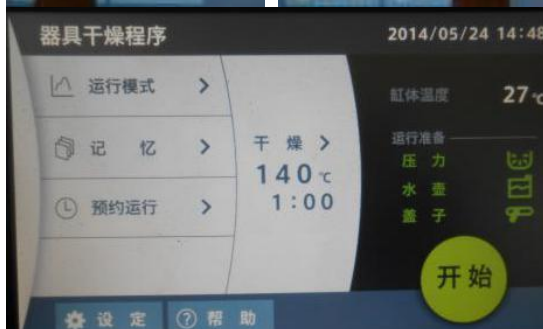

4. Instrument dry program interface

The instrument dry program executed last time:

Dry temp.140°C, sterilize time 1h



4.1 Instrument dry program interface

Press **干燥** area one time, the background color becomes yellow, switch over the interface.

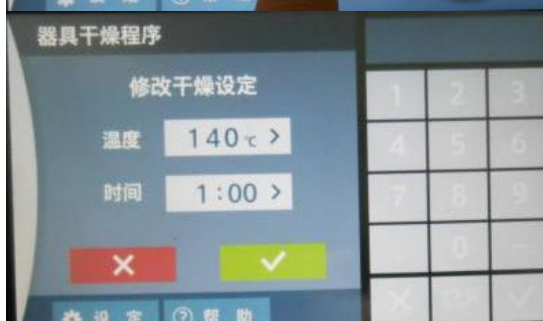

5. Modify dry temp. and time setting

① No need to modify, press **取消** or **返回** key to return to instrument dry program interface

4. Operation Method

Operation course (instrument dry)

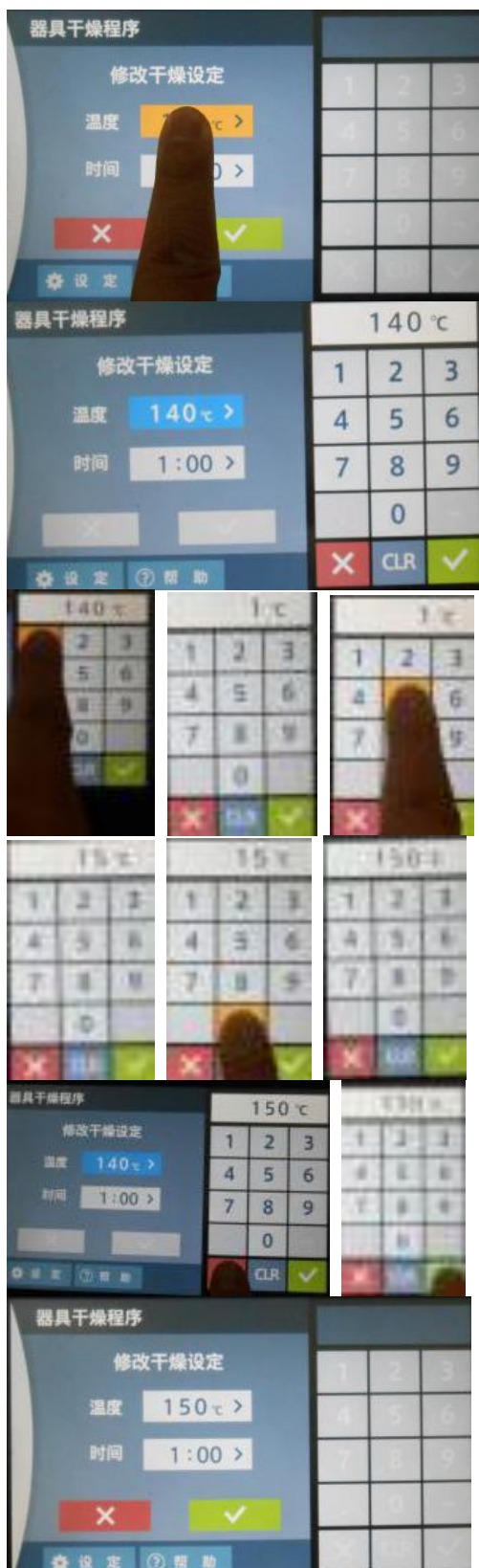

5.1.1 Modify dry temp. setting

① Press temp. display area to modify the dry temp., the background color becomes yellow

5.1.2 Modify the set sterilize temp.

The background color of temp. display area becomes blue, the numeric keypad is shown at right side, and the history set temp. value is shown at the top of keypad.

If no need to modify, press key at right keypad to close the keypad.

5.1.3 Modify dry temp. value

① If type into wrong number, press CLR key to clear it;

② Directly type into required numbers, it will display the max. available set value if exceed the range (120-150°C)!

5.1.4 Modify dry temp. value

① If no need to modify, press key at right keypad to close the keypad.

② Type into required numbers at keypad, press green to confirm, the keypad will auto hide.

5.1.5 Modify dry temp. value

① Press key to cancel modification, return to instrument dry program interface

② If no need to modify sterilize time, press key to confirm modification, return to instrument dry program interface.

4. Operation Method

Operation course (instrument dry)



5.2 Modify the dry time set interface

① Press time display area to modify the dry time, the background color becomes yellow



5.2.1 Modify the dry time setting

The background color of time display area becomes blue, the numeric keypad is shown at right side, and the history set time value is shown at the top of keypad.

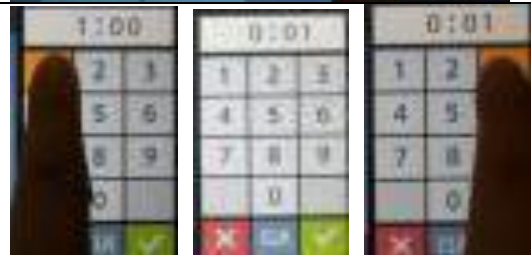

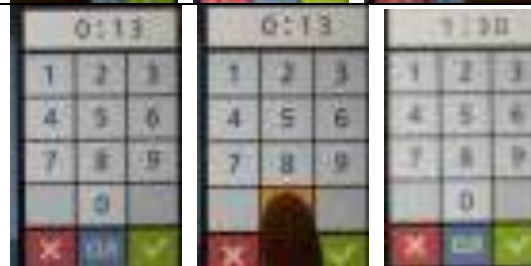

5.2.2 Numeric keypad input

① If type into wrong number, press CLR key to clear it;
② Directly type into required numbers, it will display the max. available set value if exceed the range (1min-999h)





5.2.4. Modify the dry time setting

① If no need to modify, press  key at right keypad to close the keypad.
② Type into required numbers at keypad, press green  to confirm
After setting time value, the keypad will auto hide.



5.3. Modify the dry time setting

① If cancel modification, press  key to return to liquefy & retain temp. interface
② Press green  to confirm modification and return to liquefy & retain temp. interface

4. Operation Method

Operation course (instrument dry)



6. Instrument dry program

Dry temp. 150°C, dry time 1h30min

Current temp. in chamber 28°C。

Normal pressure (green character and icon)

Normal bottle (green character and icon)

Normal cover locking (green character and icon)

Press the green START key to start operation! Mode, temp. and time parameters cannot be changed in operation!

7. Stop the operation of instrument dry program

Interface display setting: dry temp.150°C, dry time 1h30min. Current temp. in chamber 28°C.

Running time 0h0min. During heating, running stage curve indicates yellow.

The green START key becomes red STOP key.

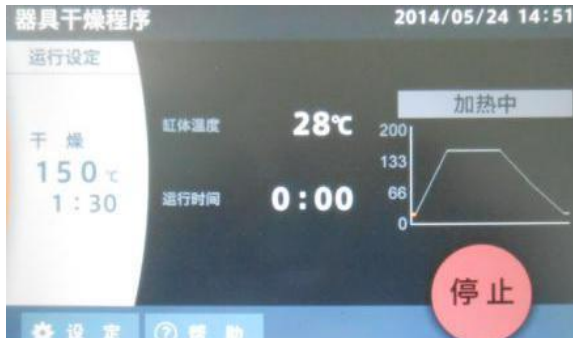

7.1 Stop the operation of instrument dry program

During heating, press STOP key.

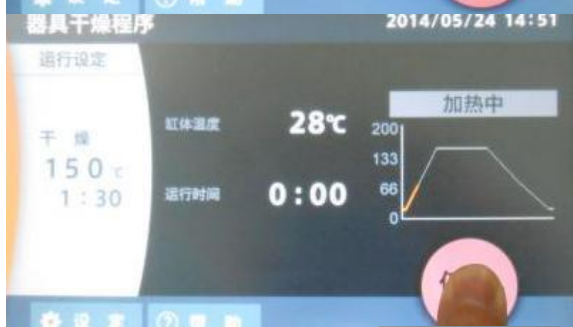

7.1.1 Stop the operation of instrument dry program

Prompt box displays whether stop: press to confirm stop, and press to continue operation if misoperation.



7.1.2 Stop the operation of instrument dry program

Press to confirm to stop operation.

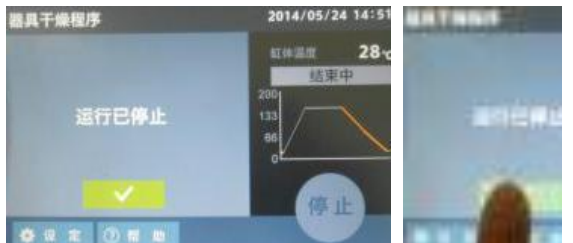

4. Operation Method

Operation course (instrument dry)



7.1.3 Stop the operation of instrument dry program

The operation of instrument dry program stops, able to unlock (red UNLOCK key appears)

7.1.4 End interface

Press UNLOCK key to unlock the operation ring, the top cover is able to open. The equipment enters into standby state, the interface displays the program and parameters operated last time.

8. Enter into standby state

Unlock the operation ring, the top cover is able to open

4. Operation Method

Operation course (sterilize & dry)

Follow the procedures below for the setting of sterilize & dry:



1. Turn on the earth leakage breaker (switch ON).

Turn on the earth leakage breaker, touch screen displays the left interface for 3 secs, and then switch over to the next interface.

2. The touch screen displays the operation mode and program executed last time.

Instrument dry program: dry temp.126°C, dry time 30min

Current temp. in chamber 26°C

Normal pressure (green character and icon)

Normal bottle (green character and icon)

Normal cover locking (green character and icon)

By default this mode and parameters can directly operate by pressing the START key!

2.1 The touch screen displays the operation mode and program executed last time.

Press **Operation mode** area, the background color becomes yellow, switch over the interface



3. Mode selection interface

Instrument dry prog background color is blue that means it is the operation mode executed last time.



3.1 Mode selection interface

Press **Sterilize & dry prog**, the background color becomes yellow, switch over the interface



4. Operation Method

Operation course (sterilize & dry)



3.2 Select operation mode

The background color of **Sterilize & dry prog** becomes blue.

Press green **√** to confirm, switch over the interface to enter into sterilize & dry interface.

Press **X**, cancel setting, switch over the interface to return to instrument dry interface.

4. Sterilize & dry program interface

The sterilize & dry program executed last time:

Sterilize temp. 135°C, sterilize time 1h

Dry temp. 140°C, dry time 1h

By default this mode and parameters can directly operate by pressing the START key!

5. Sterilize & dry program parameter setting

Press **Sterilize** area one time, the background color becomes yellow, switch over the interface.

5.1 Modify sterilize temp. and time setting

① No need to modify, press **X** or **√** key to return to sterilize & dry program interface

4. Operation Method

Operation course (sterilize & dry)



5.1.1 Modify the set sterilize temp.

The background color of temp. display area becomes blue, the numeric keypad is shown at right side, and the history set temp. value is shown at the top of keypad.

If no need to modify, press  key at right keypad to close the keypad.

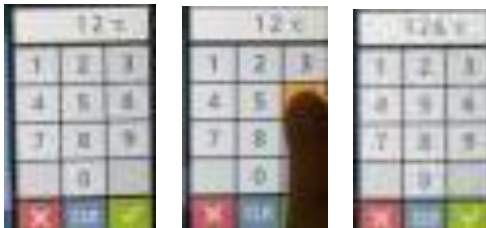

5.1.2 Modify the sterilize temp. value

① If type into wrong number, press CLR key to clear it;

② Directly type into required numbers, it will display the max. available set value if exceed the range (105-135°C)!



5.1.3 Modify the sterilize temp. value

① If no need to modify, press  key at right keypad to close the keypad.

② Type into required numbers at keypad, press green  to confirm.



5.1.4 Modify the sterilize temp. value

① After setting temp. value, the keypad will auto hide.

② If no need to modify sterilize time, press  key to return to sterilize & dry program interface



5.2 Modify the sterilize time setting

Press time display area to modify the sterilize time, the background color becomes yellow



5.2.1 Modify the sterilize time setting

The background color of time display area becomes blue, the numeric keypad is shown at right side, and the history set time value is shown at the top of keypad. (1h)

4. Operation Method

Operation course (sterilize & dry)

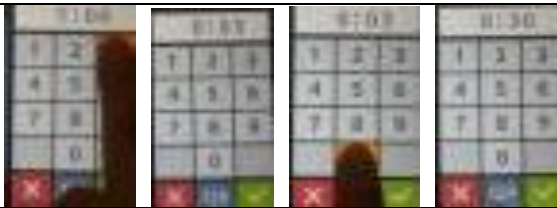

5.2.2 Numeric keypad input

Directly type into required numbers, it will display the max. available set value if exceed the range (1min-999h)!



5.2.3 Modify the sterilize time setting

- ① If no need to modify, press **X** key at right keypad to close the keypad.
- ② Type into required numbers at keypad, press green **✓** to confirm



5.2.4 Modify the sterilize setting

- ① After setting time value, the keypad will auto hide.
- ② Pop up confirmation interface of modification.



5.2.5 Sterilize setting interface

- ① If cancel modification, press **X** key to return to the sterilize & dry program interface before modification.
- ② Press green **✓** to confirm modification and return to the sterilize & dry program interface after modification.

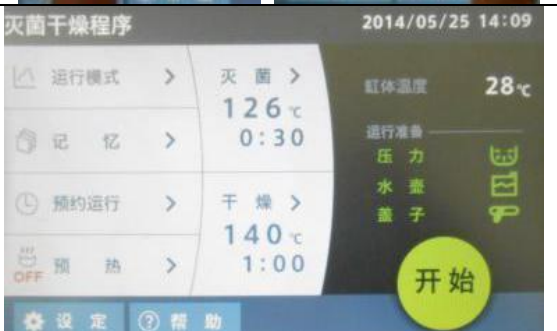

6. Sterilize & dry program interface after modifying parameters

Sterilize temp.126°C, sterilize time 30min;

Dry temp.140°C, dry time 1h

Current temp. in chamber 28°C

Normal pressure (green character and icon)

Normal bottle (green character and icon)

Normal cover locking (green character and icon)

By default this mode and parameters can directly operate by pressing the START key!

4. Operation Method

Operation course (sterilize & dry)



7. Sterilize & dry program interface

Press **Dry** area, the background color becomes yellow, switch over the interface.

7.1 Modify dry temp. and time setting

- ① If no need to modify, press **X** or **√** key to return to sterilize & dry program interface
- ② Press temp. display area to modify the dry temp. setting, the background color becomes yellow



7.1.1 Modify the set dry temp.

The background color of temp. display area becomes blue, the numeric keypad is shown at right side, and the history set temp. value is shown at the top of keypad.

If no need to modify, press **X** key at right keypad to close the keypad.



7.1.2 Modify the dry temp. value

- ① If type into wrong number, press CLR key to clear it;
- ② Directly type into required numbers, it will display the max. available set value if exceed the range (120-150°C)!



7.1.3 Modify the sterilize temp. value

- ① If no need to modify, press **X** key at right keypad to close the keypad.
- ② Type into required numbers at keypad, press green **√** to confirm.

4. Operation Method

Operation course (sterilize & dry)



7.1.4 Modify the dry temp. value

① After setting temp. value, the keypad will auto hide.

② If no need to modify the dry temp., press key to return to the sterilize & dry program interface before modification.



7.2 Modify the dry time setting

① Press time display area to modify the time, the background color becomes yellow

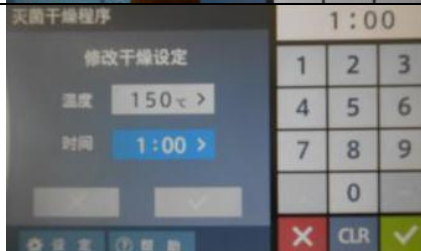

7.2.1 Modify the dry time setting

The background color of time display area becomes blue, the numeric keypad is shown at right side, and the history set time value is shown at the top of keypad.

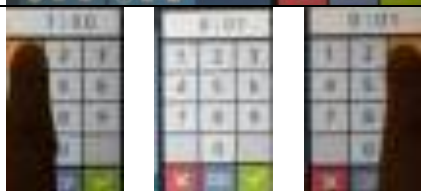

7.2.2 Numeric keypad input

① If type into wrong number, press CLR key to clear it;

② Directly type into required numbers, it will display the max. available set value if exceed the range (1min-999h)

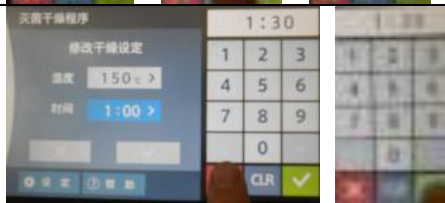
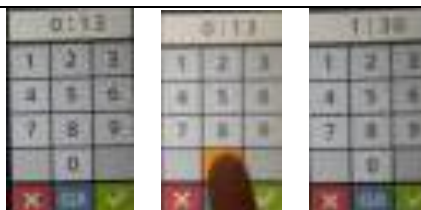

7.2.3 Modify the sterilize time setting

① If no need to modify, press key at right keypad to close the keypad.

② Type into required numbers at keypad, press green to confirm, the keypad will auto hide.

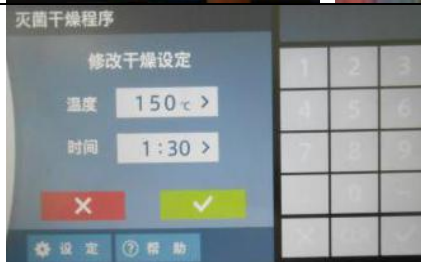

4. Operation Method

Operation course (sterilize & dry)



7.3. Modify the dry setting

- ① If cancel modification, press key to return to the sterilize & dry program interface before modification.
- ② Press green to confirm modification and return to the sterilize & dry program interface after modification.

8. Sterilize & dry program

Sterilize temp. 126°C, sterilize time 30min;
Dry temp. 150°C, dry time 1h30min
Current temp. in chamber 29°C
Normal pressure (green character and icon)
Normal bottle (green character and icon)
Normal cover locking (green character and icon)

**Press the green START key to start operation!
Mode, temp. and time parameters cannot be changed in operation!**



9. During operation of sterilize & dry program

Interface display setting: sterilize temp. 126°C, sterilize time 29min. Current temp. in chamber 29°C.

Running time 0h0min. During heating, running stage curve indicates yellow.

The green START key becomes red STOP key.

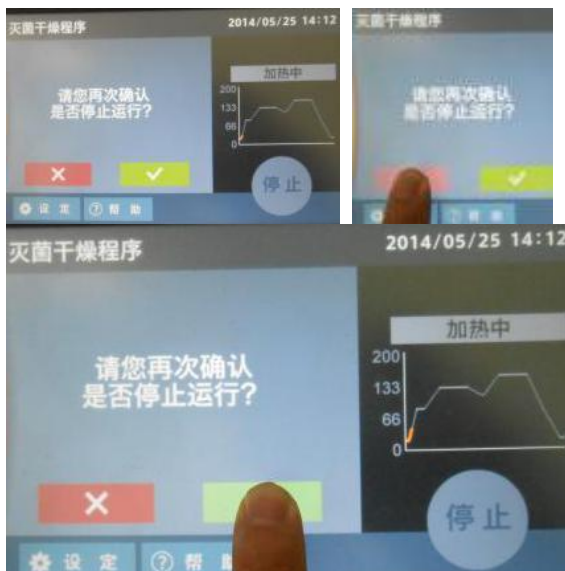

9.1.1 Stop the operation of sterilize & dry program

Prompt box displays whether stop: press to confirm stop, and press to continue operation if misoperation.

4. Operation Method

Operation course (sterilize & dry)



9.1.2 Stop the operation of sterilize & dry program

Press  to confirm to stop operation.



9.2 Stop the operation of sterilize & dry program

The operation of sterilize dry program stops, able to unlock (red UNLOCK key appears)



9.3 End interface

Press UNLOCK key to unlock the operation ring, the top cover is able to open. The equipment enters into standby state, the interface displays the program and parameters operated last time.



10. Enter into standby state

Unlock the operation ring, the top cover is able to open

4. Operation Method

Shortcut function (preheating)

Follow the procedures below for the setting of preheating:



1. Turn on the earth leakage breaker (switch ON).

Turn on the earth leakage breaker, touch screen displays the left interface for 3 secs, and then switch over to the next interface.

2. The touch screen displays the operation mode and program executed last time.

Sterilize & dry program: sterilize temp.126°C, sterilize time 30min;

Dry temp. 150°C, dry time 30min

Current temp. in chamber 32°C

Normal pressure (green character and icon)

Normal bottle (green character and icon)

Normal cover locking (green character and icon)



2.1 The touch screen displays the operation mode and program executed last time.

According to the aforementioned operation procedures of instruction manual, set the required operation mode program, ie. corresponding temp. and time; pressure, water tank and cover are normal (green display). By default operate the program!

Press **Preheating** area, the background color becomes yellow, switch over the interface



3. Preheating operation interface

Preheat **OFF** background color is blue that means the operation mode executed last time.



3.1 Preheating operation interface

Press **ON**, the background color becomes yellow, switch over the interface

4. Operation Method

Shortcut function (preheating)



3.2 Preheating operation mode

Press **Preheating program**, the background color of **ON** becomes blue.

3.2.1 Preheating operation mode

Press **X**, cancel setting, switch over the interface to return to sterilize & dry interface interface.

3.2.2 Preheating operation mode

Press green **Start** to confirm, switch over the interface to enter into instrument dry interface.

4. Preheating operation mode

Start preheating, the preheating time is 5h by default, and the preheating temp. can be set and changed in setting menu!

5.1 Stop preheating operation

①If need to stop during preheating, Press **Preheat** area, the background color becomes yellow,

4. Operation Method

Shortcut function (preheating)



5.1.1 Stop preheating operation

The background color of ON is blue, press OFF area.

5.1.2 Stop preheating operation

The background color of ON becomes white, and OFF area becomes blue.

5.1.3 Stop preheating operation

Press green to confirm the exit of preheating operation.

6. Stop preheating operation

Switch over the interface to return to instrument dry interface.

4. Operation Method

Shortcut function (memory)

Memory function

Each operation course has three memory banks, where registration and read of settings are possible. The following settings can be stored into the memory.

- Sterilize (liquefy, dry) temp.
- Retain temp. temp.
- Retain temp. time
- Sterilize (liquefy, dry) time

1. Register the memory

Make sure that the course where the memory is to be registered is selected and then press **Memory**, the background color becomes yellow, switch over the interface



1.1 Memory interface

Preset 3 programs: MEM-1, MEM-2, MEM-3



1.2 Select memory program

Press **MEM-1** program No. area, the background color becomes yellow



1.2.1 Select memory program

MEM-1 background color becomes blue



1.2.2 Select memory program

Press green **√** to confirm, switch over the interface to return to instrument dry interface.



4. Operation Method

Shortcut function (memory)



2. Register operation of memory

Memory program parameter: instrument sterilize mode, sterilize temp. 135°C, sterilize time 1h.



3. Change memory program parameter

Press **Sterilize** area, the background color becomes yellow



3.1 Select memory program

For changing sterilize temp. and time, refer to aforementioned operation of changing instrument sterilize parameters.

Instrument sterilize mode:

Change memory program TEST1 parameter < sterilize temp. 126°C, sterilize time 30min >

Confirm the mode and parameters, directly press START key to operate!



4. Change memory program name

Press **Change memory program name** area, the background color becomes yellow.



4.1 Change memory program name

Change memory program name area and **MEM-1** area become blue, they are currently operating parameters.



4.2.1 Keypad operation of changing memory program name

The letter, number and symbol at each key can be input by press this key, e.g. press **1 +/-** key to circularly display 1, + and -; press **◀ ▶** to select input position.

Press **✕** to return, Press **CLR** to change, and Press **✓** to confirm modification.

4. Operation Method

Shortcut function (memory)



3. Register operation of memory

Memory program parameter: instrument sterilize mode, sterilize temp. 135°C, sterilize time 1h.



3. Change memory program parameter

Press **Sterilize** area, the background color becomes yellow



3.1 Select memory program

For changing sterilize temp. and time, refer to aforementioned operation of changing instrument sterilize parameters.

Instrument sterilize mode:

Change memory program TEST1 parameter < sterilize temp. 126°C, sterilize time 30min >

Confirm the mode and parameters, directly press START key to operate!



4. Change memory program name

Press **Change memory program name** area, the background color becomes yellow.

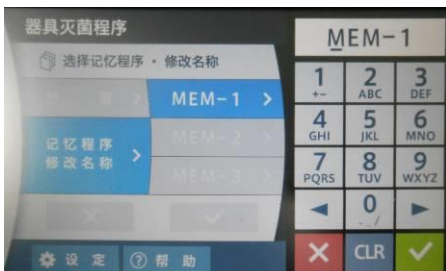

4.1 Change memory program name

Change memory program name area and **MEM-1** area become blue, they are currently operating parameters.

The pop-up keypad display the program name MEM-1.





1. Register the memory

Make sure that the course where the memory is to be registered is selected and then press **Memory**, the background color becomes yellow, switch over the interface



The memory registration interface is displayed.

The memory No. is displayed on the highest-order digit of temp. display interface. The temp./time setting display for sterilize or liquefy switches to 1, 2, 3 or normal mode in this order every time the SET MEMORY key is pressed.

As for the courses that include the retain temp. setting, the temp. and time of the setting can be checked by pressing the ENTER key.

The FORCED COOLING lamp lights up when forced cooling function is set to "on".



Select the memory No. that the setting is overwritten and then press the SET MEMORY key for two seconds. The displayed preset value changes. This completes the registration of setting.



2. Operation procedures with the registered setting

① Make sure that the course to be operated is selected and then press the SET MEMORY key. The SET MEMORY lamp blinks.



② The memory confirmation interface registered is displayed.

Select the memory No. by the SET MEMORY key.

③ Press the START/STOP key. The setting being displayed is read. The equipment starts operation using the setting.

4. Operation Method

Shortcut function (schedule)

Follow the procedures below for the setting of scheduled operation:



1. Turn on the earth leakage breaker (switch ON).

Turn on the earth leakage breaker, touch screen displays the left interface for 3 secs, and then switch over to the next interface.

2. The touch screen displays the operation mode and program executed last time.

Instrument sterilize program: sterilize temp. 126°C, sterilize time 30min

Dry temp. 150°C, dry time 1h30min

Current temp. in chamber 32°C

Normal pressure (green character and icon)

Normal bottle (green character and icon)

Normal cover locking (green character and icon)



2.1 The touch screen displays the operation mode and program executed last time.

Press Schedule area, the background color becomes yellow, switch over the interface.



3. Schedule operation interface

Date+time mode area is gray, which is the last scheduled mode, and the scheduled date and time are shown at right.



3.1 Scheduled mode selection interface

Press Date, the background color becomes yellow, switch over the interface

4. Operation Method

Shortcut function (schedule)

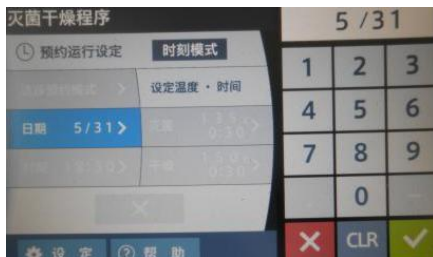

3.1.2 Scheduled date setting interface

The date setting keypad pops up, and displays the last scheduled date.

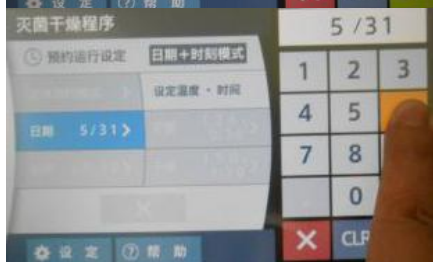



3.1.3 Scheduled date setting interface

If no need to modify, press  key at right keypad to close the keypad.

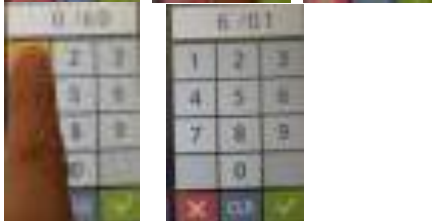
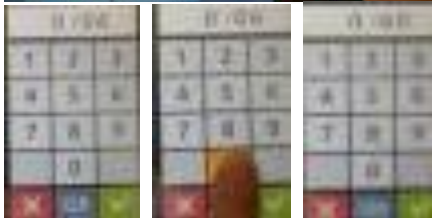
- ① If type into wrong number, press CLR key to clear it;
- ② Directly type into required date numbers.



3.1.4 Confirm the scheduled operation date

- ① If no need to modify, press  key at right keypad to close the keypad.
- ② Press green  to confirm the set scheduled date, the keypad will auto hide.



3.1.5 Scheduled operation interface

- ① Return to scheduled mode interface, complete scheduling date.

For changing time, refer to following method of scheduling time mode.

4. Operation Method

Shortcut function (schedule)



4. Select scheduled mode

Press **Select schedule mode** area, the background color becomes yellow



4.1 Select scheduled mode

Date time area is blue, the last scheduled mode is **Date+time mode**



4.1.1 Select scheduled mode

Press **Time** area, the background color becomes yellow



4.1.2 Select scheduled mode

The background color of **Time** mode area is blue.

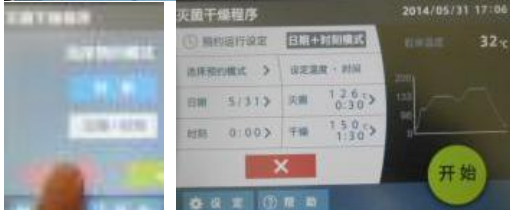

4.1.3 Select scheduled mode

Press **X** key to return to **Date time** schedule mode.



4.1.4. Confirm **Time** mode

Press **V** to confirm that the schedule mode is **Time** mode.

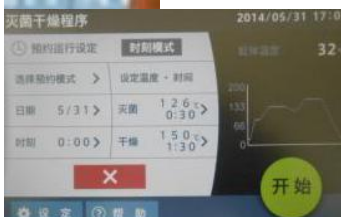

4. Operation Method

Shortcut function (schedule)



5.1 Scheduled time setting interface

Press **Time** area, the background color becomes yellow



5.1.1 Scheduled time setting interface

Press **Time** area, the background color becomes blue, and pop up the setting keypad.

If no need to modify, press **X** key at right keypad to close the keypad.

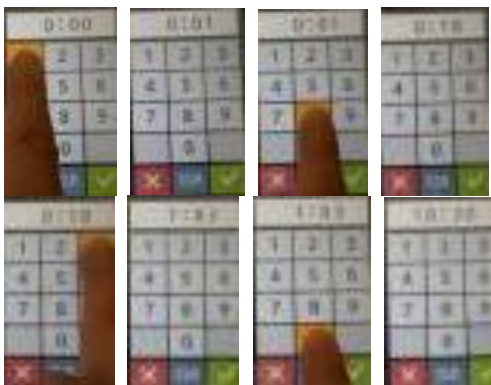

5.1.2 Set the operation start time

① If type into wrong number, press CLR key to clear it;

② Directly type into required numbers, 24h by default.



5.1.3 Set the operation start time

① If no need to schedule time, press **X** key at right keypad to close the keypad.

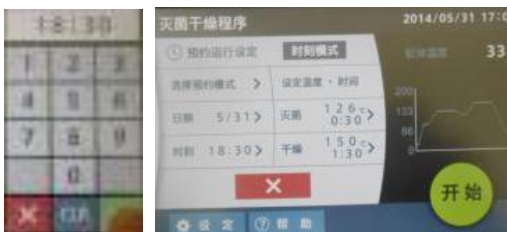

5.1.4 Set the operation start time

① Press green **✓** to confirm scheduled time, the keypad will auto hide.

② Return to scheduled time mode interface, the equipment will operate sterilize & dry program when it reaches the scheduled time 18:30.

4. Operation Method

Shortcut function (schedule)

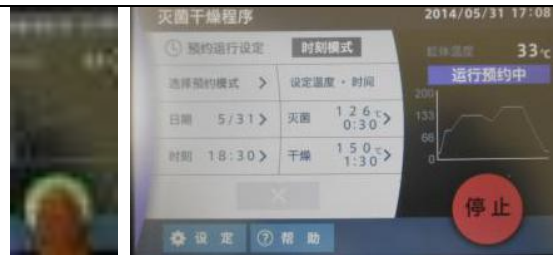

6. Start scheduled operation

Sterilize temp.126°C, sterilize time 30min

Dry temp.150°C, dry time 1h30min

**Press START key to enter into scheduling state!
The scheduled time, temp. and time parameters, except during scheduling, can not be changed when the scheduled time is reached and the operation starts!**

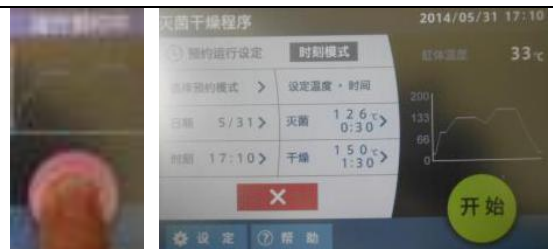

6.1 Stop during scheduling

Press STOP key to stop scheduling.



6.2 Start operation

It reaches the scheduled time and the operation starts

Sterilize & dry program: Sterilize temp.126°C, sterilize time 30min

Dry temp.150°C, dry time 1h30min

4. Operation Method

Shortcut function (initial setting value)

The preset values at factory shipment are as follows.

The initial setting values of operation						
Operation course	Sterilize temp.	Sterilize time	Liquefy temp.	Liquefy time	Retain temp. temp.	Retain temp. time
Instrument sterilize	121°C	20 min.	—	—	—	—
Fluid sterilize	121°C	20 min.	—	—	—	—
Sterilize & retain temp.	121°C	20 min.	—	—	50°C	2 hours
Liquefy & retain temp.	—	—	100°C	10 min.	50°C	2 hours
Manual	121°C	20 min.	—	—	50°C	2 hours

The initial setting values of function	
Function	Value
Preheating	45°C
Forced cooling	OFF
Key lock	OFF
Pattern lock	OFF
Buzzer	ON
Error log	—
Sample temperature	OFF
Cumulative time	0 hour

4. Operation Method

Shortcut function (optional connector)

Optional connector:

Connectors used for sample sensor, chamber temp. measurement sensor and pressure gauge optionally purchased.

Before using



Operate this product according to the procedure described in this Operation Manual. Failure to follow the operation procedure described herein may result in a problem. The guarantee will not apply if you operate the product in the wrong manner.



Caution



- | |
|---|
| 1. Turn off the breaker before connecting. |
| 2. Before connecting, confirm that both the chamber pressure and temp. are lower. |
| 3. Please correctly connect the optional connectors (S1, S2, S3) respectively. |

Connection procedure

In each connector, PT1/4 screws are mounted. Please remove these screws when connecting.

1. Sample sensor
 - 1-1. Please connect the optional connector S1 or S2 (refer to P.101 98[12.Piping diagram]) to optional sample sensor. (Refer to P.17)
 - 1-2. In order to input the sample sensor, please disassemble the back plate of unit body, connect to the terminal block (TB1 4.5) of controller board. When connecting, please confirm that they are connected by the screws attached by terminals. Refer to (P.59 [11. wiring and piping diagram])
2. Chamber temp. measurement sensor
Please connect the optional connector S1 or S2 (refer to P.101 [12.Piping diagram]) to optional chamber temp. measurement sensor. (Refer to P.17)
3. Pressure gauge
Please connect the optional connector S3 (refer to P.101 [12.Piping diagram]) to optional pressure gauge.

4. Operation Method

External Output Terminal (optional)

Before using



Operate this product according to the procedure described in this Operation Manual. Failure to follow the operation procedure described herein may result in a problem. The guarantee will not apply if you operate the product in the wrong manner.



Caution



1. Turn off the breaker before connecting.
2. Connect a recorder or another appliance of 600 W or less in input impedance to the temperature output terminal.
3. Securely fasten all connections with the screws attached to the terminal block.

Connection procedure



Connect the cables to the appropriate terminals.

When using temperature output, use a shielded wire for the cable to be connected to prevent noise.



Connection terminal

4. Operation Method

External Output Terminal (optional)

Parameters

Temperature Output (ANALOG)	<ul style="list-style-type: none">• The current (mA) corresponding to the measured temperature is output.• Output temperature range: 0 to 160°C• Output current: 4 to 20mA• Resistive load: 600Ω or bellow• Resolution: ±2°C (±0.2mA)• Connection: M4 screw terminal
Time-up Output (TIME UP)	<ul style="list-style-type: none">• It is output when operation is completed, including an abortion.• a-contact (relay contact)• Contact capacity: 250V AC, 1A (resistance load)• Connection: M4 screw terminal
Alarm Output (ALARM)	<ul style="list-style-type: none">• It is output when an abnormality is detected. Refer to "Safety Device and Error Code" in Page53.• a-contact (relay contact)• Contact capacity: 250V AC, 1A (resistance load)• Connection: M4 screw terminal
RS485 output (RS485)	RS485 communication function

Temperature/current output table

Temperature (°C)	Output current (mA)
0	4
20	6
40	8
60	10
80	12
100	14
120	16
140	18
160	20

5. Handling Precautions



Warning

If a problem occurs



If smoke or strange odor should come out of this unit for some reason, turn off the power key right away, and then turn off the circuit breaker and the main power. Immediately contact a service technician for inspection. If this procedure is not followed, fire or electrical shock may result. Never perform repair work yourself, since it is dangerous and not recommended.

Measure for flammability and handling of flammable solvent



This unit is not designed as the explosion-proof construction. Pay special attention to the handling of the sample to be handled with this unit on the consumption with the explosive material, flammable material, and similar ones. The flammable material may be vaporized by leaving it at the temperature higher than room temperature, and could cause the fire or explosion. When handling such material, provide ventilation with enough before the operation.

Keep the unit well-ventilated



Keep the heat releasing outlets in the side and back of the unit open during operation. If they are closed, the inside temperature of the unit may increase, its performance may deteriorate, or an accident, malfunction or fire may result.

Exercise care not to allow a liquid to get on the unit



Exercise care not to allow a liquid to get on the unit or enter the unit through the heat releasing outlets in the side or back of the unit. If it enters the unit, immediately stop the operation. Otherwise, an accident, malfunction, electric shock or fire may result.

Do not drop metallic pieces into the unit



Do not drop metallic pieces, such as clips, staples and screws, into the unit. If such a metallic piece has dropped into the unit, turn it off. An accident, malfunction, electric shock or fire may result.

Do not open the panels and covers



Do not operate the unit with the fixed panels and covers open. An accident, malfunction or electric shock may result.

Do not modify



Do not modify this unit. An accident, malfunction, electric shock or fire may result.

5. Handling Precautions



Caution

Do not step on this unit



Do not step on this unit. It will cause injury if this unit fall down or break.

Do not place or drop anything on the unit



Do not place or drop anything on the unit. Since the unit contains precision components, it may malfunction due to vibration, impact, etc.

During a thunder storm



During a thunderstorm, turn off the power key immediately, then turn off the circuit breaker and the main power. If this procedure is not followed, fire or electrical shock may be caused.

Countermeasure for stop operation during night or long-term stop



Turn off the power of earth leakage breaker and disconnect the power cord from the power source before stopping the operation of equipment overnight or for a long time.

Do not touch the hot section



The temperature on the cover and top board on the chamber are very hot during operation or just after operation is completed. Do not touch these sections to avoid a burn injury.

When opening the cover...



Make sure that the pressure gauge reading has decreased to 0(zero) MPa before opening the cover. Open the cover slow carefully. The high-temperature and pressure vapor blows out if the cover is opened during high pressure.

When opening/closing the door...



Do not put your hands or face into the traveling range (space) of door when it is opened or closed. The door may contact, which may cause an injury.

When draining water...



The water in the chamber is very hot just after operation is completed. Be careful not to get a burn injury. Drain the water after the water is sufficiently cooled down.
Do not drain water during operation. The hot water blows out if the drain valve is opened while the pressure is increasing.

Do not damage the packing on the cover or flange on the chamber



Damage or dirt on these areas may cause the vapor leakage, which may be the cause of burn injury. Keep these sections always clean. Do not damage them with the rack when taking out and putting in the sterile samples. The packing degrades wit time. It must be replaced if vapor leak occurs frequently. In this case consult with the selling office where you purchased or our sales office.

Replace the packing early



The packing is a consumable. If it shows the sign of damage or hardening, replace it early. Please consult with the selling office where you purchased or our sales office for the replacement of packing.

Do not perform procedures other than described in this document



Do not perform procedures other than described in this document. Otherwise an unexpected accident may occur.

5. Handling Precautions

 **Caution**

When put samples after preheating



Because of the steam pressure in cylinder during preheating, the cover cannot be open. Before putting samples, press preheat key, switch the heater to OFF, wait for 20 secs, and then open the cover after the cylinder pressure drops.

Turn off the power source at standby state



After sterilization, if not use the unit in short time, please turn off the power source and switch the breaker [OFF], which will extend the service life of equipment parts!

6. Maintenance Method

Daily Inspection and Maintenance

For the safety use of this unit, please perform the daily inspection and maintenance without fail.

Warning

- Disconnect the power cable from the power source when doing an inspection or maintenance unless needed.
- Perform the daily inspection and maintenance after returning the temperature of this unit to the normal one.
- Do not disassemble this unit.



caution

- Use a well-drained soft cloth to wipe dirt on this unit. Do not use benzene, thinner or cleanser for wiping. Do not scrub this unit. Deformation, deterioration or color change may result in.

Monthly maintenance

- Check the earth leakage breaker function.
 1. Connect the power cord.
 2. Turn the breaker on.
 3. Push the red test switch by a ballpoint pen etc.
 4. If there is no problem, the earth leakage breaker will be turned off.

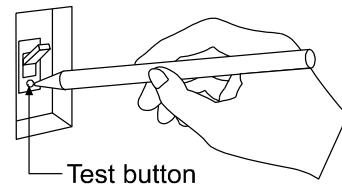

- Clean the silencer.

The exhaust hose is equipped with a silencer on its end to reduce the noise generated during air purge.

1. Remove the silencer and wash it with water. It contains a backwater prevention ball. Make sure not to lose the ball when the silencer is removed.
2. After cleaning, put the ball first into the silencer and then fix the silencer

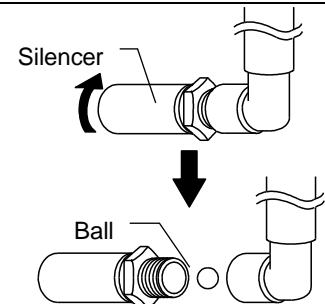

Filter cleaning

- If the filter on the bottom of chamber is clogged with dust or dirt, the equipment can not drain the water. Clean it appropriately as required.
 - The filter is inserted in the drain outlet. Pull it out to sweep it.
 - Insert it in place after cleaning.

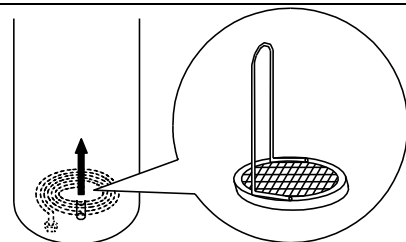

Cleaning inside the chamber

- Use soft sponge to clean inside the chamber not to damage the surface inside the chamber. Do not remove the filter on the bottom of chamber at cleaning. If it is removed, the pipe fitting is clogged with dirt inside the chamber.
- The heater and sensor are provided on the bottom inside the chamber. Make sure not to bend or damage the filter.

◆ For any questions, contact the dealer who you purchased this unit from, or the nearest sales division in our company.

7. Long storage and disposal

When not using this unit for long term / When disposing



Caution

Warning

When not using this unit for long term

- Turn off the power and disconnect the power cord.

When disposing

- Keep out of reach of children.
- Consult with the specialized disposal services when disposing the equipment.

Notes about disposal

Environmental protection should be considered

We request you to disassemble this unit as possible and recycle the reusable parts considering to the environmental protection. The feature components of this unit and materials used are listed below.

Component Name	Material
Exterior Parts	
Outer covering	Cold rolled steel plate with coating
Chamber, Cover	Stainless steel SUS304
Packing	Silicon rubber
Plates	Polyethylene, resin film
Electrical Parts	
Switches, Relay	Resin, copper
Circuit boards	Composite of glass fiber and other
Heater	SUS pipe heater
Power cord	Synthetic rubber coated wiring materials, copper and nickel
Piping Parts	
Hoses	rubber
Pipes	Copper, Copper alloy

8. In the Event of Failure

Safety Device and Error Code

This unit has an automatic diagnosis function built in the controller and safety devices independent of the controller. The table below shows the cause and the solution method when the safety device operates.

Error Code:

If an error in use or equipment a failure occurs, the temperature display screen on the operating panel displays the corresponding error code and the alarm buzzer sounds. The buzzer stops by pressing any key. In case an error occurs, check the error code and turn off the earth leakage breaker.

Safety Device	Notify	Cause/Solution
Sensor trouble detection	Display Er01	<ul style="list-style-type: none"> Failure in temperature input circuit. Temperature sensor is broken or disconnected. The measured temperature is out of the display range. Make a call for service.
SSR short-circuit detection	Display Er02	<ul style="list-style-type: none"> SSR is in short-circuit Make a call for service.
Heater disconnecting detection	Display Er03	<ul style="list-style-type: none"> Sterilize heater is disconnected. Make a call for service.
Cover locking error	Display Er04	<ul style="list-style-type: none"> The cover is unlocked during operation. Make a call for service.
Cover unlocking error	Display Er05	<ul style="list-style-type: none"> The cover is not unlocked at releasing. Make a call for service.
Abnormal drain switch	Display Er06	<ul style="list-style-type: none"> The drain switch is not installed normally. Open the door to confirm the open&close state of drain switch and the normal position of baffle.
Overheat error	Display Er07	<ul style="list-style-type: none"> The chamber temp.rises to 140°C or above. The temp. of "preset temp. + (plus) 3°C or above" is continued for one minute during sterilize course. The temp. of "preset temp. + (plus) 10°C or above" is continued for ten minutes during retain temp. course. Make a call for service.
Sample sensor (optional) disconnection	Display Er08	<ul style="list-style-type: none"> Disconnection or abnormality of sample sensor. The setting is set to "on" when the sensor is not attached. Make a call for service.
Exhaust valve error	Display Er09	<ul style="list-style-type: none"> Failure in exhaust valve. Make a call for service.
A/D conversion error	Display Er15	<ul style="list-style-type: none"> Failure in electrical parts. Make a call for service.

8. In the Event of Failure

Safety Device and Error Code

Safety Device	Notify	Cause/Solution
Auto-tuning error	Display Er16	<ul style="list-style-type: none"> Failure in preset value of memory. Make a call for service.
Internal communication error	Display Er17	<ul style="list-style-type: none"> Communication error between the control board and display board. Make a call for service.
Water level error	Display Er20	<ul style="list-style-type: none"> Lack of water supply Supply water. Check the amount of water to be supplied referring to 8 of "Preparation before operation" in Page 11. If the error is not cancelled, contact our service department.
Temp. overheat error	Display Er21	<ul style="list-style-type: none"> The chamber temp. rises to 140°C or above. The temp. of "preset temp. + (plus) 3°C or above" is continued for one minute during sterilize course. The temp. of "preset temp. + (plus) 10°C or above" is continued for ten minutes during retain temp. course. Make a call for service.
Power failure	Display Er23	<ul style="list-style-type: none"> Power failure during operation
High pressure error	Display Er25	<ul style="list-style-type: none"> The cylinder pressure exceeds the pressure switch setting limits or pressure switch settings are changed or has been damaged. Make a call for service.
Drain solenoid valve error	Display Er29	<ul style="list-style-type: none"> Drain solenoid valve is not turned on or stuck, the pressure does not get lower than the predetermined value after a certain time. Make a call for service.
Dry SSR short-circuit	Display Er102	<ul style="list-style-type: none"> Dry SSR short-circuit Make a call for service.
Dry heater disconnection	Display Er103	<ul style="list-style-type: none"> Dry heater disconnection Make a call for service.
Safety valve	Safety valve is operated.	<ul style="list-style-type: none"> Pressure rise inside the chamber or safety valve failure. Make a call for service.

8. In the Event of Failure

Trouble Shooting

Phenomenon	Check point
The unit does not start to operate although the leakage breaker is turned on.	<ul style="list-style-type: none"> • Check if the power cable is securely connected to the power supply. • Check if the power fails. • Check the power voltage.
The screen displays the error code and the alarm buzzer sounds.	<ul style="list-style-type: none"> • Check the error code. (refer to "Safety Device and Error Code" on page 90 and 91.)
Exhaust failure or safety valve is operated.	<ul style="list-style-type: none"> • The hose to the cooling water box is twisted or clogged. • The exhaust outlet inside the chamber is blocked with the sterile samples. • Too much samples are stored.
Drain failure	<ul style="list-style-type: none"> • The filter is clogged.
Sterilization temperature does not rise or pressure inside the chamber does not rise.	<ul style="list-style-type: none"> • The preset value is lower than the temperature inside the chamber. • The power supply voltage is low. • The ambient temperature is too low. • The cover is not securely closed. • The packing or flange is damaged.
Pressure inside the chamber rises with the solenoid valve opened.	<ul style="list-style-type: none"> • The exhaust outlet inside the chamber is blocked.
The temperature changes during operation of equipment.	<ul style="list-style-type: none"> • An inadequate preset temperature is set. • Check if the power supply voltage is low. • The variation in ambient temperature is too large.
Too much vapor blows out, or hot water blows out from the drain bottle.	<ul style="list-style-type: none"> • The cooling water box does not contain water. • The water in the cooling water box is hot. • The exhaust hose is removed or broken. • The silicon plug is not fitted securely. • The water level in the cooling water box is above the drain level.
Water leaks.	<ul style="list-style-type: none"> • The drain valve is not securely closed.
Operation halts in standby state.	<ul style="list-style-type: none"> • The cover is not securely closed. Check it referring to the 12 of " Preparation before operation " in Page 12.
Large noise during air purge.	<ul style="list-style-type: none"> • Check if the silencer is removed, Check the connection of silencer inside the cooling water box referring to the Page88.
Cover does not open.	<ul style="list-style-type: none"> • The power is turned off. • The sterilization process is not completed.

In the case if the error other than listed above occurred, turn off the power switch and primary power source immediately. Contact the shop of your purchase or nearest Yamato Scientific Service Office.

9. After-sales Service and Warranty

When need repair

In Case of Request for Repair

If the failure occurs, stop the operation, turn OFF the power switch, and unplug the power plug. Please contact the sales agency that this unit was purchased, or the Yamato Scientific's sales office.

< Check following items before contact >

- ◆ Model Name of Product
 - ◆ Production Number
 - ◆ Purchase Date
 - ◆ About Trouble (in detail as possible)
- } See the production plate attached to this unit.

Minimum Retention Period of Performance Parts for Repair

The minimum retention period of performance parts for repair of this unit is 7 years after discontinuance of this unit.

The "performance part for repair" is the part that is required to maintain this unit.

10. Specification

Product structure and performance: the product is mainly composed of pressure-bearing chamber, chamber cover, the cover lock structure, steam pipe, circuit structure, shell, water cooling tank and caster, etc.. Performance: the highest temperature 135 °C, the highest working pressure 0.255 MPa.(See table below)

Product name		Vertical pressure steam sterilizer			
Model		SM520	SM820	SM530	SM830
Scope of application		Applicable to health care, scientific research units, such as used for sterilization of medical device, lab ware, culture medium and sealing liquid or preparations.			
Performance	Operating temp. range	105°C~135°C (sterilize), 65°C~100°C (liquefy)			
		45°C~60°C (retain temp.), 45°C~80°C (preheat temp.)			
		135~150°C (dry)			
	Max. operating pressure	0.255MPa			
Operating ambient temp.		5°C~35°C			
Cover mechanism		Manual up and down open/close system (safety lock mechanism attached)			
Chamber structure	Sterilize heating pipe	100V 1000W x2			
	Dry heating pipe	110V/295W x2 110V/455Wx2	110V/275W x2 110V/625W x2	110V/295W x2 110V/455W x2	110V/275Wx2 110V/625Wx2
	Exhaust valve	For auxiliary exhaust, full open and slow exhaust (one each)			
	Optional connector	For sample sensor (R1/4), recorder (R1/4) and connection to pressure gauge (branched from the electromagnetic exhaust duct)			
	Forced cooling fan	Axial fan motor			
	Condenser	Copper pipe radiator			
	Condensate fan	Axial fan motor			
Configurations	Temp. control system	PID control by microcomputer			
	Setting/display method	Digital setting by UP/DOWN key / Digital display			
	Timer	Range: 0 or 1min to 99h59min, Resolution: 1minute			
	Operation courses	Instrument sterilize, fluid sterilize, sterilize→retain temp. Liquefy→retain temp., instrument dry, sterilize→dry			
	Other functions	Key lock, Schedule, Memory, Preheating, Forced cooling, Pattern lock, Error logging, Accumulated time / operation times, Time display, Buzzer, Sample temperature sensor (optional)			
Safety devices		Sterilize sensor error, sterilize SSR short circuit, dry sensor error, dry SSR short circuit, sterilize heater disconnection, dry heater disconnection,, water level detection (liquid expansion method), independent chamber overheat protector, cover unlock error, chamber overpressure protection, uncover pressure protection, warning about setting error in cooling water box, cover lock error, memory error, pressure switch (0.25MPa), pressure safety valve (0.255MPa)			

Specification

Pressure container spec.		Small pressure container				
Specification	Chamber effective dimension (ID.xD mm)	370x470	370x750	370x470	370x750	
	Exterior dimension※1 (WxDxH mm)	520x660x881	520x660x1161	520x660x881	520x660x1161	
	Chamber effective volume (L)	50	80	50	80	
	Weight (Kg)	Approx.100	Approx.110	Approx.100	Approx.110	
	Design pressure MAX(MPa)	0.42				
	Design temp. MAX(°C)	151				
	Power source (50/60 Hz)	Voltage	AC100-120V		AC200-240V	
		Sterilize current	19.0-21.0A		10-12.0A	
		Dry current	11.5-13.5A	13.0-15.0A	6.5-8.0A	7.0-9.0A
	Power cord length	1.8m outside the equipment				
Accessories	Sample box ×2 OSM-90 (Diameter 332x Depth 195.5 mm)	Sample box ×3 OSM-90 (Diameter 332xDepth 195.5 mm)	Sample box ×2 OSM-90 (Diameter 332xDepth 195.5 mm)	Sample box ×3 OSM-90 (Diameter 332xDepth 195.5 mm)		
	Vapor cup×1, droplet tray ×1 Sterilize test card ×1 set (30 pcs.), filter×1 Instruction manual, warranty					

※1 The exterior dimension excludes bulges.

※2 The chamber manufacturing meets the standard of GB150.4-2011.

11. Wiring Diagram

SM520/SM820

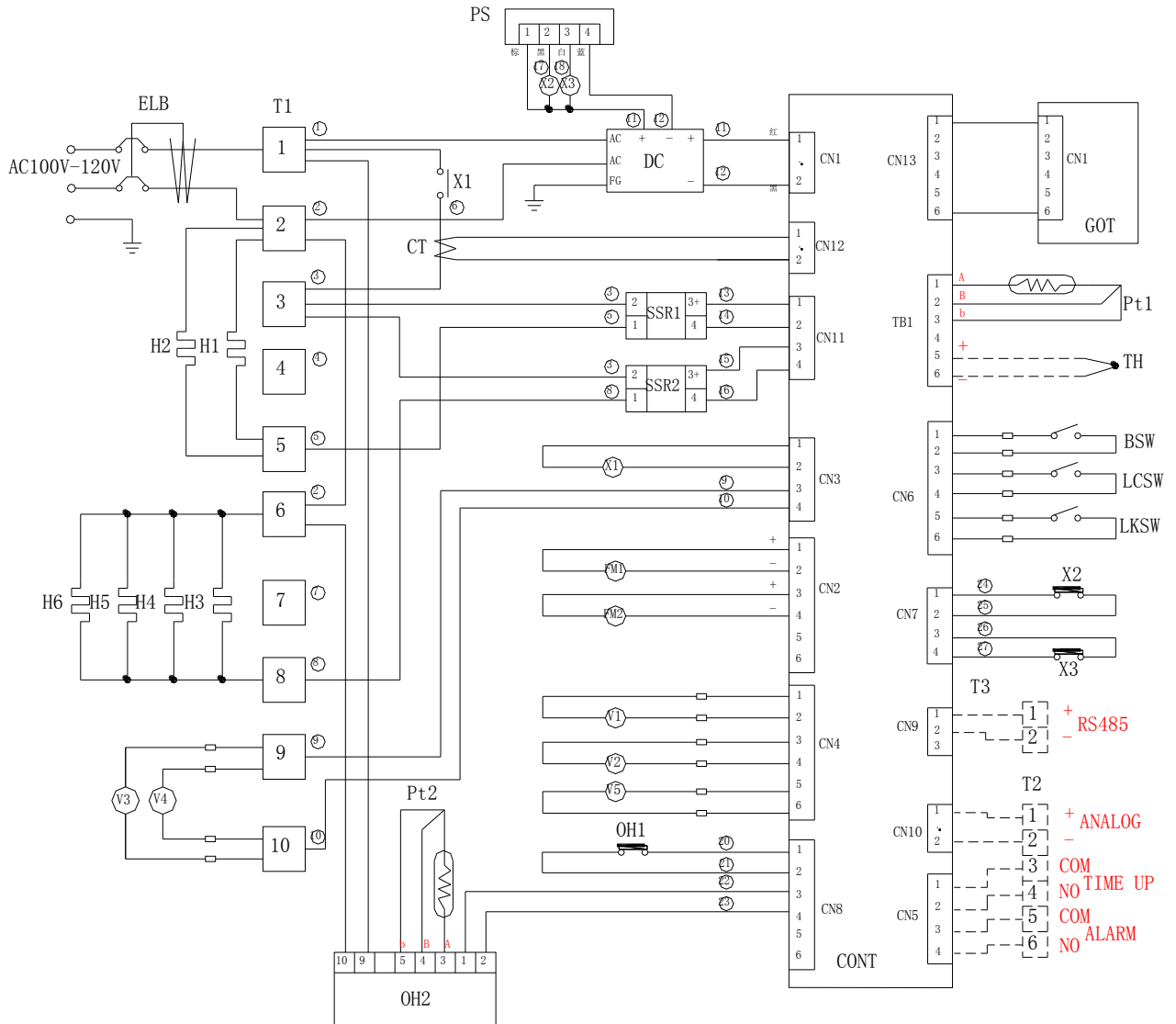

Symbol	Part name	Symbol	Part name
ELB	Earth leakage breaker	PS	Chamber pressure protection
T1, T2	Terminal block (T2, T3: option)	X1,2,3	DC relay
H1, H2	Heating pipe (sterilize)	V1	Solenoid valve (full open)
H3, 5	Heating plate (dry)	V2	Solenoid valve (slow exhaust)
H4, 6	Heating plate (dry)	V3	DC solenoid element (cover lock)
DC	Switch power supply (DC24V)	V4	Solenoid valve (auxiliary exhaust)
SSR1, 2	Solid state relay	V5	Solenoid drain valve
CT	Current transformer	BSW	Limit switch (cooling water box detection)
Pt1	Internal chamber temp. sensor	LCSW	Limit switch (lock lever detection)
Pt2	Chamber body temp. sensor	LKSW	Limit switch (cover lock solenoid valve detection)
TH	Sample sensor (K)	CONT	Control board
FM1, 2	Axial fan motor	GOT	Touch screen
OH1	Idling protection	OH2	Chamber overtemperature protection

11. Wiring Diagram

SM530/SM830

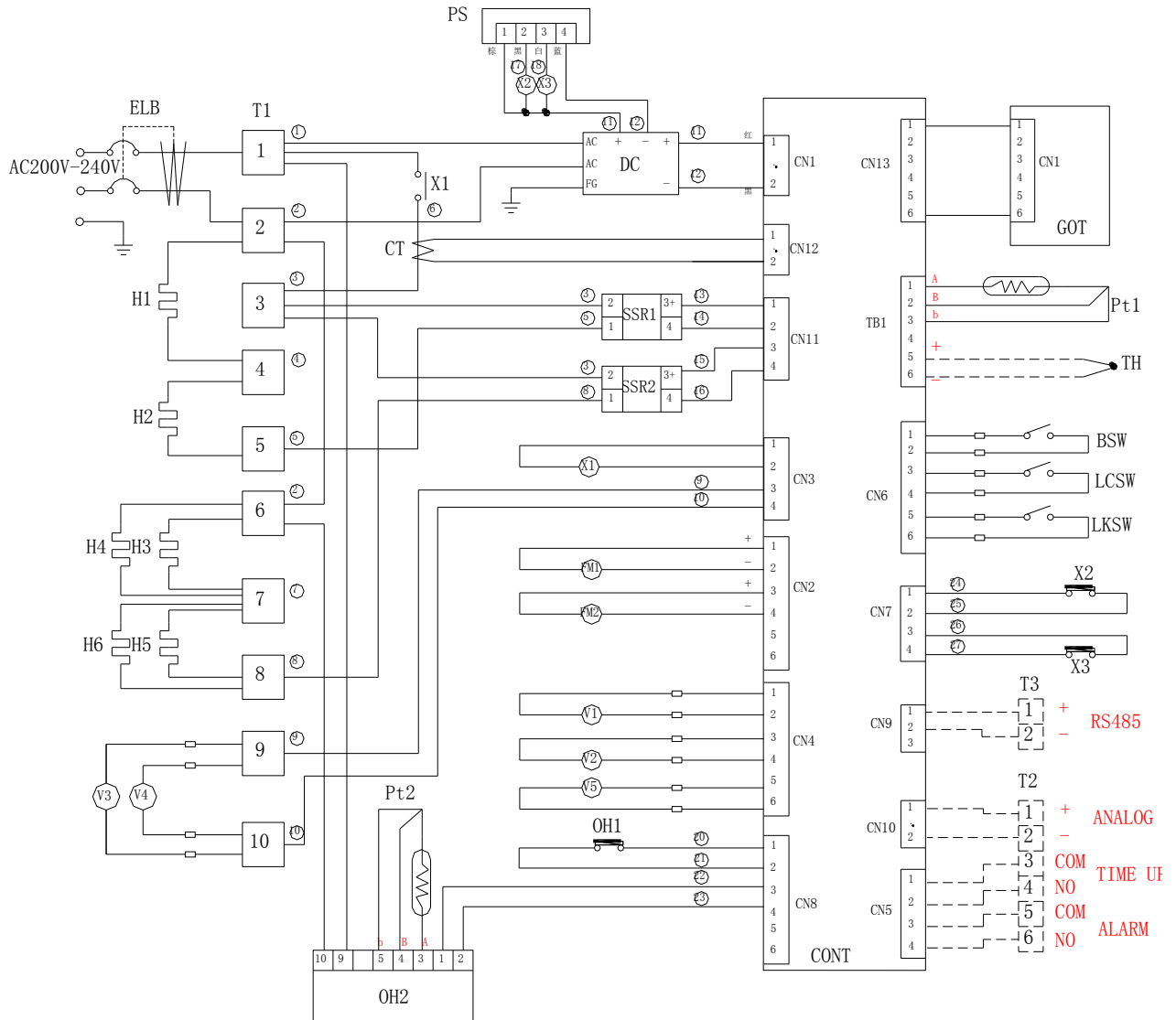

Symbol	Part name	Symbol	Part name
ELB	Earth leakage breaker	PS	Chamber pressure protection
T1, T2	Terminal block (T2, T3: option)	X1,2,3	DC relay
H1, H2	Heating pipe (sterilize)	V1	Solenoid valve (full open)
H3, 5	Heating plate (dry)	V2	Solenoid valve (slow exhaust)
H4, 6	Heating plate (dry)	V3	DC solenoid element (cover lock)
DC	Switch power supply (DC24V)	V4	Solenoid valve (auxiliary exhaust)
SSR1, 2	Solid state relay	V5	Solenoid drain valve
CT	Current transformer	BSW	Limit switch (cooling water box detection)
Pt1,2	Internal chamber temp. sensor	LCSW	Limit switch (lock lever detection)
Pt2	Chamber body temp. sensor	LKSW	Limit switch (cover lock solenoid valve detection)
TH	Sample sensor (K)	CONT	Control board
FM1, 2	Axial fan motor	GOT	Touch screen
OH1	Idling protection	OH2	Chamber overtemperature protection

12. Piping Diagram

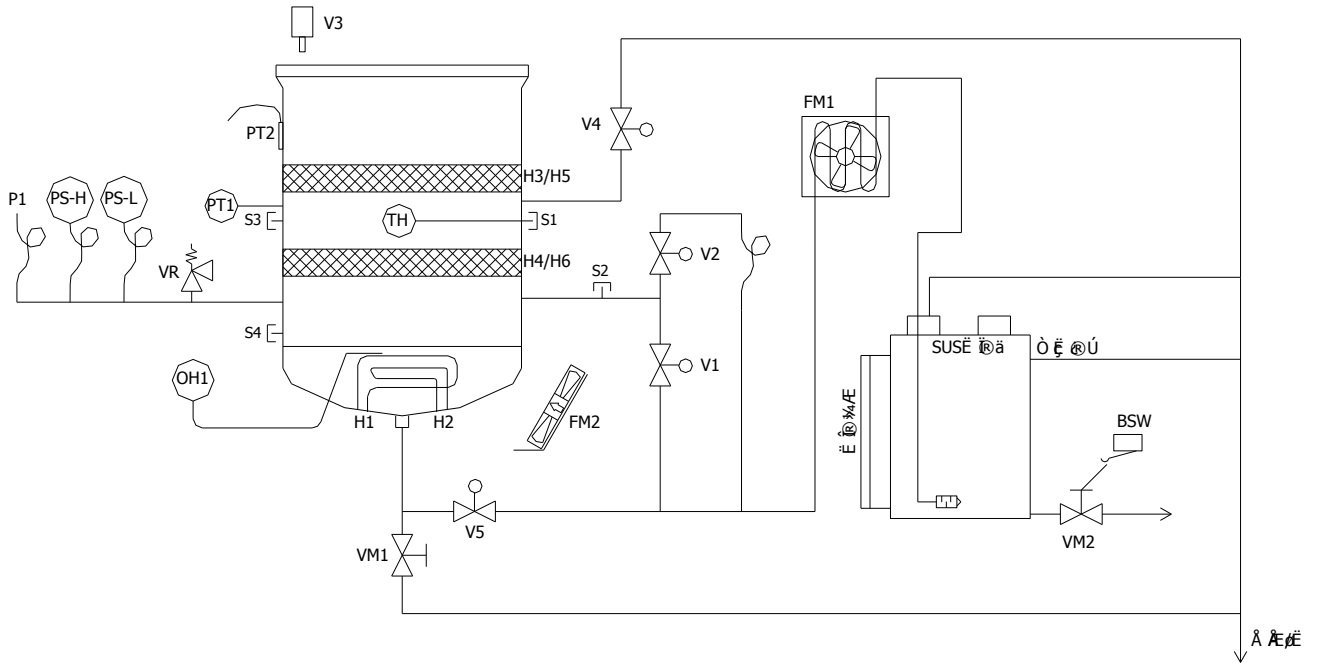

Symbol	Part name	Symbol	Part name
PT1	Internal chamber temp. sensor (sterilize/dry)	VM1	Manual drain valve (cylinder)
PT2	Chamber body temp. sensor (OH2)	VM2	Manual drain valve (water box)
OH1	Overheat protector (idling heat)	FM1	Condensation fan
P1	Pointer pressure gauge	FM2	Forced cooling fan
P-SH P-SL	Pressure switch	H1,H2	Heater (feed hot water in cylinder)
V1	Solenoid valve (full open)	H3,5	Chamber body heater (drying)
V2	Solenoid valve (slow exhaust)	H4,6	Chamber body heater (drying)
V3	Electromagnetic pushrod	S1	Optional connector (for sample sensor)
V4	Solenoid valve (pressure balance when shut down)	S2	Optional connector (for chamber temp. measurement sensor)
V5	Solenoid valve (auto drain water)	S3	Optional connector (for pressure gauge connection)
VR	Safety valve		SUS water box

13. Replacement Parts Table

Common parts

Symbol	Part Name	Code No.	Specification	Manufacturer
CONT	Control board	B020100002	SM	YSC
PIO	Display board	B020100003	SM 7 inch touch screen	YSC
OH1	Overheat protector	LT00014599	EGO 55.13042.110	YSC
0H2	Chamber overtemperature protector	A020101018	E5CWL-R1P	YSJ
Pt1	Chamber sensor	H060101001	Pt100Ω R1/2	YSC
Pt2	Chamber wall sensor	H010301001	Pt100Ω	YSJ
CT	Current transformer	B010509001	CTL-6-S-400	YSC
H1	Heating pipe	B080501002	100V 1000W	YSC
H2	Heating pipe	B080501003	100V 1000W	YSC
BSW LCSW LKSW	Micro switch	A011505003	D2VW-01L3-1M	YSC
-	Safety valve	LT00014593	M3D-B 0.255MPa	YSC
-	Silicone plug		SM520_02_09-06	YSC
	Packing	B081903003	SQ500-3046	YSC
ELB	Earth leakage breaker	A010414001	KD-L2123 30A 30mA	YSC
X1	DC relay	A011001001	JQX-116F-2/24VDC	YSJ
T1	Terminal block	A011301003	T56-STAO-10	YSJ
SSR1,2	Solid state relay	A011006005	XBPE4025C	YSJ
DC	Switch power supply	A010801017	HF100W-SEK-24	YSJ
V3	Electromagnetic pushrod	B080400010	TDS-12SB/DC24V	YSJ
V5	Drain valve	A040403025	VX235EA	YSJ
FM1, 2	Axial flow fan	A080104007	SJ1238HD2BAT	YSJ
-	Nylon gland	A011906015	PG-13.5	YSJ
P1	Pressure gauge	A042300006	GS58-271(0-0.4MPa)	YSJ
P-SH/SL	Pressure switch	A042300007	PPX-R10N-6M	YSJ
-	Silencer		R ₂ 1/4 external thread	YSJ
-	Lock lever	A082402005	SN200_3022_X	YSJ
-				
-				
-	Hook spring	A050232002	SM510C_01_02-03	YSJ
-	Left spring	H060501024	SM510C_01_04-04	YSJ
-	Right spring	H060501024	SM510C_01_04-05	YSJ

13. Replacement Parts Table

SM520、SM530

Symbol	Part Name		Code No.	Specification	Manufacturer
H3,5	Dry heating plate A		H060501009	SM520_01_02-01	YSJ
H4,6	Dry heating plate B		H060501011	SM520_01_02-02	YSJ
DC	Power supply	SM520	A010801011	S8JC-Z10024C-AC2	YSJ
		SM530	A010801017	HF100W-SEK-24(100-24 0V)	YSJ
	Power cord	SM520	11011210001	3*3.31(12AWG)	YSJ
		SM530	11011208002	3x2.5mm2 brown/blue/yellow green	YSJ
V1, 4	Solenoid valve		A040403027	VX235BA	YSJ
V2	Solenoid valve		A040403028	VX215DA	YSJ

SM820、SM830

Symbol	Part Name		Code No.	Specification	Manufacturer
H3,5	Dry heating plate A		H060501012	SM820_01_02-04	YSJ
H4,6	Dry heating plate B		H060501013	SM820_01_02-05	YSJ
DC	Power supply	SM820	A010801011	S8JC-Z10024C-AC2	YSJ
		SM830	A010801017	HF100W-SEK-24(100-24 0V)	YSJ
SSR	Solid state relay		11011006003	XBPE4025C	YSC
	Power cord	SM820	11011210001	3*3.31(12AWG)	YSJ
		SM830	11011208002	3x2.5mm2 brown/blue/yellow green	YSJ
V1, 4	Solenoid valve	SM820	11040403006	APK11-15A-C3A-DC24V	YSC
V2	Solenoid valve	SM830	11040403002	AB31-02-2-C3A-DC24V	YSC

※If need replacement, the above parts are supplied by Yamato only.

14. List of Dangerous Substances



Never use explosive substances, flammable substances and substances that include explosive or flammable ingredients in this unit.

EXPLOSIVE

EXPLOSIVE:	Ethylene glycol dinitrate (nitro glycol), Glycerin trinitrate (nitroglycerine), Cellulose nitrate (nitrocellulose), and other explosive nitrate esters
	Trinitrobenzene, Trinitrotoluene, Trinitrophenol (picric acid), and other explosive nitro compounds
	Acetyl hidroperoxide (peracetic acid), Methyl ethyl ketone peroxide, Benzyl peroxide, and other organic peroxides

FLAMMABLE

IGNITING:	Lithium (metal), Potassium (metal), Sodium (metal), Yellow phosphorus, Phosphorus sulfide, Red phosphorus, Celluloid compounds, Calcium carbide, Lime phosphate, Magnesium (powder), Aluminum (powder), Powder of metals other than magnesium and aluminum, Sodium hydrosulfite
OXIDIZING:	Potassium chlorate, Sodium chlorate, Ammonium chlorate, and other chlorate
	Potassium perchlorate, Sodium perchlorate, Ammonium perchlorate, and other perchlorate
	Potassium peroxide, Sodium peroxide, Barium peroxide, and other inorganic peroxide
	Potassium nitrate, Sodium nitrate, Ammonium nitrate, and other nitrate
	Sodium chlorite and other chlorites
	Calcium hypochlorite and other hypochlorites
INFLAMMABLE LIQUID:	Ethyl ether, Gasoline, Acetaldehyde, Propylene chloride, Carbon disulfide, and other flammable substances having a flash point of lower than -30°C
	Normal hexane, ethylene oxide, acetone, benzene, methyl ethyl ketone, and other flammable substances having a flash point of -30°C or higher but lower than 0°C
	Methanol, Ethanol, Xylene, Pentyl acetate (amyl acetate), and other flammable substances having a flash point of 0°C or higher but lower than 30°C
	Kerosene, Light oil (gas oil), Oil of turpentine, Isopentyl alcohol (isoamyl alcohol), Acetic acid, and other flammable substances having a flash point of 30°C or higher but lower than 65°C
FLAMMABLE GAS:	Hydrogen, Acetylene, Ethylene, Methane, Propane, Butane, and other flammable substances which assume a gaseous state at 15°C and 1 atm

15. Installation Standard Manual

* Install the unit according the procedure described below (check options and special specifications separately).

Model	Serial number	Date	Person in charge of installation (company name)	Person in charge of installation	Judgment

No	Item	Method	Reference operation manual	Judgment
Specifications				
1	Accessories	Check the quantities of accessories with the quantities shown in the Accessory column.	Specification	
2	Installation	<ul style="list-style-type: none"> Visually check the surrounding area. Note: Pay attention to the ambient environment. 	Error! Reference source not found. "Error! Reference source not found."	
		<ul style="list-style-type: none"> Keep space. 		
		<ul style="list-style-type: none"> Measure the customer-specific voltage (switchboard and outlet) with the tester. Measure the voltage at operation (it must be within the range of standard). Note: Use the on-spec product when installed on the plug or breaker. 	Error! Reference source not found. "Error! Reference source not found."	
			Error! Reference source not found. "Error! Reference source not found."	
		<ul style="list-style-type: none"> Clean the packing and flange on the chamber. 	Error! Reference source not found. "Do not damage the packing on the cover or flange on the chamber"	
		<ul style="list-style-type: none"> Attach the cooling water box. Note: Supply water into the bottle. 		
		<ul style="list-style-type: none"> Attach the drain board. Close the drain valve. 	Error! Reference source not found. "Error! Reference source not found."	
		<ul style="list-style-type: none"> Supply water into the chamber. Note: Supply water to the gauge level on the drain board. Attach the vapor cup and droplet tray. 		
Operation				
1	Test operation	<ul style="list-style-type: none"> Start operation. Operate the equipment with the apparatus sterilization course. Check: pressure/temperature rise, Vapor leak is not allowed. 	Error! Reference source not found. "Error! Reference source not found."	
Description				
1	Description of operation	Explain the operation of each unit to the customer according to this Operation Manual.	All	
2	Error code	Explain error codes and the procedure for resetting them to the customer according to this Operation Manual.	Error! Reference source not found.	
3	Maintenance inspection	Explain the operation of each unit to the customer according to this Operation Manual.	Maintenance Method	

4	Completion of installation Information to be entered	<ul style="list-style-type: none"> • Enter the date of installation and the name of the person in charge of installation on the face plate on the unit. • Enter necessary information on the guarantee, and pass it to the customer. • Explain the after-sale service route to the customer. 	After-sales Service and Warranty		
---	---	---	---	--	--

16. Maintenance and Replacement

Pressure gauge and safety valve

Disassembly & assembly procedures:

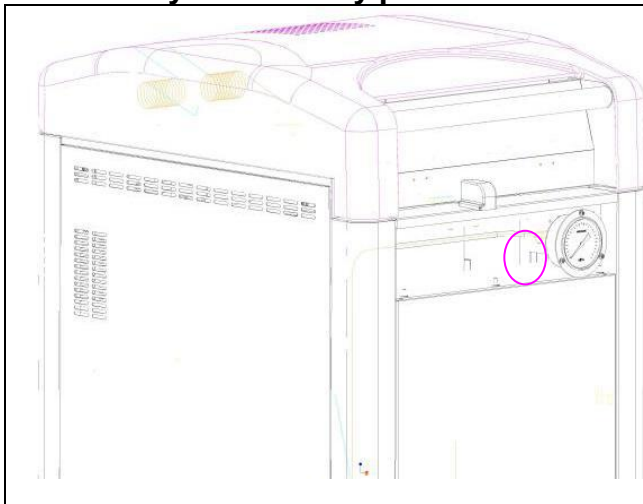

Use the cross screwdriver to remove the 3 screws at gauge case. Use 17mm wrench to steady the pressure gauge, and use 12mm wrench to remove small nuts to disassemble the pressure gauge. When replace or install pressure gauge again, use thread tape to wrap the thread tightly and seal! Finally, mount the 3 screws at the gauge case.

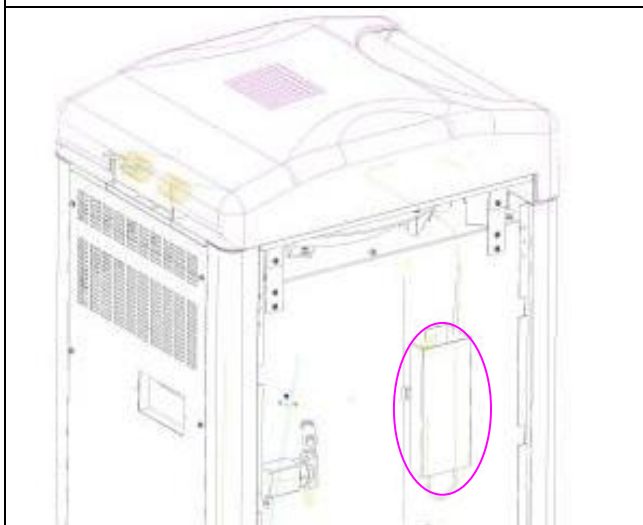

Open the front door, use the cross screwdriver to remove the 3 screws of stainless steel protection box.

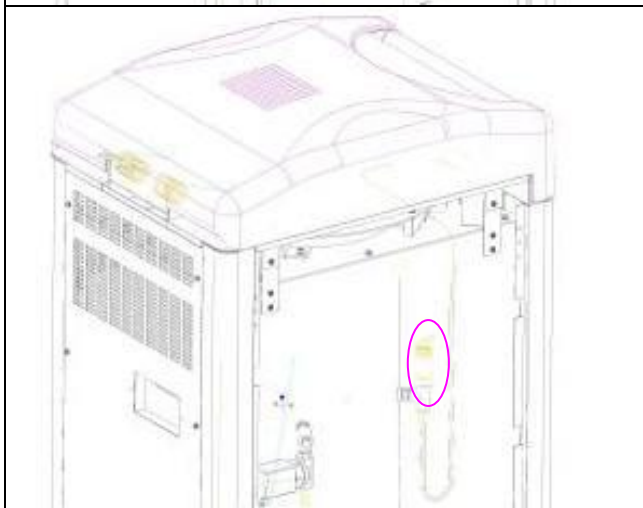

Use 24mm wrench to disassemble the safety valve. When install the safety valve again, use thread tape to wrap the thread tightly and seal!

17. Regular Spot Check

Regular self-checking of small pressure container

According to the [article 94 of the boiler and pressure container safety rules] , the small pressure container (SM520, SM530, SM820, SM830) should conduct a regular self-checking within 1 year, and the check results must be kept more than 3 years.

Boiler and pressure container safety rules
<p>Article 94 (Regular self-checking)</p> <ol style="list-style-type: none">1. When the enterprise uses small boiler and small pressure container, it must conduct a regular self-checking within 1 year (check items as below). However, if not using for more than 1 year, the non-application period is not subject to this restriction.<ol style="list-style-type: none">1) Check if there is damage or abnormality at the unit body, combustion device, auto-control device and accesories of small boiler.2) Check if there is damage or wear at the unit body, cover screws tightening, piping and valve of small pressure container.2. When the enterprise needs to use the aforesaid small boiler and small pressure container (not using for 1 year) again, it must conduct a self-checking according to the check items before using.3. The enterprise must keep the check results of the above contents for more than 3 years.
<p>Article 95 (Repairing, etc.)</p> <p>When the enterprise detects abnormalities during self-checking, please conduct repairing and take other maintenance measures.</p>

Please refer to following items to check and keep it.

In addition, if the customer is hard to conduct self-checking, please contact your dealer or Yamato service office.

17. Regular Spot Check

Regular self-checking of small pressure container

Check procedure

-Tools-	
Preparation	<ul style="list-style-type: none">① Tool Cross screwdriver · monkey wrench ×2② Calibrated temp. sensor and temp. recorder, measuring to 200°C③ Calibrated pressure gauge with 0.4Mpa pressure range④ Pressurizing device (compressor or high pressure bottle of non-flammable gas able to be pressurized to 0.3Mpa, available for using automobile air)⑤ Pressure resistance rubber hose (I.D.12 mm) · tape and connector
External check	<ul style="list-style-type: none">① Confirm no damage, rusting, deformation, etc. at chamber and cover.② Confirm no damage (fracture) at the surface of cover lock. ●If detect damage (fracture), please replace the cover lock.③ Confirm no sliding of cover locking lever when opening the cover.④ Confirm no damage, deformation, etc. of sealing strip. ●If detect damage or deformation, please replace the sealing strip.

17. Regular Spot Check

Regular self-checking of small pressure container

Check procedure

Piping check	<p>① When manually turn the drain valve and solenoid exhaust vale, confirm no looseness and no waterdrops adhering at the installing part. ●If manually turn and waterdrops adhered, it might be loose, please increase torque and tighten it.</p> <p>② When using wrench to rotate lightly to right, the nuts of connection part are not loose, and no waterdrops adhering around. ●If manually turn and waterdrops adhered, it might be loose, please increase torque and tighten it.</p> <p>③ Confirm no damage and adhering waterdrops on pipes. ●If detect damage, or especially waterdrops adhering at pipe connector, please replace the pipe in time.</p>																														
Pressure check	<p>Pressure gauge and safety valve According to the provisions of the local safety administration, deliver to related department to check on time.</p>																														
Temp. accuracy	<p>Use the follwing measures to confirm the temp. accuracy.</p> <p>① Set the calibrated temp. sensor (with recording gauge) or stationary point themometer near the chamber temp. sensor, conduct unloaded sterilize operation (setting: 135℃), and compare the chamber temp. displayed by this unit with the calibrated themometer. When displaying 135℃, the themometer' s should be within 135~137℃. In addition, when setting the temp. sensor, etc., please use optional connector (R1/4 screws).</p> <p>② During sterilizing, compare the sterilize pressure with the temp.. When the atmosphere pressure is 1013hPa, the relationship between the chamber temp. and saturation pressure is as below:</p> <table style="margin-left: 40px;"> <tr> <td>115℃</td><td> . . .</td><td>0.068MPa,</td><td>133℃</td><td> . . .</td><td>0.187MPa</td> </tr> <tr> <td>121℃</td><td> . . .</td><td>0.104MPa,</td><td>134℃</td><td> . . .</td><td>0.202MPa</td> </tr> <tr> <td>126℃</td><td> . . .</td><td>0.138MPa,</td><td>135℃</td><td> . . .</td><td>0.210MPa</td> </tr> <tr> <td>131℃</td><td> . . .</td><td>0.170MPa,</td><td>136℃</td><td> . . .</td><td>0.221MPa</td> </tr> <tr> <td>132℃</td><td> . . .</td><td>0.171MPa,</td><td>137℃</td><td> . . .</td><td>0.231MPa</td> </tr> </table>	115℃	. . .	0.068MPa,	133℃	. . .	0.187MPa	121℃	. . .	0.104MPa,	134℃	. . .	0.202MPa	126℃	. . .	0.138MPa,	135℃	. . .	0.210MPa	131℃	. . .	0.170MPa,	136℃	. . .	0.221MPa	132℃	. . .	0.171MPa,	137℃	. . .	0.231MPa
115℃	. . .	0.068MPa,	133℃	. . .	0.187MPa																										
121℃	. . .	0.104MPa,	134℃	. . .	0.202MPa																										
126℃	. . .	0.138MPa,	135℃	. . .	0.210MPa																										
131℃	. . .	0.170MPa,	136℃	. . .	0.221MPa																										
132℃	. . .	0.171MPa,	137℃	. . .	0.231MPa																										

17. Regular Spot Check

Regular self-checking of small pressure container

-Check item log sheet-

Check item		Check time	Date	Date	Date	Date
Chamber	Damage, rusting, deformation					
Cover	Damage, rusting, deformation					
Cover lock	Damage (fracture, rusting)					
Sealing strip	Damage, deformation					
Drain valve	Loose installation, water leakage					
Solenoid exhaust valve	Loose installation, water leakage					
Safety valve	Working pressure					
Pipe, connector	Damage, loose, water leakage					
Pressure gauge	Confirm pressure precision					
Temp. accuracy	Confirm temp. accuracy					
Check						
Approve						

• Tick ✓ if no above phenomena. If there is abnormality, handle it and record.

Responsibility

Please follow the instructions in this document when using this unit. Yamato Scientific has no responsibility for the accidents or breakdown of device if it is used with a failure to comply. Never conduct what this document forbids. Unexpected accidents or breakdown may result in.

Note

- ◆ The contents of this document may be changed in future without notice.
- ◆ Any books with missing pages or disorderly binding may be replaced.

Instruction Manual
Vertical Pressure Steam Sterilizer
SM520 SM530 SM820 SM830
First Edition October 23, 2014
Revision

Yamato Scientific America Inc.
925 Walsh Ave.
Santa Clara, CA 95050
Toll Free (800)292-6286
Fax (408)235-7730
www.yamato-usa.com
technical@yamato-usa.com
customerservice@yamato-usa.com