

CO₂ Transcritical Test and Charging Manifold



OWNER'S MANUAL

PN 45925 and 45930



DO NOT TRAP LIQUID R744 IN THE HOSES OR MANIFOLD AS HOSES MAY BURST.

R744 LIQUID WILL INCREASE IN PRESSURE BY 10 BAR (145 PSI) FOR EVERY 1° C (1.8° F) TEMPERATURE INCREASE.

Due to the unusually high pressures and hazardous gasses used in refrigeration and air conditioning, only TRAINED refrigeration and air conditioning technicians should use this equipment. Proper procedures must be used.

Section 608 of the Federal Clean Air Act requires that all persons who maintain, service, repair, or dispose of appliances must be certified since November 14, 1994. Failure to comply can cost you and/or your company as much as \$25,000 per day, per violation. The EPA also offers a reward up to \$10,000 for providing information concerning violations to the Act.

PROCEDURES

The various service and testing procedures below can be performed after the manifold gauge set has been installed as shown in the following diagrams.

KEY:

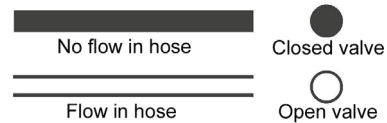
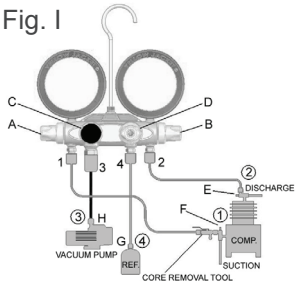

Fig. I



I. TO PURGE HOSES BEFORE HOOKING UP

- 1 & 2 Connect hoses at E & F; Do not tighten
- C & D Close valves
- 4 Connect hose G to refrigerant
- A & B Open valves
- D & G Crack D & G valve to begin purge
- E & F Tighten hose

Fig. II

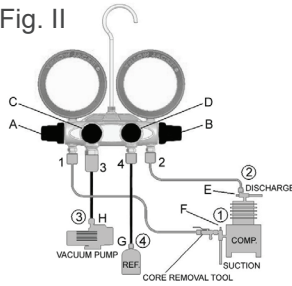

II. TO OBSERVE OPERATING PRESSURES

- A & B Close valves
- C & D Close valves
- 1 & 2 Connect hoses as illustrated
- E & F Crack open back seat

III. TO CHARGE REFRIGERATION SUCTION (VAPOR) SIDE WITH Schraders

- Purge as in I
- Charge as in IV

Fig. IV

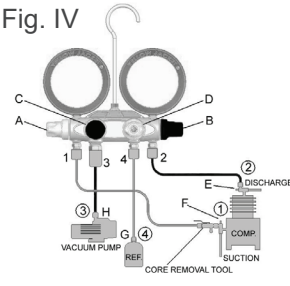

IV. TO CHARGE REFRIGERATION SUCTION (VAPOR) SIDE

- Purge as in I
- 4 Connect hose G to refrigerant
- A Open valve
- B & C Close valves
- D Open valve and throttle
- F Crack front seat

Over-pressuring the gauge voids warranty

PROCEDURES, cont.

Fig. V

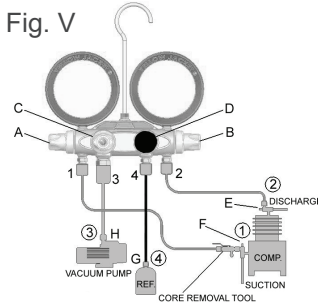

- V. TO PULL VACUUM
- D Close valve
- H Connect hose 3 to pump
- C Open valve
- A & B Open valves
- E & F Mid position valves

VI. TO SET LOW SIDE CONTROL BUILD UP PRESSURE

Disconnect pressure control line. Using flare union, screw union into control line and other end of hose 1.

- B, C & D Close valves
- A Open valve
- E Back seat then crack open
- F Back seat F
- B Open to regulate pressure; set control

Fig. VI

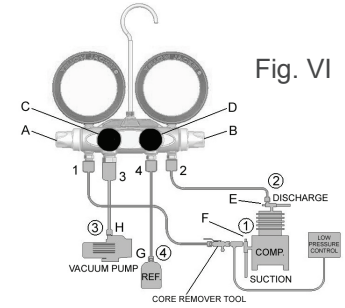

REMOVING MANIFOLD FROM THE SYSTEM

After completing service operations, you must remove the manifold from the system without losing refrigerant or admitting air.

1. Close valves E & C
2. Then open manifold valves A, B and D, 1/2 turn
3. Close valve F
4. Disconnect H from vacuum pump
5. Secure hose 3 so it cannot move when venting
6. Open valve C to vent stored CO₂

This arrangement will move all the high-pressure refrigerant from the line and the high-pressure gauge and put it into the low side. Remove hoses from system.

PARTS LIST

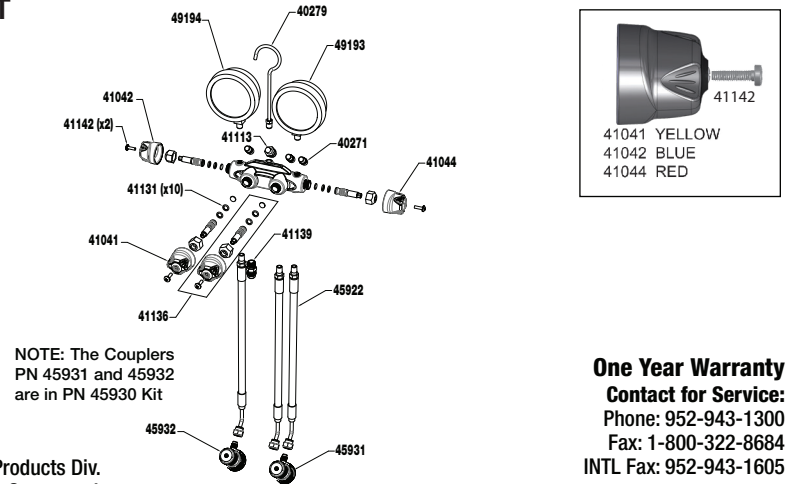

NOTE: The Couplers PN 45931 and 45932 are in PN 45930 Kit

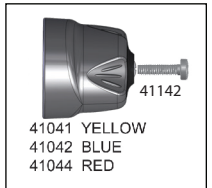

41041 YELLOW
41042 BLUE
41044 RED

YELLOW JACKET® Products Div.
Ritchie Engineering Company, Inc.
10950 Hampshire Avenue South
Bloomington, MN 55438-2623

Printed in USA P/N 500779_B

One Year Warranty
Contact for Service:
Phone: 952-943-1300
Fax: 1-800-322-8684
INTL Fax: 952-943-1605

custserv@yellowjacket.com
www.yellowjacket.com