



YELLOW JACKET®

USER AND MAINTENANCE MANUAL



Combustion Analyzer CA502

RevA

1.0	IMPORTANT INFORMATION	05
1.1	Information about this manual	05
1.2	Danger levels and other symbols	05
2.0	SAFETY	06
2.2	Safety check	06
2.2	Intended purpose	06
2.3	Improper use of the product	06
2.4	Precautions for the usage of the Li-Ion battery package	06
3.0	WORKING PRINCIPLE	07
3.1	General overview of the analyzer	07
4.0	DESCRIPTION OF THE PRODUCT	08
4.1	Working principle	08
4.2	Measurement cells	08
4.3	Fuel types	08
4.4	Sample treatment	08
4.5	Pressure sensor, piezoelectric, temperature compensated	08
4.6	Suction pump	08
4.7	Draft measurement with sensor automatic autozero	08
4.8	Bluetooth® connection	09
4.9	IR connection	09
4.10	Available software and applications	09
5.0	COMPONENTS DESCRIPTION	10
5.1	Instrument interface	10
6.0	TECHNICAL SPECIFICATIONS	12
6.1	Technical specifications	12
6.2	Measurement and Accuracy Ranges	13
7.0	USING THE FLUE GAS ANALYZER	14
7.1	Preliminary operations	14
7.2	Warning	14
7.3	Analyzer power supply	14
	7.3.1 Internal battery charge level	14
	7.3.2 Use with external power pack	15
7.4	QR code generation	15
7.5	Connection diagram	16
8.0	FLUE GAS ANALYSIS	17
8.1	Flue gas analysis	17
	8.1.1 Switching on the instrument and out-calibration	17
	8.1.2 Preliminary operations	18
	8.1.3 Inserting the probe inside the stack	18
	8.1.4 Performing the combustion analysis - manual mode	19
	8.1.5 Performing the combustion analysis - auto mode	20
	8.1.6 End of the analysis	22



9.0	INSTRUMENT PARAMETER	24
9.1	Setting Menu	24
10.0	MEASUREMENTS	25
10.1	Menu→Measurements	25
10.2	Menu→Measurements→Comb. analysis	26
10.3	Menu→Measurements→Draft	27
10.4	Menu→Measurements→CO air	28
10.5	Menu→Measurements→Pressure	29
11.0	MEMORY	30
11.1	Menu→Memory	30
12.0	CONFIGURATION	33
12.1	Menu→Configuration	33
12.2	Menu→Configurationan→Analysis	34
12.2.1	Menu→Configuration→Analysis→Fuel	35
12.2.2	Menu→Configuration→Analysis→Condensation	36
12.2.3	Menu→Configuration→Analysis→O2 Reference	37
12.2.4	Menu→Configuration→Analysis→Measure units	38
12.2.5	Menu→Configuration→Analysis→Autozero	39
12.2.6	Menu→Configuration→Analysis→Air temp	40
12.3	Menu→Configurationan→Instrument	41
12.3.1	Menu→Configuration→Instrument→Display	42
12.3.2	Menu→Configuration→Instrument→Clock	43
12.3.3	Menu→Configuration→Instrument→Bluetooth®	44
12.4	Menu→Configuration→Alarm	45
12.5	Menu→Configuration→Print	46
12.5.1	Menu→Configuration→Print→Pairing	47
12.6	Menu→Configuration→Language	48
12.7	Menu→Configuration→Reset	49
13.0	DIAGNOSTIC	50
13.1	Menu→Diagnostic	50
13.1.1	Menu→Diagnostic→Sensors	51
13.1.2	Menu→Diagnostic→Gas probe	52
13.1.3	Menu→Diagnostic→Hardware	53
14.0	INFO SERVICE	54
15.0	SENSORS	55
15.1	Sensors→Sensors arrangement	55
15.2	Sensors→Sensor types and relevant positioning	55
15.3	Sensors→Gas sensors life	55
15.4	Sensors→Gas sensors life table	55
16.0	MAINTENANCE	56

16.1	Maintenance→Routine maintenance	56
16.2	Maintenance→Preventive maintenance	56
16.3	Maintenance→Gas sensors replacing	57
16.4	Maintenance→Replacing the battery pack	59
17.0	FIRMWARE UPDATE	60
18.0	TROUBLESHOOTING	61
18.1	Troubleshooting→Troubleshooting guide	61
19.0	SPARE PARTS AND SERVICING	63
19.1	Spare parts and servicing→Spare parts	63
19.2	Spare parts and servicing→Accessories	63
19.3	Spare parts and servicing→Service Centers	63
	ANNEX A - Analysis report examples	64
	ANNEX B - Optional measurements list	65
	Measurement units matching → abbreviations	66
	ANNEX C - Coefficients of the fuels and Formulas	67
	WARRANTY CERTIFICATE	68

YELLOW JACKET® - ALL RIGHTS RESERVED -

Total or partial reproduction of this document by any means (including photocopying or storage on any electronic medium) and transmittal of same to third parties in any manner, even electronically, is strictly prohibited unless explicitly authorized in writing by YELLOW JACKET®.

1.1 Information about this manual

- This manual describes the operation and the characteristics and the maintenance of the YELLOW JACKET® Combustion Analyzer model CA502.
- Read this operation and maintenance manual before using the device. The operator must be familiar with the manual and follow the instructions carefully.
- This use and maintenance manual is *subject to change due to technical improvements - the manufacturer assumes no responsibility for any mistakes or misprints.*

1.2 Danger levels and other symbols

	<p>The magnets in the back of the instrument can damage credit cards, hard drives, mechanical watches, pacemakers, defibrillators and other devices proven sensitive to magnetic fields.</p> <p>It is recommended to keep the instrument at a distance of at least 10 inches away from these devices.</p>
--	---

Symbol	Meaning	Comments
--------	---------	----------



WARNING

Read information carefully and prepare safety appropriate action!

To prevent any danger from personnel or other goods. Violating the information in this manual may cause danger to personnel, the plant or the environment and may lead to liability loss.

15/04/19 10:00

Info ser. [1/2]

YELLOW JACKET®
 4266 E. Street Road
 Treiose, PA 19053
 Tel: (952) 943-1300
 Email: custserv@yellowjacket.com

Information on LCD



Disposal Indications

Dispose of the battery pack at the end of its working life only at the dedicated collecting bin.

This device must not be disposed in the trash or municipal recycling bins.

Dispose of the device according to national standards.

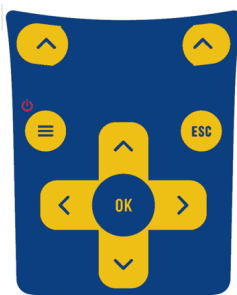

Keyboard with preformed keys with main control functions.

2.1 Safety check

- Use the product according to what is described in the section “Intended purpose”.
- During the instrument operation, comply with the current standards.
- Do not use the instrument if damaged on the outer cover, on the power supply plug or on the cables.
- Do not take measures on non-isolated components / voltage conductors.
- Keep the instrument away from solvents.
- For the maintenance of the instrument, strictly comply with what’s described in this manual at the “Maintenance” chapter.
- All the updates or changes not specified in this manual, may be performed exclusively by YELLOW JACKET® service centers. YELLOW JACKET® is not responsible for changes performed by noncertified service centers or for the operation of the instrument and on the validity of the certification.

2.2 Intended purpose

This chapter describes the areas of application for which the CA502 is intended.

Using the CA502 in other application areas transfers the risk to the operator and the manufacturer assumes no responsibility and liability for loss, damage or costs which could be a result. It is mandatory to read and pay attention to the Use And Maintenance manual.

All products of the series CA502 are handheld measuring devices in professional flue gas analysis for:

- Small furnaces (burning oil, gas, wood, coal)
- Low-temperature and condensing boilers
- Gas heaters

2.3 Improper use of the product

The CA502 should not be used:

- As safety alarm instrument
- In classified zones with explosion risk (ATEX or equivalent)

2.4 Precautions for the usage of the Li-Ion battery package

Pay attention while handling the battery package inside the instrument; a wrong or improper usage may lead to heavy physical injuries and/or damages:

- Do not create a short circuit: make sure that the terminals are not in contact with metal or other conductive materials during transportation or storage.
- Do not apply with inverted polarities.
- Do not make the batteries come in contact with liquid substances.
- Do not burn the batteries nor expose to temperature higher than 140 °F (60°C).
- Do not try to disassemble the battery.
- Do not provoke collisions or pierce the batteries. Improper use can cause damages and internal short circuits not always externally visible. If the battery package has fallen or has been hit with an hard surface, regardless the external shell condition:
 - Stop operation
 - Dispose of the battery in compliance with the disposal instructions
- Do not use batteries with leaks or damages.
- Charge the batteries only inside the instrument.
- If a malfunction occurs or if over heating signs occur, immediately remove the battery package from the instrument. **Warning: the battery may be hot.**

3.1 General overview of the Analyzer

CA502 is a portable industrial analyzer for flue gas and emissions monitoring.

The instrument is equipped with:

- Pneumatic line able to manage up to 2 sensors.
- Easy and immediate user interface so it could be used without the manual support.
- Wide and bright graphic display, White / Black 2" x 2" (50x55 mm).
- Rechargeable 'Li-Ion' battery.
- Supplied with the device is a charging cord with output 5V $\overline{=}$, 2A to charge the internal batteries. When needed, it is possible to recharge the instrument battery using a power bank, as long as it is equipped with 5 volts output and 1A minimum current.

Main functions:

- Combustion analysis in manual.
- Comes with the 15 most used fuels (such as natural gas, LPG, gas oil and fuel oil).
- Generation and visualization of a QR code with the purpose of downloading the data of the acquired measures, having installed the YJ Combustion App which can be downloaded from the AppStore and PlayStore

Measured values:

- O₂
- CO
- Combustion air temperature
- Gas pressure in the piping, pressure in the burning chamber and check of the pressure switches, using the measurement range up to 5.9 in hg (200hPa).
- Pressure measurement
- Pressure measurement of the gas inlet line
- CO environment measurement (via the internal sensor)
- Draft measurement

Calculated values:

- Stack leaks
- Combustion efficiency
- CO₂
- NO_x
- Air excess
- Poison index (CO/CO₂ ratio)

Maintenance:

- O₂ Sensors can be replaced by the user without having to ship the instrument to the service center, because the spare sensors delivered are pre-calibrated.
- The instrument requires annual calibration.

Certificate of calibration

The instrument is accompanied with a calibration certificate, according to the ISO/EN 17025 standard.

4.1 Working principle

- The gas sample is taken in through the gas probe, by a diaphragm suction pump inside the CA502.
- The measuring probe has a sliding cone that allows the probe to be inserted in holes with a diameter of 11 mm to 16 mm and to adjust the immersion depth: **it is recommended to have a gas sampling point roughly in the center of the flue/stack.**
- The gas sample is cleaned of moisture and impurities by a condensate trap and filter located in-line in the tubing for the CA502.
- The gas is then analyzed in its components by an on-board electrochemical cell.
- The electrochemical cell guarantees high precision results in a time interval of up to about 60 minutes during which the CA502 can be considered very stable.
- When measurements are going to take a long time, we suggest auto-zeroing the CA502 again and flushing the inside of the pneumatic circuit with clean air.
- During the zero calibrating phase, the instrument aspirates clean air from the environment and detects the cells' drifts from zero (20.95% for the O₂ cell), then compares them with the programmed values and compensates them.

4.2 Measurement cells

- The instrument takes advantage of pre-calibrated gas sensors for the measurement of Oxygen (O₂), Carbon Monoxide (CO) and optional Nitric Oxide (NO/NO_x).
- The sensors do not need particular maintenance, however, they have to be replaced periodically when they reach their end of life.
- If sensors of toxic gases are used with concentrations higher than 50% of their measurement range for more than 10 minutes continuously, they can show up to a $\pm 2\%$ drift as well as a longer time to return to zero.
- In this case, before turning off the analyzer, it is advisable to wait for the measured value to be lower than 20ppm by intaking clean air.
- The CA502 is intended to have a cleaning cycle of the pneumatic circuit. The duration of the cycle depends on what has been set in the menu Configuration→Analysis→Autozero.
- Used O₂ sensors can be easily replaced by the user without a complicated calibration procedure with certified mixtures as they are pre-calibrated before being shipped.
- YELLOW JACKET® certifies the accuracy of the measurements only with a calibration certificate issued by its laboratory or other approved laboratory.

4.3 Fuel types

The CA502 device is provided with the technical data of the most common types of fuels stored in its memory. For more details see [Appendix C](#). Coefficients of the Fuels and Formulas

4.4 Sample treatment

The flue gas suction line has an inline anti-condensation trap with dust filter. The trap and filter condition the gas sample to be analyzed to be properly dried and cleaned of solid residues of combustion.

4.5 Pressure sensor, piezoelectric, temperature compensated

- The CA502 has a piezoresistive differential pressure sensor which can be used for measuring the draft (vacuum) in the stack for differential pressure measurement and possibly for other measurements (pressure of gas in the piping, pressure loss across a filter, etc.).
- The measurement range is -2.95 in hg to 5.9 in hg (-10,000 Pa .. +20,000 Pa.)
- Drift of the sensor is minimized with the autozeroing built into the system.



WARNING

ANY PRESSURE APPLIED TO THE SENSOR GREATER THAN ± 8.89 inHg (± 300 hPa) MAY CAUSE A PERMANENT DEFORMATION OF THE MEMBRANE, THUS DAMAGING IRREVERSIBLY THE SENSOR ITSELF.

4.6 Suction pump

The diaphragm pump located inside the instrument, is operated with a DC motor. It is used to obtain the optimal suction flow rate of the flue gas for the ongoing analysis.

4.7 Draft measurement with sensor automatic autozero

- CA502 performs the draft measurement.
- The sensor autozero allows for zeroing of the sensor and must be done with the gas probe **NOT** inserted in the stack.

4.8 Bluetooth® connection

- The CA502 analyzer is equipped with a Bluetooth® module, which allows the communication with a remote Bluetooth® printer
- The maximum transmission range in open field is 100 meters (Class 1 Bluetooth® module), provided that the communication companion is also equipped with a Class1 Bluetooth® interface.
- This option allows freedom of movement for the operator who is no longer tied directly to the instrument for acquisition and analysis.

4.9 IR connection

The CA502 analyzer is equipped with an infrared light interface which uses the HP-IR protocol, which allows the communication with a remote IR printer.

4.10 Software and available applications

YJ Combustion App

This APP, allows the user the ability to scan the QR code generated by the CA502 to download the data of the performed analyses and/or measures and store, email, or print the report.

5.1 Instrument interface

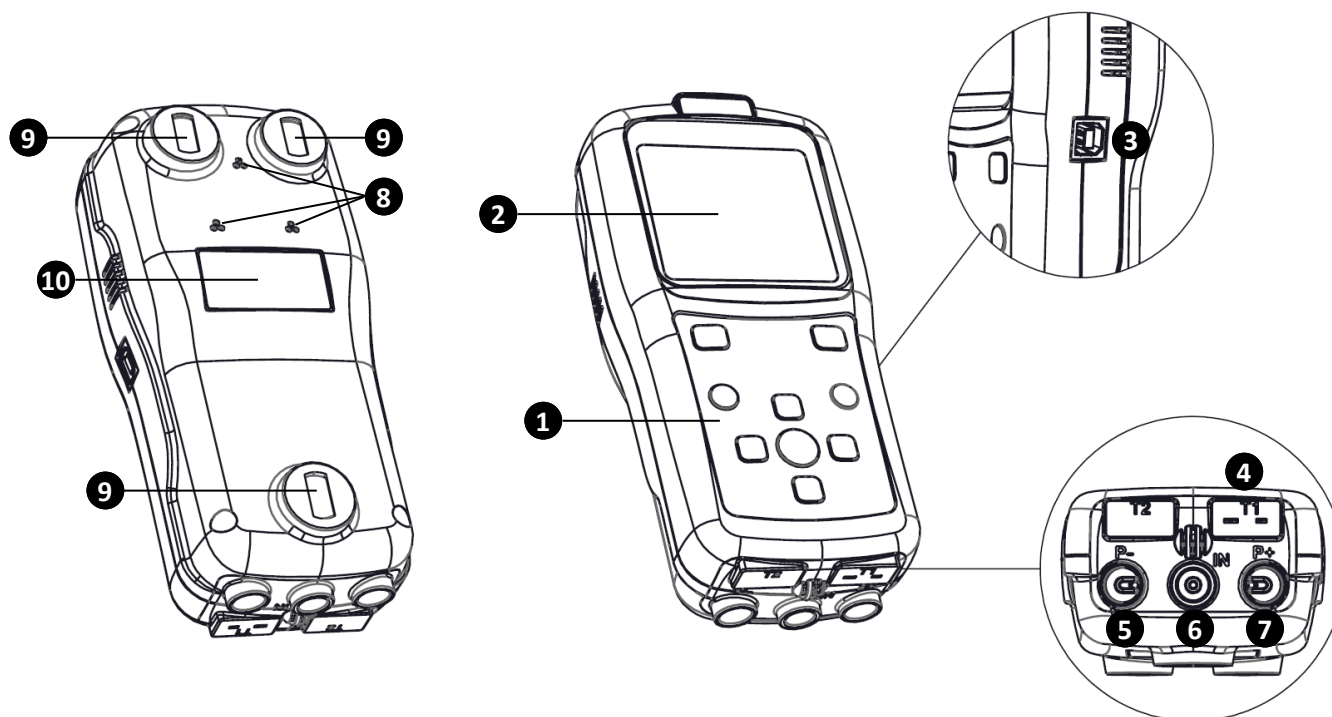

DESCRIPTION:

1 Keyboard with key functions:

KEYS	FUNCTION
	Activates the context keys shown on the display.
	<ul style="list-style-type: none"> - Turns on and off the instrument. - If pressed briefly, accesses the instrument menu. - If pressed for at least 2 seconds, turns off the instrument.
	Exits the current screen.
	Confirm settings.
	Select and/or Modify.

2 Display

LCD backlit Display, White/Black 128 x 128 pixel with white LEDs.

CAUTION:

If the instrument is exposed to extremely high or extremely low temperatures, the quality of the display may be temporarily impaired. Display appearance may be improved by pressing on the contrast key.

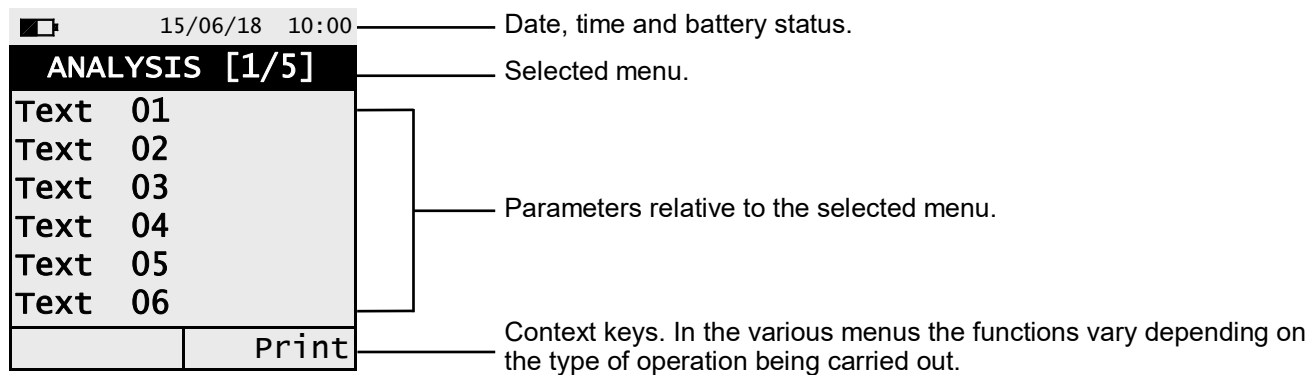

3 B-Type USB connector

Connector to connect the device to a personal computer or to the battery charger. The device comes with a wall charger with 5V $\overline{=}$, 2A output to charge the internal batteries.

4 'T1' Connector

Used to connect the Tc-K male connector of the gas temperature probe.

5 'P-' pneumatic connector

Negative input (P-) to be used for the connection of the flue gas probe.

6 'IN' pneumatic connector

Input for the connection of the branch of the gas sampling probe with the condensation separating and anti-dust filter assembly.

7 'P+' pneumatic connector

Positive input (P+): For draft measurement (with optional manometer tube kit (68620)).

8 Gas vents

9 Magnets

10 Instrument data label.

6.1 Technical specifications

Power:	Li-Ion battery pack with internal protection circuit.
Average life of the battery package:	500 empty / full charge cycles.
Battery charger:	External 5Vdc 2A battery charger with female A-type USB connector + connection to the device with the -serial communication cable supplied.
Charging time:	5 hours to charge from 0% to 90% (6 hours for 100%). The device can also be charged by connecting it to the PC, the device must be turned off, the charging time depends on the output current from the PC and may be more than 12 hours.
Instrument working time:	8 hours of non-stop operation with display brightness at 50%.
Display:	Graphic white LED backlit White / Black, 128 x 128 pixel
<u>Connectivity:</u>	
Communication port:	USB connector type B.
Bluetooth®:	Class 1. Communication distance <328' (100 meters) (in open field)
Infrared interface:	For external printer (optional) using protocol HP-IR.
Autozero:	Settable (30 .. 600 seconds)
Gas measurement sensors:	Up to 3 electrochemical sensors
Type of combustible:	12 predefined by the factory.
Self-diagnosis:	Checks all functions and internal sensors and reports any abnormal operation.
Temperature measurement:	Input for thermocouple type K with mignon connector (ASTM E 1684-96) for the temperature measurement.
Room temperature measurement:	Through the internal sensor and/or acquisition through the gas probe positioned in air.
Internal data memory:	5 complete analyses.
Suction pump:	0.26 gal. per minute (1.0 l/min) of flue gas at 32.15 inH ₂ O (80hPa).
<u>Condensate trap:</u>	
Type:	Outside the instrument.
Line filter:	With replaceable filter (68612), 99% efficient with 20um particles.
Condensing boiler efficiency:	Automatic recognition of the condensing boiler, with calculation and printout of efficiency (>100%) on the LHV (Lower Heating Value).
Environmental gases:	Measurement and separate printout of the ambient CO values.
Draft test:	By using the internal sensor connected to the port P+.
Operating temperature range:	23°F .. 113°F (-5°C .. +45°C)
Storage temperature range:	-4°F .. 122°F (-20°C .. +50°C)
Humidity limit:	20% .. 80% RH
Protection grade:	IP42
Air pressure:	Atmospheric
Outer dimensions:	Analyzer: 2.8 x 2.4 x 6.7 inches (Width x Depth x Height) Case: 15.7 x 11.4 x 4.7 inches (Width x Depth x Height)
Weight:	Analyzer: ~ 0.77lbs (12.3 Oz)

6.2 Measurement and Accuracy Ranges

MEASUREMENT	SENSOR	RANGE	RESOLUTION	ACCURACY	RESPONSE TIME T90	
O ₂	Electrochemical sensor	0 .. 21.0% vol	0.1% vol	±0.2% vol	<20 sec.	
CO high H ₂ immunity with NO _x filter	Electrochemical sensor	0 .. 4000 ppm	1 ppm	±20 ppm ±5% measured value	0 .. 400 ppm 401 .. 4000 ppm	<30 sec.
NO	Electrochemical sensor	0 .. 2000 ppm	1 ppm	±5 ppm ±5% measured value ±10% measured value	0 .. 100 ppm 101 .. 1000 ppm 1001 .. 2000 ppm	<40 sec.
NO _x	Calculated					
CO ₂	Calculated	0 .. 99.9% vol	0.1% vol			
PI* (CO/CO ₂ ratio)	Calculated		0.01%			
Air temperature	TcK sensor	-4 .. 248 °F (-20 to 120 °C)	0.2 °F (0.1 °C)	±1 °F (±0.5 °C)	<30 sec.	
Flue gas temperature	TcK sensor	-4 .. 1472 °F (-20 to 800 °C)	0.2 °F (0.1 °C)	±1 °F (±0.5 °C) ±1% measured value	32 .. 212 °F (0 to 100° C) 213 .. 1472 °F (101 to 800°C)	<30 sec.
Pressure (draft & differential)	Piezoelectric sensor	-40 .. 80 "H ₂ O	0.004 "H ₂ O	±1% measured value ±0.008 "H ₂ O ±1% measured value	-40 .. +0.8 "H ₂ O -0.8 .. +0.8 "H ₂ O +0.8 .. +80 "H ₂ O	<10 sec
Differential temperature	Calculated	32 .. 2282 °F (0 to 1250°C)	0.2 °F			
Air index	Calculated	0.00 .. 9.50	0.01			
Excess air	Calculated	0 .. 850 %	1 %			
Stack loss	Calculated	0.0 .. 100.0 %	0.1 %			
Efficiency	Calculated	0.0 .. 100.0 %	0.1 %			
Efficiency (condensing)	Calculated	0.0 .. 120.0 %	0.1 %			

* The Poison Index ratio (P.I.) is a reliable indicator of a boiler or burner good operation. It only takes a simple flue gas test to determine whether or not a service is needed to fix the system.

7.1 Start up

Remove the instrument from its packing and check it for damage. Make sure that the content corresponds to the items ordered. If signs of tampering or damage are noticed, notify the YELLOW JACKET® service center or agent immediately and keep the original packing. A label at the rear of the analyzer bears the serial number. This serial number should always be stated when requesting technical assistance, spare parts or clarification on the product or its use. Yellow Jacket maintains an updated database for each and every instrument. Before using for the first time we recommend you charge the batteries completely.

7.2 WARNING

- Use the instrument with an ambient temperature between 73°F and 113°F (23°C and +45°C).



IF THE INSTRUMENT HAS BEEN KEPT AT VERY LOW TEMPERATURES (BELOW OPERATING TEMPERATURES) WE SUGGEST WAITING A WHILE (1 HOUR) BEFORE SWITCHING IT ON TO HELP THE SYSTEM'S THERMAL BALANCE AND TO PREVENT CONDENSATE FORMING IN THE PNEUMATIC CIRCUIT.

- Do not extract flue gas samples directly without using a particulate/water trap.
- Do not use the instrument if the filters are clogged or damp.
- Do not exceed sensor overload thresholds.
- When it has finished being used, before turning the CA502 off remove the probe and let it circulate ambient clean air for at least 30 seconds to purge all traces of gas.
- Before putting the measuring probe back in its case after use, make sure it has cooled down enough and there is no condensate in the tube. It might be necessary to periodically disconnect the filter and the condensate separator and blow compressed air inside the tube to eliminate all residues.
- Remember to have the instrument checked and calibrated once a year in order to comply with the existing standards.

7.3 Analyzer power supply

- The CA502 contains a high-capacity Li-Ion rechargeable battery.
- The battery powers up the CA502 and any other probes or remote devices that may be connected. The CA502 runs for approximately 8 hours if the printer is not used and with display brightness at 50%. Should the battery be too low to effect the necessary measurements, the CA502 can be hooked up to AC power via the battery charger provided, allowing operations (and analysis) to proceed.
- The battery will be recharged while the CA502 is in use.
- The battery charging cycle takes up to 8 hours for a complete charge and finishes automatically.

ATTENTION: If the CA502 is not going to be used for a long time (for example summertime) we suggest recharging it completely at least once every 4 months.

7.3.1 Internal battery charge level

SYMBOL	BATTERY CHARGE LEVEL
	100%
	80%
	60%
	40%
	20% It's advisable to recharge the battery.
Blinking	Dead battery Recharge the battery - The instrument may not function correctly.



THE INSTRUMENT IS SHIPPED WITH 30% OF THE BATTERY CHARGE CAPACITY, ACCORDING TO CURRENT AIR TRANSPORTATION STANDARDS. IT IS ADVISABLE TO RECHARGE IT COMPLETELY BEFORE USE, TAKING 8 HOURS (ONE NIGHT).

IT IS ADVISABLE TO CHARGE THE BATTERY AT AN AMBIENT TEMPERATURE RANGING BETWEEN 50°F AND 86°F (10°C AND 30°C).

The display constantly shows the internal battery charge level shown with the symbol in the upper left corner of the display. According to the charging level of the battery, the CA502 can be left in storage for a time correlated to the battery level itself. Below, a table that explains the correlation between battery charging level and storage time.

BATTERY CHARGE LEVEL	STOCK TIME
100%	110 days
75%	80 days
50%	45 days
25%	30 days

7.3.2 Use with external power pack

The CA502 can work with the batteries fully discharged by connecting the external battery charger provided.



**THE POWER SUPPLY/BATTERY CHARGER IS A SWITCHING TYPE ONE.
THE APPLICABLE INPUT VOLTAGE RANGES BETWEEN 90Vac AND 264Vac.
INPUT FREQUENCY: 50-60Hz.
THE LOW VOLTAGE OUTPUT IS 5 VOLT WITH AN OUTPUT CURRENT GREATER THAN 1.5A.**

LOW VOLTAGE POWER CONNECTOR: A-TYPE USB CONNECTOR + CONNECTION CABLE WITH B-TYPE PLUG.

7.4 QR code generation

The CA502 is able to generate and display a QR code for the purpose of downloading the data of the acquired measures. Activate the interactive function "Print" visible on the display in the menu configuration, having installed the "YJ Combustion APP" downloadable from the AppStore and the PlayStore.

Minimum requirements for the App installation "YJCombustion"

Operating systems: Android from version 4.1
 Apple (iOS)



THE INSTRUMENT WILL GENERATE THE QR CODE ONLY IF ON THE DISPLAY THE INTERACTIVE FUNCTION "PRINT" IS SHOWN.

7.5 Connection diagram

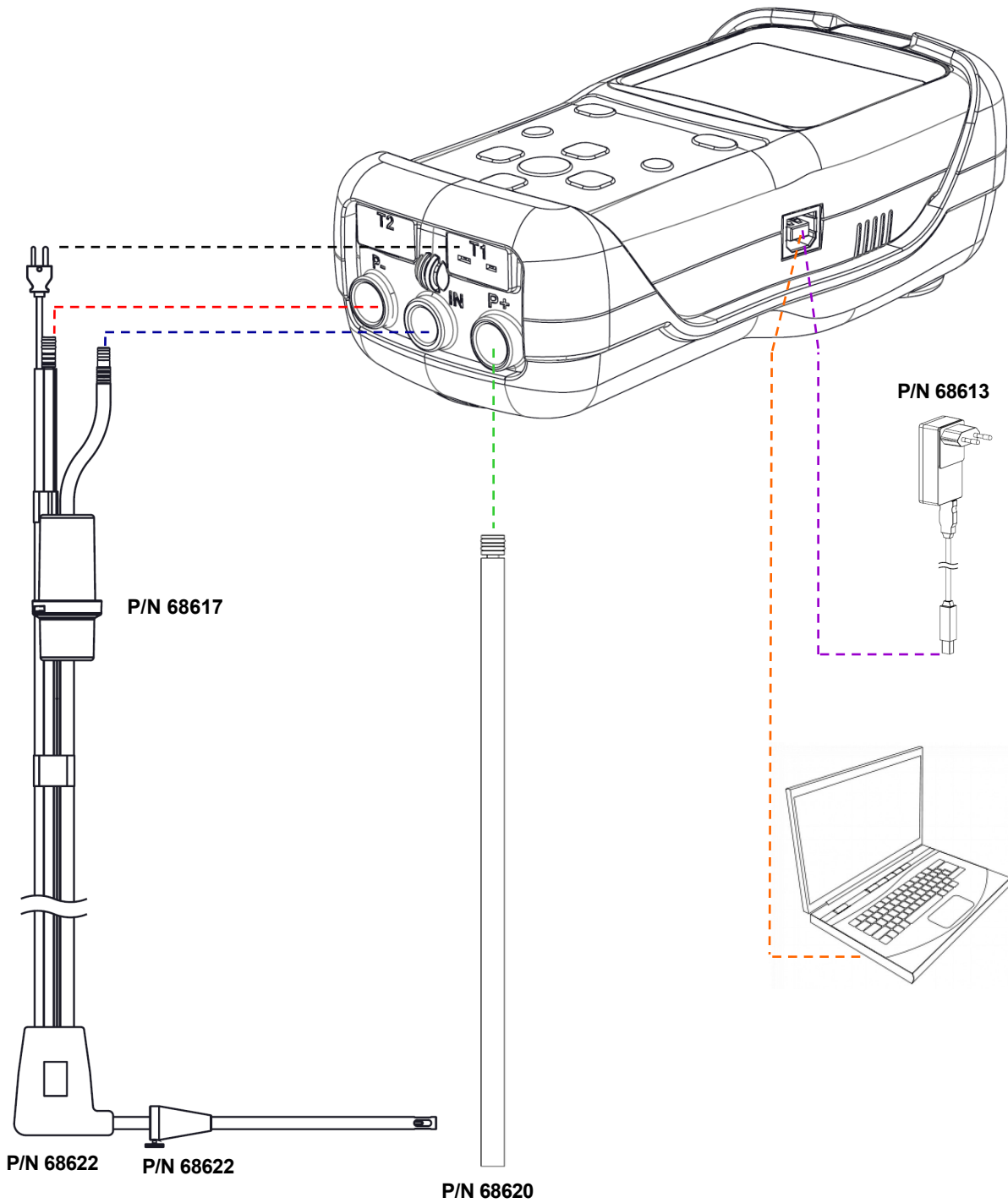

8.1 FLUE GAS ANALYSIS

To perform complete flue gas analysis, follow the instructions below.



SOME IMPORTANT WARNINGS TO CONSIDER DURING THE COMBUSTION ANALYSIS ARE LISTED BELOW:

FOR CORRECT ANALYSIS NO AIR MUST FLOW INTO THE PIPE FROM OUTSIDE DUE TO A BAD TIGHTENING OF THE POSITIONING CONE OR A LEAK IN THE PIPELINE.

THE GAS PIPE MUST BE CHECKED IN ORDER TO AVOID ANY LEAKS OR OBSTRUCTIONS ALONG THE PATH. THE CONNECTORS OF THE GAS SAMPLING PROBE AND OF THE CONDENSATION FILTER MUST BE WELL CONNECTED TO THE CA502. KEEP THE CONDENSATION TRAP IN A VERTICAL POSITION DURING THE ANALYSIS. INCORRECT POSITIONING MAY CAUSE CONDENSATE TO GO IN THE CA502 AND DAMAGE THE SENSORS. AFTER EACH ANALYSIS CHECK FOR ANY PRESENCE OF WATER IN THE CONDENSATE COLLECTION BOWL AND REMOVE IT. PUT THE PROBE BACK IN THE CASE ONLY AFTER YOU HAVE ELIMINATED CONDENSATE FROM THE TUBE AND THE EXPANSION TANK (SEE CHAPTER 'MAINTENANCE'). REPLACE THE FINE DUST FILTER IF IT IS VISIBLY DIRTY OR WET (SEE CHAPTER 'MAINTENANCE'). DO NOT PERFORM ANY MEASUREMENT WHEN THE FILTER IS REMOVED OR DIRTY TO AVOID ANY RISK OF IRREVERSIBLE DAMAGES TO SENSORS AND ANALYZER ITSELF.

8.1.1 Switching on the CA502 and auto-calibration



BEFORE TURNING ON THE CA502:

- CONNECT THE GAS SAMPLING PROBE TO THE DEVICE.
- **STORING OF THE AMBIENT TEMPERATURE: UPON COMPLETION OF THE AUTO ZERO IN FRESH OUTDOOR AIR, PRESS THE “KEEP” BUTTON TO STORE THE OUTSIDE TEMPERATURE BEING USED FOR PRIMARY AIR. IF THE T_c-K CONNECTOR IS NOT PLUGGED IN, THE TEMPERATURE WILL NOT BE CAPTURED.**



Keep pressed for a few seconds



CA502
N.S.:0
Fw:1.00-EVAL03

11/12/17 10:00

AUTOZERO

60

Primary air acquisition

11/12/17 10:00

AUTOZERO

Primary air acquisition
T: 85.5°F

keep
Repeat

11/12/17 10:00

HARDWARE

- ▶Memories KO
- Calibration KO
- voltages
- ADC channels



WARNING!

When the CA502 is turned on, a hardware check is performed on the memory and on the calibration. If an error occurs, it will be shown with the activation of the **Hardware** screen. In this case, it is advisable to restart the CA502. If the problem keeps appearing or becomes a frequent occurrence, please contact the YELLOW JACKET® Service Center, communicating the shown error.

When the autozero phase is complete, press the key “**Keep**”, to proceed with the combustion analysis or press the key “**Repeat**”, to repeat the autozero phase.

8.1.2 Preliminary Operations

The following parameters need to be set prior to performing the combustion analysis:

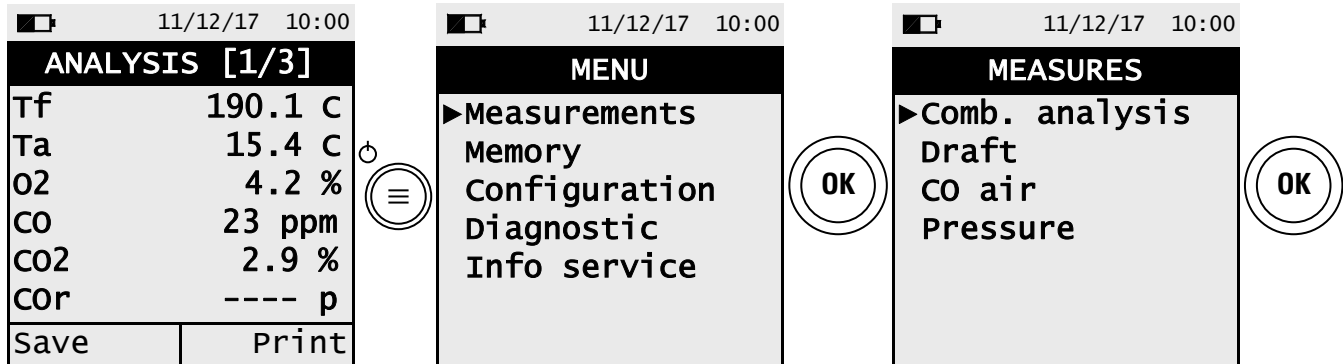

BEFORE PERFORMING THE COMBUSTION ANALYSIS, SET NECESSARY PARAMETERS
[\(SEE CHAPTER 12.2\).](#)

8.1.3 Inserting the probe in the stack

When the autozero is over, insert the gas sample probe into the stack. In order for the probe to be inserted at the right point in the stack, its distance from the boiler has to be twice the diameter of the stack pipe itself or, if this is not possible, comply with the boiler manufacturer’s instructions. In order to position the probe correctly drill a 13/16 mm hole in the stack (unless already present), and screw in the positioning cone provided with the probe. This is done so that no air is drawn from the outside during sampling. The screw on the cone allows the probe to be stopped at the right measurement depth - this usually corresponds to the center of the flue pipe. For greater accuracy, the user may insert the probe gradually into the pipe until the highest temperature is read. The exhaust pipe must be inspected before carrying out the test, to ensure that no restrictions or losses are present in the piping or stack.

8.1.4 Performing the combustion analysis - Manual Mode

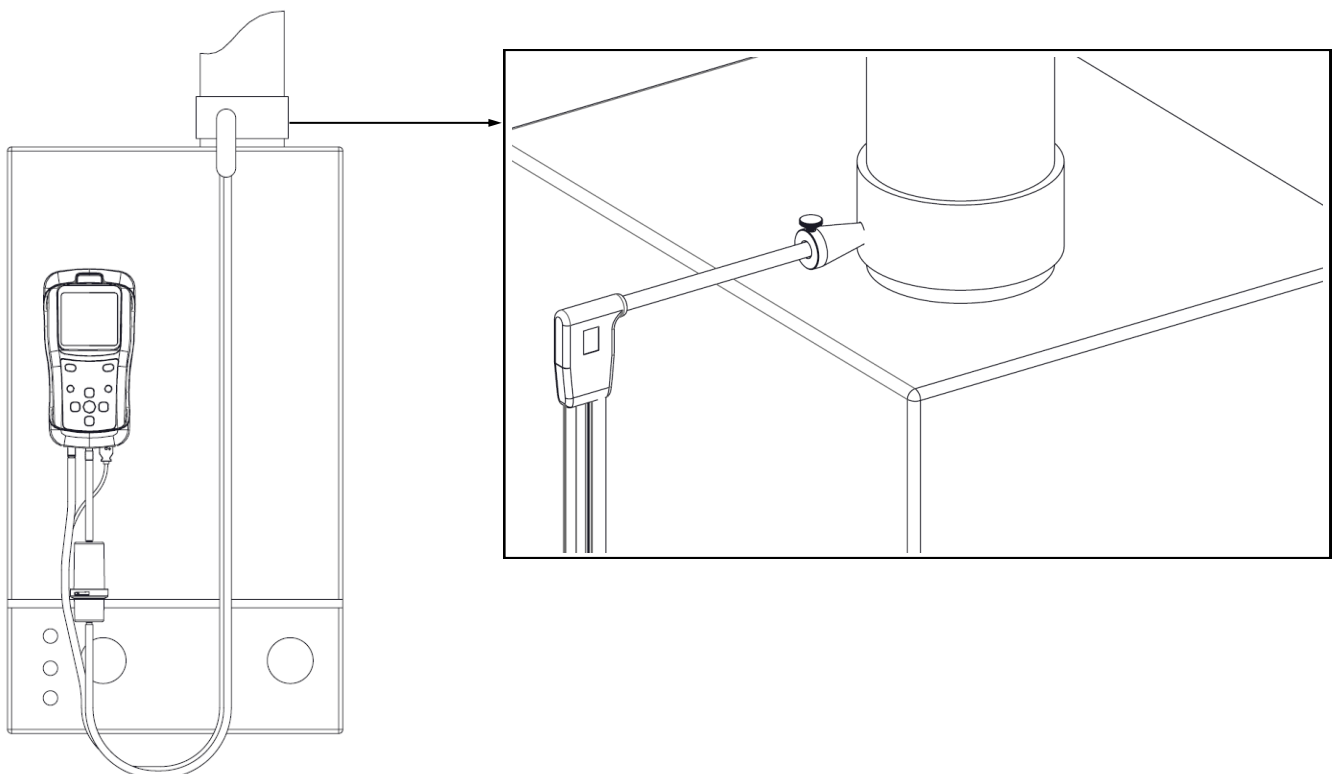

8.1.6 End of the Analysis

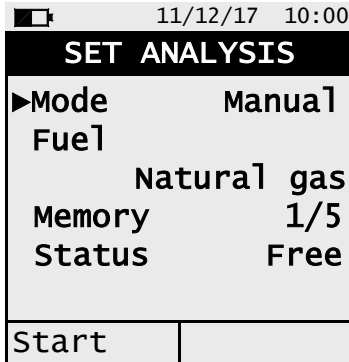

Start

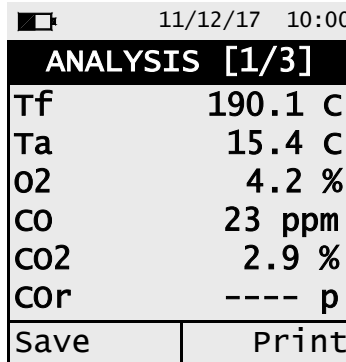

Print

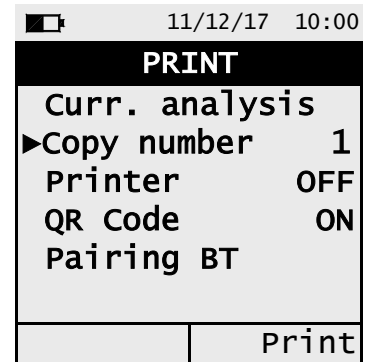

Print

IN THIS SCREEN IT IS POSSIBLE TO MODIFY THE NUMBER OF THE MEMORY IN WHICH THE CURRENT ANALYSIS IS BEING SAVED.
[\(SEE CHAPTER 11.0\)](#)

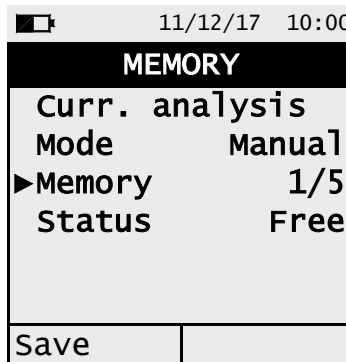

Save

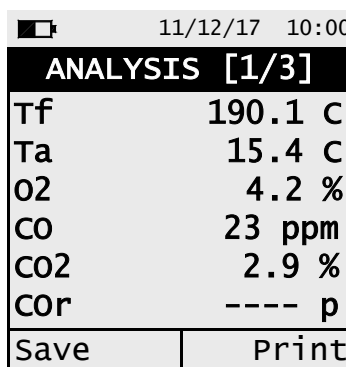

8.1.5 Performing the combustion analysis - Auto Mode

11/12/17 10:00	
AN. SETTINGS	
►Mode	Auto
Fuel	Natural gas
Interval	7 s
Memory	1/5
Start	

Start

11/12/17 10:00	
ANALYSIS [1/3]	
Tf	190.1 C
Ta	15.4 C
O2	4.2 %
CO	23 ppm
CO2	2.9 %
CO _r	---- p
Pause	1/3 7

Automatically stores the first sample when the interval time is over.

11/12/17 10:00	
ANALYSIS [1/3]	
Tf	190.1 C
Ta	15.4 C
O2	4.2 %
CO	23 ppm
CO2	2.9 %
CO _r	---- p
Pause	2/3 7

Automatically stores the second sample when the interval time is over.

11/12/17 10:00	
ANALYSIS [1/3]	
Tf	190.1 C
Ta	15.4 C
O2	4.2 %
CO	23 ppm
CO2	2.9 %
CO _r	---- p
Pause	3/3 7

Automatically stores the third sample when the interval time is over.

11/12/17 10:00	
AVERAGE [1/3]	
O2	4.2 %
CO	23 ppm
CO2	2.9 %
Tf	190.1 C
Ta	15.4 C
Es	91.4 %
	Print

Print



- SCAN THE QR CODE WITH THE YJ COMBUSTION APP IN ORDER TO DOWNLOAD THE RECORDED DATA. THE GENERATED QR CODE IS REFERRING ONLY TO THE AVERAGE OF THE PERFORMED ANALYSIS.

- IF IT IS NEEDED TO PRINT THE AVERAGE ANALYSES AND ADDITIONAL MEASURES TICKET, ENABLE THE PRINTER IN THE MENU "CONFIGURATION→PRINT".

- IF THE COMPLETE ANALYSIS IS DESIRED TO PRINT ON A TICKET AND THE RECORDED MEASUREMENTS, ENTER THE "MEMORY" MENU, SELECT THE RELATED MEMORY NUMBER AND PUSH THE INTERACTIVE FUNCTION KEY "PRINT".

- TO DOWNLOAD THE SINGLE ANALYSIS DATA, IT'S NECESSARY TO ENTER THE "MEMORY" MENU, SELECT THE MEMORY NUMBER USED TO SAVE THE ANALYSES AND THE MEASURES THEN SELECT ONE SINGLE ROW AT A TIME.

(SEE CHAPTER 11.0).



Additional Information

INTERACTIVE OPERATION	DESCRIPTION
<div style="border: 1px solid black; padding: 2px; display: inline-block;">Pause</div>	By pushing the button related to this function, the CA502 stops the current analysis when the set time interval is over. This condition is shown with the symbol " <div style="border: 1px solid black; padding: 2px; display: inline-block;">Paused</div> ".
<div style="border: 1px solid black; padding: 2px; display: inline-block;">Keep</div>	When the "Paused" phase is over, the interactive function "Keep" is shown. By activating this function the recorded sample is stored to memory and the CA502 continues with the collection of the next sample.



BY PRESSING THE  BUTTON AT ANY MOMENT, IT INTERRUPTS THE COMBUSTION ANALYSIS AND GOES BACK TO THE MAIN SCREEN.

8.1.6 End of the Analysis

- At the end of the combustion analysis, carefully remove the sample probe from the stack, take care not to get burned.

Then, proceed to turn off the instrument.

The instrument will execute a cleaning cycle, according to what is set in the menu "Configuration→Analysis→Autozero→Purging". During the purge, the pump sucks clean air until it reduces the concentration of CO. The CA502 automatically turns off within a maximum of 10 minutes.

Note: It is always advisable to purge the instrument with clean air for at least 5 - 10 minutes before turning it off.



WHEN THE GAS SAMPLING PROBE IS TAKEN OUT OF THE STACK, THE FORMATION OF SOME CONDENSATION IN THE PROBE TUBE AND IN THE WATER TRAP MAY OCCUR.

IT IS ADVISED TO ACCURATELY CLEAN EVERY PART BEFORE PUTTING AWAY THE PROBE AND THE WATER TRAP IN THE CASE.

IN ORDER NOT TO DAMAGE THE CASE MAKE SURE THAT THE METALLIC PROBE PIPE IS AT A TEMPERATURE LOWER THAN 140°F (60°C).

Gas sampling probe cleaning

- When you finish using the sample probe clean it thoroughly as described below before returning it to its case:
 - Disconnect the sample probe from the instrument and from the water trap (Fig. a-b) then blow a jet of clean air into the hose of the probe (refer to Fig. b) to remove any residual condensate that may have formed within.

Maintaining the water trap / filter unit

To

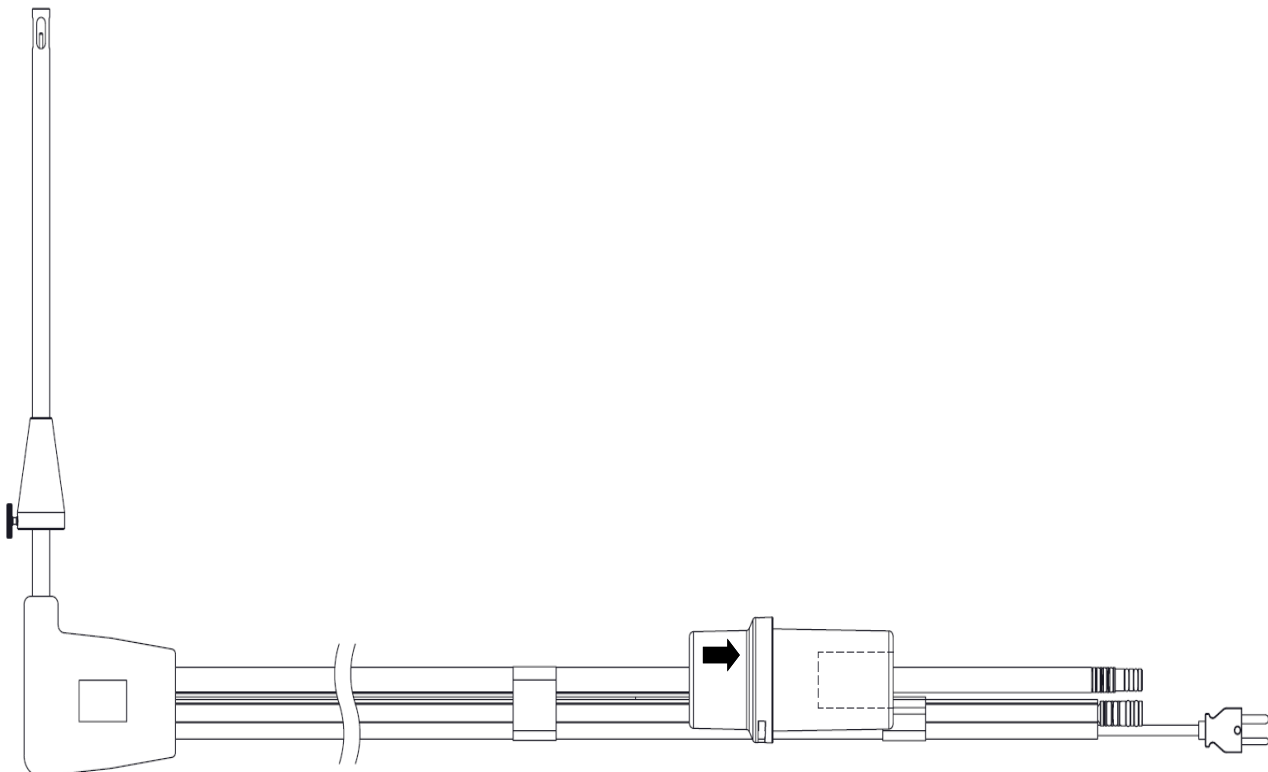

Fig. a

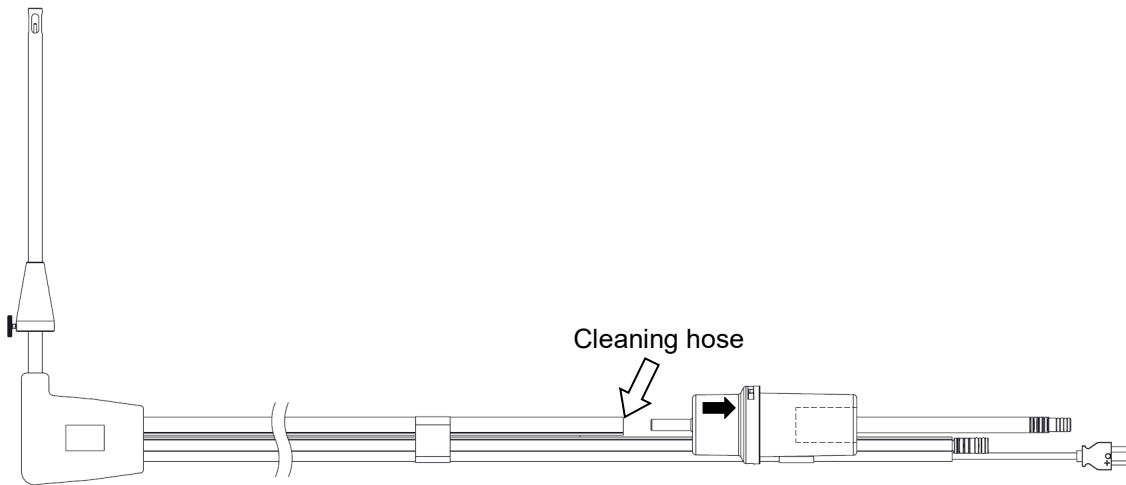
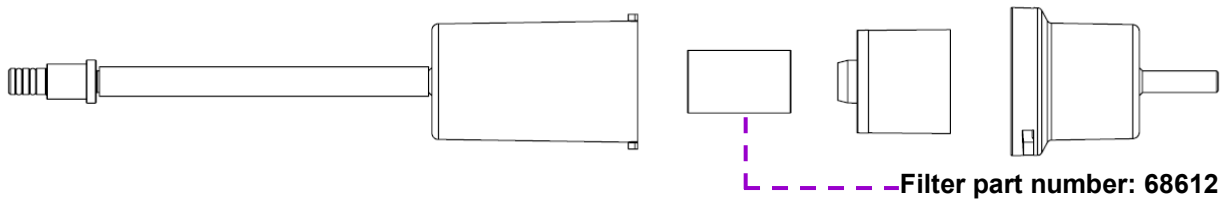

Fig. b

remove the water trap, just rotate the cover and unhook the filter holder body; remove the internal cup and then replace the filter (see figure below).

Clean all of the filter parts using only water, then dry the components and reassemble the filter.

Replacing the particulate filter



Filter part number: 68612

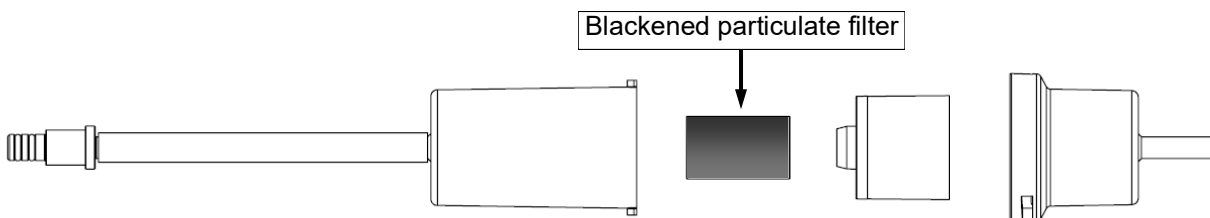

If the particulate filter appears black, especially on the inner surface (see adjacent example), it needs to be replaced immediately. This way gas will flow through without obstruction.

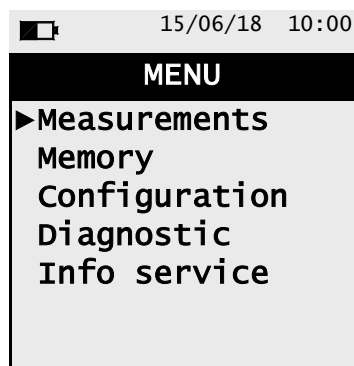

Blackened particulate filter

9.1 Menu



KEY	FUNCTION
	Returns to the previous screen.
	Selects the available parameters.
	Enters in the selected parameter setting.

SUB-MENU	FUNCTION
Measurements	This menu is used to collect the draft, ambient CO and pressure Measurements. SEE CHAPTER 10.0
Memory	This parameter sets the number of the memory records on which the combustion analysis, the draft measurement, etc. are recorded. It shows the status (Full or Free) and the details (time and date) of the selected memory number (if the memory position is occupied by data). It can also show, print or delete the recorded data and the additional measurements. SEE CHAPTER 11.0
Configuration	The user can set the different reference parameters of the instrument in order to perform the combustion analysis. SEE CHAPTER 12.0
Diagnostic	The user can verify any abnormalities of the instrument. SEE CHAPTER 13.0
Info service	Display the info about the current condition of the instrument. SEE CHAPTER 14.0

10.1 Menu → Measurements

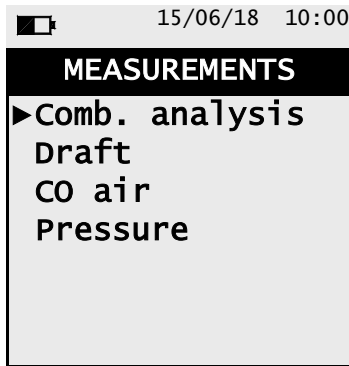

KEY	FUNCTION
	Returns to the previous screen.
	Selects the available parameters.
	Enters in the selected parameter setting.

SUB MENU	FUNCTION
Comb. analysis	The combustion analysis menu, sets the different reference parameters of the instrument to perform the combustion analysis. SEE CHAPTER 10.2
Draft	The DRAFT menu gives access to the stack draft measurement. NOTE: The measurement may not be accurate due to condensation inside the gas probe. Should you notice an inaccurate or unstable reading on the instrument, it is advisable to disconnect the gas probe from the instrument itself, and purge pipes by blowing with a compressor. In order to be sure there is no humidity, it is suggested to perform the measurement by means of the transparent rubber pipe supplied as optional. SEE CHAPTER 10.3
CO air	This menu lets the user measure the CO value present in the environment, with the scope of checking the personal safety conditions of a specific working environment. The instrument leaves our factory with the following pre-set threshold values: COmax: 9 ppm Recommended exposure limit (REL) for 24-hr exposure in residential applications. Maximum levels are stipulated by the National Institute for Occupational Safety and Health (NIOSH), equivalent to 40 mg/m ³ and calculated as an 8-hour Time-Weighted Average (TWA). It is necessary to perform the autozero in the clean air. This will ensure the ambient CO measurement is correct. It is advisable to turn on the CA502 and wait for the autozero completion outside the area where the test is being performed. SEE CHAPTER 10.4
Pressure	Through the use of the optional Manometer Hose (68620), it is possible to measure a pressure value within the range stated in the technical features (connect the pipe to P+ input). SEE CHAPTER 10.5

10.2 Menu → Measurements → Comb. analysis

11/12/17 10:00	
SET ANALYSIS	
▶ Mode	Auto
Fuel	Natural gas
Interval	7 s
Memory	1/5
Status	Free
Start	

KEY	FUNCTION
	Activate the context keys shown on the display.
	Returns to the previous screen.
	Selects the available parameters.
	Enters the selected parameter and confirms the choice made.

INTERACTIVE OPERATION	FUNCTION
	Starts the analysis with the selected mode

PARAMETER	DESCRIPTION
Mode	<p>This menu allows the user to choose among 2 different analysis modes: Manual or Auto</p> <p>Manual: In manual mode, the combustion analysis is performed manually by setting the 'Fuel' parameter. Then, the manual analysis can start wait at least two minutes for the shown values to stabilize. Once stable, it is possible to proceed with the recording or directly to printing depending on the setting made. In this mode it is possible to print or save just one combustion analysis containing all the data necessary.</p> <p>Auto: In this mode the instrument performs 3 different measures divided by a time gap defined by the user using the sub parameter 'interval'. It is possible to select the memory space to store the analysis and set the used fuel type.</p> <p>In all modes, the data displayed for CO / NO / NO_x can be normalized with reference to the concentration of O₂ previously set in "configuration => analysis" menu.</p>
Fuel	This menu is for the selection of the fuel to be used in the analysis phase. This data can be changed in this menu and in the configuration menu.
Interval	ONLY IN 'AUTO MODE'. Sets the time interval for the sample recording with a value between 1 and 900 seconds.
Memory	ONLY IN 'AUTO MODE'. Selects the memory number where the analysis is saved. If the memory is full it is possible to choose whether to overwrite the existing values.



TO PERFORM THE COMBUSTION ANALYSIS REFER TO [CHAPTER 8.0](#)

10.3 Menu → Measurements → Draft

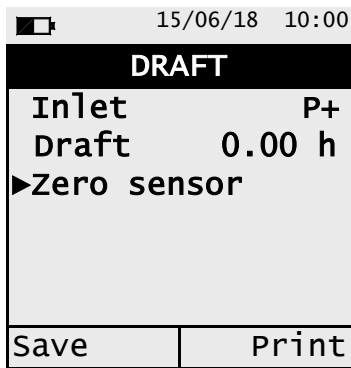

KEY	FUNCTION
	Activate the keys shown on the bottom lines of the display.
	Returns to the previous screen.
	Starts the pressure sensor autozero.

INTERACTIVE OPERATION	FUNCTION
Save	The measure will be printed on the ticket of the current combustion analysis
Print	Allows the option to print or generate the QR code for reading on the YJ Combustion APP.



To measure the draft:

- Connect the manometer hose probe to the instrument **P+** input.
- Before starting the pressure zeroing sequence remove the gas probe from the exhaust stack.
- Upon completion of the pressure zeroing sequence, insert the probe in the exhaust stack and measure the draft.

Example:



10.4 Menu → Measurements → CO air

15/06/18 10:00	
CO AIR	
CO	412 p
CO Max	413 p
Save	Print

KEY	FUNCTION
	Activate the keys shown on the bottom line of the display.
	Returns to the previous screen.

INTERACTIVE OPERATION	FUNCTION
Save	The measure will be printed on the ticket of the current combustion analysis
Print	Allows the option to print or generate the QR code for reading on the YJ Combustion APP.



It is necessary to perform the autozero in the clean air, so the ambient CO measurement is correct. It is recommended to turn on the CA502 and wait for the autozero completion outside the area where the test is being performed.

Example:

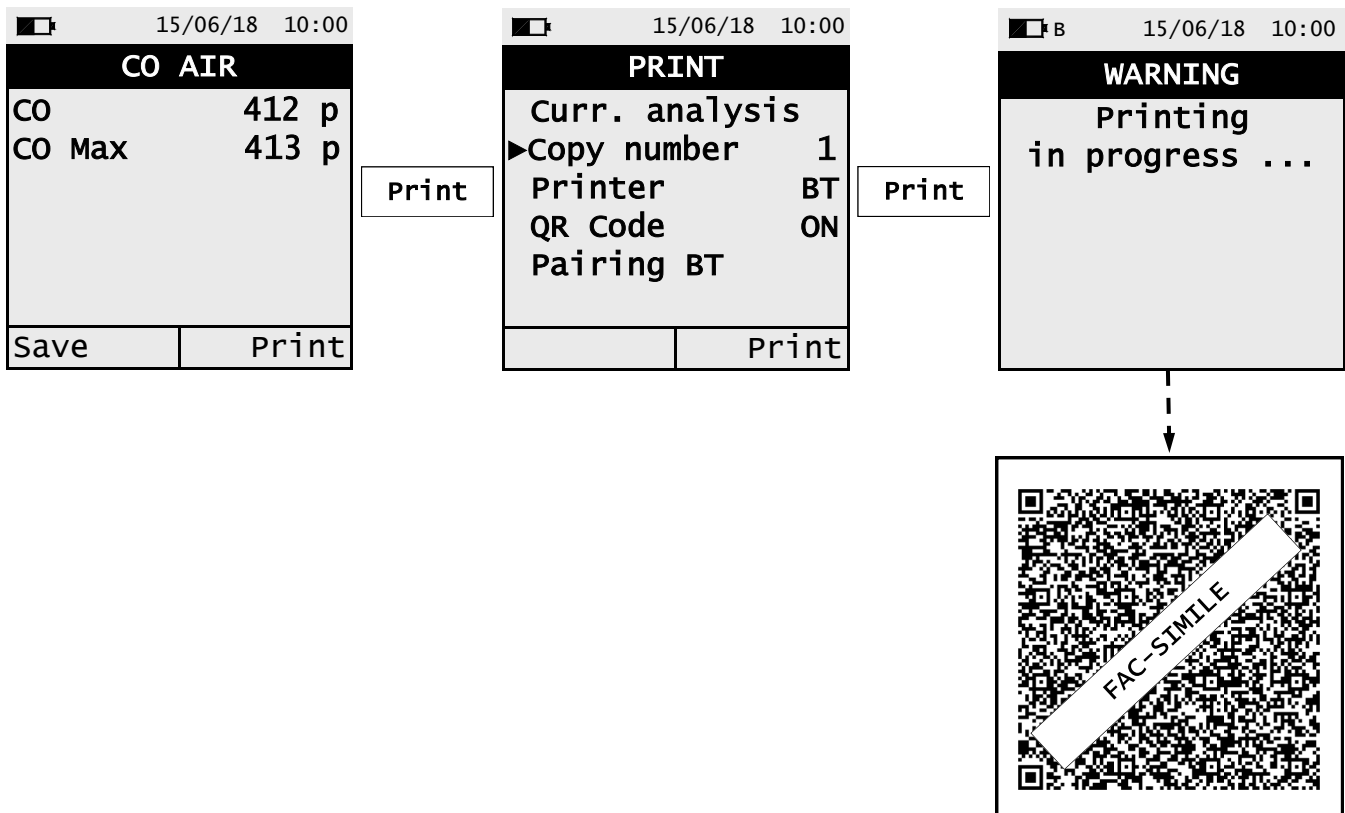

10.5 Menu → Measurements → Pressure

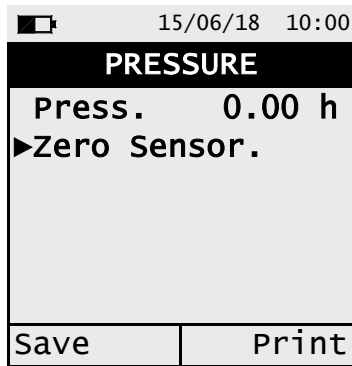

KEY	FUNCTION
	Activate the keys shown on the bottom line of the display.
	Returns to the previous screen.
	Perform the Zero Sensor of the pressure sensor.

INTERACTIVE OPERATION	FUNCTION
Save	The measure will be printed on the ticket of the current combustion analysis
Print	Allows the option to print or generate the QR code for reading on the YJ Combustion APP.

Example:

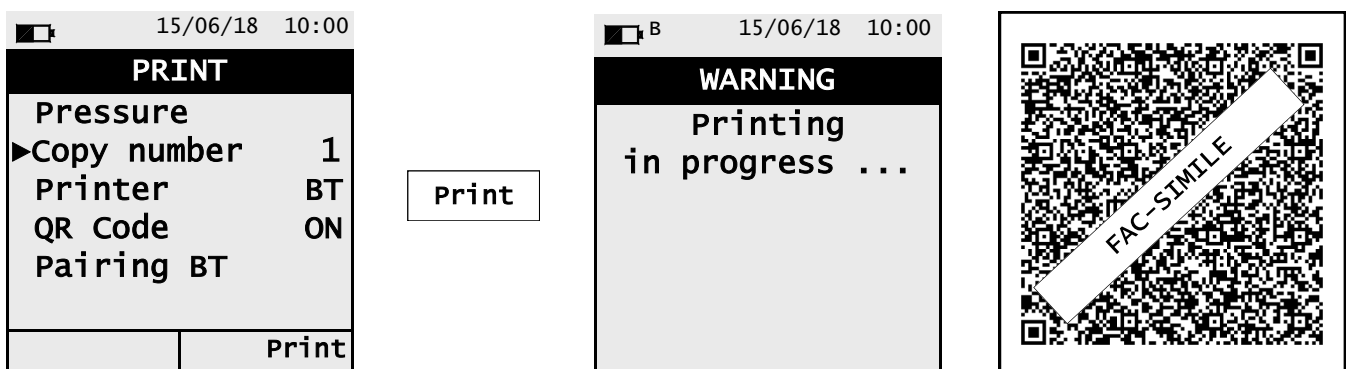
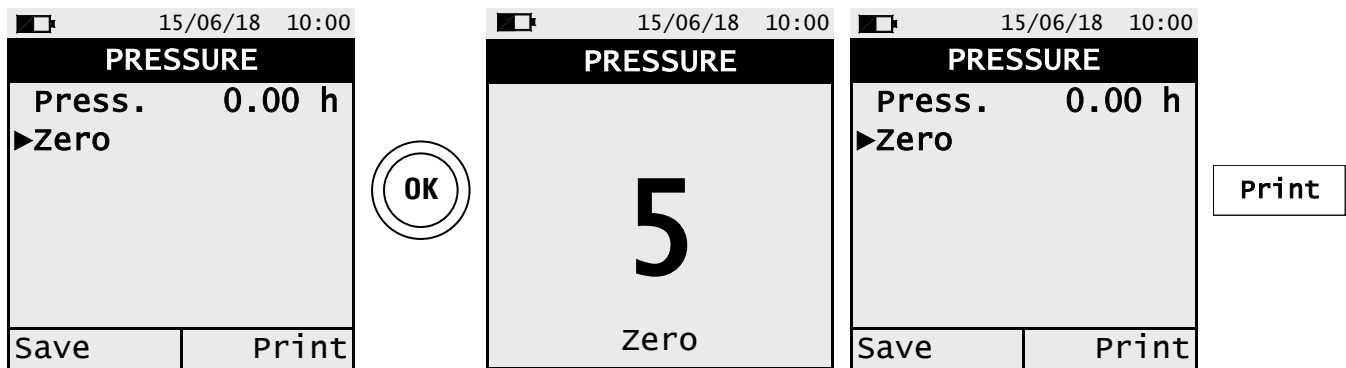

11.1 Menu→Memory

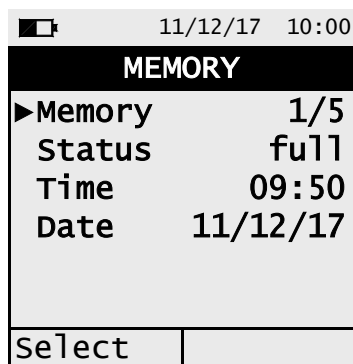

KEY	FUNCTION
	Activate the keys shown on the bottom line of the display.
	Modifies the memory number and then confirms the changed setting. When selecting the analysis, shows the detail of the evidenced analysis.
 	Selects the available parameters.
	Returns to the previous screen. In modification mode, cancels the setting made.

INTERACTIVE OPERATION	DESCRIPTION
Select	Shows the list of readings in the selected memory number.
Delete	Deletes the entire contents of the selected memory.
Print	Prints the memory file or shows the QR code of the selected memory number for use with the YJ Combustion APP.

1. Set memory detail

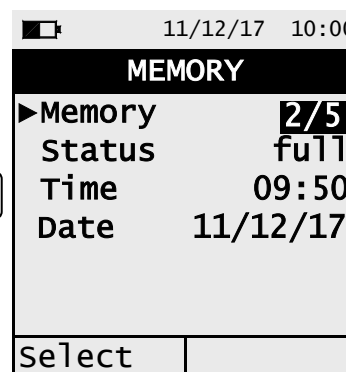
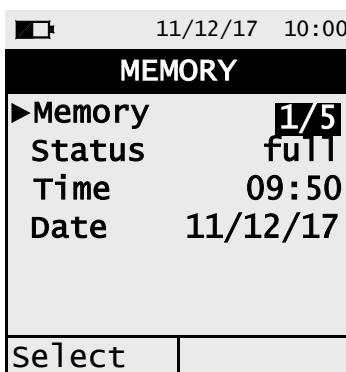
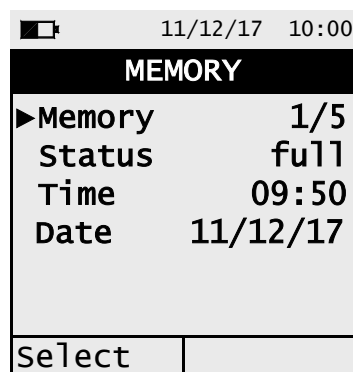

2. Visual review of the memory content

<div style="border: 1px solid black; padding: 5px;"> <p style="text-align: right;">11/12/17 10:00</p> <p style="text-align: center;">MEMORY</p> <p>▶Memory 1/5 Status full Time 09:50 Date 11/12/17</p> <p style="text-align: right;">Select</p> </div>	<div style="border: 1px solid black; padding: 2px; display: inline-block;">Select</div>	<div style="border: 1px solid black; padding: 5px;"> <p style="text-align: right;">11/12/17 10:00</p> <p style="text-align: center;">MEMORY</p> <p>▶Average analysis Analysis 1 Analysis 2 Analysis 3 Draft Pressure</p> <p style="text-align: right;">Delete Print</p> </div>
<div style="border: 1px solid black; padding: 2px; display: inline-block;">V</div>		
<div style="border: 1px solid black; padding: 5px;"> <p style="text-align: right;">11/12/17 10:00</p> <p style="text-align: center;">AVERAGE [1/2]</p> <p>Tf 190.1 C Ta 15.4 C O2 4.2 % CO 23 ppm CO2 2.9 % COR ---- p</p> <p style="text-align: right;">Print</p> </div>	<div style="border: 1px solid black; border-radius: 50%; padding: 5px; display: inline-block;">OK</div>	
<div style="border: 1px solid black; padding: 5px;"> <p style="text-align: right;">11/12/17 10:00</p> <p style="text-align: center;">MEMORY</p> <p>Average analysis ▶Analysis 1 Analysis 2 Analysis 3 Draft Pressure</p> <p style="text-align: right;">Delete Print</p> </div>	<div style="border: 1px solid black; border-radius: 50%; padding: 5px; display: inline-block;">OK</div>	<div style="border: 1px solid black; padding: 5px;"> <p style="text-align: right;">11/12/17 10:00</p> <p style="text-align: center;">ANALYSIS 1 [1/2]</p> <p>Tf 190.1 C Ta 15.4 C O2 4.2 % CO 23 ppm CO2 2.9 % COR ---- p</p> <p style="text-align: right;">Print</p> </div>

3. Print memory file detail of the selected memory

<div style="border: 1px solid black; padding: 5px;"> <p style="text-align: right;">11/12/17 10:00</p> <p style="text-align: center;">MEMORY</p> <p>Average analysis Analysis 1 Analysis 2 Analysis 3 Draft Pressure</p> <p style="text-align: right;">Delete Print</p> </div>	<div style="border: 1px solid black; padding: 2px; display: inline-block;">Print</div>	<div style="border: 1px solid black; padding: 5px;"> <p style="text-align: right;">11/12/17 10:00</p> <p style="text-align: center;">PRINT</p> <p>Memory ▶Copy number 1 Printer BT QR Code OFF Pairing BT</p> <p style="text-align: right;">Print</p> </div>
<div style="border: 1px solid black; padding: 2px; display: inline-block;">Print</div>		
<div style="border: 1px solid black; padding: 5px;"> <p style="text-align: right;">11/12/17 10:00</p> <p style="text-align: center;">WARNING</p> <p style="text-align: center;">Printing in progress ...</p> </div>		

4. Print memory file detail of the single measurement

<div style="border: 1px solid black; padding: 5px;"> <p style="text-align: right;">11/12/17 10:00</p> <p style="text-align: center;">MEMORY</p> <p>▶Average analysis Analysis 1 Analysis 2 Analysis 3 Draft Pressure</p> <p style="text-align: right;">Delete Print</p> </div>	<div style="border: 1px solid black; border-radius: 50%; padding: 5px; display: inline-block;">OK</div>	<div style="border: 1px solid black; padding: 5px;"> <p style="text-align: right;">11/12/17 10:00</p> <p style="text-align: center;">AVERAGE [1/2]</p> <p>Tf 190.1 C Ta 15.4 C O2 4.2 % CO 23 ppm CO2 2.9 % COR ---- p</p> <p style="text-align: right;">Print</p> </div>
<div style="border: 1px solid black; padding: 2px; display: inline-block;">Print</div>		
<div style="border: 1px solid black; padding: 5px;"> <p style="text-align: right;">11/12/17 10:00</p> <p style="text-align: center;">WARNING</p> <p style="text-align: center;">Printing in progress ...</p> </div>		

5. Detail of QR code generation to download the data and the additional measures.

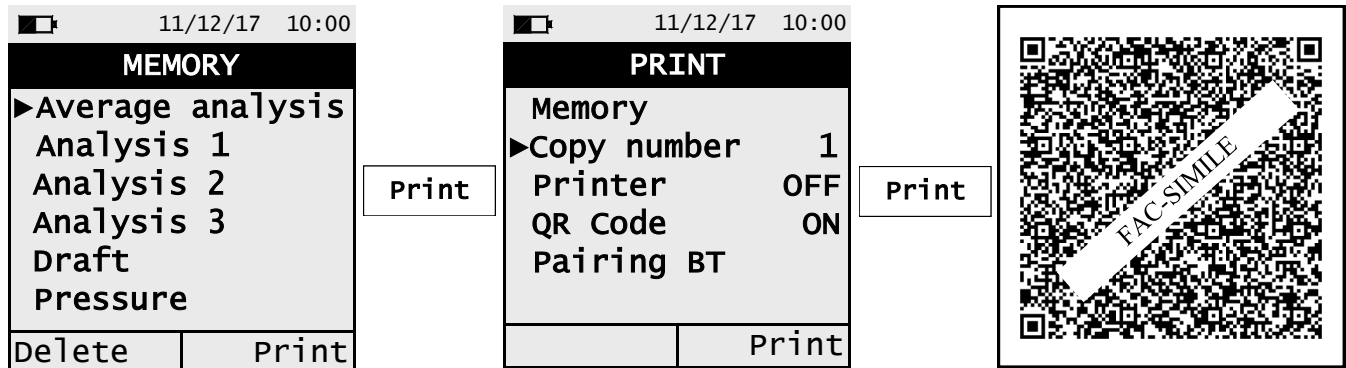

6. Detail of QR code generation to download the data of each measurement

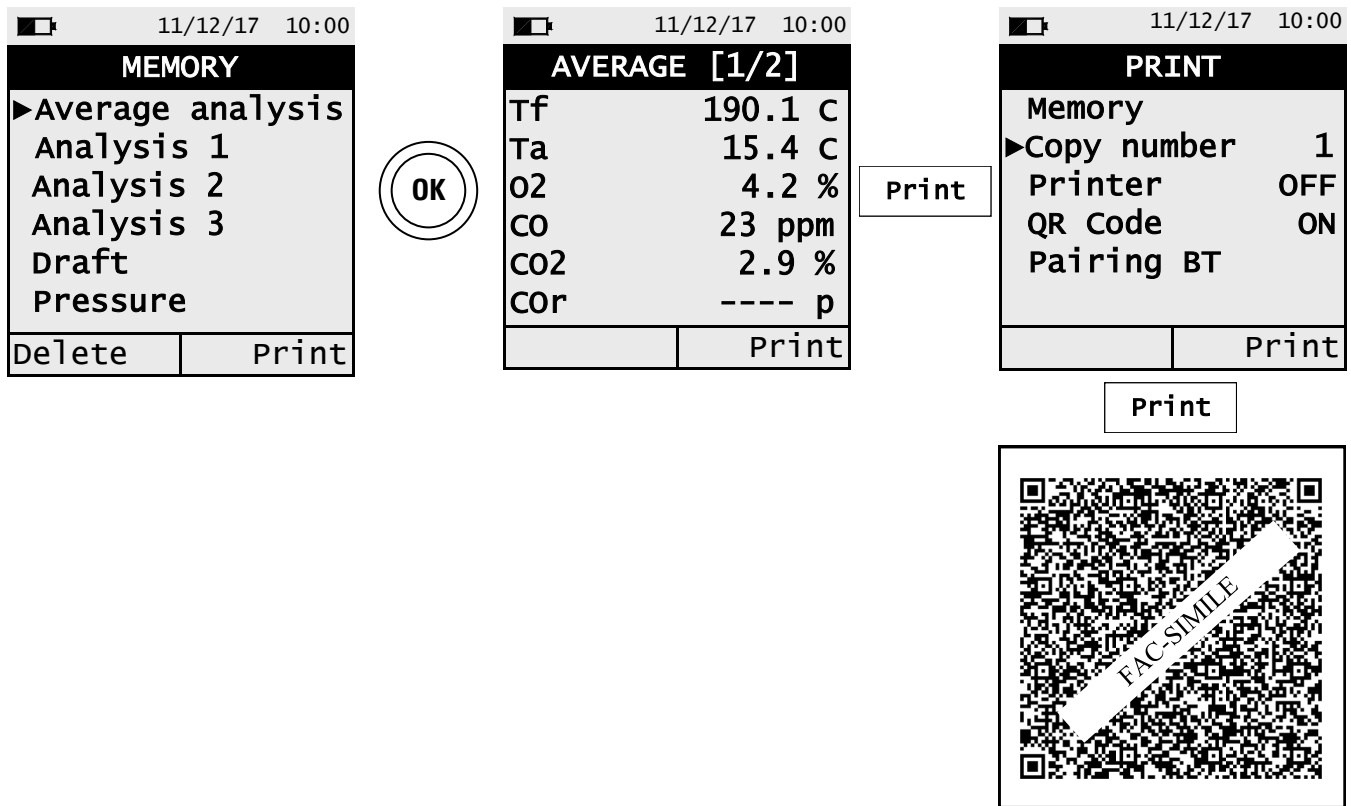

7. Detail of deleting the entire selected memory file

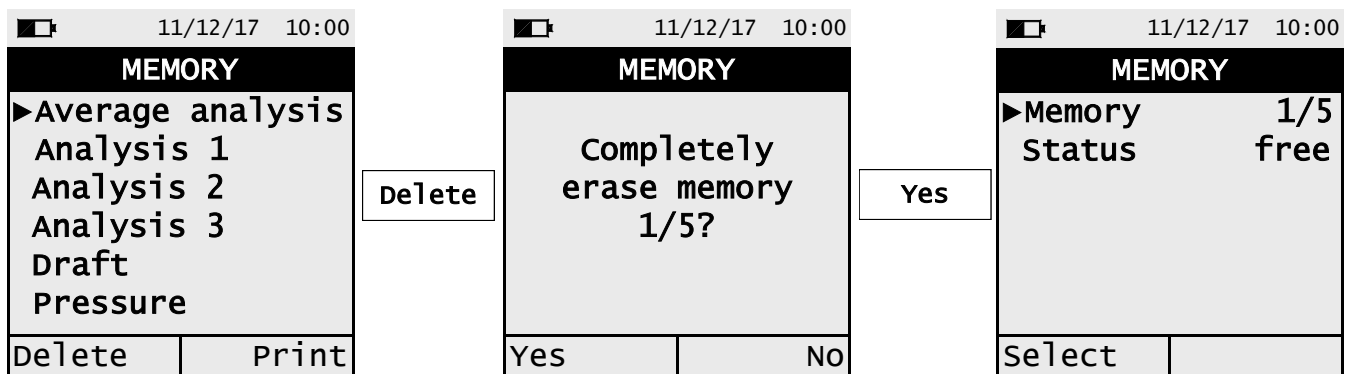

12.1 Menu→Configuration

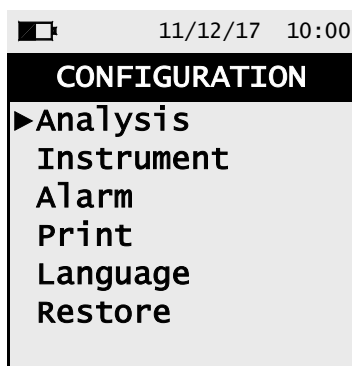



KEY	FUNCTION
	Enters in the selected parameter.
	Selects the available parameters.
	Returns to the previous screen.

SUB MENU	FUNCTION
Analysis	This menu is used to set the reference parameters of the CA502 in order to perform the combustion analysis and/or additional measures. SEE CHAPTER 12.2
Instrument	This menu is used to set the different reference parameters of the CA502. SEE CHAPTER 12.3
Alarm	<p>The alarm management menu is used to set and store only one alarm. It is possible to define the observed gas, the intervention threshold and the kind of alarm: Minimum, Maximum or Off. The Minimum alarm type will record when the measured gas drops below the set threshold, while the Maximum alarm type will record when the measured gas goes above the set threshold. If the alarm is in Off mode, it is deactivated.</p> <p>SEE CHAPTER</p>
Print	The print menu allows the settings for the print parameters. The parameters include copy number, printer type (OFF, BT or IR) and the visualization of the QR code. The QR code allows the download of the data of the performed analysis for use with the YJ Combustion APP. SEE CHAPTER 12.5
Language	The language menu selects the desired language of the instrument for all the menus. SEE CHAPTER 12.6
Restore	Resets default data. SEE CHAPTER 12.7

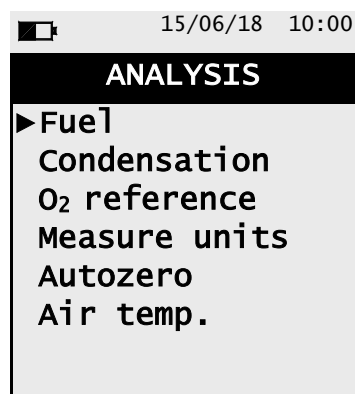
12.2 Menu→Configuration→Analysis



KEY	FUNCTION
	Returns to the previous screen.
	Selects the available parameters.
	Enters in the selected parameter.

SUB MENU	FUNCTION
Fuel	The fuel menu allows the user to select the type of fuel to be used during analysis. SEE CHAPTER 12.2.1.
Condensation	The burner efficiency figure when condensation takes place is influenced by atmospheric pressure and humidity of the combustion air. As the atmospheric pressure is an unknown, the operator is asked to enter a related parameter, i.e. the altitude of the place above the sea level. The pressure is then calculated from the atmospheric conditions. In the calculations the value of 101325 Pa is assumed as atmospheric pressure at sea level. The air relative humidity input is calculated at the combustion air temperature as measured from the CA502. If the relative humidity value is unknown the operator is recommended to enter 50% for the value. SEE CHAPTER 12.2.2.
O₂ reference	This mode allows the user the ability to set the oxygen percentage level to which pollutant emission values detected during analysis will be referenced. SEE CHAPTER 12.2.3.
Measure units	This submenu allows the user to modify the units of measurement for all the analysis parameters. SEE CHAPTER 12.2.4.
Autozero	This sub menu is used to modify the auto zero cycle duration and the duration of the sensor cleaning cycle. SEE CHAPTER 12.2.5.
Air temp.	This submenu is used to acquire or manually enter the combustion air temperature. SEE CHAPTER 12.2.6

12.2.1 Menu→Configuration→Analysis→Fuel

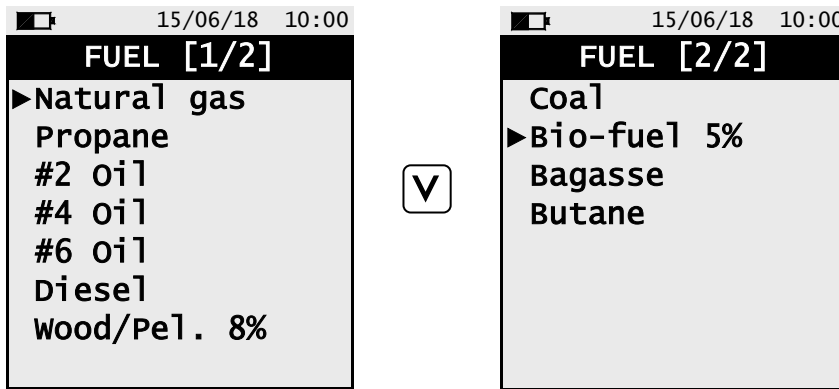

KEY	FUNCTION
	Returns to the previous screen.
	Scrolls through the pages.
	Confirms the choice of fuel to be used during the analysis.

Example:

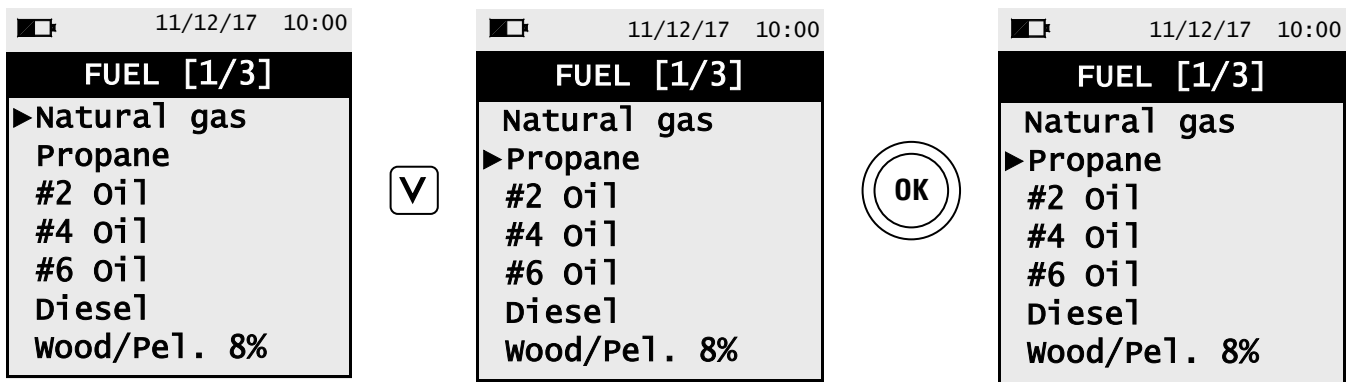

12.2.2 Menu→Configuration→Analysis→Condensation

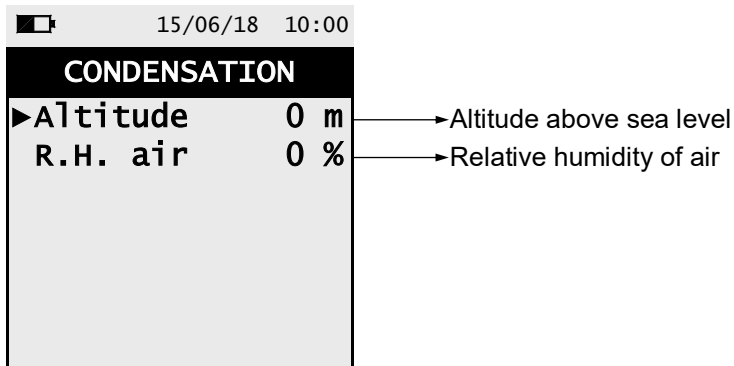

KEY	FUNCTION
	When pressed in modify mode cancels the selection made, otherwise returns to the previous screen.
	The arrows select each line displayed. In edit mode, it scrolls through the suggested values.
	Enters the modify mode for the selected parameter, then confirms the modification.

Example:

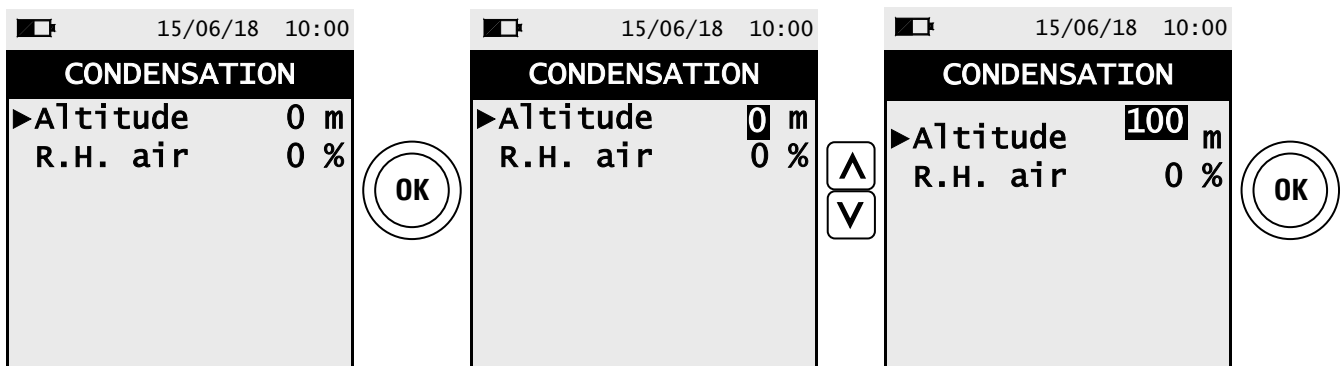

12.2.3 Menu→Configuration→Analysis→O2 Reference

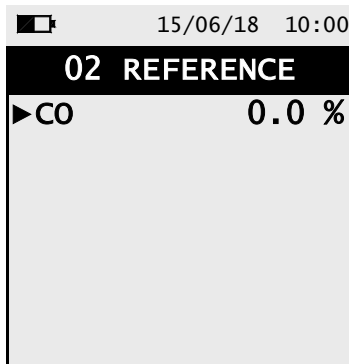

→Percentage of Oxygen in CO measurement

KEY	FUNCTION
	When pressed in modify mode cancels the selection made, otherwise returns to the previous screen.
	The arrows select each line displayed. In edit mode, it scrolls through the suggested values.
	Enters the modify mode for the selected parameter, then confirms the modification.

Example:

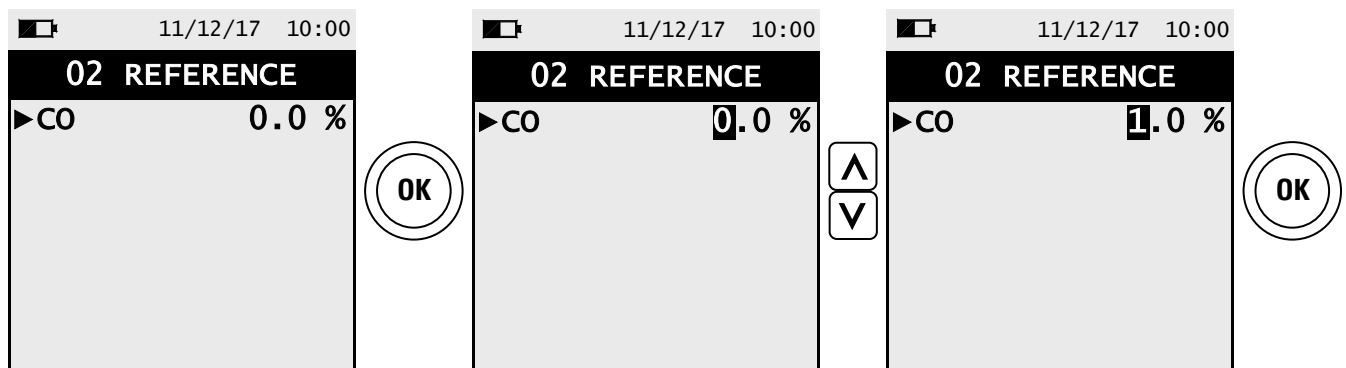

12.2.4 Menu → Configuration → Analysis → Measure units

15/06/18 10:00

MEASURE UNITS

- ▶ CO ppm → Measurement unit can be set as: ppm - mg/m³ - mg/kWh - g/GJ - g/m³ ng/J - g/kWh - %
- Pressure hPa → Measurement unit can be set as: inH2O - psi - hPa - Pa - mbar - mmH2O - mmHg
- Draft mmH2O → Measurement unit can be set as: inH2O - psi - hPa - Pa - mbar - mmH2O - mmHg
- Temperature oC → Measurement unit can be set as: °F - °C
- Altitude ft → Measurement unit can be set as: ft - m

KEY	FUNCTION
	When pressed in modify mode cancels the selection made, otherwise returns to the previous screen.
	The arrows select each line displayed. In edit mode, it scrolls through the suggested values.
	Enters the modify mode for the selected parameter, then confirms the modification.

Example:

15/06/18 10:00

MEASURE UNITS

- ▶ CO ppm
- Pressure hPa
- Draft mmH2O
- Temperature oC
- Altitude ft

15/06/18 10:00

MEASURE UNITS

- ▶ CO ppm
- Pressure hPa
- Draft mmH2O
- Temperature oC
- Altitude ft

15/06/18 10:00

MEASURE UNITS

- ▶ CO mg/m³
- Pressure hPa
- Draft mmH2O
- Temperature oC
- Altitude ft

12.2.5 Menu→Configuration→Analysis→Autozero

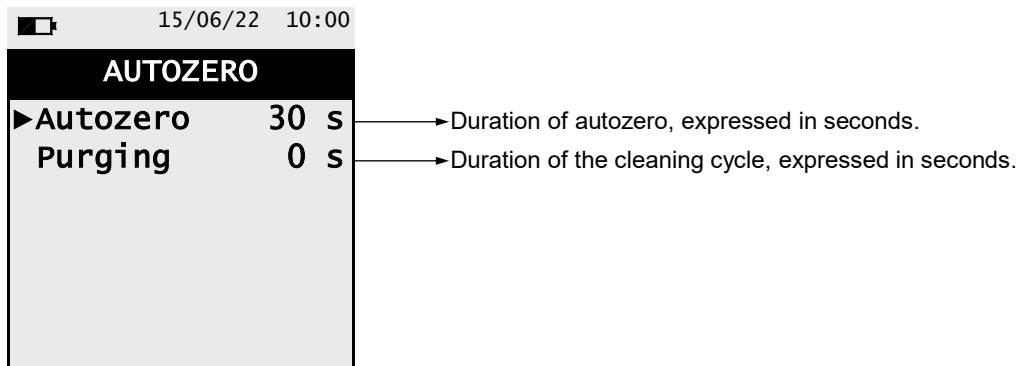

KEY	FUNCTION
	When pressed in modify mode cancels the selection made, otherwise returns to the previous screen.
	When in modify mode, sets the desired value.
	Enters edit mode of the selected element and then confirms the change.

Example:

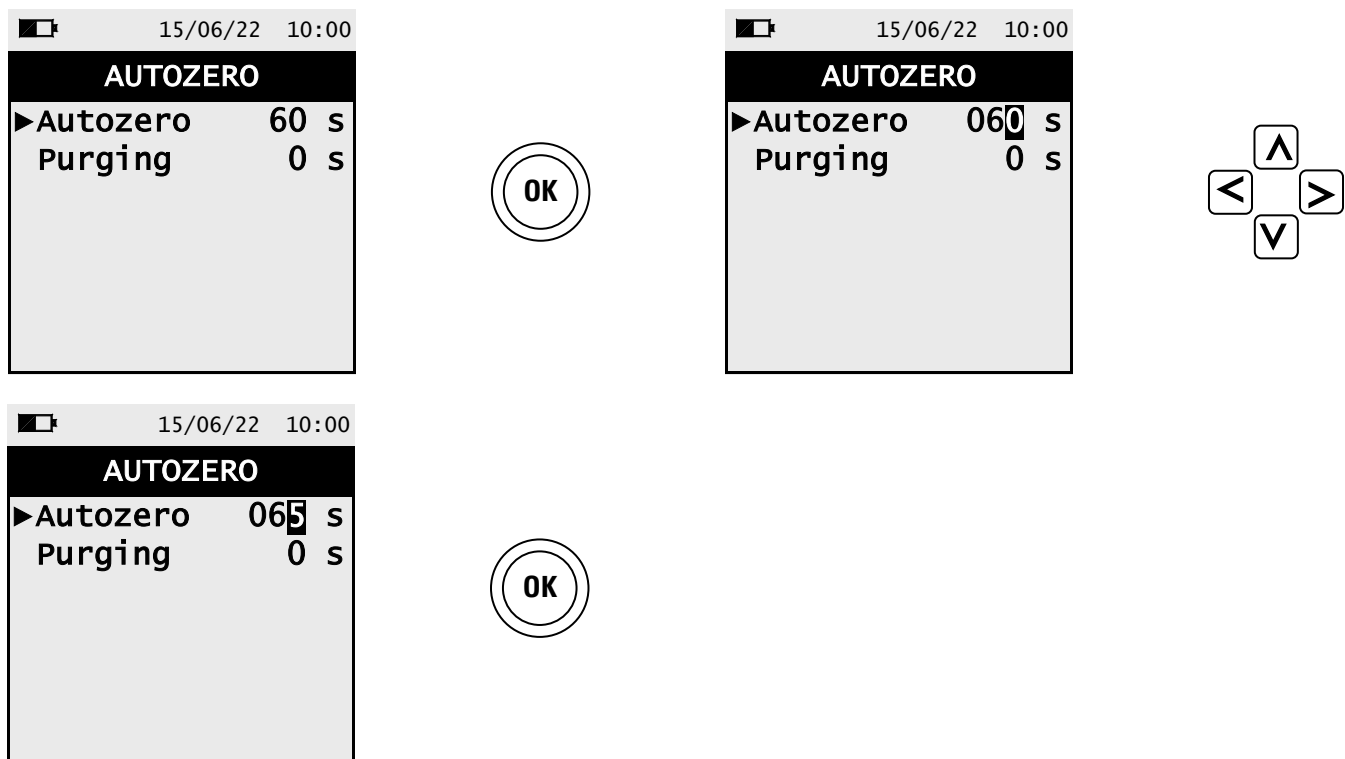

12.2.6 Menu→Configuration→Analysis→Air temp

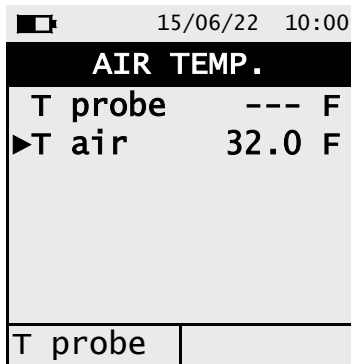

KEY	FUNCTION
	Enters edit mode of the selected element and then confirms the change.
	When in modify mode, sets the desired value.
	When pressed in modify mode cancels the selection made, otherwise returns to the previous screen.

INTERACTIVE OPERATION	DESCRIPTION
T probe	Measures the temperature by the Tc-K probe connected to the instrument and uses it as primary air temperature.

Example with probe connected to the instrument:

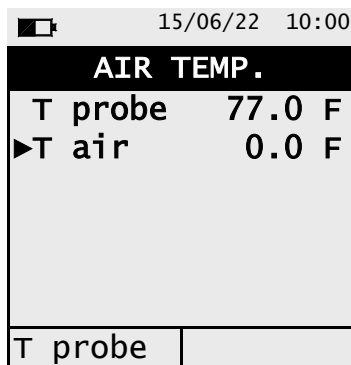

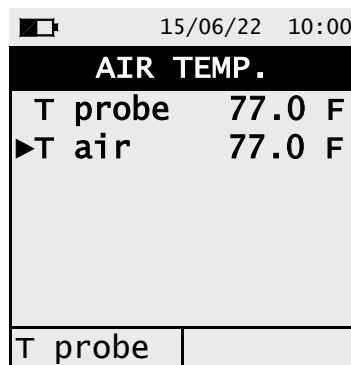

T probe

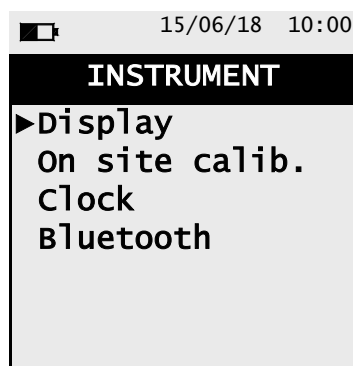

12.3 Menu→Configuration→Instrument





KEY	FUNCTION
	Returns to the previous screen.
	Selects the available parameters.
	Enters in the selected parameter.

SUB MENU	FUNCTION
Display	With the arrow keys it is possible to increase or decrease the brightness and the contrast of the display. SEE CHAPTER 12.3.1.
Clock	This allows the current time and date to be set. The user can select the date and hour format either in USA (American) or EU (European) mode. SEE CHAPTER 12.3.2.
Bluetooth	In this sub menu it is possible to turn on and off the Bluetooth® communication of the instrument and to visualize the related codes. SEE CHAPTER 12.3.3

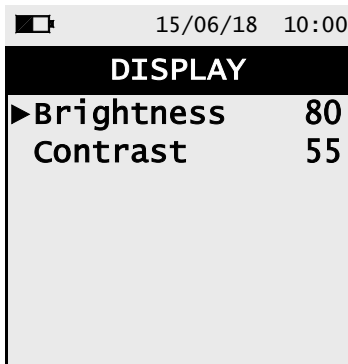
12.3.1 Menu→Configuration→Instrument→Display



KEY	FUNCTION
	When pressed in modify mode cancels the selection made, otherwise returns to the previous screen.
	The arrows select each line displayed. In edit mode, it scrolls through the suggested values.
	Enters the modify mode for the selected parameter, then confirms the modification.

Example:

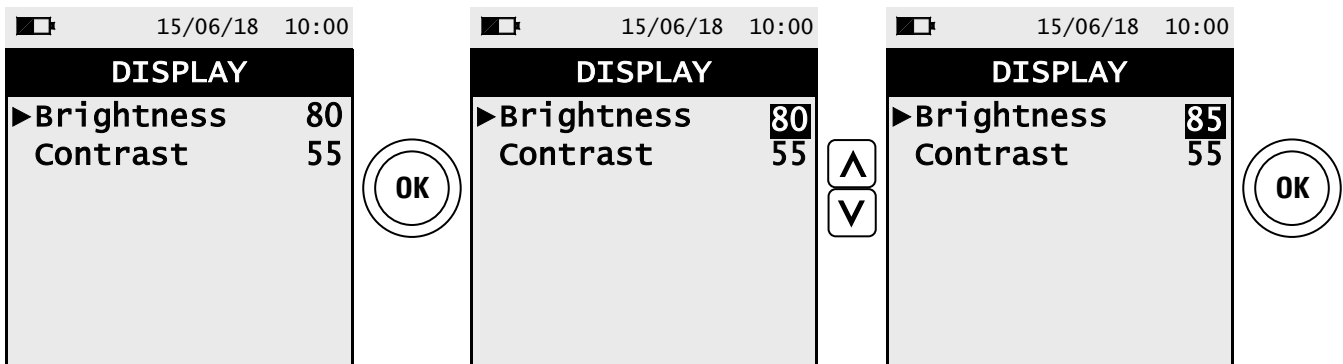



12.3.2 Menu-Configuration-Instrument-On Site Calibration

This menu is for calibration at YELLOW JACKET® certified calibration center only.

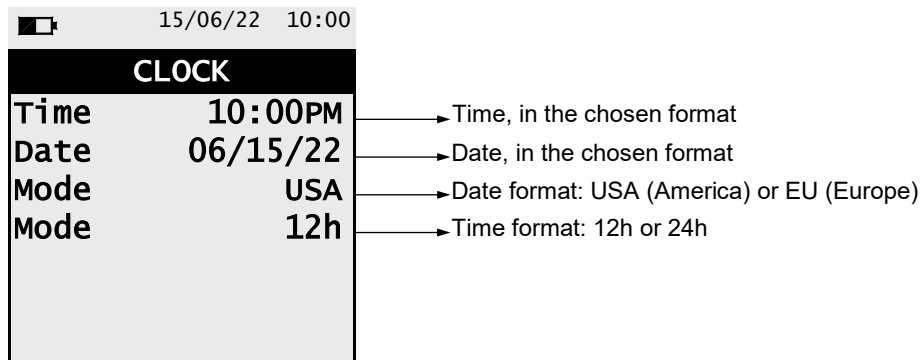

12.3.3 Menu→Configuration→Instrument→Clock

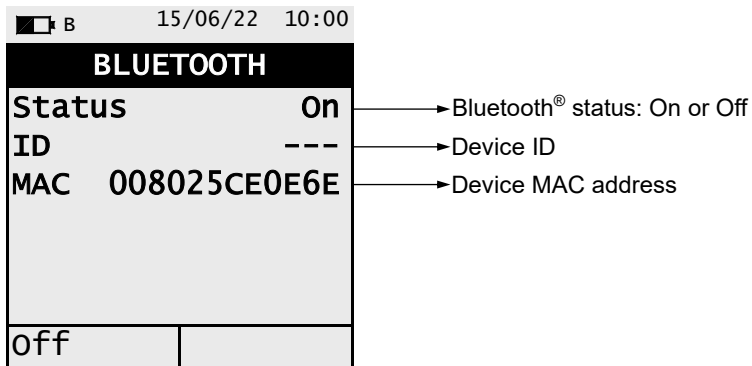

KEY	FUNCTION
	When pressed in modify mode cancels the selection made, otherwise returns to the previous screen.
	Selects line; in modification sets the value or the desired mode.
	Enters the modify mode for the selected parameter, then confirms the modification.

12.3.4 Menu → Configuration → Instrument → Bluetooth® (if available)



KEY	FUNCTION
 	Activate the keys shown on the bottom line of the display.
	Goes back to the previous screen.

INTERACTIVE OPERATIONS	DESCRIPTION
Off	Turns off Bluetooth®.
On	Turns on Bluetooth®.

12.4 Menu→Configuration→Alarm



11/12/22 10:00

ALARM

▶ Measure 02 → Observed parameter: CO - O2

Mode Min → Kind of set alarm: Max / Min / Off

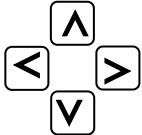
Limit 18.0 % → Concentration threshold of the observed gas.

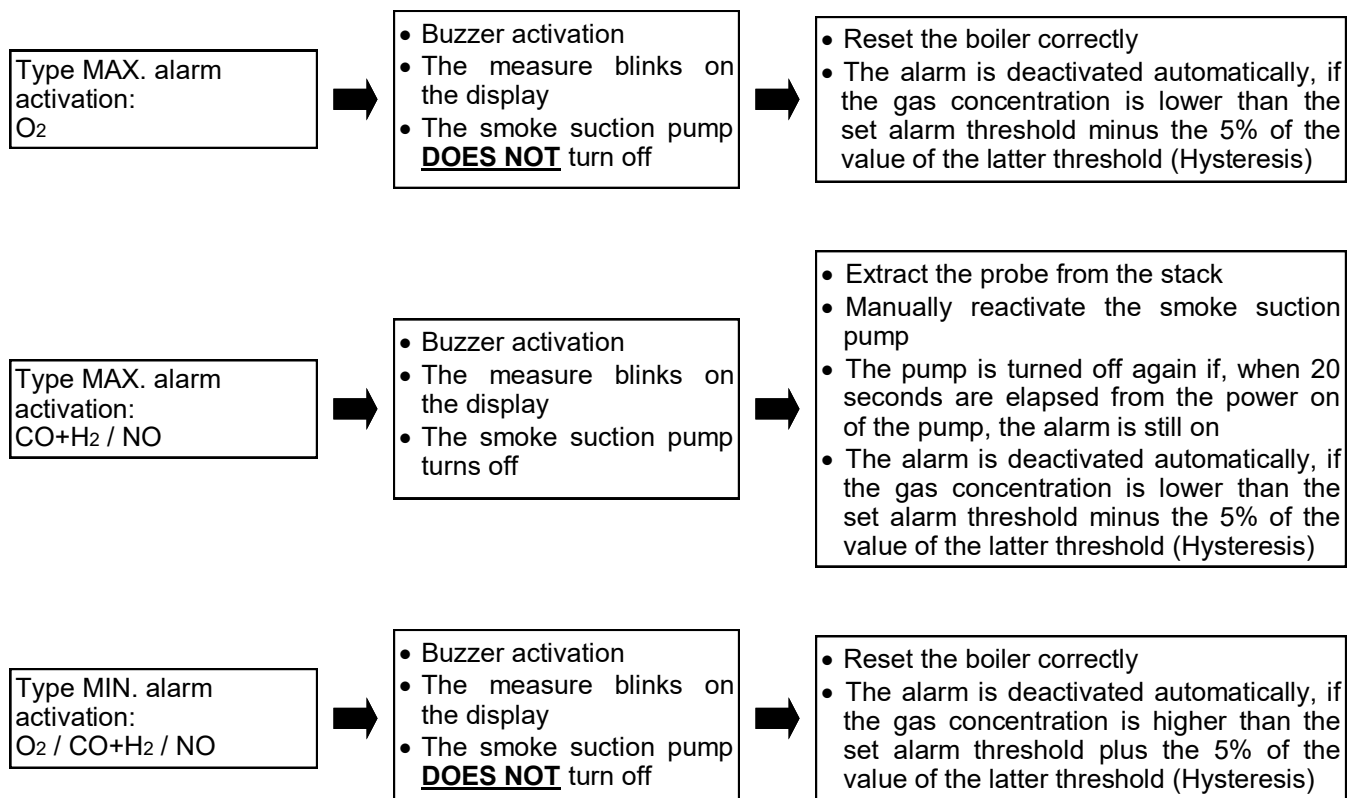

KEY	FUNCTION
	Enters the modify mode for the selected parameter, then confirms the modification.
	Selects line; in setting mode, sets the value or the desired mode.
	When pressed in modify mode cancels the selection made, otherwise returns to the previous screen.

Alarm activation flow chart and suggested correctional actions



12.5 Menu→Configuration→Print

15/06/22 10:00	
PRINT	
▶Copy number	1
Printer	IR
Mode	fast
QR code	ON
Pairing BT	

KEY	FUNCTION
	Enters the modification mode of the selected data and then confirms it.
	Selects the available parameters. In modification mode, scrolls the available values.
	When pressed in modify mode cancels the selection made, otherwise returns to the previous screen.

PARAMETER	DESCRIPTION
Copy number	Sets the number of ticket copies to be printed. This is a valid setting only if a printer has been selected.
Printer	Select the type of printer with which the ticket is printed: BT: Bluetooth® at the first start up it is necessary to perform the pairing procedure described below. IR: Infrared. OFF: None - the printer is turned off.
Mode	This parameter is visible only if the IR printer has been selected. Selects the printing speed of the IR printer between 'fast' and 'slow'. Select 'slow' in order to make the printing process compatible when an HP IR printer is used.
QR code	QR code generation ON: pushing the button related to the interactive function "Print" the instrument generates a QR code, which can be read with the " YJ Combustion " APP and allows the download of the data recorded during the combustion analysis and additional measurements. OFF: the QR code will not be shown.
Pairing BT	Carry out the procedure to pair the Bluetooth® printer.

12.5.1 Menu→Configuration→Print→Pairing

1. When the Bluetooth® printer is set, proceed with the following procedure:

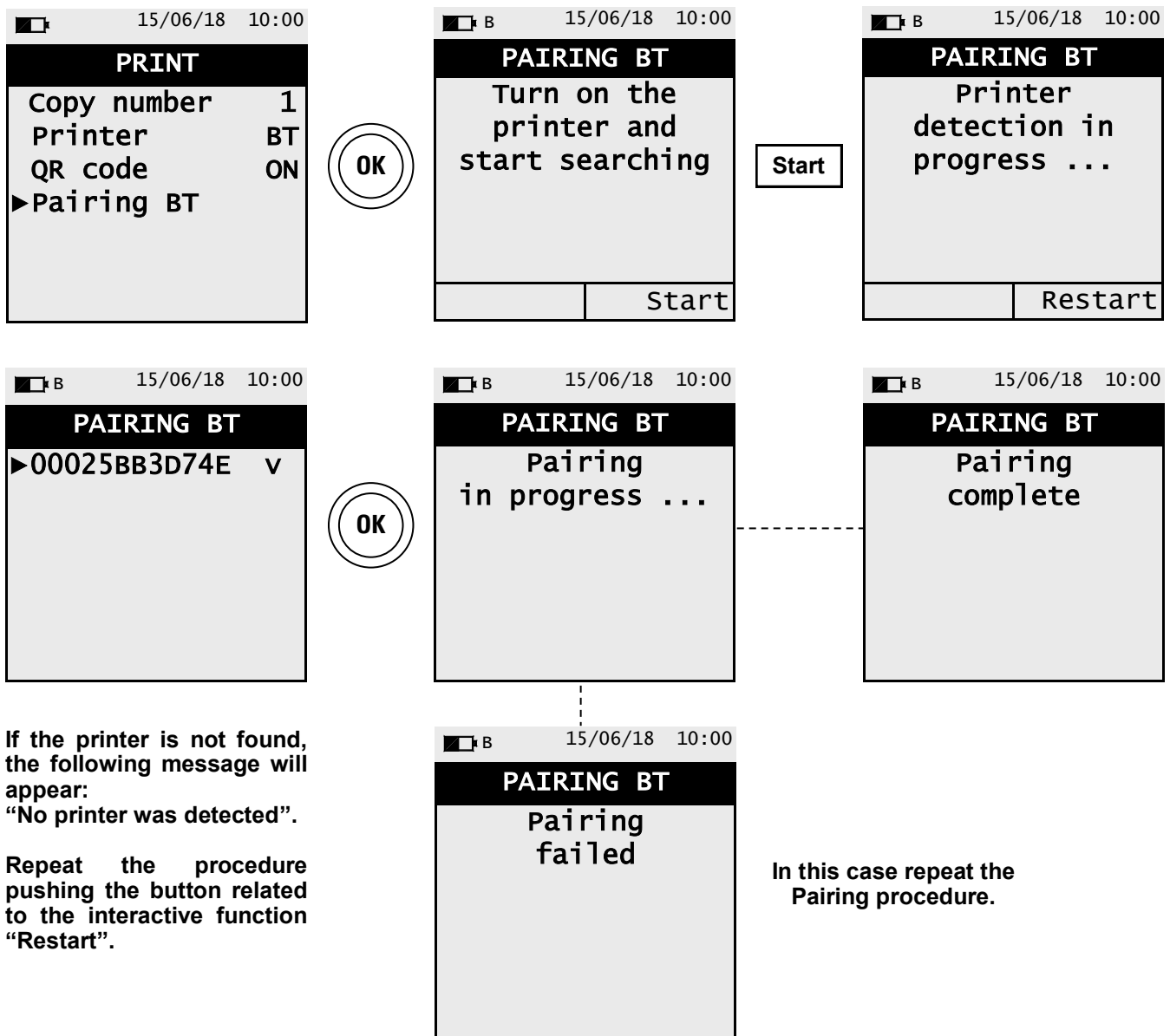



If the printer is not found, the following message will appear:
“No printer was detected”.

Repeat the procedure pushing the button related to the interactive function “Restart”.

In this case repeat the Pairing procedure.

12.6 Menu→Configuration→Language





KEY	FUNCTION
	Returns to the previous screen.
	Scrolls through the available languages.
	Sets the selected language.

Example:

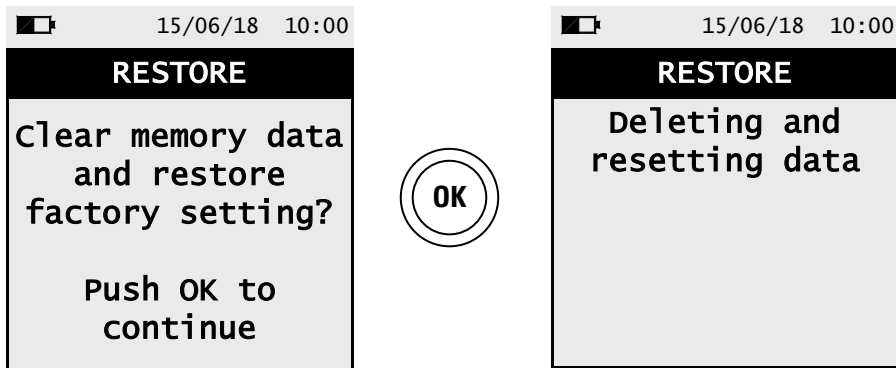

12.7 Menu→Configuration→Restore



KEY	FUNCTION
	Exits the current screen without resetting.
	Starts the factory data reset phase.

13.1 Menu→Diagnostic

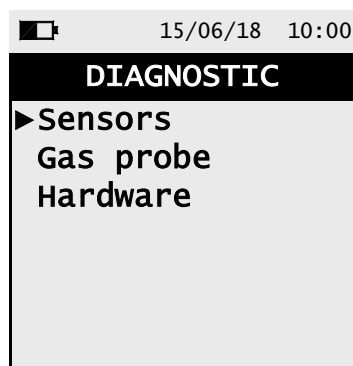

KEY	FUNCTION
	Returns to the previous screen.
	Selects the available parameters.
	Enters in the selected parameter.

SUB MENU	DESCRIPTION
Sensors	Displays the information on the state and calibration of the electrochemical sensors and provides the ID data of the sensor: Code Serial number Gas and Range Measured currents (to perform a quick diagnosis in case of malfunction). SEE CHAPTER 13.1.1.
Gas probe	Tests the tightness of the gas probe pneumatic path for potential leaks or possible damage. SEE CHAPTER 13.1.2.
Hardware	If a malfunction occurs, before contacting the Customer service, collect and/or send the data present in this menu. SEE CHAPTER 13.1.3.

13.1.1 Menu→Diagnostic→Sensors

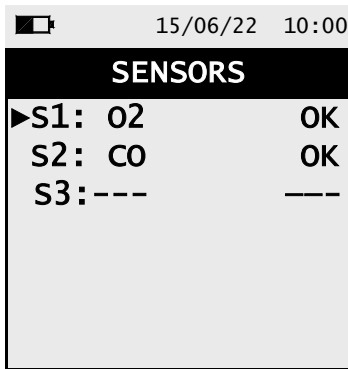

Messages on the state and calibration of the electrochemical sensors:

Ok	No problem detected
absent	The sensor was not detected
err data	Memory data error of the sensor
unknown	It is necessary to update the firmware of the device
err pos	The sensor has been installed in the wrong position
err cal	Calibration error (sensor not calibrated)
err curr	Currents outside the range
err cfg	Do not use this sensor as it has not been accepted on the screen "types of sensors".

KEY	DESCRIPTION
	Returns to the previous screen.
	Selects the available parameters.
	Shows the details about the selected sensor.

Example:

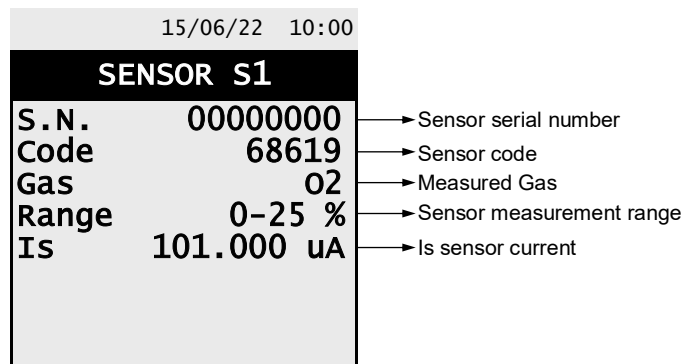
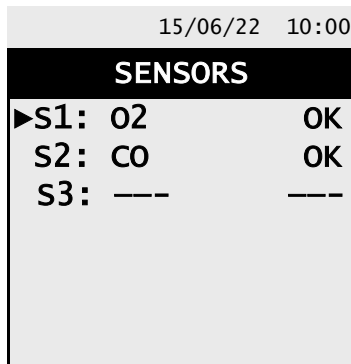

13.1.2 Menu→Diagnostic→Gas probe

15/06/22 10:00

GAS PROBE

Close the flue
gas probe

Push OK to
continue

Connect the flue gas sampling probe and filter unit assembly to the instrument;
Fully insert the black rubber cap (68624) on the gas probe tip, as shown in the following picture:

KEY	FUNCTION
	Returns to the previous screen.
	Starts the test to check the tightness of the gas sampling probe.

Tightness test of the probe.

15/06/22 10:00

GAS PROBE

Close the flue
gas probe

Push OK to
continue

15/06/22 10:00

GAS PROBE

Calibration

→

15/06/22 10:00

GAS PROBE

Probe Test

→

15/06/22 10:00

GAS PROBE

Calibration
Probe Test

Result: Tight

Results:

Tightness: The system is OK

Leak: Make sure that the probe is connected to the input P- or P+, check the seals of the pneumatic connections and/or the seal of the condensation trap and check that the test cap is correctly inserted on the tip of the probe. **WARNING: a damaged probe tip may impair the test.**

Error: It is not possible to perform the test because the sensor is not calibrated.

13.1.3 Menu→Diagnostic→Hardware

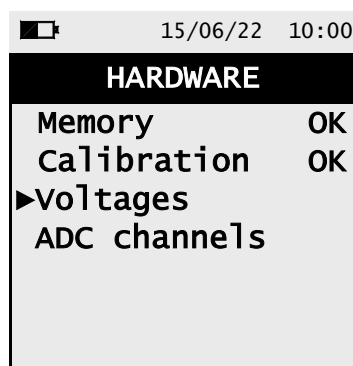

KEY	FUNCTION
	Returns to the previous screen.
	Selects the available parameters.
	Enters in the selected parameter.



INTERACTIVE OPERATIONS	DESCRIPTION
mV	Shows the values in mV.
Bit	Shows the values in Bit.

Note: the memory and calibration parameters are not accessible if their condition is OK.

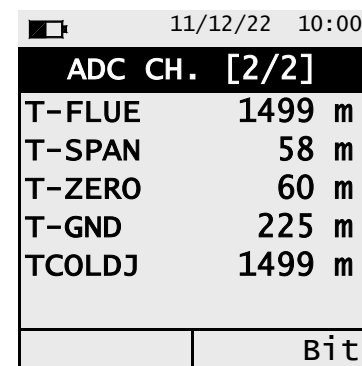
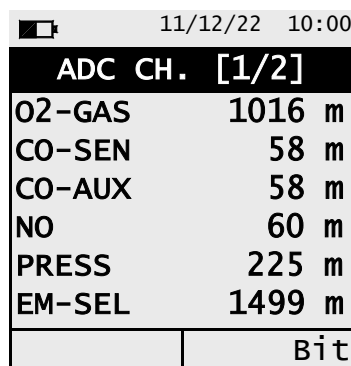
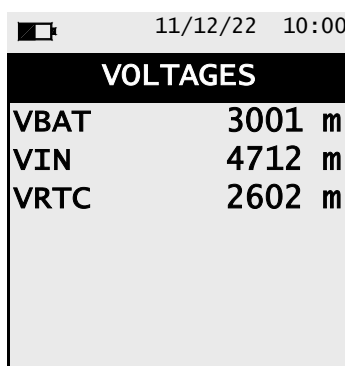
Visualization example:

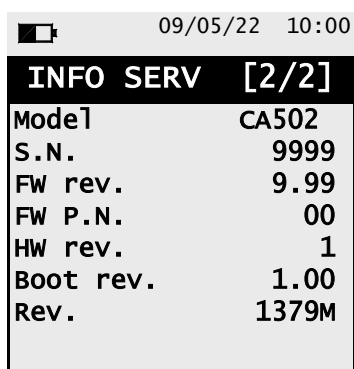
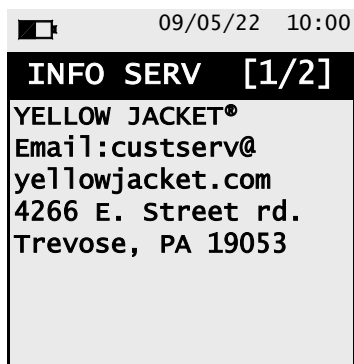



KEY	FUNCTION
	Returns to the previous screen.
 	Toggle view between next or previous screen.

15.1 Sensors arrangement

SENSORS ARRANGEMENT INSIDE THE SENSORS COMPARTMENT

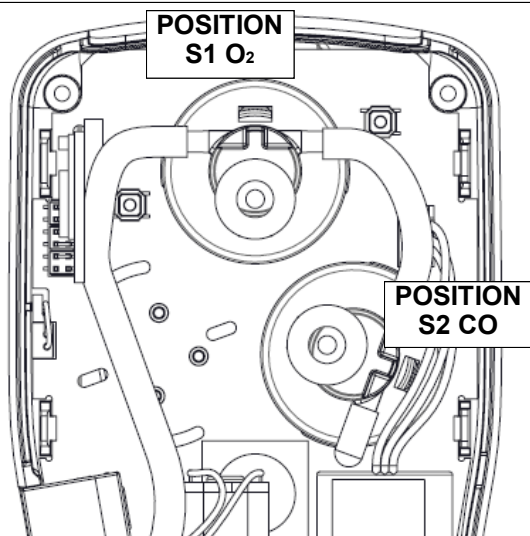

GRAPHICAL DISPLAY OF ARRANGEMENT

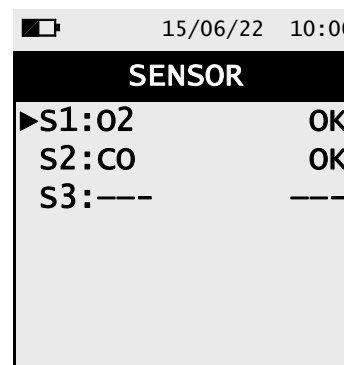

15.2 Sensor types and relevant positioning

CODE	POSITION	S1	S2
O₂ Sensor Part n. 68619		✓	
CO Sensor with NO_x filter 0-4000ppm Contact us for sensor			✓

15.3 Gas sensors life

The gas sensors used in this instrument are electrochemical: thus, when the relative gas is detected, a chemical reaction takes place inside them that generates an electrical current.

The electrical current acquired by the instrument is then converted into the corresponding gas concentration. Sensor life is strongly related to the consumption of the reagents within.

Sensor characteristics diminish as the reagents are consumed and when these have been used up completely the sensor must be replaced. The sensors must be recalibrated on a regular basis to assure measuring accuracy: recalibration can only be performed by a qualified YELLOW JACKET® service center.

Table 15.4 illustrates the characteristics inherent to each sensor.

15.4 Gas sensors life table

CODE	MEASURED GAS	AVERAGE LIFE	RECALIBRATION
O₂ Sensor Part n. 68619	O ₂ Oxygen	24 months	not necessary
CO Sensor with NO_x filter + H₂ immunity 0-4000ppm <i>Contact us for sensor</i>	CO Carbon Monoxide	24 months	Yearly

16.1 Routine maintenance

This instrument was designed and manufactured using top-quality components. Proper and systematic maintenance will prevent the onset of malfunctions and will increase instrument life altogether.

The following basic requisites are to be respected:

- When the analysis is over remove the sample probe from the stack and let the analyzer draw fresh air for a few minutes, or at least until the displayed parameters return to their original values:
O₂: >20.0%
Toxic gases: <20ppm
- Clean the filter unit when necessary, replacing the particulate filter and applying a jet of air to the sample probe hose to eliminate any condensate that may have formed.

Do not clean the instrument with abrasive cleaners, thinners or other similar detergents.

16.2 Preventive maintenance

At least once a year send the instrument to the Yellow Jacket service center for a complete overhaul and thorough internal cleaning.

YELLOW JACKET® highly qualified staff is always at your disposal and will provide you with all the sales, technical, application and maintenance details required.

The service centre will always return the instrument to you as new and in the shortest time possible. Calibration is performed using gases and instruments comparable with National and International Specimens. Annual servicing is accompanied by a specific calibration certificate that is a guarantee of perfect instrument performance, and it is indispensable for users wishing to maintain ISO 9000 status.

16.3 Gas sensors replacing

- 1 Unscrew the four screws of the instrument base; then slide apart the base of the instrument to access the internal parts.
- 2 Locate the position of the sensor to be replaced; below is an example of a sensor to be replaced.

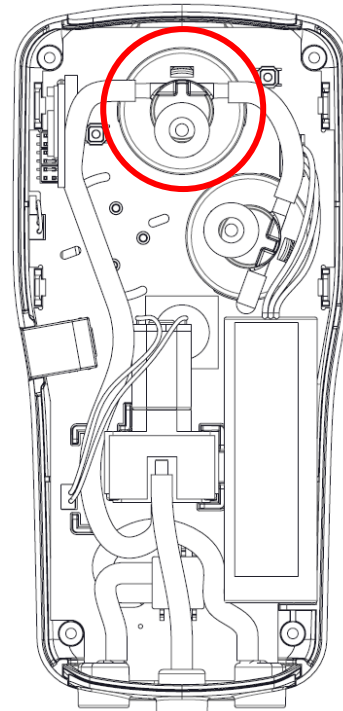
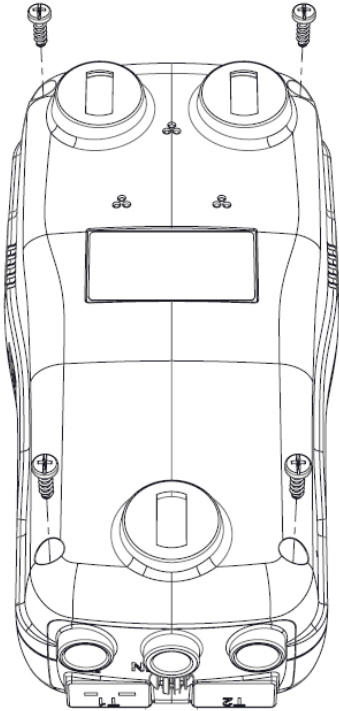

- 3 Remove the tubes from the sensor to be replaced; below is an example of a sensor with the disconnected pipes.
- 4 After disconnecting the pipes, pull the sensor upwards; below is an example of the sensor compartment without the sensor.

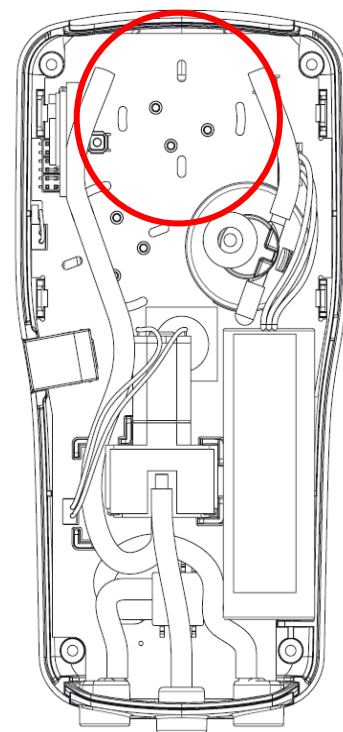
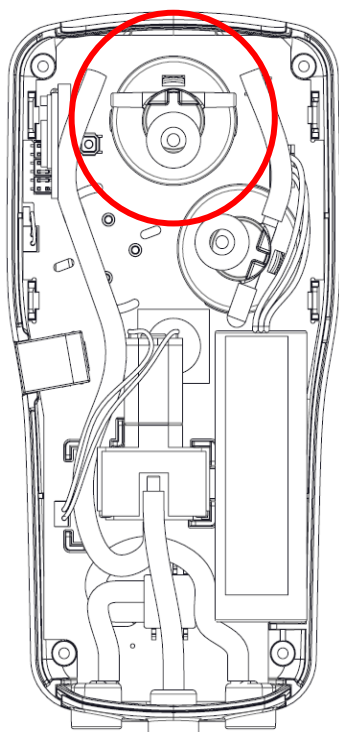

- 5 Insert the new sensor paying attention to match the sensor connectors with the relevant supports on the circuit board.
- 6 Place back the tubes (See point 4).
- 7 Close back the base of the instrument and screw back the four screws (See point 2).

Turn on the instrument to check the new sensor works correctly through the menu "Sensor Troubleshooting".
It is normal if a newly installed sensor gives a 'current error': it is necessary to wait some time, so that the sensor polarization can settle.

The table here below shows the minimum settling time for each sensor.

CODE	DETECTED GAS	POSITION	SETTLING TIME
O₂ Sensor P/N 68619	O ₂ Oxygen	S1	8 hours
CO Sensor with NO_x filter 0-4000ppm	CO Carbon Monoxide	S2	2 hours

16.4 Replacing the battery pack

Follow these instructions to replace the battery pack:

1 Remove the base of the instrument

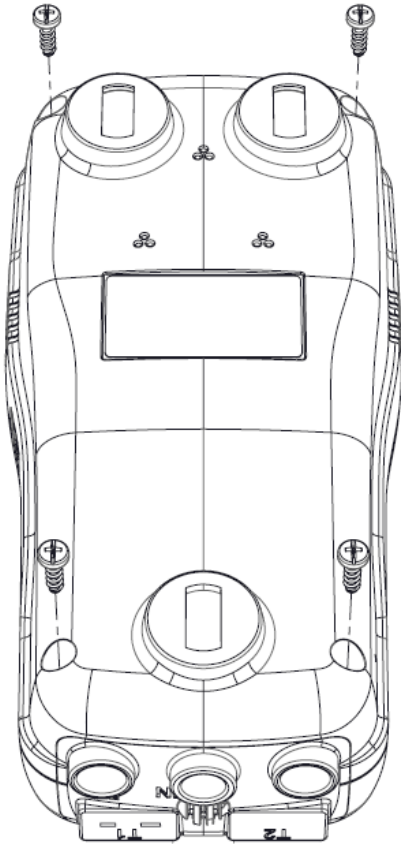

2 Extract the battery pack.

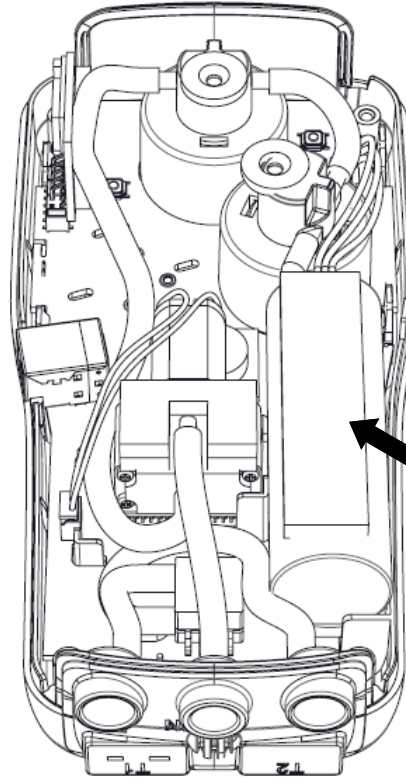

3 Remove the battery pack connector, and replace the pack with a new one following the reverse procedure described above.

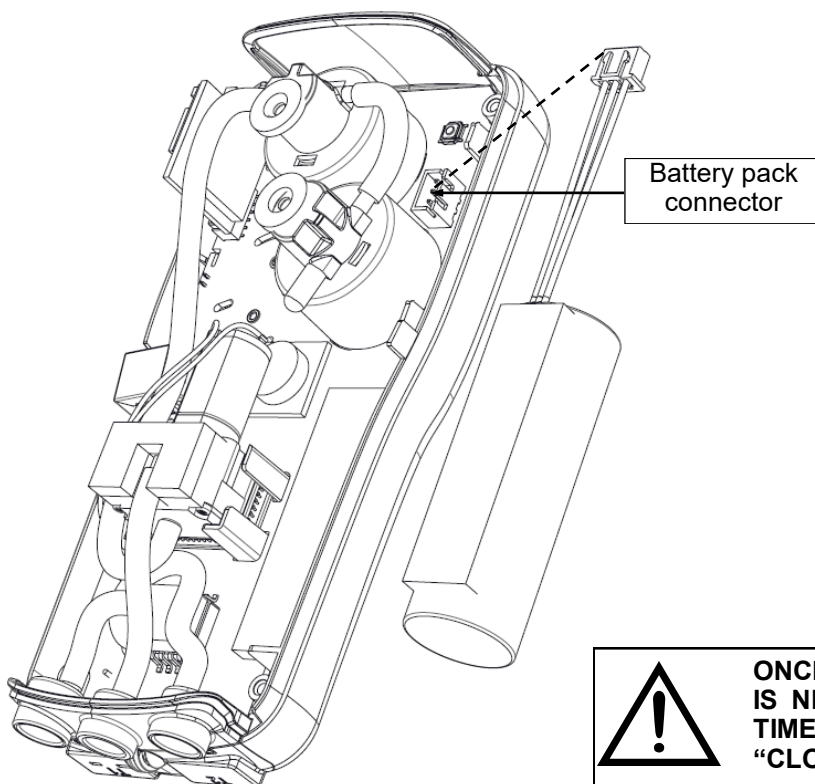



ONCE THE BATTERY IS REPLACED IT IS NECESSARY TO RESET DATE AND TIME THROUGH THE PARAMETER "CLOCK" ([SEE CHAPTER 12.3.3](#)).

17.0 FIRMWARE UPDATE

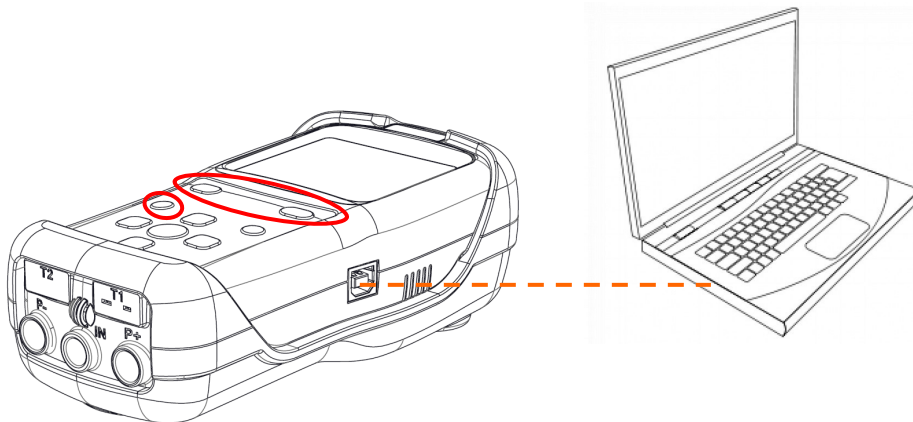

The manufacturer periodically releases firmware updates of the instrument in order to correct unavoidable mistakes or improve the instrument performance or add new functions. This update can be performed by the user by following the simple instructions below.

Instructions to update the combustion analyzer with a new firmware:





1. Log in to the website <http://yellowjacket.com> and download the firmware file available in the "combustion analyzers" section. This file is in a compressed version .zip.
2. Unzip the file thus obtaining the contents of the .zip file (extension .srec)
3. Plug in the analyzer to the PC via the USB cable
4. Hold down the three circled buttons in above picture on the analyzer for at least 10 seconds:

5. The display turns off
6. Release only the power  button
7. The analyzer will be recognized by the operating system as a portable device drive: the display starts blinking
8. Release the remaining two buttons
9. Copy the firmware file (extension .srec) to the directory of the analyzer: the display continues to blink faster
10. Wait till the end of the file copy operation
11. The file copy directory will be closed and the analyzer will restart
12. The analyzer is now updated, it can be powered off and it can be unplugged from the PC

18.1 Troubleshooting guide

SYMPTOM	PROBABLE CAUSES AND REMEDIES
<p>The instrument does not work at all. Pushing the  button the instrument does not turn on.</p>	<ul style="list-style-type: none"> a. Press the  for at least 2 seconds. b. The battery is low; connect the battery charger to the instrument. c. The battery pack is not connected to the instrument. Access the internal parts of the instrument and verify that the connector of the battery pack is inserted in the proper connector (SEE CHAPTER 16.4). d. The instrument is faulty: send it to a service center.
<p>The battery symbol is empty on the inside and blinking.</p>	<p>The batteries are low. The instrument will remain on for a couple of minutes after which it will switch off; connect the battery charger.</p>
<p>The instrument battery performance is lower than what stated in the “Technical features” chapter.</p>	<ul style="list-style-type: none"> a. The battery capacity is limited at a low temperature. To obtain a greater performance it is advised to keep the instrument in higher temperatures. b. Perform a 100% complete charge cycle connecting the instrument to the plug for at least 6 hrs. c. That battery pack is old. Aging can cause the batteries to reduce their capacity. If the performance has become unacceptable change the internal battery with an original part Yellow Jacket.(68623) d. Verify the measured voltage values in “Menu→Diagnostic→Hardware→Voltages”: <ul style="list-style-type: none"> - If VBAT<3000mV: the battery needs to be changed. - If VIN <4700mV: the output voltage of the battery charger is not sufficient to recharge the instrument battery. In this case verify the connections and the plate data of the battery charger in use: 5Vdc 2A. d. If the problem keeps on happening contact the SERVICE CENTER.
<p>Date and time are not memorized.</p>	<ul style="list-style-type: none"> a. Verify the voltage value VRTC showed in “Menu→Diagnostic→Hardware→Voltages”: If <2600mV contact the SERVICE CENTER. b. The battery is completely drained (VBAT<2500mV)
<p>After the autozero, the sensor diagnostic screen appears, which indicates an error in one or more cells.</p>	<ul style="list-style-type: none"> a. The autozero has been performed while the combustion gas sample was still being taken. b. The O₂ sensor is broken, incorrectly connected or not connected at all. Check the described points, with the help of the paragraph 5.3, 5.4, 6.6. c. The waited settling time of the sensor was not enough or the instrument has been left with a low battery charge for a long time.
<p>In the Pressure / Draft screen there is an error of the pressure sensor.</p>	<p>There is a calibration problem. Send the instrument to the service center.</p>
<p>In the analysis screen there is an error in the smoke temperature measurement (Tf).</p>	<ul style="list-style-type: none"> a. Thermocouple not connected; connect the thermocouple to the analyzer. b. The sensor has been exposed to temperature higher or lower than its functioning. c. The thermocouple is faulty. Send the entire probe to the service center.

Troubleshooting guide

SYMPTOM	PROBABLE CAUSES AND REMEDIES
The following symbol "----" appears on the analysis screen.	The instrument is not able to calculate a numerical value based on the flue gas analysis conducted. The "----" are replaced by numbers when the analyzer detects valid combustion data.
"Max. Lim." or "Min. Lim" appears on the analysis screen.	The relative sensor is detecting a value that is beyond the analyzer measuring range. "Max. Lim" or "Min. Lim." are replaced by numbers when the instrument reveals values that are within the measuring range.
The sample pump sounds as though it is running slowly, tends to stop or does not even start.	<p>a. Sample flow is obstructed. Check that the water filter is clean and that it is not completely soaked. Also check that the hose connected to the probe is not crushed.</p> <p>b. Sample intake flow is obstructed. Check that the particulate filter is clean.</p> <p>c. Pump is disabled. The key combination   has been pressed. To re-enable the pump, switch off the instrument and then switch it on again.</p>
The back lighting of the display does not turn on.	The instrument is faulty. Send it to the service center for repairing.
The values shown in the analysis screen are not reliable.	<p>a. Sensor/s is/are faulty. Check that the sensors are installed correctly by accessing the sensor diagnostics menu.</p> <p>b. The sample probe connection presents a leak. Check all joints and the conditions of the hose.</p> <p>c. The instrument is faulty: Send it to a service center for repairing.</p>

19.1 Spare parts

PART NUMBER	DESCRIPTION
68612	Replacement particulate filter (5-pack)
68623	Li-Ion 7,2V 2,4Ah battery pack
68619	O2 Sensor Replacement
68616	Printer Paper (5-pack)

19.2 Accessories

PART NUMBER	DESCRIPTION
68613	AC Power Adapter Kit For ALL Analyzers (Power adapter w/ US plug adapter + USB A / USB B cable)
68615	Carrying case
68622	7 inches (180 mm) gas probe, maximum working temperature: 752°F, with 5 ft (2 mt) cable
68624	Rubber probe cover
68617	Water trap / filter assembly
68614	Adapter cable USB-A / USB-B
68611	Wireless Bluetooth® printer
68618	O-ring replacement for water trap
68620	Manometer hose
68621	POSG cone for probe

19.3 Service Centers

YELLOW JACKET®
4266 E. Street Rd.
Trevose, PA 19053
Email: custserv@yellowjacket.com
WWW.YELLOWJACKET.COM

Data Management with the YELLOW JACKET® YJ Combustion App

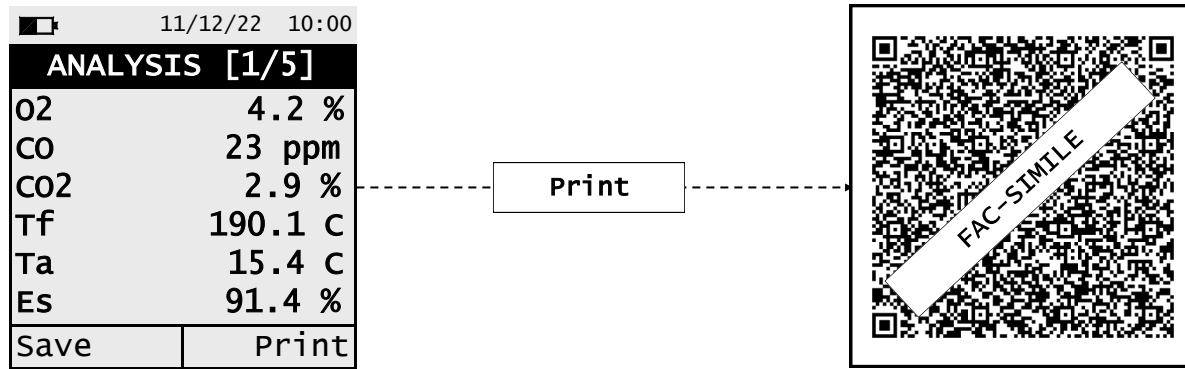

SCAN THE QR CODE USING THE YELLOW JACKET® APP, TO DOWNLOAD THE ACQUIRED DATA.

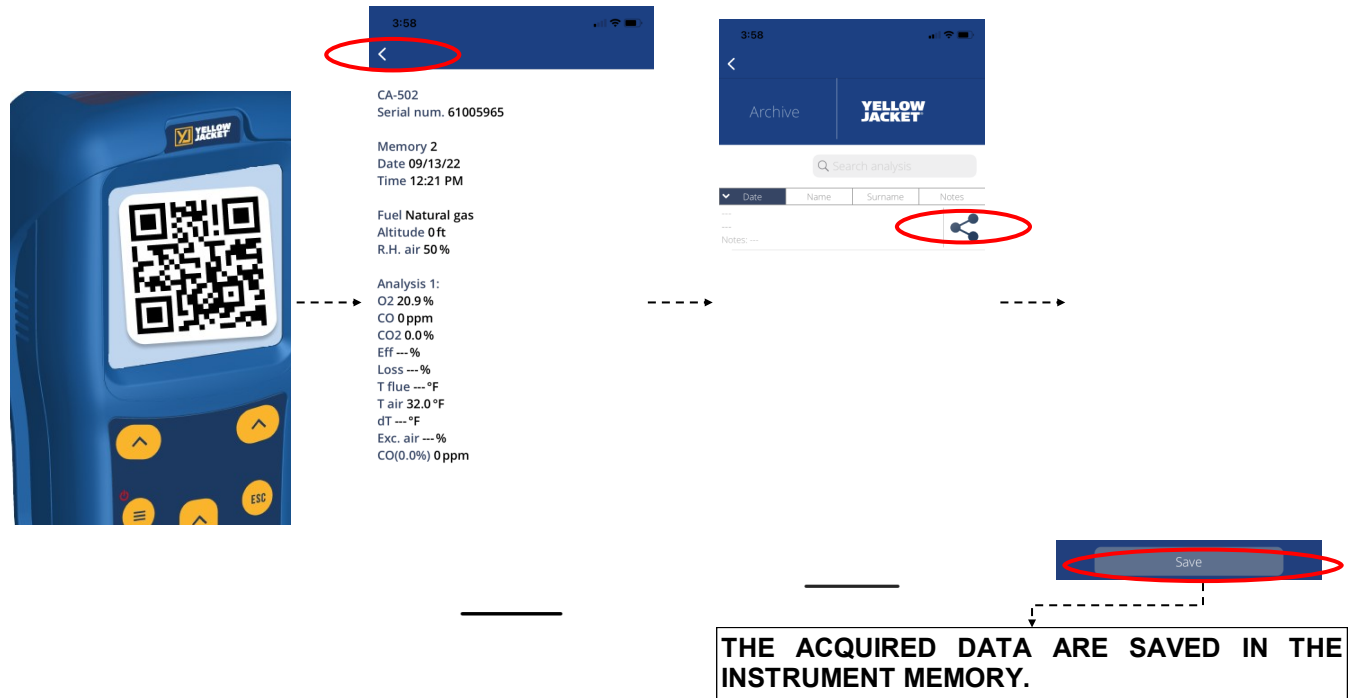

APP settings.

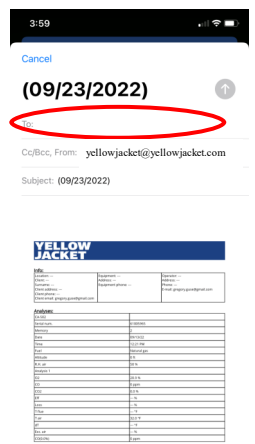

- > Insert a customer email address.
- > Select subject matter line and fill out
- > Add any job site notes and message for customers in body of email and select send.

Optional measures list:

MEASURE	DEFINITION
$\lambda, n (l,n)$	Air index (defined as λ , sometimes also indicated as n).
e (Exc. Air)	Air excess. Expressed as a percentage according to the formula in the appendix D, is the ratio between the volume of air actually entering the combustion chamber and the one theoretically needed.
ΔT (dT)	Temperature Differential : Is the difference between the smoke temperature and the air combustion temperature.
Q_s (LHV)	Stack losses in relation to the Lower Heating Value: Is the percentage of dissipated heat through the stack referred to the lower heating value (LHV)
η_s (Es) (LHV)	Sensible efficiency in relation to the Lower Heating Value: Is the burner efficiency calculated as the ratio between conventional heating power and the burner heating power. Among the combustion losses, only the sensible heat lost with flue gases is taken into account, thus neglecting the radiation losses and incomplete combustion losses. This value is referred to the Lower Heating Value (LHV) of the fuel and cannot exceed 100%. The sensible efficiency value is to be compared against minimum efficiency stated for the heating system performances.
η_c (Ec) (LHV)	Condensation efficiency in relation to the Lower Heating Value: Efficiency deriving from the condensation of water vapor contained in flue gases it is referred to the LHV.
η_t (Eff) (LHV) $\eta_t = \eta_s + \eta_c$	Total efficiency in relation to the Lower Heating Value: Total efficiency. It is the sum of sensible efficiency and condensation efficiency. It is referred to LHV (Lower Heating Value) and can exceed 100%.
NOx	Measure of nitrogen oxides quantity; the measurement unit can be set in the special menu.
NOx ppm	Measure of nitrogen oxides quantity; the measurement unit can not be set but it is fixed in ppm.
NOx (rif. O2)	Measure of nitrogen oxides quantity referring to O ₂ ; the measurement unit can be set in the special menu.
NOx (rif. O2) ppm	Measure of nitrogen oxides quantity referring to O ₂ ; the measurement unit can not be set but it is fixed in ppm.
PI	Poison Index (CO/CO₂ ratio): It is defined as the ratio between CO and CO ₂ useful to determine whether the system needs maintenance.
CO	CO quantity measurement. Measurement units: ppm - mg/m ³ - mg/kWh - ng/J - g/GJ - g/m ³ - mg/kWh - %
CO (RIF)	CO quantity measurement with O ₂ reference. Measurement units: ppm - mg/m ³ - mg/kWh - ng/J - g/GJ - g/m ³ - mg/kWh - %

Measurement units matching → abbreviations

ppm	p
mg/m ³	g
mg/Kwh	w
g/GJ	J
ng/J	J
g/m ³	G
g/Kwh	W
hPa	h
Pa	P
mbar	b
mmH ₂ O	H
mmHg	g
inH ₂ O	i
psi	p
°C	C
°F	F
m	m
ft	ft

Coefficients of the Fuels and Formulas

The following chart, lists the coefficients of the memorised fuels, used for calculating losses and efficiencies. Details of the coefficients of the fuels:

Coefficients for calculating combustion efficiency								
Fuel	A1 USA	B	CO ₂ t (%)	PCI (KJ/Kg)	PCS (KJ/Kg)	M air (Kg/Kg)	M H ₂ O (Kg/Kg)	V dry gas (m ³ /Kg)
Natural Gas	0,0280	0,0090	11,70	50050	55550	17,17	2,250	11,94
Propane	0,0277	0,0073	13,70	45950	49950	15,61	1,638	11,11
#2 Oil	0,0305	0,0066	15,70	42900	45700	14,30	1,136	10,34
#4 Oil	0,0306	0,0066	15,80	41100	43500	13,80	0,973	10,06
#6 Oil	0,0346	0,0048	16,00	39800	42197	13,61	0,981	9,97
Diesel	0,0305	0,0066	15,70	42900	45700	14,30	1,136	10,34
Wood/Pellets 8%	0,0354	0,0071	19,01	18150	19750	6,02	0,660	4,58
Bagasse	0,0395	0,0219	20,45	6950	8834	2,50	0,779	1,93
Coal	0,0320	0,0000	18,60	31400	32300	10,70	0,370	8,14
Biogas	0,0353	0,0091	17,33	17800	19800	6,08	0,830	4,55
Bio-Fuel 5%	0,0305	0,0066	15,70	42600	45400	14,22	1,133	10,64
Butane	0,0277	0,0073	14,00	45360	49150	15,38	1,548	10,99

- **CO₂ t:** The value of CO₂ generated by combustion in stoichiometric condition, i.e. without excess Oxygen and therefore maximum.
- **A1, B:** Also please have a look at the Siegert formulas from the European standard EN50379-1 (in the following).
A1 is the parameter in the Siegert Formula when the O₂ measurement is available.
NOTE: For the US the A1 parameter is the same as the 'European' A1 BUT divided by 2.

Flue gas heat losses are calculated from measured oxygen content according to the relationship:
Flue gas heat losses are calculated from measured carbon dioxide content according to the relationship:

$$q_A = (t_A - t_L) \times \left(A1 \frac{21}{21 - O_2} + B \right)$$

- **CO conv:** Conversion coefficient from ppm to mg/KWh. It can be expressed as a function of the gas density

$$q_A = (t_A - t_L) \times \left(A1 \frac{CO_2t}{CO_2} + B \right)$$

Air index is calculated with the formula:

$\lambda = 21 / (21 - O_2)$, where O₂ is the oxygen residual concentration in the combustion smokes.

Air excess is calculated with the formula:

$$e = (\lambda - 1) * 100$$

(CO in this case) and the volume of the dry smoke.

- **NO conv:** Same as CO conv, but for NO.
- **NO_x conv:** Same as CO conv, but for NO_x.
- **SO₂ conv:** Same as CO conv, but for SO₂.
- **PCI:** Potere Calorifico Inferiore. Italian for LHV (Lower Heating Value).
- **PCS:** Potere Calorifico Superiore. Italian for HHV (Higher Heating Value).
- **m H₂O:** Mass of the air produced (per each Kg of fuel) in the combustion in stoichiometric condition.
- **m Air:** Mass of the air needed for combustion in stoichiometric condition.
- **V g.d.:** Volume of dry smokes produced in the combustion.

WARRANTY CERTIFICATE

WARRANTY

The CA502 flue gas analyzer is guaranteed for **12 months** from purchasing document date including the electronic parts, the internal electro-chemical sensors. .

YELLOW JACKET® undertakes to repair or replace, free of charge, those parts that, in its opinion, are found to be faulty during the warranty period. The products which are found defective during the above mentioned periods of time have to be delivered to YELLOW JACKET® Laboratories postage paid. The following cases are not covered by this warranty: accidental breakage due to transport, inappropriate use or use that does not comply with the indications in the product's instruction manual or quick start guide. Any mistreatment, repairs and modifications to the product not explicitly authorized by YELLOW JACKET® shall invalidate the present warranty.

IMPORTANT

For the product to be repaired under Warranty, please send a copy of this Certificate along with the instrument to be repaired, together with a brief explanation of the fault observed.

Space reserved for user

Name: _____

Company: _____

User's notes:

Date: _____

Serial Number



Ritchie Engineering Co./ YELLOW JACKET®
Customer Service: 1-800-769-8370 or 952-943-1300
www.yellowjacket.com

YELLOW JACKET® Laboratories
4622 E. Street Rd
Trevose, PA 19053