User's Manual

Model CA51, CA71 HANDY CAL (Calibrator)

IM CA71-E

Store this manual in an easily accessible
place for quick reference.

Introduction

Thank you for purchasing the CA51/CA71 HANDY CAL Calibrator. This User's Manual explains the functions of the CA51 and CA71, as well as the operating methods and handling precautions. Before using this product, thoroughly read this manual to understand how to use it properly.

■ List of Manuals

The following manuals, including this one, are provided as manuals for the CA51 and CA71. Please read all manuals.

| Manual No. | Description |
|--------------|-----------------------------|
| IM CA71-E | User's Manual (this manual) |
| IM CA71-93Z2 | Document for Korea |

Contact information of Yokogawa offices worldwide is provided on the following sheet.

| Document No. | Description |
|--------------|---|
| PIM 113-01Z2 | Inquiries List of worldwide contacts |

■ **Notes**

- This manual exclusively describes the CA71, which is more multifunctional than the CA51. The CA51 has no temperature measurement and communication functions.
- The contents of this manual are subject to change without prior notice for reasons of improvements in performance and/or functionality.
- Every effort has been made to ensure the accuracy of this manual. If you notice any errors or have any questions, however, please contact the vender from which you purchased the instrument.
- The content of this manual may not be transcribed or reproduced, in part or in whole, without prior permission.

■ **Trademark Acknowledgments**

- All other company and product names appearing in this document are trademarks or registered trademarks of their respective holders.

■ **Revision Information**

| | |
|----------------|---------------|
| February 2002: | First Edition |
| December 2006: | 2nd Edition |
| November 2007: | 3rd Edition |
| January 2012: | 4th Edition |
| July 2014: | 5th Edition |
| April 2015: | 6th Edition |
| April 2016: | 7th Edition |
| August 2017: | 8th Edition |
| October 2017: | 9th Edition |
| November 2018: | 10th Edition |
| March 2021: | 11th Edition |
| May 2021: | 12th Edition |

Checking Items in the Package

After opening the package, check the product as follows before use. If the delivered product is the wrong model, any item is missing, or there are visible defects, contact the vendor from which you purchased the product.

Main Unit

Check the model (specifications) codes in the MODEL and SUFFIX fields of the nameplate at the back of the instrument to ensure that the instrument is exactly as specified in your purchase order.

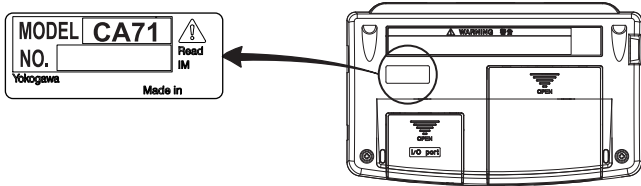

- Model Codes

| Model | Specification |
|-------|---|
| CA51 | Basic model |
| CA71 | Provided with temperature measurement and communication functions |

- NO. (Serial Number)

Refer to this serial number on the nameplate when contacting the vendor about the instrument.

Standard Accessories

Make sure that the package contains all the accessories listed below and that they are all free from any damage.

Standard accessories are not covered by warranty of this instrument.

**Lead cables
for source**
(98020)

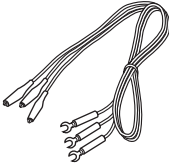

**Lead cables for
measurement**
(RD031)

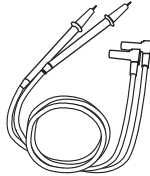

Carrying case
(93016)

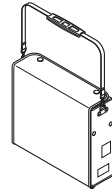

Terminal adapter
(99021)

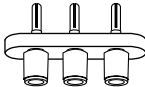

**AA-size (LR6)
alkaline batteries**
(four units)

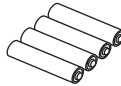

User's manual
(IM CA71-E)

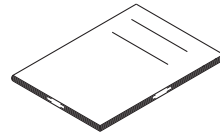

Optional Accessories

The products listed below are available as optional accessories.

If you purchased some of the optional accessories, make sure the delivered package is complete with the ordered items and they are free from any damage.

For technical and ordering inquiries concerning the accessories, contact the vendor from which you purchased the instrument.

| Product | Part Number | Remarks |
|--------------------------------|-------------|-------------------------------------|
| AC adapter | 94012 | For 100 VAC |
| AC adapter | 94013 | For 120 VAC |
| AC adapter | 94016 | For 220 to 240 VAC |
| RJ sensor | B9108WA | For reference junction compensation |
| Accessories case | B9108XA | |
| Communication cable (RS232) | 91017 | (For CA71 only) |

Power cord of AC adapter:

94016-F (VDE standard), 94016-S (BS standard)

Make sure that the attached power cord meets the designated standards of the country and area that you are using it in.

Optional Spare Parts

| Product | Part Number | Remarks |
|-------------------------------|-------------|----------------------------------|
| Lead cable for source | 98020 | |
| Lead cable for measurement | RD031 | |
| Carrying case | 93016 | |
| Terminal adapter | 99021 | Used for temperature measurement |
| Fuse | --- | A1635EF (1 piece) |

Accessories case



RJ sensor

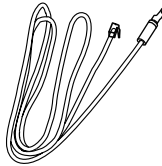

Communication cable

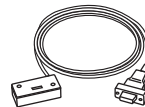

AC adapter

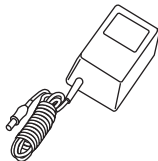

Precautions for Safe Use of the Instrument

This product is designed to be used by a person with specialized knowledge. When operating the instrument, be sure to observe the cautionary notes given below to ensure correct and safe use of the instrument. If you use the instrument in any way other than as instructed in this manual, the instrument's protective measures may be impaired. This manual is part of the product and contains important information. Store this manual in a safe place close to the instrument so that you can refer to it immediately.

Keep this manual until you dispose of the instrument.

YOKOGAWA is by no means liable for any damage resulting from use of the instrument in contradiction to these cautionary notes.

The following symbols are used on the instrument and in the User's Manual to ensure safe use.



Danger! Handle with Care.

This symbol indicates that the operator must refer to an explanation in the User's Manual in order to avoid the risk of injury or loss of life of personnel or damage to the instrument.



This symbol indicates DC voltage/current.



This symbol indicates AC voltage/current.



This symbol indicates AC or DC voltage/current.



WARNING

Indicates that there is a possibility of serious personal injury or loss of life if the operating procedure is not followed correctly and describes the precautions for avoiding such injury or loss of life.



CAUTION

Indicates that there is a possibility of serious personal injury or damage to the instrument if the operating procedure is not followed correctly and describes the precautions for avoiding such injury or damage.



NOTE

Draws attention to information essential for understanding the operation and features.

TIP

Provides additional information to complement the present topic.

Damage to the instrument or personal injury or even loss of life may result from electrical shock or other factors.

To avoid this, follow the precautions below.



WARNING

- **Use the instrument Only for Its Intended Purpose**

This instrument is for generating (sourcing)/measuring voltage or current. (This instrument is for generating and measuring resistance and generating and measuring temperature using resistance or thermocouples.) Do not use this instrument for other purpose.

- **Check the Physical Appearance**

Do not use the instrument if there is a problem with its physical appearance.

- **Use in gases**

Do not operate this instrument in areas where inflammable or explosive gases or vapor exists.

It is extremely hazardous to use the instrument under such environments.

- **Defects in protective features**

Do not operate this instrument if any defect seems to exist in such protective features as fuses.

Before operating the instrument, make sure the protective features are free from any defect.

- **External connection**

When connecting the instrument to the object under test or an external control circuit, or if you need to touch any external circuit, cut off the power to the circuit and make sure no voltage is being supplied.

- **Fuses**

In order to prevent a possible fire, use a fuse with ratings (current, voltage, and type) specified for the instrument. Do not short-circuit the fuse holder.

 **WARNING**

• **Correct Use of Lead Cables**

Use the lead cables supplied by YOKOGAWA with this instrument.

Do not use lead cables that have deteriorated or are defective.

Check lead cables continuity.

Correctly use the lead cables for measurement (P/N: RD031) and source (P/N: 98020) without mistaking one for the other.

For high-voltage measurement, always use the lead cable for measurement.

• **Damaged Signal Cable**

If the signal cable (lead cables) is torn and the inner metal is exposed or if a color different from the outer sheath appears, stop using the cable immediately.

• **Do Not Remove the Casing or Disassemble**

Only Yokogawa service personnel are authorized to remove the casing or disassemble or modify the instrument.

Do not attempt to repair the instrument yourself, as doing so is extremely dangerous. Some parts inside the instrument are extremely dangerous because they use a high voltage.

When the instrument needs an internal inspection or calibration, contact YOKOGAWA or the dealer from whom you purchased the instrument.

 **CAUTION**

The use of this instrument is limited to residential, commercial, and light-industrial environments.

This instrument may not be able to measure accurately if it is near other equipment generating strong electromagnetic interference or a strong magnetic field caused by large current.

For the safe use of the optional AC adapter, follow the precautions given below.

 **WARNING**

- Make sure that the rated power supply voltage of the instrument matches the voltage of the power supply before turning on the power.
 - To prevent the possibility electrical shock or fire, be sure to use the AC adapter and the power cord supplied by YOKOGAWA. Additionally, do not use the AC adapter and the power cord supplied with this instrument with another instrument.
 - Do not place anything on the AC adapter or power cord, and prevent heat sources from coming into contact with them.
 - When unplugging the power cord from the outlet, be sure to hold the plug and never pull the actual cord.
 - Do not throw (dispose of) the AC adapter in fire or apply heat to it.
 - Do not use it, where the cord is bundled (bent).
 - If the power cord is damaged, contact your dealer.
-

Contents

| | |
|---|------------|
| Introduction | i |
| Checking Items in the Package | iii |
| Precautions for Safe Use of the Instrument | vi |
| 1. Functions | 1-1 |
| 2. Names and Functions of Parts | 2-1 |
| 3. Before Starting Source/Measurement | 3-1 |
| 4. Source | 4-1 |
| 4.1 Connecting Cables to Terminals | 4-2 |
| 4.2 Sourcing DC Voltage, DC Current or SINK Current Signal | 4-3 |
| 4.2.1 Sourcing DC Voltage or DC Current Signal | 4-3 |
| 4.2.2 4-20 mA Function | 4-4 |
| 4.2.3 20 mA SINK Function | 4-5 |
| 4.2.4 Using As 24-V Loop Power Supply | 4-6 |
| 4.3 Sourcing Resistance or RTD Signal | 4-7 |
| 4.4 Sourcing Thermocouple (TC) Signals | 4-9 |
| 4.4.1 When RJ Sensor Is Used (Making Use of Reference Junction Compensation) | 4-9 |
| 4.4.2 When No RJ Sensor Is Used | 4-12 |
| 4.5 Sourcing Pulse Signals | 4-13 |
| 4.5.1 Sourcing a Continuous Pulse Train | 4-13 |
| 4.5.2 Sourcing the Preset Number of Pulses (Pulse Cycle) | 4-15 |
| 4.5.3 Using the Contact Output | 4-17 |
| 4.6 Divided Output Function (n/m) | 4-19 |
| 4.7 Sweep Function | 4-20 |
| 4.8 Auto Step Function | 4-20 |
| 4.9 Temperature Monitor Function | 4-21 |

| | |
|--|------------|
| 5. Measurement | 5-1 |
| 5.1 Connecting Cables to Terminals | 5-2 |
| 5.2 Measuring 300 V AC-range Voltage, DC Voltage, AC Voltage or DC Current | 5-4 |
| 5.2.1 Measuring 300 V AC-range Voltage | 5-4 |
| 5.2.2 Measuring DC or AC Voltage | 5-5 |
| 5.2.3 Measuring DC Current | 5-5 |
| 5.3 Measuring Resistance or RTD (CA71 only) Signal | 5-6 |
| 5.4 Measuring Temperature with Thermocouple (TC) - CA71 only - | 5-7 |
| 5.5 Measuring Frequency or Pulses | 5-8 |
| 5.5.1 Operating the Calibrator for Frequency Measurement | 5-8 |
| 5.5.2 Operating the Calibrator for Measuring Number of Pulses | 5-8 |
| 6. Memory Functions | 6-1 |
| 6.1 Saving Data into Memory | 6-2 |
| 6.1.1 Saving Data in the Order of Memory Numbers | 6-2 |
| 6.1.2 Saving Data by Selecting Desired Memory Number | 6-4 |
| 6.1.3 Overwriting Data in Memory | 6-4 |
| 6.2 Reading Data from Memory | 6-5 |
| 6.3 Clearing Data in Memory | 6-6 |
| 6.3.1 Clearing Data by Selecting Desired Memory Number | 6-6 |
| 6.3.2 Clearing All In-Memory Data Globally | 6-7 |
| 6.4 Sending Out Data from Memory - CA71 only - | 6-7 |
| 7. Functions Provided by DIP Switch | 7-1 |
| 7.1 Sweep Function | 7-2 |
| 7.2 Auto Step Function | 7-4 |
| 7.3 Selecting the INT RJ Function | 7-6 |
| 7.4 Selecting the IPTS-68 Function | 7-7 |
| 7.5 Switch Not Used | 7-7 |
| 7.6 Temp Switch | 7-7 |
| 7.7 Selecting the Contact In Function (Contact Input for Pulse Measurement) | 7-7 |

- 1
- 2
- 3
- 4
- 5
- 6
- 7
- 8
- 9
- 10
- 11
- 12
- 13
- App

- 8. Communication Function - CA71 only8-1**
 - 8.1 Cables Connection and Interface Specifications 8-1
 - 8.2 Setting the Mode..... 8-2
 - 8.3 Types of Mode 8-2
 - 8.4 Data Format 8-3
 - 8.5 Data Structure..... 8-3
 - 8.6 Commands 8-4
 - 8.7 Detailed Description of Commands 8-5
- 9. Troubleshooting and Calibration 9-1**
- 10. Method of Calibrator Adjustment 10-1**
 - 10.1 Calibration Standard Selection and Environmental Requirements 10-1
 - 10.2 Adjusting Source Functions 10-3
 - 10.3 Adjusting Measurement Functions 10-6
 - 10.3.1 Adjusting DC Voltage and DC Current Ranges 10-6
 - 10.3.2 Adjusting AC Voltage and Resistance (400 Ω) Ranges 10-8
 - 10.4 Notes on the Adjustment of Temperature Ranges - CAL71 only - 10-9
 - 10.5 Post-adjustment Verification 10-9
- 11. Using Accessories 11-1**
- 12. Specifications 12-1**
- 13. Regulations and Sales in Various Countries and Regions 13-1**
 - 13.1 Disposal 13-1
 - 13.2 For the Pollution Control of Electronic and Electrical Products of the People's Republic of China 13-2
- Appendix 1 Reference Junction Compensation App1-1**

1. Functions

■ Block Diagram

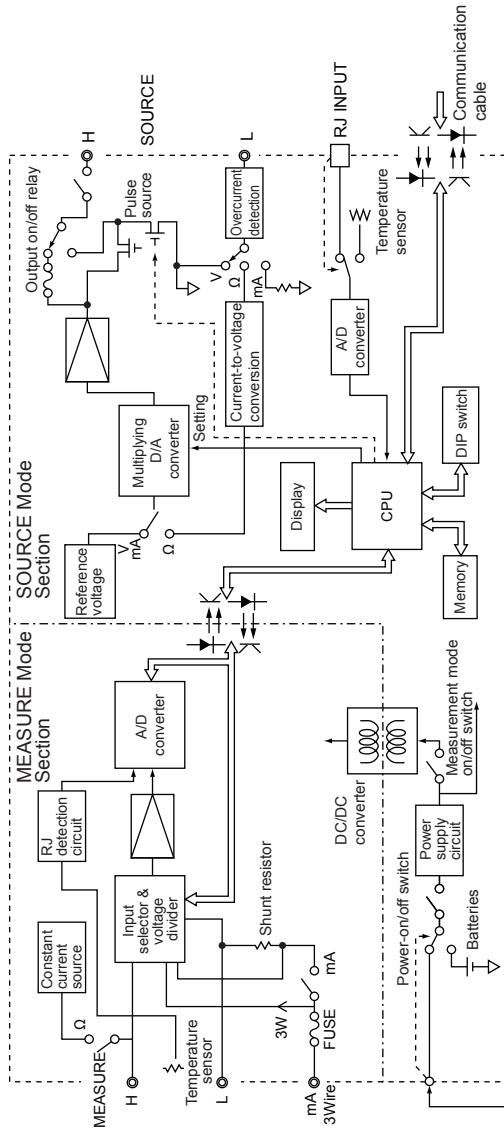

■ Main Functions

• Source

The calibrator sources a voltage, current, resistance, thermocouple (TC), RTD, frequency or pulse signal at a preset level.

| Function | Description |
|---------------------|---|
| DC voltage | Sources a DC voltage signal in the 100 mV, 1 V, 10 V or 30 V range. |
| DC current | Sources a DC current signal in the 20 mA range. |
| SINK current | Draws a sink current from an external power source in the 20 mA range. |
| Resistance | Sources a resistance signal in the 400 Ω range. |
| Thermocouple (TC) | Sources a thermoelectromotive force corresponding to the temperature detected by a type-K, E, J, T, R, B, S, N, L or U thermocouple. *1 |
| RTD | Sources resistance corresponding to the temperature detected by a Pt100 or JPt100 RTD. *2 |
| Frequency and pulse | Sources a continuous pulse train with frequency in the 500 Hz, 1 kHz or 10 kHz range. This function also sources the preset number of pulses defined by the frequency mentioned above. |

*1: The thermocouples comply with the Japanese Industrial Standard JIS C1602 (ITS-90), except for the type-L and U thermocouples that comply with DIN.

*2: The RTD comply with the Japanese Industrial Standard JIS C1604 (ITS-90).
The internal DIP switch can be configured so that the detectors comply with IPTS-68 instead.

• Measurement

Independent of the source function, the calibrator measures DC voltage, AC voltage, DC current and resistance signals, a temperature signal based on a thermocouple (TC) or RTD, as well as frequency and the number of pulses.

| Function | Description |
|---------------------|--|
| DC voltage | Measures a DC voltage signal in the 100 mV, 1 V, 10 V or 100 V range. |
| AC voltage | Measures a DC voltage signal in the 1 V, 10 V, 100 V or 300 V range. |
| DC current | Measures a DC current signal in the 20 mA or 100 mA range. The current terminals are equipped with a built-in overrange input protection fuse. |
| Resistance | Measures a resistance signal in the 400 Ω range. |
| Thermocouple (TC) | Measures temperature according to the type of thermocouple – K, E, J, T, R, B, S, N, L or U. *1 (CA71 only) |
| RTD | Measures temperature according to the type of RTD – Pt100 or JPt100. *2 (CA71 only) |
| Frequency and pulse | Measures frequency in the 100 Hz, 1 kHz or 10 kHz range. For pulse signals, this function measures the number of pulses as a CPM (count per minute) or CPH (count per hour) reading. |

You can also select and configure the following functions.

| Function | Description |
|-----------------------------------|---|
| Divided output function (n/m) | Sources a “setpoint $\times (n/m)$ ” output signal, where the variables m and n are defined as $m = 1$ to 19 and $n = 0$ to m . |
| Memory | Stores up to 50 sourced and measured values as a set. |
| Sweep | Changes the output signal in a linear manner. |
| Auto step | Automatically changes the value of n in a setpoint $\times n/m$ output in a step-by-step manner. |

- **Power Supply**

The calibrator operates on AA-size (LR6) alkaline batteries or the optional AC adapter.

2. Names and Functions of Parts

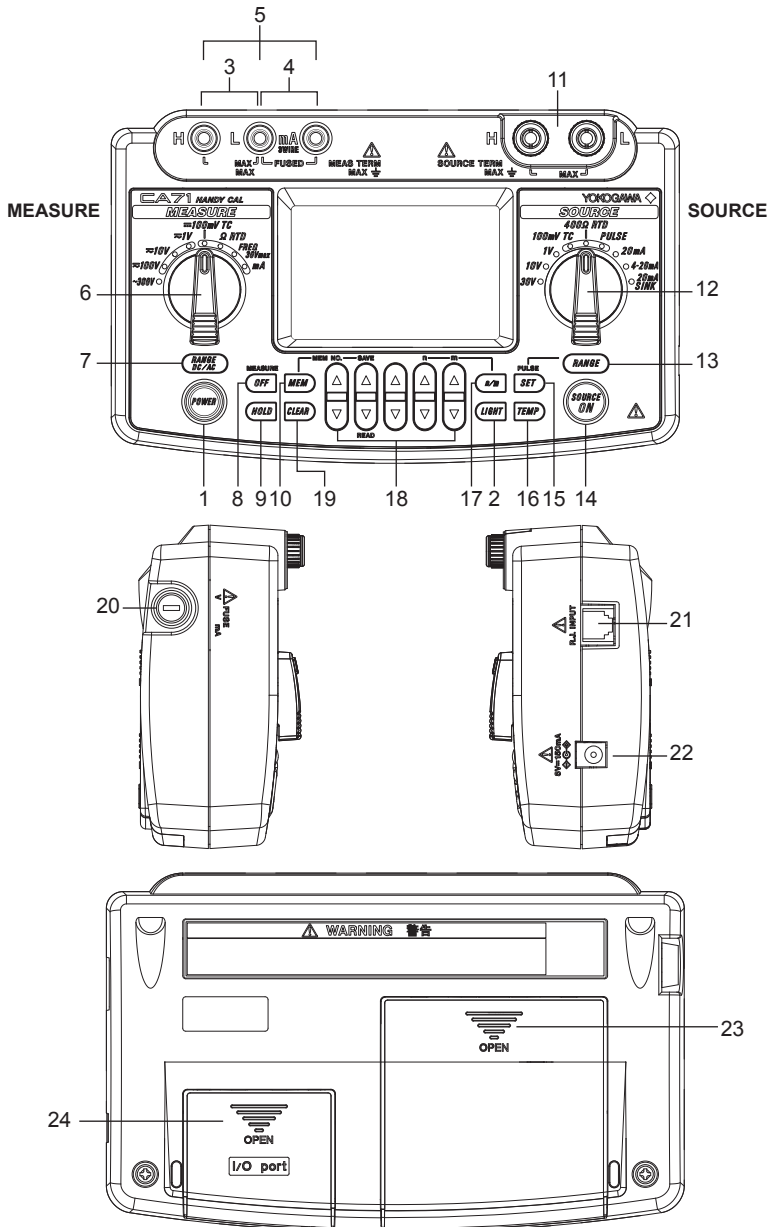

■ Front Panel

- 1) **POWER** Key
Turns on/off the power supply.
- 2) **LIGHT** Key
Turns on/off the backlight of the LCD.

MEASURE Mode – Functions for Measurement

- 3) DC Voltage, AC Voltage, Resistance and Pulse Input Terminals
Serve as H (positive) and L (negative) input terminals when you measure DC voltage, AC voltage, resistance, and pulse signals.
- 4) DC Current Input Terminals
Serve as H (positive) and L (negative) input terminals when you measure a DC current signal. Also serve as L' terminals when you carry out 3-wire resistance measurement.
- 5) Three-wire Input Terminals
- 6) Function Selector Switch
Selects a measurement function and its range.
- 7) **RANGE DC/AC** Key
Used to further select from range options within the selected function.
 - If you have selected the 1 V, 10 V or 100 V range, use this key to toggle between the DC and AC options.
 - If you have selected the FREQ range, use this key to select the range of frequency measurement, as the key cycles through the 100 Hz, 1 kHz, 10 kHz, CPM and CPH options.
 - If you have selected the mA range, use this key to select from the 20 mA and 100 mA ranges.
 - If you have selected the 100 mV TC range, use this key to select the voltage range or the type of thermocouple, as the key cycles through the 100 mV, K, E, J, T, R, B, S, N, L and U options. (CA71 only)
 - If you have selected the Ω RTD range, use this key to select the resistance range or the type of RTD, as the key cycles through the 400 Ω , Pt100 and JPt100 options. (CA71 only)
If you have selected the TC or RTD range in the source mode of display, the TC or RTD type options on the SOURCE function side precede those on the MEASURE mode side.

- 8) **MEASURE OFF** Key
Turns on/off the MEASURE mode. Turning off the mode causes the measured value shown on the LCD to disappear.
If the MEASURE mode is not in use and therefore turned off, the power to the measurement circuit within the calibrator is also turned off.
This strategy saves on battery power if the calibrator is running on batteries.
- 9) **HOLD** Key
Holds the measured value being displayed.
Also used to start CPM or CPH measurement or communication.
- 10) **MEM** Key
Used to turn on/off the memory function.

SOURCE Mode – Functions for Generation

- 11) Output Terminals
These terminals are common to all of the source functions.
- 12) Function Selector Switch
Selects a source function and its range.
- 13) **RANGE** Key
Used to further select from range options within the selected function.
 - If you have selected the 100 mV TC range, use this key to select the voltage output or the type of thermocouple, as the key cycles through the 100 mV, K, E, J, T, R, B, S, N, L and U options.
 - If you have selected the 400 Ω RTD range, use this key to select the resistance range or the type of RTD, as the key cycles through the 400 Ω , Pt100 and JPt100 options.
 - If you have selected the PULSE range, use this key to select the frequency range, as the key cycles through the 500.0 Hz, 1000 Hz and 10 kHz options.
- 14) **SOURCE ON** Key
Turns on/off the source output.
- 15) **PULSE SET** Key
If you have selected the PULSE range, use this key to cycle through the frequency, amplitude and pulse count options for pulses being generated.

16) **TEMP** Key



Allows you to monitor temperature by selecting from the room temperature (°C), reference junction temperature (°C), thermocouple (mV) and RTD (Ω) options.



17) **n/m** Key

Turns on/off the divided output function (*n/m*).



18)  and  Output Setting Keys



Set the output value of a source function.

Each pair of  and  keys corresponds to each digit of the reading, thus increasing/decreasing the digit in units of 1s. Increasing the digit from 9 or decreasing it from 0 causes the digit to overflow or underflow, allowing you to set the output value without interruption.



Holding down the  or  key continuously changes the digit in question.

If your choice is the 4–20 mA function, see Section 4.2, “Sourcing DC Voltage, DC Current or SINK Current Signal,” for further details.

Note that  and  keys are also used in the following ways:

- The  and  keys labeled *n* and *m* serve as keys for setting the variables *n* and *m* when you have selected the divided output function (*n/m*).

(See Section 4.6, “Divided Output Function (*n/m*),” for further details.)

- The  and  keys labeled MEM NO., SAVE and READ serve as keys for working with the memory when you have selected the memory function.

(See Chapter 6, “Memory Function,” for further details.)

19) **CLEAR** Key

Initializes the output setpoint, causing the on-screen reading to revert to 0000 for functions other than PULSE and 20 mA SINK, though the number of digits depends on function selected.

This key serves as a key for clearing the memory when the memory function is selected.

■ Side and Rear Panels

20) FUSE

A holder for housing a fuse that protects the input during DC current measurement.

21) R.J.INPUT

A connector to which the external reference junction compensation sensor is connected.

22) AC Adapter Connection Jack

23) Battery Holder

Opening the cover reveals the battery holder and DIP switch.

24) I/O Port Cover

Open this cover to connect the RS232 communication cable (P/N: 91017). (CA71 only)

■ LCD Unit

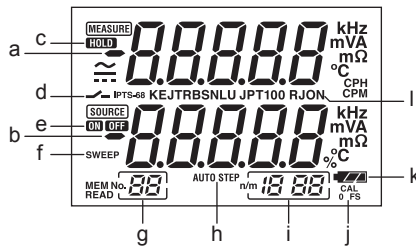

- a) Measured value
- b) Setpoint for source
- c) HOLD indicator
Indicates the on-screen measured value is in a hold state.
- d) Contact input
Indicates the contact input is selected when your choice is pulse measurement.
- e) ON/OFF indicators for output
ON: Indicates the output is on.
OFF: Indicates the output is off.
- f) SWEEP indicator for sweep function
Comes on when the sweep function is selected using the DIP switch.

2. Names and Functions of Parts

- g) MEM NO. indicator
Shows a memory number when the memory function is selected.
- h) AUTO STEP indicator
Comes on when the auto step function is selected.
- i) Divided output function (n/m) indicator
Comes on when the divided output function (n/m) is selected.
The most significant two digits "18" denote the value of n ,
while the least significant two digits "88" mean the value of m .
- j) CAL mode selection indicator
The 0 and FS indicators below this indicator denote zero point and
full scale adjustments, respectively.
- k) Battery replacement indicator
(Remaining battery power indicator)
Shows the battery level in three steps according to the level of
remaining electricity.
- l) RJON indicator
Indicates reference junction compensation is active when
thermoelectromotive force is being sourced.
The thermoelectromotive force output when this indicator is off
represents the 0°C-based output.

3. Before Starting Source/Measurement

■ Operating Precautions

Precautions for Safe Use of the Instrument

- When using the instrument for the first time, be sure to read the instructions given on pages vi to ix of the section, "Precautions for Safe Use of the Instrument."
- Do not open the instrument's case.
Opening the case is extremely hazardous, as the instrument contains high-voltage parts. Contact the vendor from which you purchased the instrument, for a service of inspecting or adjusting the internal assembly.
- In case of failure
Should the instrument begin to emit smoke, give off an unusual odor, or show any other anomaly, immediately turn off the POWER key. If you are using an AC adapter, disconnect the plug from the wall outlet. Also cut off power to the object under test that is connected to the input terminals. Then, contact the vendor from which you purchased the instrument.

General Handling Precautions

- Before carrying around the instrument turn off power to the object under test, and then the POWER key of the instrument.
If you are using an AC adapter, disconnect the power cord from the wall outlet. Finally, detach all lead cables from the instrument.
Use a dedicated carry case when transporting the instrument.
- Do not bring any electrified object close to the input terminals, since the internal circuit may be destroyed.
- Do not apply any volatile chemical to the instrument's case or operation panel. Do not leave the instrument in contact with any product made of rubber or vinyl for a prolonged period.
Be careful not to let a soldering iron or any other heat-emitting object come into contact with the operation panel, as the panel is made of thermoplastic resin.
- Before cleaning the instrument's case or operation panel disconnect the power cord plug from the wall outlet if you are using an AC adapter. Use a soft, clean cloth soaked in water and tightly squeezed to gently wipe the outer surfaces of the instrument.
Ingress of water into the instrument can result in malfunction.

3. Before Starting Source/Measurement

- If you are using an AC adapter with the instrument and will not use the instrument for a prolonged period, disconnect the power cord plug from the wall outlet.
- For handling precautions regarding the batteries, see “Installing or Replacing the Batteries” on page 3-3.
- Never use the instrument with the cover of the battery holder opened.

Operating Environment and Conditions

This instrument complies with the EMC standard under specific operating environment and operating conditions.

If the installation, wiring, and so on are not appropriate, the compliance conditions of the EMC standard may not be met.

In such cases, the user will be required to take appropriate measures.

■ Environmental Requirements

Use the instrument in locations that meet the following environmental requirements:

- Ambient temperature and humidity
 - Ambient temperature range: 0 to 50°C
 - Ambient humidity range: 20 to 80% RH.

Use the instrument under non-condensing condition.

- Flat and level locations
- Indoors
- Operating altitude: 2000 m or less

Do not use the instrument in locations that are:

- Outdoors
- exposed to direct sunlight or close to any heat source;
- exposed to water or other liquids;
- exposed to frequent mechanical vibration;
- close to any noise source, such as high-voltage equipment or motive power sources;
- close to any source of intensive electric or electromagnetic fields;
- exposed to large amounts of greasy fumes, hot steam, dust or corrosive gases;
- unstable; or
- exposed to a risk of explosion due to the presence of flammable gases.

**NOTE**

- Use the instrument under the following environmental conditions if precise source or measurement is your requirement:
Ambient temperature range: $23\pm 5^{\circ}\text{C}$; ambient humidity range: 20 to 80% RH (non-condensing)
When using the instrument within a temperature range of 0 to 18°C or 28 to 50°C , add a value based on the temperature coefficient shown in Chapter 12, "Specifications (page 12-1)," to the given accuracy rating.
- When using the instrument at an ambient humidity of 30% or lower, prevent electrostatic charges from being produced, by using an antistatic mat or any other alternative means.
- Condensation may occur if you relocate the instrument from places with low temperature and humidity to places with high temperature and humidity, or if the instrument experiences any sudden temperature change.
In that case, leave the instrument under the given ambient temperature for at least one hour to ensure that the instrument is free from condensation, before using the instrument.

■ Installing or Replacing the Batteries**WARNING**

To avoid electrical shock, always remove the source or measurement lead cables from the object under test, as well as from the instrument itself.

**CAUTION**

- To avoid the risk of fluid leakage or battery explosion, install batteries with their positive and negative electrodes correctly positioned.
- Do not short-circuit the batteries.
- Do not disassemble or heat the batteries or throw them into fire.
- When replacing batteries, replace all of the four batteries at the same time with new ones from the same manufacturer.
- If the instrument will not be used for a prolonged period, remove the batteries from the instrument.

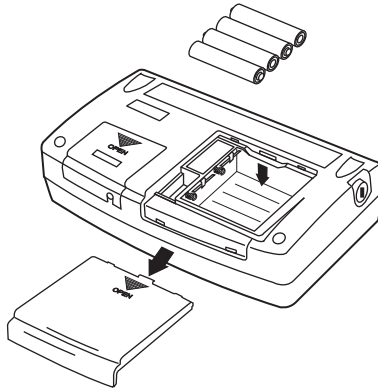

3. Before Starting Source/Measurement

- Step 1:** Remove the lead cables and AC adapter and turn off the calibrator before you begin installing batteries.
- Step 2:** Remove the battery holder cover by sliding it in the direction indicated by → **OPEN**.
- Step 3:** Install four AA-size (LR6) alkaline batteries in the battery holder with their positive and negative electrodes positioned correctly as indicated on the holder.
- Step 4:** After replacement, reattach the battery holder cover tightly.



Indication of Battery Level (Remaining Battery Power Indicator)

The battery replacement indicator shows the battery level in three steps according to the measured voltage of the batteries.

-  (Lit constantly): The battery level is normal.
-  (Lit constantly): The battery level is below 50% full, but still allows for normal operation.
-  (flashing): replace the batteries.

Note that the battery replacement (remaining battery power) indicator is driven by directly measuring the battery voltage when the calibrator is in actual operation. Consequently, the indicator may read differently depending on the battery load condition (e.g., the load condition of the source output or on/off state of the measurement function) if the batteries are too low. If the remaining power starts to run low, replace the batteries as soon as possible.

If the calibrator will be used under a wide variety of conditions, it is advisable that the battery replacement indicator be verified under heavy loads (MEASURE mode is on and the SOURCE mode is set to the 20 mA/10 V output).

■ Connecting the AC Adapter

WARNING

- Make sure that the rated power supply voltage of the instrument matches the voltage of the power supply before turning on the power.
- To prevent the possibility electrical shock or fire, be sure to use the AC adapter and the power cord supplied by YOKOGAWA. Additionally, do not use the AC adapter and the power cord supplied with this instrument with another instrument.
- Do not place anything on the AC adapter or power cord, and prevent heat sources from coming into contact with them.
- When unplugging the power cord from the outlet, be sure to hold the plug and never pull the actual cord.
- Do not throw (dispose of) the AC adapter in fire or apply heat to it.
- Do not use it, where the cord is bundled (bent).
- If the power cord is damaged, contact your dealer.

Step 1: Make sure the calibrator is turned off.

Step 2: Insert the plug of the optional AC adapter into the AC adapter connection jack.

■ Turning On/Off the Power

CAUTION

To verify the instrument's functionality, check that the measured value is updated after turning on the power. If the measured value is not updated, the reading will be incorrect and may lead to possible electrical shock or personal injury.

Turning On/Off the POWER Switch

Pressing the  key once when the power is off turns on the calibrator.

Pressing the  key once again turns off the calibrator.

NOTE

- Before disconnecting the AC adapter from an AC power source, turn off the calibrator by pressing the  key.
 - When operating the calibrator on batteries, disconnect the AC adapter plug from the instrument.
Once you connect the AC adapter plug to the instrument, the instrument no longer operates on batteries.
Thus, the instrument will not turn on unless the AC adapter is connected to an AC power source.
 - Be sure to turn off the POWER switch when you finish using the instrument.
-
-

Turning On/Off MEASURE Mode

Pressing the MEASURE  key after power-on turns off the MEASURE mode.

- If the MEASURE mode is not needed and therefore turned off, power to the measurement circuit is also turned off within the calibrator.
Thus, you can save on battery power if the calibrator is running on batteries.
- Turning off the MEASURE mode causes the on-screen measured value to disappear.
- To resume measurement when the MEASURE mode is off, press the MEASURE  key once again.

TIP

One to two seconds are taken for the LCD to turn on after the MEASURE mode is turned on.

■ Turning On/Off the Backlight

The LCD can be back-lit. Pressing the  key turns on the backlight, while pressing the key once again turns it off.

This feature makes it easier for you to view the LCD when operating the calibrator in dark places or when carrying out source or measurement.

Note that battery life shortens when the calibrator is operated on batteries.



NOTE

The backlight automatically turns off approximately one minute later.
To turn on the backlight again, press the  key once again.

■ Operating Environment

Operating Environment

Ambient Temperature and Humidity

Use the CA51/71 in the following environment:

- Ambient temperature: 0 to 50°C
- Ambient humidity: 20 to 80 % RH (no condensation)
- Location: indoors
- Operating altitude: 2000 m max. above sea level.

■ Measurement Category

Measurement Category of Main unit

WARNING

The instrument is designed for measurement category III.

Do not use the CA51 or CA71 for measurements in location that fall under Measurement Category IV.

| Measurement Category | Description | Remarks |
|----------------------|---|---|
| O (None, Other) | Other circuits that are not directly connected to MEAINS. | Circuits not connected to a mains power source. |
| CAT II | For measurement performed on circuits directly connected to a low-voltage installation. | Appliances, portable equipment, etc. |
| CAT III | For measurement performed in a building installation. | Distribution board, circuit breaker, etc. |
| CAT IV | For measurement performed at the source of a low-voltage installation. | Overhead wire, cable systems, etc. |

Category of Lead cables (RD031)

WARNING

When you use the lead cables, attach or remove the caps according to the measurement category.

With caps: 1000V 10A CAT III / 600V 10A CAT IV

With no caps: 1000V 10A CAT II

Pollution Degree

The pollution degree of the CA51 or CA71 in the operating environment is 2.

Pollution Degree applies to the degree of adhesion of a solid, liquid, or gas which deteriorates withstand voltage or surface resistivity.

Pollution Degree 2 applies to normal indoor atmospheres.

Normally, only non-conductive pollution is emitted.

However, a temporary electrical conduction may occur depending on the concentration.

4. Source

From the calibrator, you can source a DC voltage, DC current, SINK current, resistance, thermocouple, RTD, frequency or pulse signal.

WARNING

- To avoid electrical shock, do not apply any voltage above 30 V to the output terminals.
Always use the calibrator in locations with a voltage to ground below 30 V.

CAUTION

- Do not apply any voltage to the output terminals for ranges other than 20 mA SINK. Otherwise, the internal circuitry may be damaged.
- The instrument has been calibrated without taking into account a voltage drop due to the resistance component of the lead cables for source. Care must be taken therefore when drawing a load current since the voltage drop due to the resistance component (approximately 0.1 Ω on a round-trip basis) of the lead cables serves as an error.

4.1 Connecting Cables to Terminals

CAUTION

Tighten the output terminal knob by hand.

Do not use a tool or the like. Tightening the knob using a tool or the like may damage the terminal, resulting in the disability of normal generation.

Before storing the instrument in the carrying case, tighten the output terminal knob. If the instrument is stored in the carrying case while the output terminal knob is not tightened completely and is protruding, an external force may be applied to the terminal, thus causing damage to the terminal and resulting in the disability of generation.

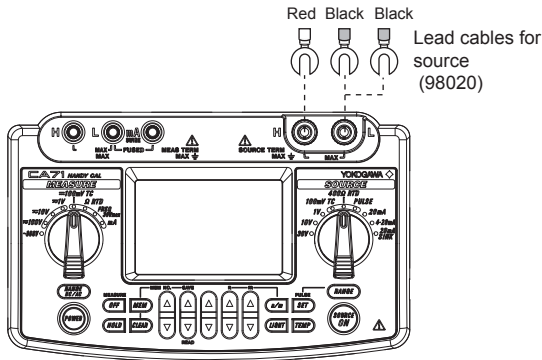

For DC voltage, DC current, thermocouple or pulse output

Step 1: Connect the red lead cable for source (P/N: 98020) to the H output terminal and the black lead cable to the L output terminal.

Step 2: Connect the two clips of the cables to the input of equipment under test while making sure the polarities are correct.















For 3-wire connection resistance or RTD signal

Step 1: Connect the red lead cable for source (P/N: 98020) to the H output terminal, and both black lead cables to the L output terminal. (The two black lead cables should be fastened together to the L output terminals.)

Step 2: Connect the three leading clips of the cables to the input of equipment under test while making sure the polarities are correct.

4.2 Sourcing DC Voltage, DC Current or SINK Current Signal

4.2.1 Sourcing DC Voltage or DC Current Signal

- Step 1:** Using the Function selector switch, select the desired source function from **100mV TC**, **1V**, **10V**, **30V** and **20mA**.
- Step 2:** The LCD shows the default value and unit of the source function.
- Step 3:** Set the output value digit by digit using each pair of  and  output setting keys. Each pair of  and  keys corresponds to each digit of the LCD reading. Each press of the  and  key increases or decreases the digit. Increasing the digit from 9 or decreasing it from 0 causes the digit to overflow or underflow, allowing you to set the output value without interruption. Holding down the  or  key continuously changes the digit in question. Pressing the  key initializes the output setpoint to the default value (0).
- Step 4:** Pressing the  key causes the  indicator on the LCD to change from  to . The calibrator sources the preset DC voltage or current signal between the output terminals.
- Step 5:** To turn off the output, press the  key once again. The  appears on the LCD and the output terminals are open-circuited.

TIP



If either of the following cases applies, the protection circuit works to turn off the output.



- The output terminals or the lead cables for source connected to the output terminals are short-circuited or an excessive load current has flowed through the cables when a voltage is being output.
 - The output terminals or the lead cables for source connected to the output terminals are open-circuited or an excessive load voltage has been sourced between the output terminals when a current is being output.
-

4.2.2 4-20 mA Function



You can set a 4-20 mA signal in 4 mA increments.

Step 1: Using the function selector switch, select **4-20mA** .

Step 2: Using each pair of  and  output setting keys, which correspond to each digit of a value from 4 to 20, set the signal in a step-by-step manner. You can set the signal in 4 mA increments or decrements in the order 4 ↔ 8 ↔ 12 ↔ 16 ↔ 18 ↔ 20 mA.

Use the pairs of  and  keys for the decimals to make fine adjustments, as the keys let you set the decimals in normal resolution.

Pressing the  key initializes the signal setpoint to the default value (4.00).

Step 3: Pressing the  key causes the  indicator on the LCD to change from **OFF** to **ON**. The calibrator sources the preset 4-20 mA current signal between the output terminals.

Step 4: To turn off the output, press the  key once again. The **OFF** appears on the LCD and the output terminals are open-circuited.

TIP

If the signal setpoint is 3 mA or less, no step-by-step setting is possible even if you operate the higher-order output setting keys.

4.2.3 20 mA SINK Function

The 20 mA SINK function can draw a preset amount of current from an external voltage source to the H terminal.



Thus, you can use the calibrator in a loop test, for example, as a simulator for two-wire transmitters.

In that case, use this function within the 5 to 28 V range of applied voltages. The minimum value of the range for the 20 mA SINK function is 0.1 mA.

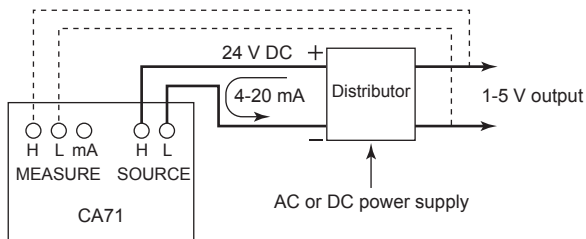
You can test the I/O signals of a distributor by wiring the calibrator as indicated by the dashed lines in the following figure.



Drawing SINK Current

- Step 1:** Before connecting to the terminals, select $\frac{20\text{mA}}{\text{SINK}}$ with the source range setting rotary switch.
- Step 2:** Connect the positive terminal of an external power source to the H output terminal and the negative terminal to the L output terminal.
- Step 3:** Turn on the external power source and press the  key. The  indicator on the LCD changes from **OFF** to **ON**. The calibrator sources the preset current value of the 20 mA SINK function between the output terminals.
- Step 4:** To turn off the output, press the  key once again. The **OFF** appears on the LCD and the output terminals are open-circuited.

4.2.4 Using As 24-V Loop Power Supply

A maximum load current of 22 mA can be drawn from the calibrator by selecting the 30 V range and setting the sourced voltage to 24 V. With this function, you can use the calibrator as a loop power supply in place of the distributor in a two-wire loop, as shown in the following figure. Thus, you can measure a 4-20 mA current signal. Using the supplied terminal adapter (P/N: 99021) makes it easy to wire the calibrator for this application.

 **NOTE**

Since the function discussed above requires a significant amount of DC current (22 mA), operation on batteries will reduce the battery life considerably. To avoid this problem, operate the calibrator on the AC adapter. In this application, no source output other than 24 V can be taken at the same time.

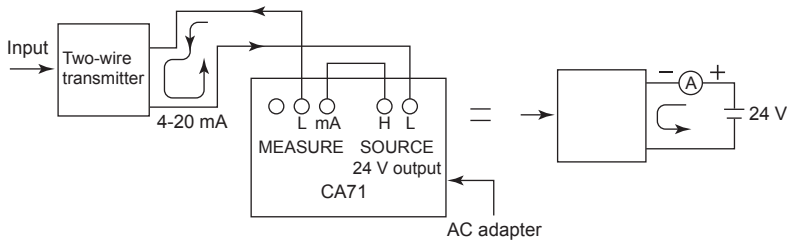

Using As a Loop Power Supply

4.3 Sourcing Resistance or RTD Signal

- The calibrator sources a resistance signal by 1) receiving the resistance-measuring current I supplied from the device being calibrated, such as a resistance meter or RTD thermometer, and 2) delivering the voltage $V = R \times I$ proportional to the preset resistance R between the output terminals, and 3) thus producing the equivalent resistance $R = V/I$. Consequently, the calibrator sources the signal correctly only for such devices that employ this method of measurement.
- The allowable range of the resistance measuring current I that the calibrator receives from a resistance measuring device under calibration is rated as 0.1 to 5 mA. Note, however, that accuracy lowers for resistance measuring currents smaller than 0.5 mA. For further details, see Chapter 12, “Specifications.”
- Any resistance signal being sourced does not include the resistance component of the lead cables for source.
The calibrator is adjusted so that the signal has a resistance value as viewed from the output terminals.
The whole resistance, when measured at the ends of the lead cables for source, is given by adding the resistance of the lead cables themselves (approximately 0.1Ω on a round-trip basis) to the sourced resistance signal.
For source of precise resistance signals, use three-wire connection.
- If capacitance between the terminals of a device under calibration is greater than $0.1 \mu\text{F}$, the calibrator may fail to source correct resistance signals.

■ Output Method Based on Three-wire Connection

Attach another lead cable to the L output terminal, as shown in the following figure. The output is provided through the three wires, H, L and L'. Connect these three wires to the device being calibrated.

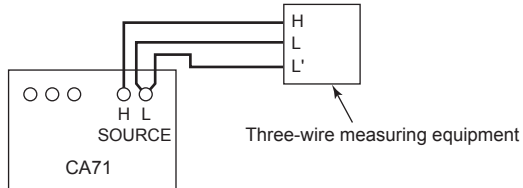

Three-wire Connection for Resistance Signal Source

- Step 1:** Using the function selector switch, select **400Ω RTD**.
- Step 2:** Using the **RANGE** key, select the range. Pressing the **RANGE** key cycles through the 400 Ω, PT100 and JPT100 options.
- Step 3:** Set the output value digit by digit using each pair of **▲** and **▼** keys. Each press of the **▲** or **▼** key increases or decreases the digit. Increasing the digit from 9 or decreasing it from 0 causes the digit to overflow or underflow, allowing you to set the output value without interruption. Holding down the **▲** or **▼** key continuously changes the digit in question. Pressing the **CLEAR** key initializes the output setpoint to the default value (0).
- Step 4:** Pressing the **SOURCE ON** key causes the **SOURCE** indicator on the LCD to change from **OFF** to **ON**. The calibrator sources the preset resistance value between the output terminals.
- Step 5:** To turn off the output, press the **SOURCE ON** key once again. The **OFF** appears on the LCD and the output terminals are open-circuited.

4.4 Sourcing Thermocouple (TC) Signals













4.4.1 When RJ Sensor Is Used (Making Use of Reference Junction Compensation)

To calibrate a device with built-in reference junction temperature compensation by sourcing a thermoelectromotive force with the calibrator without using any external 0°C reference junction compensation means, use the optional RJ sensor (P/N: B9108WA).

CAUTION

When sourcing thermocouple signals, the CA71 outputs a small DC voltage. If the device under calibration has a switching power supply, its switching noise may affect the CA71 output. Taking measures such as connecting the device to ground can reduce its noise, resulting in less effect on the CA71. (This caution also applies to the CA51.)

- Step 1:** Insert the RJ sensor into the R.J.INPUT connector of the calibrator.
Insert the sensor until the locking claw in the bottom of the sensor connector locks with a click.
To unplug the sensor connector, unlock the connector by gently pushing the locking claw.
- Step 2:** Using the function selector switch, select **100mV TC**.
- Step 3:** Using the **RANGE** key, select the type of thermocouple. Select the type from K, J, E, T, R, B, S, N, L and U. The selected type of thermocouple is shown on the LCD.
- Step 4:** When the RJ sensor is connected, the calibrator goes into the RJ ON status and the **RJON** symbol appears on the LCD.

- Step 5:** Set the output value digit by digit using each pair of  and  output setting keys. Each pair of  and  keys corresponds to each digit of the LCD reading. Each press of the  or  key increases or decreases the digit. Increasing the digit from 9 or decreasing it from 0 causes the digit to overflow or underflow, allowing you to set the output value without interruption. Holding down the  or  key continuously changes the digit in question. Pressing the  key initializes the output setpoint to the default value (600°C for a type-B thermocouple).
- Step 6:** Pressing the  key causes the  indicator on the LCD to change from **OFF** to **ON**. A thermoelectromotive force based on the temperature detected by the RJ sensor develops between the output terminals.
- Step 7:** To turn off the output, press the  key once again. The **OFF** appears on the LCD and the output terminals are open-circuited.



NOTE

- When you have attached the RJ sensor to the device being calibrated, wait until the detected temperature stabilizes before you begin using the calibrator.
 - If no reference junction compensation is required, be sure to remove the RJ sensor from the calibrator.
-

TIP

The calibrator has a built-in RJ sensor (INT RJ) that compensates for the measured reference junction temperature.

You can generate thermoelectromotive force that is based on the measured temperature from the calibrator's output terminal and roughly check the measurement (reading) on the thermometer under verification.

Because the thermoelectromotive force generated using this method does not match that generated using an external RJ sensor,* the accuracy of this measurement is not guaranteed.

For further details on how to use the temperature sensor, see Section 7.3, "Selecting the INT RJ Function."

* The terminal temperature of the thermometer under verification is measured using an external RJ sensor, and this temperature is used as the reference junction temperature.

4.4.2 When No RJ Sensor Is Used

From the output terminals, the calibrator sources a thermoelectromotive force corresponding to the preset temperature of a selected thermocouple.

The thermoelectromotive force is sourced with reference to 0°C.

- Step 1:** Using the function selector switch, select **100mV TC**.
- Step 2:** Using the **RANGE** key, select the type of thermocouple. Select the type from K, J, E, T, R, B, S, N, L and U. The selected type of thermocouple is shown on the LCD.
- Step 3:** Set the output value digit by digit using each pair of **▲** and **▼** output setting keys. Each pair of **▲** and **▼** keys corresponds to each digit of the LCD reading. Each press of the **▲** or **▼** key increases or decreases the digit. Increasing the digit from 9 or decreasing it from 0 causes the digit to overflow or underflow, allowing you to set the output value without interruption. Holding down the **▲** or **▼** key continuously changes the digit in question. Pressing the **CLEAR** key initializes the output setpoint to the default value (600°C for a type-B thermocouple).
- Step 4:** Pressing the **SOURCE ON** key causes the **SOURCE** indicator on the LCD to change from **OFF** to **ON**. A thermoelectromotive force (mV) equivalent to the preset temperature develops between the output terminals.
- Step 5:** To turn off the output, press the **SOURCE ON** key once again. The **OFF** appears on the LCD and the output terminals are open-circuited.





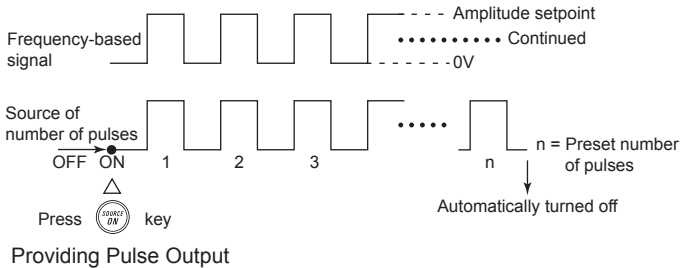









4.5 Sourcing Pulse Signals

You can source a preset type of continuous pulse train, a pulse signal with a preset frequency, or the preset number of pulses.





4.5.1 Sourcing a Continuous Pulse Train

- Step 1:** Using the function selector switch, select **PULSE**.
The LCD shows the default frequency 10 Hz .
- Step 2:** Using the **RANGE** key, set the frequency range.
Pressing of the **RANGE** key cycles through the 500.0 Hz, 1000 Hz and 10 kHz options.
- Step 3:** Set the output value digit by digit using each pair of Δ and ∇ output setting keys.
Each pair of Δ and ∇ keys corresponds to each digit of the LCD reading.
Each press of the Δ or ∇ key increases or decreases the digit.
Increasing the digit from 9 or decreasing it from 0 causes the digit to overflow or underflow, allowing you to set the output value without interruption.
Holding down the Δ or ∇ key continuously changes the digit in question.
Pressing the **CLEAR** key initializes the output setpoint to the default value (differs depending on the frequency range).
- Step 4:** Pressing the **PULSE SET** key once switches to amplitude setting mode.
The LCD provides a reading of 10 V .

- Step 5:** Set the output value digit by digit using each pair of  and  output setting keys. Each pair of  and  keys corresponds to each digit of the LCD reading. Each press of the  or  key increases or decreases the digit. Increasing the digit from 9 or decreasing it from 0 causes the digit to overflow or underflow, allowing you to set the output value without interruption. Holding down the  or  key continuously changes the digit in question. Pressing the  key initializes the output setpoint to the default value (0.1 V).
- Step 6:** Press the  key once again to show *cont* on the LCD. Then, press the  key one more time to revert to frequency setting mode.
- Step 7:** Pressing the  key causes the  indicator on the LCD to change from **OFF** to **ON**. The calibrator sources a continuous pulse train with the preset frequency and amplitude between the output terminals.
- Step 8:** To turn off the output, press the  key once again. The **OFF** symbol appears on the LCD and the output terminals are open-circuited.

TIP

To change the frequency range, place the calibrator in frequency setting mode with the  key. Then, change the frequency range using the  key.

4.5.2 Sourcing the Preset Number of Pulses (Pulse Cycle)

- Step 1:** Using the function selector switch, select **PULSE**.
The LCD shows the default frequency $\square\square\text{Hz}$.
- Step 2:** Using the **RANGE** key, set the frequency range.
Each press of the **RANGE** key cycles through the 500.0 Hz, 1000 Hz and 10 kHz options.
- Step 3:** Set the output value digit by digit using each pair of **▲** and **▼** output setting keys.
Each pair of **▲** and **▼** keys corresponds to each digit of the LCD reading.
Each press of the **▲** or **▼** key increases or decreases the digit.
Increasing the digit from 9 or decreasing it from 0 causes the digit to overflow or underflow, allowing you to set the output value without interruption.
Holding down the **▲** or **▼** key continuously changes the digit in question.
Pressing the **CLEAR** key initializes the output setpoint to the default value (differs depending on the frequency range).
- Step 4:** Pressing the **PULSE SET** key once switches to amplitude setting mode.
The LCD provides a reading of $\square\square\text{V}$.
- Step 5:** Set the output value digit by digit using each pair of **▲** and **▼** output setting keys.
Each pair of **▲** and **▼** keys corresponds to each digit of the LCD reading.
Each press of the **▲** or **▼** key increases or decreases the digit.
Increasing the digit from 9 or decreasing it from 0 causes the digit to overflow or underflow, allowing you to set the output value without interruption.
Holding down the **▲** or **▼** key continuously changes the digit in question.
Pressing the **CLEAR** key initializes the output setpoint to the default value (0.1 V).

- Step 6:** Press the **PULSE SET** key once again to show *count* on the LCD. Then, press the **▲** key. The source setpoint reading of the LCD changes to a numeric value, which represents the number of pulses.
- Step 7:** Set the number of pulses value digit by digit using each pair of **▲** and **▼** output setting keys. Each press of the **▲** or **▼** key increases or decreases the digit. Increasing the digit from 9 or decreasing it from 0 causes the digit to overflow or underflow, allowing you to set the output value without interruption. Holding down the **▲** or **▼** key continuously changes the digit in question. Pressing the **CLEAR** key initializes the output setpoint to the default (*count*), thus reverting to the mode of sourcing continuous pulse trains.
- Step 8:** Pressing the **SOURCE ON** key causes the **SOURCE** indicator on the LCD to change from **OFF** to **ON**. The calibrator sources the preset number of pulses with the preset frequency and amplitude between the output terminals.
- Step 9:** When source is complete, the calibrator automatically turns off the output and ceases operation. The **OFF** appears on the LCD and the output terminals are open-circuited.

TIP

To stop sourcing pulses halfway, press the **SOURCE ON** key when pulse output is in progress. The **OFF** appears on the LCD and the output terminals are open-circuited.

4.5.3 Using the Contact Output

You can turn on or off the output terminals.

This setting is possible for both the mode of sourcing a continuous pulse train and the mode of sourcing a given number of pulses.

An FET is used as the contact switching device.

Since the way of using the contact output is the same for both the source of continuous pulse trains and the source of a number of pulses, this subsection only refers to the procedure for continuous pulse trains.

- Step 1:** Using the function selector switch, select **PULSE**.
The LCD shows the default frequency 1.0Hz .
- Step 2:** Using the **RANGE** key, set the frequency range.
Each press of the **RANGE** key cycles through the 500.0 Hz, 1000 Hz and 10 kHz options.
- Step 3:** Set the output value digit by digit using each pair of **▲** and **▼** output setting keys.
Each pair of **▲** and **▼** keys corresponds to each digit of the LCD reading.
Each press of the **▲** or **▼** key increases or decreases the digit.
Increasing the digit from 9 or decreasing it from 0 causes the digit to overflow or underflow, allowing you to set the output value without interruption.
Holding down the **▲** or **▼** key continuously changes the digit in question.
Pressing the **CLEAR** key initializes the output setpoint to the default value (differs depending on the frequency range).
- Step 4:** Pressing the **PULSE SET** key once switches to amplitude setting mode.
The LCD provides a reading of 0.0V .
- Step 5:** Changing the reading of 0.0V to 0.00V with the **▼** key causes the calibrator to enter contact output mode.
- Step 6:** Press the **PULSE SET** key once again to show **CONT** on the LCD.
Then, press the **PULSE SET** key one more time to revert to frequency setting mode.

Step 7: Pressing the  key causes the **SOURCE** indicator on the LCD to change from **OFF** to **ON**.
The output terminals turn on and off at the preset frequency.

Step 8: To turn off the output, press the  key once again.
The **OFF** appears on the LCD and the output terminals are open-circuited.



NOTE

- The contact has polarities. Always connect the positive side to the H output terminal of the calibrator and the negative side to the L output terminal.
 - Exercise the utmost care not to allow the contact current to exceed 50 mA.
-
-

4.6 Divided Output Function (n/m)

The divided output function (n/m) outputs a value n/m times the setpoint of a voltage, current, resistance, thermocouple or RTD signal.

Thus, the output value is defined as:



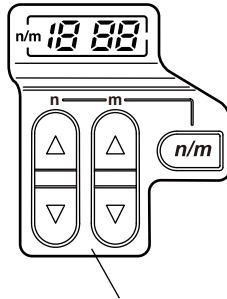

Output value = Main setpoint \times (n/m)



Keys and labels related to divided output function (n/m)

For details on how to set the sourced signal level of each range, see Sections 4.2, “Sourcing DC Voltage, DC Current or SINK Current Signal, to 4.4, “Sourcing Thermocouple (TC) Signal.” Follow the steps shown below with the calibrator output turned off.

- Step 1:** When the setting of the sourced signal level of each range is complete, follow step 2 and later steps.
- Step 2:** Using each pair of Δ or ∇ keys, set the main setpoint.
- Step 3:** Press the $\boxed{n/m}$ key to enter the divided output (n/m) mode. The LCD shows $n/m \quad ! ! !$. The higher-order two digits represents the value of n and the lower-order two digits the value of m .
- Step 4:** Using a pair of Δ or ∇ keys, set the value of m . The variable m can be set to a value from 1 to 19.
- Step 5:** Using a pair of Δ or ∇ keys, change the value of n . An output value n/m times the main setpoint can be obtained according to the setpoint of n . The variable n can be set to a value from 0 to m .

- Step 6:** Pressing the  key causes the  indicator on the LCD to change from **OFF** to **ON**.
The calibrator sources a (main setpoint) × (*n/m*) signal between the output terminals for each range selected.
- Step 7:** To turn off the output, press the  key once again. The **OFF** appears on the LCD and the output terminals are open-circuited.
- Step 8:** Pressing the  key one more time cancels the divided output (*n/m*) mode.

TIP

To change the main setpoint, temporarily cancel the divided output (*n/m*) mode.

Set the main setpoint once again.

Then, place the calibrator in the divided output (*n/m*) mode once again.

4.7 Sweep Function

The sweep function varies the output in a linear manner.

For further details, see Section 7.1, “Sweep Function.”

4.8 Auto Step Function

The auto step function varies the output in a step-by-step manner.

For further details, see Section 7.2, “Auto Step Function.”

4.9 Temperature Monitor Function

Using the **TEMP** key, you can show the monitored temperature on the LCD, as described below.

■ When the Voltage, Current, Resistance or Pulse (Continuous Pulse Train or Number of Pulses) Range Is Selected

The reading of a sourced signal remains changed to the temperature detected by the built-in temperature sensor of the calibrator as long as the **TEMP** key is kept held down.

Thus, you can monitor the room's temperature.

■ When the Temperature (Thermocouple or RTD) Range Is Selected

- Pressing the **TEMP** key once allows you to monitor the electromotive force (mV) or resistance (Ω) equivalent to the preset temperature. The monitored value does not reflect the correction made by the RJ sensor.
- Pressing the **TEMP** key once again changes to the temperature detected by the RJ sensor connected to the calibrator or the internal temperature of the calibrator.
- Pressing the **TEMP** key one more time reverts to the initial normal setting mode.

TIP

- In approximately 10 seconds, the temperature monitor function automatically returns to the initial normal setting mode.
- The reading of internal temperature may become higher than the room's temperature because of a temperature rise within the calibrator. With an external RJ sensor, it is possible to measure the room's temperature more precisely.
- For a reading of monitored temperature, the unit symbol (mV, Ω or $^{\circ}\text{C}$) blinks. Thus, you can discriminate between a setpoint and a monitored value.

5. Measurement

WARNING

- In an application where the calibrator is used together with the supplied lead cables for measurement, the maximum allowable voltage from the input terminals to ground is 300 V.
To avoid electrical shock, do NOT use the calibrator at any voltage exceeding this maximum.
The maximum allowable terminal voltage is 300 V AC max.
- The allowable voltage to ground when the supplied terminal adapter is attached to the input terminals is 30 V_{peak} maximum.
To avoid electrical shock, do not use the terminal adapter for measuring any circuit voltage exceeding the maximum voltage to ground.

TIP

- With the **HOLD** key, you can hold the measured value.
- When no measurement needs to be made, turn off the MEASURE mode by pressing the **MEASURE OFF** key.
The measured value shown on the LCD disappears and power to the internal measuring circuit is cut off.
This strategy saves on battery power.
- The reading of a measured value is updated at approximately one-second intervals.
If the input is overranged, the measured value on the LCD reads as - - - - -.

5.1 Connecting Cables to Terminals

■ For DC voltage, AC voltage, resistance, frequency or pulse signal

Step 1: Connect the red lead cable for measurement (P/N: RD031) to the H input terminal and the black lead cable to the L input terminal.

Step 2: Connect the two clips of the cables to the measuring terminals of equipment under test while making sure the polarities are correct.

■ For DC current signal

Step 1: Connect the red lead cable for measurement (P/N: RD031) to the mA input terminal and the black lead cable to the L input terminal.

Step 2: Connect the two clips of the cables to the measuring terminals of equipment under test while making sure the polarities are correct.

■ For thermocouple signal (CA71 only)

Step 1: Connect the terminal adapter (P/N: 99021) to the input terminals. This will help you connect the cables easily.

Step 2: Connect between TC RTD terminals.
The positive output leadwire of the thermocouple to the H terminal of the terminal adapter and the negative output leadwire to the L terminal.

■ For RTD signal (CA71 only)

Step 1: When using the terminal adapter (P/N: 99021), connect the H, L and L terminals of the terminal adapter to the H, L and mA terminals of the three-wire input terminal block of the calibrator, respectively.

Step 2: Connect the A, B and B output leadwires of the RTD to the H, L and L terminals of the terminal adapter, respectively.

 **CAUTION**

- Before connecting the calibrator to the device under test, cut off the power to the device.
- Do not apply any voltage or current exceeding the allowable voltage (300 V) or current (120 mA).
Otherwise, there will be a danger of not only damage to the instrument but also personal injury due to electrical shock.
- Mistaking the H voltage input terminal for the mA current input terminal, and vice versa, when wiring is extremely dangerous.
NEVER make this mistake.
- The current input terminals are equipped with a built-in current input protection fuse.
Overcurrent input to the terminals will cause the fuse to blow.
If the fuse is blown, replace it with one (P/N: A1635EF) with the specified ratings.
For details on fuse replacement, see subsection 5.2.3, "Measuring DC Current."
- When using the terminal adapter (model: 99021), tighten the knob by hand.
Do not use a tool or the like.
Tightening the knob using a tool or the like may damage the terminal, resulting in the disability of measurement.
Before storing the instrument in the carrying case, remove the terminal adapter (model: 99021).
If the instrument is stored in the carrying case while the adapter is attached, an external force may be applied to the terminal, thus causing damage to the terminal and resulting in the disability of measurement.

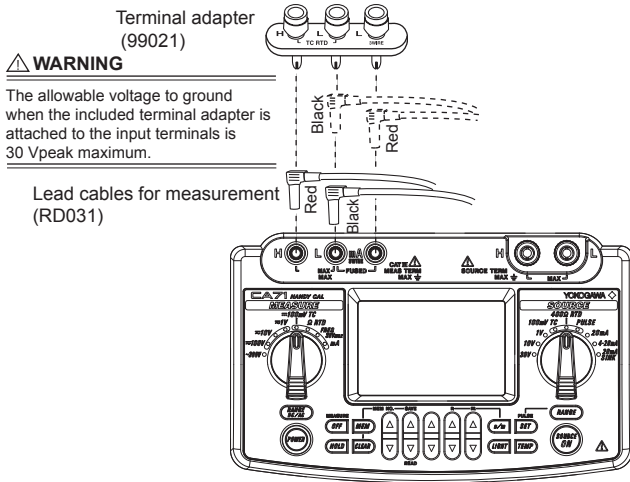

5.2 Measuring 300 V AC-range Voltage, DC Voltage, AC Voltage or DC Current

5.2.1 Measuring 300 V AC-range Voltage

CAUTION

If you make a mistake in wiring or in the operating procedure in this measurement task, there will be a danger of not only damage to the instrument but also personal injury due to electrical shock. Exercise the utmost care when carrying out the measurement task.

- Step 1:** Make sure the lead cables for measurement are not connected to the measuring instrument under test.
- Step 2:** Using the function selector switch, select $\sim 300V$.
- Step 3:** Connect the lead cables for measurement to the measuring terminals of the measuring instrument under test.

5.2.2 Measuring DC or AC Voltage

Step 1: Using the function selector switch, select the measurement function you want to use from $\approx 100\text{mV}$ TC, $\approx 1\text{V}$, $\approx 10\text{V}$ and $\approx 100\text{V}$.

Step 2: Using the  key, select either DC or AC. The DC --- or AC \sim symbol appears on the LCD.

5.2.3 Measuring DC Current

Step 1: Using the function selector switch, select **mA**.

Step 2: Using the  key, select either 20 mA or 100 mA. The decimal point of the measured value shown on the LCD is repositioned.

■ Replacing the Fuse

The current input protection fuse in the mA/3WIRE terminal is housed inside the fuse holder (labeled FUSE) on one side panel of the calibrator.

To replace the fuse, first remove the fuse holder labeled FUSE by turning the holder counterclockwise with a flatblade screwdriver.

Then, replace the fuse and insert the fuse holder back in place.

Fasten the fuse holder by turning it clockwise.

The replacement fuse is described below.

| Part number | Rating |
|-------------|--------------|
| A1635EF | 100 mA/400 V |

5.3 Measuring Resistance or RTD (CA71 only) Signal

Step 1: Using the function selector switch, select **Ω RTD** .

Step 2: Using the  key, select the range.
Pressing the key cycles through the 400 Ω ,
Pt100 and JPt100 options.

TIP

- If you select the 400 Ω RTD range of the SOURCE mode at the same time, the RTD selected on the SOURCE mode side precedes the one selected on the MEASURE mode side.
Thus, you cannot select any RTD for the **Ω RTD** range of the MEASURE mode. (CA71 only)
 - To carry out measurement based on three-wire connection, use the 3WIRE terminal.
-

5.4 Measuring Temperature with Thermocouple (TC) - CA71 only -



NOTE

Use the terminal adapter in locations where any voltage higher than 30 V will never be imposed on the measuring circuit.

Step 1: Using the function selector switch, select \approx **100mV TC** .

Step 2: Using the  key, select the type of thermocouple. Pressing the key cycles through the 100 mV, K, E, J, T, R, B, S, N, L and U options.

TIP

-
- If you select the 100 mV TC range of the SOURCE mode at the same time, the thermocouple selected on the SOURCE mode side precedes the one selected on the MEASURE mode side. Thus, you cannot select any thermocouple for the 100 mV TC range of the MEASURE mode.
 - If there has been a sudden change in the operating ambient temperature of the calibrator, wait until the built-in reference junction compensation stabilizes. Avoid using the calibrator in locations exposed to wind from such apparatus as an air-conditioner.
 - If the thermocouple has burnt out, the LCD shows the $-bD-$ symbol.
-

5.5 Measuring Frequency or Pulses

5.5.1 Operating the Calibrator for Frequency Measurement

Step 1: Using the function selector switch, select **FREQ 30Vmax** .

Step 2: Using the  key, select 100 Hz, 1000 Hz or 10 kHz. Pressing the key cycles through the 100 Hz, 1000 Hz, 10 kHz, CPM and CPH options.

Note however that the range reading of the LCD is given as shown below (when no signal is present).

| LCD Reading | Range |
|-------------|---------|
| 0.00 Hz | 100 Hz |
| 0.0 Hz | 1000 Hz |
| 0.000 kHz | 10 kHz |

5.5.2 Operating the Calibrator for Measuring Number of Pulses

The CPM option in this measurement counts pulses per minute, while the CPH option counts pulses per hour.

Step 1: Using the function selector switch, select **FREQ 30Vmax** .

Step 2: Using the  key, select either **CPM** or **CPH**. Pressing the key cycles through the 100 Hz, 1000 Hz, 10 kHz, CPM and CPH options.

Step 3: The  indicator turns on and the calibrator goes into a standby-for-counting state.

The calibrator begins counting pulses the moment the  key is pressed to cancel the hold state.

**NOTE**

-
- If you press the **HOLD** key after the completion of counting while the **HOLD** indicator is lit, the calibrator restarts counting from 0.
 - If you press the **HOLD** key halfway before the selected time (one minute or one hour) expires, the calibrator stops counting at that moment. The LCD shows the number of pulses counted up to the moment.
 - If the count exceeds the limit, the calibrator shows the maximum number and stops counting.
-

TIP

To measure contact input, switch to that measurement function with the DIP switch in the battery holder.

For further details, see Section 7.7, "Selecting the Contact In Function (Contact Input for Pulse Measurement)."

6. Memory Functions

The built-in memory has the following four functions. With a pair of sourced and measured signal values in a set, the calibrator can handle a maximum of 50 sets of data (hereinafter simply referred to as data) by means of its built-in memory.

1. Saving to Memory (MEM SAVE)

You can save data to memory.

2. Reading from Memory (MEM READ)

You can show data in memory on the LCD.

When data is being read from memory, the source output remains turned off.

Thus, you cannot do any source task using data stored in memory.

3. Clearing Memory (MEM CLEAR)

You can clear data stored in memory.

4. Sending Data from Memory - CA71 only -

You can send data in memory to an external personal computer using the communication function.

This function requires use of the optional RS232 communication cable (P/N: 91017).

For further details, see Chapter 8, "Communication Function."

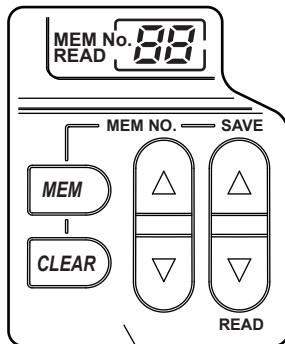

Keys and labels related to memory function

6.1 Saving Data into Memory

6.1.1 Saving Data in the Order of Memory Numbers

Step 1: Press the  key.

The **MEM No.** indicator on the LCD turns on.

At this point, the indicator shows a memory number immediately following the one most recently used to save data.

Step 2: Pressing the **SAVE**  key saves the sourced and measured (currently on-display) signal values at that moment into the area with that memory number (address).

Executing the MEM SAVE function cancels the state of selecting memory, reverting to normal setting mode.

Step 3: To save the next data item into the area with the next memory number, press the  key once again.

Now the MEM No. indicator shows a memory number one count larger than the previous one.

Step 4: Pressing the **SAVE**  key saves the sourced and measured (currently on-display) signal values at that moment into the area with that memory number (address) – the previous memory number (address) + 1.

TIP

To cancel the memory mode (saving/reading), press the  key one more time.

(Executing the MEM SAVE function automatically cancels the memory mode.)

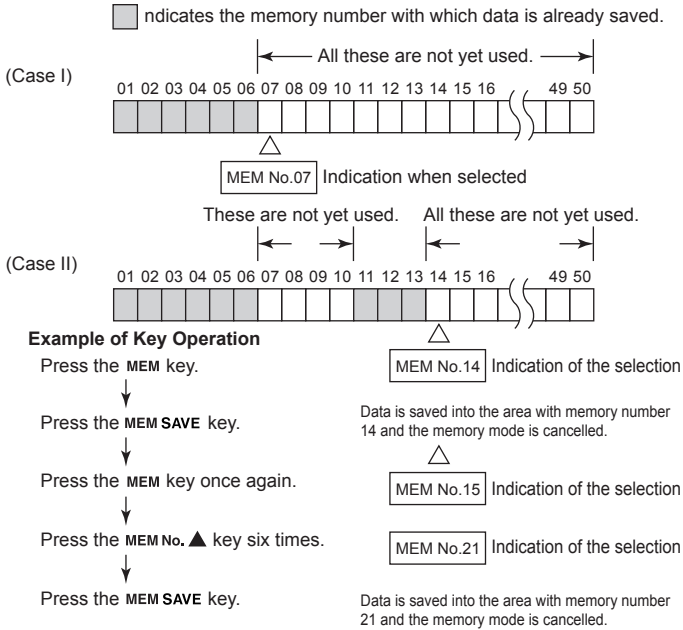

Working with the MEM SAVE Function



NOTE

- In memory mode, some of the and keys change to those for working with memory. Consequently, you cannot do the regular task of setting output values for source.
- The **MEM No.** indicator begins with if no data has been saved into memory.
If memory contains any saved data already, a memory number immediately following the largest of the already used memory numbers is allocated to the next data, as shown in the figure discussed above, even if there is any not-yet-used memory address at some midpoint.
- In the case of the divided output function (n/m), the output value "setpoint $\times n/m$ " for source is stored in memory.

6.1.2 Saving Data by Selecting Desired Memory Number

- Step 1:** Press the **MEM** key.
The **MEM No.** indicator on the LCD turns on.
- Step 2:** Using the pair of **MEM NO.** key, select the desired memory number (address).
- Step 3:** Pressing the **SAVE** key saves the sourced and measured (currently on-display) signal values at that moment into the area with the selected memory number (address).

TIP

To cancel the memory mode (saving/reading), press the **MEM** key one more time.
(Executing the MEM SAVE function automatically cancels the memory mode.)

6.1.3 Overwriting Data in Memory

- Step 1:** Press the **MEM** key.
- Step 2:** Using the pair of **MEM NO.** key, select the desired memory number (address).
- Step 3:** Press the **SAVE** key. The LCD shows *REPLACE* to alert you.
- Step 4:** Pressing the **SAVE** key once again overwrites the data in that memory number.



Alarm indication for memory overwriting

NOTE

To stop overwriting the data, press the **MEM** key one time.
This cancels saving data, reverting to the original state of being able to save/read data to/from memory.

TIP

To cancel the memory mode (saving/reading),
press the **MEM** key one more time.
(Executing the MEM SAVE function automatically cancels the memory mode.)

6.2 Reading Data from Memory

Step 1: Press the **MEM** key once.

The LCD shows MEM No. xx.

At this point, the MEM No. indicator shows a memory number immediately following the one most recently used to save data. (Memory is ready for data saving.)

Step 2: Pressing the **READ** key causes the on-screen **READ** indication to blink, indicating the calibrator is reading from memory.

Step 3: Using the pair of **MEM NO.** key, select the memory number whose data you want to read.
The LCD shows the data thus read out of memory.
The items of the read data are shown on their respective measured-value and generated-value display areas.
If the area with the memory number contains no saved data, the LCD shows - - - - .

TIP

- To cancel reading from the memory mode, press the **MEM** key or the **READ** key one more time.
- To save data anew while reading from memory, overwrite the existing data by following step 2 in subsection 6.1.3, "Overwriting Data in Memory."

6.3 Clearing Data in Memory

6.3.1 Clearing Data by Selecting Desired Memory Number

- Step 1:** Press the **MEM** key once.
The **MEM No.** indicator on the LCD turns on.
- Step 2:** Using the pair of **MEM NO.** Δ ∇ key, select the memory number whose data you want to clear.
- Step 3:** Pressing the **CLEAR** key causes the LCD to show the alarm indication *no.88 CLEAR*.
(no.88 indicates object **MEM No.**)
- Step 4:** Pressing the **CLEAR** key once again clears the data with the selected memory number.

TIP

- To cancel clearing the data after the *CLEAR* alarm indication is given, press the **MEM** key.
The calibrator reverts to memory mode (saving/reading).
 - You can also clear the data after having read it from memory.
-

6.3.2 Clearing All In-Memory Data Globally

- Step 1:** Press the **MEM** key once.
The **MEM No.** indicator on the LCD turns on.
- Step 2:** Hold down the **CLEAR** key for at least five seconds.
The LCD shows the *ALL CLEAR* alarm indication.
- Step 3:** Pressing the **CLEAR** key once again clears all of the data in memory.



ALL CLEAR alarm indication

TIP

To cancel clearing the data after the *ALL CLEAR* alarm indication is given, press the **MEM** key.
The calibrator reverts to memory mode (saving/reading).

6.4 Sending Out Data from Memory - CA71 only -

See Chapter 8, "Communication Function."

7. Functions Provided by DIP Switch

By configuring the DIP switch, you can use the functions listed below. The DIP switch can be found by removing the battery holder cover at the back of the calibrator.

⚠ CAUTION

Turn off the calibrator before you change the DIP switch configuration.

| DIP Switch Position | Description | Factory Setting | |
|---------------------|---|-----------------|-----------------|
| | | OFF (left-side) | ON (right-side) |
| 1 Sweep | Selects the sweep or auto-step function. | ✓ | |
| 2 Speed | Changes the speed setpoint of the sweep or auto-step function. | ✓ | |
| 3 INT RJ | Selects the internal reference junction compensation for TC signal generation. | ✓ | |
| 4 IPTS-68 | Selects the IPTS-68 temperature scale for temperature signal generation or measurement. | ✓ | |
| 5 No use | Denotes the position is not used. | ✓ | |
| 6 Temp | OFF | ✓ | |
| 7 Contact In | Selects contact input based operation for pulse measurement. | ✓ | |
| 8 No use | Denotes the position is not used. | ✓ | |

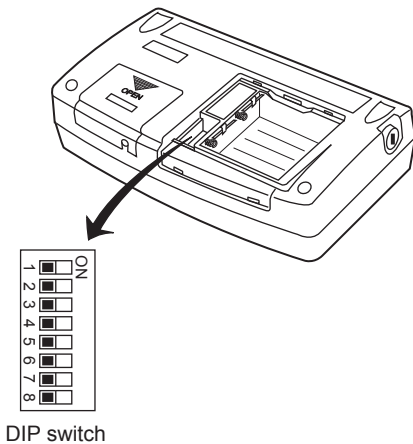





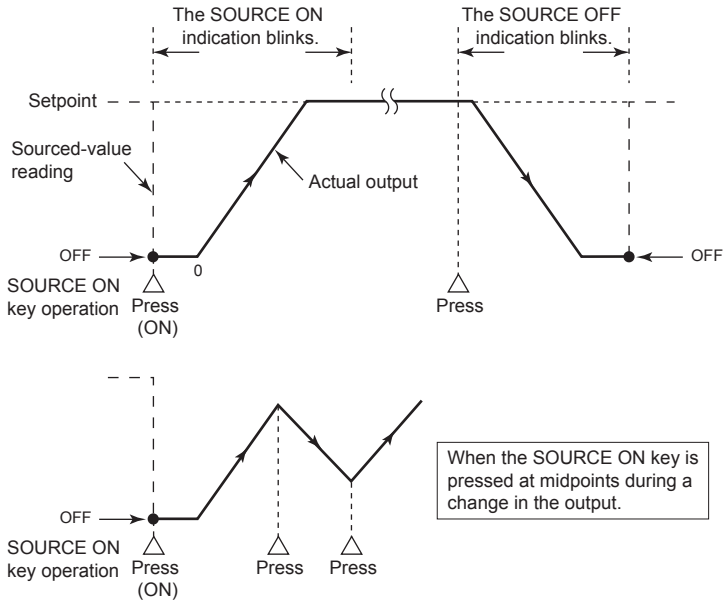



7.1 Sweep Function

The sweep function lets you linearly change the calibrator output as shown in the following figure.





Sweep Mode Operation

- Step 1:** Press the  key to turn off the calibrator.
- Step 2:** Place switch 1 (Sweep switch) in the ON (right-side) position.
- Step 3:** By setting the position of switch 2 (Speed switch), change the sweep speed.
OFF (left-side): 16 sec; ON (right-side): 32 sec
- Step 4:** Press the  key to turn on the calibrator.
The LCD shows **SWEEP**.
- Step 5:** Using the function selector switch, select the function (voltage, current, resistance, thermocouple, or RTD) for which you want to source a signal. In the case of pulse source, the sweep function is disabled.

- Step 6:** Using the pair of  and  keys, set the upper limit of the signal to be output.
The lower limit is set to a value predetermined depending on the selected range.
- Step 7:** Pressing the  key initiates sweeping and the output value begins to increase.
- The LCD shows  and the lower limit (default) for approximately two seconds.
The calibrator outputs the default.
 - Then, the LCD reading and the output value begin to increase in fixed increments, up to the upper limit, in the sweep time set in the preceding steps.
 - When the output reaches the setpoint, the calibrator retains the output as is, and automatically holds sweep operation.
- Step 8:** Pressing the  key once again causes the output value to begin decreasing. The output value decreases down to the lower limit in the same amount of time it took to increase up to the upper limit. When the output reaches the lower limit, the calibrator retains the output as is for approximately three seconds, and then automatically turns it off.
Thus, one cycle of sweeping is completed.
- Step 9:** To quit the sweep function, turn off the calibrator by pressing the  key.
- Step 10:** Place switch 1 back in the OFF (left-side) position to disable the sweep function.



NOTE



- When the output reaches the lower limit, the calibrator retains the output as is for three seconds, and then turns it off. Thus, one cycle of sweeping is completed.
- To alter the direction in which the output changes, press the  key when sweeping is in progress (LCD reading is changing).
The calibrator alters the direction of change and continues sweep operation.
For example, pressing the  key during an increase in the output causes the output to begin decreasing.

7.2 Auto Step Function

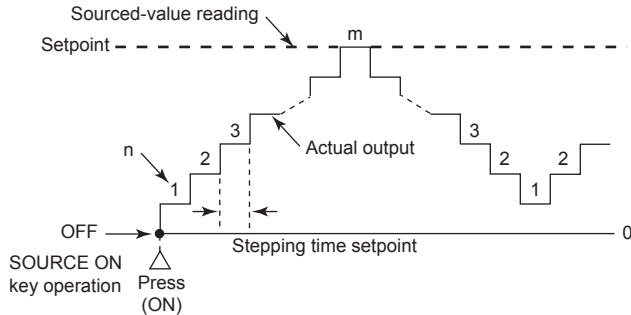
The auto step function automatically changes the variable n of the n/m output in a step-by-step manner, as shown in the following figure, when the divided output function (n/m) is selected.



Auto Step Operation (when the default of n is set to 1)



- Step 1:** Press the  key to turn off the calibrator.
- Step 2:** Place switch 1 (Sweep switch) in the ON (right-side) position.
- Step 3:** By setting the position of switch 2 (Speed switch), set the time of one step.
OFF (left-side): 2.5 sec/step; ON (right-side): 5 sec/step
- Step 4:** Press the  key to turn on the calibrator.
- Step 5:** Using the function selector switch, select the function (voltage, current, resistance, thermocouple, or RTD) for which you want to source a signal.
In the case of pulse source, the auto step function is disabled.
- Step 6:** Set the output value.
- Step 7:** Press the  key.
The **SWEEP** indication on the LCD changes to **AUTO STEP** and the n/m symbol turns on.

Step 8: Using each pair of Δ and ∇ keys, set the value of the denominator m and the starting setpoint of the enumerator n .
(See Section 4.6, "Divided Output Function (n/m), for further details.)
The starting setpoint is the minimum of the variable n for auto step operation.

Step 9: Pressing the  key initiates the automatic stepping of the divided output (n/m), as described below.
Assuming the starting value of the variable n is 1, the output cyclically changes with the variable n as n changes in the following manner.
 $n = 1 \rightarrow 2 \rightarrow 3 \rightarrow \dots (m - 1) \rightarrow m \rightarrow (m - 1) \rightarrow \dots \rightarrow 2 \rightarrow 1 \rightarrow 2 \rightarrow 3 \rightarrow \dots$

Step 10: To quit the auto step function, turn off the calibrator by pressing the  key.
Place switch 1 back in the OFF (left-side) position.
Note that disabling the divided output mode (n/m) before placing switch 1 back in the OFF position enters sweep mode.



TIP

- Pressing the  key to change to the SOURCE OFF state pauses the auto step operation.
- To execute the auto step function again, press the  key.
The auto step operation resumes from the value of n shown on the LCD.

7.3 Selecting the INT RJ Function

The INT RJ function compensates for the measured reference junction temperature by using the calibrator's built-in RJ sensor. The function enables you to generate thermoelectromotive force that is based on the measured temperature from the calibrator's output terminal. The built-in temperature sensor is located near the calibrator's terminals. Because the thermoelectromotive force generated using this method does not match that generated using an external RJ sensor,* the accuracy of this measurement is not guaranteed. For more accurate reference junction compensation, be sure to use the optional RJ sensor (P/N: B9108WA).

* The terminal temperature of the thermometer under verification is measured using an external RJ sensor, and this temperature is used as the reference junction temperature.

- Step 1:** Press the  key to turn off the calibrator.
- Step 2:** Place switch 3 (INT RJ switch) in the ON (right-side) position. The calibrator detects temperature using its built-in temperature sensor and outputs reference junction-compensated thermoelectromotive force appropriate for the detected temperature.
- Step 3:** To disable the INT RJ function, turn off the calibrator by pressing the  key.
- Step 4:** Place switch 3 back in the OFF (left-side) position.

TIP

Even when the INT RJ function is selected, the temperature detected by an external RJ sensor precedes any other measured temperature if you plug the sensor into the RJ INPUT connector.

For further details, see Appendix 1, "Reference Junction Compensation."

7.4 Selecting the IPTS-68 Function

By placing switch 4 (IPTS-68 switch) in the ON (right-side) position, you can select the IPTS-68 temperature scale when you choose the type-K, E, J, T, N, R, S or B thermocouple or the Pt100 RTD. Placing the switch in the OFF position results in the selection of the ITS-90 temperature scale.

TIP

When you have selected a type of thermocouple or RTD, the LCD shows IPTS-68.

7.5 Switch Not Used

Although switch 5 (No Use switch) of the DIP has no effect on calibrator operation, the switch should be placed in the OFF (left-side) position.

7.6 Temp Switch

Check that the switch should be placed in the OFF position.

7.7 Selecting the Contact In Function (Contact Input for Pulse Measurement)

By placing switch 7 (Contact In switch) in the ON (right-side) position, you can measure transistor contact on-off signals.

If you select the contact input function, the  (contact) symbol appears on the LCD.

By placing the switch in the OFF position, you can measure normal pulse.

8. Communication Function - CA71 only -

You can configure the calibrator from a personal computer just as you do with the calibrator's panel keys (except for turning on/off the power, configuring the function selector switch, and setting the communication function).

You can also verify the setpoint, measured value and status of the calibrator.



NOTE

- With the optional communication cable (P/N: 91017), you can use the RS232 serial port (9-pin D-sub) of a personal computer or any other equipment.
- In talk-only or printer mode, you can output the source setpoint and measured value at preset intervals.

8.1 Cables Connection and Interface Specifications

■ Connecting Communication Cable

Remove the I/O port cover at the back of the calibrator and connect the communication cable (P/N: 91017) to the I/O port.

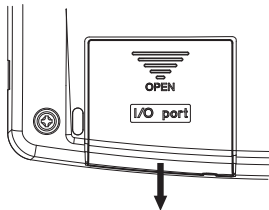

■ Setting RS232 Parameters

| | |
|---------------|---|
| Baud rate: | 9600 baud |
| Parity: | None |
| Stop bits: | 2 bits |
| Data length: | 8 bits |
| Flow control: | None (Xon/Xoff control for printing only) |
| Delimiter: | Fixed to CrLf |

8.2 Setting the Mode

- Step 1:** Press the **SET** key while simultaneously holding down the **HOLD** key.
The LCD shows $\overline{[ON]}$ in its upper section and either *nor*, *tonly* or *Print* in its lower section.
- Step 2:** Using the pair of **Δ** and **▽** keys, select *nor*, *tonly* or *Print*.
- Step 3:** Press the **SET** key to confirm your mode selection.
If you set the mode to *tonly* or *Print*, the LCD shows $\overline{[SET]}$.
When the $\overline{[SET]}$ is indicated, each press of the **HOLD** key outputs one data item.
- Step 4:** If you set any value using the pair of **Δ** and **▽** keys with $\overline{[SET]}$ shown, the calibrator outputs data using the value thus set as the time interval (sec).
The value should be set within the range from 0 to 3600.

TIP

- To close the communication setting screen, press the **SET** key once again while simultaneously holding down the **HOLD** key.
 - Even if you turn off the calibrator, the communication mode and interval you have set are saved internally until you replace the batteries or reconfigure the communication function.
Thus, communication will take place with the previous settings.
-

8.3 Types of Mode

- nor*: Normal mode – Permits normal transmission and reception.
- tonly*: Talk-only mode – Outputs the source setpoint and measured value at preset intervals (0* to 3600 sec).
- Print*: Printer mode – Outputs the source setpoint and measured value to a printer at preset intervals (0* to 3600 sec).

*: For a 0-second interval, each press of the **HOLD** key outputs one data item. For other intervals, pressing the **HOLD** key initiates or terminates communication.

TIP

When communication is in progress, the **HOLD** indicator blinks, telling you data is being output.

Care must be taken therefore, since the hold function of the MEASURE mode is disabled if you select *hold* or *print*.

8.4 Data Format

Data is output from the calibrator in the following format.

| | | |
|----------|----------|--------|
| Source: | Function | 1V |
| | Range | DC V |
| | Data | 1.0000 |
| Measure: | Function | 100 mV |
| | Range | k |
| | Data | 25.5C |

8.5 Data Structure

The calibrator's program has the following data structure.

Command + Parameter + Delimiter

Command: Defined by one to three alphabetical upper-case letters.

Parameter: A string of ASCII-code numerals or characters.

Delimiter: Fixed to CrLf.

8.6 Commands

| Command | Description |
|---------|--|
| BL | Turns the back lighting on and off/queries the current setting. |
| DW | Moves down the “m-th” digit of the sourced setpoint by one digit. |
| UP | Moves up the “m-th” digit of the sourced setpoint by one digit. |
| H | Enables/Disables the output data header/queries the current setting. |
| HD | Enables/Disables data hold mode/queries the current setting. |
| MF | Queries the measurement function. |
| MO | On/Off of measurement/queries the current setting. |
| MR | Sets the measuring range/queries the current setting. |
| OD | Outputs measured value. |
| OE | Outputs error information. |
| OR | Queries whether an external RJC sensor is connected. |
| OS | Outputs the setting information. |
| SD | Sets sourced setpoint/queries the current setting. |
| SF | Queries the source function. |
| SO | On/Off of source output/queries the current setting. |
| SR | Sets the sourcing range/queries the current setting. |
| SY | Switches between the normal and adjustment modes/queries the current setting. |
| CD | Sets the sourced setpoint/queries the current setting. |
| CL | Sets the adjustment item/queries the current setting. |
| CP | Sets the adjustment point. |
| CW | Saves the adjusted data. |
| CMF | Queries the measurement function. |
| CSF | Queries the source function. |
| OM | Queries memory data. |
| NM | Sets divided output (n/m) mode/queries the current setting. |
| ND | Sets n/m values in divided output (n/m) mode/queries the current setting. |
| TE | Sets the temperature monitor display for sourced TC/RTD range/queries the current setting. (TC, RTD mode only) |
| PU | Sets the display for sourced pulse range/queries the current setting. |

8.7 Detailed Description of Commands

| | | |
|---|--|----------------------------------|
| BL | Turns the back lighting on and off /queries the current setting. | When normal condition |
| Syntax for setting BLm<delimiter> | | |
| Syntax for query BL?<delimiter> ⇒ Response: BLm<delimiter> | | |
| Description of parameter m=0: Off m=1: On | | |
| DW | Moves down the "m-th" digit of the sourced setpoint by one digit. | When normal condition |
| Syntax for setting DWm<delimiter> | | |
| Description of parameter m: Specifies a digit 1 (the lowest digit) to 5 (the highest digit) | | |
| UP | Moves up the "m-th" digit of the sourced setpoint by one digit. | When normal condition |
| Syntax for setting UPm<delimiter> | | |
| Description of parameter m: Specifies a digit 1 (the lowest digit) to 5 (the highest digit) | | |
| H | Enables/Disables the output data header/queries the current setting. | When normal condition/adjustment |
| Syntax for setting Hm<delimiter> | | |
| Syntax for query H?<delimiter> ⇒ Response: Hm<delimiter> | | |
| * For details on the header, see the OD command. | | |
| Description of parameter m: Enables/Disables the header m=0: Disabled m=1: Enabled | | |
| HD | Enables/Disables data hold mode/queries the current setting. | When normal condition |
| Syntax for setting HDm<delimiter> | | |
| Syntax for query HD?<delimiter> ⇒ Response: HDm<delimiter> | | |
| Description of parameter m: Specifies data hold m=0: Hold Off m=1: Hold On | | |

8.7 Detailed Description of Commands

| | | |
|---|---|----------------------------------|
| MF | Queries the measurement function. | When normal condition |
| Syntax for query MF?<delimiter> ⇒ Response: MFm<delimiter> | | |
| Description of parameter m: Measurement function m=0: 300V AC m=1: 100V m=2: 10V m=3: 1V m=4: 100mV m=5: Resistance m=6: Frequency m=7: Current | | |
| MO | On/Off of measurement/queries the current setting. | When normal condition/adjustment |
| Syntax for setting MOm<delimiter> | | |
| Syntax for query MO?<delimiter> ⇒ Response: MOm<delimiter> | | |
| Description of parameter m: On/Off condition m=0: Off m=1: On | | |
| MR | Sets the measuring range/queries the current setting. | When normal condition/adjustment |
| Syntax for setting MRm<delimiter> | | |
| Syntax for query MR? <delimiter> ⇒ Response: MRm<delimiter> | | |
| Description of parameter m: Measuring range [100V] m=0: DC m=1: AC [10V] m=0: DC m=1: AC [1V] m=0: DC m=1: AC [100mV] (When normal condition) m=0: 100mV DC m=1: TcK m=2: TcE m=3: TcJ m=4: TcT m=5: TcR m=6: TcB m=7: TcS m=8: TcN m=9: TcL m=10: TcU [100mV] (When adjustment) m=0: 100mV DC m=1: TcK m=2: TcE m=4: TcT [Ω] m=0: 400Ω m=1: Pt100 m=2: JPt [Freq] m=0: 100Hz m=1: 1kHz m=2: 10kHz [mA] m=0: 20mA m=1: 100mA | | |

| | | |
|---|--|----------------------------------|
| OD | Outputs measured value. | When normal condition/adjustment |
| Syntax for setting OD<delimiter> ⇒ Response: ODabcde<delimiter> | | |
| Description of parameter <Header section> (Output only when the header is set to "enabled"). a = V: Voltage A: Current O: Resistance T: Temperature F: Frequency b = DC: Direct current AC: Alternating current c = N: Normal O: Overrange E: No data <Data section> d = Measured value, mantissa part (7 digits) e = Measured value exponent part (E-3 / E+0 / E+3) de = 99999. E+3 when overrange occurs or no data reside. | | |
| OE | Outputs error information. | When normal condition/adjustment |
| Syntax for setting OE<delimiter> ⇒ Response: ERRm<delimiter> | | |
| Description of parameter m: Error information m=00: No error m=11: Received command not used in this instrument m=12: Specified parameter value is outside allowed range. m=13: Attempt made to execute a command that is not permitted in a certain status of the instrument. m=16: An error was received during adjustment. | | |
| OR | Queries whether an external RJC sensor is connected. | When normal condition |
| Syntax for query OR<delimiter> ⇒ Response: m | | |
| Description of parameter m: Connecting condition of external RJC m=0: Not connected m=1: Connected | | |
| OS | Outputs the setting information. | When normal condition |
| Syntax for setting OS<delimiter> Response Measure m<CrLf> m = On/Off Function m<CrLf> m = Measurement function Range m<CrLf> m = Measuring range Source m<CrLf> m = On/Off Function m<CrLf> m = Source function Range m<CrLf> m = Source range Data m<CrLf> m = Sourced setpoint Light m<CrLf> m = On/Off | | |

8.7 Detailed Description of Commands

| | | |
|--|--|----------------------------------|
| SD | Sets sourced setpoint/queries the current setting. | When normal condition |
| Syntax for setting SDm<delimiter> Syntax for query SD?<delimiter> ⇒ Response: SDm<delimiter> | | |
| Description of parameter m: Sourced setpoint (7 digits) ex. +1.0000 | | |
| SF | Queries the source function. | When normal condition |
| Syntax for query SF? <delimiter> ⇒ Response: SFm<delimiter> | | |
| Description of parameter m: Function m=0: 30V m=1: 10V m=2: 1V m=3: 100mV m=4: Resistance m=5: Pulse m=6: 20mA m=7: 4 to 20mA m=8: 20mASINK | | |
| SO | On/Off of source output/queries the current setting. | When normal condition/adjustment |
| Syntax for setting SOm<delimiter> Syntax for query SO?<delimiter> ⇒ Response: SOm<delimiter> | | |
| Description of parameter m: Condition of generation (source) m=0: Off m=1: On | | |
| SR | Sets the sourcing range/queries the current setting. | When normal condition/adjustment |
| Syntax for setting SRm<delimiter> Syntax for query SR?<delimiter> ⇒ Response: SRm<delimiter> | | |
| Description of parameter m: sourcing range [100mV] (When normal condition) m=0: DC 100mV m=1: TcK m=2: TcE m=3: TcJ m=4: TcT m=5: TcR m=6: TcB m=7: TcS m=8: TcN m=9: TcL m=10: TcU [100mV] (When adjustment) m=0: DC 100mV m=1: TcK [Ω] m=0: 400Ω m=1: Pt100 m=2: JPt [Freq] m=0: 500Hz m=1: 1kHz m=2: 10kHz | | |

| | | |
|--|---|----------------------------------|
| SY | Switches between the normal and adjustment modes/queries the current setting. | When normal condition/adjustment |
| Syntax for setting SYm<delimiter> Syntax for query SY?<delimiter> ⇒ Response: SYm<delimiter> | | |
| Description of parameter m: Mode m=0: Normal mode m=1: Adjustment mode | | |
| CD | Sets the sourced setpoint/queries the current setting. | When adjustment |
| Syntax for setting CDm<delimiter> Syntax for query CD?<delimiter> ⇒ Response: CDm<delimiter> | | |
| Description of parameter m: Sourced setpoint (8 digits) ex. +1.00003 | | |
| CL | Sets the adjustment item/queries the current setting. | When adjustment |
| Syntax for setting CLm<delimiter> Syntax for query CL?<delimiter> ⇒ Response: CLm<delimiter> | | |
| Description of parameter m: Adjustment item m=3: Adjustment of source m=4: Adjustment of measurement | | |
| CP | Sets the adjustment point. | When adjustment |
| Syntax for setting CPm<delimiter> | | |
| Description of parameter m: Adjustment point m=0: FS adjustment m=1: Zero adjustment | | |
| CW | Saves the adjusted data. | When adjustment |
| Syntax for setting CW<delimiter> Be sure to execute CW command after adjustment for each function/range. Without executing CW command, the adjusted value will be deleted when the power is turned off. | | |

8.7 Detailed Description of Commands

| | | |
|---|-----------------------------------|-----------------------|
| CMF | Queries the measurement function. | When adjustment |
| Syntax for query CMF?<delimiter> ⇒ Response: CMFm<delimiter> | | |
| Description of parameter m: Measurement function m=0: AC 300V m=1: 100V m=2: 10V m=3: 1V m=4: 100mV m=5: Resistance m=6: Frequency m=7: Current | | |
| CSF | Queries the source function. | When adjustment |
| Syntax for query CSF?<delimiter> ⇒ Response: CSFm<delimiter> | | |
| Description of parameter m= Function m=0: 30V m=1: 10V m=2: 1V m=3: 100mV m=4: Resistance m=5: Pulse m=6: 20mA m=7: 4 to 20mA m=8: 20mASINK | | |
| OM | Queries memory data. | When normal condition |
| Syntax for query OMm<delimiter> Response: abcde, fghij [, fghij] <delimiter> <Header section of measured value> a= V: Voltage A: Current O: Resistance T: Temperature F: Frequency b= DC: Direct current AC: Alternating current c= N: Normal O: Overrange E: No data <Data section of measured value> d = Measured value, mantissa part (7 digits) e = Measured value exponent part (E-3 / E+0 / E+3) <Header section of sourced setpoint> f= V: Voltage A: Current O: Resistance T: Temperature F: Frequency g= DC: Direct current AC: Alternating current h= N: Normal E: No data i = Sourced setpoint, mantissa part (7 digits) j = Sourced setpoint exponent part (E-3 / E+0 / E+3) | | |
| Description of parameter m: Number of memory 1 to 50 | | |

9. Troubleshooting and Calibration

■ Troubleshooting

Failure Checklist

Troubleshoot the cause of any problem using the following checklist. Should the problem persist even if you have taken the given corrective action or if you notice any problem not listed herein, contact the vendor from which you purchased the instrument.

| Problem | Corrective Action |
|---|--|
| The LCD shows nothing even if the POWER switch is turned on. | <ul style="list-style-type: none">– When the calibrator is operated on batteries<ul style="list-style-type: none">• Make sure the batteries are securely housed in the holder.• Check if the batteries are too low.• Check if the AC adapter plug is inserted to the calibrator but the adapter is not connected to the AC power source.– When the calibrator is operated on AC adapter<ul style="list-style-type: none">• Check if the AC adapter is reliably supplied with electricity. |
| The LCD shows everything except for the measured value. | <ul style="list-style-type: none">• Check if the MEASURE OFF key for turning on/off the MEASURE mode is set to OFF. |
| The SOURCE indicator remains set to OFF even if the SOURCE ON key is operated for signal source. | <ul style="list-style-type: none">• When in voltage signal source, check if the load current is beyond the specified limits.• When in current signal source, check if the load resistance is too large. |
| The output cannot be turned on for signal source, or no signal is output even if the output is turned on. | <ul style="list-style-type: none">• The built-in fuse may blow off if any abnormal voltage level is applied to the output terminals. If this is the case, the calibrator needs repair. |
| The measured and sourced signal values are abnormal. | <ul style="list-style-type: none">• Check if the signal carries noise.• When in resistance signal source, check if the input stage of the device under test contains a capacitor with an excessively large capacitance. |
| The calibrator cannot be configured or controlled via RS232 interface-based communication. | <ul style="list-style-type: none">• Make sure the communication parameter settings are correct. |
| The hold function of the MEASURE mode does not work at all. | <ul style="list-style-type: none">• Check if the communication mode is set to <i>tonLy</i> or <i>Print</i>. |
| The LCD shows Err60 at power-on. | <ul style="list-style-type: none">• The calibrator needs repair. |

■ **Calibration**

We recommend that you calibrate the instrument once a year to maintain its accuracy (high accuracy).

For a service of calibration, contact the dealer from which you purchased the instrument.

10. Method of Calibrator Adjustment

We recommend that you calibrate the instrument once a year to maintain its accuracy (high accuracy).

If the calibrator needs to be readjusted, follow the procedure described below.

For a service of calibration or readjustment, contact the dealer from which you purchased the instrument.

10.1 Calibration Standard Selection and Environmental Requirements

■ Selection of Calibration Standard

Select an appropriate calibration standard having the ranges shown in the following table and accuracy levels equal to or higher than those shown in the table.

Source Functions

| Function to Be Adjusted | Standard's Name | Range to Be Adjusted | Measuring Range | Accuracy | Remarks |
|-------------------------|---|-------------------------------|---------------------------------|--|---|
| DCV | Digital multimeter (DMM) Note: | 100 mV 1 V 10 V 30 V | 110 mV 1.1 V 11 V 33 V | $\pm(0.002\%+1.5 \mu\text{V})$ $\pm(0.002\%+10 \mu\text{V})$ $\pm(0.002\%+100 \mu\text{V})$ $\pm(0.002\%+1 \text{ mV})$ | --- |
| DCA | Also use a 100 Ω standard resistor for the DCA and SINK functions and a high-precision 5 mA current source for the $\Omega/5$ mA function. | 20 mA | 22 mA | $\pm(0.002\%+0.3 \mu\text{A})$ | Measure the current with the DMM's mA range or measure the voltage drop across the 100 Ω standard resistor with the DMM's voltage range. |
| SINK | | 20 mA | 20 mA | $\pm(0.002\%+0.3 \mu\text{A})$ | |
| $\Omega/1$ mA | | 400 Ω | 440 Ω | $\pm(0.0025\%+0.01 \Omega)$ | DMM's resistance range (1mA) |
| $\Omega/5$ mA | | 400 Ω | 2.2 V/5 mA | $\pm(0.0025\%)$ | High-precision current source (5 mA) |
| | $\pm(0.0025\%)$ | | | DMM's voltage range | |

Measurement Functions

| Function to Be Adjusted | Standard's Name | Range to Be Adjusted | Measuring Range | Accuracy | Remarks |
|-------------------------|------------------------------------|----------------------|-----------------|---|---------|
| DCV | High-precision calibrator | 100 mV | 100 mV | $\pm(0.0025\%+1 \mu\text{V})$ | --- |
| | | 1 V | 1 V | $\pm(0.0025\%+20 \mu\text{V})$ | |
| | | 10 V | 10 V | $\pm(0.0025\%+0.2 \text{ mV})$ | |
| | | 30 V | 30 V | $\pm(0.005\%+2 \text{ mV})$ | |
| DCA | | 20 mA 100 mA | 20 mA 100 mA | $\pm(0.0025\%+0.4 \mu\text{A})$ $\pm(0.004\%+3 \mu\text{A})$ | --- |
| Ω | Decade resistance box | --- | 400 Ω | $\pm(0.01\%)$ | --- |
| ACV | AC calibrator or AC voltage source | 1V | 1 V | $\pm(0.08\%+0.015\%)$ | --- |
| | | 10 V | 10 V | | |
| | | 100 V | 100 V | | |
| | | 300 V | 300 V | | |

■ Environmental Requirements

- Ambient temperature: 23 \pm 1 $^{\circ}$ C
- Relative humidity: 45 to 75%
- Warm-up: Before use, warm up the calibration standard for the period of time specified for the standard.

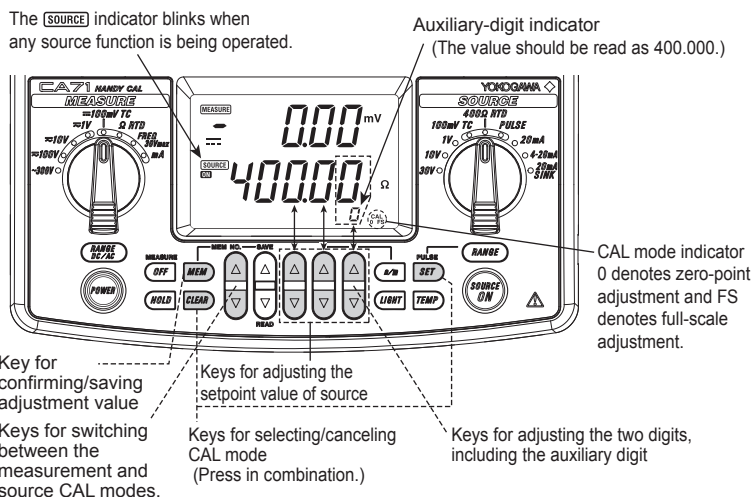

CAL-mode Operation keys and Display Indications

10.2 Adjusting Source Functions

Table 10.1 Adjustment Points of Source Functions

| Range | Adjustment Points *1 | | Remarks |
|------------|----------------------|--------|-----------------------|
| | CAL 0 | CAL FS | |
| 100 mV | 0 | 100 mV | --- |
| 1 V | 0 | 1 V | --- |
| 10 V | 0 | 10 V | --- |
| 30 V | 0 | 30 V | --- |
| 20 mA | 0 | 20 mA | See the figure below. |
| 20 mA SINK | 0.1 mA | 20 mA | See the figure below. |
| 400 Ω/1 mA | 0 | 400 Ω | Four-wire connection |
| 400 Ω/5 mA | 0 | 400 Ω | See the figure below. |

*1: Adjust the source functions so that the readings of the calibration standard (output values of the CA51/71) match the adjustment points listed above.





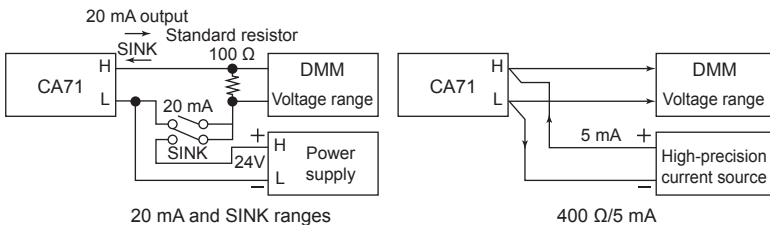





TIP

- You can also select only the range in need of readjustment to adjust it separately.
- Always make zero-point (0) adjustments together with full-scale (FS) adjustments.



Hook-ups for Adjustment

- Step 1:** Press the **SET** key while simultaneously holding down the **CLEAR** key. The LCD shows $[CAL] S_{rC}$.
- Step 2:** Pressing the **SET** key enters the source CAL mode. The **SOURCE** indicator blinks on the LCD and the 0^{CAL} symbol appears. The calibrator is now ready for the zero-point adjustment of source functions.

- Step 3:** From Table 10.1, select the range you want to adjust. Then, point the function selector switch to that range and press the  key.
- Step 4:** Conform that the CAL_0 symbol is appearing on the LCD.
- Step 5:** Read the calibrator output on the calibration standard. Then, using the lowest-order pair of  and  keys, adjust the reading so that it matches the given CAL 0 adjustment setpoint in Table 10.1. In the CAL mode, the lowest-order pair of  and  keys are used to increase or decrease the least-significant two digits, including the auxiliary digit. Adjust the value measured with the calibration standard to the given adjustment setpoint in Table 10.1.
- Step 6:** Press the  key to confirm the CAL 0 adjustment setpoint. The CAL indicator on the LCD changes to CAL_{FS} , setting the calibrator ready for full-scale adjustment.
- Step 7:** Using the lowest-order pair of  and  keys, adjust the reading of the calibration standard so that it matches the given CAL FS adjustment setpoint in Table 10.1.
- Step 8:** Press the  key to confirm the CAL FS adjustment setpoint. The 0 and FS symbols on the LCD blink.
- Step 9:** Pressing the  once again saves the adjustment setpoint in memory.
- Step 10:** The 0 and FS symbols stop blinking, causing the calibrator to return to the state discussed in step 4. Using the function selector switch, select the next range. By repeating steps 4 to 9, you can adjust the source function assigned to that range.

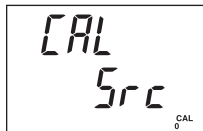

**NOTE**

- Saving to memory results in the overwriting of existing data. Be extremely careful since the previous adjustment setpoints are cleared.
- Both the thermocouple and RTD ranges are adjusted at the same time when the 100 mV and 400 Ω ranges are adjusted.

TIP

With the CAL mode selected, press the **SET** key while holding down the **CLEAR** key.

This key operation cancels the CAL mode (the same key operation as for selecting the CAL mode).

You can use the same key operation to cancel the CAL mode during adjustment, before saving to memory.

**CAUTION**

Precautions when adjusting the 400 Ω range for resistance signal source

(1) Internal Offset Adjustment

When setting a resistance of 0.00 Ω , make sure the voltage between the H and L terminals is within ± 20 μV . If the voltage is beyond the limits, internal adjustments must be made. Contact the vendor from which you purchased the instrument.

(2) Notes on Resistance-measuring Current

Adjusting the 400 Ω range requires drawing two types of resistance-measuring current – 1 mA and 5 mA – from an external device.

Adjust the range separately for each of these currents.

Adjustment for 1 mA

This adjustment is possible with the resistance measuring range of the calibration standard (digital multimeter). At this point, make sure the resistance-measuring current is 1 mA.

Adjustment for 5 mA

Like the method of adjusting the 400 Ω /5 mA range shown in the figure (Hook-ups for Adjustment) on page 10-3, you can make this adjustment by applying the reference current of 5 mA from the external device and then measuring the resulting voltage drop.

10.3 Adjusting Measurement Functions

Table 10.2 Adjustment Setpoints of Measurement Functions

| Range | Adjustment Points ^{*2} | | Remarks |
|--------------|---------------------------------|-------------------|-----------------------|
| | CAL 0 | CAL FS | |
| DC 100 mV | --- | 100 mV | --- |
| DC 1 V | --- | 1 V | --- |
| DC 10 V | --- | 10 V | --- |
| DC 100 V | --- | 100 V | --- |
| DC 20 mA | --- | 20 mA | --- |
| DC 100 mA | --- | 100 mA | --- |
| 400 Ω | 0 Ω | 380 Ω | Three-wire connection |
| AC 1 V | 0 V | 1V/50 to 60 Hz | --- |
| AC 10 V | 0 V | 10 V/50 to 60 Hz | --- |
| AC 100 V | 0 V | 100 V/50 to 60 Hz | --- |
| AC 300 V | 0 V | 300 V/50 to 60 Hz | --- |

*2: Apply the reference input signals listed above from the calibration standard.

TIP

- You can also select only the range in need of readjustment to adjust it separately.
- Always make zero-point (0) adjustments together with full-scale (FS) adjustments.

10.3.1 Adjusting DC Voltage and DC Current Ranges

- Step 1:** Press the **SET** key while simultaneously holding down the **CLEAR** key. The LCD shows $[RL] 5rc$.
- Step 2:** Pressing the highest-order **Δ** key causes the LCD to show $[RL] nERS$.
- Step 3:** Pressing the **SET** key enters the measurement CAL mode. The **MEASURE** indicator blinks on the LCD and the CAL_{FS} symbol appears. The calibrator is now ready for the defining the CAL FS setpoint of measurement functions.



CAL-mode Operation Keys and Display Indications

- Step 4:** Apply the CAL FS adjustment setpoint input of each range in Table 10.2 from the calibration standard to the H and L input terminals of the calibrator.
- Step 5:** Pressing the **MEM** key confirms the CAL FS adjustment setpoint. At this point, the CAL_{FS} symbol blinks.
- Step 6:** Pressing the **MEM** once again saves the adjustment setpoint in memory.

NOTE

- Range adjustments are made automatically within the calibrator so that the LCD reading matches the adjustment setpoint in question given in the table with reference to the input applied as described above. Therefore, you need not make any range adjustment with **Δ** and **▽** keys.
- Saving the adjustment setpoint results in the overwriting of existing data. Be extremely careful since the previous adjustment setpoints are cleared.

- Step 7:** The CAL_{FS} symbol stops blinking, causing the calibrator to return to the state discussed in step 4. Using the function selector switch, select the next range. By repeating steps 4 to 6, you can adjust the measurement function assigned to that range.

TIP

Press the **SET** key while holding down the **SET** key.

This key operation cancels the CAL mode.

You can use the same key operation to cancel the CAL mode during calibration, before saving to memory.

When adjusting DC current range, using the **RANGE DC-AC** key, change DC 20 mA → DC 100 mA.

10.3.2 Adjusting AC Voltage and Resistance (400 Ω) Ranges

- Step 1:** Press the **SET** key while simultaneously holding down the **CLEAR** key. The LCD shows $[RL \ 5rC$.
- Step 2:** Pressing the highest-order **Δ** key causes the LCD to show $[RL \ rERS$.
- Step 3:** Pressing the **SET** key enters the measurement CAL mode. The **MEASURE** indicator blinks on the LCD and the 0^{CAL} symbol appears. The calibrator is now ready for defining the CAL 0 setpoints of measurement functions.
- Step 4:** Using the function selector switch, select the range to be adjusted.
- Step 5:** Pressing the **MEM** key confirms the CAL 0 adjustment setpoint. The **CAL** indicator on the LCD changes to 0^{CAL}_{FS} , setting the calibrator ready for full-scale calibration.
- Step 6:** Apply the CAL FS adjustment setpoint input of each range in Table 10.2 from the calibration standard to the H and L input terminals of the calibrator.
- Step 7:** Pressing the **MEM** key confirms the CAL FS adjustment setpoint. At this point, the **0** and **FS** symbol blinks.
- Step 8:** Pressing the **MEM** key once again saves the adjustment setpoint in memory.



NOTE

- Range adjustments are made automatically within the calibrator so that the LCD reading matches the adjustment setpoint in question given in the table with reference to the input applied as described above. Therefore, you need not make any range adjustment with **Δ** and **▽** keys.
- Saving the adjustment setpoint results in the overwriting of existing data. Be extremely careful since the previous adjustment setpoints are cleared.
- The temperature measuring ranges of the RTD function are adjusted at the same time when the 400 Ω range is adjusted.

Step 9: The 0 and **FS** symbols stop blinking, causing the calibrator to return to the state discussed in step 4.
Using the measurement range setting rotary switch, select the next range.
By repeating steps 4 to 8, you can adjust the measurement function assigned to that range.

TIP

Press the **SET** key while holding down the **CLEAR** key.

This key operation cancels the CAL mode.

You can use the same key operation to cancel the CAL mode during calibration, before saving to memory.

10.4 Notes on the Adjustment of Temperature Ranges - CAL71 only -

Adjusting the temperature measuring ranges of the thermocouple function involves using special equipment to make reference junction compensation adjustments.

For this reason, contact the vender from which you purchased the instrument to perform this adjustment.

10.5 Post-adjustment Verification

When adjustment work is done, test the calibrator to ensure that adjustments have been made correctly and adjustment setpoints have been saved into memory correctly.

To do this test, turn off the calibrator once and turn it back on again. Then, place the calibrator in normal source or measurement mode and check the setpoints using the same calibration standard.

11. Using Accessories

When attaching accessories to the calibrator, refer to the following figure. When connecting the included terminal adapter, make sure the adapter is positioned in the correct orientation.

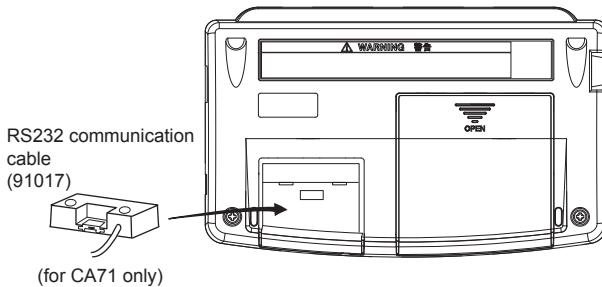
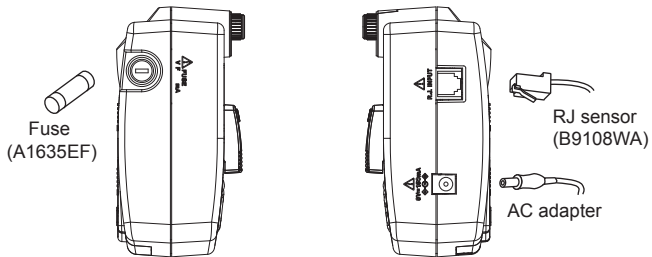
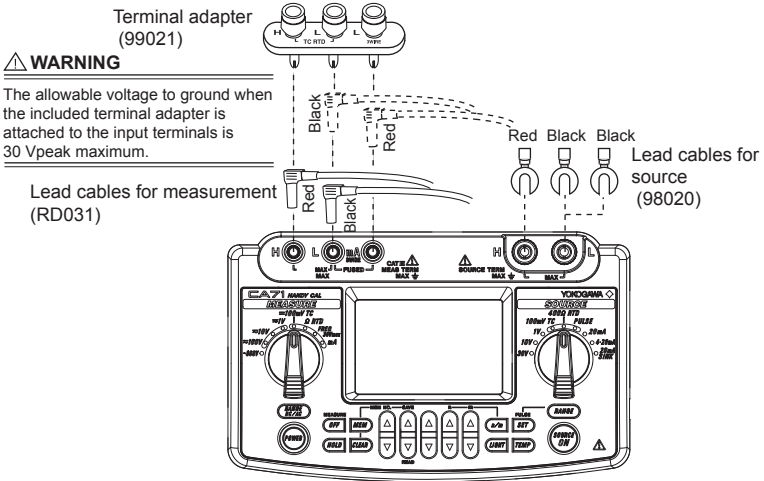

12. Specifications

(1) Signal sourcing unit range and accuracy (for both CA51 and CA71)

±(% of setting + μV , mV , mA , Ω or $^{\circ}\text{C}$)

| Parameter | Reference | Range | Accuracy ($23\pm 5^{\circ}\text{C}$ per year) | Resolution | Remarks |
|-------------------|----------------------------|------------------------------------|--|------------------------|--|
| DC voltage | 100 mV | -10.00 – 110.00 mV | $\pm(0.02\% + 15 \mu\text{V})$ | 10 μV | --- |
| | 1 V | 0 – 1.1000 V | $\pm(0.02\% + 0.1 \text{ mV})$ | 0.1 mV | Maximum output: 5 mA |
| | 10 V | 0 – 11.000 V | $\pm(0.02\% + 1 \text{ mV})$ | 1 mV | Maximum output: 10 mA |
| | 30 V | 0 – 30.00 V | $\pm(0.02\% + 10 \text{ mV})$ | 10 mV | Maximum output: 10 mA * ¹ |
| DC current | 20 mA | 0 – 24.000 mA | $\pm(0.025\% + 3 \mu\text{A})$ | 1 μA | Maximum load: 12 V |
| | 4-20 mA | 4/8/12/16/20 mA | | 4 mA | |
| mA SINK | 20 mA | 0.1 – 24.000 mA | $\pm(0.05\% + 3 \mu\text{A})$ | 1 μA | External power supply: 5 to 28 V |
| Resistance | 400 Ω | 0 – 400.00 Ω | $\pm(0.025\% + 0.1 \Omega)$ | 0.01 Ω | Excitation current: 0.5 to 5 mA * ³ If 0.1 mA, add 0.25 Ω or 0.6 $^{\circ}\text{C}$. Subject device input capacitance: 0.1 μF or less |
| RTD | Pt100 * ² | -200.0 – 850.0 $^{\circ}\text{C}$ | $\pm(0.025\% + 0.3^{\circ}\text{C})$ | 0.1 $^{\circ}\text{C}$ | TC source accuracy does not include RJ sensor accuracy. < RJ sensor specs > Measurement range: -10 to 50 $^{\circ}\text{C}$ Accuracy (when combined with main unit) 18 to 28 $^{\circ}\text{C}$: $\pm 0.5^{\circ}\text{C}$ Other than the above: $\pm 1^{\circ}\text{C}$ |
| | JPt100 | -200.0 – 500.0 $^{\circ}\text{C}$ | | | |
| TC * ⁴ | K | -200.0 – 1372.0 $^{\circ}\text{C}$ | $\pm(0.02\% + 0.5^{\circ}\text{C})$ | 0.1 $^{\circ}\text{C}$ | |
| | E | -200.0 – 1000.0 $^{\circ}\text{C}$ | (-100 $^{\circ}\text{C}$ or greater) | | |
| | J | -200.0 – 1200.0 $^{\circ}\text{C}$ | $\pm(0.02\% + 1^{\circ}\text{C})$ (less than -100 $^{\circ}\text{C}$) | | |
| | T | -200.0 – 400.0 $^{\circ}\text{C}$ | $\pm(0.02\% + 0.5^{\circ}\text{C})$ | | |
| | N | -200.0 – 1300.0 $^{\circ}\text{C}$ | (0 $^{\circ}\text{C}$ or greater) | | |
| | L | -200.0 – 900.0 $^{\circ}\text{C}$ | $\pm(0.02\% + 1^{\circ}\text{C})$ | | |
| | U | -200.0 – 400.0 $^{\circ}\text{C}$ | (less than 0 $^{\circ}\text{C}$) | | |
| | R | 0 – 1768 $^{\circ}\text{C}$ | $\pm(0.02\% + 2.5^{\circ}\text{C})$ (less than 100 $^{\circ}\text{C}$) | 1 $^{\circ}\text{C}$ | |
| | S | | $\pm(0.02\% + 1.5^{\circ}\text{C})$ (100 $^{\circ}\text{C}$ or greater) | | |
| | B | | $\pm(0.02\% + 2^{\circ}\text{C})$ (less than 1000 $^{\circ}\text{C}$) $\pm(0.02\% + 1.5^{\circ}\text{C})$ (1000 $^{\circ}\text{C}$ or greater) | | |
| Frequency, pulse | 500 Hz | 1.0 – 500.0 Hz | $\pm 0.2 \text{ Hz}$ | 0.1 Hz | Output voltage: +0.1 to +15 V (zero base waveform) Amplitude accuracy: $\pm(5\% + 0.1 \text{ V})$ Maximum load current: 10 mA Contact output (with 0.0 V amplitude setting, FET switch ON/OFF) Maximum open/close voltage/current: +28 V/50 mA |
| | 1000 Hz | 90 – 1100 Hz | $\pm 1 \text{ Hz}$ | 1 Hz | |
| | 10 kHz | 0.9 kHz – 11.0 kHz | $\pm 0.1 \text{ kHz}$ | 0.1 kHz | |
| | Pulse cycle * ⁵ | 1 – 99,999 cycles | --- | 1 cycle | |

Temperature coefficient: Accuracy shown above $\times (1/5)^{\circ}\text{C}$

*1: Output up to 24 V/22 mA is possible when using the AC adapter.

*2: As per JIS C 1604 (ITS-90). IPTS-68 may be selected through internal settings (DIP switch).

*3: Excitation current: If less than 0.1 mA to 0.5 mA, then add [0.025/1s (mA)] Ω or [0.06/1s (mA)] $^{\circ}\text{C}$.

*4: As per JIS C 1602 (ITS-90) (L and U are DIN specs).

K, E, J, T, N, R, S, and B may be switched to IPTS-68 through internal settings (DIP switch) (L and U are not switched).

*5: Frequency (interval between one pulse and another) and amplitude during pulse cycle source may have the same range as during frequency source.

12. Specifications

(2) Measurement unit range and accuracy (for both CA51 and CA71)

Accuracy: \pm (% of reading + μ V, mV, μ A, Ω or dgt (digit))

| Parameter | Reference | Range | Accuracy (23 \pm 5°C per year) | Resolution | Remarks |
|---------------------|--------------|---------------------|-------------------------------------|---------------|---|
| DC voltage | 100 mV | 0 – \pm 110.00 mV | \pm (0.025% + 20 μ V) | 10 μ V | Input resistance: 10 M Ω or greater |
| | 1 V | 0 – \pm 1.1000 V | \pm (0.025% + 0.2 mV) | 0.1 mV | |
| | 10 V | 0 – \pm 11.000 V | \pm (0.025% + 2 mV) | 1 mV | Input resistance: Approx. 1 M Ω |
| | 100 V | 0 – \pm 110.00 V | \pm (0.05% + 20 mV) | 0.01 V | |
| DC current | 20 mA | 0 – \pm 24.000 mA | \pm (0.025% + 4 μ A) | 1 μ A | Input resistance: Approx. 14 Ω |
| | 100 mA | 0 – \pm 100.00 mA | \pm (0.04% + 30 μ A) | 10 μ A | |
| Resistance | 400 Ω | 0 – 400.00 Ω | \pm (0.05% + 0.1 Ω) | 0.01 Ω | Accuracy during 3-wire measurement |
| AC voltage | 1 V | 0 – 1.100 V | \pm (0.5% + 5 dgt) | 1 mV | Input resistance: Approx. 10 M Ω /10 pF Input frequency: 45 to 65 Hz Input voltage range: 10% to 100% Measurement method: Average value rectification |
| | 10 V | 0 – 11.00 V | | 0.01 V | |
| | 100 V | 0 – 110.0 V | \pm (0.5% + 2 dgt) | 0.1 V | Input resistance: Approx. 1 M Ω /10 pF |
| | 300 V | 0 – 300 V | | 1 V | |
| Frequency, pulse | 100 Hz | 1.00 – 100.00 Hz | \pm 2 dgt | 0.01 Hz | Maximum input: 30 V peak Input resistance: 200 k Ω or greater Sensitivity: 0.5 V peak or greater Contact input: Maximum 100 Hz Notes CPM: Counts per minute CPH: Counts per hour |
| | 1000 Hz | 1.0 – 1000.0 Hz | | 0.1 Hz | |
| | 10 kHz | 0.001 – 11.000 kHz | | 0.001 kHz | |
| | CPM | 0 – 99,999 CPM | --- | 1 CPM | |
| | CPH | 0 – 99,999 CPH | --- | 1 CPH | |

Temperature coefficient: Accuracy shown above \times (1/5) $^{\circ}$ C

(3) Measurement unit (temperature; CA71 only) range and accuracy

Accuracy: \pm (% of reading + $^{\circ}$ C)

| Parameter | Reference | Range | Accuracy (23 \pm 5°C per year) | Resolution | Remarks |
|-----------|-------------------------|----------------------------------|---|---------------------------------------|-----------------------------|
| TC *7 | K | -200.0 – 1372.0 $^{\circ}$ C | \pm (0.05% + 1.5 $^{\circ}$ C) (-100 $^{\circ}$ C or greater) | 0.1 $^{\circ}$ C | --- |
| | E | -200.0 – 1000.0 $^{\circ}$ C | | | |
| | J | -200.0 – 1200.0 $^{\circ}$ C | | | |
| | T | -200.0 – 400.0 $^{\circ}$ C | \pm (0.05% + 2 $^{\circ}$ C) (less than -100 $^{\circ}$ C) | 1 $^{\circ}$ C | |
| | N | -200.0 – 1300.0 $^{\circ}$ C | | | |
| | L | -200.0 – 900.0 $^{\circ}$ C | | | |
| | U | -200.0 – 400.0 $^{\circ}$ C | \pm (0.05% + 2 $^{\circ}$ C) (100 $^{\circ}$ C or greater) \pm (0.05% + 3 $^{\circ}$ C) (less than 100 $^{\circ}$ C) | 1 $^{\circ}$ C | |
| | R | 0 – 1768 $^{\circ}$ C | | | |
| | S | 0 – 1768 $^{\circ}$ C | | | |
| B | 600 – 1800 $^{\circ}$ C | \pm (0.05% + 0.6 $^{\circ}$ C) | 0.1 $^{\circ}$ C | Accuracy during 3-wire measurement | |
| RTD | Pt100 *6 | | | | -200.0 – 850.0 $^{\circ}$ C |
| | JPt100 | -200.0 – 500.0 $^{\circ}$ C | | | |

Temperature coefficient: Accuracy shown above \times (1/5) $^{\circ}$ C

*6: As per JIS C 1604 (ITS-90). IPTS-68 may be selected through internal settings (DIP switch).

*7: As per JIS C 1602 (ITS-90) (L and U are DIN specs).

K, E, J, T, N, R, S, and B may be switched to IPTS-68 through internal settings (DIP switch)
(L and U are not switched).

■ General Specifications

| | |
|---------------------------------------|---|
| Signal sourcing unit response time: | Approx. 1 second (time between start of voltage change and when voltage enters accuracy range) |
| Signal sourcing unit voltage limiter: | Approx. 32 V |
| Signal sourcing unit current limiter: | Approx. 25 mA |
| Divided output (n/m) function: | Output = setting × (n/m) n = 0 - m; m = 1 - 19; n ≤ m |
| Auto-step output function: | n value sent automatically when n/m function selection is selected (two options: approx. 2.5 seconds/step or approx. 5 seconds/step) |
| Sweep function: | Sweep time (two options: approx. 16 seconds or approx. 32 seconds) |
| Memory function: | 50 value sets (sourced and measured values are stored as value sets with the same address (up to 50 value sets can be stored)) |
| Measuring unit maximum input: | Voltage terminal: 100 VDC, 300 VAC Current terminal: 120 mA DC |
| Current terminal input protection: | Fuses: 100 mA/400 V |
| Measuring unit ground voltage: | Maximum 300 V AC |
| Measurement display updating rate: | Approximately once per second |
| Serial interface: | Enabled when communication cable (RS232) is connected; sold separately as optional accessory (CA71 only) |
| Display: | Segmented LCD (approx. 76 mm × 48 mm) |
| Backlight: | LED backlight; auto-off after one minute (from when LIGHT key is turned on) |
| Power supply: | Four AA-size (LR6) alkaline batteries, or special AC adapter (sold separately) |
| Battery life: | Measurement off, output 5 V DC/10 kΩ or greater: Approx. 40 hours Simultaneous signal source/measurement, output 5 VDC/10 kΩ or greater: Approx. 20 hours Simultaneous signal source/measurement, output 20 mA/5 V: Approximately 12 hours (using alkaline batteries, with backlight off) |
| Consumed power: | Approx. 7 VA (using 100 VAC adapter) |
| Insulation resistance: | Across input terminal and output terminal, 500 V DC, 50 MΩ or greater |
| Withstand voltage: | Across input terminal and output terminal, 3.7 kVAC, for one minute |

12. Specifications

| | |
|--|---|
| Operating temperature and humidity ranges: | 0 to 50°C, 20 to 80% RH (no condensation) |
| Storage temperature and humidity ranges: | -20 to 50°C, 90% RH or less (no condensation) |
| External dimensions: | Approx. 190 (W) × 120 (H) × 55 (D) mm |
| Weight: | Approx. 730 g (including batteries) |
| Standard accessories: | All of the following are included: Lead cables for source (one red, two black); 98020 Lead cables for measurement (one red, one black); RD031 Carrying case; 93016 Terminal adapter for CA71; 99021 User's manual; IM CA71-E AA-size (LR6) alkaline batteries; four units |
| Optional accessories (sold separately): | AC adapter; 94012 (100 V AC power supply) AC adapter; 94013 (120 V AC power supply) AC adapter; 94016-F (VDE), 94016-S (BS) (220–240 V AC power supply) RJ sensor; B9108WA (for reference junction compensation) Accessory carrying case; B9108XA Communication cable; 91017 |
| Spare parts: | Lead cables for source (one red, two black); 98020 Lead cables for measurement (one red, one black); RD031 Carrying case; 93016 Terminal adapter; 99021 Fuse; A1635EF (for current terminal input protection) |

| | |
|-------------------|---|
| Safety standards: | EN 61010-1, EN 61010-2-030, EN 61010-2-033 Measurement category III 300 V Lead cables for measurement (RD031): EN 61010-031 Indoor use, Operating altitude 2000 m or less, Pollution degree 2 |
| EMC standards: | EN 61326-1 Class B, EN 61000-3-2, EN 61000-3-3 EMC Regulatory Arrangement in Australia and New Zealand EN 55011 Class B Group1 Korea Electromagnetic Conformity Standard (한국 전자파적합성기준) Measurement error may temporarily occur under immunity environment. Conditions of EMC: Use AC adapter (94016) for AC220-240V, Lead cables for source (98020), Lead cables for measurement (RD031), RS232 Communication cable (91017) and RJ sensor (B9108WA): attach a sleeve clamp ferrite core (YOKOGAWA B9108WC, Moriimiya electric Co. MSFC6KEX) toward the main body of the instrument. |

12. Specifications

■ External Dimensions

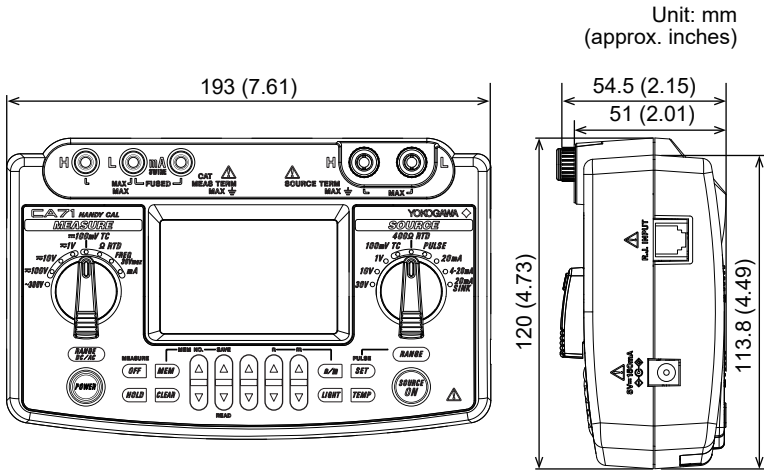

Note: This figure shows the CA71,
but there is no difference in exterior from the CA51.

13. Regulations and Sales in Various Countries and Regions

13.1 Disposal

When disposing of this instrument, follow the laws and ordinances of the country or region where the product will be disposed of.

13.2 For the Pollution Control of Electronic and Electrical Products of the People's Republic of China

This manual is valid only in China.

产品中有害物质的名称及含量

| 部件名称 | 有害物质 | | | | | |
|----------------------|-----------|-----------|-----------|------------------|---------------|-----------------|
| | 铅 (Pb) | 汞 (Hg) | 镉 (Cd) | 六价铬 (Cr (VI)) | 多溴联苯 (PBB) | 多溴二苯醚 (PBDE) |
| 框架 (塑料) | × | ○ | ○ | ○ | ○ | ○ |
| 线路板 ASSY | × | ○ | ○ | ○ | ○ | ○ |
| 导线 | × | ○ | ○ | ○ | ○ | ○ |
| 电池 | ○ | ○ | ○ | ○ | ○ | ○ |
| < 选购 > | | | | | | |
| RJC CABLE B9108WA | × | ○ | ○ | ○ | ○ | ○ |
| RS232 CABLE 91017 | × | ○ | ○ | ○ | ○ | ○ |

- : 表示该有害物质在该部件所有均质材料中的含量均在 GB/T 26572 规定的限量要求以下。
 × : 表示该有害物质至少在该部件的某一均质材料中的含量超出 GB/T 26572 规定的限量要求。

环保使用期限：该标识适用于 SJ/T11364 中所述，在中华人民共和国销售的电子电气产品的环保使用期限。只要您遵守该产品相关的安全及使用注意事项，在自制造日起算的年限内，则不会因产品中有有害物质泄漏或突发变异，而造成对环境的污染或对人体及财产产生恶劣影响。



注)
 该年数为“环保使用期限”，并非产品的质量保证期。
 零件更换的推荐周期，请参照使用说明书。

Appendix 1 Reference Junction Compensation

Standard thermocouple tables give 0°C as the temperature of the reference junction. Normally, the input terminal part (reference junction) of a thermometer (device under calibration) is at room temperature. (This results in an error equivalent to the difference between 0°C and room temperature.)

Reference junction compensation means measuring (detecting) the temperature of the reference junction, calculating the temperature difference (difference of thermoelectromotive force) from 0°C, and then carrying out compensation based on the result.

Use an external RJ sensor (or the built-in RJ sensor) for measuring (detecting) the temperature of the reference junction.

■ Using an External RJ Sensor

Use an external RJ sensor to measure (detect) the temperature of the thermometer, and compensates thermoelectromotive force.

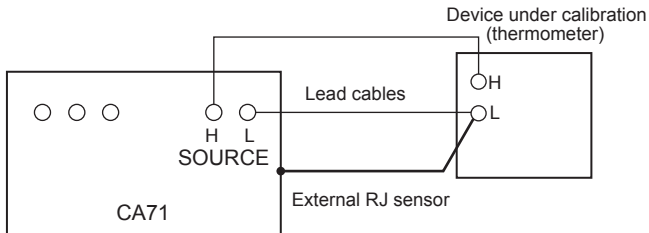

<Calibration of thermometer>

■ **Using a Cold Junction Compensator**

A cold junction compensator can be used when, for example, it is not possible to use an RJ sensor. The use of a cold junction compensator enables the reference junction to be 0°C.

Cold junction compensator: Yokogawa T-MJ or the equivalent

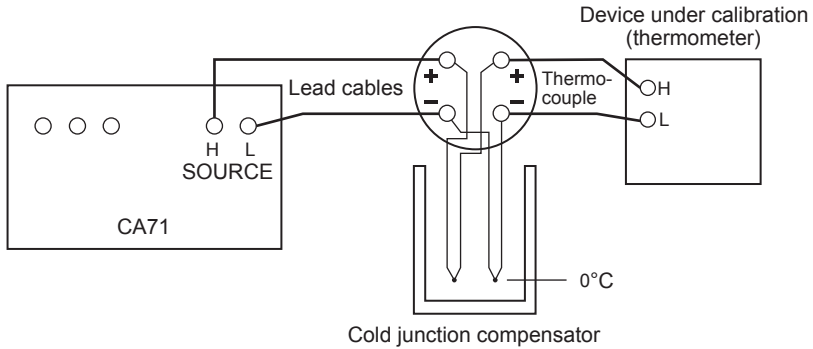

<Using a cold junction compensator>

■ **Using a built-in RJ Sensor**

When a built-in RJ sensor is used, a difference in temperature may exist between the terminal of the calibrator and the thermometer.

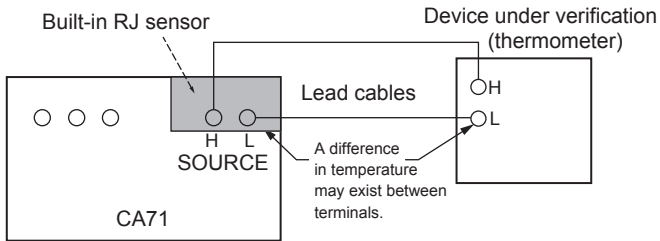

<Using a built-in RJ sensor>

