User's Manual

CL150
Clamp-on Tester
クランプテスタ

IM CL150

保証書付

YOKOGAWA 

横河計測株式会社

Yokogawa Test & Measurement Corporation

IM CL150
2018.6 11版 (KYOU)

Contents

■ Precautions for Safety Use of the Instrument	i
1. Instrument Layout	1
2. Measurement	3
2.1 Preparation for Measurement	3
2.2 Current Measurement	3
2.2.1 AC Current Measurement (Normal Mode)	4
2.2.2 Peak Current Measurement (Peak Mode)	4
2.3 Voltage Measurement	5
2.3.1 DC Voltage Measurement	5
2.3.2 AC Voltage Measurement	5
2.4 Resistance Measurement	6
2.4.1 Resistance Measurement (Normal Mode)	6
2.4.2 Continuity Check (400Ω range fixed)	6
3. Other Functions	8
3.1 Sleep Function	8
3.2 Data Hold Function	8
3.3 OUTPUT Terminal (For current measurement only)	9
3.4 Optional Accessories	10
4. Battery Replacement	11
5. Specifications	12
6. Calibration and After-sales Service	15

■ Precautions for Safe Use of the Instrument

When handling the instrument, ALWAYS observe all of the cautionary notes on safety given below. Yokogawa M&C Corporation is not at all liable for damage resulting from misuse of this product by the user that is contrary to these cautionary notes.

Various symbols are used on the instrument and in this manual to ensure the product is used safely and to protect operators and property from possible hazards or damage. The following safety symbols are used where appropriate. Read the explanations carefully and familiarize yourself with the symbols before reading the text.

The instrument and this manual use the following safety symbols:

Danger! Handle with Care.



This symbol indicates that the operator must refer to an explanation in the User's Manual in order to avoid the risk of personal injury or death and/or damage to the instrument.



Double Insulation

This symbol indicates double insulation.



AC Voltage/Current

This symbol indicates AC voltage or current.



DC Voltage/Current

This symbol indicates DC voltage or current.



Ground

This symbol indicates ground (earth)



This symbol indicates that this instrument can clamp on bare conductors when measuring a voltage corresponding to the applicable Measurement category, which is marked next to this symbol.



WARNING

Indicates that there is a possibility of serious personal injury or loss of life if the operating procedure is not followed correctly and describes the precautions for avoiding such injury or loss of life.



CAUTION

Indicates that there is a possibility of serious personal injury or damage to the instrument if the operating procedure is not followed correctly and describes the precautions for avoiding such injury or damage.

NOTE

Draws attention to information essential for understanding the operation and features.

 **WARNING**

- Never make measurement on a circuit above 750V AC or 1000V DC.
- Do not use the instrument in an atmosphere where any flammable or explosive gas is present.
- Do not attempt to make measurement in the presence of flammable gasses, fumes, vapor or dust. Otherwise, the use of the instrument may cause sparking, which can lead to an explosion.
- Avoid using the instrument if it has been exposed to rain or moisture or if your hands are wet.
- Do not exceed the maximum allowable input of any measurement range.
- Never open the battery compartment cover when making measurement.
- Do not use the instrument if there is any damage to the casing or when the casing is removed.
- Do not turn the Function Selector switch with plugged in test leads connected to the circuit under test.
- Do not install substitute parts or make any modification to the instrument. Return the instrument to Yokogawa Meter & Instruments or your distributor for repair or re-calibration.
- Always switch off the instrument before opening the battery compartment cover for battery replacement.
- Do not use the test leads that have deteriorated or are defective.
- Check the test leads continuity

 **WARNING**

To avoid damage to the instrument or electric shock!

The restrictions on the maximum voltage level for which the CL150 testers can be used, depend on the measurement categories specified by the safety standards. These category specifications are formulated to protect operators against transient impulse voltage in power lines.

Function	Maximum Allowable Input	
	MEASUREMENT CATEGORY II	MEASUREMENT CATEGORY III
~ A	AC 2000A rms Measuring circuit voltage : AC 750V rms	AC 2000A rms Measuring circuit voltage : AC 600V rms
~ V, = V	AC 750V rms/DC 1000V	AC 600V rms/DC 600V
Input terminal-to-ground voltage	AC 750V rms/DC 1000V	

O (None, Other)

Other circuits that are not directly connected to MEAINS.

Measurement category II (CAT.II)

Local level, appliance, portable equipment etc., with smaller transient over-voltages than CAT.III.

Measurement category III (CAT.III):

Distribution level, fixed installation, with smaller transient over-voltages than CAT.IV.

CAUTION

- Always make sure to insert each plug of the test leads fully into the appropriate terminal on the instrument.
 - Make sure to remove the test leads from the instrument before making current measurement.
 - Be sure to set the Function Selector switch to the "OFF" position after use. When the instrument will not be in use for a long period of time, Place it in storage after removing the battery.
 - Use a damp cloth and detergent for cleaning the instrument. Do not use abrasives or solvents.
-
-

NOTE

- Radiation immunity affects the accuracy of CL150 testers under the conditions specified in EN 61000-4-3.
- If equipment generating strong electromagnetic interference is located nearby, the testers may malfunction.

1. Instrument Layout

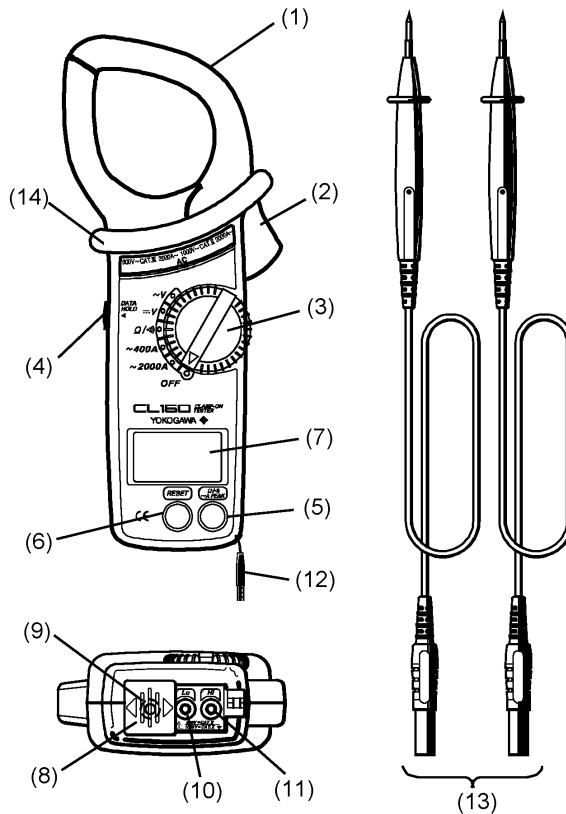

- (1) Transformer Jaws : Pick up current flowing through the conductor.
- (2) Open/Close Lever : Operates the transformer jaws. Press to open the Transformer Jaws.
- (3) Function Selector Switch : Selects ranges. Also used to power the instrument on.
- (4) Data Hold Button : Freezes the display reading. "H" is shown on the display when Data Hold is enabled.
- (5)  Mode Selector Button : On a AC current ("~ 400A" or "~ 2000A" or the resistance (Ω/\bullet)) range. Press the mode button to cycle through the measurement modes. The instrument is initially set to the normal mode and can be switched to peak or continuity check mode by means of the mode button.

A / V (ACA/ACV)	Display	Ω / \cdot) (Resistance/Continuity)	Display
Normal ↓ Peak	PEAK	Resistance ↓ Continuity check	Ω \cdot)

- (6) **RESET** Button : Reset the measurement in peak mode.
- (7) LCD Display : Field effect type of liquid crystal display with maximum counts of 4000. Function symbols and decimal point are controlled by the microprocessor based on the selected function and measuring mode.

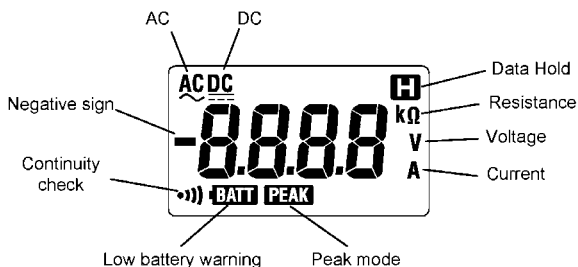

- (8) Terminal Cover : Slides over Hi and Lo Terminals to prevent access to them when OUTPUT terminal is in use.
- (9) OUTPUT Terminal (For " ~ 400A" or " ~ 2000A" range only) : Provides DC voltage output in proportion to the AC or DC current reading. (See section 3.3, OUTPUT Terminal.) The out-put is connected to a recording device such as a chart recorder for long hour monitoring. No output is available on voltage and resistance ranges.
- (10) Lo Terminal : Accepts the black test lead for voltage or resistance measurement.
- (11) Hi Terminal : Accepts the red test lead for voltage or resistance measurement.
- (12) Safety Hand Strap : Prevents the instrument from slipping off the hand during use.
- (13) Test Leads (Model 98072) : Connected to Lo and Hi terminals for voltage or resistance measurement.
- (14) Barrier: It is a part providing protection against electrical shock and ensuring the minimum required air and creepage distances.

2. Measurement

2.1 Preparation for Measurement

CAUTION

- The jaw section is a delicate, precision sensor. Do not subject the jaw to unreasonably strong shock, vibration, or force when using it.
- If dust gets into the tops of the jaws, remove it immediately. Do not close the jaws when dust is trapped in its joints as the sensor may break.
- Please check that the function and mode are set to the desired setting before measurement.

2.2 Current Measurement

WARNING

- Do not make measurement on a circuit above 750VDC. This may cause shock hazard or damage to the instrument or equipment under test.
- Do not make current measurement with the test leads connected to the Hi and Lo terminals.
- When measuring current is not less than 1000A, make sure to stop measurement within the maximum measuring time shown below. Otherwise, transformer jaws may heat to cause a fire or deformation of molded parts, which will degrade insulation.
1000 to 1500A : 15min. 1500 to 2000A : 5min.
- Keep your fingers and hands behind the barrier during measurement.

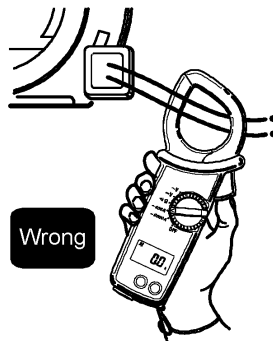
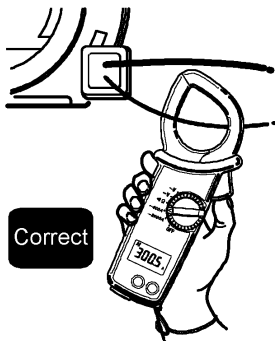



2.2.1 AC Current Measurement (Normal Mode)

- (1) Set the Function Selector switch to the " $\sim 400A$ " or " $\sim 2000A$ " position. "AC" should be shown on the upper left corner of the display.
- (2) Press the open/close lever to open the transformer jaws and clamp them onto the conductor under test, then take the reading on the display. The most accurate reading will be obtained by keeping the conductor at the center of the transformer jaws.

NOTE

- During current measurement, keep the transformer jaws fully closed. Otherwise, accurate measurement cannot be made. The maximum measurable conductor size is approx. 54.5mm in diameter.
- The transformer jaws may buzz when measuring large current. This has no effect on the instrument's performance or safety.

2.2.2 Peak Current Measurement (Peak Mode)

- (1) Set the Function Selector switch to the " $\sim 400A$ " or " $\sim 2000A$ " position.
- (2) Press the  button once to enter from the normal mode to the PEAK mode. "PEAK" should be shown on the display.
- (3) Press the open/close lever to open the transformer jaws and clamp them onto the conductor under test. Then, press the .
- (4) The display shows the current's crest value divided by the square root of two. Therefore, when the current is sinusoidal, the reading equals RMS value.
- (5) To reset the display, press the .

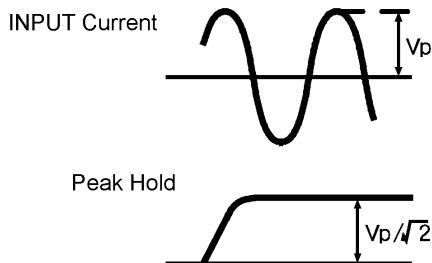

- (6) After the measurement is over, press the  button to return to the normal mode.

NOTE

- In the Peak measurement mode, the data hold feature is disabled.
- In the Peak measurement mode, the response time is 10ms.

2.3 Voltage Measurement

WARNING

Do not make measurement on a circuit above 750V AC or 1000V DC. This may cause shock hazard or damage to the instrument or equipment under test.

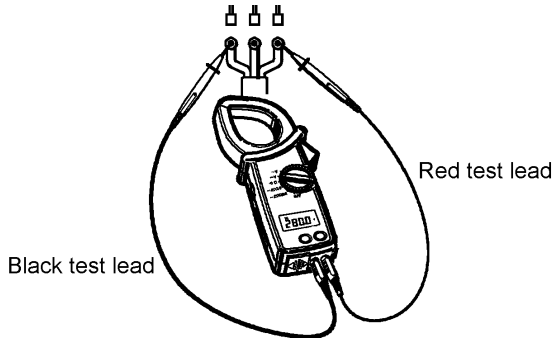

2.3.1 DC Voltage Measurement

- (1) Set the Function Selector switch to the " V " position. "DC" should be shown on the upper left corner of the display.
- (2) Slide the terminal cover to the left to disclose the Hi and Lo terminals. Plug the red test lead into the Hi terminal and the black test lead into Lo terminal.
- (3) Connect the tip of the red and black test leads to the positive (+) and negative (-) sides of the circuit under test respectively. Take the reading on the display.

2.3.2 AC Voltage Measurement

- (1) Set the Function Selector switch to the " V " position. "AC" should be shown on the upper left corner of the display.
- (2) Slide the terminal cover to the left to disclose the Hi and Lo terminals. Plug the red test lead into the Hi terminal and the black test lead into Lo terminal.
- (3) Connect the tip of the test leads to the circuit under test respectively. Take the reading on the display.

NOTE

For high sensitivity, there are parts which do not indicate "0".

2.4 Resistance Measurement (Normal Mode)

WARNING

Never use the instrument on an energized circuit.

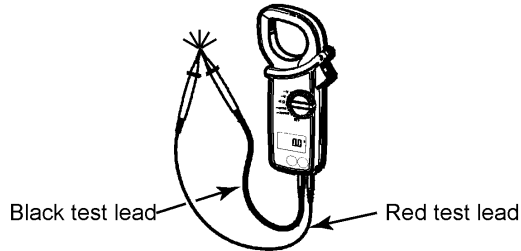

2.4.1 Resistance Measurement (Normal Mode)

- (1) Set the Function Selector switch to the " Ω/diode " position. The " Ω " should be shown on the upper right corner of the display.
- (2) Slide the terminal cover to the left to disclose the Hi and Lo terminals. Plug the red test lead into the Hi terminal and the black test lead into the Lo terminal. Check that "OL" (over indication) is indicated on the LCD display.
- (3) Short the tip of the test leads and check whether the display reads "0".
- (4) Connect the tip of the test leads to the circuit under test respectively. Take the reading on the display.

NOTE

When shorting the tip of the test leads, the display may read a very small resistance instead of "0". This is the resistance of the test leads on the display.

2.4.2 Continuity Check (400 Ω range fixed)

The continuity check mode is enabled by pressing the  button on resistance range. " diode " and " Ω " is indicated on the display to show the instrument in the continuity check mode. The buzzer beeps, if the resistance under test is 50 Ω or less.

- (1) Set the Function Selector switch to the " Ω/diode " position.
- (2) Slide the terminal cover to the left to disclose the Hi and Lo terminals. Plug the red test lead into the Hi terminal and the black test lead into the Lo terminal. Check that "OL" (over indication) is indicated on the LCD display.

- (3) Press the  button once to enter from the normal mode to the continuity check mode. " ••• " should be indicated on the display.
- (4) Short the tip of the test leads and check whether the display reads "0".
- (5) Connect the tip of the test leads to the circuit under test. If the resistance is 50 Ω or less, the buzzer beeps.

NOTE

When shorting the tip of the test leads, the display may read a very small resistance instead of "0". This is the resistance of the test leads on the display.

3. Other Functions

3.1 Sleep Function

This is a function to prevent the instrument from being left powered on in order to conserve battery life. This function causes the instrument to enter the Sleep (powered-down) mode about 10 minutes after the last switch or button operation.

To exit the Sleep mode, press the Data hold, **RESET** button or **DATA PEAK** button or turn the Function Selector switch back to "OFF", then to any other position, or press any button.

The current is consumed a little in the Sleep mode.

How to Exit the Sleep Mode

Turn the Function Selector switch from "OFF" to another position with the data hold function button pressed. Then, "P.OFF" is shown on the display. This disables the sleep function and enables continuous use of the instrument.

NOTE

- Connecting the plug to the OUTPUT terminal disables the Sleep function. The function is enabled on removing the plug from the terminal.
- The Sleep function is disabled in the PEAK measurement mode.

3.2 Data Hold Function

This is a function used to freeze the measured value on the display. Press the Data Hold button to freeze the reading. The reading will be held regardless of subsequent variation in input. " **H** " is shown on the upper right corner of the display while the instrument is in the Data Hold mode.

To exit the Data Hold mode, press the Data Hold button again.

NOTE

- The Data hold function is disabled in the peak measurement mode on the AC current range.
- When the Sleep function is activated, the Data hold mode turns to the normal mode.

3.3 OUTPUT Terminal (For current ranges only)

WARNING

- Never use the instrument on a circuit above 750VAC or 1000VDC. This may cause electrical shock hazard and damage to the instrument or the circuit under test.
- Never apply voltage to the OUTPUT terminal.

Only on the " 400A" or " 2000A" range, DC voltage proportional to the input current is output from the OUTPUT terminal.

- (1) Attach the output plug cable (sold separately : 98076 or 98077) to a connection lead so that the output voltage can be connected to a recording device such as a chart recorder.
- (2) Slide the terminal cover to the right to disclose the OUTPUT terminal and insert the output plug into the terminal. Make connection to the recording device.

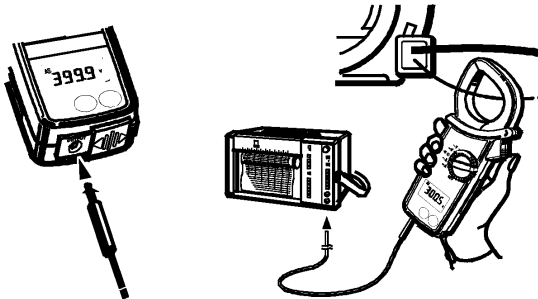

- (3) Set the Function Selector switch to the " 400A" or " 2000A" position and follow appropriate measurement instructions.

NOTE

- Output voltage is 1mV/A on the " ~ 400A" range and 0.1mV/A on the " ~ 2000A" range. Set an appropriate input sensitivity on the recorder.
- The peak hold function does not apply to the recorder output even if the instrument is in the peak hold mode.
- For long term measurement, disable the sleep function.

3.4 Optional Accessories

Clamp Adapter Model 99025 (For AC current measurement only)

The clamp adapter (99025) has been discontinued.

The clamp adapter (99025) is designed to increase the measuring capability of a clamp meter. With the use of the Clamp Adapter, you can not only extend current range over 3000A, but also clamp on a large bus-bar or conductor.

- (1) Set the Function Selector switch to the " \sim A" position.
- (2) As shown in the figure below, clamp Model CL150 onto the pickup coil of Model 99025.
- (3) Clamp Model 99025 onto the bus-bar or conductor under test.
- (4) Take the reading on Model CL150 and multiply it by 10.

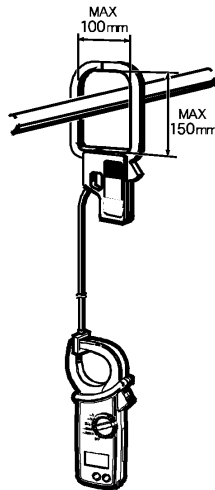

4. Battery Replacement

WARNING

To avoid electric shock hazard, make sure to set the Function Selector switch to "OFF" and remove the test leads from the instrument before trying to replace battery.

CAUTION

- Do not mix new and old batteries.
 - Make sure to install battery in correct polarity as indicated in battery compartment.
-

If the battery voltage becomes too low for the instrument to operate normally, " **BATT** " is shown on the display. Then, replace the battery. Note that when the battery is completely exhausted, the display blanks without " **BATT** " shown.

- (1) Set the Function Selector switch to the "OFF" position.
- (2) Unscrew and remove the battery compartment on the bottom of the instrument.
- (3) Replace the battery observing correct polarity. Use two new R6P batteries.
- (4) Re-place and screw the battery compartment cover.

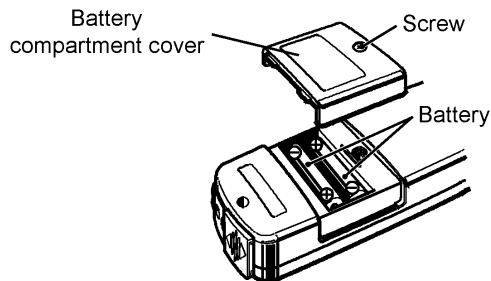

5. Specifications

■ Instrument Specifications

● Measuring Ranges and Accuracy (at $23 \pm 5^\circ\text{C}$, 45 to 75% relative humidity)

AC Current $\sim 400\text{A}$, $\sim 2000\text{A}$

Ranges	Measuring range	Resolution	Accuracy (frequency range)	Maximum Measurement Time
400A	0 to 400.0A	0.1A	$\pm 1.0\% \text{ rdg} \pm 3\text{dgt}$ (50/60Hz) $\pm 2.0\% \text{ rdg} \pm 3\text{dgt}$ (40 to 1kHz)	Continuous
2000A	0 to 1000A	1A	$\pm 1.0\% \text{ rdg} \pm 3\text{dgt}$ (50/60Hz)	
	1000 to 1500A		$\pm 3.0\% \text{ rdg} \pm 3\text{dgt}$ (40 to 1kHz)	15min.
	1500 to 2000A		$\pm 3.0\% \text{ rdg}$ (50/60Hz)	5min.

AC Voltage ($\sim \text{V}$) Auto-ranging

Ranges	Measuring range	Resolution	Accuracy
40V	0 to 40.00V	0.01V	$\pm 1.0\% \text{ rdg} \pm 2\text{dgt}$ (50/60Hz) $\pm 1.5\% \text{ rdg} \pm 3\text{dgt}$ (40 to 1kHz)
400V	15.0 to 400.0V	0.1V	
750V	150 to 750V	1V	

Initially set to the 40V range. Input impedance is about $1\text{M}\Omega$.

DC Voltage (= V) Auto-ranging

Ranges	Measuring range	Resolution	Accuracy
40V	0 to $\pm 40.00\text{V}$	0.01V	$\pm 1.0\% \text{ rdg} \pm 2\text{dgt}$
400V	15.0 to $\pm 400.0\text{V}$	0.1V	
1000V	150 to $\pm 1000\text{V}$	1V	

Initially set to the 40V range. Input impedance is about $1\text{M}\Omega$.

Resistance (Auto-ranging)

Ranges	Measuring range	Resolution	Accuracy
400 Ω	0 to 400.0 Ω	0.1 Ω	$\pm 1.5\% \text{ rdg} \pm 2\text{dgt}$
4k Ω	0.15 to 4.000k Ω	1 Ω	
40k Ω	1.50 to $\pm 40.00\text{k}\Omega$	10 Ω	
400k Ω	15.0 to $\pm 400.0\text{k}\Omega$	100 Ω	

Initially set to the 400 Ω range. In the continuity check mode, fixed to the 400 Ω range and when the reading is not more than $.50 \pm 35\Omega$, the buzzer beeps.

OUTPUT (AC Current Ranges)

DC Output : 100.0mV per 1000 counts (Output impedance : about 10k Ω)

Ranges	Measuring range	Accuracy (Frequency Range)
400A	0 to 400.0mV/0 to 400A	$\pm 1.5\%$ rdg ± 0.5 mV (50/60Hz) $\pm 2.5\%$ rdg ± 0.5 mV (40 to 1kHz)
2000A	0 to 150.0mV/0 to 1500A	$\pm 1.5\%$ rdg ± 0.5 mV (50/60Hz) $\pm 3.5\%$ rdg ± 0.5 mV (40 to 1kHz)
	150.0 to 200.0mV/1500 to 2000A	$\pm 3.5\%$ rdg (50/60Hz)

■ General Specifications

- Operating System : Dual integration
- Measurement Function : AC current, DC current, AC voltage, resistance, continuity check
- Display : Liquid crystal display with maximum counts of 4000
- Overrange Indication : "OL" is shown on the display
- Response Time : Approx. 2 seconds.
- Temperature and Humidity for Guaranteed Accuracy : 23°C \pm 5°C , relative humidity 45 to 75% without condensation
- Operating Temperature and Humidity : 0 to 40°C , relative humidity up to 85% without condensation
- Storage Temperature and Humidity : -20 to 60°C , relative humidity up to 85% without condensation
- Effect of conductor position : Within $\pm 2.0\%$ rdg, ± 3 dgt to a 10 mm-dia conductor, at every part inside the jaws
- Effect of external magnetic field : 1A or less in AC or DC magnetic field of 400 A/m
- Power Source : Two R6P 1.5V battery
- Battery Life : Approx. 150 hours (continuity)
- Current Consumption : Approx. 5mA max. (Sleep function : Approx. 20 μ A)
- Sleep function : Automatically powered down in Approx. 10 minutes after the last switch operation
- Withstanding Voltage : 6300V AC, 50/60Hz for 5 sec. between electrical circuit and housing case or metal part of the jaws
- Insulation Resistance : 10M Ω or greater at 1000V between electrical circuit and housing case or metal part of the jaws
- Conductor Size : Approx. 54.5mm diameter max.
- Dimensions : Approx.105(W) x 247(H) x 49(D) mm
- Weight : Approx. 470g (with batteries)

- Safety Standard: EN 61010-1, EN 61010-2-033
EN 61010-031, EN 61010-2-032
AC/DC 600V CAT III, AC/DC 1000V CAT II,
Pollution degree2, indoor use, altitude 2000m or less
- EMC Standard : EN 61326-1, EN 61326-2-1
- Radiation immunity : EN 61000-4-3
- Environmental standard : EN 50581
- Accessories : Test leads Model 98072 1set
R6P batteries 2
Carrying case Model 93034 1
User's Manual 1
- Optional Accessories : Output cable Model 98076
Output cable (for terminal screw) Model 98077

6. Calibration and After-sales Service

Should any failure occur while you are using the tester, follow the instructions given below. If the tester still fails to operate correctly and needs repair, contact the vendor from whom you purchased the instrument or the nearest Yokogawa Meters & Instruments sales office.

- Turn off the POWER switch once, then turn it back on again.
- If the tester does not turn on, replace the battery with a new one.

Calibration

It is recommended that the instrument be calibrated once every year.

Waste Electrical and Electronic Equipment (WEEE), Directive

(This directive is valid only in the EU.)

This product complies with the WEEE directive marking requirement.

This marking indicates that you must not discard this electrical/electronic product in domestic household waste.

Product Category

With reference to the equipment types in the WEEE directive, this product is classified as a “Monitoring and control instruments” product.

When disposing products in the EU, contact your local

Yokogawa Europe B.V. office.

Do not dispose in domestic household waste.



This User's Manual explains the Prevention of Pollution Control of Electronic Equipmen Method in China. This manual is valid only in China.

产品中有害物质的名称及含量

部件名称	有害物质					
	铅 (Pb)	汞 (Hg)	镉 (Cd)	六价铬 (Cr (VI))	多溴联苯 (PBB)	多溴二苯醚 (PBDE)
框架 (塑料)	○	○	○	○	○	○
线路板 ASSY	×	○	×	○	○	○
导线	×	○	○	○	○	○
电池	×	○	○	○	○	○

○：表示该有害物质在该部件所有均质材料中的含量均在GB/T 26572规定的限量要求以下。

×：表示该有害物质至少在该部件的某一均质材料中的含量超出GB/T 26572规定的限量要求。

环保使用期限：



该标识适用于 SJ/T11364 中所述，在中华人民共和国销售的电子电气产品的环保使用期限。

只要您遵守该产品相关的安全及使用注意事项，在自制造日起算的年限内，则不会因产品中有害物质泄漏或突发变异，而造成对环境的污染或对人体及财产产生恶劣影响。

