

---

**User's  
Manual**

**CW500  
Power Quality Analyzer  
User's Manual**

Thank you for purchasing the CW500 Power Quality Analyzer. This user's manual explains the features and operating procedures of the CW500. To ensure correct use, please read this manual thoroughly before beginning operation. Keep this manual in a safe place for quick reference in the event that a question arises.

The following five manuals, including this one, are provided as manuals for the CW500.

Please read all manuals.

Manual Title	Manual No.	Description
CW500 Power Quality Analyzer User's Manual	IM CW500-01EN	This guide. This manual explains the CW500's standard features and how to use these features.
Application Software User's Manual	IM CW500-61EN	The supplied CD contains the PDF file of this manual. This manual explains how to use the application software.
CW500 Power Quality Analyzer Getting Started Guide	IM CW500-02EN	The guide explains the handling precautions and basic operations of the CW500 and provides a list of specifications.
Application Software Installation Manual	IM CW500-62JA	This manual describes how to install the application software.
CW500 Power Quality Analyzer User's Manual	IM CW500-92Z1	Chinese document

The "-EN" in the manual number is the language code.

Contact information of Yokogawa offices worldwide is provided on the following sheet.

Manual No.	Description
PIM113-01Z2	List of worldwide contacts

## Notes

- The contents of this manual are subject to change without prior notice as a result of continuing improvements to the software's performance and functionality. The figures given in this manual may differ from those that actually appear on your screen.
- Every effort has been made in the preparation of this manual to ensure the accuracy of its contents. However, should you have any questions or find any errors, please contact your nearest YOKOGAWA dealer.
- Copying or reproducing all or any part of the contents of this manual without the permission of YOKOGAWA is strictly prohibited.
- 

## Trademarks

- Microsoft, Windows, Windows 7, and Windows 8 are either registered trademarks or trademarks of Microsoft Corporation in the United States and/or other countries.
- Adobe, Acrobat, and PostScript are either registered trademarks or trademarks of Adobe Systems Incorporated.
- In this manual, the TM and ® symbols do not accompany their respective registered trademark or trademark names.
- Other company and product names are trademarks or registered trademarks of their respective companies.

## Revisions

September 2015

1st Edition

---

# Contents

## Chapter 1 Product Outline

1.1	Feature Outline .....	1-1
1.2	Features.....	1-3
1.3	System Configuration Diagram.....	1-5
1.4	Measurement Procedure .....	1-6

## Chapter 2 Component Names

2.1	Display (LCD) and Control Keys.....	2-1
2.2	Connectors .....	2-2
2.3	Side Panel .....	2-3
2.4	Voltage Probe and Current Clamp-on Probe .....	2-4

## Chapter 3 Basic Operation

3.1	Description of Control Keys .....	3-1
3.2	Marks Displayed in the Top Area of the LCD .....	3-3
3.3	Display Symbols .....	3-4
3.4	Backlight and Contrast Adjustment.....	3-5
3.5	Screens and Screen Configuration.....	3-6

## Chapter 4 Recording

4.1	Starting and Stopping Recording.....	4-1
4.2	Starting to Record with “Quick start guide” .....	4-3

## Chapter 5 Setup

5.1	Settings.....	5-1
5.2	Basic Setup.....	5-2
5.3	Measurement Setup .....	5-12
5.4	Recording Setup .....	5-25
5.5	Other Settings.....	5-31
5.6	Saved Data .....	5-36



**Chapter 6 Display Items of Each Screen**

6.1 Instantaneous Value (W) .....6-1  
6.2 Integrated Value (Wh).....6-9  
6.3 Demand .....6-11  
6.4 Vector.....6-14  
6.5 Waveform.....6-17  
6.6 Harmonics.....6-19  
6.7 Power Quality .....6-25

**Chapter 7 Other Features**

7.1 Other Features.....7-1

**Chapter 8 Connecting to Peripheral Devices**

8.1 Transferring Data to a PC .....8-1  
8.2 Signal Control with External Devices.....8-2  
8.3 Supplying Power through Measurement Lines .....8-5

**Chapter 9 PC Software for Configuration and Analysis**

9.1 PC Software for Configuration and Analysis.....9-1

**Chapter 10 Troubleshooting**

10.1 Troubleshooting .....10-1  
10.2 Error Messages and Corrective Actions .....10-3

**Appendix**

When Using 96030, 96033, or 96036 ..... App-1

**Index**

# 1.1 Feature Outline

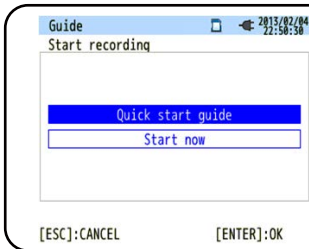

## Starting and Ending Recording

Start recording normally or start by following the Quick Start Navigation, which guides you through the necessary setup for recording. See “Starting and Stopping Recording.”

## Displaying Instantaneous, Integrated, and Demand

Displays instantaneous, average, maximum and minimum values for current, voltage, active power, apparent power, and reactive power. Switch the screen to display integrated values. Set a demand target value and display the demand values from start to finish. See “Displaying Instantaneous, Integrated, and Demand.”

W/Wh 2013/06/05 13:42:06

	1ch	2ch	3ch	
V :	596.7	445.6	499.1	V
A :	49.9	39.6	44.8	A
P :	29.78	17.68	26.78	kW
Q :	20.05	10.65	20.39	kvar
S :	29.78	17.68	26.78	kVA
PF :	0.798	0.785	0.795	

	Inst	Avg	Max	Min
P :	91.95 kW	f : 60.00 Hz		
Q :	57.23 kvar			
S :	91.95 kVA			
PF :	0.809	M : 39.6 A		
DC1 :	0 mV	DC2 : -0 mV	02:14	02:14
			30min	

W h Zoom Trend Customize

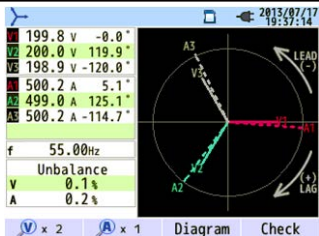
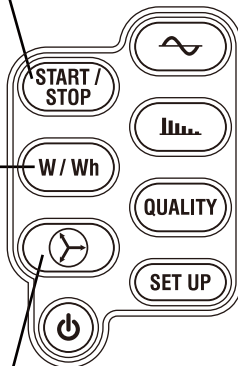

## Displaying Vectors and Checking the Wiring

Displays a vector diagram of voltage and current for the measurement channel and checks the wiring. See “Vector.”

### Displaying Waveforms

Displays waveforms of voltage and current for the measurement channel. See “Waveforms.”

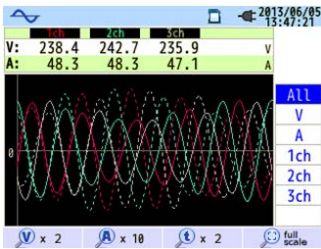

### Harmonic Analysis

Displays harmonic components superimposed on the voltage and current for the measurement channel. See “Harmonic Analysis.”

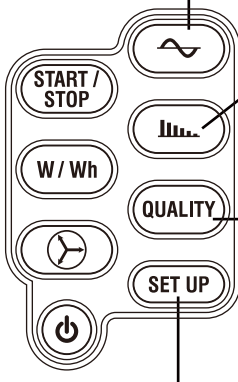
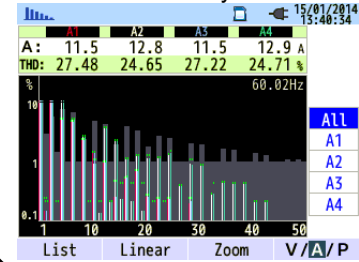

### Displaying Power Supply Quality Events

Displays the swell, dip, interruption, transient, inrush current, and flicker of the measured voltage. See “Power Supply Quality.”

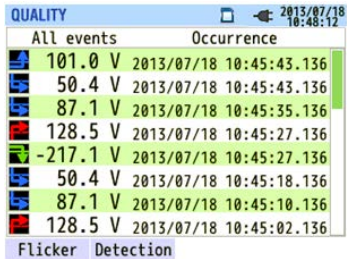

### Setup (SET UP)

Configures the CW500 and measurement. See “Setup.”

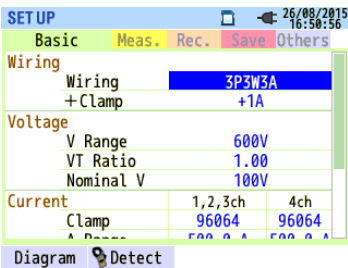

---

## 1.2 Features

This product is a clamp-type power quality analyzer that supports a variety of wiring systems. It simultaneously performs simulations of instantaneous values, integrated values, demand values for power management, harmonic analysis, power quality events, and phase lead capacitor values for improving the power factor. Voltage and current can be displayed as waveforms and vectors.

Measured data can be saved to files in SD memory cards or internal memory, and the files can be transferred to a PC through USB communication.

### **Safety Design**

This product complies with safety standard IEC 61010-1 CAT. IV 300V/ CAT. III 600V/CAT. II 1000V.

### **Power Quality Measurement**

This product supports international power quality measurement standard IEC61000-4-30 Class S. It can perform highly accurate frequency and rms voltage measurements and harmonic analysis as well as simultaneously measure without gaps swell, dip, interruption, transient, inrush current, and flicker that are necessary for capturing and monitoring power abnormalities.

### **Power Measurement**

This product can measure active, reactive, and apparent powers as well as watt-hour, power factor, rms current, phase angle, and neutral line current.

### **Wiring Systems**

This product supports single-phase two-wire (four systems), single-phase three-wire (two systems), three-phase three-wire (two systems), and three-phase four-wire measurement lines.

### **Demand Measurement**

You can monitor in a simplified form the usage condition so that the specified target value (contract demand) is not exceeded.

### **Waveform and Vector Displays**

Voltage and current can be displayed as waveforms and vectors.

### **Saving Measured Data**

This product is equipped with a logging function whose recording interval can be specified. Measured data can be saved manually or by specifying the date and time. Further, the print screen function can be used to save image data to SD memory cards.

### **Dual Power System**

This product can be driven by AC power or batteries. For batteries, AA alkaline batteries (LR6) or off-the-shelf rechargeable AA nickel-metal hydride batteries (Ni-MH) can be used. For rechargeable AA nickel-metal hydride (Ni-MH) batteries, use the battery manufacturer's charger to charge them. You cannot charge them on the CW500. If a power failure occurs while the CW500 is running off of AC power, the power supply is automatically switched to battery power.

### **Display Screen**

This product has a color TFT LCD.

### **Easy Wiring and Compact, Lightweight Design**

Wiring is easy as this product is a clamp type. Its compact, lightweight design makes it convenient to install and carry around.

### **Application**

Files saved in SD memory cards and internal memory can be downloaded to a PC through USB. Downloaded files can be analyzed easily using the accompanying PC software. It is also possible to configure the CW500 from a PC.

### **Auxiliary I/O Function**

The 2-channel analog input (DC voltage) can be used to simultaneously measure analog signals from thermometers, lux meters, and the like.

If a power quality event occurs, a contact signal can be sent to an alarm through the 1-channel digital output.

# 1.3 System Configuration Diagram

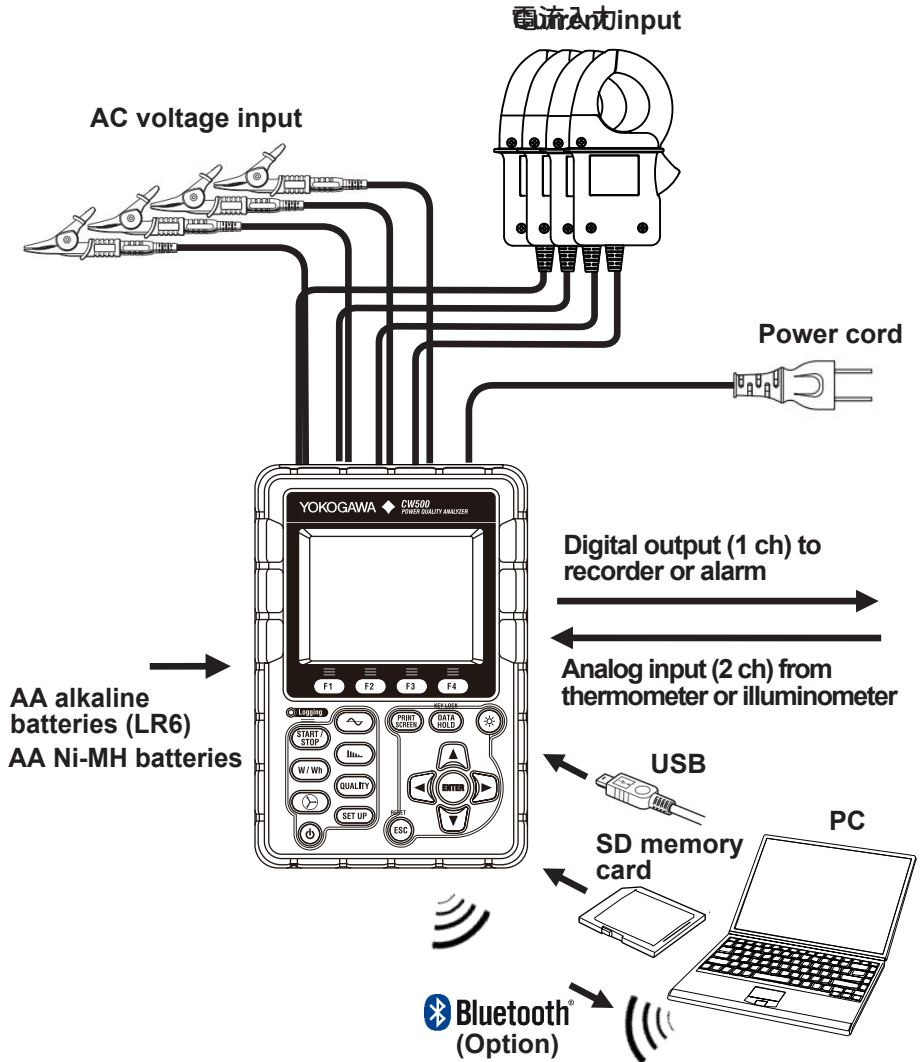

# 1.4 Measurement Procedure

**Measurement preparation**  
Getting Started Guide, “Making Preparations for Measurements” Page 5

**Connecting cords and sensors to the CW500**  
Getting Started Guide, “Connecting a Voltage Probe and Clamp-on Probe”  
Page 15

**Turning the power on**  
Getting Started Guide, “Power Supply” Page 7

**Setting common measurement items**  
5.2, “Basic Settings” Page 5-3

**Loading CW500 settings**  
5.6, “Save Data” Page 5-36

**Wiring measurement lines**  
Getting Started Guide, “Safety Precautions” Page vii

**Checking the wiring**  
6.4, “Vectors” Page 6-14

**Configuring measurement settings and save method**  
5.3, “Measurement Settings” Page 5-12 and 5.4, “Record Settings” Page  
5-25.

**Checking measured values**  
6.1, “Instantaneous Value W” Page 6-1 and 6.4, “Vectors” Page 6-14

**Starting and stopping recording**  
4.6, “Starting and Stopping Recording” Page 4-12

**Checking Measured Data**  
Chapter 6, “Display Items of Each Screen” Page 6-1

**Removing cords and sensors from the measurement line and turning the  
power off**

**Analyzing recorded data on a PC**  
8.1, “Transferring Data to a PC” Page 8-1  
Chapter 9, “PC Software for Configuration and Analysis” Page 9-1

## 2.1 Display (LCD) and Control Keys

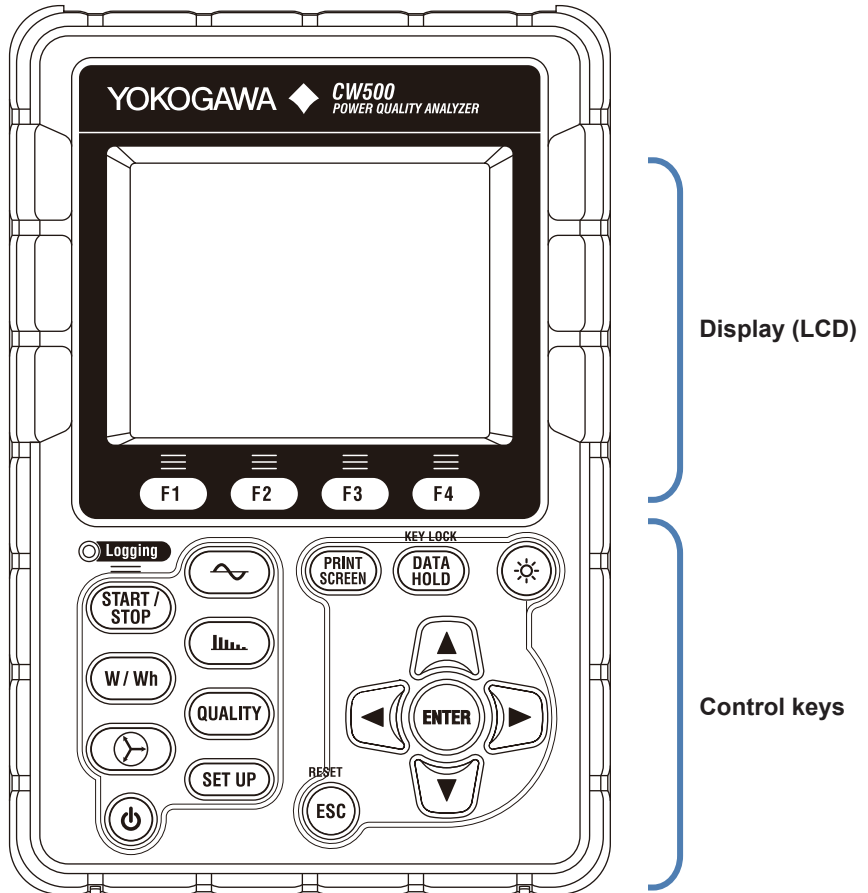



## 2.2 Connectors

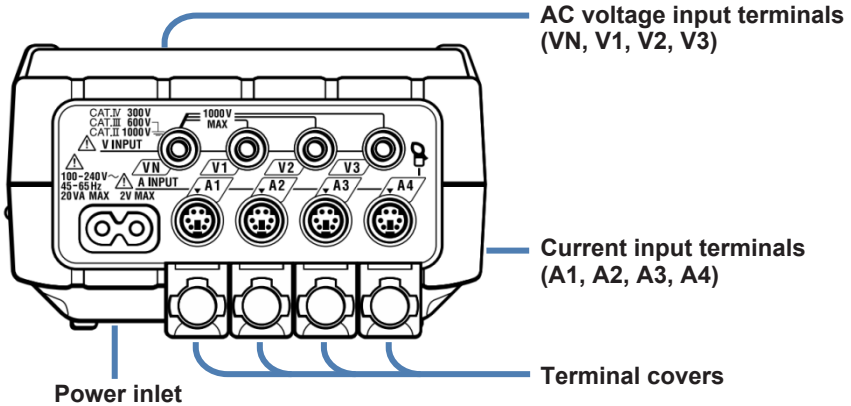

Wiring System		AC Voltage Input Terminal	Current Input Terminal*
Single-phase two-wire (1 system)	1P2W×1	VN, V1	A1
Single-phase two-wire (2 system)	1P2W×2	VN, V1	A1, A2
Single-phase two-wire (3 system)	1P2W×3	VN, V1	A1, A2, A3
Single-phase two-wire (4 system)	1P2W×4	VN, V1	A1, A2, A3, A4
Single-phase three-wire (1 system)	1P3W×1	VN, V1, V2	A1, A2
Single-phase three-wire (2 system)	1P3W×2	VN, V1, V2	A1, A2, A3, A4
Three-phase three-wire (1 system)	3P3W×1	VN, V1, V2	A1, A2
Three-phase three-wire (2 system)	3P3W×2	VN, V1, V2	A1, A2, A3, A4
Three-phase three-wire 3A	3P3W3A	V1, V2, V3	A1, A2, A3
Three-phase four-wire	3P4W×1	VN, V1, V2, V3	A1, A2, A3

\* Current terminals that are not used in wiring can measure only rms values and harmonics.

## 2.3 Side Panel

### With the Connector Cover Closed

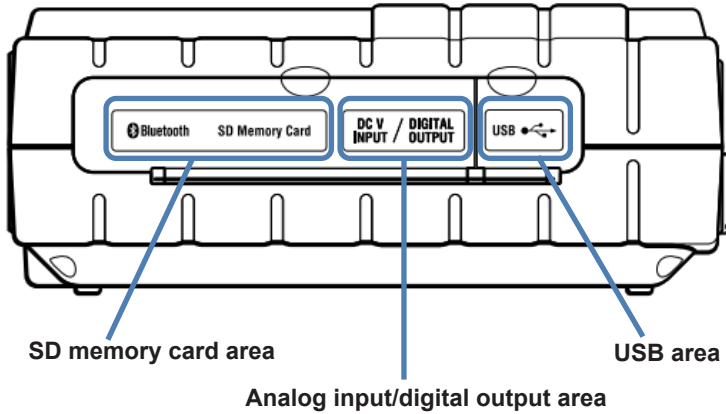

### With the Connector Cover Open

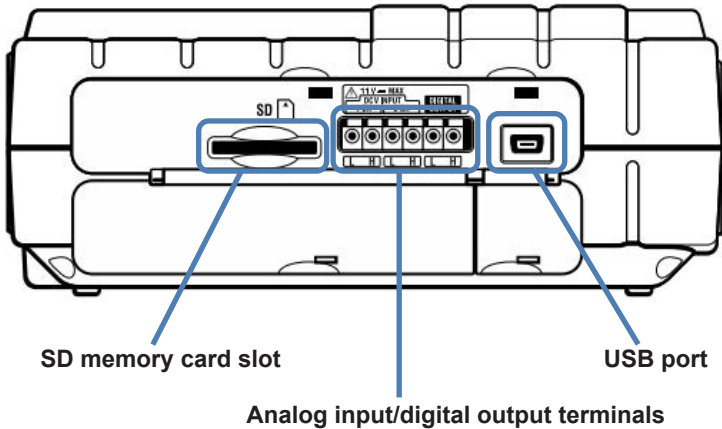

---

## 2.4 Voltage Probe and Current Clamp-on Probe

Alligator Clip (the end of the voltage probe)

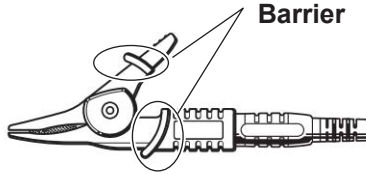

Current Clamp-on Probe

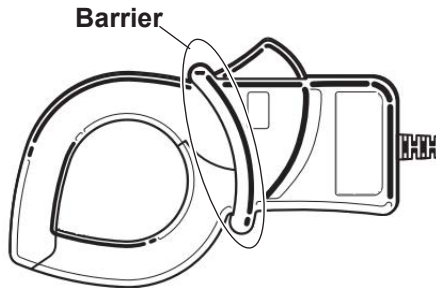

Barrier: A mark for securing the minimum required creep and spatial distance to prevent electric shock during operation.

When taking a measurement, be careful that your finger or the like does not cross over the barrier.

## 3.1 Description of Control Keys

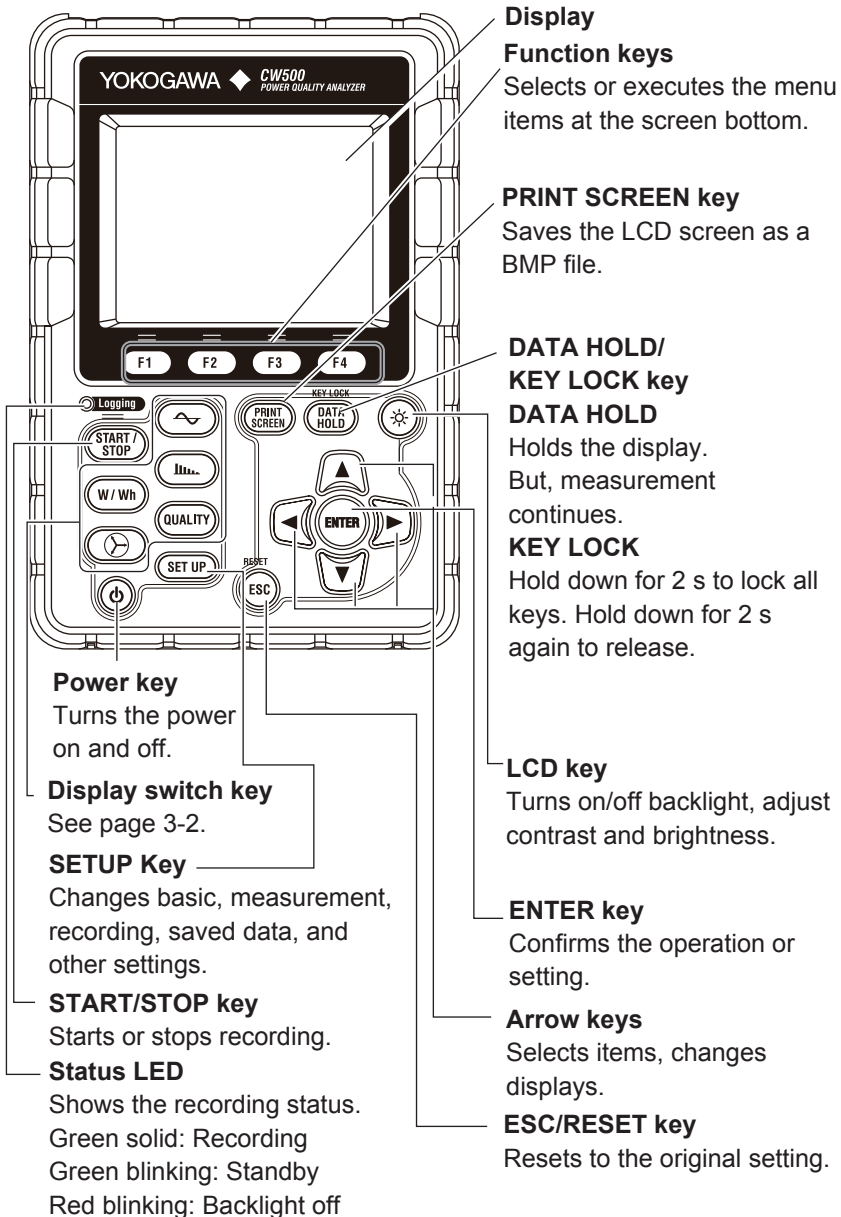

# Display Switch Key

## W/Wh key

Displays instantaneous values, integrated values, and “demand”



## Vector key

Displays phases



## Waveform key

Displays voltage and current waveforms



## Harmonic analysis key

















Displays harmonic voltage, harmonic current, and harmonic power



## QUALITY key

Displays the occurrence of swell, dip, interruption, transient, inrush current, and flicker

## 3.2 Marks Displayed in the Top Area of the LCD

Mark	Status When Displayed
	Running on batteries. Shows the battery level using four levels.
	Running on AC power.
	Screen updating is held.
	Keys are locked.
	The buzzer is turned off.
	SD memory card can be used.
	Recording to SD memory card.
	Not enough space in SD memory card to record.
	Unable to access SD memory card.
	Possible to record to internal memory. This appears when recording is started without an SD memory card inserted.
	Recording to internal memory.
	Not enough space in internal memory to record.
	Waiting to record.
	Recording measurement values.
	Recording medium is full.
	USB can be used.
	Bluetooth® can be used.

### 3.3 Display Symbols

Display Symbol									
V <sup>1</sup>	Phase voltage			VL <sup>1</sup>	Line voltage			A	Current
P	Active power	+	Consumption	Q	Reactive power	+	Lag	S	Apparent power
		-	Regeneration			-	Lead		
PF	power factor	+	Lag	f	Frequency				
		-	Lead						
DC1	Analog input channel 1 voltage			DC2	Analog input channel 2 voltage				
An <sup>2</sup>	Neutral line current			PA <sup>3</sup>	Phase angle	+	Lag	C <sup>3</sup>	Phase advance capacitor capacitance
						-	Lead		
WP+	Active energy (consumption)			WS+	Volt-ampere hours (consumption)			WQi+	Reactive energy (lag)
WP-	Active energy (regeneration)			WS-	Volt-ampere hours (regeneration)			WQc+	Reactive energy (lead)
THD	Voltage/current distortion								
Pst (1min)	1-minute voltage flicker			Pst	Short term voltage flicker			PIt	Long term voltage flicker

- 1 The V and VL displays can be customized when 3P4W is selected.
- 2 An appears only when 3P4W is selected.
- 3 PA and C can be displayed by customization.

---

## 3.4 Backlight and Contrast Adjustment

Holding down the LCD key for 2 seconds when the backlight is on displays slide bars for adjusting the backlight brightness and display contrast. To adjust the brightness or contrast, use the arrow keys to move the slide bars. After adjusting, press ENTER to confirm. To cancel the adjustment, press ESC or LCD again.

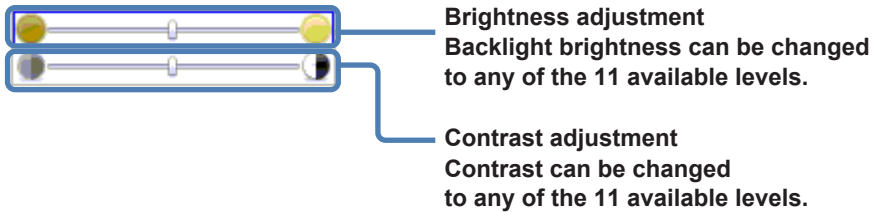



# 3.5 Screens and Screen Configuration

## Instantaneous, Integrated, and Demand Switching the W/Wh Screen

Each time you press function key F1, the display screen changes.

**W (instantaneous value)**

**Wh (Integrated value)**

**Demand**



**W/Wh**

**Customize**

Select and change the items to be displayed.



**Zoom**

Zoom in on selected items.

**Trend**

Measurement variation trends are displayed on a graph.

**4 windows**

**8 windows**

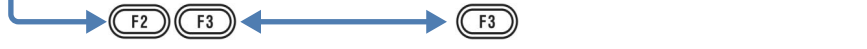

## Vector

### Switching the Vector Screen

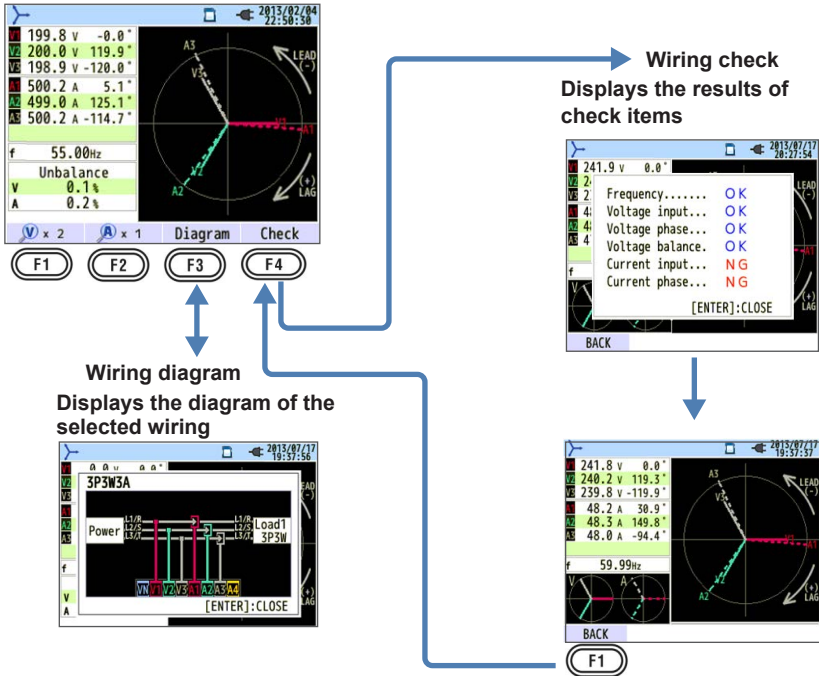

## Waveform

### Switching the Waveform Screen

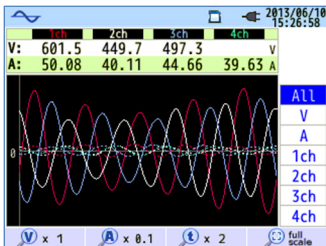

# Harmonics

## Switching the Harmonic Analysis Display Items

Voltage, Linear, Overall display



Current

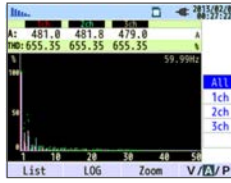

Power



List, percentage content

V	V1	V2	V3	%
1	100.0	100.0	100.0	%
2	16.2	10.5	3.6	%
3	54.7	29.8	48.8	%
4	0.7	3.7	2.4	%
5	11.2	6.5	3.7	%
6	2.1	4.7	0.6	%
7	6.0	1.5	8.9	%
8	0.4	1.5	0.9	%
9	7.9	4.3	4.8	%
10	1.0	0.3	1.0	%

Logarithm

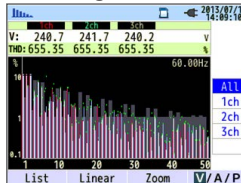

Zoom

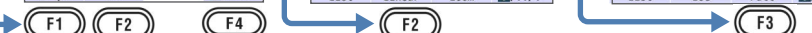

Phase angle

V	V1	V2	V3	deg
1	0.0	118.2	-119.3	deg
2	10.8	121.0	-119.5	deg
3	3.5	118.9	-119.6	deg
4	-2.6	119.1	-119.2	deg
5	8.7	121.8	-119.0	deg
6	-3.7	119.5	-119.8	deg
7	-2.1	119.9	-119.2	deg
8	4.3	119.4	-119.2	deg
9	-9.5	119.1	-119.1	deg
10	3.7	120.8	-119.5	deg

Rms value

V	V1	V2	V3	v
1	599.5	455.6	505.9	v
2	25.8	50.7	134.7	v
3	107.6	33.4	91.1	v
4	19.7	9.1	8.0	v
5	39.8	44.1	36.6	v
6	5.7	4.8	5.9	v
7	7.5	12.6	8.6	v
8	21.0	13.6	3.8	v
9	17.3	10.0	28.0	v
10	8.8	8.2	4.4	v

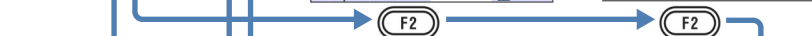

Current

A	A1	A2	A3	A
1	481.4	481.9	478.5	A
2	69.5	137.0	89.3	A
3	213.2	57.3	70.6	A
4	6.0	4.4	9.9	A
5	77.1	94.6	15.9	A
6	24.7	12.1	27.3	A
7	33.3	48.2	47.7	A
8	16.1	5.4	4.2	A
9	26.5	8.8	41.8	A
10	1.4	2.0	5.5	A

Power

P	P1	P2	P3	P
1	115.4	115.6	115.3	356.1kw
2	0.8	0.5	5.6	7.2kw
3	24.0	1.6	20.8	47.0kw
4	0.2	0.3	0.2	0.0kw
5	1.0	0.1	2.6	3.8kw
6	0.0	0.0	0.0	0.1kw
7	0.2	1.0	0.0	1.3kw
8	0.0	0.0	0.0	0.0kw
9	0.5	0.1	0.6	1.4kw
10	0.0	0.0	0.0	0.0kw

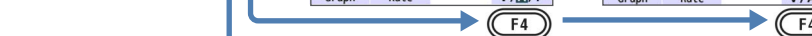

# Power Quality

## Switching the Quality Display Items

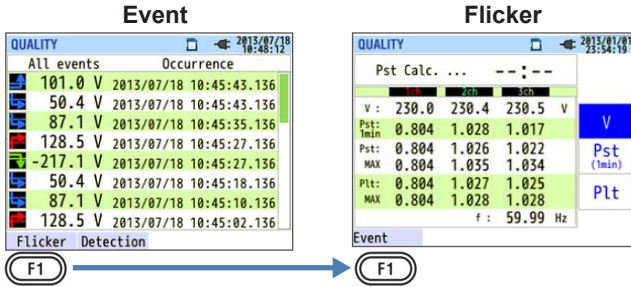

# Setup

## Switching the Setup Display Items

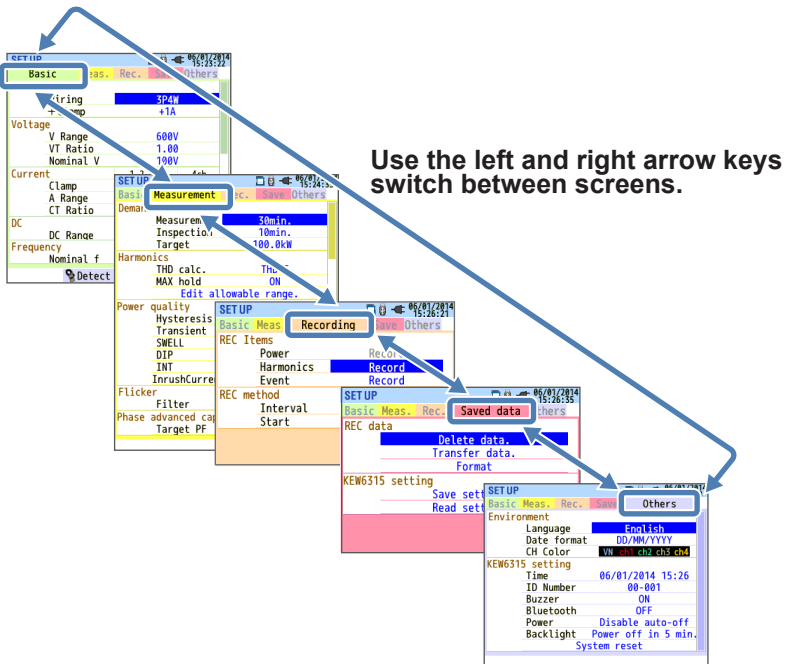

## 4.1 Starting and Stopping Recording

### Starting Recording

Press START/STOP.

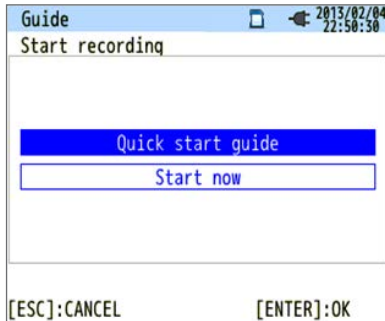

You can select the recording start method from “Quick start guide” and “Start now.”

#### Quick start guide

You can easily start recording by setting the items by following the instructions displayed on the screen. However, the items that you can set are those related to wiring and recording. If you need to specify other settings, set them from the SETUP menu.

#### Start now

Recording starts immediately using the current settings.

#### <Procedure>

Using the up and down arrow keys, select “Quick start guide” or “Start now,” and press ENTER.

To cancel, press ESC.

## Stopping Recording

While recording is in progress, press START/STOP.

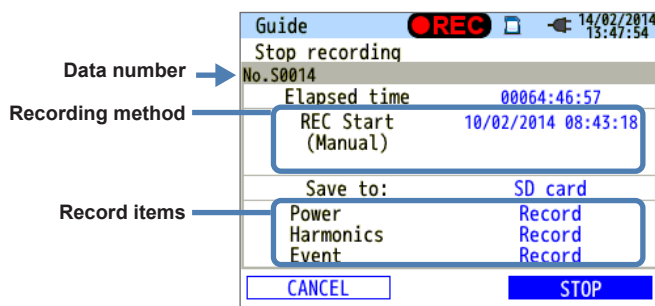

Recording information is displayed, and recording stops.

Display Items	
<b>Recorded data number</b>	The ID number of the recorded data is displayed. This is also used as the name of the folder in which measured data is saved.
<b>Elapsed time</b>	Elapsed time from the start of recording is displayed.
<b>Recording method</b>	Manual The recording start date and time are displayed.
	Constant rec. The recording start/end date and time are displayed.
	Time period rec. The recording start date and time, recording period, and recording time are displayed.
<b>Save to</b>	The location where measured data is being recorded to is displayed.
<b>Record items</b>	Measurement items being recorded are displayed.

### <Procedure>

Using the up and down arrow keys, select CANCEL or STOP, and then press ENTER.

You can also cancel by pressing ESC.

## 4.2 Starting to Record with “Quick start guide”

Set the record items.

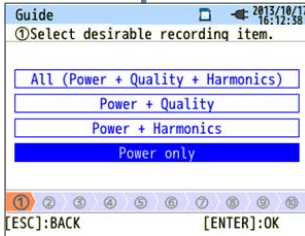

Set the wiring system.

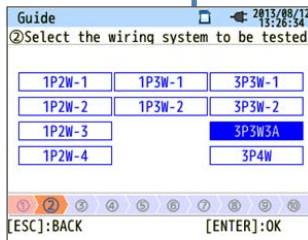

Check wiring connection.

Check the test environment.

Select the item you want to record.

\* Greater the number of items, the greater the file size, which means shorter recording time.

Select the wiring system to be measured.

\* Select a proper wiring system for accurate measurements.

See page 4-5.

Connect to the circuit to be measured.

\* Read and follow the safety precautions.

See the Getting Started Guide (IM CW500-02EN).

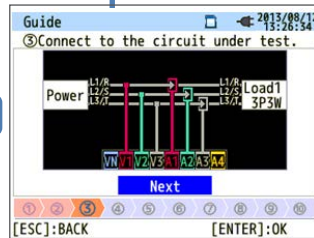

Check the test environment.

- \* Performs a CW500 self-diagnosis, wiring status check, and connected sensor identification.
- \* We recommend that you execute this check in order to record in the correct conditions. The test takes about 10 seconds.

See page 4-6.

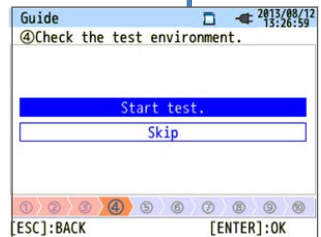

## 4.2 Starting to Record with “Quick start guide”

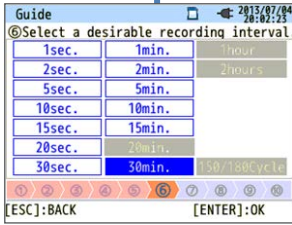

Select a recording interval.

\* Selecting a short interval results in a large file size preventing long-term recording.

See page 5-29.

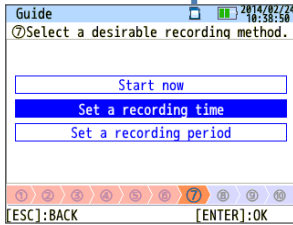

Select the rec. method.

See page 4-9.

### Ready. Recording will start.

When recording starts, the screen shows REC, and the Logging LED turns green. To stop recording, press START/STOP, and follow the instructions on the screen.

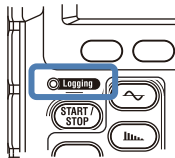
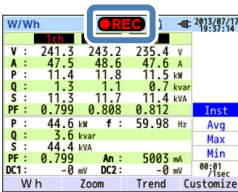
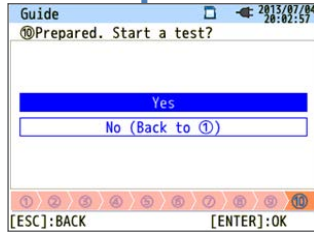



## Setting the Wiring System

You can select from the following wiring systems.

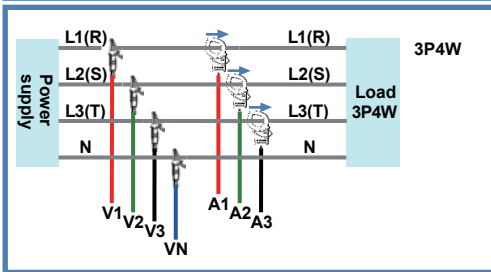
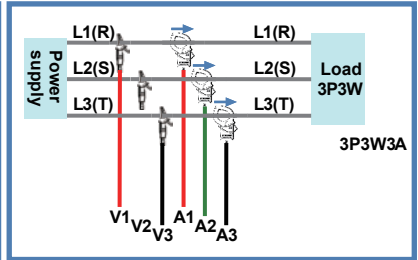
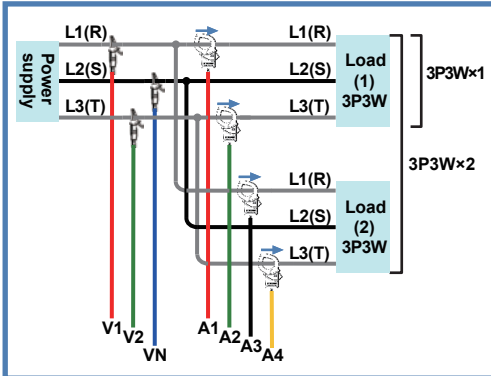
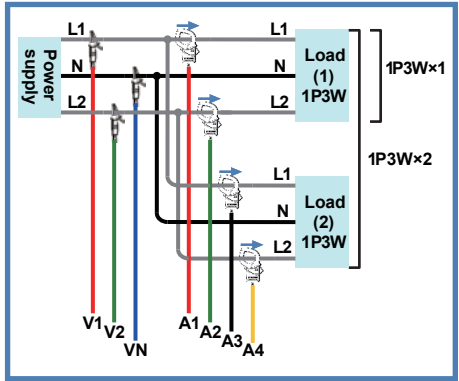
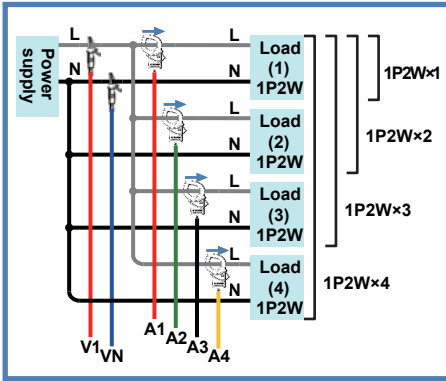

Orientation of the current clamp-on probe

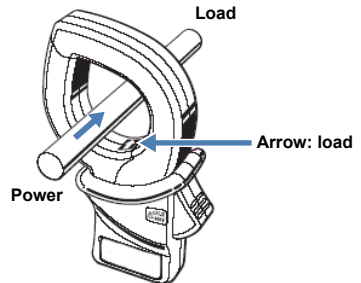

\* If clamped in the reverse direction, the polarity of the active power (P) value will be reversed.

## Test Environment Check

### Test environment check

Select Start test and press ENTER to check the test environment and display the results.

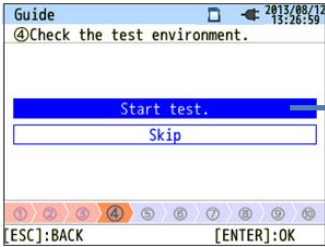

Select the OK or NG of a test result to see the details.

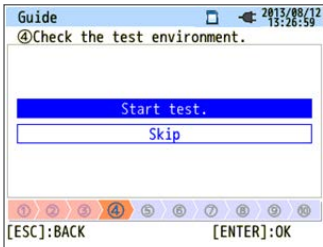

### Wiring check

Displays the test results of each item.  
\* If measuring at site with extremely poor power factor, this check may fail even if the wiring is correct.

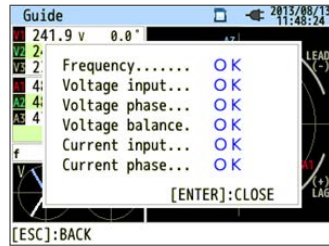

### Self-diagnosis

Displays the results of a system operation check.

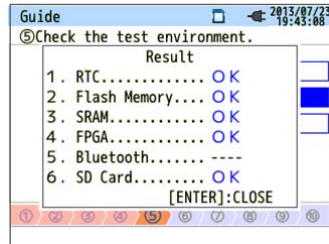

### Sensor detection

Automatically detects connected current probes and sets the range to their maximums.

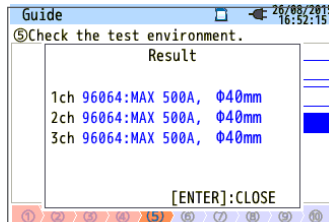

## NG Judgment

### Wiring Check

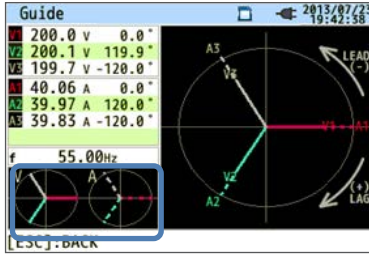

Closing the test results causes the NG values and vectors to blink. If everything is OK, the ideal vector diagram will be displayed in the lower left corner.

### Wiring Check Criteria and Failure Cause

Check	Judgment Criteria	Failure Cause
<b>Frequency</b>	• The V1 frequency is between 40 to 70 Hz.	<ul style="list-style-type: none"> <li>• The voltage clip is not firmly connected to the DUT.</li> <li>• Harmonic components are large.</li> </ul>
<b>AC voltage input</b>	• AC voltage input is 10% of (nominal voltage × VT) or higher.	<ul style="list-style-type: none"> <li>• The voltage clip is not firmly connected to the DUT.</li> <li>• Voltage probe is not correctly inserted into the AC voltage input terminal of this instrument.</li> </ul>
<b>Voltage balance</b>	<ul style="list-style-type: none"> <li>• AC voltage input is within ±20% of reference voltage V1.</li> <li>* Not checked for single-phase wiring</li> </ul>	<ul style="list-style-type: none"> <li>• Settings are not appropriate for the measurement line wiring system.</li> <li>• The voltage clip is not firmly connected to the DUT.</li> <li>• Voltage probe is not correctly inserted into the AC voltage input terminal.</li> </ul>
<b>Voltage phase</b>	• AC voltage input phase is within ±10% of the reference value (appropriate vector).	<ul style="list-style-type: none"> <li>• Voltage probe is not connected correctly. (The connected channel is incorrect.)</li> </ul>
<b>Current input</b>	• Current input is 5% or higher and 110% or less of (current range × CT).	<ul style="list-style-type: none"> <li>• Current clamp-on probe is not correctly inserted into the AC power input terminal of this instrument.</li> <li>• Current range setting is too high or too low for the input level.</li> </ul>
<b>Current phase</b>	<ul style="list-style-type: none"> <li>• Power factor (PF, absolute value) of each channel is 0.5 or higher.</li> <li>• Active power (P) of each channel is positive.</li> </ul>	<ul style="list-style-type: none"> <li>• Current direction mark of the current clamp-on probe is not matched with the current-to-load direction.</li> <li>• Clamp-on probe is not connected correctly.</li> </ul>

## Self-Diagnosis

If NG is displayed frequently, the instrument may be malfunctioning. Stop using it immediately, and see chapter 10, “Troubleshooting,” on page 10-1.

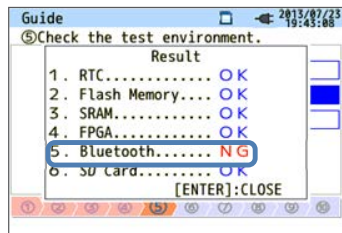

## Sensor Detection

If detection fails, current clamp-on probe types are displayed in red.

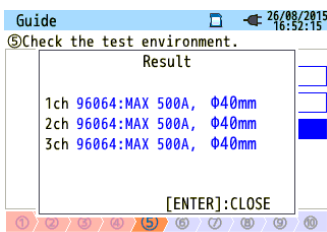
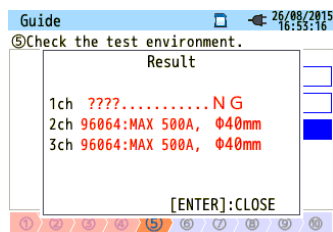

## Detection Failure Cause

Check	Cause
<b>Current clamp-on probe type</b>	<ul style="list-style-type: none"> <li>Different types of current clamp-on probes are connected to each channel. Use the same type of current clamp-on probes for measurement.</li> </ul>
<b>??? (cause unknown)</b>	<ul style="list-style-type: none"> <li>Current clamp-on probe is not firmly connected to the instrument.</li> <li>Troubleshooting</li> </ul> <p>Connect the current clamp-on probe that failed to be detected to a channel that detection was successful, and test again. If the same channel fails again, the instrument may be malfunctioning. If detection fails on the channel connected to the current clamp-on probe that failed to be detected the last time, the clamp-on probe may be malfunctioning. If you suspect a malfunction, stop using it immediately, and see chapter 10, “Troubleshooting,” on page 10-1.</p>

## Reserving by Specifying the Date and Time

Guide 2013/07/04 20:02:57

Ⓢ Set a recording time.

REC Start 2013/08/02 08:00

REC End 2013/08/07 18:00

Next

[ESC]:BACK [ENTER]:OK

From the specified start date and time to the end date and time, recording is performed at a given interval.

If the date and time are set as shown above, recording will be performed during the following period.

8:00 on August 2, 2013 to 18:00 on August 7, 2013

## Reserving a Repetitive Recording

Guide 2013/08/01 20:24:11

Ⓢ Set a recording period.

REC Time 08:00 ~ 18:00

REC Period 2013/08/01~2013/08/08

Next

[ESC]:BACK [ENTER]:OK

Recording is repeated during the specified time slot at a given interval for the specified period.

If the date and time are set as shown above, recording will be performed during the time slots (i) to (viii) below. Recording is not performed from 18:00 to 8:00 of the next day.

- (i) 8:00 to 18:00 on August 1, 2013
- (ii) 8:00 to 18:00 on August 2, 2013
- (iii) 8:00 to 18:00 on August 3, 2013
- (iv) 8:00 to 18:00 on August 4, 2013
- (v) 8:00 to 18:00 on August 5, 2013
- (vi) 8:00 to 18:00 on August 6, 2013
- (vii) 8:00 to 18:00 on August 7, 2013
- (viii) 8:00 to 18:00 on August 8, 2013

## Operation

The basic procedure to operate this instrument is to use the arrow keys to select an item or value, the ENTER key to confirm, and the ESC key to cancel. As an example, the operation is explained for entering settings in Quick start guide. The operation is similar for entering settings on other display screens.

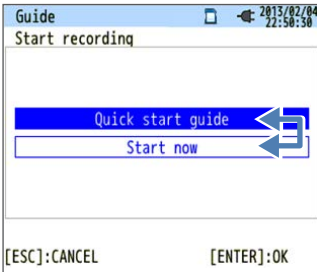

Using arrow keys, you can select the items in blue letters (unselected) and the highlighted item with blue background and white letters (selected). On the Record start screen shown on the left, you can use the up and down arrow keys to select the recording method and ENTER to confirm. To cancel the settings and close the Quick start guide,

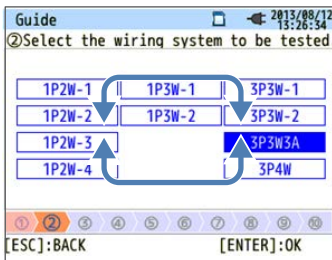

On a screen that shows selectable items in a table form, you can use the up, down, left, and right arrow keys to select an item. On the wiring selection screen shown on the left, you can use the up, down, left, and right arrow keys to select the wiring system to be measured and ENTER to confirm. To cancel

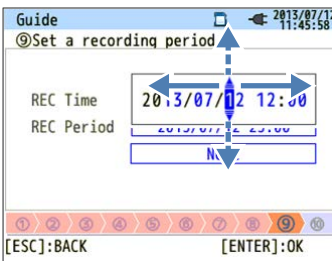

To enter values such time, use the left and right arrow keys to select the digit and the up and down arrow keys to change the number. On the recording time selection screen shown on the left, left and right arrow keys were used to select the tenth digit of the date. In this condition, pressing the up and down arrow keys will increment or decrement the tenth digit. To confirm the change, press ENTER. To cancel the settings and return to the previous screen, press ESC.

## Notes on Settings

If the current range is set to AUTO, only “Power + Harmonics” or “Power only” can be selected with “1. Select desirable recording item.” If you want to record power quality, change the current range to a fixed range before starting to record. Only wiring and recording settings can be specified in “Quick start guide.” Nominal voltage, nominal frequency, threshold for power quality events (included in the measurement settings), and filter coefficient (ramp) for flicker measurement must be set in advance. Set these items from the SETUP menu. Note that the “+ Clamp” option clamp-on probe setting is automatically set to OFF.

## 5.1 Settings

Before starting measurement, you need to set measurement conditions and data saving conditions.

To set these conditions, press SET UP to enter the SET UP mode.

The SET UP mode is divided into the following five categories. Use the arrow keys to move between the categories.

The settings that you change take effect after you exit from the SET UP mode and  appears in the upper left of the screen.

Note that even if you change the settings, if you turn off the power while in SET UP mode, the settings will not take effect.

<b>Basic</b>	Set common measurement items.
<b>Measurement</b>	Set specific measurement items.
<b>Recording</b>	Set the saving method.
<b>Saved Data</b>	Edit recorded data or change the instrument settings.
<b>Others</b>	Configure environmental settings.

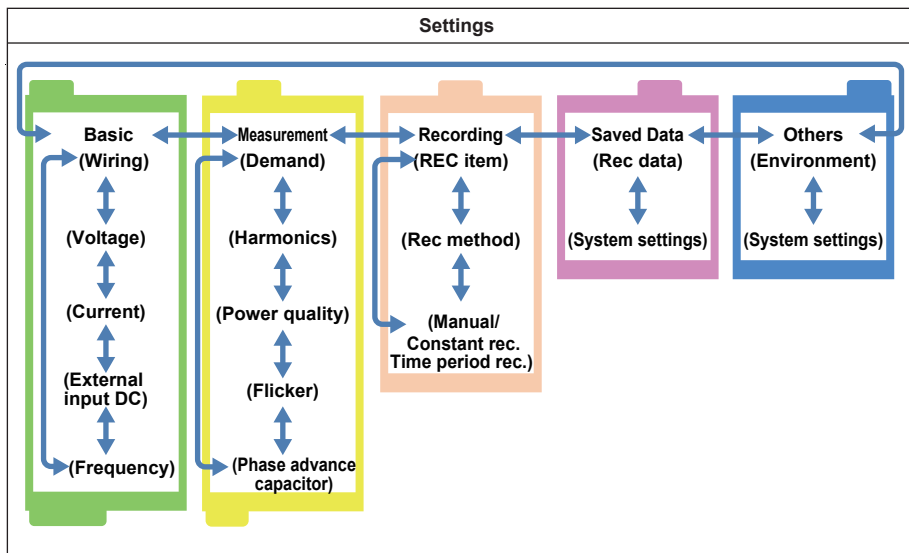



## 5.2 Basic Setup

### <Procedure>

Press SETUP. → Use the left and right arrow keys to select the Basic tab.



## Wiring System Settings

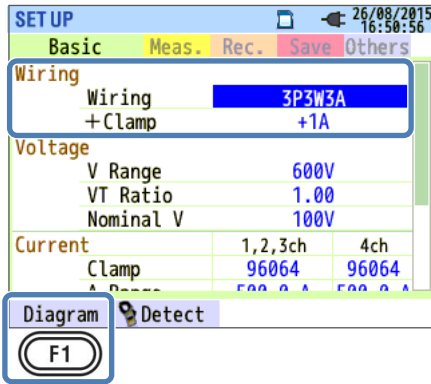

### Wiring

From the 10 available wiring systems, select the appropriate one for the wiring system to be measured.

### Settings

1P2W×1	1P2W×2	1P2W×3	1P2W×4
1P3W×1	1P3W×2		
3P3W×1	3P3W×2	3P3W3A	3P4W (default setting)

\*Current terminals that are not used in “+Clamp” wiring can measure only rms values and harmonics.

#### <Procedure>

Use the up and down arrow keys to move to Wiring. → Press ENTER to show a pull-down menu. → Select the wiring system. → Press ENTER to confirm or ESC to cancel.

### +Clamp (optional clamp-on probe)

#### <Procedure>

Use the up and down arrow keys to move to +Clamp. → Press ENTER to show a pull-down menu. → Use the up and down arrow keys to select the optional clamp. → Press ENTER to confirm or ESC to cancel.

## Wiring Diagrams

When you move to the Wiring item, you can use the F1 (Diagram) key to show the wiring diagram of the selected wiring system.

### <Procedure>

After showing the wiring diagram, press F1 (previous wiring system) or F2 (next wiring system) to change the wiring system. → Press ENTER to confirm or ESC to cancel.

1P2W-1

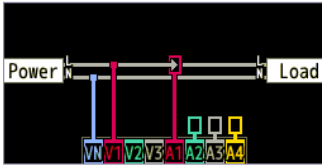

1P2W-2

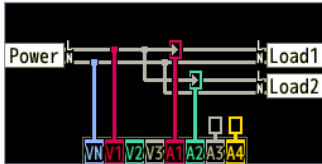

1P2W-3

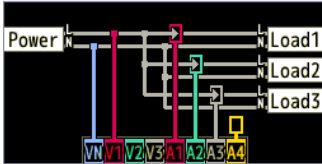

1P2W-4

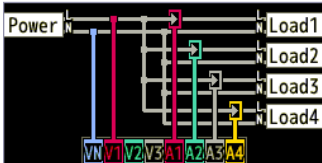

1P3W-1

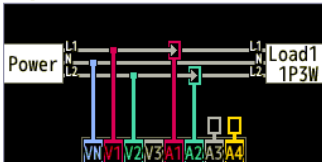

3P4W

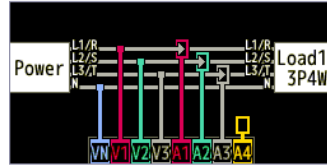

3P3W3A

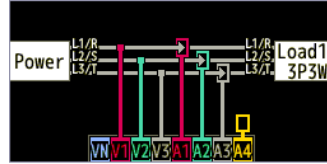

3P3W-2

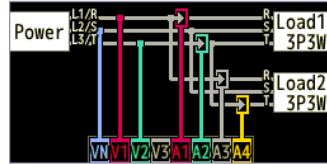

3P3W-1

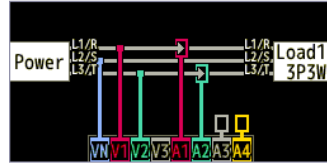

1P3W-2

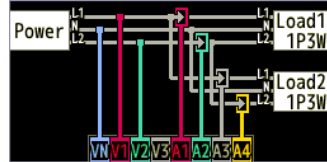

## Voltage Measurement Settings

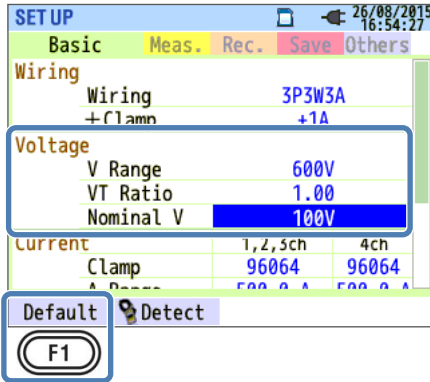

### V Range

Select the voltage range to use.

To perform a measurement according to the international power quality standard IEC61000-4-30 Class S, select 600V.

Settings
600V*/1000V

\* Default value

### <Procedure>

Use the up and down arrow keys to move to V Range. → Press ENTER to show a pull-down menu. → Use the up and down arrow keys to select the voltage range. → Press ENTER to confirm or ESC to cancel.

### VT Ratio

Set this when an external VT (voltage transformer) is installed in the system. The VT ratio will be applied to all voltage measurements.

Settings
0.01 to 9999.99 (1.00*)

\* Default value

**<Procedure>**

Use the up and down arrow keys to move to VT Ratio. → Press ENTER to show a value entry window.\* → Use the arrow keys to select the VT ratio. → Press ENTER to confirm or ESC to cancel.

\* The input range is shown in a pop-up.

**VT/CT**

The measurement accuracy of this instrument when VT or CT is used is not guaranteed. When using a VT or CT, take into consideration the VT or CT accuracy, phase characteristics, and the like in addition to the instrument accuracy.

If the voltage or current on the measurement line exceeds the maximum measurement range of this instrument, you can use a VT or CT with specifications appropriate for the measurement line voltage and current to measure the secondary side and display the value on the primary side.

Example of single-phase two-wire (1 system) (1P2W × 1)

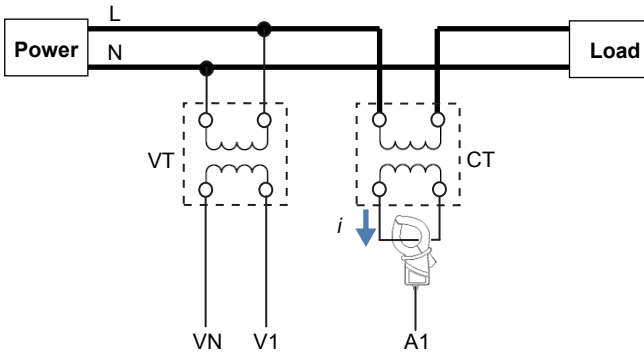

If the rating of the secondary side of the CT is 5 A, We recommend that you use a 50 A type clamp-on probe and measure at the 5 A range. Make sure to set the appropriate VT and CT ratios.

### Nominal V

Set the nominal voltage applied from the DUT.

Settings
50V~600V(100V*)

\* Default value

#### <Procedure>

Use the up and down arrow keys to move to Nominal V. → Press ENTER to show a value entry window.\* → Use the arrow keys to enter the nominal voltage. → Press ENTER to confirm or ESC to cancel.

\* The input range is shown in a pop-up.

### Default Values

When you move to the Nominal V item, you can press F1 (default values) to show a list of typical nominal voltages that you can choose from.

Settings
100V/101V/110V/120V/200V/202V/208V/220V/230V/ 240V/277V/346V/380V/400V/415V/480V/600V

#### <Procedure>

Use the arrow keys to select nominal voltage. → Press ENTER to confirm or ESC to cancel.

## Current Measurement Settings

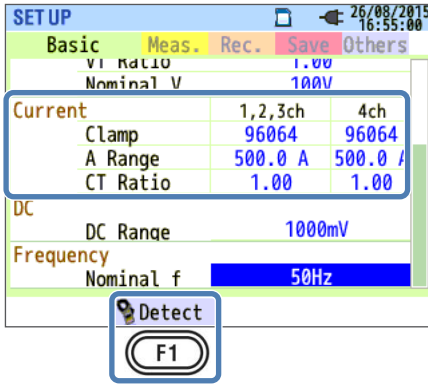

### Clamp (Current clamp-on probe)

Select the current clamp-on probe you want to use. If you selected an optional clamp-on probe for “+Clamp,” you can select a current clamp-on probe that is of a different type than the current clamp-on probe connected to the DUT only for channel 4. If you select a current clamp-on probe from the pull-down menu, the rated current and the conductor size are displayed in a pop-up.

Settings	
96060: 0.2/2A/AUTO\$3	Leak current clamp-on probe
96061:5/50A/AUTO	
96062:10/100A/AUTO	
96063:20/200A/AUTO	
96064*:50/500*A/AUTO	Power measurement clamp-on probe
96066:100/1000A/AUTO	
96065:300/1000/3000	

\* Default value

### <Procedure>

Use the arrow keys to move to Clamp. → Press ENTER to show a pull-down menu. → Use the arrow keys to select the current clamp-on probe. → Press ENTER to confirm or ESC to cancel.

## Current Range

Select the current range to use. If power quality events are set to be recorded, AUTO is not available.\* If you want the current range to switch automatically, set power quality events to “Do not record.” For details on power quality event settings, see “Power Quality (Event) Threshold Settings” on page 5-18.

\* If AUTO range is selected, measurements according to international power quality standard IEC61000-4-30 Class S cannot be performed.

### <Procedure>

Use the arrow keys to move to A Range. → Press ENTER to show a pull-down menu. → Use the up and down arrow keys to select the range. → Press ENTER to confirm or ESC to cancel.

## CT Ratio

Set this when an external CT (current transformer) is installed in the system. The CT ratio will be applied to all current measurements. For details on CT, see “VT/CT” on page 5-6.

Settings
0.01~9999.99(1.00*)

\* The default value is 1.00.

### <Procedure>

Use the arrow keys to move to CT Ratio. → Press ENTER to show a value entry window.\* → Use the arrow keys to select the CT ratio. → Press ENTER to confirm or ESC to cancel.

\* The input range is shown in a pop-up.



### **Sensor Detection**

Press F2 (sensor detection) to automatically set the connected current clamp probe. However, if a current clamp-on probe whose type is not appropriate for the DUT is connected or if the type fails to be detected, this will not work. If this happens, an error message appears in a pop-up, and Clamp, A Range, and CT ratio settings will be cleared. For details on sensor detection, see section 4.2, "Sensor Detection."

## External Input Terminal and Reference Frequency Settings

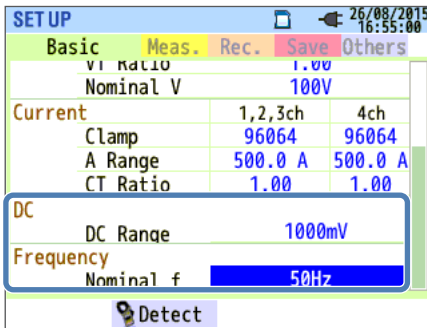

### DC Range

Select the DC range according to the input DC voltage signal.

Settings
100mV/1000mV*/10V

\* Default value

#### <Procedure>

Use the up and down arrow keys to move to DC Range. → Press ENTER to show a pull-down menu. → Use the up and down arrow keys to select the range. → Press ENTER to confirm or ESC to cancel.

### Frequency

Set the nominal frequency for the DUT. If the voltage frequency cannot be determined, such as during a power failure, the CW500 measures based on the preset nominal frequency.

Settings
50Hz*/60Hz

\* Default value

#### <Procedure>

Use the up and down arrow keys to move to Nominal f. → Press ENTER to show a pull-down menu. → Use the up and down arrow keys to select the frequency. → Press ENTER to confirm or ESC to cancel.

## 5.3 Measurement Setup

### <Procedure>

Press SETUP. → Use the left and right arrow keys to select the Measurement tab.

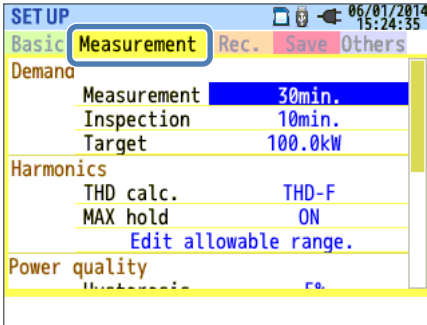

### Demand Measurement Settings

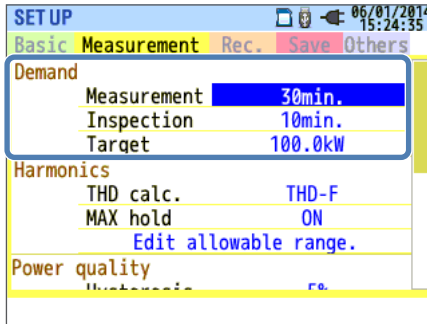

## Measurement

Disable demand measurement or select the demand measurement cycle. When demand measurement is started, the demand value is determined every measurement interval and recorded. In demand measurement, the recording interval can be set only to the times shown below. If the interval is set to some other value and the measurement interval is set, the interval is automatically set to the same value as the measurement interval.

Selectable intervals: 1 s, 2 s, 5 s, 10 s, 15 s, 20 s, 30 s, 1 min, 2 min, 5 min, 10 min, 15 min,\* 30 min\*

\* The interval cannot be set to a value longer than the measurement interval.

Settings
Not be used, 10 min, 15 min, 30 min*

\* Default value

### <Procedure>

Use the up and down arrow keys to move to Measurement. → Press ENTER to show a pull-down menu. → Use the up and down arrow keys to select the time. → Press ENTER to confirm or ESC to cancel.

## Target

Set the demand measurement target value.

Settings
0.001mW~999.9TW(100.0kW*)

\* Default value

### <Procedure>

Use the arrow keys to move to Target. → Press ENTER to show a value entry window.\* → Use the arrow keys to enter the target value. → Press ENTER to confirm or ESC to cancel.

\* The input range is shown in a pop-up.

## 5.3 Measurement Setup

When the target value entry window is displayed, the following operations become valid. You can specify an active power or apparent power for the demand target value. To switch between active power and apparent power, press F1 (VA/W) to change to the appropriate power unit.\* To change the unit,\* use the left and right arrow keys to move to the unit, and use the up and down arrow keys to change it. Press F2 and F3 to move the decimal point.

\*Apparent power:mVA, \_VA, kVA, MVA, GVA, TVA

Active power:mW, \_W, kW, MW, GW, TW

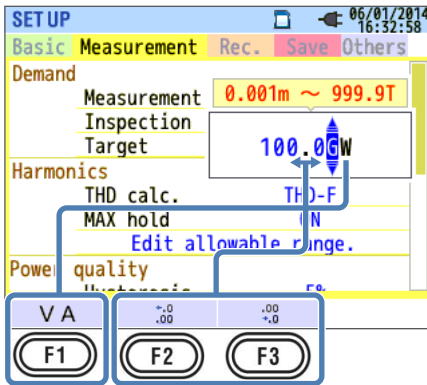

### Inspection cycle

Select the cycle (time) during which a buzzer is sounded when the estimated value exceeds the target value during demand measurement. You cannot set the inspection cycle longer than the measurement cycle. The inspection cycles that can be selected depending on the measurement cycle are shown below.

Measurement cycle setting	Selectable inspection cycles
10 min or 15 min	1 min, 2 min, 5 min
30 min	1 min, 2 min, 5 min, 10 min,* 15 min

\* Default value

#### <Procedure>

Use the up and down arrow keys to move to Inspection. → Press ENTER to show a value entry window.\* → Use the arrow keys to select the time.  
 → Press ENTER to confirm or ESC to cancel.

\* The input range is shown in a pop-up.

## Demand Measurement Overview

The average power over 30 minutes (measurement cycle) is typically called the demand. Contract demand for factories and the like is determined by this demand. A method to suppress demand is explained below using an example. Assuming that the maximum demand needs to be suppressed to 500 kW (target value), measurement cycle 1 is not a problem because the demand is 500 kW, but measurement cycle 2 is because 600 kW of power is consumed in the first 15 minutes. In this case, the demand for measurement cycle 2 can be suppressed to 500 kW (the same as measurement cycle 1) by reducing the power of the last 15 min to 400kW. Note that if the power consumption during the first half of cycle 2 is 1000 kW and the last 15 minutes is 0 kW (no load), the average power is also 500 kW. If Inspection is set to 15 min, the buzzer will sound after 15 minutes at measurement cycle 2.

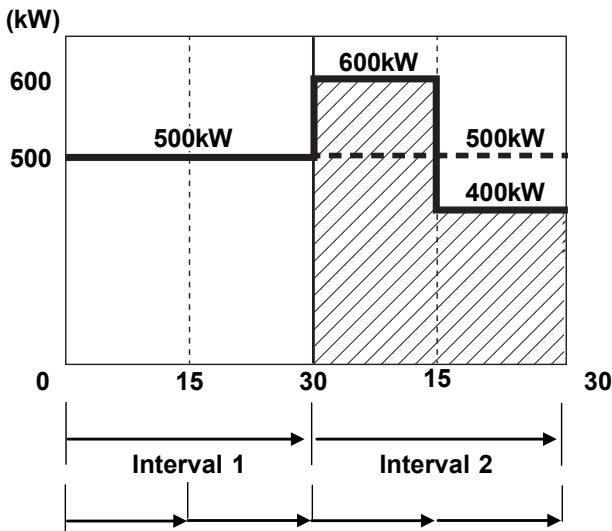

## Harmonic Analysis Settings

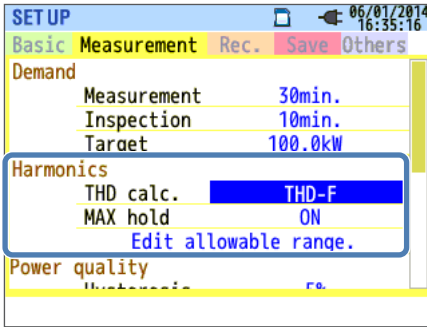

### THD calculation

Select the THD (total harmonic distortion) calculation method. Select THD-F to calculate the total harmonics distortion based on the fundamental waveform and “THD-R” to calculate based on all rms values.

Settings
THD-F (fundamental waveform as reference)*/THD-R (all rms values as reference)

\* Default value

#### <Procedure>

Use the up and down arrow keys to move to THD calc. → Press ENTER to show a pull-down menu. → Use the up and down arrow keys to select the calculation method. → Press ENTER to confirm or ESC to cancel.

### MAX hold

If MAX hold is set to ON, the maximum percentage content from the start of measurement is marked on the harmonics graph.

Settings
ON*/OFF

\* Default value

#### <Procedure>

Use the up and down arrow keys to move to MAX hold. → Press ENTER to show a pull-down menu. → Use the up and down arrow keys to select ON or OFF. → Press ENTER to confirm or ESC to cancel.

## Editing the Allowable Range

Set the EMC allowable range (percentage content) for harmonics for each order. The specified ranges are displayed as a bar graph on the harmonics graph.

Settings
Specified value*/customize (voltage/current)

\* Default value

### <Procedure>

Use the up and down arrow keys to move to Edit allowable range. → Press ENTER to display the allowable range entry window. → Use the arrow keys to select the harmonic order you want to set. → Press ENTER to open a value entry window.\* → Use the arrow keys to enter the allowable values. → Press ENTER to confirm or ESC to cancel.

\* The input range is shown in a pop-up.

When the allowable range entry window is displayed, the following operations become valid. The default allowable values of each harmonic order are the values of the international EMC standard IEC61000-4-7: industrial environment Class 3. If you change the values and want to reset to their defaults, press F3 (default). Press F2 (A/V [%]) to switch between the allowable value entry window of harmonic current and that of harmonic voltage. To return to the measurement setup screen, press F1 (return).

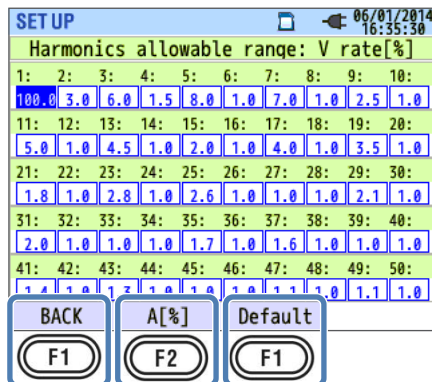



## Power Quality (Event) Threshold Settings

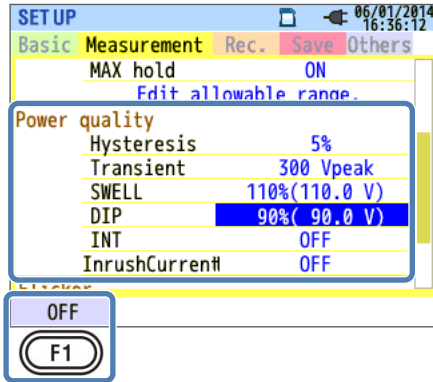

Press F1 (OFF/ON) to enable the threshold of each event to be entered. Even if a threshold is specified, the event will not be detected if it is set to OFF. When you set an event back to ON, the threshold set previously appears.

### Notes on Setting the Thresholds

Because the SWELL, DIP, and INT thresholds are set as percentages of the nominal voltage, if the nominal voltage is changed, the threshold voltages also change. The default value is the peak voltage (300%). Because the InrushCurrent threshold is set as a percentage of the current range, if the current range is changed, the threshold current also changes. Keep these in mind.

## Hysteresis

Set the measurement area where events will not be detected as a percentage of the threshold. Setting a proper hysteresis will help to prevent unnecessary detections of events that are caused by voltage or current fluctuations near the threshold values.

Settings
1 to 10% (5%*) of the threshold

\* Default value

### <Procedure>

Use the arrow keys to move to Hysteresis. → Press ENTER to show a value entry window.\* → Use the arrow keys to enter the hysteresis [%]. → Press ENTER to confirm or ESC to cancel.

\* The input range is shown in a pop-up.

## Transient (Over-voltage (Impulse))

Set the transient threshold as an instantaneous voltage. The selectable range varies depending on the VT ratio.

Settings
±50 to ±2200 V <sub>peak</sub> (300% of the nominal voltage*)

\* Default value

### <Procedure>

Use the arrow keys to move to Transient. → Press ENTER to show a value entry window.\* → Use the arrow keys to enter the voltage. → Press ENTER to confirm or ESC to cancel.

\* The input range is shown in a pop-up.

## Example of Transient Detection

For details, see “Displaying Recorded Events” on page 6-27.

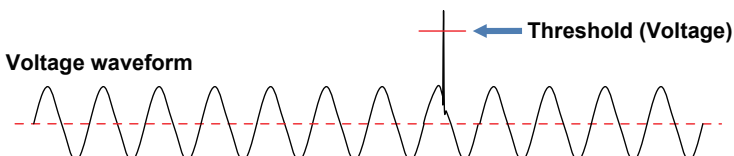

### **Swell (Instantaneous voltage rise)**

Set the swell threshold (rms voltage in one cycle) as a percentage of the nominal voltage. The selectable range varies depending on the VT ratio. Hysteresis is applied to this threshold.

<b>Settings</b>
100 to 200% (110% <sup>*</sup> ) of the nominal voltage

\* Default value

#### **<Procedure>**

Use the up and down arrow keys to move to SWELL. → Press ENTER to show a value entry window.\* → Use the arrow keys to enter a percentage of the nominal voltage.

\* The input range is shown in a pop-up.

### **Inrush current (Instantaneous current rise)**

Set the inrush current threshold (rms current in one cycle) as a percentage of the maximum value of the current range. The selectable range varies depending on the CT ratio. Hysteresis is applied to this threshold.

<b>Settings</b>
0 to 110% (100% <sup>*</sup> ) of the current range

\* Default value

#### **<Procedure>**

Use the up and down arrow keys to move to InrushCurrent. → Press ENTER to show a value entry window.\* → Use the arrow keys to enter a percentage of the maximum value of the current range.

\* The input range is shown in a pop-up.

### Example of Swell and Inrush Current Detection

For details, see “Displaying Recorded Events” (section 6.7).

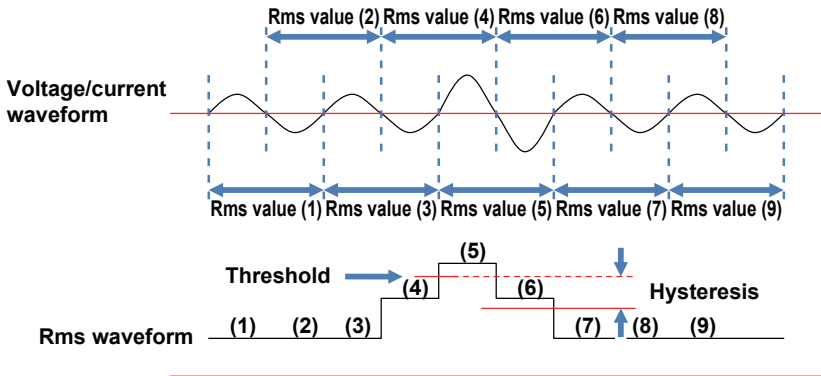

### Dip (Instantaneous voltage drop)

Set the dip threshold (rms voltage in one cycle) as a percentage of the nominal voltage. The selectable range varies depending on the VT ratio. Hysteresis is applied to this threshold.

Settings
0 to 100 % (90 %*) of the nominal voltage

\* Default value

#### <Procedure>

Use the up and down arrow keys to move to DIP. → Press ENTER to show a value entry window.\* → Use the arrow keys to enter a percentage of the nominal voltage.

\* The input range is shown in a pop-up.

**Interruption (Instantaneous power interruption)**

Set the interruption threshold (rms voltage in one cycle) as a percentage of the nominal voltage. The selectable range varies depending on the VT ratio. Hysteresis is applied to this threshold. To detect events at rms voltages of 10 V or less, be sure to enable the interruption event. Proper detection may not be possible by setting a similar threshold for dip.

<b>Settings</b>
0 to 100 % (10 %*) of the nominal voltage

\* Default value

**<Procedure>**

Use the up and down arrow keys to move to INT. → Press ENTER to show a value entry window.\* → Use the arrow keys to enter a percentage of the nominal voltage.

\* The input range is shown in a pop-up.

Example of Dip and Interruption Detection

For details, see “Displaying Recorded Events” on page 6-27.

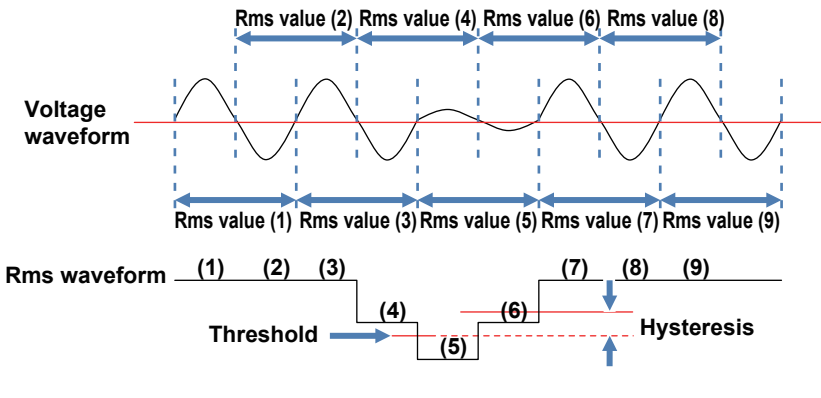

## Flicker Filter Coefficient Settings

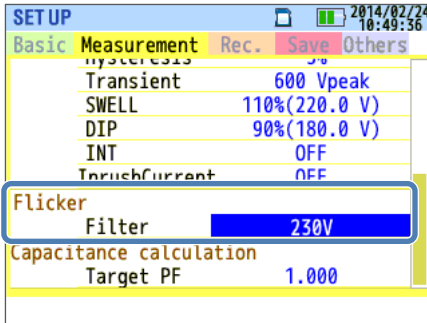

### Filter Coefficient

Select an appropriate filter coefficient according to the nominal voltage. To accurately measure flicker, the nominal voltage, nominal frequency, and filter coefficient must be set properly for the actual DUT. If possible, use the same voltage for the nominal voltage and filter coefficient.

Settings
230V*/220V/120V/100V

\* Default value

### <Procedure>

Use the up and down arrow keys to move to Filter. → Press ENTER to show a pull-down menu. → Select the appropriate filter coefficient. → Press ENTER to confirm or ESC to cancel.

## Target Power Factor for Phase Advance Capacitor

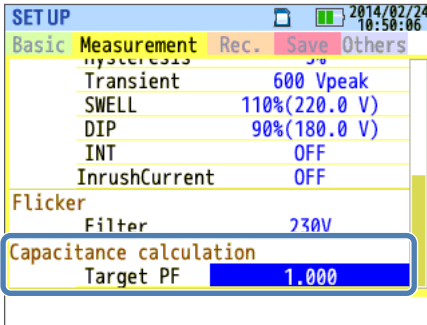

### Target Power Factor

Set the power factor for when phase advance capacitors are installed. The power factor degrades if inductive loads, such as motors, are connected to the power supply because current phases lag behind the voltage phases. Usually, phase advance capacitors are installed in high-voltage-receiving installations, to improve this situation.

Settings
0.5 to 1 (1.000*)

\* Default value

#### <Procedure>

Use the up and down arrow keys to move to Target PF. → Press ENTER to show a value entry window.\* → Use the arrow keys to enter the target power factor.

\* The input range is shown in a pop-up.

## 5.4 Recording Setup

### <Procedure>

Press SETUP. → Use the left and right arrow keys to select the Recording tab.

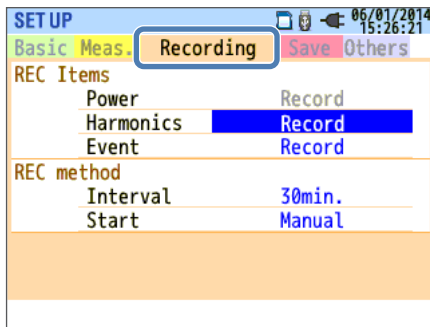

### Recording Item Settings

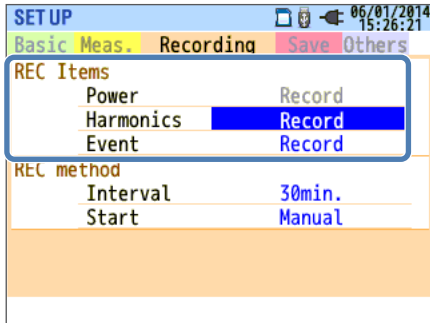

The length of time that measured data can be recorded to an SD memory card or internal memory varies depending on the number of recorded items and interval. Recording time can be extended by setting unnecessary record items to “Do not record.” For details, “Possible Recording Time” on page 5-30.

### Power

This is fixed to “Record.” Power measurement items are always recorded.



### Harmonics

Select whether to record the harmonic data of voltage, current, and power.

Settings
Record*/Not record

\* Default value

### Event

Select whether to record detailed data when a power quality event occurs. If the current range is set to AUTO, "Record" cannot be selected. To select "Record," change the current range to a fixed range first.

\* If AUTO range is selected, measurements according to international power quality standard IEC61000-4-30 Class S cannot be performed.

Settings
Record*/Not record

\* Default value

### <Procedure>

Use the up and down arrow keys to move to Harmonics or Event. → Press ENTER to show a pull-down menu. → Use the up and down arrow keys to select Record or Do not record. → Press ENTER to confirm or ESC to cancel.

## Record Items

The following data measured on each channel is recorded according to the selected record method.

Record items vary depending on the record method and wiring system.

Record file	Record items	Recording setup		
		Power	+Harmonics	+Event
Power measurement data	RMS voltage (line/ phase)			
	Rms current			
	Active power			
	Reactive Power			
	Apparent power			
	Power factor			
	Frequency			
	Neutral line current (3P4W)			
	Voltage/current phase angle (1st order)			
	Analog input voltage, 1CH, 2CH			
	Voltage/current unbalance ratio			
	1-minute voltage flicker	•	•	•
	Short term voltage flicker (Pst)			
	Long term voltage flicker (PIt)			
	Phase advance capacitor capacitance			
	Active energy (consumption/regeneration)			
	Reactive power (consumption) lag/lead			
	Volt-ampere hours (consumption/regeneration)			
	Reactive power (regeneration) lag/lead			
	Demand (W/VA)			
Target demand (W/VA)				
Total harmonic voltage distortion (F/R)				
Total harmonic current distortion (F/R)				
Harmonic measurement data	Harmonic voltage/current (1 to 50th order)			
	Voltage/current phase angle (1 to 50th order)		•	
	V/A phase difference (1 to 50th order)			
	Harmonic power (1 to 50th order)			
Voltage/current fluctuation data	Rms voltage per half-cycle			
	Rms current per half-cycle			•
Event type data	Event detection date and time			
	Event type			•
	Measured values at event detection			
Waveform data	Voltage/current waveforms			•

## Record Method Settings

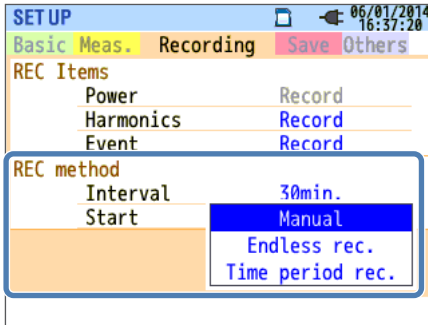

### Interval

Set the interval to record the measured data to the SD memory card or internal memory. Seventeen different intervals are available, but if the measurement interval of demand measurement is already set, the record interval cannot be set longer than the measurement interval. To set a longer interval, change the measurement interval of demand measurement to “Not be used” first. If you set the measurement interval of demand measurement after you set the record interval, the record interval is automatically set to the same setting as the measurement interval. For details, see “Demand Measurement Settings” (page 5-12).

<b>Settings</b>
1s/2s/5s/10s/15s/20s/30s/
1min/2min/5min/10min/15min/20min/30min*
1h/2h/150, 180 cycle (approx. 3 s)

\* Default value

The intervals 150, 180 cycles (approx. 3 sec) are defined in the international power quality standard IEC61000-4-30. Data will be collected for 150 cycles for 50 Hz nominal frequency and 180 cycles for 60 Hz nominal frequency.

### <Procedure>

Use the arrow keys to move to Interval. → Press ENTER to show a selection window.\* → Use the arrow keys to enter the recording interval.  
 → Press ENTER to confirm or ESC to cancel.

## Start

Select the method to start recording.

Settings
Manual*/Constant rec./Time period rec.

\* Default value

### <Procedure>

Use the up and down arrow keys to move to Start. → Press ENTER to show a pull-down menu. → Use the up and down arrow keys to select the recording start method. → Press ENTER to confirm or ESC to cancel.

## Manual

The CW500 records during the period from when you start recording to when you stop recording using the START/STOP key.

## Constant rec.

Set the time to start and stop recording. The CW500 records repeatedly during the period between the start and stop times at the specified interval. For details see “Reserving by Specifying the Date and Time” or “Reserving a Repetitive Recording” (page 4-9).

Settings	Settings
Start date/time	Day/Month/Year Hour:Minute (00/00/0000 00:00)
Stop date/time	Day/Month/Year Hour:Minute (00/00/0000 00:00)

### <Procedure>

Use the arrow keys to move to REC Start/REC End. → Press ENTER to show a time entry window. → Use the arrow keys to select the date and time. → Press ENTER to confirm or ESC to cancel.

### Time Period Recording

Set the recording period by specifying the start date and stop date, and the common time slot during which recording will take place on each day of the recording period. During each time slot, recording is performed at the specified interval. For details see “Reserving by Specifying the Date and Time” or “Reserving a Repetitive Recording” (page 4-9).

Settings		Settings
REC Period	Start—Stop	Day/Month/Year (DD/ MM/ YYYY) - Day/Month/Year (DD/ MM/ YYYY)
REC Time	Start—Stop	Hour:Minute (hh:mm) - Hour:Minute(hh:mm)

**<Procedure>**

Use the arrow keys to move to REC Period. → Press ENTER to show a time entry window. → Use the arrow keys to enter the date and time. → Press ENTER to confirm or ESC to cancel. → Use the arrow keys to move to Time period rec. → Press ENTER to show a time entry window. → Use the arrow keys to enter the time. → Press ENTER to confirm or ESC to cancel.

### Possible Recording Time

Estimated recording time for a 2GB SD memory card

Interval	REC item		Interval	REC item	
	Power	+Harmonics		Power	+Harmonics
1 s	13 days	3 days	1 min	1 year or more	3 months
2 s	15 days	3 days	2 min	2 year or more	6 months
5 s	38 days	7 days	5 min	6 year or more	1 year or more
10 s	2.5 months	15 days	10 min	10 year or more	2 year or more
15 s	3.5 months	23 days	15 min		3 year or more
20 s	5 months	1 months	20 min		5 year or more
30 s	7.5 months	1.5 months	30 min		7 year or more
			1 hour		10 year or more
			2 hours		
			150/180 cycle	23 days	4 days

- \* The above figures do not include power quality event data. If events are recorded, the possible recording time will decrease by the amount of such events. The maximum event data size that can be saved per recording is 1 GB.
- \* The SD memory cards that can be used with this instrument are those provided by YOKOGAWA.

## 5.5 Other Settings

### <Procedure>

Press SETUP. → Use the left and right arrow keys to select the Others tab.

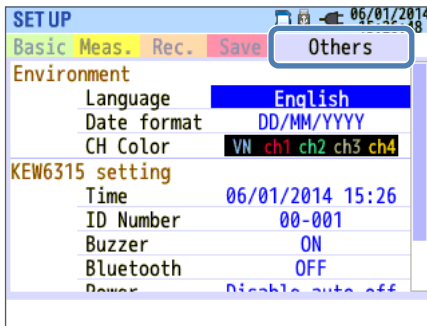

### System Environment Settings

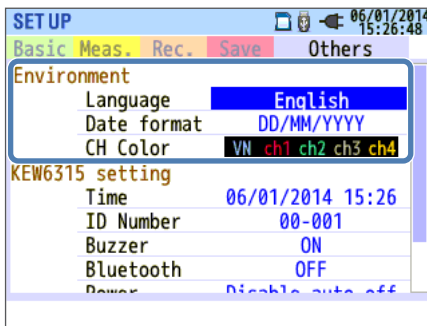

### Language

Select the language to be displayed.

Settings
English*/Japanese/French/Spanish/Polish/Korean/Chinese

\* Default value. However, this setting will not be initialized even when the system is reset.

### <Procedure>

Use the up and down arrow keys to move to Language. → Press ENTER to show a pull-down menu. → Use the up and down arrow keys to select the language. → Press ENTER to confirm or ESC to cancel.

**Date format**

Select the date display format. You can change the display format of all displayed dates, such as the current date shown in the upper right of the screen and the recording start and stop dates that are shown and that you edit.



\* Default value. However, this setting will not be initialized even when the system is reset.

**<Procedure>**

Use the up and down arrow keys to move to Date format. → Press ENTER to show a pull-down menu. → Use the up and down arrow keys to select the format. → Press ENTER to confirm or ESC to cancel.

**CH color**

Specify the colors for voltage and current of each channel. You can change the item label text colors, graph colors, wiring diagram’s channel colors, and so on.

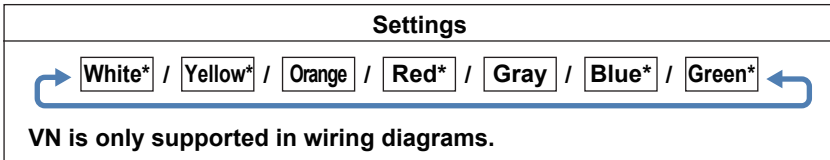

\* The default color settings are VN: Yellow, 1CH: Red, 2CH: White, 3CH: Blue, 4CH: Green. However, these setting will not be initialized even when the system is reset.

**<Procedure>**

Use the arrow keys to move to CH color. → Press ENTER to show a selection window.\* → Use the arrow keys to select the color. → Press ENTER to confirm or ESC to cancel.

## CW500 System Settings

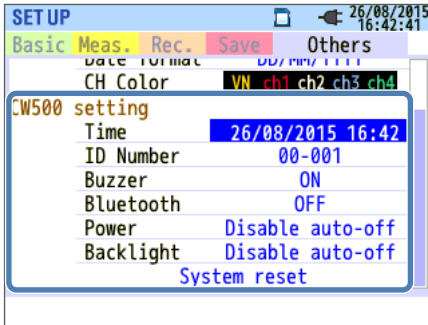

### Time

Set the system clock to the current time.

Settings
yyyy/mm/dd hh:mm

\* The input format is synchronized with the Date format setting.

#### <Procedure>

Use the arrow keys to move to Time. → Press ENTER to show a time entry window. → Use the arrow keys to select the date and time. → Press ENTER to confirm or ESC to cancel.

### ID Number

Set the CW500 ID number. Assigning numbers in an organized manner will make it convenient to analyze recorded data when several CW500s are used or when several locations are measured periodically using a single CW500.

Settings
00-001~99-999(00-001*)

\* Default value

#### <Procedure>

Use the arrow keys to move to ID Number. → Press ENTER to show a value entry window. → Use the arrow keys to enter the ID number. → Press ENTER to confirm or ESC to cancel.



### Buzzer

Turn on or off the keypad sound. Warning buzzers for demand judgment and low battery are not affected by this setting.

<b>Settings</b>
On*/Off

\* Default value

#### <Procedure>

Use the up and down arrow keys to move to Buzzer. → Press ENTER to show a pull-down menu. → Use the up and down arrow keys to select on or off. → Press ENTER to confirm or ESC to cancel.

### Bluetooth® (option)

Enable or disable the built-in Bluetooth® function. Disable it when you are not using Bluetooth® communication.

<b>Settings</b>
On/Off*

\* Default value

#### <Procedure>

Use the up and down arrow keys to move to Bluetooth®. → Press ENTER to show a pull-down menu. → Use the up and down arrow keys to select on or off. → Press ENTER to confirm or ESC to cancel.

## Power

Enable or disable the auto-power-off function. If the CW500 is running off of batteries, “Disable auto-off” cannot be selected in order to save battery power.

Mode	Settings
AC power	Power off in 5 min./Disable auto-off*
Battery	Power off in 5 min.

\* Default value

### <Procedure>

Use the up and down arrow keys to move to Power. → Press ENTER to show a pull-down menu. → Use the up and down arrow keys to enable auto-power-off. → Press ENTER to confirm or ESC to cancel.

## Backlight

Select whether to turn off the backlight automatically when there is no user interaction for a given period. If the CW500 is running off of batteries, “Disable auto-off” cannot be selected in order to save battery power.

Mode	Settings
AC power	Power off in 5 min./Disable auto-off*
Battery	Power off after 2 min.

\* Default value

### <Procedure>

Use the up and down arrow keys to move to Backlight. → Press ENTER to show a pull-down menu. → Use the up and down arrow keys to enable or disable the backlight auto-off function. → Press ENTER to confirm or ESC to cancel.

## System reset

This restores all the settings to their defaults except for Language, Date format, CH Color, and Time.

### <Procedure>

Use the up and down arrow keys to move to System reset. → Press ENTER to show a confirmation message. → Use the left and right arrow keys to select Yes or NO. → Press ENTER to confirm.

## 5.6 Saved Data

### <Procedure>

Press SETUP. → Use the left and right arrow keys to select the Saved data tab.

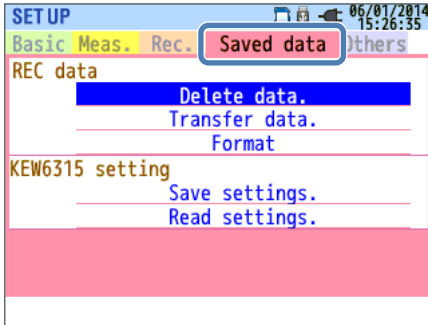

You can save measured data, screenshots, and setup data to the SD memory card or internal memory. If an SD memory card is inserted in the instrument, data will be automatically saved to the card. Do not insert an SD memory card if you want to save to the internal memory. You cannot set the save destination.

We recommend that you save data to an SD memory card. Up to three measured data files and eight other files can be saved to the internal memory.

### Recorded Data Operation

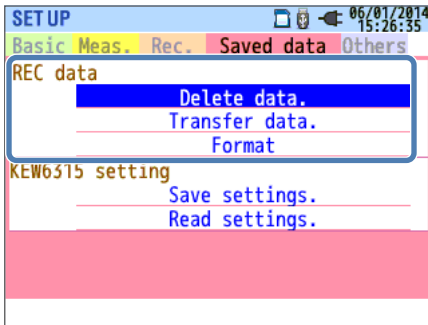

### <Procedure>

Use the up and down arrow keys to move to the desired operation. → Press ENTER to confirm.

## Delete data

This is used to delete measured data, screenshots, and setup data from the SD memory card or internal memory. Be careful when deleting data files because they are not sorted by recording date. The data recording dates are listed to the right of file names. Note that dates of data files transferred from the internal memory to an SD memory card are the dates when they were transferred. A scroll bar appears when not all the data can be displayed on the screen.

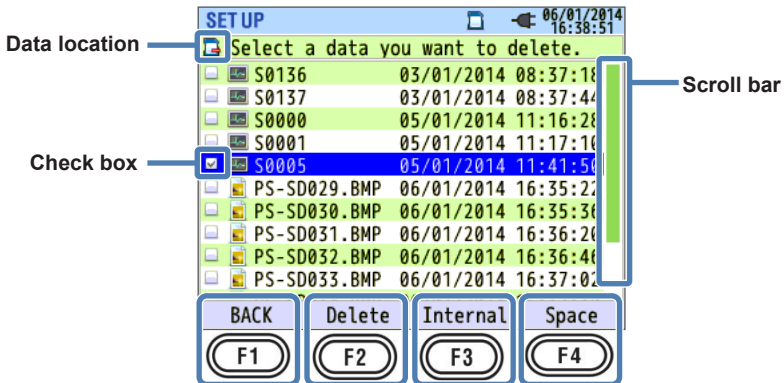

### <Procedure>

Use the up and down arrow keys to move to the data you want to delete.

→ Press ENTER to select it. → Press F2 to show a delete confirmation message. → Use the left and right arrow keys to select Yes or NO. → Press ENTER to confirm.

When you select a data file, the corresponding check box is selected. You can delete several data files at once.

## Delete

Press F2 (delete) to show a confirmation message. Select “Yes” to delete the data.

## Internal/SD card

Press F3 to switch between the SD memory card and internal memory.

The selected medium is displayed in the upper left of the screen.

Switching the screen clears all the selected check boxes.

### Space

Press F4 (free space) to display a pop-up screen showing the selected medium information. Press ENTER to return to the data deletion screen.

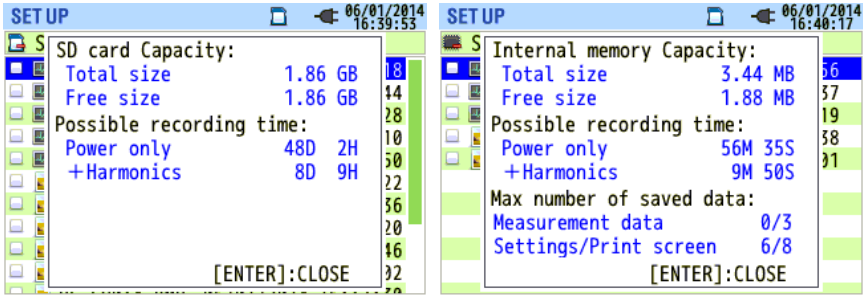

Item		Displayed Information
Capacity	Total size	Size of used space + free space
	Free size	Size of free space only
Possible recording time	Power only	Estimated possible recording time when only power parameters are recorded
	Power+Harmonics	Estimated possible recording time when power and harmonic parameters are recorded
Max number of saved data * Internal memory only	Measured data	Number of completed measurements * The maximum number of files that can be saved in the internal memory is three.
	Settings/ Print screen	Number of recorded settings and screenshots * The maximum number of files that can be saved in the internal memory is eight.

### Back

Press F1 (back) to return to the Saved data screen.

## Transfer data

This is used to transfer measured data, screenshots, and setup data from the internal memory to an SD memory card. Be careful when transferring data files because they are not sorted by recording date. The data recording dates are listed to the right of file names. Note that dates of data files transferred from the internal memory to an SD memory card are the dates when they were transferred. A scroll bar appears when not all the data can be displayed on the screen.

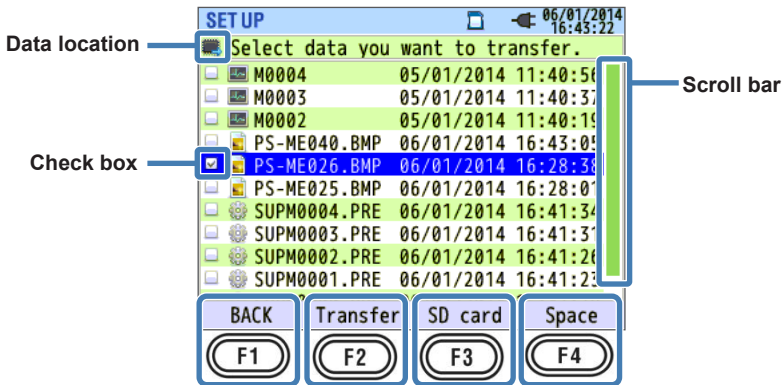

### <Procedure>

Use the up and down arrow keys to move to the data you want to transfer.

→ Press ENTER to select it. → Press F2 to show a delete confirmation message.

→ Use the left and right arrow keys to select Yes or NO. → Press ENTER to confirm.

When you select a data file to be transferred, the corresponding check box is selected. You can transfer several data files at once.

## Transfer

Press F2 (transfer) to show a confirmation message. Select "Yes" to transfer the data.

## SD card

Press F3 (SD memory card) to view the data stored in the transfer destination SD memory card. To return to the transfer data selection screen, press F3 (internal memory) again. Switching the screen clears all the selected check boxes.

### Free size

Press F4 (free space) to display a pop-up screen showing the selected medium information. Press ENTER (close) to return to the data transfer screen.

For details, see “Space” on page 5-38.

### Back

Press F1 (back) to return to the Saved data screen.

### Format

This is used to format an SD memory card or internal memory.

When you format, all the saved data will be deleted. Save necessary data to a different storage medium before formatting.

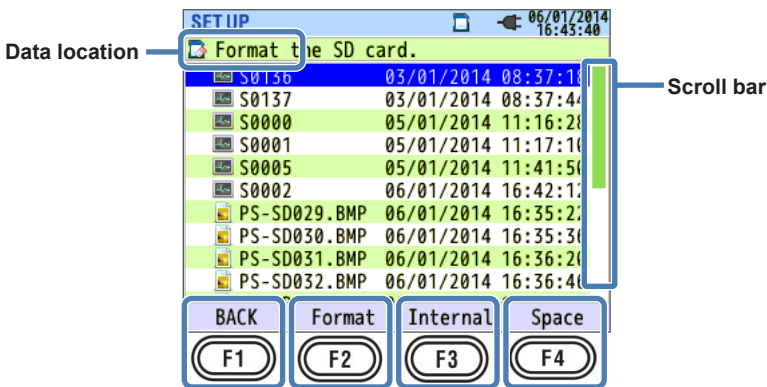

### <Procedure>

Press F2 to show a format confirmation message. → Use the left and right arrow keys to select Yes or NO. → Press ENTER to confirm.

### Format

Press F2 (format) to show a confirmation message. Press ENTER (yes) to start formatting.

**Internal/SD card**

Press F3 (internal memory/SD memory card) to switch the target medium. The selected medium is displayed in the upper left of the screen.

**Free size**

Press F4 (free space) to display a pop-up screen showing the selected medium information. Press ENTER (close) to return to the format screen.

For details, see “Space” on page 5-38.

**Back**

Press F1 (back) to return to the Saved data screen.



## Types of Saved Data

### File Name

File names are automatically assigned with incrementing file numbers. As the current file number is retained even when the power is turned off, it will keep incrementing until the system is reset or until the maximum count is reached. Even if you change the save destination, files are saved with serial numbers.

If a file with the same file number already exists at the save destination, the measured data file name is automatically incremented to the next number. Screenshot data and setup data are overwritten with the same file names. Be careful when you reset the system and start saving the files from number zero and when sharing a single SD memory card between several CW500s. Note that if all the file numbers from 0 to 9999 are used up, measured data files are also overwritten.

If files are deleted or the folder or files are renamed from a PC or the like, data operations on the CW500 and analysis using CW500 Viewer will no longer be possible. Do not change folder names or file names from a PC.

### Print screen

Press PRINT SCREEN to save a screen image as BMP data.

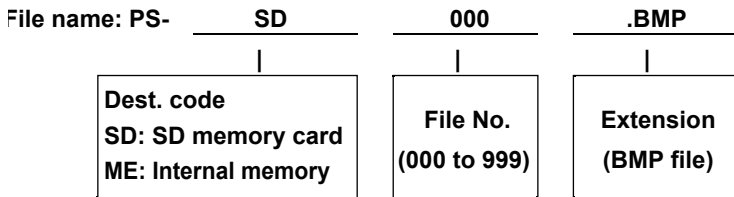

### System settings

Press SETUP, and select Saved data and then Save Settings to save the CW500 setup data.

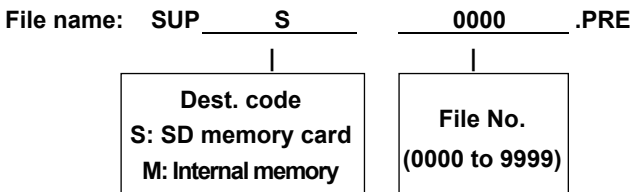

## Data folder

A new folder is created for every measurement to save interval and power quality data.

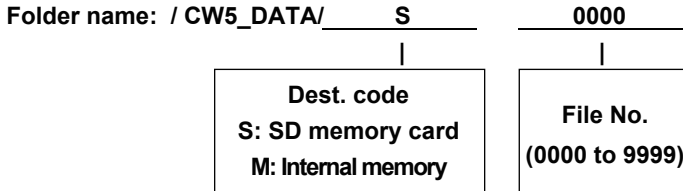

## Interval data

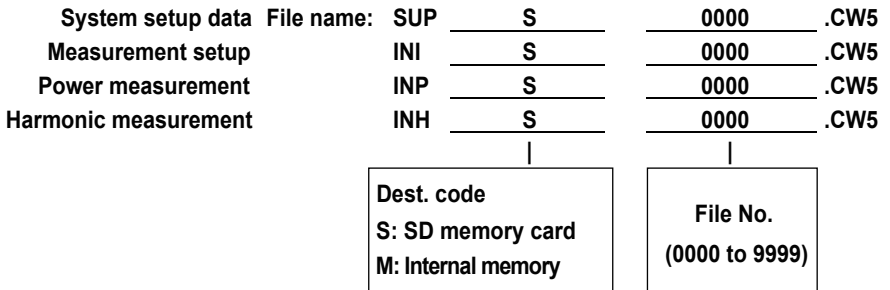

## Power quality data

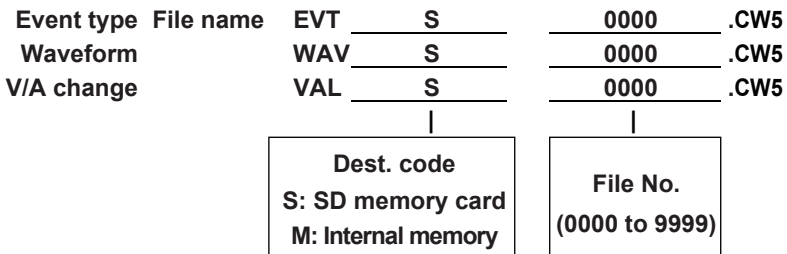

## Saving and Loading System Settings

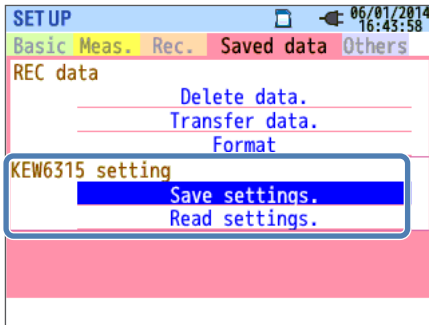

### <Procedure>

Use the up and down arrow keys to move to the desired operation. → Press ENTER to confirm.

### Save settings

This is used to save the setup data to an SD memory card or internal memory. Note that data files are not sorted by recording date. The data recording dates are listed to the right of file names. Note that dates of data files transferred from the internal memory to an SD memory card are the dates when they were transferred. A scroll bar appears when not all the data can be displayed on the screen.

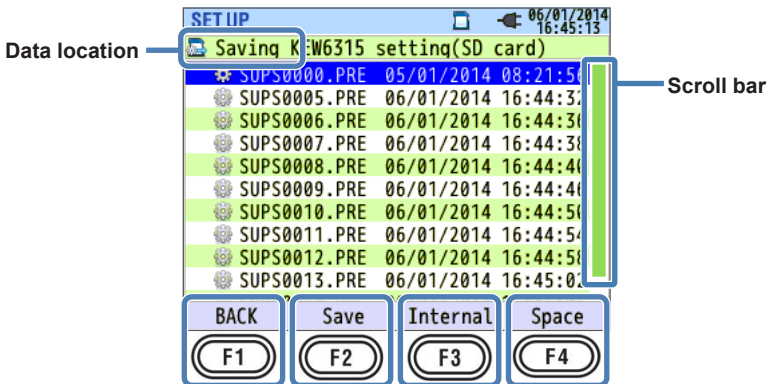

### <Procedure>

Press F2 to show a save confirmation message. → Use the left and right arrow keys to select Yes or NO. → Press ENTER to confirm.

## Save

Press F2 (save) to show a confirmation message. Select Yes to save the system settings to the SD memory card or internal memory.

## Internal/SD card

Press F3 (internal memory/SD memory card) to change the save destination. The current save destination is displayed with a mark in the upper left of the screen.

## Free size

Press F4 (free space) to display a pop-up screen showing the selected medium information. Press ENTER (close) to return to the data transfer screen.

For details, see “Space” on page 5-38.

## Back

Press F1 (back) to return to the Saved data screen.

## Settings That Are Saved

### Basic Setup

Settings
Wiring
Voltage range
VT ratio
Nominal voltage
Clamp/Current range
CT ratio
DC range
Frequency

### Other Setup

Settings	
Environment	Date format
System settings	ID number
	Buzzer

### Measurement Setup

Settings	
Demand	Measurement interval
	Inspection cycle
	Target value
Harmonics	THD (total harmonic distortion) calculation method
	Allowable range
	MAX hold
Power quality	Hysteresis threshold
	Transient threshold
	Swell threshold
	Dip threshold
	Interruption threshold
	Inrush current threshold
Flicker	Filter coefficient (ramp)
Phase advance capacitor	Target power factor

**Recording setup**

Settings		
REC item	Harmonics	
	Power quality (event)	
Record method	Interval	
	Start	
Constant rec.	Start date/time	
	Stop date/time	
Time period rec.	REC period	Start—Stop
	REC time slot	Start—Stop

**Read settings**

This is used to read setup data from an SD memory card or internal memory to change the system settings. Note that data files are not sorted by recording date. The data recording dates are listed to the right of file names. Note that dates of data files transferred from the internal memory to an SD memory card are the dates when they were transferred. A scroll bar appears when not all the data can be displayed on the screen.

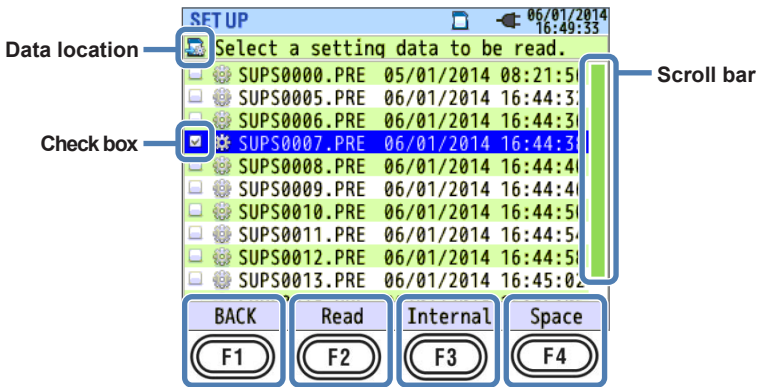

**<Procedure>**

Use the up and down arrow keys to move to the data you want to transfer.

- Press ENTER to select it.
- Press F2 to show a read confirmation message.
- Use the left and right arrow keys to select Yes or NO.
- Press ENTER to confirm.

When you select a data file you want to read, the corresponding check box is selected.

**Read**

Press F2 (read) to show a confirmation message. Select Yes to transfer the data.

**Internal/SD card**

Press F3 (internal memory/SD memory card) to change the save destination. The current save destination is displayed with a mark in the upper left of the screen.

**Free size**

Press F4 (free space) to display a pop-up screen showing the selected medium information. Press ENTER (close) to return to the data transfer screen.

For details, see “Space” on page 5-38.

**Back**

Press F1 (back) to return to the Saved data screen.

## 6.1 Instantaneous Value (W)

### <Procedure>

Press W/Wh. → Press F1 to display the instantaneous value (W) screen.

### Displaying a List of Measurements

Press F2 to display a list.

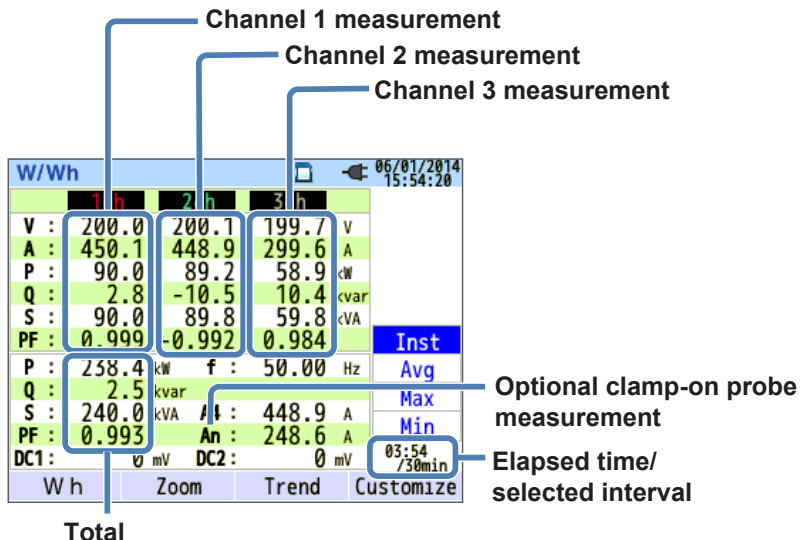

Multiple measurement values are displayed on a single screen. The displayed items and their display positions can be changed using keys.

## 6.1 Instantaneous Value (W)

Display Symbol										
V <sup>1</sup>	Phase voltage			VL <sup>1</sup>	Line voltage			A	Current	
P	Active power	+	Consumption	Q	Reactive Power	+	Lag	S	Apparent power	
		-	Regeneration			-	Lead			
PF	Power factor	+	Lag	f	Frequency					
		-	Lead							
DC1	Analog input channel 1 voltage			DC2	Analog input channel 2 voltage					
An <sup>2</sup>	Neutral line current			PA <sup>3</sup>	Voltage-current phase difference	+	Lag	C <sup>3</sup>	Phase advance capacitor capacitance	
				-		Lead				

- 1 The V and VL displays can be customized when 3P4W is selected.
- 2 “An” appears only when 3P4W is selected.
- 3 PA and C can be displayed pressing F4 (customization). Line voltages are converted into phase voltages to determine currents and phase angles for “PA” of 3P3W3A.

Example: Instantaneous values measured under 1P3W-2 (2 systems)

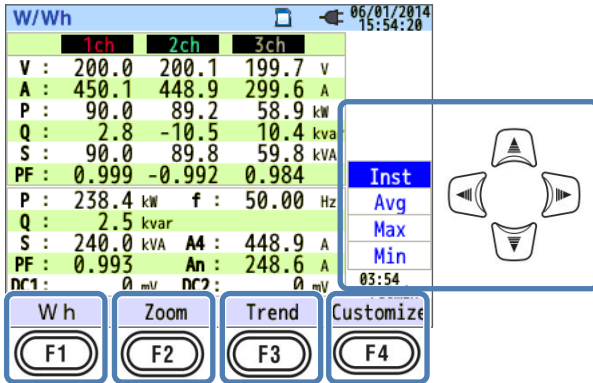



## Changing the Displayed Systems

Use the left and right arrow keys to change the displayed systems. Items displayed on the screen depend on the selected wiring system and the number of systems. The dotted lines represents the range that can be displayed on a single screen.

### 1P2W-1 to -4 (single-phase two-wire, system 1, 2, 3, or 4)

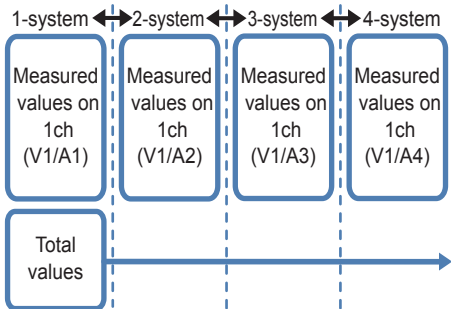

### 1P3W-1 to -2 (single-phase three-wire, system 1 or 2)

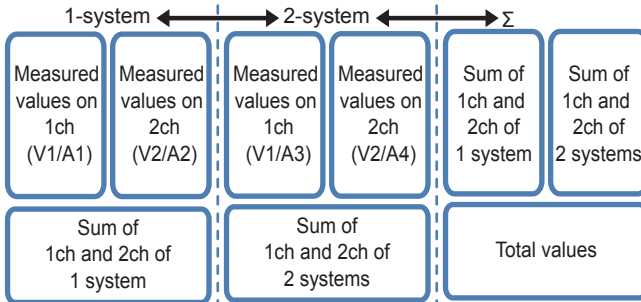

### 1P3W-1 to -2 (three-phase three-wire two-wattmeter, system 1 or 2)

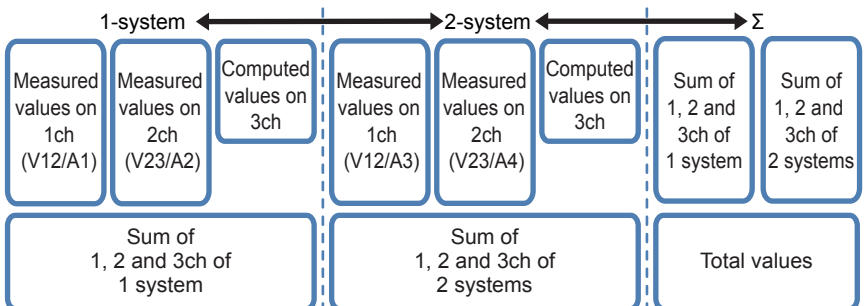

**3P3W3A (three-phase three-wire) 3P4W (three-phase four-wire)**

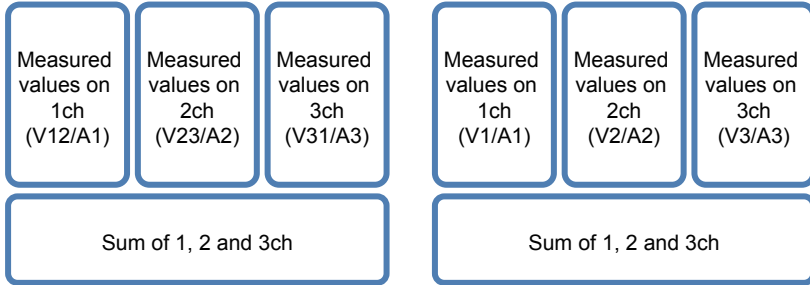

**Changing the Type of Displayed Values**

Use the up and down arrow keys to change the display type between instantaneous values or average, maximum, or minimum within the interval.

If the interval is set to 1 second, the instantaneous, average, maximum, and minimum values will all be the same because the display update rate is also 1 second.

**Wh (Integrated value)**

Press F1 (Wh) to switch to a screen that shows integrated values. For details, see section 6.2, “Integrated Value (Wh)” on page 6-9.

**Zoom**

Press F2 (zoom) to switch between zooming in on four selected measurement values or eight selected measurement values. For details, see “Zoom Display” on page 6-5.

**Trend graph**

Press F3 (trend) to switch to a screen that shows the trends of display items in a graph. The display range is from the present to the past 60 minutes. For details, see “Displaying a Trend Graph” on page 6-7.

**Customize**

Press F4 (customize) to change the displayed items and their display positions. For details, see “Changing Displayed Items and Display Positions” on page 6-8.

## Zoom Display

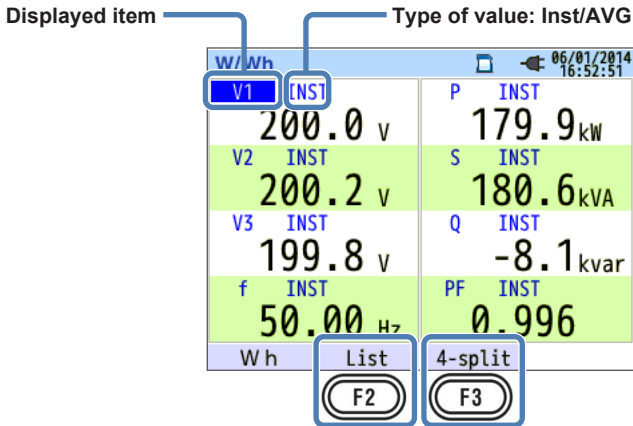

The selected four or eight measured values are displayed on one screen. Measured values are easier to read because the text is larger than that on the list screen.

## Displayed Items

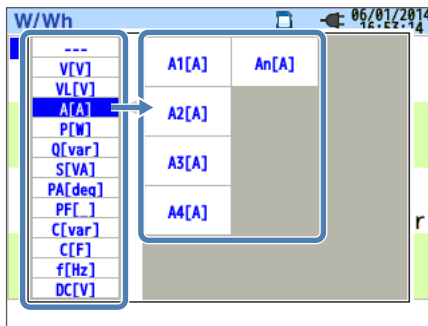

Select the measurement items you want to display. From the list of measurement items in the left menu, select the items you want to display. The right menu will display the measurement item with channels that you can choose from. From the right menu, select the measurement items you want to display.

### <Procedure>

Use the arrow keys to move to the item you want to display. → Press ENTER to show a selection menu. → Use the arrow keys to select an item. → Press ENTER to confirm or ESC to cancel.

### Type of Value

For the selected measurement item, select whether to display the instantaneous value (INST) or the average (AVG), maximum (MAX), or minimum (MIN) value among the data values that were measured in the interval. If the interval is set to 1 second, the instantaneous, average, maximum, and minimum values will all be the same because the display update rate is also 1 second.

#### <Procedure>

Use the arrow keys to move to the type of value you want to display. → Press ENTER to show a pull-down menu. → Use the arrow keys to select a type. → Press ENTER to confirm or ESC to cancel.

### List Display

Press F2 (list) to display all the values in a list.

### 4-split/8-split

Press F3 (4-split/8-split) to set the number of items to display on one screen to four or eight.

## Displaying a Trend Graph

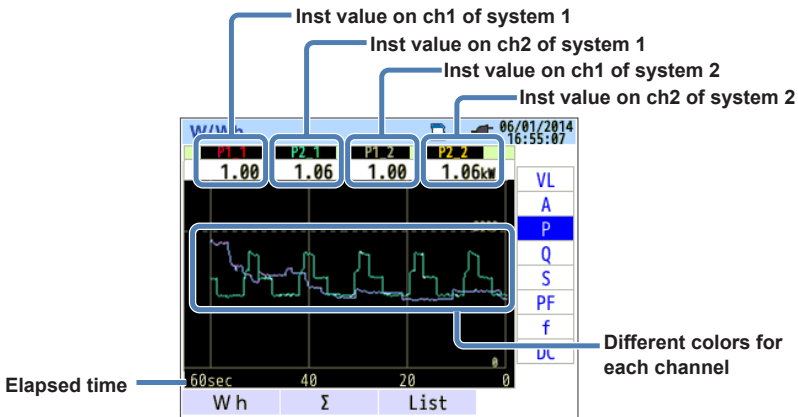

You can select measured values and graph their variation with time.

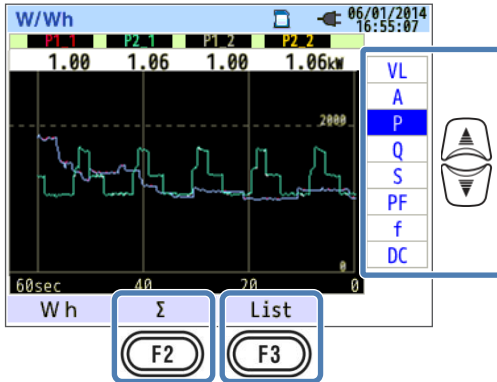

## Changing the Items Displayed on the Trend Graph

Use the up and down arrow keys to change the items to display on the trend graph.

## $\Sigma$ /CH

Press F2 ( $\Sigma$ /CH) to switch between trend graphs of the sum for each system and the total sum and trend graphs of each channel. The selection of " $\Sigma$ " or "CH" will apply to all trend graphs. Selecting  $\Sigma$  will display the trend graph of the sum of each system and the total sum. Selecting CH will display the trend graph of each channel. If you select " $\Sigma$ " when rms current value (A) is selected for 3P4W, neutral line currents ( $A_n$ ) will be displayed on the trend graph.

## List Display

Press F3 (list) to display all the values in a list.

## Changing Displayed Items and Display Positions

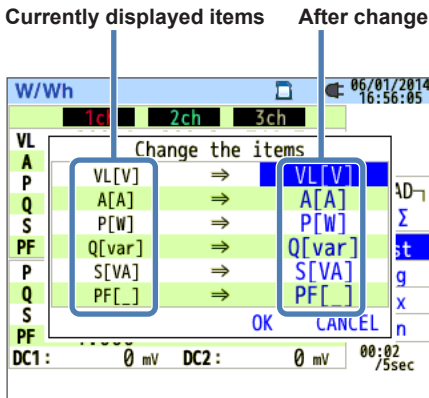

You can change the displayed items.

### <Procedure>

Use the up and down arrow keys to move to the item you want to change.

→ Press ENTER to show a pull-down menu. → Use the up and down arrow keys to select a measurement item you want to display. → Press ENTER to confirm or ESC to cancel. → Use the left and right arrow keys to select OK or Cancel. → Press ENTER to confirm or ESC to cancel.

Voltage and current measurement items can only be changed other voltage and current measurement items. Likewise, power and phase advance capacitor measurement items can only be changed to other power and phase advance capacitor measurement items.

For details on the symbols displayed on the screen, see “Displaying a List of Measurements” on page 6-2.

## 6.2 Integrated Value (Wh)

### <Procedure>

Press W/Wh. → Press F1 to display the integrated value (Wh) screen.

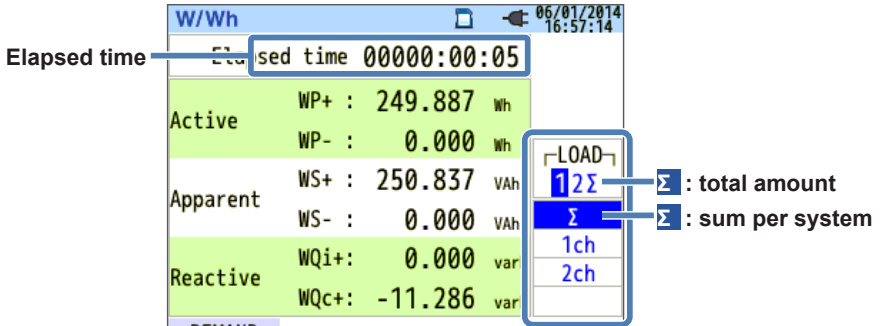

The power that flows during a given period is displayed as integrated power.

Display Symbol											
WP	Active energy	+	Consumption	WQ	Var hours	+	Lag	WS	Volt-ampere hours	+	Consumption
		-	Regeneration			-	Lead			-	Regeneration

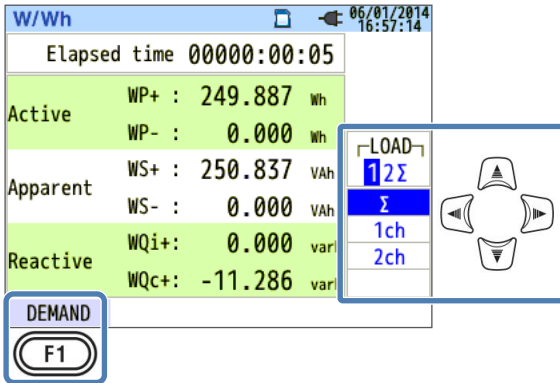

### Changing the Displayed Systems

Use the left and right arrow keys to change the displayed systems. For the relationship between wiring and the number of systems, see “Wiring System Settings” in section 5.2.

### Changing the Displayed Channels

Use the up and down arrow keys to change the displayed channels. For the relationship between wiring and channels, see “Wiring System Settings” in section 5.2.

### Demand

Press F1 (demand) to switch to a screen that shows demand values. For details, section 6.3, “Demand,” on the next page.



## 6.3 Demand

### <Procedure>

Press W/Wh. → Press F1 to display the demand screen. → Use the up and down arrow keys to display the measured value, shift in specific period, or demand change screen

### Displaying Measured Values

Use the up and down arrow keys to display the measured value screen.

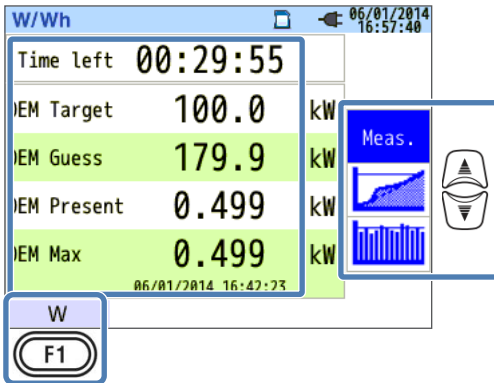

The demand is an average power over a given period. When the estimated value exceeds the target value during demand measurement, a warning buzzer sounds at each inspection cycle.

Display Items	
Remaining time (time left)	Demand interval is counted down.
DEM Target	Demand target value.
DEM Guess	Estimated demand value after the measurement interval of the current load. ( Present value×Measurement interval )/Elapsed time is calculated as time elapses.
DEM Present	Demand value (average power) within a demand interval. (WP+ x 1 hour) / Interval is calculated as time elapses.
DEM Max Recorded date	The maximum demand recorded during a measuring period is displayed. The display is updated each time the measured value exceeds the maximum demand.

### Instantaneous Value (W)

Press F1 (W) to show instantaneous values on the screen. For details, see section 6.1, "Instantaneous Value (W)."

### Shifts in Specific Period

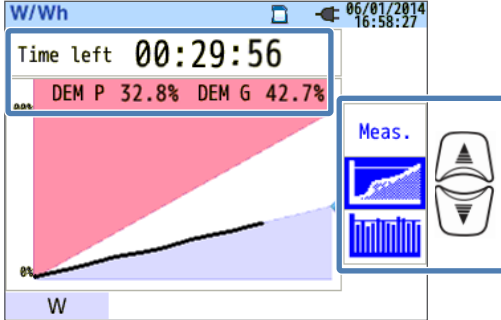

Display Items	
Remaining time (time left)	Demand interval is counted down.
DEM P	The present value as a percentage of the target value.
	$\frac{\text{Present value}}{\text{Target value}}$ is displayed.
DEM G	The estimated value as a percentage of the target value.
	$\frac{\text{Estimated value}}{\text{Target value}}$ is displayed.

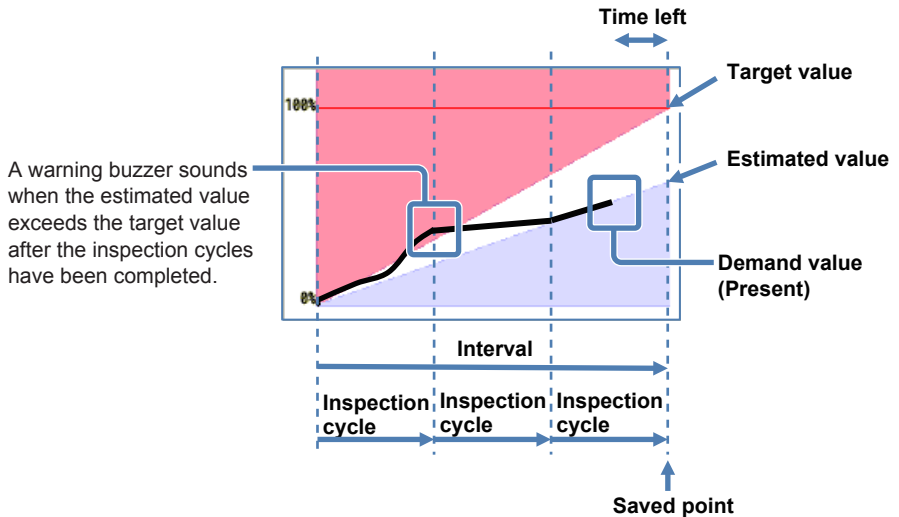

## Demand change

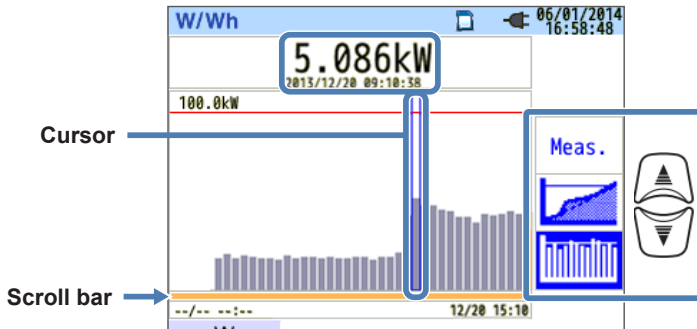

Use the left and right arrow keys to move the cursor and scroll the graph horizontally. The white area of the scroll bar shows the entire measurement period while the dark orange area shows the present display range.

Display Items	
Demand measurement/ Recorded date	Demand value at the cursor is displayed with the recorded date and time.

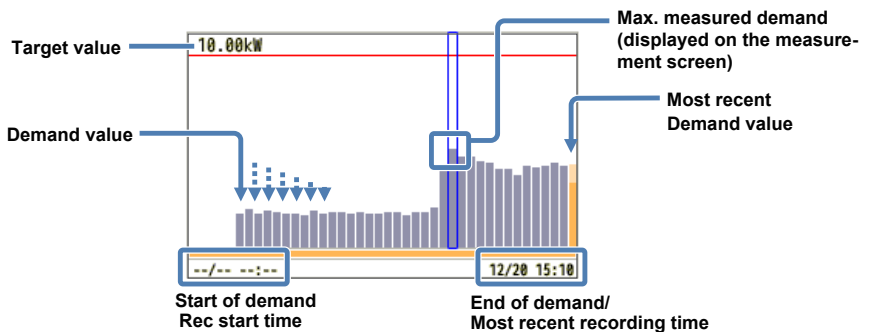

Start of demand and recording start date and time are displayed when the graph does not fit on one screen.

# 6.4 Vector

Press the vector key.

**Vector display**

**Measured values**

V: rms voltage<sup>1</sup> /Phase angle<sup>2</sup>

A: rms current /Phase angle<sup>2</sup>

1 For 3P3W3A, rms line voltages are displayed.

2 Phase angle is displayed using the V1 phase as the reference (0°).

**Solid circle line: Maximum voltage/current range**

**Vector display**

rms voltage (solid line)

rms current (dotted line)

±180°

The circle (solid line) represents the maximum values of the voltage and current ranges. The line length represents rms voltage and current values. The angle between the lines represents the phase relation with reference to V1. For 3P3W3A/3P4W, unbalance ratio is also displayed. While the measured voltages and currents are balanced, the following vectors will be displayed.

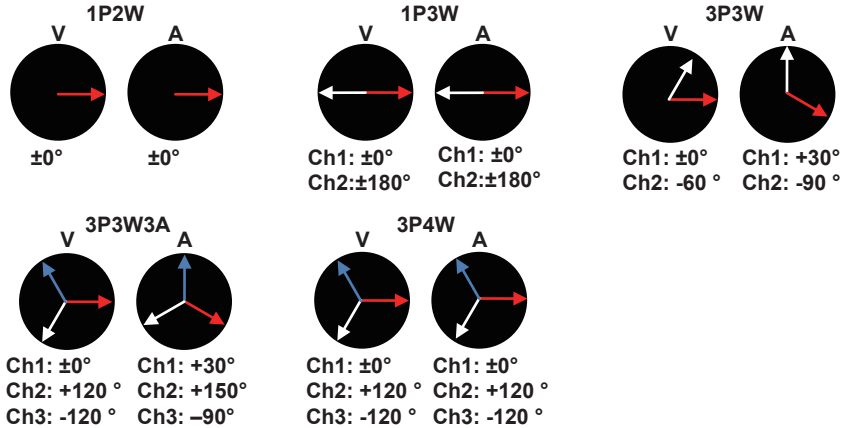

The following figure is an example of 3P4W.

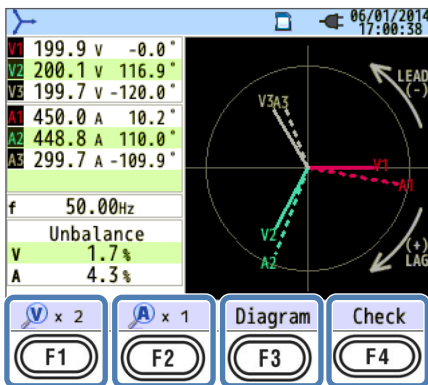

### **V × Magnification**

Press F1 (V×magnification) to set the magnification of the length of voltage vector lines.



### **A × Magnification**

Press F2 (A×magnification) to set the magnification of the length of current vector lines.



### **Wiring Diagrams**

Press F3 (diagram) to show the wiring diagram of the selected wiring system. For details, see “Wiring Diagram” in section 5.2.

### **Wiring Check**

Press F4 (wiring check) to display the results of the wiring check.

If measuring at site with extremely poor power factor, this check may fail even if the wiring is correct. For details, see “Wiring Check” in section 4.2.

## 6.5 Waveform

Press the waveform key.

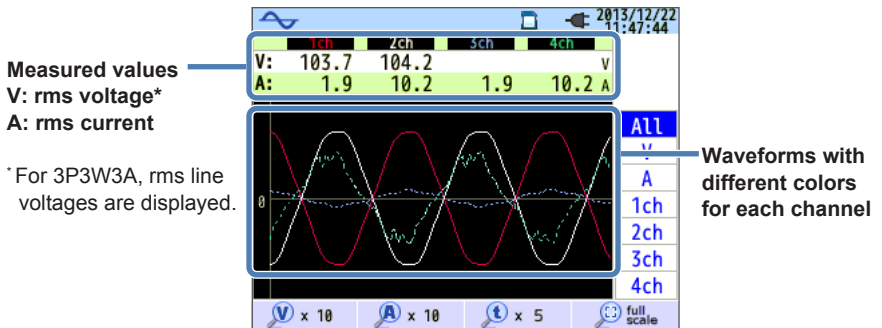

Voltage and current waveforms are displayed for up to 10 cycles at 50 Hz and up to 12 cycles at 60 Hz. If switched to the waveform screen, the scale is automatically set so that the waveform amplitude and period are displayed at their maximum size.

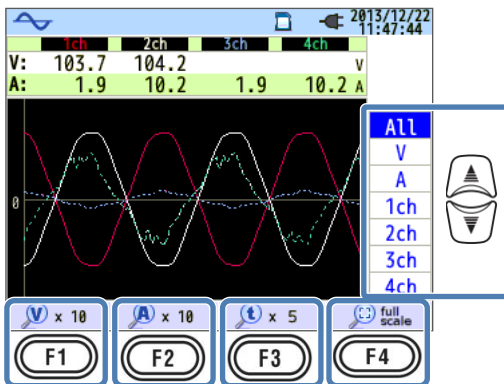

### Changing the Displayed Waveforms

Use the up and down arrow keys to change the displayed waveforms.

### **V × Magnification**

Press F1 (V×magnification) to set the vertical magnification of the voltage waveform.

0.1x, 0.5x, 1x, 2x, 5x, 10x

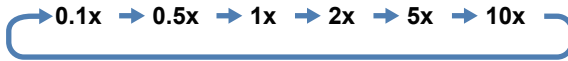

### **A × Magnification**

Press F2 (A×magnification) to set the vertical magnification of the current waveform.

0.1x, 0.5x, 1x, 2x, 5x, 10x



### **t × Magnification**

Press F3 (t×magnification) to set the time-axis (horizontal) magnification.  
1x, 2x, 5x, 10x



### **full scale**

Press F4 (full scale) to set a magnification that displays the voltage and current waveforms at their maximum size.



## 6.6 Harmonics

Press the harmonic analysis key.

### Displaying Harmonics on a Bar Graph

Press F1 (graph) .



Display Symbol			
V	Voltage * For 3P3W3A, rms line voltages are displayed.		A Current
THD	Voltage total harmonic distortion is displayed while "V" is displayed. Current total distortion factor is displayed while "A" is displayed. Total harmonic distortion is calculated according to the selected THD calculation method.		
P	Active power of each channel	+ In — Out	$\Sigma P$ System total/total sum Active power + In — Out

### Bar Graph Display

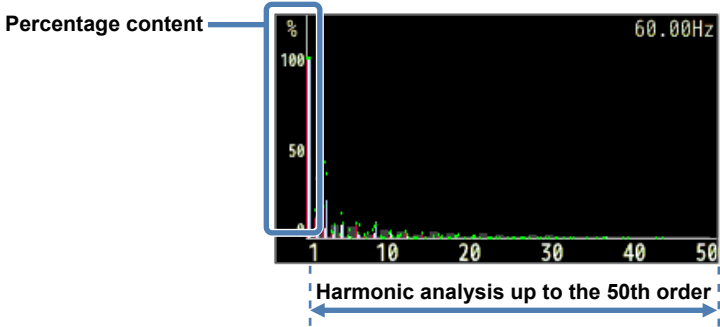

In the above example, “Linear” and “full-scale” are selected. In this case, the upper limit of the percentage content is “100%” and all harmonics, 1st to 50th, are displayed on one screen.

Display Items	
Percentage content	Percentage content of each harmonic in reference to the fundamental waveform.

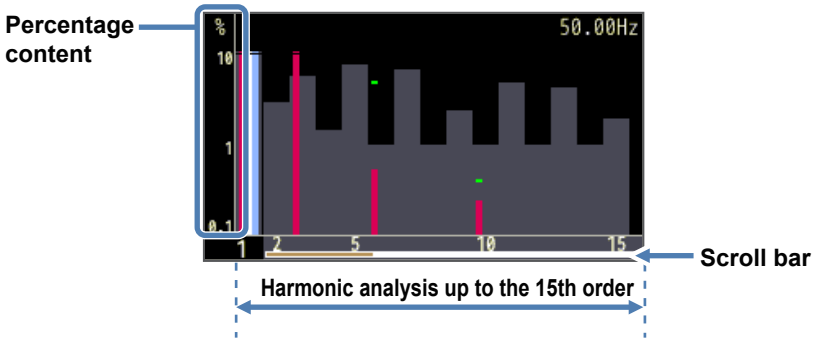

In the above example, “log” and “zoom” are selected. In this case, the upper limit of the percentage content is “10 %” and harmonics up to the 15th are displayed on one screen. Press the left and right arrow keys to scroll the display range. The dark orange area of the scroll bar shows the present display range.

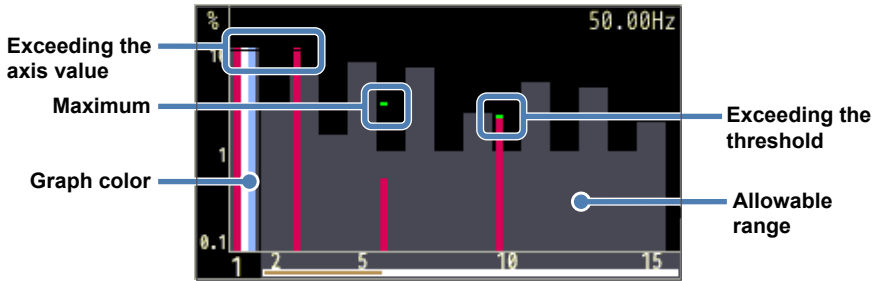

Display Items	
Exceeding the axis value	Displayed when the relative harmonic content of each order is more than 10%. Because the percentage content of the fundamental waveform is “100%,” it always exceeds the axis value in “LOG” display.
Maximum	The maximum values since the start of measurement are displayed. These values can be reset by changing the setting, starting a recording, or holding down ESC for at least 2 seconds. It cannot be reset, however, while recording is in progress.
Graph color	If there are many measurement channels, graphs are displayed with different colors for each channel.
Exceeding the threshold	Displayed when measured values exceed the preset allowable range.
Allowable range	This is preset according to IEC61000-2-4 Class 3. To change the range, select “Edit allowable range” in the harmonic items of SETUP.



## Changing the Displayed Channels

Use the up and down arrow keys to change the displayed channels. For the relationship between wiring and channels, see “Wiring System Settings” in section 5.2.

## List/Graph

Press F1 (list/graph) to display voltage, current, power harmonics, from 1st to 50th order, in a list. The bar graph displays only the percentage content, but the list displays rms values, percentage content, or phase angle,\* whichever you select.

\* While “P” (power) is played, phase differences between voltage and current are displayed. Inflow is  $\pm 0^\circ$  to  $\pm 90^\circ$  and outflow  $\pm 90^\circ$  to  $180^\circ$ .

## Log/Linear

Press F2 (log/linear) to change the upper limit of percentage content (vertical axis of the bar graph) to 10% and display the bar graph. This is useful for analyzing low-level harmonics.

## Full/zoom

Press F3 (zoom/full) to display the entire harmonics from 1st to 50th or zoom up to the 15th harmonic. Voltage, current, and power harmonics can be displayed separately in bar graphs. When zoomed up to the 15th harmonic, use the left and right arrow keys to scroll the screen (change the display range).

**V/A/P/ΣP**

Press F4 (V/A/P/ΣP) to select the harmonic analysis parameter (voltage, current, power, or system total or total sum power).

**Displaying a List of Harmonics**

Press F1 to display a list of harmonics.

P	P1.1	P2.1	P1.2	P2.2
1	88.5	89.1	-20.4	89.1 kW
2	0.0	0.0	0.0	0.0 kW
3	0.0	0.0	0.0	0.0 kW
4	0.0	0.0	0.0	0.0 kW
5	0.0	0.0	0.0	0.0 kW
6	0.0	0.0	0.0	0.0 kW
7	0.0	0.0	0.0	0.0 kW
8	0.0	0.0	0.0	0.0 kW
9	0.0	0.0	0.0	0.0 kW
10	0.0	0.0	0.0	0.0 kW
11	0.0	0.0	0.0	0.0 kW

The voltage, current, rms value of power harmonics, percentage content, and phase angle, from 1st to 50th order, in a list.

Display Symbol							
V	Voltage <sup>1</sup>			A	Current		
P <sup>2</sup>	Active power of	+	In	ΣP <sup>2</sup>	System total/total sum	+	In
	each channel	-	Out		Active power	-	Out

- 1 For 3P3W3A, rms line voltages are displayed.
- 2 The letters and numbers displayed at the top represent the displayed parameter and the channel or system number. If there is a space between the letter P and the number, only the system number is displayed. In this case, the measured values are the sum of each system. If only P is displayed, the measured values are total sums.

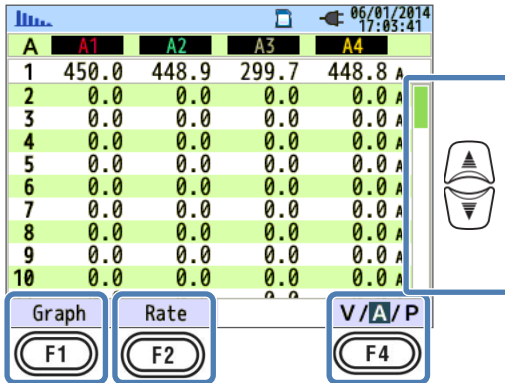

### Changing the Displayed Harmonic Orders

Use the up and down arrow keys to vertically scroll the screen thereby changing the displayed orders.

### Graph/List

Press F1 (graph/list) to display voltage, current, power harmonics, from 1st to 50th order, in bar graphs. On the bar graph screen, only the percentage content is displayed.

### Percentage Content, Phase Angle, RMS Value (Power)

Press F2 (percentage content/phase angle/rms value (power)) to change the measurement items displayed in the list. If V (voltage) or A (current) is selected, select percentage content, phase angle (in reference to V1 (0°)), or rms value. If P ( $\Sigma P$ ) (power) is selected, select percentage content, phase angle (current-to-voltage difference between channels), or power.

### V/A/P/ $\Sigma P$

Press F4 (V/A/P/ $\Sigma P$ ) to select the harmonic analysis parameter (voltage, current, power, or system total or total sum power).

## 6.7 Power Quality

Press QUALITY.

### Factors That Degrade Power Quality and Symptoms

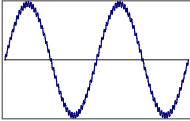
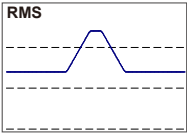
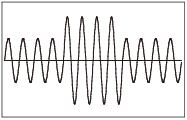
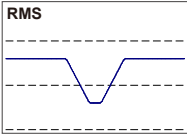
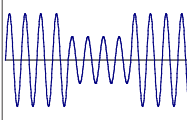
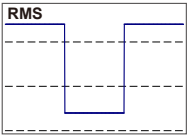
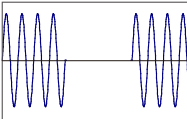
Event	Waveform	Symptoms	Adverse Effects
Harmonics		The device control circuit uses an inverter (capacitor input full-wave rectifier) and thyristor (phase-control) circuits. These circuits cause current distortion, which generates harmonics.	Harmonic currents can cause phase advance capacitor and reactor burnouts, transformer buzz, circuit breaker malfunction, flicker in TV images, and noises in audio devices.
Voltage swell	 	Inrush current occur when the power line switch is turned on causing the voltage to increase temporarily.	Equipment, robots, and other machines may shut down, or PCs and office appliances may be reset.
Voltage dip	 	Inrush current occurs when motors and other loads are applied causing the current to dip.	
Voltage interruption	 	Lightning and other electric surges interrupt the power supply.	

## 6.7 Power Quality

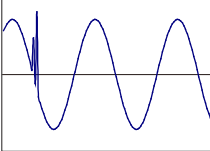
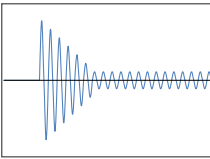
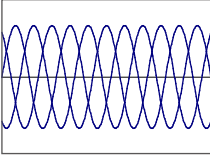
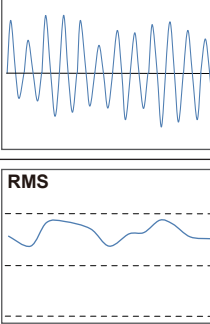
Event	Waveform	Symptoms	Adverse Effects
<p>Transient overvoltage (impulse)</p>		<p>Transient overvoltage occurs due to contact failure with circuit breakers, magnets, or relays.</p>	<p>The sudden voltage change (spike) causes damage to devices' power supplies or causes devices to reset.</p>
<p>Inrush current</p>		<p>Instantaneous large current (surge) flows through devices with a motor, incandescent lamp, or flat capacitor when they are powered on.</p>	<p>Welding of power switch contacts, fuse melting, circuit breaker tripping, adverse effects on rectifier circuit, or fluctuations in power supply voltage may occur.</p>
<p>Unbalance rate</p>		<p>Heavy loading on specific phase occurs due to fluctuations in the power line load or unbalanced extension of installations. This causes distortions in voltage and current waveforms, dips, and negative sequence voltages.</p>	<p>Unbalanced voltage and current, motor instability, negative sequence voltages, and harmonics will occur.</p>
<p>Flicker</p>		<p>The load on a particular phase increases due to changes in the load connected to each of the phases of the power line or use of unbalanced installation equipment. This causes voltage dips.</p>	<p>Unbalanced voltage, negative sequence voltage, harmonics, and the like occur causing motor instability, circuit breaker tripping, and heating due to transformer overload.</p>



## Displaying Recorded Events

Press F1 to display the event screen.

Measured value

Event symbol

All events		Occurrence	
[Symbol]	102.0 V	2013/12/23	13:55:41.217
[Symbol]	-257 V	2013/12/23	13:55:38.647
[Symbol]	119.3 V	2013/12/23	13:55:25.727
[Symbol]	119.3 V	2013/12/23	13:55:25.727
[Symbol]	-285 V	2013/12/23	13:55:25.647
[Symbol]	75.0 V	2013/12/23	13:55:12.105
[Symbol]	451.7 A	2013/12/23	13:54:55.597
[Symbol]	501.9 A	2013/12/23	13:54:49.097

Flicker Detection

Display Symbol	
Event symbol	Start → End Swell [Symbol] → [Symbol] Dip [Symbol] → [Symbol] Interruption [Symbol] → [Symbol] Transient [Symbol] → [Symbol] Inrush current [Symbol] → [Symbol]
Measured value	Instantaneous values recorded when the start and end of an event were detected. If the interval between the start and end of an event is short, the measured value at the end of the event may not be displayed. To check the rms values before and after the detection, check rms variation data. For the measured values of a long-lasting event, check the interval measurement data. For power quality analysis, short interval recording is effective.
Time of occurrence	The times recorded when the start and end of an event were detected.

### Event Detection on Poly-Phase Systems

#### Interruption

The start of an event is detected when the voltages of all the relevant channels for the wiring system are interrupted. The end of the event is detected when the interruption on any of the channels is restored.

#### Swell, Dip, Inrush Current, and Transient

The start of an event is detected when any of the voltages of the relevant channels for the wiring system meets the event condition. The end of the event is detected when the condition is no longer met by any of the channels.

### How Swell, Dip, Inrush Current, and Transient Are Measured

Events are detected from the rms values of single waveforms that overlap each other at every half period. If an event is first detected in the rms value of a single waveform, the beginning of that waveform is considered the start of the event. If the event is no longer detected in the rms value of a later waveform, the beginning of that waveform is considered the end of the event. The detected event is assumed to continue from the start to the end.

#### Example of dip detection

\* Interruption is detected with the same method.

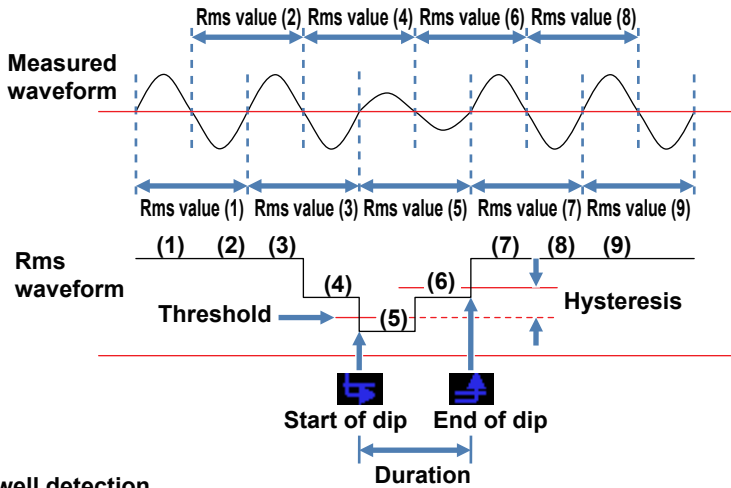

#### Example of swell detection

\* Inrush current is detected with the same method.

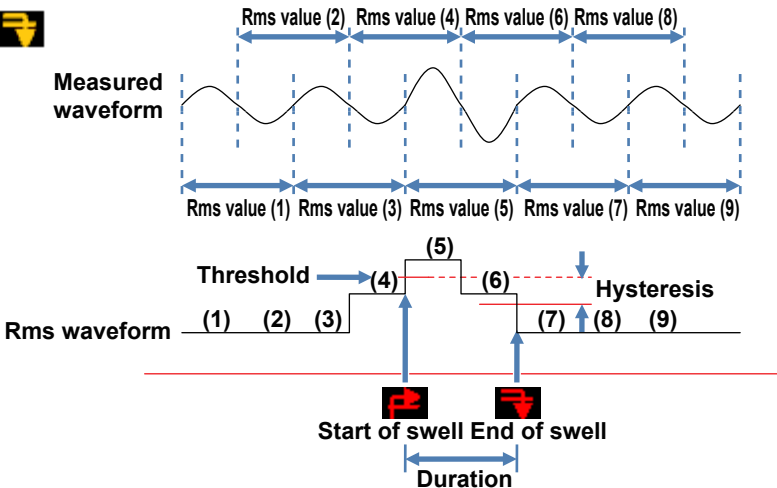

## Transient Detection

Voltage waveforms are monitored at approximately 40 kps without gaps to detect transients every approximately 200 ms. The beginning of a 200 ms period where the first transient is detected is regarded as the start of the event. The beginning of a later 200 ms period where a transient is no longer detected is regarded as the end of the event. The detected event is assumed to continue from the start to the end.

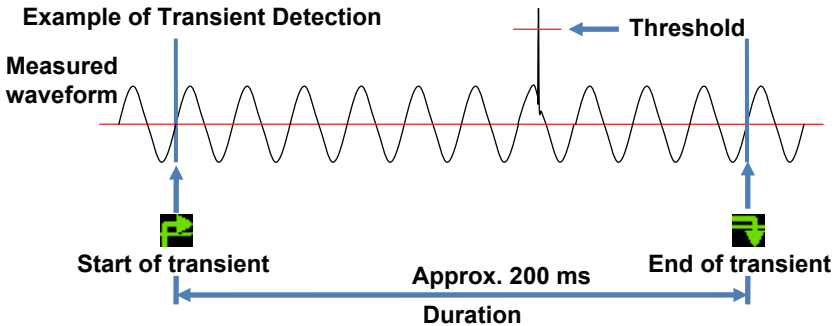

## Saved Data

When an event occurs, the event type, the start and end times, and the measured values are recorded together with the event waveform and rms variation data. Note that for the event waveform, only the 200 ms period within the 1-second data update interval is recorded.

## Event Waveform

The voltage and current waveform data of all channels in the 200 ms period (10 cycles for 50 Hz, 12 cycles for 60 Hz) that includes the event data is recorded (8192 points). If different events occur within the 1-second data update interval, only the waveform data of the 200 ms period containing the highest priority event is recorded. If several events of the same time occur within the same period, the one with the highest (deepest) value is recorded. If the values are also the same, the one lasting the longest is recorded. There are no priority levels between connected channels.

[Highest priority] → Voltage

transient → Interruption → Dip → Swell → Inrush current

### Rms Variation

The rms voltage and current (resolution: half-cycle) variation data of all channels is recorded in the 1-second data update interval that includes the event data.

### Example of a 800 ms dip detection (saved data)

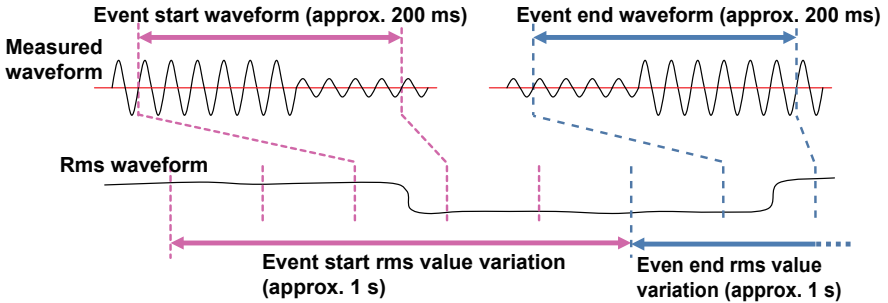

QUALITY		06/01/2014 17:04:02	
All events	Occurrence		
102.0 V	2013/12/23	13:55:41.217	
-257 V	2013/12/23	13:55:38.647	
119.3 V	2013/12/23	13:55:25.727	
119.3 V	2013/12/23	13:55:25.727	
-285 V	2013/12/23	13:55:25.647	
75.0 V	2013/12/23	13:55:12.105	
451.7 A	2013/12/23	13:54:55.597	
501.9 A	2013/12/23	13:54:49.097	

Flicker F1 Detector F2

### Changing the Displayed Area

Use the up and down arrow keys to vertically scroll the screen thereby changing the displayed area.

### Flicker

Press F1 (flicker) to switch to a screen that shows flicker values. For details, see “Displaying a List of Flicker Measurements” on the next page.

## Event Detection

Press F2 (detection) to toggle the type of displayed events.



## Displaying a List of Flicker Measurements

### <Procedure>

Press F1 to display the flicker screen. → Use the up and down arrow keys to display a screen showing V: List display/Pst(1min): Trend graph/Plt: Transitional change.

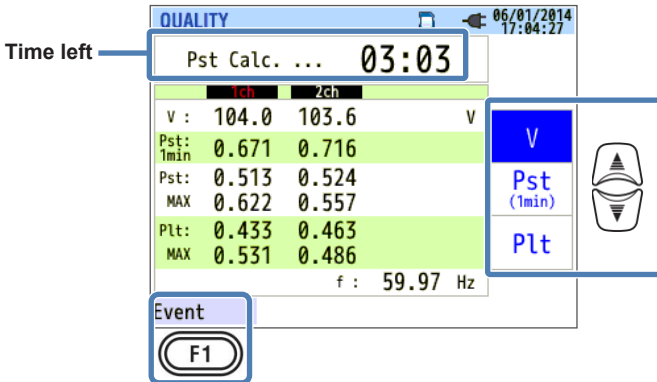

If variable loads, such as an arc furnace, are connected, voltages may vary and cause lights to flicker. This phenomenon is called voltage flicker, and its severity level is expressed by Pst and Plt.

Display Symbol	
Remaining time (time left)	The countdown time until a Pst calculation completes. This usually takes about 10 minutes.
V	Phase voltage.* For 3P3W and 3P3W3A, rms line voltages are displayed.
f	Frequency
Pst,1min	Severity of short-term flicker measured over 1 minute. This is useful for power quality survey or study.
Pst	Severity of short-term flicker measured over 10 minutes.
Pst,MAX	The maximum Pst value measured since the start of measurement. The display is updated every time the measured value exceeds the previous maximum value.

## 6.7 Power Quality

Display Symbol	
Plt	Severity of long-term flicker measured over 2 hours.
Plt,MAX	The maximum Plt value measured since the start of measurement. The display is updated every time the measured value exceeds the previous maximum value.

### Event

Press F1 (event) to switch to a screen that shows recorded events. For details, see “Displaying Recorded Events” on page 6-26.

## Displaying the Trend Graph of “Pst, 1 min”

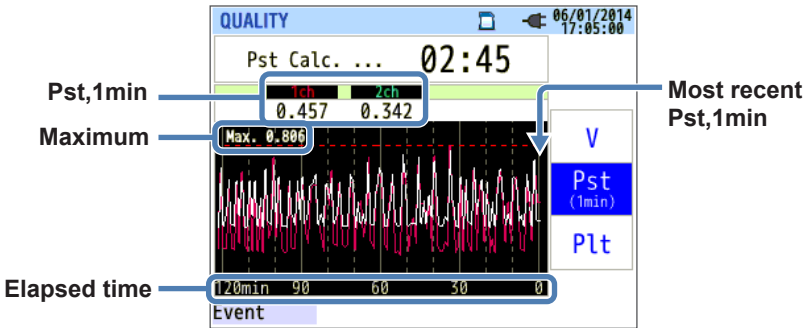

The “Pst, 1min” measured in the recent 120 minutes is displayed on the trend graph.

Display Symbol	
Pst,1min	Severity of most recent short-term flicker measured over 1 minutes.
Maximum	The maximum “Pst, 1min” value measured since the start of measurement. The display is updated every time the measured value exceeds the previous maximum value.
Elapsed time	The most recent measured value is displayed at the right end (0 minutes) and shifts to left as time passes. Measured values in the recent 120 minutes can be displayed.

## Displaying the Plt Trend Graph

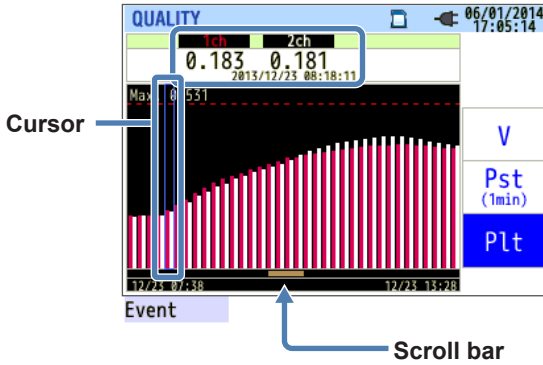

Use the left and right arrow keys to move the cursor and scroll the Plt trend graph horizontally. The dark orange area of the scroll bar shows the present display range.

Display Items	
Measured Plt/Recorded date	The Plt of each channel at the cursor is displayed with the recorded date and time.

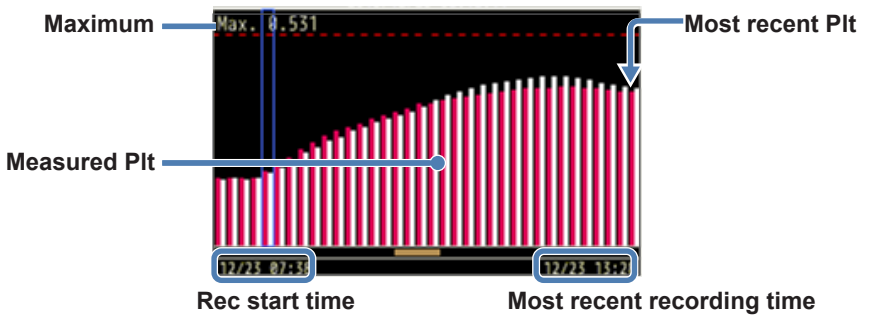



The recording start date and time are displayed when the Plt trend graph does not fit on one screen.



Display Symbol	
Maximum	The maximum Plt value measured since the start of measurement. The display is updated every time the measured value exceeds the previous maximum value.

## 7.1 Other Features

### Data Hold

Pressing DATA HOLD stops display updating regardless of the measurement condition. An  icon appears at the top of the screen. Pressing DATA HOLD again causes the  icon to disappear and resumes display updating. Even when data is being held, you can switch the display to view the measured values of other screens. Even when display updating is stopped during recording, the CW500 continues to record measurement values and events.

### Key Lock

Holding down DATA HOLD for 2 seconds causes an  icon to appear on the screen and disables all keys except the LCD key. Holding down the key again for 2 seconds causes the  icon to disappear and clears key lock.

### Turning Off the Backlight

Press LCD to turn off the backlight. Pressing a key other than the power key turns on the backlight.

### Backlight Auto-Off

#### When Connected to an AC Power Supply

If you do not perform any operations for 5 minutes, the backlight automatically turns off. To turn it back on, press any key other than the power key. You can also disable the backlight auto-off function by selecting Disable auto-off from the SETUP menu.

#### During Battery Operation

To reduce power consumption, the brightness of the backlight while operating on batteries is about half that while operating on AC power. In addition, during battery operation, if you do not perform any operations for 2 minutes, the backlight automatically turns off. To turn it back on, press any key other than the power key. Auto-off cannot be disabled during battery operation.



### **Auto Power OFF**

#### **When Connected to an AC Power Supply**

The CW500 automatically turns off if you do not perform any operations for about 5 minutes. It does not turn off while the CW500 is recording. To turn the power on again, press the power key. You can also disable this function by selecting Disable auto-off from the SETUP menu.

#### **During Battery Operation**

The CW500 automatically turns off if you do not perform any operations for about 5 minutes. It does not turn off while the CW500 is recording. To turn the power on again, press the power key. Auto power off cannot be disabled during battery operation.

### **Auto Current Range**

The current ranges of clamp-on probes are automatically switched according to the measured rms values. This function cannot be enabled while recording power quality events. The range shifts to the next higher range when the input exceeds 300% peak of the next lower range and shifts to the next lower range if the input falls below 100% peak of the next lower range. However, the display is fixed to the next higher range.

### **Sensor Detection**

If sensor detection is enabled from the SETUP menu, current clamp-on probes connected to the CW500 are automatically detected.

When the CW500 starts, it automatically checks the connected current clamp-on probes to the current clamp-on probe settings of the previous measurement.

### **Power Failure Recovery**

If the CW500 shuts down while it is recording due to a power failure, when the power supply recovers, the CW500 automatically resumes recording.

### **Print Screen**

Pressing PRINT SCREEN captures the current screen to a BMP file. The file size is about 77 KB.

**Setup Memory**

The CW500 retains all the settings used in the previous measurement and starts in the same condition when the power is turned on.

The default settings are used when the CW500 is turned on the first time after purchase.

**Quick start guide**

Press START/STOP to run the Quick start guide. You can easily start recording by setting the items by following the instructions displayed on the screen.

**Status LED**

The LED blinks red when the backlight is off and lights green when recording is in progress regardless of the backlight state. The LED blinks green when the CW500 is standing by.

## 8.1 Transferring Data to a PC

Data saved in an SD memory card or internal memory can be transferred to a PC through a USB connection or an SD memory card reader.

	Transfer Method	
	USB	Card reader
<b>SD memory card data (file)</b>	Yes but not recommended	Yes
<b>Internal memory data (file)</b>	Yes	-----

The USB data transfer rate on the CW500 is about 320 MB/hour. Transferring large data files over a USB connection may take a long time. We recommend that you use an SD memory card to transfer large data files to a PC.

For information on how to handle SD memory cards, refer to the user's manual provided with the card. To prevent problems, only save data files of the CW500 to the SD memory card. Delete unnecessary files in advance.

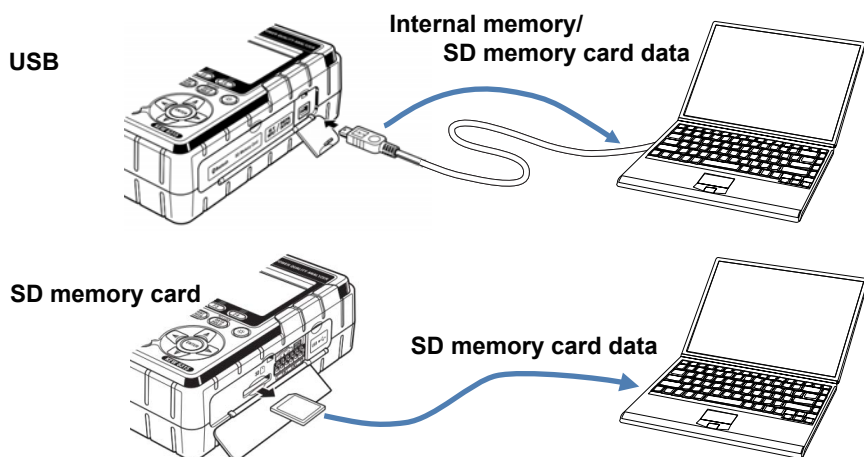

## 8.2 Signal Control with External Devices

### Connecting I/O Terminals

#### CAUTION

- Apply voltage in the range of  $\pm 11\text{ V}$  to the input terminals and in the range of 0 to 30 V (50 mA, 200 mW) to the output terminals. Exceeding these ranges can damage the CW500.
- The L terminals of each channel are connected internally. Do not simultaneously connect different ground levels to the L terminals.

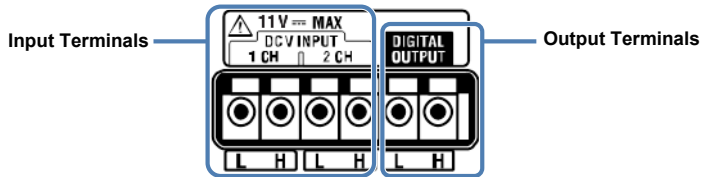

Do not mistake input terminals for output terminals or vice versa.

Connectable signal wire sizes are as follows.

Suitable wire: Single wire  $\phi 1.2\text{ mm}$  (AWG16)

Stranded wire 1.25 mm<sup>2</sup> (AWG16) strand diameter 0.18 mm or more

Usable wire: Single wire  $\phi 0.4$  to 1.2 (AWG26 to 16)

Stranded wire 0.2 to 1.25 mm<sup>2</sup> (AWG24 to 16) strand diameter 0.18 mm or more

Standard length of stripped wire: 11 mm

**<Procedure>**

- 1 Open the connector cover.
- 2 While pressing the rectangular area above the appropriate terminal with a flat-bladed screwdriver or the like, insert a signal wire.
- 3 Remove the screwdriver to fix the wire in place.

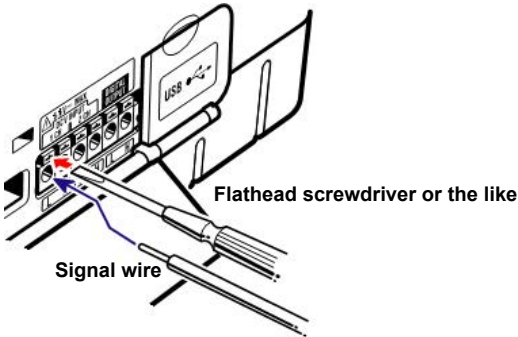
**Input Terminals**

Input terminals are used to monitor voltage output signals from temperature sensors or the like. They are useful when you need to simultaneously measure a signal output from another device and the anomalies that occur on that power supply.

Number of channels: 2

Input resistance: Approx. 225.6 k $\Omega$

### Output Terminals

Output terminals transmit low level signals while a power quality event is occurring. The terminals are normally at high level. If the event lasts less than 1 second, the output signal is set to low level for 1 second.

The output target event is the event with the highest priority among the specified events. If you want the output to synchronize with a lower priority event, turn off events that are higher priority than that event. For details, see “Power Quality (Event) Threshold Settings” in page 5-18. The events are arranged in order by priority below.

[Highest priority] → Transient → Interruption → Dip → Swell → Inrush current

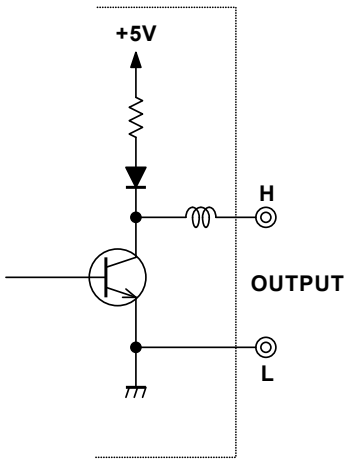

**Output format:** Open collector output  
**Maximum input:** 30 V, 50 mA, 200 mW  
**Output voltage:** Hi 4 to 5 V  
Lo 0 to 1 V

---

## 8.3 Supplying Power through Measurement Lines

If AC power cannot be supplied from an outlet, you can use a power supply adapter (98031) to supply power through voltage probes.

---



### WARNING

- If the probe and the measurement category of the main unit are mismatched, the lower measurement category takes precedence. Be sure to check that the measurement voltage and rating are matched.
  - Never connect voltage probes that are not necessary for the measurement that you are taking.
  - Do not connect to the measurement line when the probe is not connected to the main unit.
  - Never remove the probe from the main unit connector while measuring (power running from the measurement line).
  - Be sure to connect to the secondary side of the circuit breaker. The current capacity is large on the primary side and is dangerous.
  - Connect the probe after checking that the instrument is turned off.
  - Connect the main unit end of the cord first. Firmly insert the probe up to the base.
  - If the probe cracks or the metal parts become exposed, stop using it immediately.
-

### 8.3 Supplying Power through Measurement Lines

To connect the power supply adapter to the instrument, follow the procedure below.

- 1 Check that the power supply adapter's power switch is off.
- 2 Connect the power supply adapter plug to the VN and V1 terminals of the CW500.
- 3 Connect the power supply adapter power plug to the power inlet of the CW500.
- 4 Connect voltage probes to the VN and V1 terminals of the power supply adapter.
- 5 Connect the voltage probe's alligator clip to the circuit under measurement.
- 6 Turn on the power supply adapter's power switch.
- 7 Turn on the CW500 power switch.

To remove the power supply adapter from the CW500, reverse the steps 1 to 7 above.

For details on how to operate the power supply adapter, see the user's manual for the adapter.

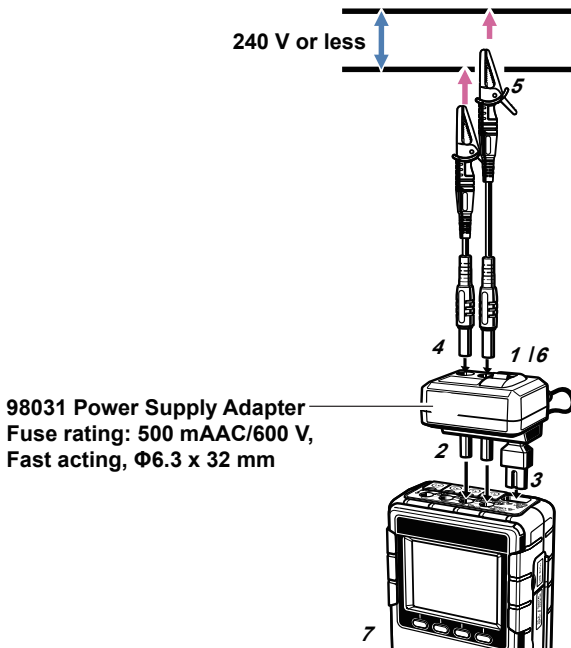



## 9.1 PC Software for Configuration and Analysis

The software “CW500Viewer” can be used to analyze the data recorded on the CW500 and also configure the CW500. You can automatically create graphs and lists from recorded data with a single click, convert recorded data to CSV format, centrally manage setup data and recorded data of several CW500s, and output data expressed in crude oil and CO2 equivalent values in reports.

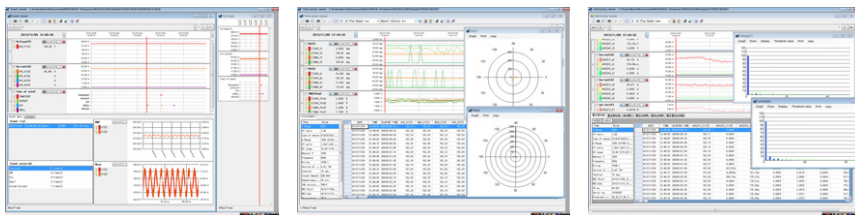

To use CW500Viewer, install the application and USB driver in your PC according to the installation manual provided as a PDF file.

### • Interface

The CW500 is equipped with a USB interface.

Transmission mode: USB Ver 2.0

USB communication can be used to perform the following operations.

- Download files in the CW500 internal memory to a PC
- Configure the CW500 from a PC
- Retrieve measured values in real time from the CW500 and display them and a graph on the PC

### • System Requirements

- Operating System  
Windows 7, Windows 8, Windows Vista
- Display Screen  
1024×768 dots, 65536 colors or more
- Hard disk space  
1 GB or more (including Framework)
- .NET Framework (3.5 or higher)

- **Trademarks**

- Windows is a registered trademarks or trademark of Microsoft Corporation in the United States and/or other countries.

The latest software is available for download from the following webpage.  
<http://www.yokogawa.com/yimi/>

## 10.1 Troubleshooting

If you suspect that the CW500 is malfunctioning, check the following items. If your problems is not listed, contact your nearest YOKOGAWA dealer.

<b>Symptom</b>	<b>Check</b>
The power does not turn on even when the power key is pressed. (Nothing is displayed on the LCD.)	<p>When operating on AC power</p> <ul style="list-style-type: none"> <li>• Check that the power cord is connected properly to an outlet.</li> <li>• Check that the power cord is not broken.</li> <li>• Check that the supply voltage is within the allowable range.</li> </ul> <p>When operating on battery power</p> <ul style="list-style-type: none"> <li>• Check that the batteries are set with proper polarity.</li> <li>• If you are using AA nickel-metal hydride (Ni-MH) batteries, check that they are charged sufficiently.</li> <li>• If you are using AA alkaline batteries, check that the batteries are not flat.</li> </ul> <p>If you problem is still not solved</p> <ul style="list-style-type: none"> <li>• Disconnect the AC power cord, and remove all the batteries. Load the batteries again, connect the AC power, and turn on the power. If the CW500 still fails to turn on, it may be malfunctioning.</li> </ul>
Keys do not work.	<ul style="list-style-type: none"> <li>• Check that key lock is not activated.</li> <li>• Check the valid keys of each measurement range in this manual.</li> </ul>
Measured values are not displayed. Measured values are unstable or inaccurate.	<ul style="list-style-type: none"> <li>• Check that the frequency applied to voltage channel 1 is within the guaranteed accuracy range. It should be between 40 to 70 Hz.</li> <li>• Check that the voltage probes and current clamp-on probes are connected properly.</li> <li>• Check that the CW500 settings and wiring are appropriate for the measurement line.</li> <li>• Check that the current clamp-on probe and clamp settings are correct.</li> <li>• Check that the voltage probes are not broken.</li> <li>• Check whether noise is introduced in the input signal.</li> <li>• Check that there are no strong electromagnetic fields nearby.</li> <li>• Check that the measurement environment meets the specifications of the CW500.</li> </ul>

<b>Symptom</b>	<b>Check</b>
Data cannot be saved to internal memory.	<ul style="list-style-type: none"> <li>• Check the number of files that have been saved.</li> <li>• Check whether an SD memory card is inserted. If an SD memory card is inserted, data cannot be saved to internal memory.</li> </ul>
Data cannot be saved to SD memory cards.	<ul style="list-style-type: none"> <li>• Check that an SD memory card is inserted properly.</li> <li>• Check that the SD memory card is formatted.</li> <li>• Check that there is free space on the SD memory card.</li> <li>• Check the number of files that have been saved to the SD memory card and the capacity.</li> <li>• Check that the SD memory card is compatible with the CW500.</li> <li>• Check that the SD memory card operates on known hardware.</li> </ul>
Downloading and configuration are not possible through USB communication.	<ul style="list-style-type: none"> <li>• Check that the CW500 is connected properly to the PC with a USB cord.</li> <li>• Use the communication application software (CW500 Viewer) to check that the connected device is displayed. If it is not, the USB driver may not be installed properly. See the separate installation manual, and reinstall the USB driver in the PC.</li> </ul>
Self-diagnosis frequently displays “NG.”	<ul style="list-style-type: none"> <li>• If it is an SD memory card failure, check “Data cannot be saved to SD memory cards.” For other failures, disconnect the AC power cord, and remove all the batteries. Load the batteries again, connect the AC power, and turn on the power. Then, perform the self-diagnosis again. If “NG” still appears, the CW500 may be malfunctioning.</li> </ul>

## 10.2 Error Messages and Corrective Actions

Messages may appear on the screen during operation.

This section describes the error messages and how to respond to them.

Message	Description and Corrective Action
No SD card. Check the amount of free space in the SD card.	<ul style="list-style-type: none"> <li>• Check that an SD memory card is inserted properly. For details, see “Inserting and Removing the SD Memory Card” in the Getting Started Guide.</li> </ul>
Check the amount of free space in the SD card.	<ul style="list-style-type: none"> <li>• Check the free space on the SD memory card. If there is not enough free space, delete files or format the SD memory card, or use another SD memory card that has been formatted on the CW500. For details, see “Recorded Data Operation” in section 5.6.</li> </ul>
Failed to detect sensors. Check the connection of the sensor(s).	<ul style="list-style-type: none"> <li>• Check that current probes are securely connected to the CW500.</li> <li>• If you suspect a malfunction, check with the following procedure. Connect the current clamp-on probe that failed to a channel that detection was successful, and test again. If the same channel fails again, the instrument may be malfunctioning. If detection fails on the channel connected to the current clamp-on probe that failed to be detected the last time, the current clamp-on probe may be malfunctioning. If a malfunction is found, stop using the CW500 or probe immediately.</li> </ul>
Battery level is low. Powering off...	<ul style="list-style-type: none"> <li>• Use AC power, or replace the AA alkaline batteries (LR6) with new ones or the AA nickel-metal hydride (Ni-MH) batteries with recharged ones. For details, see “Installing Batteries” in the Getting Started Guide.</li> </ul>
Not having free space on the internal memory. Format the memory or delete unnecessary files.	<ul style="list-style-type: none"> <li>• Check the free space in the internal memory and the number of saved files. Up to three measured data files and eight other files can be saved to the internal memory. If there is not enough free space, delete files or format the memory. For details, see “Recorded Data Operation” in section 5.6.</li> </ul>

## 10.2 Error Messages and Corrective Actions

Message	Description and Corrective Action
Cannot read the setting file. The file may be damaged.	<ul style="list-style-type: none"> <li>Try loading the setup file again. If it still fails, the SD memory card may be damaged if the setup file is on the card or the CW500 may be malfunctioning if the setup file is in the internal memory. If the CW500 is malfunctioning, stop using it immediately.</li> </ul>
Available memory is low. Check the amount of free space in the SD card and internal memory.	<ul style="list-style-type: none"> <li>Check the free space on the SD memory card and in the internal memory and the number of saved files. Up to three measured data files and eight other files can be saved to the internal memory. If there is not enough free space, delete files or format the SD memory card, or use another SD memory card that has been formatted on the CW500. For details, see “Recorded Data Operation” in section 5.6.</li> </ul>
There is no available space in the storage area.	
Start time is set in the past. Check the recording start method.	<ul style="list-style-type: none"> <li>This appears when “Start” for recording is set to Constant rec. or Time period rec., and the stop time of recording is set to a time in the past. Check the time settings. For details see “Reserving by Specifying the Date and Time” or “Reserving a Repetitive Recording” (section 4.2).</li> </ul>
Failed to start recording.	<ul style="list-style-type: none"> <li>Check the settings on the Recording tab of SET UP. For details, see section 5.4, “Recording Setup.”</li> <li>Start recording again. If it still fails, the SD memory card may be damaged if the recording destination is the card or the CW500 may be malfunctioning if the recording destination is the internal memory. If the CW500 is malfunctioning, stop using it immediately.</li> </ul>
Cannot change the instrument settings during recording or in stand-by mode.	<p>You can only view the settings while recording is in progress. To change the settings, be sure to stop recording, and wait for the message “Recording stopped” to disappear.</p>
New sensor is detected. Recheck the basic setting for SET UP before measurements.	<ul style="list-style-type: none"> <li>This appears when a current clamp-on probe different from the previous measurement is connected. On the Basic tab of SET UP, specify the currently connected clamp-on probe, or use sensor detection to automatically detect the current clamp-on probe.</li> </ul>
Sensor connection is not correct. Check the connected sensor(s).	<ul style="list-style-type: none"> <li>An appropriate current probe may not be connected to a channel for the wiring system to be measured. Only the same type of current probes may be used in a measurement.</li> </ul>

<b>Message</b>	<b>Description and Corrective Action</b>
Out of SD card space. Recording will be stopped.	<ul style="list-style-type: none"><li>• Be sure to wait for the message “Recording stopped” to disappear, and back up the saved files to a PC or the like. Delete the files or format the SD memory card, or use another SD memory card that has been formatted on the CW500. Then, resume recording. For details, see “Recorded Data Operation” in section 5.6.</li></ul>
Out of internal memory space. Recording will be stopped.	<ul style="list-style-type: none"><li>• Be sure to wait for the message “Recording stopped” to disappear, and back up the saved files to a PC or SD memory card. Delete the files or format the internal memory. Then, resume recording. For details, see “Recorded Data Operation” in section 5.6.</li></ul>

## When Using 96030, 96033, or 96036

To use a YOKOGAWA's 96030, 96033, or 96036 current clamp-on probe with the CW500, you need a 99073 banana-DIN adapter.

The sensor identification function cannot be used.

Configure the clamp-on probe settings manually.

The clamp-on probe settings and specifications are as follows.

Probe		96030	96033	96036
Current-Clamp setting of CW500		96063	96061	96060
Accuracy	Band width	±0.5%rdg±0.1mV (45Hz to 66Hz) ±0.8%rdg±0.2mV (66Hz to 1kHz) ±2.0%rdg±0.4mV (1kHz to 3.5kHz)	±0.5%rdg±0.1mV (45Hz to 66Hz) ±0.8%rdg±0.2mV (66Hz to 1kHz) ±1.0%rdg±0.3mV (1kHz to 3.5kHz)	±0.5%rdg±0.01mV (45Hz to 66Hz) ±0.8%rdg±0.02mV (66Hz to 1kHz) ±2.0%rdg±0.04mV (1kHz to 3.5kHz)
	Phase	±0.5° or less (45Hz to 3.5kHz)	±1.0° or less (45Hz to 3.5kHz)	-
Maximum allowable input		5% to 110% of each measuring range		
Safety standard		Do not comply with safety standard.		



# Index

## **Symbol** **Page**

Σ/CH ..... 6-7

## **Numeric** **Page**

4-split/8-split ..... 6-6

## **A** **Page**

A × Magnification ..... 6-16,6-18

Auto power OFF ..... 7-2

AVG ..... 6-6

## **B** **Page**

Backlight ..... 3-5,5-35,7-1

Barrier ..... 2-4

Basic ..... 5-1

Basic Setup ..... 5-2

Bluetooth ..... 5-34

Buzzer ..... 5-34

## **C** **Page**

Changing the displayed channels..... 6-10

CH color..... 5-32

Clamp ..... 5-8

Constant rec. .... 5-29

Contrast ..... 3-5

CT Ratio ..... 5-9

Current measurement..... 5-8

Current Range ..... 5-9

Customize..... 6-4

## **D** **Page**

Data folder ..... 5-43

DATA HOLD ..... 7-1

DATA HOLD key ..... 3-1

Data transfer ..... 8-1

Date format ..... 5-32

DC Range ..... 5-11

Delete data ..... 5-37

Demand ..... 3-6,6-10

DEM G ..... 6-12

DEM Guess ..... 6-11

DEM Max ..... 6-11

DEM P ..... 6-12

DEM Present ..... 6-11

DEM Target..... 6-11

Detection failure cause ..... 4-8

DIP ..... 5-21

## **E** **Page**

Edit allowable range ..... 5-17

ENTER key ..... 3-1

ESC key ..... 3-1

Event ..... 5-26

Event data ..... 6-29

## **F** **Page**

File name ..... 5-42

Filter ..... 5-23

Format ..... 5-40

Frequency..... 5-11

full scale..... 6-18

Full/zoom ..... 6-22

Function key ..... 3-1

## **G** **Page**

Graph/List..... 6-24

## **H** **Page**

Harmonic analysis ..... 6-19

Harmonic analysis key..... 3-2

Harmonic orders ..... 6-24

Harmonics ..... 3-8,5-26

Hysteresis..... 5-19

## Index

<b>I</b>	<b>Page</b>
ID Number .....	5-33
InrushCurrent .....	5-20
Inspection cycle .....	5-14
INST .....	6-6
Instantaneous .....	3-6
Instantaneous value .....	6-1
INT .....	5-22
Integrated .....	3-6
Integrated value .....	6-9
Interruption .....	5-22
Interval .....	5-28
I/O terminal .....	8-2

<b>K</b>	<b>Page</b>
Key Lock .....	7-1
KEY LOCK key .....	3-1

<b>L</b>	<b>Page</b>
Language .....	5-31
LCD key .....	3-1
LED .....	3-1
List/Graph .....	6-22
List of flicker measurements .....	6-31
Log/Linear .....	6-22

<b>M</b>	<b>Page</b>
Manual .....	5-29
MAX .....	6-6
MAX hold .....	5-16
Measurement .....	5-1,5-13
Measurement setup .....	5-12
MIN .....	6-6

<b>N</b>	<b>Page</b>
NG judgment .....	4-7
Nominal V .....	5-7

<b>O</b>	<b>Page</b>
Others .....	5-1
Output terminal .....	8-4

<b>P</b>	<b>Page</b>
Plt trend graph .....	6-33
Power .....	5-25,5-35
Power key .....	3-1
Power quality .....	3-9,5-18
Power Quality .....	6-25
Power supply adapter .....	8-5
Print screen .....	7-2
PRINT SCREEN .....	5-42
PRINT SCREEN key .....	3-1

<b>Q</b>	<b>Page</b>
QUALITY key .....	3-2,6-25

<b>R</b>	<b>Page</b>
Read settings .....	5-46
REC End .....	5-29
Recording .....	5-1,5-25
Record items .....	5-27
REC Period .....	5-30
REC Start .....	5-29
RESET key .....	3-1

<b>S</b>	<b>Page</b>
Saved data .....	5-36
Saved Data .....	5-1
Save settings .....	5-44
SD card .....	5-39
Self-Diagnosis .....	4-8
Sensor detection .....	4-8,7-2
Sensor Detection .....	5-10
SETUP key .....	3-1
Starting recording .....	4-1
Start now .....	4-1
START/STOP key .....	3-1
Stopping recording .....	4-2
SWELL .....	5-20
System reset .....	5-35

---

<b>T</b>	<b>Page</b>
Target.....	5-13
Target PF.....	5-24
Test environment check.....	4-6
THD calc.....	5-16
Threshold current.....	5-18
Time.....	5-33
Time period recording.....	5-30
t × Magnification.....	6-18
Transfer data.....	5-39
Transient.....	5-19
Trend graph.....	6-4

<b>V</b>	<b>Page</b>
V/A/P/ΣP.....	6-23,6-24
Vector.....	3-7,6-14
Vector key.....	3-2
V × Magnification.....	6-16,6-18
Voltage measurement.....	5-5
V Range.....	5-5
VT/CT.....	5-6
VT Ratio.....	5-5

<b>W</b>	<b>Page</b>
Waveform.....	3-7,6-17
Waveform key.....	3-2
Wh.....	6-4,6-9
Wiring check.....	4-7
Wiring system.....	4-5,5-3
W/Wh.....	6-1
W/Wh key.....	3-2

<b>Z</b>	<b>Page</b>
Zoom.....	6-4