

### External Dimensions

Unit: mm  
(approx. inch)

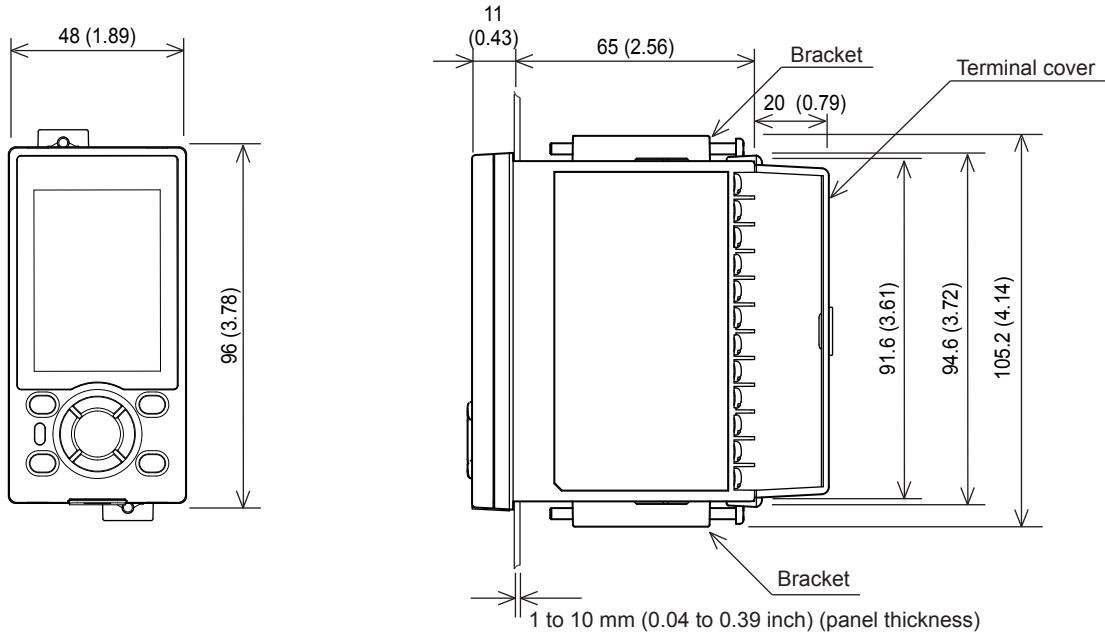

### Panel Cutout Dimensions

#### General mounting

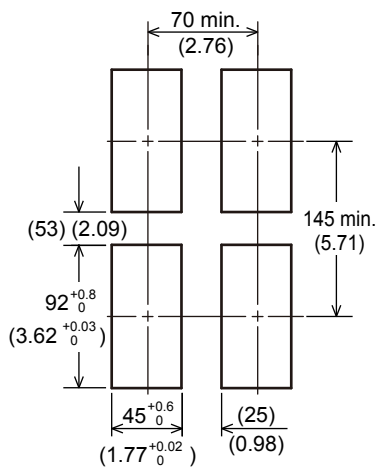

#### Side-by-side close mounting

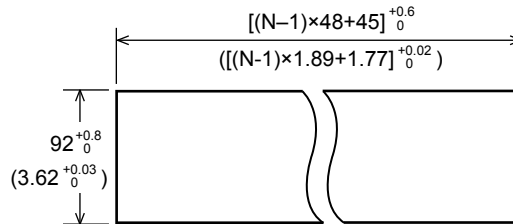

"N" stands for the number of controllers to be installed.  
However, the measured value applies if N ≥ 5.

Normal tolerance: ±(value of JIS B 0401-1998 tolerance grade IT18) / 2

# Terminal Wiring Diagrams

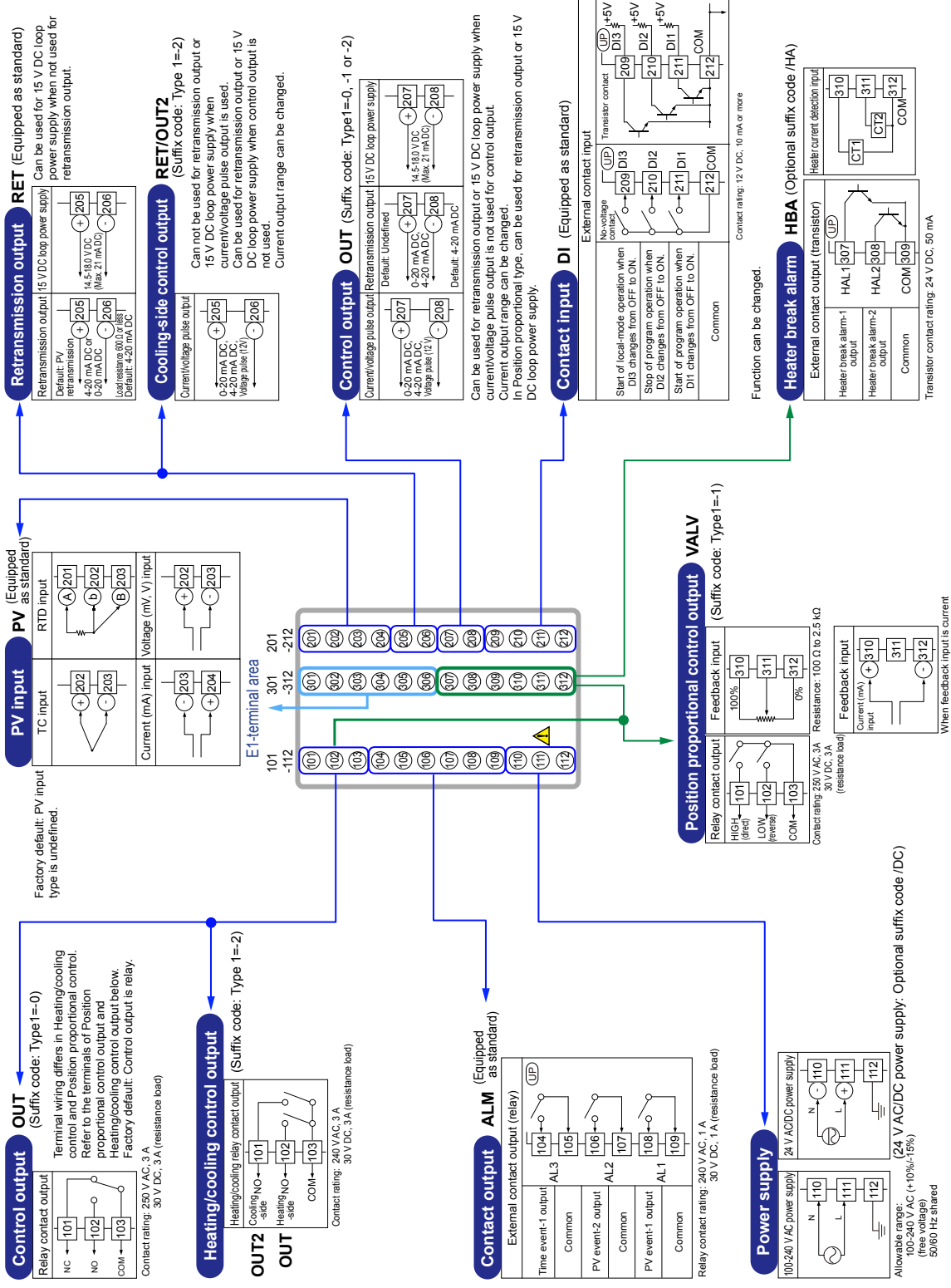

# Terminal Wiring Diagrams (E1-Terminal Area)

## 301-312 E1端子エリア

301-312

### RS-485 communication RS485

(Suffix code: Type 2=1)

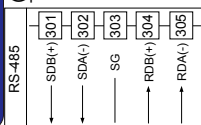

### Contact input / Contact output D/I/O (Suffix code: Type 2=2)

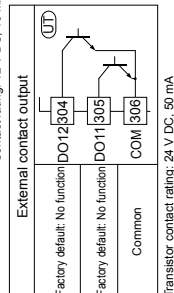
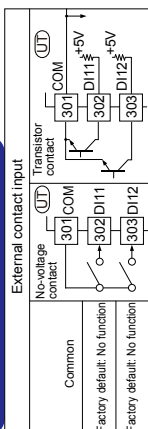

### CC-Link communication (with Modbus master)

(Suffix code: Type 3=3)

