

R&S® Cable Rider ZPH Handheld Cable and Antenna Analyzer Getting Started



1321094402
Version 10

ROHDE & SCHWARZ
Make ideas real



This document describes the following R&S®Cable Rider ZPH models with firmware version 1.70 and higher:

- R&S®ZPH (1321.1211.02)
- R&S®ZPH (1321.1211.12)
- R&S®ZPH (1321.1211.52, equivalent to 1321.1211.02)

© 2020 Rohde & Schwarz GmbH & Co. KG

Mühlhofstr. 15, 81671 München, Germany

Phone: +49 89 41 29 - 0

Email: info@rohde-schwarz.com

Internet: www.rohde-schwarz.com

Subject to change – data without tolerance limits is not binding.

R&S® is a registered trademark of Rohde & Schwarz GmbH & Co. KG.

Trade names are trademarks of the owners.

1321.0944.02 | Version 10 | R&S®Cable Rider ZPH

Throughout this manual, products from Rohde & Schwarz are indicated without the ® symbol , e.g. R&S®Cable Rider ZPH is indicated as R&S Cable Rider ZPH.

Safety Instructions

Instrucciones de seguridad

Sicherheitshinweise

Consignes de sécurité

WARNING

Risk of injury and instrument damage

The instrument must be used in an appropriate manner to prevent electric shock, fire, personal injury or instrument damage.

- Do not open the instrument casing.
 - Read and observe the "Basic Safety Instructions" delivered as printed brochure with the instrument.
 - Read and observe the safety instructions in the following sections. Note that the data sheet may specify additional operating conditions.
 - Keep the "Basic Safety Instructions" and the product documentation in a safe place and pass them on to the subsequent users.
-

ADVERTENCIA

Riesgo de lesiones y daños en el instrumento

El instrumento se debe usar de manera adecuada para prevenir descargas eléctricas, incendios, lesiones o daños materiales.

- No abrir la carcasa del instrumento.
 - Lea y cumpla las "Instrucciones de seguridad elementales" suministradas con el instrumento como folleto impreso.
 - Lea y cumpla las instrucciones de seguridad incluidas en las siguientes secciones. Se debe tener en cuenta que las especificaciones técnicas pueden contener condiciones adicionales para su uso.
 - Guarde bien las instrucciones de seguridad elementales, así como la documentación del producto, y entréguelas a usuarios posteriores.
-



WARNUNG

Gefahr von Verletzungen und Schäden am Gerät

Betreiben Sie das Gerät immer ordnungsgemäß, um elektrischen Schlag, Brand, Verletzungen von Personen oder Geräteschäden zu verhindern.

- Öffnen Sie das Gerätegehäuse nicht.
 - Lesen und beachten Sie die "Grundlegenden Sicherheitshinweise", die als gedruckte Broschüre dem Gerät beiliegen.
 - Lesen und beachten Sie die Sicherheitshinweise in den folgenden Abschnitten; möglicherweise enthält das Datenblatt weitere Hinweise zu speziellen Betriebsbedingungen.
 - Bewahren Sie die "Grundlegenden Sicherheitshinweise" und die Produktdokumentation gut auf und geben Sie diese an weitere Benutzer des Produkts weiter.
-



AVERTISSEMENT

Risque de blessures et d'endommagement de l'appareil

L'appareil doit être utilisé conformément aux prescriptions afin d'éviter les électrocutions, incendies, dommages corporels et matériels.

- N'ouvrez pas le boîtier de l'appareil.
 - Lisez et respectez les "consignes de sécurité fondamentales" fournies avec l'appareil sous forme de brochure imprimée.
 - Lisez et respectez les instructions de sécurité dans les sections suivantes. Il ne faut pas oublier que la fiche technique peut indiquer des conditions d'exploitation supplémentaires.
 - Gardez les consignes de sécurité fondamentales et la documentation produit dans un lieu sûr et transmettez ces documents aux autres utilisateurs.
-

Safety instructions for rechargeable lithium ion batteries

WARNING

Risk of serious personal injury or even death.

You must fully observe the following instructions in order to avoid serious personal injury – or even death – due to an explosion and/or fire.

1. Do not dismantle, open or crush the batteries or drop them from a great height. If mechanical damage occurs, there is a risk that chemicals may be released. Gases that are released can cause breathing difficulties. Immediately ventilate the area and in serious cases consult a doctor.
Irritation can occur if the chemicals that are released come in contact with the skin or eyes. If this happens, immediately and thoroughly rinse the skin or eyes with water and consult a doctor.
2. Do not expose cells or batteries to heat or fire. Do not store them in direct sunlight. If overheating occurs, there is the risk of an explosion or a fire, which can lead to serious personal injuries.
3. Keep the batteries clean and dry. If the terminals become soiled, clean them with a dry, clean cloth.
4. Charge the batteries prior to using them.
Only use the appropriate Rohde & Schwarz charger to charge the batteries. See the device manual or data sheet for the exact designation of the charger.
If the batteries are improperly charged, there is a risk of explosion, which can cause serious personal injury.
5. The charging temperature must be between 0 °C and 45 °C (see manual for information on possible restrictions).
6. Discharging may take place only at temperatures between 0 °C and 50 °C (see manual for information on possible restrictions).
7. Only charge batteries until they are fully charged. Frequent overcharging can reduce the battery lifetime.
8. Remove the battery from the device when the battery is not being used. Following a longer period of storage, it may be necessary to charge and discharge the battery several times in order to obtain the full capacity.
9. Only use the battery with designated Rohde & Schwarz devices. See the device manual for details.
10. Do not dispose of the batteries with unsorted municipal waste. The batteries must be collected separately. After the end of their life, dispose of the batteries at a suitable collection point or via a Rohde & Schwarz customer service center.



EU labeling for batteries and secondary cells

11. Follow the transport stipulations of the carrier (IATA-DGR, IMDG-Code, ADR, RID) when returning lithium batteries to Rohde & Schwarz subsidiaries.
12. Keep this safety information for future reference.

Instrucciones de seguridad para baterías recargables de ión litio

ADVERTENCIA

Posibilidad de lesiones graves que en determinadas circunstancias puede causar la muerte.

Tenga en cuenta los siguientes avisos en caso de explosión y/o incendio para impedir lesiones graves en personas que, en determinadas circunstancias, podrían incluso causar la muerte.

1. No desarme las baterías, no las abra, no las triture ni las deje caer desde una gran altura.
En caso de daños mecánicos existe el riesgo de salida de sustancias químicas. En caso de salida de gases pueden producirse dificultades respiratorias. Ventile inmediatamente la habitación y acuda a un médico en casos graves.
Si sustancias químicas provenientes de la batería entran en contacto con la piel o los ojos pueden producirse irritaciones. Enjuague en estos casos la piel y los ojos inmediatamente con abundante agua y acuda a un médico.
2. No exponga las celdas o baterías al calor ni al fuego. No las almacene bajo la luz solar directa. En caso de sobrecalentamiento existe peligro de explosión o de incendio, lo que puede provocar lesiones graves en personas.
3. Mantenga las baterías limpias y secas. Si los conectores están sucios, límpielos con un paño seco y limpio.
4. Cargue las baterías antes de su uso.
Solamente está permitido cargar la batería con el correspondiente cargador de Rohde & Schwarz. Consulte en el manual o en las especificaciones técnicas del equipo la denominación exacta del cargador.
Si las baterías se cargan de forma incorrecta existe peligro de explosión, lo que podría causar lesiones graves en personas.
5. La temperatura de carga debe encontrarse entre 0 °C y 45 °C (consulte el manual para posibles restricciones).
6. La descarga solamente puede efectuarse entre 0 °C y 50°C (consulte el manual para posibles restricciones).
7. Cargue las baterías solamente el tiempo necesario hasta que se hayan cargado por completo. La sobrecarga frecuente reduce la vida útil de la batería.
8. Extraiga la batería del equipo si no se va a utilizar. Después de un periodo de almacenamiento prolongado puede ser necesario cargar y descargar varias veces la batería para recuperar su capacidad completa.
9. Utilice la batería exclusivamente con los equipos Rohde & Schwarz correspondientes. Consulte para ello el manual del equipo.
10. No elimine las baterías junto con los residuos urbanos sin clasificar, sino por separado. Para eliminar la batería una vez finalizada su vida útil, diríjase a un punto de recogida de residuos adecuado o a una oficina de representación de Rohde & Schwarz.
Etiquetado de la UE para baterías y acumuladores
11. En caso de devolver baterías de litio a las filiales de Rohde & Schwarz, debe cumplirse las normativas sobre los modos de transporte (IATA-DGR, código IMDG, ADR, RID).
12. Conserve estas instrucciones de seguridad para fines de información y consulta posterior.

Sicherheitshinweise für wiederaufladbare Li-Ion-Batterien

WARNUNG

Mögliche schwere Verletzungen, unter Umständen mit Todesfolge.

Beachten Sie die folgenden Hinweise vollständig, um schwere Verletzungen von Personen - unter Umständen mit Todesfolge - durch Explosion und/oder Brand zu verhindern.

1. Batterien nicht zerlegen, öffnen, zerkleinern oder aus großer Höhe fallen lassen. Bei mechanischer Beschädigung besteht die Gefahr des Austritts von Chemikalien. Austretende Gase können zu Atembeschwerden führen. Sofort lüften, in schweren Fällen einen Arzt konsultieren.
Bei Haut- oder Augenkontakt mit austretenden Chemikalien können Hautirritationen und Reizungen auftreten. In diesen Fällen die Haut oder Augen sofort gründlich mit Wasser ausspülen und einen Arzt konsultieren.
2. Zellen oder Batterien weder Hitze noch Feuer aussetzen. Nicht im direkten Sonnenlicht lagern. Bei Überhitzung besteht die Gefahr einer Explosion oder eines Brandes, was zu schweren Verletzungen bei Personen führen kann.
3. Batterien sauber und trocken halten. Falls die Anschlüsse verschmutzt sind, mit einem trockenen, sauberen Tuch reinigen.
4. Batterien vor dem Gebrauch laden.
Die Batterie darf ausschließlich mit dem entsprechenden Rohde & Schwarz Ladegerät geladen werden. Siehe Handbuch oder Datenblatt des Gerätes für die genaue Bezeichnung des Ladegerätes.
Wenn Batterien unsachgemäß geladen werden, besteht Explosionsgefahr, was zu schweren Verletzungen bei Personen führen kann.
5. Die Ladetemperatur muss zwischen 0 °C und 45 °C betragen (für mögliche Einschränkungen siehe Handbuch).
6. Ein Entladen darf nur zwischen 0 °C und 50 °C erfolgen (für mögliche Einschränkungen siehe Handbuch).
7. Batterien nur so lange laden, bis sie vollständig aufgeladen sind. Ein häufiges Überladen führt zu einer geringeren Lebensdauer der Batterie.
8. Die Batterie aus dem Gerät entfernen, wenn sie nicht benutzt wird. Nach längerer Lagerzeit kann es erforderlich sein, die Batterie mehrmals zu laden und zu entladen, um die volle Leistungsfähigkeit zu erlangen.
9. Die Batterie nur mit dafür vorgesehenen Rohde & Schwarz-Geräten betreiben. Siehe dazu das Handbuch des Gerätes.
10. Die Batterien nicht über unsortierten Siedlungsabfall entsorgen, sondern getrennt sammeln. Nach Ende der Lebensdauer über eine geeignete Sammelstelle oder eine Rohde&Schwarz-Kundendienststelle entsorgen.
EU - Kennzeichnung für Batterien und Akkumulatoren
11. Bei Rücksendungen von Lithiumbatterien zu Rohde & Schwarz - Niederlassungen müssen die Transportvorschriften der Verkehrsträger (IATA-DGR, IMDG-Code, ADR, RID) befolgt werden.
12. Diese Sicherheitsinformationen für zukünftige Informations- und Nachschlagezwecke aufbewahren.



Consignes de sécurité pour batteries rechargeables lithium-ion

AVERTISSEMENT

Risque de blessures graves pouvant entraîner la mort.

Respecter intégralement les consignes ci-dessous afin d'éliminer tout risque de blessures graves voire mortelles par suite d'explosion et/ou d'incendie.

1. Ne pas démonter, ouvrir ou découper les batteries ni les faire tomber d'une hauteur importante. Des produits chimiques peuvent s'écouler en cas de détérioration mécanique et les gaz libérés peuvent provoquer des difficultés respiratoires. Aérer immédiatement les locaux. Dans les cas graves, consulter un médecin. Si la peau ou les yeux entrent en contact avec les produits chimiques libérés, des irritations peuvent se produire. Rincer immédiatement et abondamment la peau ou les yeux à l'eau claire et consulter un médecin.
2. Ne pas exposer les cellules ou les batteries à la chaleur ou au feu. Ne pas les stocker dans un endroit exposé à la lumière directe du soleil. Toute surchauffe risque de provoquer une explosion ou un incendie, ce qui peut entraîner des blessures graves.
3. Conserver les batteries dans un lieu sec et propre. Nettoyer les points de contact sales à l'aide d'un chiffon sec et propre.
4. Charger les batteries avant utilisation. Utiliser seulement le chargeur Rohde & Schwarz approprié pour recharger les batteries. Les références exactes du chargeur sont indiquées dans le manuel ou la fiche technique de l'appareil. Une recharge incorrecte des batteries peut entraîner des explosions susceptibles de causer des blessures graves.
5. Recharger impérativement à des températures comprises entre 0 °C et 45 °C (restrictions éventuelles : voir le manuel).
6. Décharger impérativement à des températures comprises entre 0 °C et 50 °C (restrictions éventuelles : voir le manuel).
7. Terminer la charge dès que les batteries sont complètement rechargées. Une surcharge répétée diminue la longévité des batteries.
8. Retirer les batteries de l'appareil lorsqu'elles ne sont pas utilisées. Après un stockage prolongé, plusieurs cycles de recharge et de décharge peuvent s'avérer nécessaires pour rétablir la pleine capacité des batteries.
9. Utiliser les batteries exclusivement dans les appareils Rohde & Schwarz auxquels elles sont destinées. Voir le manuel fourni avec chaque appareil.



10. Ne pas éliminer les batteries avec les déchets municipaux non triés mais s'assurer qu'elles soient collectées séparément. Recycler les batteries en fin de vie en les confiant à un point de collecte compétent ou à un point de service après-vente Rohde & Schwarz.

Marquage UE pour batteries et accumulateurs

11. Lors des renvois de batteries au lithium à des filiales Rohde & Schwarz, il convient de respecter les prescriptions de transport (IATA-DGR, code IMDG, ADR, RID) fixées par les transporteurs.
12. Conserver ces consignes de sécurité de sorte à pouvoir vous y reporter ou vérifier ultérieurement certains points.

Customer Support

Technical support – where and when you need it

For quick, expert help with any Rohde & Schwarz product, contact our customer support center. A team of highly qualified engineers provides support and works with you to find a solution to your query on any aspect of the operation, programming or applications of Rohde & Schwarz products.

Contact information

Contact our customer support center at www.rohde-schwarz.com/support, or follow this QR code:



QR code to the Rohde & Schwarz support page

Contents

1 Preface.....	5
1.1 Documentation Overview.....	5
1.1.1 Manuals.....	5
1.1.2 Data Sheet.....	6
1.1.3 Calibration Certificate.....	6
1.1.4 Release Notes, Open Source Acknowledgment.....	6
1.1.5 Application Notes, Application Cards, Videos.....	6
1.2 Conventions Used in the Documentation.....	7
1.2.1 Typographical Conventions.....	7
1.2.2 Conventions for Procedure Descriptions.....	7
1.2.3 Other Conventions.....	8
2 Welcome to the R&S Cable Rider ZPH.....	9
3 Preparing for Use.....	10
3.1 Putting into Operation.....	10
3.1.1 Unpacking and Checking the Instrument.....	11
3.1.2 Accessory List.....	12
3.1.3 Setting up the R&S Cable Rider ZPH.....	12
3.1.4 Using the AC Adapter.....	14
3.1.5 Battery Operation.....	15
3.1.6 Battery Maintenance.....	17
3.2 Switching the Instrument On and Off.....	18
4 Instrument Tour.....	20
4.1 Front View.....	20
4.2 Top View.....	21

4.3 Left View..... 25

4.4 Right View.....25

4.5 Rear View.....26

4.6 Display Overview..... 26

Index..... 28

1 Preface

1.1 Documentation Overview

This section provides an overview of the R&S Cable Rider ZPH user documentation.

1.1.1 Manuals

You find the documents on the R&S Cable Rider ZPH product page at:

<http://www.rohde-schwarz.com/manual/zph>

Getting started manual

Introduces the R&S Cable Rider ZPH and describes how to set up and start working with the product. The printed document is delivered with the instrument.

User manual

Contains the description of all instrument modes and functions. It also provides an introduction to remote control, a complete description of the remote control commands with programming examples, and information on maintenance and instrument interfaces. Includes the contents of the getting started manual.

The *online version* of the user manual provides the complete contents for immediate display on the internet.

Basic safety instructions

Contains safety instructions, operating conditions and further important information. The printed document is delivered with the instrument.

Instrument security procedures manual

Deals with security issues when working with the R&S Cable Rider ZPH in secure areas.

Service manual

Describes the performance test for checking the rated specifications, module replacement and repair, firmware update, troubleshooting and fault elimination, and contains mechanical drawings and spare part lists. The service manual is available for registered users on the global Rohde & Schwarz information system (GLORIS, <https://gloris.rohde-schwarz.com>).

1.1.2 Data Sheet

The data sheet contains the technical specifications of the R&S Cable Rider ZPH. It also lists the options and their order numbers as well as optional accessories.

The brochure provides an overview of the R&S Cable Rider ZPH and shows its specific characteristics.

<http://www.rohde-schwarz.com/brochure-datasheet/zph>

1.1.3 Calibration Certificate

The document is available on <https://gloris.rohde-schwarz.com/calcert>. You need the device ID of your instrument, which you can find on a label on the rear panel.

1.1.4 Release Notes, Open Source Acknowledgment

The release notes list new features, improvements and known issues of the current firmware version, and describe the firmware installation.

The open source acknowledgment document provides verbatim license texts of the used open source software.

<http://www.rohde-schwarz.com/firmware/zph>

1.1.5 Application Notes, Application Cards, Videos

These documents contain information about possible applications and background information on various topics, see www.rohde-schwarz.com/appnotes

1.2 Conventions Used in the Documentation

The following conventions are used throughout the R&S Cable Rider ZPH manual.

1.2.1 Typographical Conventions

The following text markers are used throughout this documentation:

Convention	Description
"Graphical user interface elements"	All names of graphical user interface elements on the screen, such as dialog boxes, menus, options, buttons, and softkeys are enclosed by quotation marks.
[KEYS]	Key names are written in capital letters.
File names, commands, program code	Filenames, commands, coding samples and screen output are distinguished by their font.
<i>Input</i>	Input to be entered by the user is displayed in italics.
Links	Links that you can click are displayed in underline blue font.
"References"	References to other parts of the documentation are enclosed by quotation marks.

1.2.2 Conventions for Procedure Descriptions

When describing how to operate the instrument, several alternative methods may be available to perform the same task. In this case, the procedure using the touchscreen is described. The alternative procedure using the keys on the instrument or the on-screen keyboard is only described if it deviates from the standard operating procedures.

The term "select" may refer to any of the described methods, i.e. using a finger on the touchscreen or a key on the instrument or on a keyboard.

1.2.3 Other Conventions

Remote commands may include abbreviations to simplify input. In the description of such commands, all parts that have to be entered are written in capital letters. Additional text in lower-case characters is for information only.

2 Welcome to the R&S Cable Rider ZPH

The R&S Cable Rider ZPH is a new generation Rohde & Schwarz cable and antenna analyzer developed to meet demanding customer requirements. Offering touchscreen input, the analyzer enhances user experience in making measurements fast and easy.

This user manual contains a description of the functionality that the instrument provides. The latest version is available for download at the product homepage (<http://www.rohde-schwarz.com/product/zph.html>).

3 Preparing for Use

3.1 Putting into Operation

This chapter describes the basic steps to be taken when setting up the R&S Cable Rider ZPH for the first time.

⚠ WARNING**Risk of injury due to disregarding safety information**

Observe the information on appropriate operating conditions provided in the data sheet to prevent personal injury or damage to the instrument. Read and observe the basic safety instructions provided with the instrument, in addition to the safety instructions in the following sections. In particular:

- Do not open the instrument casing.
-

NOTICE**Risk of instrument damage due to inappropriate operating conditions**

Specific operating conditions are required to ensure accurate measurements and to avoid damage to the instrument. Observe the information on appropriate operating conditions provided in the basic safety instructions and the instrument's data sheet.

NOTICE**Instrument damage caused by electrostatic discharge**

Electrostatic discharge (ESD) can damage the electronic components of the instrument and the device under test (DUT). Electrostatic discharge is most likely to occur when you connect or disconnect a DUT or test fixture to the instrument's test ports. To prevent electrostatic discharge, use a wrist strap and cord and connect yourself to the ground, or use a conductive floor mat and heel strap combination.

NOTICE**Risk of instrument damage during operation**

An unsuitable operating site or test setup can cause damage to the instrument and to connected devices. Ensure the following operating conditions before you switch on the instrument:

- The instrument is dry and shows no sign of condensation.
- The instrument is positioned as described in the following sections.
- The ambient temperature does not exceed the range specified in the data sheet.
- Signal levels at the input connectors are all within the specified ranges.
- Signal outputs are correctly connected and are not overloaded.

 **EMI impact on measurement results**

Electromagnetic interference (EMI) may affect the measurement results.

To suppress generated electromagnetic interference (EMI):

- Use suitable shielded cables of high quality. For example, use double-shielded RF and LAN cables.
- Always terminate open cable ends.
- Note the EMC classification in the data sheet.

3.1.1 Unpacking and Checking the Instrument

Check the equipment for completeness using the delivery note and the accessory lists for the various items. Check the instrument for any damage. If there is damage, immediately contact the carrier who delivered the instrument. Make sure not to discard the box and packing material.

 **Packing material**

Retain the original packing material. If the instrument needs to be transported or shipped later, you can use the material to protect the control elements and connectors.

NOTICE**Risk of damage during transportation and shipment**

Insufficient protection against mechanical and electrostatic effects during transportation and shipment can damage the instrument.

- Always make sure that sufficient mechanical and electrostatic protection is provided.
- When shipping an instrument, the original packaging should be used. If you do not have the original packaging, use sufficient padding to prevent the instrument from moving around inside the box. Pack the instrument in antistatic wrap to protect it from electrostatic charging.
- Secure the instrument to prevent any movement and other mechanical effects during transportation.

3.1.2 Accessory List

The instrument comes with the following accessories:

- Power supply cable and adapter set
- Li-ion rechargeable battery
- USB2.0 cable A-Mini
- Side strap
- "Getting Started" printed manual
- Document folder containing safety instructions, KC and CE certificate

Optional accessories and their order numbers are listed in the data sheet.

3.1.3 Setting up the R&S Cable Rider ZPH

The R&S Cable Rider ZPH is mainly used for diagnostic purpose during the installation of RF feeder cables and antennas for all kinds of radio transmitters.

Depending on the environment, you can adjust the viewing angle of the display and either lay it out horizontally or prop it up using the support on the back of the R&S Cable Rider ZPH.



When laid out horizontally for operation from above, the R&S Cable Rider ZPH is tilted slightly due to the micro-stand at the back. This position provides the optimum viewing angle for the display.

To allow easy operation from the front and still be able to read the display, you can swing out the support on the back of the R&S Cable Rider ZPH.

Before you turn on the R&S Cable Rider ZPH, you should insert the lithium ion battery included in the delivery into the battery compartment located at the back of the R&S Cable Rider ZPH.

Insert battery

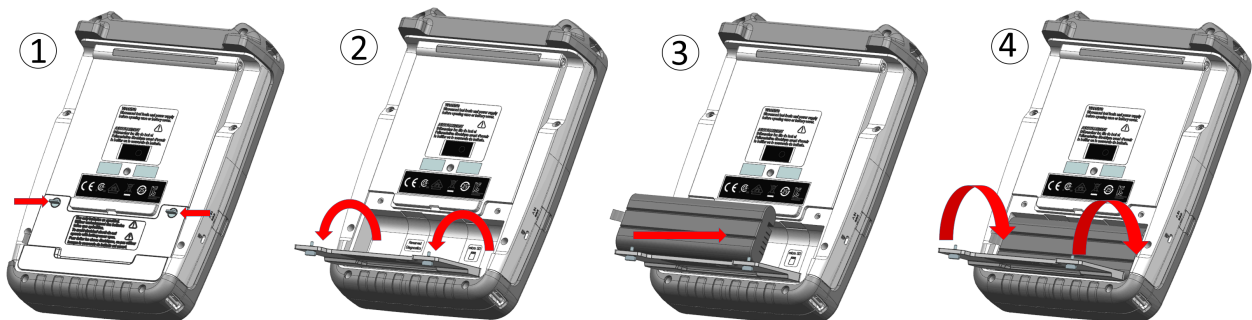

1. Unscrew the two thumb screws located on the battery compartment.
2. Open the cover.
3. Insert the battery into the R&S Cable Rider ZPH.
4. Close the cover and screw back the thumb screws.

You can operate the R&S Cable Rider ZPH with the AC adapter or the battery. Both are included in the delivery.

3.1.4 Using the AC Adapter

NOTICE

Risk of instrument damage

To avoid instrument damage:

- Only use the power supply (R&S HA-Z301, order number 1321.1386.02) included in the delivery.
- Make sure that the AC supply voltage is compatible to the voltage specified on the power supply unit.
- Attach the appropriate adapter to the power supply.

Connect the AC adapter to the DC port on the left side of the R&S Cable Rider ZPH (item 1 of [Figure 3-1](#)). Make sure to fully insert the AC adapter plug into the DC port.

Depending on the system you need, firmly connect the appropriate power cable included in the delivery to the AC adapter (item 2 of [Figure 3-1](#)).

Finally, connect the power cable plug to an AC power outlet.



Figure 3-1: AC adapter

- 1 = AC adapter
2 = Power cable

The voltage range of the AC power supply is 100 V to 240 V AC.

After the R&S Cable Rider ZPH is connected to the power supply, you can turn it on with the [Power] key on the front panel.

3.1.5 Battery Operation

The R&S Cable Rider ZPH has a smart battery indicator which displays the battery charging status on the [Power] key as well as the battery icon shown at the top right corner of the display screen. See [Chapter 4.6, "Display Overview"](#), on page 26.

The lithium ion battery has a capacity of 6.4 Ah and it allows operation of up to nine hours when it is fully charged.

The actual operation time depends on the current charged status (see [Figure 3-2](#)), the ambient temperature and the operating mode of the R&S Cable Rider ZPH.

For a summary of the LED indication of the [Power] key, see [Table 3-1](#).

The battery charging and discharging process of the battery icon indicated in the display screen is illustrated below:

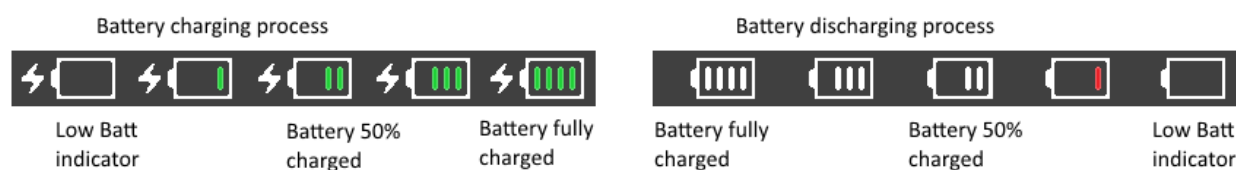

Figure 3-2: Battery charging and discharging process

Charging time is about three hours when the R&S Cable Rider ZPH is in inactive mode (i.e. R&S Cable Rider ZPH is switched off). If the instrument is in active mode (i.e. R&S Cable Rider ZPH is switched on), the charging time is extended to about four hours because the charging current is reduced as the power is partially drained by the usage of the R&S Cable Rider ZPH.

During operation in the field, you can also charge the battery with the car adapter (R&S HA-Z302, order number 1321.1340.02). You can connect the car adapter to the DC port. With the car adapter, you are able to charge the R&S Cable Rider ZPH via the car's cigarette lighter socket. A replacement battery (R&S HA-Z306, order number 1321.1334.02) with the same capacity and charging time as the battery included in the standard delivery is also available if necessary.

i Battery dispatched during delivery is not fully charged, for battery operation you have to charge it first.

To charge the battery, connect the charger to AC power adapter included in the delivery. For more information, see "[Using an external battery charger](#)" on page 16.

Using an external battery charger

You can also use an external battery charger (R&S HA-Z303, order number 1321.1328.02) to charge the battery.

To charge the battery externally, put the battery into the external charger and supply it with power via the AC power adapter.

An amber LED on the charger indicates the charging process. The LED turns to green when the battery is fully charged. A red LED on the charger indicates that the battery is not charging or the charging failed.

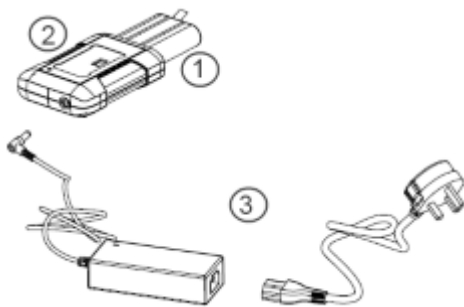

Figure 3-3: External battery charger

1 = Lithium ion battery R&S HA-Z306

2 = External charger R&S HA-Z303

3 = Power supply unit R&S HA-Z301 or car adapter R&S HA-Z302

⚠ WARNING

Risk of traffic accidents, physical injury and property damage

- Turn off the R&S Cable Rider ZPH while driving or while the engine is on.
 - Operation of the R&S Cable Rider ZPH via the cigarette lighter socket while driving or while the engine on is prohibited.
-

3.1.6 Battery Maintenance

The R&S Cable Rider ZPH comes with a lithium-ion battery. In general, these batteries are easy to handle. When you handle the battery, follow the instruction mentioned in the safety instructions and in the following chapters.

3.1.6.1 Handling

- The battery has been designed for a specific application. Do not use it for any other applications.
- Do not connect batteries in series or parallel as it can cause serious damage.
- Observe correct polarities during installation and charging.
- Do not heat over 70°C. The battery contains thermal fuses that could activate and render the battery inoperable.
- The battery contains an electronic device for protection against deep discharge, overcharge and short-circuiting between the terminals.
 - If you cannot discharge the battery, it may be deep discharged. Charge the battery for 0.5 hours and check again.
 - If you cannot charge the battery, it may be overcharged. Discharge the battery and check again.
 - If the battery has been short-circuited, charge it to reset the electronics.
 - If the battery still does not work, contact the Rohde & Schwarz customer support.
- Do not allow metallic objects to come into contact with the terminals.
- Do not solder directly to the battery.

3.1.6.2 Storage

The battery self-discharges while not in use. When storing the battery for an extended period of time, make sure to

- Handle the battery carefully to avoid short circuits. Make sure that leads and terminals are insulated.
- Keep the battery in the supplied packaging before use. The temperature should not exceed 30°C.
- Store the battery at an initial state of charge between 15% and 50% of its capacity. When calculating the initial state of charge, consider

Switching the Instrument On and Off

- The maximum consumption of electronic devices
- The self-discharge of the battery - the higher the state of charge, the higher the rate of self-discharge
- Avoid a deep discharge of the battery. A deep discharge occurs when the state of charge falls below 5% of the battery's capacity.
- Recharge the battery at least every six months.

Should the battery voltage be low or even 0 V, the battery protection circuit may have gone into a sleep mode. In that case, reset the battery with an approved charger.

3.1.6.3 Transportation

No special regulations apply for transporting the battery. The battery cells contain no metallic lithium.

3.1.6.4 End of Life

The capacity of the battery decreases after it has gone through numerous charge cycles and nearing its end of life. When the battery is dead, do not open the battery. Do not dispose battery in fire.

3.2 Switching the Instrument On and Off

The instrument can be powered with an AC or DC (battery operated or via car adapter) input. See [Chapter 3.1.4, "Using the AC Adapter"](#), on page 14.

- ▶ Press [Power] key to switch on the instrument.
During booting, the R&S Cable Rider ZPH displays a splash screen to indicate the operable frequency range of the instrument. Depending on the frequency upgrade option installed, the respective splash screen is loaded.
After booting, the instrument is ready for operation.
Refer to the instrument brochure for the list of options available.
- ▶ Press [Power] key to switch off the instrument.





NOTICE**Risk of losing data**

If a running instrument (without battery) is disconnected directly from the power cord, the instrument loses its current settings. Furthermore, program data may be lost.

Press [Power] key first to shut down the application properly.

The following shows the [POWER] key behavior in different operation modes.

Table 3-1: Summary of LED indication on POWER key

LED indication on [Power] key		Descriptions
Green LED		Instrument is in operation mode.
Blue LED		Instrument is in switch off mode with a fully charged battery. A blinking blue LED indicates that the battery charging is in process.
Amber LED		Instrument is in switch off mode with AC supply and there is no battery in it.
Red LED		There is an error in the battery charging.
LED "OFF"		This is an indication that there is no AC or DC supply to the instrument. The instrument is in a switch off mode.

4 Instrument Tour

This chapter describes the instrument in different views.

4.1 Front View



- 1 = Power meter input / RF input
- 2 = BNC connector for model .12
- 3 = Headphone jack for model .12
- 4 = USB ports
- 5 = Signal source output / Reflection (N-connector)
- 6 = Touch-sensitive screen area
- 7 = Softkey labels (on display)
- 8 = Softkey
- 9 = Systems keys
- 10 = DC port (behind protective cap)
- 11 = Kensington lock
- 12 = Function keys
- 13 = On/off key
- 14 = Alphanumeric key
- 15 = Unit keys
- 16 = Back key
- 17 = Cancel key
- 18 = Rotary knob

19 = Screenshot key

20 = LAN and mini USB port (behind protective cap)

21 = Micro-SD card slot (not visible as it is located behind the battery compartment)

For a description of the keys, see "Front Panel Keys" in the R&S Cable Rider ZPH user manual.

NOTICE

Instrument damage caused by cleaning agents

Cleaning agents contain substances that may damage the instrument. For example, cleaning agents that contain a solvent may damage the front panel labeling, plastic parts, or the display.

Never use cleaning agents such as solvents (thinners, acetone, etc.), acids, bases, or other substances.

The outside of the instrument can be cleaned sufficiently using a soft, lint-free dust cloth.

4.2 Top View



1 = Power meter input / RF input

2 = BNC connector for model .12 only

3 = Headphone jack for model .12 only

4 = USB type A connector

5 = RF out / Reflection

Power meter input / RF input

For model .02, the built-in power-meter provides a maximum power measurement of 30 dBm (or 1 W) at the RF input port. Connect a cable or DUT to the RF input with an N-type connector. Use a cable to connect the DUT to the R&S Cable Rider ZPH, if necessary.

For model .12, the RF input allows a maximum power of 20 dBm (or 100 mW) at the RF input port. The R&S Cable Rider ZPH may be loaded with up to 30 dBm (or 1 W) for up to three minutes. If you apply 1 W for a longer period, the R&S Cable Rider ZPH may be destroyed. The RF input is protected from static discharges and voltage pulses by a limiting circuit. Connect a cable or DUT to the RF input with an N-type connector. Use a cable to connect the DUT to the R&S Cable Rider ZPH, if necessary.

⚠ WARNING**Risk of electrical shock**

To avoid electrical shock, the DC input voltage must never exceed the value specified on the housing.

NOTICE**Risk of instrument damage**

To avoid damage to the coupling capacitor, input attenuator or the mixer, the DC input voltage must never exceed the value specified in the data sheet.

BNC connector

You can connect the BNC connector for various applications. It supports an external trigger signal or an external reference signal. It can also be configured as a BIAS port.

When the BNC connector is configured as a trigger input, it controls the start of a measurement. The trigger mode is selected in the SWEEP menu. The trigger threshold is similar to that of TTL signals.

When the BNC connector is configured as reference input, you can apply a 10 MHz external reference signal to it for frequency synchronization. The external reference label **Ext Ref** is displayed at the top right corner of the trace window to indicate that the reference signal is supplied via external signal input. The label turns green when the reference signal is detected.

The level of the reference signal must be larger than 0 dBm. If there is no reference signal present at the BNC connector, the R&S Cable Rider ZPH displays an appropriate message. Thus, measurements without a valid reference can be avoided.

When the BNC connector is configured as an internal DC bias port, the BNC connector provides direct current output. Active equipment under test can be supplied with power via the bias port.

NOTICE**Risk of instrument damage**

To avoid damage to the tracking generator output, never apply currents greater than 600 mA or voltages greater than 20 V to the BNC connectors if the BNC connectors are not configured as BIAS output ports.

If they are configured as BIAS ports, never apply currents greater than 600 mA or voltages greater than 50 V.

Headphone jack

The 3.5 mm connector for headphones has an internal impedance of approximately 10 Ω .

USB type A connector

The USB port provides the USB interface to connect a memory stick and store data sets or screenshots. It can also be used to control the operation of the external power sensor.

RF out / Reflection

For model .02, the RF out connector provides a signal source output power at -10.00 dBm nominal.



For model .12, the RF out connector provides the following ways to generate a signal source output power at -10.00 dBm nominal.

- Tracking generator output
- Continuous signal source output
- Coupled continuous signal source output

NOTICE**Risk of DUT damage**

The R&S Cable Rider ZPH displays a signal source indicator on the [title bar](#). When the indicator shows a full green circle, signal source is present on the RF out connector.

To prevent damage on DUT, it is important to consider maximum input power on DUT before connection.

-  : Signal source is present on the RF out connector
-  : Signal source is not present on the RF out connector

For model .12, the RF out connector can also be configured as an internal DC bias port. When the RF out is configured as a BIAS port, the RF out connector provides direct current output. Active equipment under test can be supplied with power via the bias port.

⚠ WARNING**Risk of electrical shock**

To avoid electrical shock, the DC input voltage must never exceed the value specified on the housing.

NOTICE**Risk of instrument damage**

- Make sure not to overload the RF input and keep within the maximum allowed signal levels. Refer to the datasheet for the maximum allowed signal levels.
- To avoid damage to the coupling capacitor, input attenuator or the mixer, the DC input voltage of 50 V must never be exceeded.

4.3 Left View

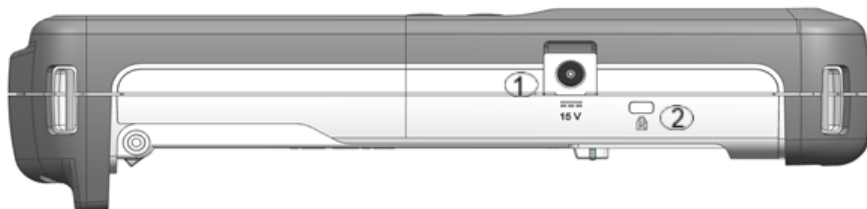

1 = DC input

2 = Kensington lock slot

DC input

The R&S Cable Rider ZPH is supplied with power by the AC/DC transformer power supply via the DC connector. You can also use the DC connector to charge the battery.

Kensington lock slot

A Kensington lock can be anchored to the R&S Cable Rider ZPH housing to secure it to a workstation mechanically.

4.4 Right View

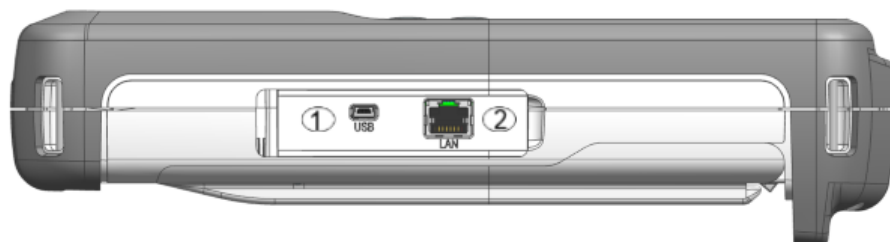

1 = Min USB port

2 = LAN port

LAN connector

RJ-45 connector to connect the instrument to a Local Area Network (LAN) and transfer data in both directions. It supports up to 100 Mbit/s.

USB type B connector (mini USB)

Mini USB connector to connect a computer for remote control of the instrument and transfer data in both directions.

4.5 Rear View

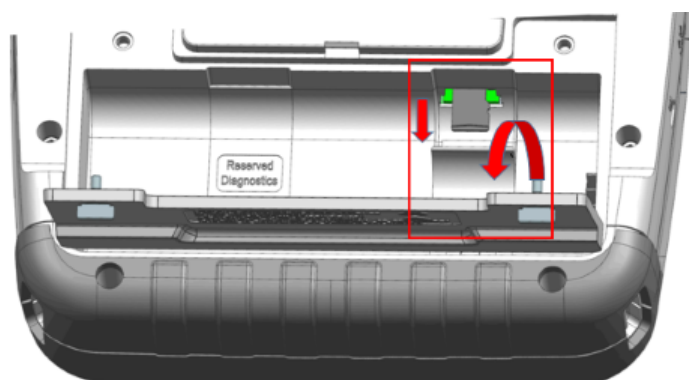

The micro-SD card slot is located behind the battery compartment of the R&S Cable Rider ZPH.

Peel open the micro-SD card protective cap to access to the micro-SD card slot. You can use the micro-SD card to store datasets or screenshots.

4.6 Display Overview

The display area has a touch-sensitive screen, the touch functionality can be turned on or off in the instrument setup menu.

For information on the different sections of the display area and touchscreen gestures, see "Screen Layout and Elements" and "Touchscreen Gesture Elements" in the R&S Cable Rider ZPH user manual.

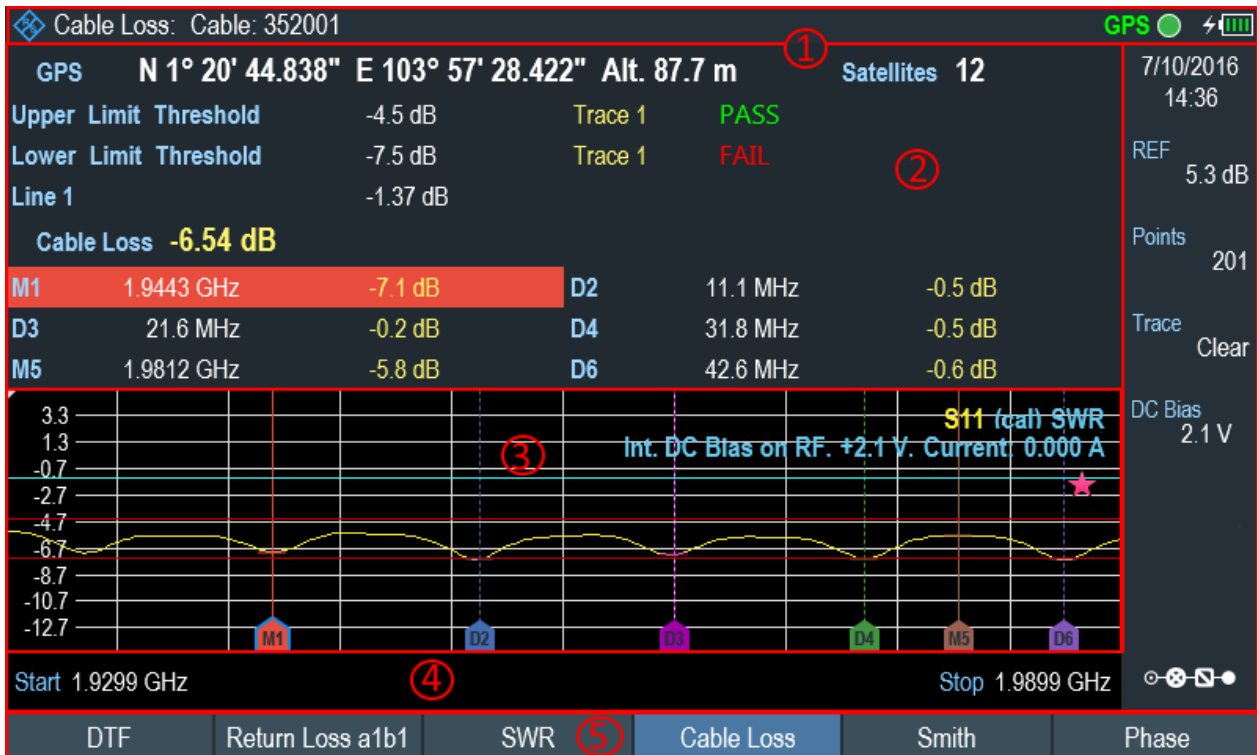

Figure 4-1: Display overview

- 1 = Title bar
- 2 = Measurement result view
- 3 = Measurement trace window
- 4 = Parameter view
- 5 = Softkey functions

NOTICE

Risk of touchscreen damage during operation

- Never touch the screen with ball point pens or other pointed objects with sharp edges.
- It is recommended that you operate the touchscreen by finger only. As an alternative, you may use a stylus pen with a smooth soft tip.
- Never apply excessive force to the screen. Touch it gently.
- Never scratch the screen surface, e.g. with a finger nail. Never rub it strongly, for example with a dust cloth.

Index

A

AC adapter	14
Application cards	6
Application notes	6

B

Battery insertion	12
Battery maintenance	17
Battery operation	
Battery (car adapter)	15
Battery (charging)	15
Battery (external charger)	15
Battery (replacement)	15
Brochure	6

C

Calibration certificate	6
Conventions	7

D

Data sheet	6
Documentation overview	5

E

Electrostatic discharge	10
ESD	10

G

Getting started	5
-----------------------	---

I

Instrument tour	20
-----------------------	----

O

Open source acknowledgment (OSA)	6
--	---

P

Package contents	12
Positioning	
Support	12
Putting into operation	10

R

Release notes	6
---------------------	---

S

Safety instructions	5
Switching on and off the instrument	18

U

Unpacking and checking the instrument ..	11
User manual	5

W

White papers	6
--------------------	---