

R&S® ZVH

Cable and Antenna Analyzer

Quick Start Guide



1309.6900.12 – 06

ROHDE & SCHWARZ

Make ideas real



The Quick Start Guide describes the following R&S®ZVH models and options

- R&S ZVH4 (1309.6800.24)
- R&S ZVH8 (1309.6800.28)
- R&S ZVH-K1 (1309.6823.02)
- R&S ZVH-K9 (1309.6852.02)
- R&S ZVH-K39 (1309.6830.02)

The contents of this manual correspond to firmware version 1.90 and higher.

© 2021 Rohde & Schwarz GmbH & Co. KG

Muehldorfstr. 15, 81671 Munich, Germany

Phone: +49 89 4129-0

E-mail: info@rohde-schwarz.com

Internet: <http://www.rohde-schwarz.com>

81671 Munich, Germany

Subject to change – Data without tolerance limits is not binding.

R&S® is a registered trademark of Rohde & Schwarz GmbH & Co. KG.

Trade names are trademarks of the owners.

The following abbreviations are used throughout this manual:

R&S®ZVH is abbreviated as R&S ZVH.

Table of Contents

Safety Instructions	4
Instrucciones de seguridad	5
Sicherheitshinweise	6
Consignes de sécurité	7
Documentation Overview	8
Contacting Customer Support	10
1 Putting into Operation	11
1.1 Unpacking the R&S ZVH	12
1.2 Overview of Controls	13
1.3 Setting up the R&S ZVH	14
1.3.1 Using the AC Adapter	15
1.3.2 Battery Operation.....	16
1.3.3 Battery Maintenance	18
1.3.3.1 Handling.....	18
1.3.3.2 Storage	18
1.3.3.3 Transportation.....	19
1.3.3.4 End of Life.....	19
1.4 Connectors on the R&S ZVH	20
1.4.1 RF Input	21
1.4.2 Tracking Generator Output.....	22
1.4.3 Power Sensor Port.....	22
1.4.4 Headphone Jack	23
1.4.5 AUX Input.....	23
1.4.6 BNC Connectors	24
1.4.6.1 EXT TRIG / EXT REF	24
1.4.6.2 BIAS Port 1 / BIAS Port 2	24
1.4.6.3 IF Output.....	25
1.4.7 Mini USB and LAN Ports	26
1.4.8 Mechanical Locking Device	26

1.4.9	DC Port	27
1.4.10	USB Port	27
1.4.11	SD Card Slot	27
1.5	Managing Options.....	28
1.5.1	Enabling Options.....	28
1.5.2	Checking Installed Options	28
1.5.3	Managing Options with the R&S License Manager	29
1.6	Configuring the R&S ZVH	31
1.6.1	Configuring the Hardware	32
1.6.2	Configuring Antennas	34
1.6.3	Using the GPS Receiver	35
1.6.4	Configuring Date and Time	37
1.6.5	Selecting Regional Attributes.....	38
1.6.6	Configuring the Display.....	40
1.6.7	Configuring Audio Output	41
1.6.8	Configuring Power Supply	42
1.6.9	Self Alignment.....	43
1.6.10	Using a PIN Code	43
1.6.11	Resetting the R&S ZVH	44
1.7	Connecting the R&S ZVH to a PC	45
1.7.1	Connecting the R&S ZVH in a LAN	45
1.7.2	Connecting the R&S ZVH in an existing LAN	48
1.7.3	Connecting the R&S ZVH via USB	49
2	Getting Started	50
2.1	Using the Measurement Wizard	51
2.1.1	Defining Measurement Sets	51
2.1.2	Uploading Measurement Sets	52
2.1.3	Performing Measurements	53
2.1.4	Evaluating the Results	55
2.2	Identifying Cable Faults	56
2.3	Measuring Transmissions (Option R&S ZVH-K39).....	61
2.4	Using the Spectrum Analyzer (Option R&S ZVH-K1).....	63
2.4.1	Attenuating the Signal.....	63

2.4.2	Using the Preamplifier	65
2.4.3	Measuring CW Signals	66
2.5	Using a Power Sensor (Option R&S ZVH-K9)	68
2.5.1	Measuring the Power with a Power Sensor	69
2.5.2	Measuring Power and Return Loss	71
2.6	Saving and Recalling Results and Settings	73
2.6.1	Saving Measurement Results	73
2.6.2	Recalling Measurement Results	74
	Index	75

Safety Instructions

 WARNING**Risk of injury and instrument damage**

The instrument must be used in an appropriate manner to prevent personal injury or instrument damage.

- Do not open the instrument casing.
 - Read and observe the "Basic Safety Instructions" delivered as printed brochure with the instrument or in electronic format on the documentation CD-ROM.
 - Read and observe the safety instructions in the following sections. Note that the data sheet may specify additional operating conditions.
 - Keep the "Basic Safety Instructions" and the product documentation in a safe place and pass them on to the subsequent users.
-

The R&S ZVH has been designed for lab operation as well as for service and maintenance applications in outdoor areas. Thus, the following safety instructions apply in addition to or contrary to the "Basic Safety Instructions" leaflet.

1. The R&S ZVH is protected against dripping water and dust (IP degree 51) and can thus be used in outdoor areas to a certain degree.
2. The R&S ZVH's max. operating altitude is 4600 m above sea level and its max. transport altitude is 12000 m above sea level.

Instrucciones de seguridad

ADVERTENCIA

Riesgo de lesiones y daños en el instrumento

El instrumento se debe usar de manera adecuada para prevenir descargas eléctricas, incendios, lesiones o daños materiales.

- No abrir la carcasa del instrumento.
- Lea y cumpla las "Instrucciones de seguridad elementales" suministradas con el instrumento como folleto impreso o en formato electrónico en el CD-ROM de documentación.
- Lea y cumpla las instrucciones de seguridad incluidas en las siguientes secciones. Se debe tener en cuenta que las especificaciones técnicas pueden contener condiciones adicionales para su uso.
- Guarde bien las instrucciones de seguridad elementales, así como la documentación del producto, y entréguelas a usuarios posteriores.

El R&S ZVH está diseñado tanto para el uso en el laboratorio como para aplicaciones de servicio y mantenimiento al aire libre. En consecuencia, las instrucciones de seguridad siguientes son aplicables de manera adicional a las "Informaciones elementales de seguridad" (folleto) o en lugar de estas en los puntos en los que diverjan.

1. El R&S ZVH está protegido contra las salpicaduras de agua y contra el polvo (IP 51), por lo que hasta cierto punto se puede usar en exteriores sin problemas.
2. La altitud máxima de funcionamiento del R&S ZVH es de 4600 m sobre el nivel del mar, mientras que su altitud máxima de transporte es de 12 000 m sobre el nivel del mar.

Sicherheitshinweise

WARNUNG

Gefahr von Verletzungen und Schäden am Gerät

Betreiben Sie das Gerät immer ordnungsgemäß, um elektrischen Schlag, Brand, Verletzungen von Personen oder Geräteschäden zu verhindern.

- Öffnen Sie das Gerätegehäuse nicht.
 - Lesen und beachten Sie die "Grundlegenden Sicherheitshinweise", die als gedruckte Broschüre dem Gerät beiliegen oder elektronisch auf der Dokumentation CD-ROM zu finden sind.
 - Lesen und beachten Sie die Sicherheitshinweise in den folgenden Abschnitten; möglicherweise enthält das Datenblatt weitere Hinweise zu speziellen Betriebsbedingungen.
 - Bewahren Sie die "Grundlegenden Sicherheitshinweise" und die Produktdokumentation gut auf und geben Sie diese an weitere Benutzer des Produkts weiter.
-

Der R&S ZVH wurde für den Einsatz im Labor sowie für Service- und Wartungseinsätze im Freien entwickelt. Deshalb gelten zusätzlich oder im Gegensatz zur Broschüre „Grundlegende Sicherheitshinweise“ die folgenden Sicherheitshinweise.

1. Der R&S ZVH ist gegen Spritzwasser und Staub geschützt (IP-Schutzart 51) und kann daher bis zu einem gewissen Grad im Freien verwendet werden.
2. Die maximale Betriebshöhe des R&S ZVH beträgt 4600 m ü. NN und die maximale Transporthöhe 12000 m ü. NN

Consignes de sécurité

AVERTISSEMENT

Risque de blessures et d'endommagement de l'appareil

L'appareil doit être utilisé conformément aux prescriptions afin d'éviter les électrocutions, incendies, dommages corporels et matériels.

- N'ouvrez pas le boîtier de l'appareil.
- Lisez et respectez les "consignes de sécurité fondamentales" fournies avec l'appareil sous forme de brochure imprimée ou disponibles en format électronique sur le CD-ROM de documentation.
- Lisez et respectez les instructions de sécurité dans les sections suivantes. Il ne faut pas oublier que la fiche technique peut indiquer des conditions d'exploitation supplémentaires.
- Gardez les consignes de sécurité fondamentales et la documentation produit dans un lieu sûr et transmettez ces documents aux autres utilisateurs.

Le R&S ZVH a été conçu pour le fonctionnement en laboratoire ainsi que pour les applications de service et de maintenance en extérieur. Par conséquent, les instructions de sécurité suivantes s'appliquent en plus de la fiche « Consignes fondamentales de sécurité » ou s'opposent à elles.

1. Le R&S ZVH est protégé contre les projections d'eau et la poussière (niveau de protection IP 51) et peut par conséquent être utilisé en extérieur dans une certaine mesure.
2. Le R&S ZVH est utilisable jusqu'à une altitude maximale de 4600 m au-dessus du niveau de la mer, et peut être transporté à une altitude maximale de 12000 m au-dessus du niveau de la mer.

Documentation Overview

The user documentation for the R&S ZVH is divided as follows:

Quick Start Guide

The Quick Start Guide provides basic information on the instrument's functions.

It covers the following topics:

- overview of all elements of the front and rear panels
- basic information on how to set up the R&S ZVH
- information on how to operate the R&S ZVH in a network
- instructions on how to perform measurements

Operating Manual

The Operating Manual provides a detailed description on the instrument's functions

It covers the following topics:

- instructions on how to set up and operate the R&S ZVH in its various operating modes
- instructions on how to perform measurements with the R&S ZVH
- instructions on how to work with the available software options and applications

Manual for Remote Control Operation

The software manual for the R&S ZVH-K40 provides a detailed description of the remote control option.

It covers the following topics:

- introduction to the operation of the R&S ZVH via remote control
- detailed description of the remote control commands available with the R&S ZVH-K40 software application.
- description of the status reporting system

Service Manual

The Service Manual provides information on maintenance.

It covers the following topics:

- instructions on how to perform a performance test
- instructions on how to repair the R&S ZVH including a spare parts list
- mechanical drawings

Release Notes

The release notes describe the installation of the firmware, new and modified functions, eliminated problems, and last minute changes to the documentation. The corresponding firmware version is indicated on the title page of the release notes. The current release notes are provided on the internet.

Internet Site

The internet site at: <http://www.rohde-schwarz.com/product/zvh.html> provides the most up to date information on the R&S ZVH. The most recent manuals are available as printable PDF files in the download area.

Also provided for download are firmware updates including the corresponding release notes, instrument drivers, current data sheets, application notes and image versions.

Calibration certificates

The calibration certificates of your device are available online. Visit the R&S ZVH product page and select the item to download the calibration certificate. You will be forwarded to a Gloris page.

<https://gloris.rohde-schwarz.com/calcert>

Enter the device ID of your R&S ZVH and download the certificate. You can find the device ID either in the "Setup" menu or on the label on the rear panel.

Contacting Customer Support

Technical support – where and when you need it

For quick, expert help with any Rohde & Schwarz product, contact our customer support center. A team of highly qualified engineers provides support and works with you to find a solution to your query on any aspect of the operation, programming or applications of Rohde & Schwarz products.

Contact information

Contact our customer support center at www.rohde-schwarz.com/support, or follow this

QR code:



1 Putting into Operation

This chapter assists you in using the R&S ZVH for the first time.

It contains general information about the R&S ZVH as well as information about the available connectors and the general system configuration.

Contents

- [Unpacking the R&S ZVH](#) (p. 12)
- [Overview of Controls](#) (p. 13)
- [Setting up the R&S ZVH](#) (p. 14)
- [Connectors on the R&S ZVH](#) (p. 20)
- [Managing Options](#) (p. 28)
- [Configuring the R&S ZVH](#) (p. 31)
- [Connecting the R&S ZVH to a PC](#) (p. 45)

1.1 Unpacking the R&S ZVH

The R&S ZVH is delivered in formfitting packaging. It consists of an upper and a lower shell. The two shells are held together by tape.

The packaging contains all accessories that are supplied with the instrument.

- ▶ Remove the tape and open the packaging.
- ▶ Remove the R&S ZVH and its accessories.
- ▶ Remove the protective film from the screen.

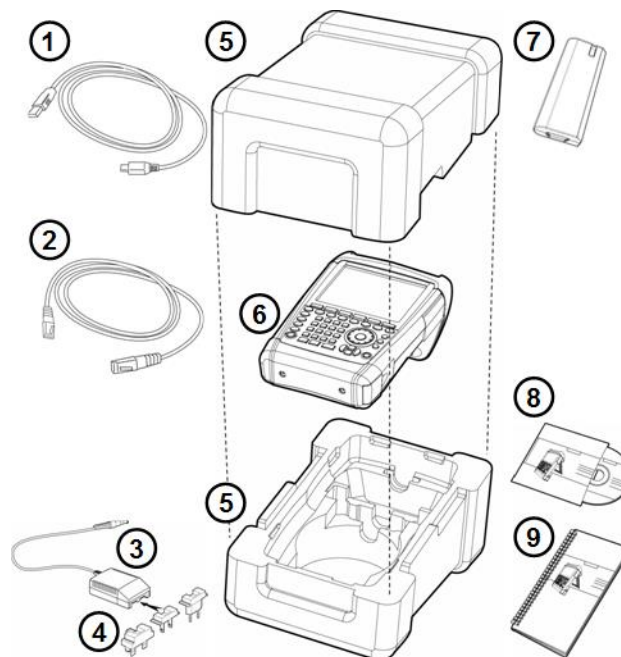

- | | |
|---|----------------------------|
| 1 | USB cable |
| 2 | LAN cable |
| 3 | AC adapter |
| 4 | AC plug (country specific) |
| 5 | Upper and lower shell |
| 6 | R&S ZVH |
| 7 | Lithium ion battery |
| 8 | CD-ROM |
| 9 | Quick Start manual |

1.2 Overview of Controls



- 1 RF input (N-connector)
- 2 Headphone jack
- 3 BNC connectors (behind protective cap)
- 4 LAN and Mini USB ports (behind protective cap)
- 5 Softkey labels (on display)
- 6 Softkeys
- 7 Function keys
- 8 Alphanumeric keypad
- 9 Kensington lock
- 10 DC port
- 11 On/Off key
- 12 Entry keys
- 13 Unit keys
- 14 Cursor keys
- 15 Preset key
- 16 Rotary knob
- 17 Screenshot key
- 18 Setup key
- 19 Display
- 20 SD card slot / USB port (behind protective cap)
- 21 Tracking generator output (N-connector)
- 22 Power sensor jack

1.3 Setting up the R&S ZVH

The R&S ZVH has been designed for lab operation as well as for service and maintenance applications on-site.

Depending on the environment, you can adjust the viewing angle of the display and either lay it out flat or prop it up using the support on the back of the R&S ZVH.



When laid out flat for operation from above, the R&S ZVH is still tilted slightly because of the grip on its top. This position provides the optimum viewing angle for the display.

To allow easy operation from the front and still be able to read the display, you can swing out the support on the back of the R&S ZVH.

For use on site or service measurements, it is best to hold the instrument in both hands. All controls are easy to reach. It is also recommended to use the R&S HA-Z222 carrying bag in order to leave both hands free for work on the device under test (DUT).

You can also use the grip on the top of the R&S ZVH to hang it from cabinet doors, for example.

Before you turn on the R&S ZVH, you should insert the lithium ion battery included in the delivery into the battery compartment. The battery compartment is located on the bottom right of the R&S ZVH.

(1) Press a finger against the recessed grip and push the cover down.

(2) Open the cover.

(3) Insert the battery into the compartment with the round side facing upwards and the handle facing outwards.

(4) Close the cover.

(5) Push the cover up until it clicks fully into place.

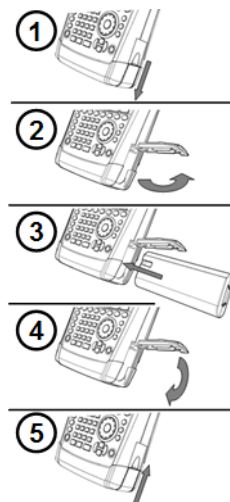

You can operate the R&S ZVH with the AC adapter or the battery. Both are included in the delivery.

1.3.1 Using the AC Adapter

Connect the AC adapter (R&S HA-Z201) to the DC port on the left side of the R&S ZVH (1). Make sure to fully insert the plug into the port.

Depending on the system you need, firmly connect the appropriate plug included in the delivery (2) to the AC adapter.

Finally, connect the plug to an AC power outlet.

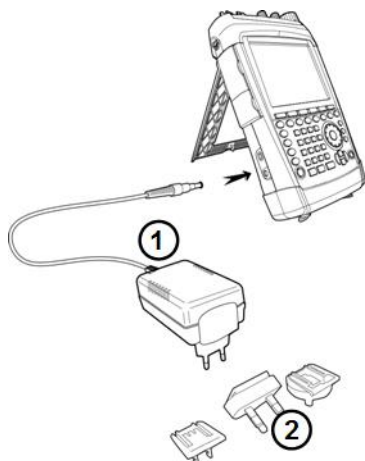

The voltage range of the AC power supply is 100 V to 240 V AC.

When the R&S ZVH is supplied with power, you can turn it on with the  button on the front panel.

NOTICE

Risk of instrument damage

To avoid instrument damage,

- only use the power supply included in the delivery (R&S HA-Z201).
 - make sure that AC supply voltage is compatible to the voltage specified on the power supply unit.
 - attach the appropriate adapter to the power supply.
-

1.3.2 Battery Operation

The lithium ion battery has a capacity of approximately 4 Ah and allows operation of up to three hours when it is fully charged.

The actual operation time depends on the current charge status, the ambient temperature and the operating mode of the R&S ZVH.

The R&S ZVH shows the current charge status at the top of the display.



When fully charged, the battery icon is completely white. As the battery loses power, the white color in the battery icon fades away until it turns red and starts to blink. When the icon starts to blink, the battery low level has been reached. For more information see "[Configuring Power Supply](#)" on page 42.

Note that the battery is not fully charged when it is dispatched. For battery operation you have to charge it first.

To charge the battery, connect the AC power adapter included in the delivery. For more information see "[Using the AC Adapter](#)" on page 15.

Charging time is about 2.5 hours when the R&S ZVH is switched off. If it is switched on, the charging time is extended to about 3.5 hours, because the charging current is reduced by the power drain of the R&S ZVH.

During operation in the field, you can also charge the battery with the R&S HA-Z202 car adapter (order no. 1309.6117.00). You can connect the car adapter to the DC port. With the car adapter, you are able to charge the R&S ZVH via the car's cigarette lighter socket.

While charging, the R&S ZVH displays an arrow within the battery charge status indicator at the top right of the display to show that it is connected to the power supply and is charging.

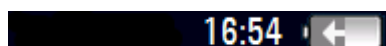

When the battery is fully charged (or when you use the R&S ZVH without a battery), a plug icon is displayed instead of the battery icon.



You can set up the R&S ZVH to automatically turn off if no input is made after a particular time period. The possible range is from 0 to 99 minutes. For more information see "[Configuring the Display](#)" on page 40.

In the default state, the automatic cut-off is inactive.

A replacement battery (R&S FSH-Z206) with a capacity of approximately 6 Ah and an operating time of 4.5 hours is available as an accessory. Charging time for the replacement battery is about 3.5 hours if the R&S ZVH is switched off and about 4.5 hours if the R&S ZVH is switched on.

Using an external battery charger

You can also use an external battery charger (R&S HA-Z203, order no. 1309.6123.00) to charge an additional replacement battery.

To charge the battery externally, put the battery into the external charger and supply it with power via the AC power adapter.

An orange LED (CHARGE) on the charger indicates the charging process. The orange LED turns off when the battery is fully charged. When the battery is fully charged, a green LED (READY) turns on instead.

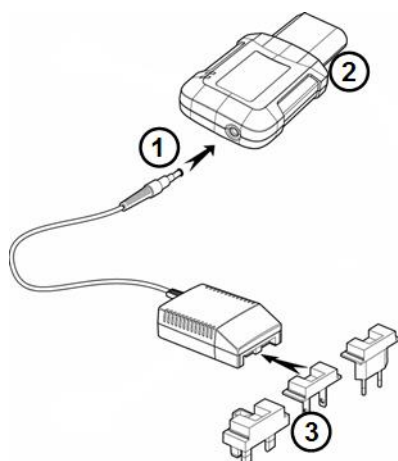

- 1 External charger R&S HA-Z203
- 2 Lithium ion battery R&S HA-Z204 or HA-Z206
- 3 Power supply unit R&S Z201 or car adapter R&S HA-Z202

⚠ WARNING

Turn off the R&S ZVH while driving or while the engine is on.

Operation of the R&S ZVH via the cigarette lighter socket while driving or while the engine is on is prohibited.

1.3.3 Battery Maintenance

The R&S ZVH comes with a lithium-ion battery. In general, these batteries are easy to handle. When you handle the battery, mind the things mentioned in the safety instructions and those in this chapter.

1.3.3.1 Handling

- The battery has been designed for a specific application. Do not use it for any other application
- Do not connect batteries in series or parallel as it can cause serious damage.
- Observe correct polarities during installation and charging.
- Do not heat over 70°C. The battery contains thermal fuses that could activate and render the battery inoperable.
- The battery contains an electronic device for protection against deep discharge, overcharge and short-circuiting between the terminals.
 - If you cannot discharge the battery, it may be deep discharged. Charge the battery for 0.5 hours and check again.
 - If you cannot charge the battery, it may be overcharged. Discharge the battery and check again.
 - If the battery has been short-circuited, charge it to reset the electronics.
 - If the battery still does not work, contact the Rohde & Schwarz customer support.
- Do not allow metallic objects to come into contact with the terminals.
- Do not solder directly to the battery.

1.3.3.2 Storage

The battery self-discharges while not in use. When storing the battery for an extended period of time, make sure to

- handle the battery carefully to avoid short circuits. Make sure that leads and terminals are insulated.
- keep the battery in the supplied packaging prior to use. The temperature must be between -20°C and +50°C.
- store the battery at an initial state of charge between 15% and 50% of its capacity. When calculating the initial state of charge, consider
 - the maximum consumption of electronic devices
 - the self-discharge of the battery - the higher the state of charge, the higher the rate of self-discharge
- avoid a deep discharge of the battery. A deep discharge occurs when the state of charge falls below 5% of the battery's capacity.
- recharge the battery at least every three months.

Should the battery voltage be low or even 0 V, the battery protection circuit may have gone into a sleep mode. In that case, reset the battery with an approved charger.

1.3.3.3 Transportation

No special regulations apply for transporting the battery. The battery cells contain no metallic lithium.

1.3.3.4 End of Life

The capacity of the battery decreases after it has gone through numerous charge cycles and nears its end of life. When the battery is dead, do not open the battery. Dispose of it at a suitable collection point.

1.4 Connectors on the R&S ZVH

The R&S ZVH has several connectors. The connectors are either on the upper, left or right side.

Contents

- [RF Input](#) (p. 21)
- [Tracking Generator Output](#) (p. 22)
- [Power Sensor Port](#) (p. 22)
- [Headphone Jack](#) (p. 23)
- [AUX Input](#) (p. 23)
- [BNC Connectors](#) (p. 24)
- [Mini USB and LAN Ports](#) (p. 26)
- [Mechanical Locking Device](#) (p. 26)
- [DC Port](#) (p. 27)
- [USB Port](#) (p. 27)
- [SD Card Slot](#) (p. 27)

1.4.1 RF Input

The RF input is located on the top of the R&S ZVH.



Connect a cable or DUT to the RF input with an N connector. Use a cable to connect the DUT to the R&S ZVH, if necessary.

Make sure not to overload the R&S ZVH when a DUT is connected.

The maximum power that is permissible at the RF input is 20 dBm (or 100 mW).

The R&S ZVH may be loaded with up to 30 dBm (or 1 W) for up to three minutes. If you apply 1 W for a longer period, the R&S ZVH may be destroyed.

The RF input is protected from static discharges and voltage pulses by a limiting circuit.

WARNING

Risk of electrical shock

In order to avoid electrical shock, the DC input voltage must never exceed the value specified on the housing.

NOTICE

Risk of instrument damage

To avoid damage to the coupling capacitor, input attenuator or the mixer, the DC input voltage must never exceed the value specified in the data sheet.

1.4.2 Tracking Generator Output

The tracking generator output is located on the top of the R&S ZVH.



The tracking generator output power of the R&S ZVH is 0 dBm nominal.

With an integrated step attenuator, you can reduce the tracking generator output power by a maximum of 40 dB in 1 dB steps.

NOTICE

Risk of instrument damage

To avoid damage to the tracking generator output, the reverse voltage up to the voltage stated on the R&S ZVH housing must not be exceeded.

1.4.3 Power Sensor Port

The connector for power sensors is located on the top of the R&S ZVH.



The connector is configured especially for power sensors. It is used for both the power supply and data transfer via the power sensor interface.

Additionally, you can connect accessories like the R&S TS-EMF isotropic antenna (order no. 1158.9295.13) to the power sensor port.

1.4.4 Headphone Jack

The 3.5 mm connector for headphones is located on the top of the R&S ZVH.



The internal impedance of the connector is approximately 10 Ohm.

1.4.5 AUX Input

The AUX input is located on the left side of the R&S ZVH under a protective cap.



You can connect various accessories like the GPS receiver R&S HA-Z240 (order no. 1309.6700.02) to the AUX connector.

1.4.6 BNC Connectors

The BNC connectors are located on the left side of the R&S ZVH behind a protective cap.



You can configure both BNC connectors for various applications. The name of the connector is printed on the insides of the protective caps.

1.4.6.1 EXT TRIG / EXT REF

The first (upper) BNC connector supports an external trigger source or an external reference signal.

The external trigger is only for input configuration. It controls the start of a measurement and has to be selected in the "Sweep" menu. The trigger threshold is similar to that of TTL signals.

The 10 MHz reference signal that you can apply is used for frequency synchronization. The level of the reference signal must be larger than 0 dBm. When the BNC connector is configured for the external reference but no reference signal is present, the R&S ZVH displays an appropriate message. Thus, measurements without a valid reference can be avoided.

For more information see "[Configuring the Hardware](#)" on page 32.

1.4.6.2 BIAS Port 1 / BIAS Port 2

When you use the BNC connectors as BIAS ports, the two BNC connectors are direct current inputs.

Active equipment under test can be supplied with power via the BIAS Port 1 and BIAS Port 2 direct current inputs. Direct current is supplied with the assistance of a suitable power adapter (600 mA max. / 50 V max.).

1.4.6.3 IF Output

The second (lower) BNC connector can be used as an intermediate frequency output (54.4 MHz).

NOTICE**Risk of instrument damage**

To avoid damage to the tracking generator output, never apply currents greater than 600 mA or voltages greater than 20 V to the BNC connectors if the BNC connectors are not configured as BIAS input ports.

If they are configured as BIAS ports, never apply currents greater than 600 mA or voltages greater than 50 V.

1.4.7 Mini USB and LAN Ports

The mini USB and LAN ports are located on the left side of the R&S ZVH behind a protective cap.



You can connect the R&S ZVH to a PC via USB or LAN and transfer data in both directions.

Configure the USB and LAN connection via the "Instrument Setup". For more information see "[Connecting the R&S ZVH to a PC](#)" on page 45.

1.4.8 Mechanical Locking Device

A Kensington Lock can be anchored to the R&S ZVH housing to secure the R&S ZVH to a workstation mechanically.



1.4.9 DC Port

The DC port is located on the left side of the R&S ZVH.



The R&S ZVH is supplied with power by the AC/DC transformer power supply via the DC connector. You can also use the DC connector to charge the battery.

1.4.10 USB Port

The USB port is located on the right side of the R&S ZVH behind a protective cap.

You can use the USB interface to connect a memory stick and store data sets or screenshots, for example.

1.4.11 SD Card Slot

The SD Card slot is located on the right side of the R&S ZVH behind a protective cap.

You can use an SD card to store data sets or screenshots, for example.

1.5 Managing Options

For special measurement tasks, you can equip the R&S ZVH with various firmware options.

1.5.1 Enabling Options

To enable options, you have to enter a key code. The key code is based on the unique serial number of the R&S ZVH.

- ▶ Press the SETUP key.
- ▶ Press the "Installed Options" softkey.
- ▶ Select the "Install Option..." item.
- ▶ Press the ENTER key.

The R&S ZVH opens an input field to enter the option key.

- ▶ Enter the appropriate option key.
- ▶ Confirm the entry with the ENTER key.

If you have entered the correct code, the R&S ZVH shows

Installation successful !

If you have entered an incorrect code, the R&S ZVH shows

Invalid key code!

- ▶ Enter the correct code again.

1.5.2 Checking Installed Options

In the "Setup" menu, the R&S ZVH shows all options that are currently installed.

- ▶ Press the SETUP key.
- ▶ Press the "Installed Options" softkey.

The R&S ZVH shows a list of all available options and the current status of the option:

- "Installed": the option is installed and working.
- "Installed Portable": the option is installed and working, the license is a portable one.
- "Removed: <option key>": indicates that a portable license has been removed from the R&S ZVH and is ready to be transferred to another R&S ZVH.

1.5.3 Managing Options with the R&S License Manager

If you are using the R&S ZVH in a local area network (LAN), you can manage firmware options with a web browser (e.g. Microsoft Internet Explorer or Mozilla Firefox).

For more information on connecting the R&S ZVH to a LAN see "[Connecting the R&S ZVH to a PC](#)" on page 45.

After you have connected the R&S ZVH, open your web browser.

- ▶ Enter the IP address of the R&S ZVH in the address bar of the web browser.



The browser will access the R&S License Manager. In this part of the R&S License Manager, you can install and activate licenses on the R&S ZVH.

This page features three areas.

- The first area shows the details of the connected device including the device ID and the IP address.

Connected Device		
FSH4	Device ID:	1309.6000K24-900204-nK
FSH4	IP Address:	10.113.10.184
Version: V1.50	Host Name:	localhost

- The second area provides functionality to install and activate licenses.



- Install Registered License Keys and Activate Licenses

Follow this link if you have purchased a registered license. Registered licenses only work in combination with a specific device ID.

- Register Licenses, Install License Keys and Activate Licenses

Follow this link if you have purchased an unregistered license. Unregistered licenses are not connected to a specific device ID.

- Reboot Device

Follow this link to reboot the R&S ZVH.



Opens a detailed online help to the corresponding topic.

- The third area provides hints on using the license manager when you move the mouse over one of the options.

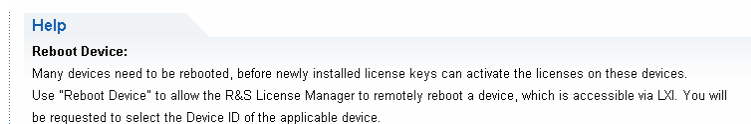

In case you already have one or more R&S ZVH equipped with options, you can manage the licenses of these options on the license manager web page.

- ▶ Press the **Manage Licenses** button.

The browser will access another part of the R&S License Manager. In this part of the license manager you can manage licenses already installed on your R&S ZVH.

This page features two areas.

- The first area provides functionality to manage licenses already installed on a device.



- Register Licenses

Follow this link if you have purchased an unregistered license. Unregistered licenses only work in combination with a specific device ID.

- Unregister License

Follow this link if you have installed a portable license. Portable licenses work in combination with several device IDs. However, you have to unregister it on one device before you can use it on another.

- Move Portable License

Follow this link if you want to move a portable license. Moving a portable license is possible without unregistering the license.

- 

Opens a detailed online help to the corresponding topic.

- The second area provides hints on using the R&S License Manager when you move the mouse over one of the options.

After you have followed one of the links, follow the instructions displayed in the browser. If you encounter any problems during the licensing procedure, you can access the online help at any time with the  icon. The online help contains an extensive description of all functionality that the license manager features.

1.6 Configuring the R&S ZVH

In the "Instrument Setup" dialog box, the R&S ZVH provides various general settings that are independent of the operating mode of the R&S ZVH.

- ▶ Press the SETUP key.
- ▶ Press the "Instrument Setup" softkey.
The R&S ZVH opens the corresponding dialog box.
- ▶ Select the item you want to modify with the rotary knob or the cursor keys.

Contents

- [Configuring the Hardware](#) (p. 32)
- [Configuring Antennas](#) (p. 34)
- [Using the GPS Receiver](#) (p. 35)
- [Configuring Date and Time](#) (p. 37)
- [Selecting Regional Attributes](#) (p. 38)
- [Configuring the Display](#) (p. 40)
- [Configuring Audio Output](#) (p. 41)
- [Configuring Power Supply](#) (p. 42)
- [Self Alignment](#) (p. 43)
- [Using a PIN Code](#) (p. 43)
- [Resetting the R&S ZVH](#) (p. 44)

1.6.1 Configuring the Hardware

The hardware settings contain settings that control internal and connected hardware.

Hardware	
Auto Accessory Detection	Off
Detected Accessory	
BNC 1	Trigger Input
BNC 2	IF Out
Internal DC Bias	Off
Internal DC Bias Level (Volt)	12V

Using auto accessory detection

If you are using any accessories while working with the R&S ZVH, the R&S ZVH is able to identify the connected hardware.

- ▶ In the "Instrument Setup" dialog box, select the "Auto Accessory Detection" item.
- ▶ Press the ENTER key.
- ▶ Select the accessory detection state from the dropdown menu.



- ▶ Confirm the selection with the ENTER key.

When this feature is on, the name of the connected accessory is displayed in the "Detected Accessory" field.

Configuring the BNC connectors

You can use the BNC connectors for various applications. For more information on the supported applications, see "[BNC Connectors](#)" on page 24.

- ▶ In the "Instrument Setup" dialog box, select the "BNC 1" item.
- ▶ Press the ENTER key.

A dropdown menu to select the BNC connector application opens.



The following applications are available:

- Trigger input
 - Reference signal input
 - DC Bias Port 1 and Port 2
- ▶ Select the required application.
 - ▶ Confirm the selection with the ENTER key.

The way to configure the second BNC connector is similar.

- ▶ Instead of selecting the "BNC 1" item, select the "BNC 2" item.



The following applications are available:

- IF output
- DC Bias Port 1 and Port 2

Configuring the internal DC bias

For both ports, you can also activate an internal DC bias.

- ▶ In the "Instrument Setup" dialog box, select the "Internal DC Bias" item.
- ▶ Press the ENTER key.

A dropdown menu to turn the internal DC bias on and off opens.



- ▶ Select the port for the internal DC bias.
- ▶ Confirm the selection with the ENTER key.

The voltage range is from 12 V to 32 V in 1 V steps.

- ▶ In the "Instrument Setup" dialog box, select the "Internal DC Bias Level (Volt)" item.
- ▶ Press the ENTER key.



- ▶ Set the internal DC bias level you need. The unit is Volt.

NOTICE

Risk of damage to the DUT

Be careful when using the DC bias as it may damage the DUT.

1.6.2 Configuring Antennas

You can use the log-periodic antenna R&S HL300 (order no. 4097.3005.02) or the active directional antenna R&S HE300 with the R&S ZVH.

For a comprehensive description of the antennas and their functionality, refer to the user manuals delivered with the product.

1.6.3 Using the GPS Receiver

The R&S ZVH can locate your exact position if you equip it with the R&S HS-Z240 GPS receiver (order no. 1309.6700.02).

- The GPS receiver has to be connected to the AUX port.



GPS reference frequency

Note that the reference frequency is automatically adjusted as soon as the GPS receiver is enabled and a fix connection with enough satellites is established.

The "Instrument Setup" dialog box provides all settings necessary to configure the GPS receiver.

GPS	
GPS	Enabled
Show GPS Information	Enabled
Coordinate Format	ddd° mm' ss.sss"
GPS Receiver Connected	Yes
Position Fix	Invalid
Number of Tracked Satellites	0
Signal Quality	Insufficient

In addition, the R&S ZVH shows some information about the GPS connection like the number of tracked satellites or the signal quality.

Enabling the GPS receiver

- ▶ In the "Instrument Setup" dialog box, select the "GPS Function" item.
- ▶ Press the ENTER key.

A dropdown menu to turn the GPS receiver on and off opens.



- ▶ Turn the GPS receiver on or off as required.
- ▶ Confirm the selection with the ENTER key.

When this feature is on, the R&S ZVH is ready to receive GPS data.

Displaying GPS information

- ▶ In the "Instrument Setup" dialog box, select the "Show GPS Information" item.
- ▶ Press the ENTER key.

A dropdown menu to turn the display of the GPS coordinates on and off opens.



- ▶ Turn the display of GPS coordinates on or off as required.
- ▶ Confirm the selection with the ENTER key.

When this feature is on, and a sufficient connection to GPS satellites is established, the R&S ZVH displays the GPS coordinates in a blue bar below the hardware information.

When the connection to a satellite is lost, the bar turns red and the GPS coordinates are shown in brackets. However, the R&S ZVH still shows the last valid position.

The state of the satellite lock is shown in the title bar.

GPS in the title bar indicates that the GPS receiver is enabled and that there is a fix connection with enough satellites for the GPS receiver to provide the coordinates. The GPS information bar is blue.



[GPS] in the title bar indicates that the GPS receiver is enabled but that there is no fix connection to a satellite. The GPS information bar is red. The coordinates are not updated.



[GPS] in the title bar indicates that the GPS receiver is enabled, but that the receiver is not connected, not connected properly or defective. The GPS information bar is red. The coordinates are not updated.

The title bar shows no symbol, if the GPS receiver is not enabled.

If the GPS receiver is connected and enabled when you boot the R&S ZVH, it asks whether to restore the GPS coordinates that were active just before it was shut down.

Selecting the coordinate format

- ▶ In the "Instrument Setup" dialog box, select the "Coordinate Format" item.
- ▶ Press the ENTER key.

A dropdown menu to select the coordinate format opens.



- ▶ Select the format you are most comfortable with from the dropdown menu.
- ▶ Confirm the selection with the ENTER key.

1.6.4 Configuring Date and Time

The R&S ZVH has an internal clock that can apply a date and time stamp. In the "Instrument Setup" dialog box, you can set both date and time.

Date and Time	
Set Date	19/01/2012
Set Time	10:52:54
Time Zone	-01:00

Setting the date

- ▶ In the "Instrument Setup" dialog box, select the "Set Date" item.
- ▶ Press the ENTER key.

The R&S ZVH asks you to confirm a change of the date.

! Warning !
Are you sure you want to change the 'Date' and not the 'Date Format'?
Press YES to continue, press NO to cancel

- ▶ Enter the date you want with the numeric keys. The sequence depends on the selected date format.

Set Date	14/08/2010
----------	------------

- ▶ Confirm the entry with the ENTER key.

Setting the time

- ▶ In the "Instrument Setup" dialog box, select the "Set Time" item.
- ▶ Press the ENTER key.
- ▶ Enter the time you want with the numeric keys.

Set Time	16:12:51
----------	----------

- ▶ Confirm the entry with the ENTER key.

After you have entered the time, the R&S ZVH verifies the validity of the time. If it is not a valid time, it sets the next valid time.

Selecting the time zone

- ▶ In the "Instrument Setup" dialog box, select the "Time Zone" item.
- ▶ Press the ENTER key.
- ▶ Enter a positive or negative time offset relative to the system time with the numeric keys.

Time Zone	+01:00
-----------	--------

- ▶ Confirm the entry with the ENTER key.

After you have confirmed the time zone, the R&S ZVH adjusts the displayed time accordingly, without changing the system time.

1.6.5 Selecting Regional Attributes

The regional settings allow you to select a different language, date format and length unit.

Regional	
Language	English
Date Format	dd/mm/yyyy
Length Unit	meter

Selecting the language

The R&S ZVH provides several languages for the user interface.

- ▶ In the "Instrument Setup" dialog box, select the "Language" item.
- ▶ Press the ENTER key.

A dropdown menu opens to select the language.



- ▶ Select one of the languages from the dropdown menu.
- ▶ Confirm the selection with the ENTER key.

Setting the date format

The R&S ZVH provides several formats to display the date as.

- ▶ In the "Instrument Setup" dialog box, select the "Date Format" item.
- ▶ Press the ENTER key.

A dropdown menu opens to select the date format.



- ▶ Select the date format you are most comfortable with from the dropdown menu.
- ▶ Confirm the selection with the ENTER key.

Setting the length unit

- ▶ In the "Instrument Setup" dialog box, select the "Length Unit" item.
- ▶ Press the ENTER key.

A dropdown menu opens to select the length unit.



- ▶ Select the length unit you are most comfortable with from the dropdown menu.
- ▶ Confirm the selection with the ENTER key.

1.6.6 Configuring the Display

The display settings configure display characteristics.

Display	
Display Backlight	50 %
Display Color Scheme	Color

The display of the R&S ZVH is a TFT color LCD display.

Indoors, its ideal brightness depends on the intensity of the backlight. To strike a balance between battery operating time and screen display quality, set the backlight intensity to the minimum brightness needed.

To optimize the viewing angle, adjust the color settings. To achieve maximum contrast, the screen can be switched from color display to black-and-white display.

Under extreme light conditions, it can be of advantage to select the high-contrast monochrome display.

Adjusting the display backlight

- ▶ In the "Instrument Setup" dialog box, select the "Display Backlight" item.
- ▶ Press the ENTER key.
- ▶ Enter the backlight intensity you want with the numeric keys.



The backlight intensity is a percentage from 0% to 100% with 100% being the brightest.

- ▶ Confirm the entry with the ENTER key.

Selecting the display color scheme

- ▶ In the "Instrument Setup" dialog box, select the "Display Color Scheme" item.
- ▶ Press the ENTER key.

A dropdown menu opens to select the color scheme.



- ▶ Select the color scheme you want.
 - "Color" selects a color display.
 - "Black & White" selects monochrome display.
 - "Printer Friendly" inverts the colors.
- ▶ Confirm the selection with the ENTER key.

1.6.7 Configuring Audio Output

The audio settings control the audio output of the system.

Audio	
Key Click Volume	0 %
System Beeper Volume	30 %
Beeper on Power Overload	Off

Setting the key click volume

The key click volume sets the volume of the sound that the R&S ZVH produces when you press a key or softkey.

- ▶ In the "Instrument Setup" dialog box, select the "Key Click Volume" item.
- ▶ Press the ENTER key.
- ▶ Enter the volume you want with the numeric keys.



The key click volume is a percentage from 0% to 100% with 100% being the loudest.

- ▶ Confirm the entry with the ENTER key.

Setting the system beeper volume

The system beeper volume sets the volume of the system beeper of the R&S ZVH, used for example if a message box pops up.

- ▶ In the "Instrument Setup" dialog box, select the "System Beeper Volume" item.
- ▶ Press the ENTER key.
- ▶ Enter the volume you want with the numeric keys.



The system beeper volume is a percentage from 0% to 100% with 100% being the loudest.

- ▶ Confirm the entry with the ENTER key.

Turning audio output in case of a power overload on and off

In case the R&S ZVH detects an overload at one of its inputs, you can configure it to make a sound.

- ▶ In the "Instrument Setup" dialog box, select the "Beeper on Power Overload" item.
- ▶ Press the ENTER key.



- ▶ Turn the beeper on or off.

When this feature is on, the R&S ZVH will make a sound every time it detects an overload.

- ▶ Confirm the entry with the ENTER key.

1.6.8 Configuring Power Supply

The power settings contain settings that configure the power supply of the R&S ZVH. The "Current Power Source" shows the source the R&S ZVH is currently powered by. When you are using the battery to supply the R&S ZVH with power, the remaining "Battery Level" is displayed as a percentage, with 100 % representing a full charge.

Power	
Current Power Source	Battery
Battery Level	59 %
Battery Low Level	20 %
Battery Low Level Beep	Off

Setting the battery low level

The battery low level is a reminder that the remaining battery charge might be used up soon.

When the battery low level is reached, the battery symbol in the title bar turns red and starts blinking.

- ▶ In the "Instrument Setup" dialog box, select the "Battery Low Level" item.
- ▶ Press the ENTER key.
- ▶ Enter the charge level in percent of a fully charged battery with the numeric keys.



- ▶ Confirm the entry with the ENTER key.

Turning audio output in case of battery low level state on and off

The R&S ZVH also allows you to turn on an audio signal that indicates that the battery has reached its low level state.

- ▶ In the "Instrument Setup" dialog box, select the "Battery Low Level Beep" item.
- ▶ Press the ENTER key.



- ▶ Select either "Repetitive" or "Once" to turn the audio signal on.

If you have selected "Once", the R&S ZVH will beep once if the battery runs out of power. For a continuous beep, select "Repetitive".

- ▶ Select "Off" to turn off the beeper.

1.6.9 Self Alignment

The self alignment calibrates the instrument settings for vector network analysis. During the self alignment, the R&S ZVH generates new factory calibration data and overwrites the old factory calibration.

For the self alignment a short circuit (Short), an open circuit (Open) and a 50 Ohm match (Load) are required. In addition, a through connection must be established with an appropriate cable.

When you are in Cable and Antenna Analyzer mode or Network Analyzer mode, the "Calibration Kit" item becomes available and you can select the calibration kit that you want to use for the self alignment.

- ▶ In the "Instrument Setup" dialog box, select the "Calibration Kit" item.
The R&S ZVH opens a dialog box to select a calibration kit.
- ▶ Select the required calibration kit.

Performing self alignment

- ▶ In the "Instrument Setup" dialog box, select the "Self Alignment" item.



- ▶ Press the ENTER key.

The R&S ZVH initiates the self alignment procedure and shows a warning message box.

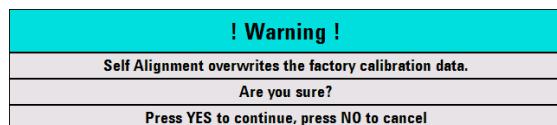

Selecting "Yes" initiates the self alignment procedure. Follow the instructions shown on the screen.

Selecting "No" cancels the self alignment procedure.

1.6.10 Using a PIN Code

The R&S ZVH features a PIN protection system with several security levels that protects the R&S ZVH from unauthorized access. When PIN protection is on, you have to enter the PIN whenever you turn the R&S ZVH on.

For more information, please refer to the Operating Manual.

1.6.11 Resetting the R&S ZVH

You can either preset the R&S ZVH or reset it to factory settings.

Presetting the R&S ZVH

The PRESET key resets the R&S ZVH to the default setup of the currently active operating mode.

This allows you to define a new configuration based on defined measurement parameters without parameters from a previous measurement unintentionally still being active.

- ▶ Press the PRESET key.

Resetting the R&S ZVH

A "Reset to Factory Settings" resets the R&S ZVH to the factory defaults.

During a reset, the R&S ZVH restores the original configuration. It also deletes all customized datasets (limit lines, standards, channel tables, cable models etc.). Instead, it will reinstall all the datasets that have been available after delivery.

NOTICE

Risk of data loss

All datasets you have saved will be deleted during a factory reset.

- ▶ In the "Instrument Setup" dialog box, select the "Reset to Factory Settings" item.



- ▶ Press the ENTER key.

The R&S ZVH initiates the reset procedure and shows a warning message box.

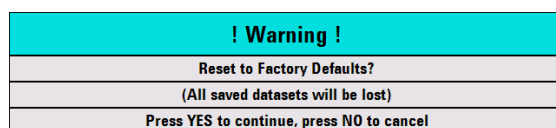

Selecting "Yes" performs the reset. During the reboot, it shows a corresponding message.

Selecting "No" cancels the reset.

1.7 Connecting the R&S ZVH to a PC

The R&S ZVH comes with the R&S ZVHView software package. This software package features several tools that allow you to document measurement results or create and edit limit lines or channel tables among other things.

Note that the .NET Framework 2.0 (or higher) is required on the PC to run the software properly.

You can set up a connection between the R&S ZVH and R&S ZVHView either via its LAN port or its mini USB port.

You have to install the R&S ZVHView software on the PC before you are able to establish a connection.

- ▶ Run the CD-ROM delivered with the R&S ZVH.
- ▶ Navigate to the "Software" section and start the setup file.
- ▶ Follow the instructions on the screen.

Alternatively, you can download the latest R&S ZVHView from the R&S ZVH product homepage.



Firewall settings

If no connection can be established between the software and the R&S ZVH after successful configuration, check the firewall settings on your PC.

1.7.1 Connecting the R&S ZVH in a LAN

You can connect the R&S ZVH directly to the PC with the LAN cable that is supplied with the R&S ZVH. The LAN port is located on the left side of the R&S ZVH behind a protective cap. For more information see "[Mini USB and LAN Ports](#)" on page 26.

You can set up the LAN connection in the "Instrument Settings" dialog box.

LAN Port	
MAC Address	00-90-b8-18-81-aa
DHCP	Off
IP Address	10.114.10.1
Subnet Mask	255.255.255.0
Gateway	0.0.0.0

For a direct connection between a PC and the R&S ZVH, DHCP (Dynamic Host Configuration Protocol) has to be turned off (which is the default state).

- ▶ In the "Instrument Setup" dialog box, select the "DHCP" item.
- ▶ Press the ENTER key.

A dropdown menu to select the DHCP state opens.



- ▶ Turn DHCP on or off as required.

Setting an IP address and subnet mask

To establish a connection, the PC and the R&S ZVH have to be in the same subnet.

- ▶ Identify the subnet mask of your PC, for example in the Microsoft Windows "TCP/IP Properties".

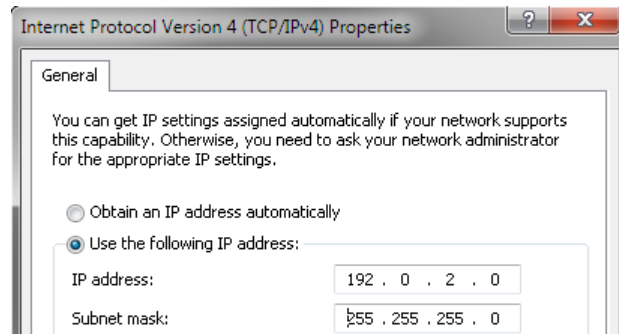

- ▶ In the "Instrument Setup" dialog box, select the "Subnet Mask" item.
- ▶ Press the ENTER key.
- ▶ Enter the subnet mask of the PC with the numeric keys.



- ▶ Confirm the entry with the ENTER key.

After you have matched the subnet mask, you can define the IP address. When both devices are in the same subnet, the first three digits of the IP address are usually the same ('192' in the example below).

Example

IP address PC	192.0.2.0
IP address R&S ZVH	192.0.2.10

- ▶ Identify the IP address of your PC, for example in the Microsoft Windows "TCP/IP Properties".

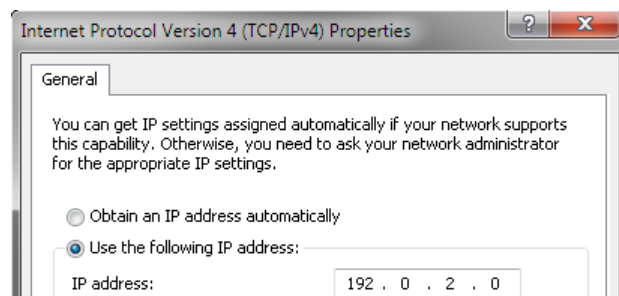

- ▶ In the "Instrument Setup" dialog box, select the "IP Address" item.
- ▶ Press the ENTER key.
- ▶ Enter the IP address of the PC with the numeric keys.



- ▶ Confirm the entry with the ENTER key.

Configuring the R&S ZVHView software

- ▶ Start R&S ZVHView.
- ▶ Select the "LAN" tab in the "Instrument Connect" dialog box.

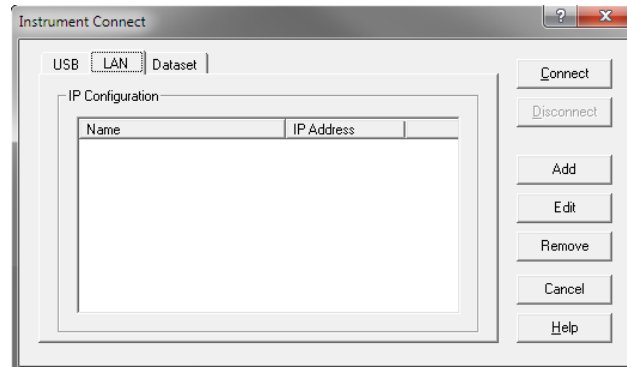

- ▶ Press the "Add" button to create a new network connection.

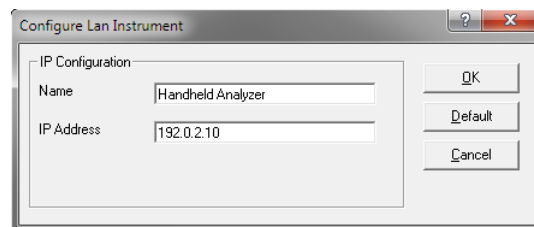

- ▶ Specify a name for the new network connection, for example R&S ZVH.
- ▶ Enter the IP address for the R&S ZVH (in this case 192.0.2.10)
- ▶ Confirm the entry with the "OK" button.

The connection is now created and configured and is added to the IP Configuration list.

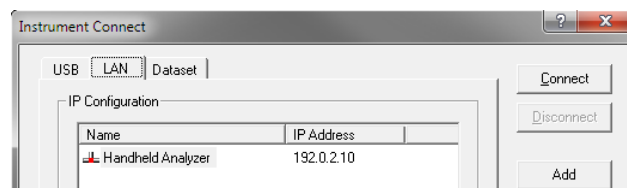

- ▶ Select the new connection labeled R&S ZVH.
- ▶ Press the Connect button to establish the connection.

1.7.2 Connecting the R&S ZVH in an existing LAN

You can either draw the R&S ZVH IP address automatically from the DHCP server or manually assign a fixed address. With manual allocation, a fixed IP address and subnet mask must be assigned to the R&S ZVH as described in the chapter on direct LAN connection. Then the R&S ZVHView software has to be configured as described with the assigned IP address.



Free IP address

Contact your IT system manager to get a free IP address.

In networks with a DHCP server, DHCP permits automatic allocation of the network configuration to the R&S ZVH connected via LAN cable. For this purpose, DHCP has to be active on the R&S ZVH.

DHCP is off by default. Turn it on like this:

- ▶ In the "Instrument Setup" dialog box, select the "DHCP" item.
- ▶ Press the ENTER key.

A dropdown menu to select the DHCP state opens.



- ▶ Select "On" to activate DHCP.

The R&S ZVH is now allocated an IP address and the subnet mask by the DHCP server. This can take several seconds.

The IP address and subnet mask are automatically set in the corresponding input fields and are no longer available for editing.

Configure the R&S ZVHView software with the IP address and subnet mask as defined by the DHCP server. For more information see ["Connecting the R&S ZVH in a LAN"](#) on page 45.

1.7.3 Connecting the R&S ZVH via USB

Alternatively, you can connect the R&S ZVH to the PC with the USB cable that is supplied with the delivery. The Mini USB interface is located on the left side of the R&S ZVH behind a protective cap. For more information see "[Mini USB and LAN Ports](#)" on page 26.

When you connect the R&S ZVH to a computer for the first time, Windows tries to install the new hardware automatically. The required drivers are installed along with the R&S ZVHView software package.

When the drivers have been found on your system and the hardware has been successfully installed, Windows shows a corresponding message.

- ▶ Connect the R&S ZVH via the Mini USB port to your computer.
- ▶ Start R&S ZVHView on the PC.
- ▶ Select the "USB" tab in the "Instrument Connect" dialog box.

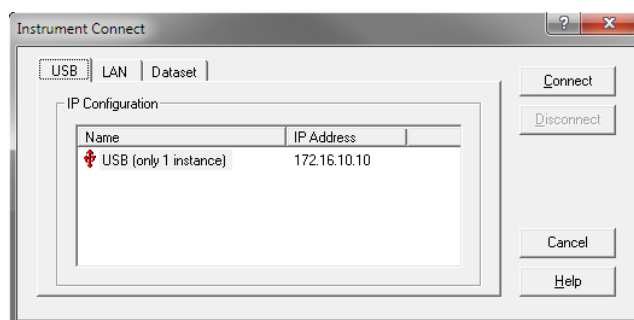

- ▶ Select the R&S ZVH connection.
- ▶ Confirm the selection with the "Connect" button.



R&S ZVH IP address

The R&S ZVH internally emulates a LAN connection. The IP address displayed by R&S ZVHView for the USB connection is for information only. It is fixed to 172.16.10.10 and cannot be changed.

2 Getting Started

This chapter provides a short overview of several basic measurements you can perform with the R&S ZVH.

Contents

- [Using the Measurement Wizard](#) (p. 51)
- [Identifying Cable Faults](#) (p. 56)
- [Measuring Transmissions \(Option R&S ZVH-K39\)](#) (p. 61)
- [Using the Spectrum Analyzer \(Option R&S ZVH-K1\)](#) (p. 63)
- [Using a Power Sensor \(Option R&S ZVH-K9\)](#) (p. 68)
- [Saving and Recalling Results and Settings](#) (p. 73)

2.1 Using the Measurement Wizard

The measurement wizard allows you to combine several individual measurement configurations to a sequence of measurements (or measurement set). Because all relevant parameters have been set prior to the actual measurement and cannot be changed once the measurement procedure has begun, the wizard is a good way to avoid mistakes and save time when setting up measurements.

This chapter describes the functionality of the measurement wizard. For a more comprehensive guide see the Operating Manual.

Note that it is necessary to install and use the R&S ZVHView software package if you want to access the measurement wizard.

2.1.1 Defining Measurement Sets

Before you can use the measurement wizard you have to define a measurement set with the R&S ZVHView software package and transfer it to the R&S ZVH.

A measurement set consists of several datasets. A dataset is a file that contains the settings of a specific R&S ZVH configuration, e.g. frequency, scaling etc.. To get hold of a dataset, set up the R&S ZVH as you need and save the configuration, or use one of the predefined datasets.

For more information on datasets see "[Saving and Recalling Results and Settings](#)" on page 73 and the operating manual.

- ▶ Start the R&S ZVHView software on your PC.
- ▶ Select the "Wizard Set Editor" with the  button.

In the dialog that opens, you can, for example,

- combine several datasets to a measurement set
 - specify instructions about the measurement procedure
 - define cable characteristics
 - define the calibration method.
- ▶ Set up the measurement set as you like by adding or removing datasets and by adding instructions for each stage of the measurement.
 - ▶ Save the measurement set. The file type of a measurement set is *.mdf.

2.1.2 Uploading Measurement Sets

In order to perform the actual measurements, you have to upload the wizard definition file that contains the set of measurements to the R&S ZVH.

- ▶ Select the "Wizard Set Control" function with the  button.

The R&S ZVH opens a dialog box to select the measurement set(s) to upload.

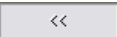
- ▶ Select the measurement set you want to upload.
- ▶ Copy the files with the  button.

The software stores a copy of the measurement set in the memory of the R&S ZVH.

Alternatively, you can use a memory stick or SD card to access a measurement set on the R&S ZVH.

2.1.3 Performing Measurements

Now that the measurement set is available on the R&S ZVH you can start to perform measurements.

- ▶ Press the WIZARD key.

The R&S ZVH opens the "Measurement Wizard" dialog box. This dialog box contains information about the measurement set, including several parameters whose values you can change during the measurement (for example the site name).

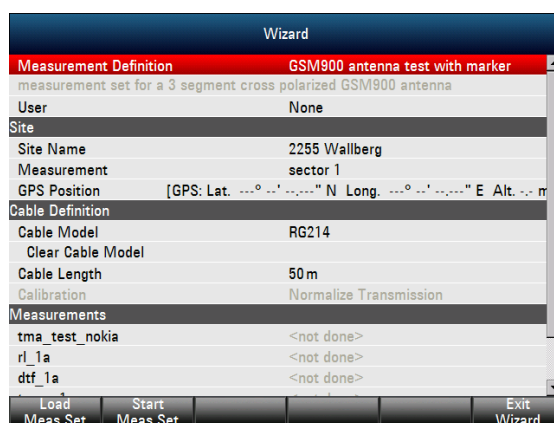

The "Measurement Wizard" dialog shows various information about the measurement set. Note that you can edit some of the parameters listed in the dialog, e.g. "User" or "Site Name".

- ▶ Press the "Load Meas Set" softkey.

The R&S ZVH opens the file manager.

- ▶ Select a measurement set.

The R&S ZVH loads the measurement set and shows its contents in the "Wizard" dialog box.

- ▶ Press the "Start Meas Set" softkey.

The R&S ZVH starts the measurement procedure by showing the instructions for the first measurement.

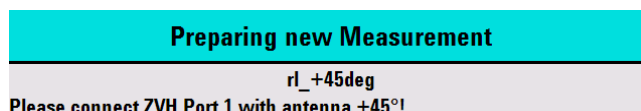

The contents of the message box are the same you have defined for each measurement with R&S ZVHView.

- ▶ Follow the instructions shown in the message box.
- ▶ Press the "Confirm" softkey to confirm the successful preparation.

The R&S ZVH performs the measurement as defined in the dataset and measurement set. When finished, it shows the measurement results and says

Measurement Done .

Note that it is not possible to change any measurement parameters while using the measurement wizard. Marker functionality, scaling parameters and (if configured that way) cable settings are, however, available.

Now that you have the results of the measurement, you have several options:

- continue with the next measurement in the set
- repeat the current measurement
- interrupt the measurement set sequence
- skip a measurement
- end the measurement sequence
- abort the measurement sequence

When you have finished all measurements that are part of the measurement set, the R&S ZVH asks you if you want to save the measurement results.

- ▶ Press the "Save Meas Results" softkey.

The R&S ZVH saves the results on the selected storage device.

The results for a measurement set consist of a number of files, each file corresponding to one of the performed measurements. For easy evaluation, the R&S ZVH includes the name of the measurement as defined in the wizard dialog or R&S ZVHView in the file name.

All result files that belong to a measurement set are stored in the same directory. The directory is named after the measurement name and site. The syntax is 'sitename_measurement_#'.

2.1.4 Evaluating the Results

The R&S ZVHView software provides functionality to evaluate results and compile measurement reports. However, before you can start to evaluate the results you have to download the results to your computer.

- ▶ Select the "Wizard Result Control" function with the  button.

The R&S ZVH opens a dialog box to select the measurement set(s) to download.

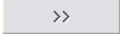
- ▶ Select the measurement set you want to download.
- ▶ Copy the files with the  button.

Now that the results are available, you can start to compile a measurement report with the R&S ZVHView.

- ▶ Select the "Report Generator" with the  button.

The R&S ZVH opens a dialog that provides all functionality to manage measurement sets.

2.2 Identifying Cable Faults

One of the basic measurement tasks for the R&S ZVH is to find cable faults with the distance-to-fault measurement.

Test setup

The test setup requires an R&S ZVH, an RF cable (for example R&S FSH-Z320) and a calibration standard (for example R&S FSH-Z28 or R&S FSH-Z29).

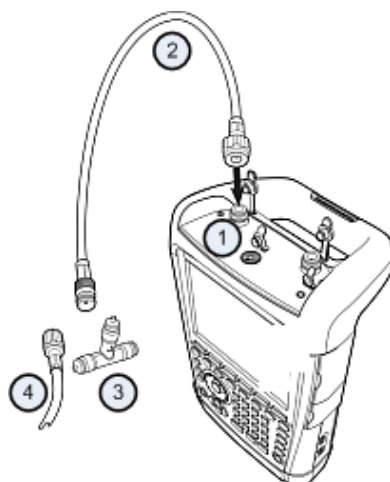

- | | |
|---|----------------------|
| 1 | RF input (port 1) |
| 2 | RF cable |
| 3 | Calibration standard |
| 4 | Test cable (DUT) |

- ▶ For measurements on DUTs that require an external voltage supply (for example power amplifiers), connect the supply voltage from a suitable AC power supply to the BIAS PORT 1 input.
- ▶ Connect the RF test cable to the RF input of the R&S ZVH.



You should use the RF cable. Otherwise, measurement results may be invalid.

Starting the measurement

- ▶ Press the MODE key.
- ▶ Press the "Antenna & Cable Test" softkey.

By default, the R&S ZVH shows the magnitude of the reflection (S11). You can also measure the distance to fault, the transmission or the cable loss.

- ▶ Press the MEAS key.
- ▶ Press the "Distance-to-Fault" softkey.

The R&S ZVH starts the distance-to-fault measurement.

Setting the frequency and bandwidth

To get the best results, you should adjust the center frequency to that of the DUT and set the measurement bandwidth.

- ▶ Press the **FREQ/DIST** key.
- ▶ Press the **"DTF Center Freq"** softkey.
- ▶ Enter the center frequency you need (for example that of the antenna at the other end of the cable) with the numeric keys.
- ▶ Press the **SWEEP/BW** key.
- ▶ Press the **"Manual Meas BW"** softkey.
- ▶ Enter 100 kHz as the measurement bandwidth.

Specifying the cable model

To perform cable tests, you have to specify the type of the cable and its approximate length.

- ▶ Press the **MEAS** key.
- ▶ Press the **"Cable Config"** softkey.
- ▶ Select the **"Select Cable Model..."** item.

The R&S ZVH opens a dialog box to select the cable model.



- ▶ Select the cable model that you need from the list of cables.
- ▶ Confirm the selection with the **"Select"** softkey.

The currently active cable model is always shown in the display header.

You can also define new cable models on the R&S ZVH or with the R&S ZVHView software and then transfer them to the R&S ZVH. For more information see the operating manual.

In addition to the cable model, you should also specify the maximum distance to the cable end.

- ▶ Press the **FREQ/DIST** key.
- ▶ Press the "Stop Dist" softkey.
- ▶ Enter the maximum distance of the cable you are testing.

The range is from 3 m (10 ft) to 1500 m (4921 ft). The unit depends on the regional settings. It is either meter or feet. For more information see "[Selecting Regional Attributes](#)" on page 38.

The R&S ZVH uses the cable length to determine the ideal span for the measurement and to scale the horizontal axis. For best results, the cable should be specified 20% to 50% longer than the actual cable length.

Calibrating the test setup

Before connecting the cable, you should calibrate the R&S ZVH to get the best measurement results.

The R&S ZVH provides several calibration methods for cable measurements. For more information on the methods refer to the operating manual.

- ▶ Press the **CAL** key.

The R&S ZVH opens a menu that contains all available calibration methods.

- ▶ Press the "Full 1-Port" softkey.

The R&S ZVH asks you to connect a "Short", an "Open" and a "Load" to the measurement cable.

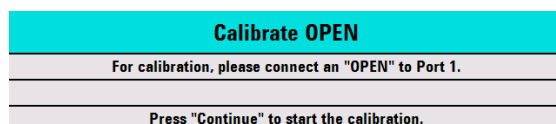

- ▶ Firmly connect the short, the open and the load to the output end of the cable.
- ▶ After each step, proceed with the "Continue" softkey.

After the calibration, the R&S ZVH shows that it is calibrated by displaying (CAL).

- ▶ Screw the cable under test back to the measurement cable.



In CAT mode, the R&S ZVH performs calibration over its entire span. It is thus not necessary to perform a new calibration after changing the frequency range or cable length.

The R&S ZVH stores the calibration data in its memory. Thus, the calibration is valid after you change the operating mode or after you turn off the R&S ZVH.

The R&S ZVH now shows the cable characteristics over the cable's entire length. With a marker, you can easily detect the distance to the cable fault.

In addition to the distance to fault measurement, the R&S ZVH also features a cable spectrum measurement and a reflection measurement, for example to test impedance matching.

Using markers

The R&S ZVH has markers to read out signal levels and frequencies. Markers are always positioned on the trace. Both the level and frequency at their current positions are displayed on the screen.

- ▶ Press the MARKER key.

The R&S ZVH activates a marker and puts it on the maximum value on the trace.



A blue vertical line represents the position of the marker on the horizontal axis (e.g. the frequency).

A small blue horizontal dash represents the marker position on the vertical axis (e.g. the level).

The R&S ZVH shows the coordinates of all markers in a table above the diagram.

Selecting the measurement format

By default, the R&S ZVH shows the magnitude of the cable fault.

For some result displays, you can also select other measurement formats.

- ▶ Press the FORMAT/SPAN key.
- ▶ Press the softkey labelled with the measurement format you want to see.

Measuring the cable loss

In addition to the distance to the cable fault, you might also be interested in the loss that the cable has over a particular frequency span.

- ▶ Press the MEAS key.
- ▶ Press the "Cable Loss" softkey.

The R&S ZVH now shows how much power is lost for a particular frequency span.

Using markers, you can determine the magnitude of the cable loss for any particular frequency.



2.3 Measuring Transmissions (Option R&S ZVH-K39)

With option R&S ZVH-K39 (order no. 1309.6830.02) you can perform transmission measurements (S12).

This measurement example measures the transmission characteristics of a highpass filter.

Test setup

To measure the transmission, connect the input of the filter to the generator output and the output of the filter to the RF input.

Setting the frequency span

Before calibrating the R&S ZVH, you should define the frequency range of the filter.

- ▶ Press the **FREQ/DIST** key.
- ▶ Press the **"Start"** softkey.
- ▶ Enter 10 MHz as the start frequency.
- ▶ Press the **"Stop"** softkey.
- ▶ Enter 100 MHz as the stop frequency.

Calibrating the measurement

For transmission measurements you have to perform a full 2-port calibration to get the best results.

- ▶ Press the **CAL** key.
- ▶ Press the **"Full 2-Port"** softkey.

The R&S ZVH asks you to connect an "Open", a "Short" and a "Load" to port 1.

- ▶ Firmly connect the open, the short and the load to the output end of the cable.
- ▶ After each step, proceed with the **"Continue"** softkey.

After port 1 has been calibrated, the R&S ZVH asks you to connect a "Through" to both ports.

- ▶ Firmly connect the through to both ports of the R&S ZVH.
- ▶ Proceed with the **"Continue"** softkey.

After the calibration, the R&S ZVH shows that it is calibrated by displaying (CAL).

- ▶ Reconnect the filter to the ports of the R&S ZVH.

The R&S ZVH now shows the (corrected) characteristics of the highpass filter.

Measuring Transmissions (Option R&S ZVH-K39)

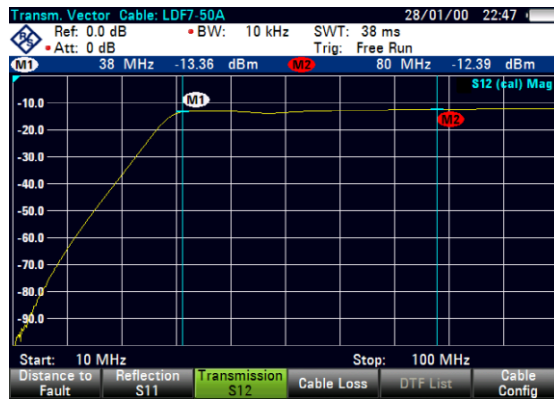

2.4 Using the Spectrum Analyzer (Option R&S ZVH-K1)

Equipped with option R&S ZVH-K1 (order no. 1309.6823.02), the R&S ZVH is able to perform spectrum measurements.

- ▶ Press the MODE key.
- ▶ Press the "Spectrum Analyzer" softkey.

The R&S ZVH turns on spectrum analyzer mode.

2.4.1 Attenuating the Signal

You can attenuate the signal to a suitable level either manually or automatically.

In case of automatic attenuation, the level of attenuation at the RF input depends on the current reference level. The R&S ZVH provides two ways of automatic attenuation.

For the highest possible sensitivity it provides the "Auto Low Noise" attenuation mode. For the lowest possible intermodulation, it provides the "Auto Low Distortion" mode.

The main difference between the two modes is that the attenuation level is 5 to 10 dB higher in case of "Auto Low Distortion" than it is for "Auto Low Noise". In the default state, "Auto Low Distortion" is active.

- ▶ Press the SCALE/AMPT key.
- ▶ Press the "RF Att/Amp/Imp" softkey.
- ▶ Select either the "Auto Low Noise" or "Auto Low Distortion" menu item.

The R&S ZVH shows the current attenuation level in the hardware settings overview ("Att.:" caption). The currently active menu item has a green background.

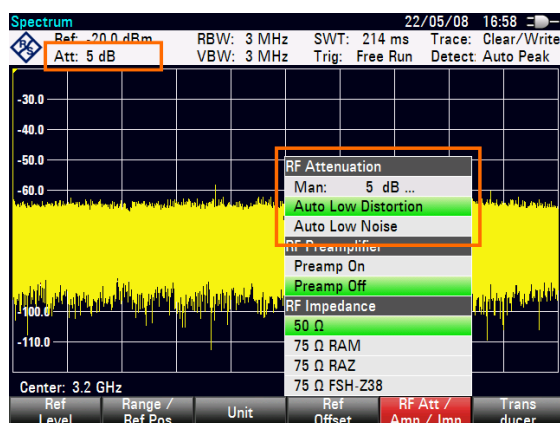

You can also set the attenuation manually. The R&S ZVH provides attenuation in the range from 0 to 40 dB in 5 dB steps.

- ▶ Press the SCALE/AMPT key.
- ▶ Press the "RF Att/Amp/Imp" softkey.
- ▶ Select either the "Man: 0 dB" menu item.

The R&S ZVH opens an input field to define the attenuation.

The R&S ZVH provides several methods to fill in input fields:

- directly with the number keys
- with the rotary knob
- with the cursor keys

While you can enter any number you want with the number keys, using the rotary knob or the cursor keys is coupled to a certain step size in most cases.

If you use the rotary knob to change the attenuation, for example, the step size is 5 dB.

- ▶ Enter the attenuation you need.

Again, the R&S ZVH shows the current attenuation level in the hardware settings overview ("Att.:" caption).

2.4.2 Using the Preamplifier

The R&S ZVH has an internal preamplifier to increase sensitivity. Depending on the frequency, the gain of the amplifier is in the range from 15 to 20 dB and increases the sensitivity by 10 to 15 dB.

In the signal path, the preamplifier comes after the RF attenuator and before the input mixer.

- ▶ Press the SCALE/AMPT key.
- ▶ Press the "RF Att/Amp/Imp" softkey.
- ▶ Select either the "Preamp On" or "Preamp Off" menu item.

The R&S ZVH turns the preamplifier on or off.

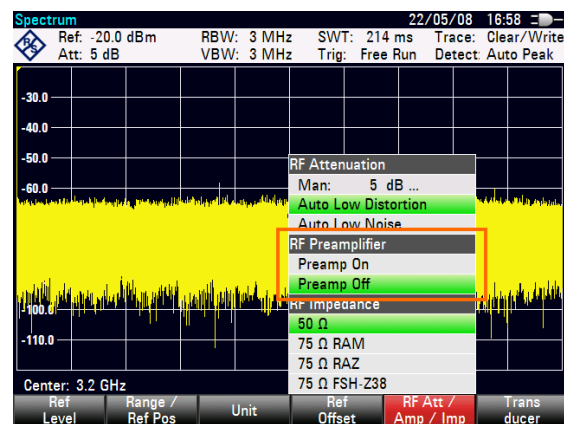

The magnitude of amplification depends on the reference level. This coupling to the reference level makes sure that the dynamic range is at an optimum.

2.4.3 Measuring CW Signals

A basic task for spectrum analyzers is to measure the level and frequency of sinewave signals. The following examples illustrate an effective way of performing these measurements.

A signal generator, e.g. R&S SMBV provides the signal source.

Test setup

Connect the RF output of the signal generator to the RF input of the R&S ZVH.

Signal generator settings:

Frequency: 700 MHz

Level: -30 dBm

Measuring the level

- ▶ Press the PRESET key.

The R&S ZVH is reset to its default state.

After the preset, the R&S ZVH displays the frequency spectrum over its full frequency span. At 700 MHz, the generator signal is displayed as a vertical line.

To analyze the generator signal at 700 MHz in more detail, reduce the frequency span.

- ▶ Press the FREQ/DIST key.

The R&S ZVH opens an input field to enter the center frequency.

- ▶ Enter a center frequency of 700 MHz.

The signal is now in the center of the display.

- ▶ Press the FORMAT/SPAN key.

The R&S ZVH opens an input field to specify the span.

- ▶ Enter a span of 10 MHz.

The R&S ZVH now displays the generator signal with a higher resolution.

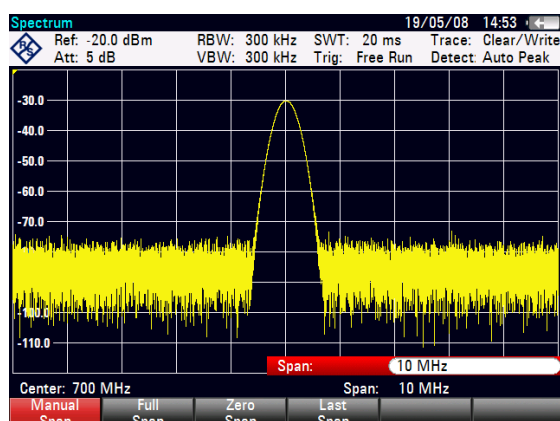

Setting the reference level

The level at the top of the measurement diagram is called the reference level. To obtain the best dynamic range from the R&S ZVH, you should use its full level range. That means that the maximum level value should be at or close to the top of the measurement diagram (= reference level).

- ▶ Press the SCALE/AMPT key.
- ▶ Press the "Ref Level" softkey.
- ▶ Enter a reference level of -30 dBm.

The R&S ZVH reduces the reference level by 10 dB.

The maximum trace value is close to the maximum scale value of the measurement diagram. The increase in the displayed noise floor is minimal. The difference between the signal maximum and the displayed noise (i.e. the dynamic range) has, however, been increased.

Measuring the frequency

The trace consists of 631 measurement points (frequency points). The marker is always positioned on one of these measurement points. The R&S ZVH calculates the marker frequency from the frequency of the measurement point, the center frequency and the frequency span that have been set. The measurement-point resolution, and consequently the accuracy of the marker frequency readout, therefore depend on the frequency span that has been selected.

The R&S ZVH has a frequency counter to increase the accuracy of the marker-frequency readout. It stops the sweep at the marker position, counts the frequency and then continues the sweep.

- ▶ Press the MARKER key.
- ▶ Press the "Marker Function" softkey.
- ▶ Select the "Frequency Count" menu item.

The marker label "M" turns to a "C" to indicate an active frequency counter. When the frequency counter is active, the resolution of the frequency readout is always 1 Hz, regardless of the span. The accuracy is determined by the internal reference frequency which is far more exact than that of the pixel-oriented marker readout.

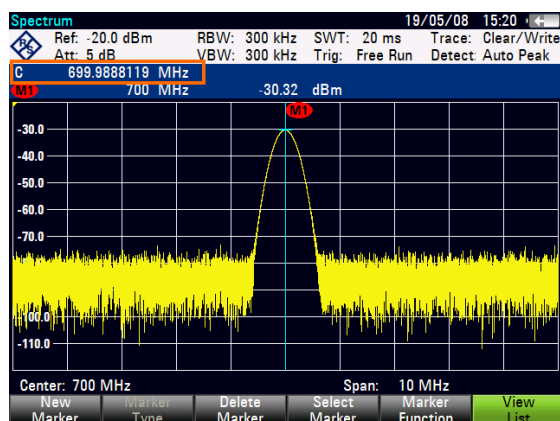

2.5 Using a Power Sensor (Option R&S ZVH-K9)

For highly accurate power measurements, you can connect one of the power sensors that are supported by the R&S ZVH.

The power sensors R&S ZVH-Z1 and -Z18 are especially designed for use with the R&S ZVH.

You can connect the power sensors available for the R&S ZVH to the RS-232-C interface on the top face of the R&S ZVH. This connector allows you to control the power sensor and supplies it with power.

It is also possible to use one of the R&S NRP power sensors. When you use one of these, connect it to the USB interface on the right side of the R&S ZVH.

2.5.1 Measuring the Power with a Power Sensor

The power sensors R&S FSH-Z1 and R&S FSH-Z18 measure the power in the range from 10 MHz to 8 GHz and 18 GHz respectively.

For more information about the characteristics of the R&S NRP power sensors, refer to their datasheets.

NOTICE

Risk of damaging the power sensor

Because of high input power,

- the continuous power applied to the power sensor's input must not exceed 400 mW (26 dBm)
- use an attenuator for measurements on highpower transmitters

However, brief power peaks $\leq 10 \mu\text{s}$ up to 1 W (30 dBm) are permissible.

Test setup

Connect the cable of the power sensor to the power sensor jack of the R&S ZVH.

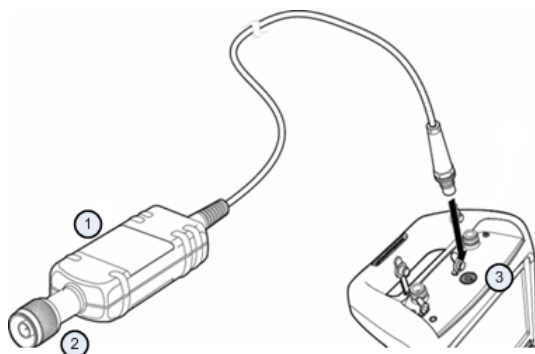

- 1 Power sensor R&S FSH-Z1 or R&S FSH-Z18
- 2 Power sensor connector (DUT)
- 3 Power sensor jack

Measuring the power

- ▶ Press the MODE key.
- ▶ Press the "Power Meter" softkey.

The R&S ZVH switches its operating mode.

If the R&S ZVH recognizes a power sensor, it sets up a connection via the interface and after a few seconds shows the measured power.

If no power sensor has been connected or is not connected appropriately, the R&S ZVH shows nothing.

If there are communication problems between the R&S ZVH and the power sensor, the R&S ZVH displays an error message that indicates a possible cause. For more information see the operating manual.

Zeroing the power sensor

To compensate internal offsets of the power meter, it needs to be compensated for before starting the measurement.

- ▶ Press the "Zero" softkey.

The R&S ZVH asks you not to apply any signals to the power sensor while zeroing is active.

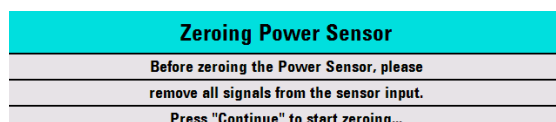

- ▶ Disconnect the power sensor from any signal sources.
- ▶ Press the "Continue" softkey to start zeroing.

The R&S ZVH starts the zeroing process. It asks you to wait until it is finished.

After zeroing is done, the R&S ZVH outputs the message "Power Sensor Zero OK" and again shows the power sensor softkey menu.

- ▶ Connect the signal under test to the power sensor.

The R&S ZVH shows the measured power level in dBm.

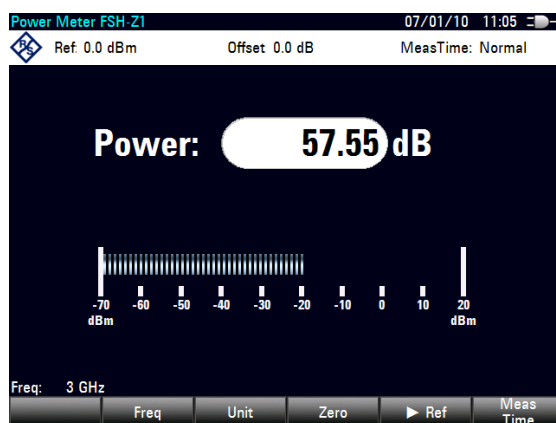

Entering the frequency

To get the best results, also enter the frequency of the signal under test.

- ▶ Press the "Freq" softkey.
- ▶ Enter the frequency of the signal.
- ▶ Confirm the entry with one of the unit keys.

The R&S ZVH transfers the new frequency to the power sensor which then corrects the measured power readings.

2.5.2 Measuring Power and Return Loss

With the directional power sensors R&S FSH-Z14 and R&S ZVH-Z44 you can measure the power in both directions.

When you connect the directional power sensor between the source and the load, the R&S ZVH measures the power from source to load (forward power) and from load to source (reverse power).

The ratio between forward and reverse power is a measure of the load matching. The R&S ZVH displays it as the return loss or standing wave ratio.

The power sensors for the R&S ZVH have an asymmetrical design. Therefore, they have to be inserted into the test setup in such a way that the "Forward" arrow on the sensor points toward the load (= in the direction of the power flux).

When measuring high powers, pay strict attention to the following instructions to avoid personal injury and to prevent the power sensor from being destroyed.

⚠ CAUTION

Danger of skin burns and damage to the instrument

- Never exceed the permissible continuous power.
- See diagram on the rear of the sensor for the permissible continuous power.
- Turn off the RF power to connect the sensor.
- Screw the RF connectors tightly..

Test setup

Connect the cable of the power sensor to the power sensor jack of the R&S ZVH and insert the directional power sensor between the source and the load.

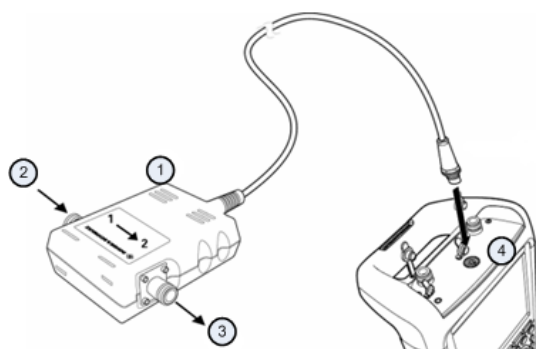

- | | |
|---|---|
| 1 | Directional power sensor R&S FSH-Z14 or Z44 |
| 2 | Source |
| 3 | Load |
| 4 | Power sensor jack |

Measuring the power

- ▶ Press the MODE key.
- ▶ Press the "Power Meter" softkey.

As soon as the R&S ZVH recognizes the power sensor, it shows the type of the directional power sensor that is connected in the diagram header. After a few seconds it also shows the forward power and return loss currently measured at the load.

Zeroing the power sensor

Before performing the power measurement, you should zero the power sensor. For more information, see "[Measuring the Power with a Power Sensor](#)" on page 69.

After zeroing is done, the R&S ZVH outputs the message "Power Sensor Zero OK" and again shows the power sensor softkey menu.

- ▶ Connect the R&S FSH-Z14 or R&S FSH-Z44 between the source and the load.
The R&S ZVH displays the measured forward power in dBm and the SWR of the load.

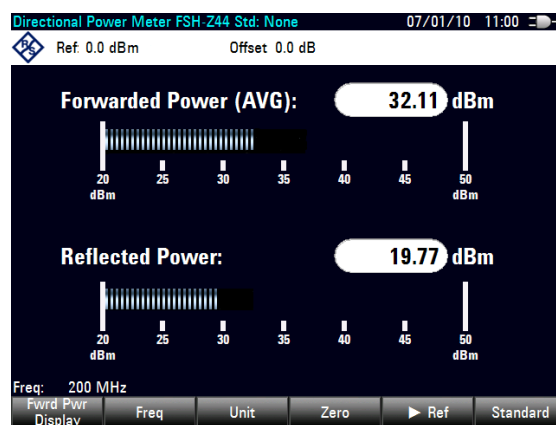

To get the best results, you should also define the frequency of the signal. For more information see "[Measuring the Power with a Power Sensor](#)" on page 69.

2.6 Saving and Recalling Results and Settings

The R&S ZVH can store measurement results and settings in the internal memory, on a removable SD memory card or on a memory stick via the USB interface.

Results and settings are always stored together, allowing them to be interpreted in context when recalled. The R&S ZVH can store at least 100 data records in the internal memory which are differentiated by their names.

The R&S ZVH provides a USB port and a SD card slot. For more information see "[USB Port](#)" and "[SD Card Slot](#)".

To use the SD card, insert it into the slot until it audibly clicks into place. Remove the SD card, by pressing it in and then pulling it out.

2.6.1 Saving Measurement Results

- ▶ Press the SAVE/RECALL key.
- ▶ Press the "Save" softkey.

The R&S ZVH opens the file manager dialog box.



- 1 Available data sets and folder structure
- 2 Data set name input field
- 3 Remaining memory on selected data storage
- 4 File manager softkey menu

- ▶ Specify a name for the data set in the input field of the dialog box with the number keys.

In addition, ▼ moves the cursor to the left, ▲ moves it to the right and the BACK key deletes a character.

You can either

- overwrite a data set that already exists by selecting it from the available data sets with the cursor keys or
 - edit the name of an existing data set with the cursor keys and the numeric keys or
 - create a new data set by entering a new name with the numeric keys.
- ▶ Select the storage medium you want to use.
 - ▶ Press the "Save" softkey.

The R&S ZVH saves the data set.

2.6.2 Recalling Measurement Results

Use the R&S ZVH recall function to review previously saved measurement results and settings.

- ▶ Press the SAVE/RECALL key.
- ▶ Press the "Recall" softkey.

A list of all saved data sets opens.

If you want to recall results from the SD card or a USB stick, select it first to view its contents.

Select a data set from the list with the cursor keys.

- ▶ Confirm your selection with the "Recall" softkey.

Index

AC adapter	15	Headphone jack.....	23
Accessories	12	IF output	25
Accessory detection.....	32	Kensington lock	26
Attenuation	63	LAN port	26
Audio settings	41	Languages.....	38
Auto low distortion	63	Length unit.....	39
Auto low noise	63	Options	28
AUX input	23, 35	Positioning.....	14
Backlight.....	40	Power overload beep.....	41
Battery (car adapter).....	16	Power sensor.....	69
Battery (charging)	16	directional.....	71
Battery (external charger)	17	Power sensor port.....	22
Battery (replacement)	16	Power settings	42
Battery insertion.....	14	Preamplifier	65
Battery low level.....	42	Preset	44
BIAS ports	24	Regional settings	38
BNC connectors.....	24	Reset.....	44
configuration.....	32	RF input.....	21
Color scheme.....	40	SD card slot.....	27
Connectors	20	Self alignment.....	43
Controls	13	Signal attenuation	63
Date & time.....	37	Spectrum analyzer	63
Date format.....	38	Support.....	14
DC bias.....	33	Tracking generator output.....	22
DC port	27	USB port.....	26, 27
Directional power sensor.....	71	User Interface	13
Display settings.....	40	Volume	
External reference	24	key click volume	41
External trigger	24	system beeper	41
GPS information	36	Zeroing	70, 72
GPS receiver	35	ZVHView	45
Hardware settings.....	32		