

soft seating

PRODUCT GUIDE 2023



MOORECO™



MooreCo Inc.

2885 Lorraine Avenue | Temple, TX 76501

p: 800.749.2258 | f: 866.888.7483

www.moorecoinc.com

©2023 MooreCo, Inc. All rights reserved.

MooreCo, Inc. reserves the right to correct pricing or copy errors.

Due to the current volatility in the price of raw and finished materials, please refer to our web site for the latest price list for pricing. Since individual items are subject to availability of materials from our suppliers, we reserve the right to limit quantities.

All shipping weights are nominal and may vary depending on items and quantities ordered. When ordering please contact MooreCo customer service at 1-800-749-2258 for accurate shipping rates and lead times.

Board dimensions reflect panel sizes prior to framing. All boards listed as 3'H x 4'W actually measure 33-3/4"H x 48"W due to shipping restrictions. Dimensions on all glass dry erase boards are estimated and may vary slightly.

Return Policy: A return authorization is required for the return of any merchandise. All requests for returns should be made within 90 (ninety) days of receipt of merchandise. The dealer may be responsible for restock and return freight charges. Returned products must be unused, undamaged, and in the original packaging. Please contact customer service for more details. Returned merchandise may be subject to a restocking fee.

Restocking Fee: Returned merchandise will be subject to a restocking fee.

Non-Returnable Merchandise: All boards and furniture which have been custom sized, custom framed, or customized to specifications will be considered a non-returnable item.



Alighting on a familiar path to a comforting destination...

Designed to foster calm, to soothe anxiety, and to provide a more restful outlet for quiet thinking and work, soft seating puts people at ease and in a more focused and open frame of mind. Soft seating brings immediate comfort and relaxation and a sense of home to any space, and is fast becoming the preferred seating for a variety of spaces, from educational to commercial.

Our full line of soft seating offers the potential to create a truly unique and tailor-made environment. We can accommodate any industry or style, whether it's commercial, industrial, medical, or educational. Contemporary or traditional, bright or subtle. Our offerings and configurations will turn your environment into a warm and productive space.

We bring contemporary styling together with customizable options, which include over 5000 fabric choices. Our configurations are limitless, with selections of curved and straight shapes, tables, casters, and integrated power modules.

See how you can bring your space to life...

Soft Seating Graded-In Product Information

Graded-In Fabrics

We've partnered with multiple fabric and textile manufacturers to offer you more than 5000 graded-in fabric options. Please refer to the MooreCo Graded-In Fabrics Guide for grading information. The guide can be downloaded at www.moorecoinc.com/price-guides.

Upcharges & Add-Ons

Upcharge Option:	Product Line:
Two fabrics	
Ganging device	
Back shelf	Lounge seating with a back
Mobility package	Lounge seating with a back
Tablet arm	Lounge seating without arms
Tablet arm	Lounge seating with arms
Face-Up Electrical	
Under Seat Electrical	Under modular seats with legs
Pop-Up Flat Face Electrical	
Pop-Up Grommet Electrical	Table tops only
MoorePower® Tower	
Tablet Side Table	



Materials

Seating is assembled with ¾" commercial grade plywood and hardwood. The seat back is made up of a Martex Syntex woven webbing. Hard top tables are constructed with 48-52 density MDF core and finished with HPL. CAL 117-2013 Compliant. Weight limit 400 lbs.

Warranty Information

Seating Frame – MooreCo warrants the frames used in soft seating products to be free from design defects in materials and workmanship for a period of twelve (12) years beginning on the date of shipment.

Seating Foam – MooreCo warrants the foam used in soft seating products to be free from defects in materials and workmanship, beginning on the date of shipment, extending for five (5) years. This does not include softening and flattening of the foam that occurs as a result of normal use and aging.

Seating Fabric – The MooreCo warranty of fabrics offered as part of the graded program is dictated by the materials manufacturer and passed on accordingly. Customer Own Material (COM) is not warranted.

Table Frame – MooreCo warrants the frames used in soft seating products to be free from design defects in materials and workmanship for a period of twelve (12) years beginning on the date of shipment.

Table Top – MooreCo warrants HPL table tops used in soft seating products to be free from design defects in materials and workmanship for a period of twelve (12) years beginning on the date of shipment.

Table Fabric – The MooreCo warranty of fabrics offered as part of the graded program is dictated by the materials manufacturer and passed on accordingly. Customer Own Material (COM) is not warranted.

Electrical Options – Electrical options are warranted for one (1) year from date of shipment for manufacturer's defects.

Changes & Cancellation

MooreCo's acceptance of an order for custom soft seating is final and binding and an order may not be changed or canceled without MooreCo's written consent. To change or cancel orders, contact MooreCo Customer Care in writing for authorization and applicable charges. **All orders for soft seating must be on a separate PO with no other MooreCo products.**

Freight Program

All soft seating and graded-in products ship FOB Tennessee. All charges illustrated in the matrix include delivery only and do not include extra services such as: inside delivery, lift gate service, white glove services, international shipments, or shipments to Alaska or Hawaii.

Ordering Details

Visit www.moorecoinc.com/price-quote-a-product or contact your sales representative at 800.749.2258 to request more information. Pricing and fabric availability are subject to change.

2022 Zoned Freight Pricing Matrix

Zone	Orders less than \$1000	Orders \$1001 - \$42,000	Orders greater than \$42,000 (truckload)
1	\$250.00	11% (\$250.00 min.)	6%
2	\$365.00	14% (\$365.00 min.)	8%
3	\$550.00	21% (\$550.00 min.)	14%
4	\$625.00	22% (\$625.00 min.)	15%

Effective 03-21-2022

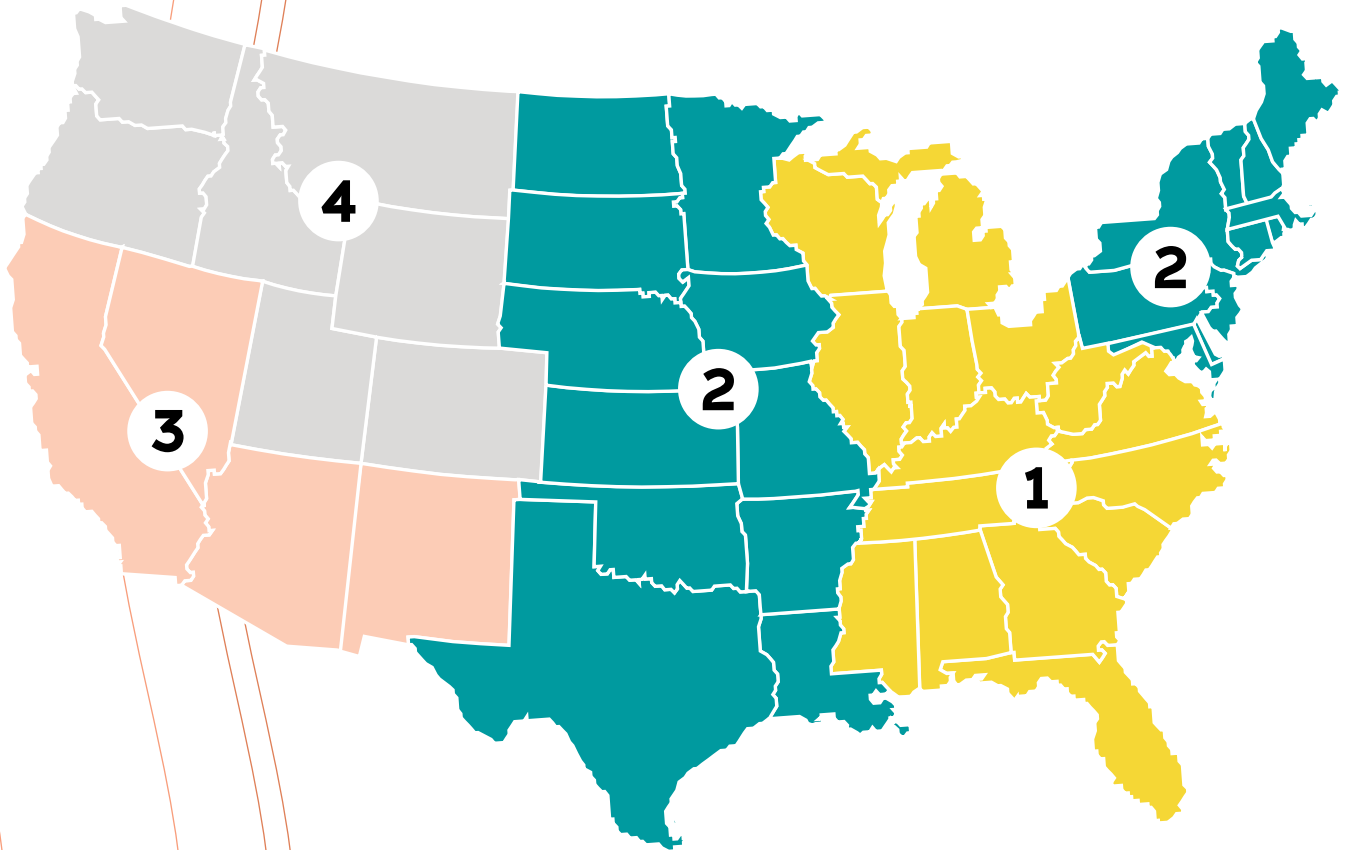

Elevate Wind
90° Arch Seat



Akt Lounge
Sofa



Akt Lounge
Loveseat Table



Akt Lounge
Chair

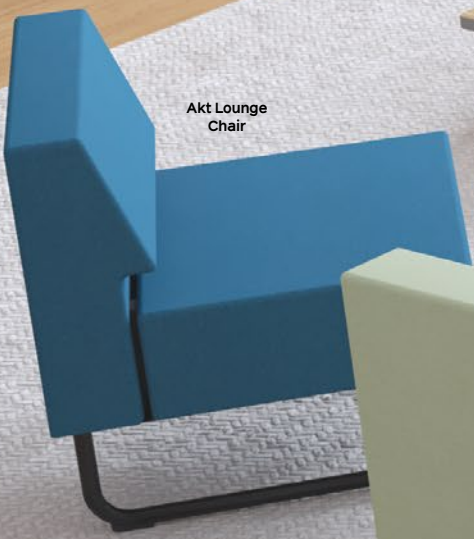

Akt Lounge
Small Ottoman



Tablet Side
Table





Akt Stacking
Chair



Akt Lounge Soft Seating

- Designed to be inviting, comfortable, and easy to clean, Akt lounge seating is the perfect addition to your common and public spaces. Cozy pieces are perfect for individual work and relaxation, private collaboration, or team activities.
- Ideally suited for secondary learners, higher education students, and employees in the workforce, Akt lets you outfit a multitude of spaces to establish privacy, study spaces, and relaxation.
- Akt soft seating is designed to facilitate easy and thorough cleaning by minimizing the spaces where debris can collect. The taller legs allow most vacuums to fit beneath, and each piece features gaps between the back and seat to allow crumbs and dirt to fall to the ground where it can be easily vacuumed.
- Seating also features spacers between the seat and arms for easy access and easy cleaning. The spacers are available in colors to match the other members of the Akt family.
- Multiple seating shapes and sizes to create a cohesive and flexible environment.
- Top stitched sewing details in upholstery. Textiles available through graded-in fabric program, or COM by approval. Includes powder-coated steel legs.
- Available with optional integrated electrical USB and 110v outlets.
- Manufactured in the USA from commercial grade ¾" plywood and hardwoods. Seats are 18"H on all units.
- Twelve year limited warranty on seating. Prop 65 and CAL 117-2013 compliant. 400 lb. capacity.
- SCS Indoor Advantage Gold Certified.

VIEW ONLINE

Akt Lounge Soft Seating



Akt Lounge Single Bench

AK-BN-292918
17"H x 29.5"W x 29.5"D



Akt Lounge Loveseat Bench

AK-BN-295418
17"H x 54"W x 29.5"D

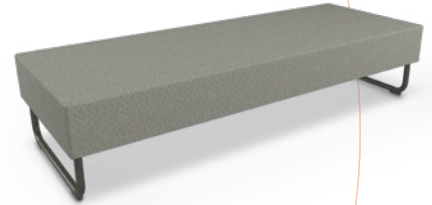

Akt Lounge Sofa Bench

AK-BN-297818
17"H x 78"W x 29.5"D



Akt Lounge Chair - Armless

AK-AL-292918-XX
31"H x 29.5"W x 29.5"D



Akt Lounge Loveseat - Armless

AK-AL-295418-XX
31"H x 54"W x 29.5"D



Akt Lounge Sofa - Armless

AK-AL-297818-XX
31"H x 78"W x 29.5"D



Akt Lounge Chair - Both Arms

AK-LO-293818-XX
31"H x 39"W x 29.5"D



Akt Lounge Loveseat - Both Arms

AK-LO-296618-XX
31"H x 66"W x 29.5"D



Akt Lounge Sofa - Both Arms

AK-LO-298718-XX
31"H x 87"W x 29.5"D



Akt Lounge Corner Chair

AK-CO-292918-XX
31"H x 29.5"W x 29.5"D



Akt Lounge High Back Chair

AK-HB-293718-XX
57"H x 37"W x 29.5"D



Akt Lounge High Back Loveseat

AK-HB-295918-XX
57"H x 59"W x 29.5"D



Akt Lounge Small Ottoman

AK-OT-313118
18"H x 31"W x 31"D



Akt Lounge Large Ottoman

AK-OT-505015
15"H x 50"W x 50"D





Ogee Curved Easel



Valu-Tak Tackboard



Schoolworks Bookcase



Pinto Pillow



Square Ottoman



Lentil Round Lounger



Divvy D.O.C.



Fava Lounge Chair

Soft Sway Rocker

Beanies by MooreCo

- Find a cozy pod to recharge during the day with Beanies by MooreCo.
- Adding flexible seating to your spaces increases a user's sensory experience, shown to improve calmness, focus, and reduce tension. By creating space where humans of all ages can relax, you foster positive attitudes and encourage learning.
- Featuring the same soft and comfortable interior cushioning used for our highest quality soft seating, these bean bag chairs come in multiple sizes and versions for both indoor and outside settings.
- Beanies were designed with humans of all ages in mind, featuring a standard childproof zipper for hours of play and restoration.
- Indoor styles feature a machine washable outer layer of cozy microsuede with a removable insert filled mixed polyurethane foam. Available in select fabrics and multiple colors to suit any room with style.
- Choose from five indoor styles: Lima Lounger (two sizes available), Lentil Round Lounger (two sizes available), and the Pinto Pillow.
- Outdoor Beanies feature a machine washable exterior made of Sunbrella canvas with a removable insert with a polystyrene infill. Available in select fabrics and multiple colors to suit any space with style.
- Choose from five outdoor styles: Chana Lounge Chair, Fava Lounge Chair, square ottoman, round ottoman, or rectangle ottoman.
- SCS Indoor Advantage Gold Certified.

VIEW ONLINE

Beanies by MooreCo



Indoor Lima Lounger (Small)

58581-VX-XXXX
26"H x 46"W x 34"D



Indoor Lima Lounger (Large)

58580-VX-XXXX
36"H x 64"W x 47"D



Indoor Lentil Round Lounger (Small)

58582-VX-XXXX
16"H x 45"W x 45"D



Indoor Lentil Round Lounger (Large)

58583-VX-XXXX
40"H x 48"W x 58"D



Indoor Pinto Pillow

58584-VX-XXXX
15"H x 44"W x 64"D





Outdoor Chana Lounge Chair

58588-VX-XXXX
30"H x 36"W x 28"D



Outdoor Fava Lounge Chair

58589-VX-XXXX
28"H x 26"W x 36"D



Outdoor Square Ottoman

58585-VX-XXXX
17"H x 17"W x 17"D



Outdoor Round Ottoman

58586-VX-XXXX
17"H x 21"W x 21"D



Outdoor Rectangle Ottoman

58587-VX-XXXX
14"H x 26"W x 18"D





Mid Back
Loveseat

Chair

Tablet Arm
Accessory

Sofa

Single Table



Hierarchy
Cloud 9 Table

Hierarchy
4-Leg Chair



Straight Soft Seating

- Soft seating creates a welcoming and comfortable environment by establishing islands of quiet and calm where creativity, collaboration, and socialization can flow naturally.
- Adding flexible seating to your spaces increases a user's sensory experience, shown to improve calmness, focus, and reduce tension. By creating space where humans of all ages can relax, you foster positive attitudes and encourage learning.
- Modular soft seating pieces are designed to work together to create limitless configurations, from circular, straight, to serpentine arrangements that fit any space or architectural detail.
- Top stitched sewing details in upholstery. Textiles available through graded-in fabric program, or COM by approval. Includes aluminum legs.
- Available with optional integrated electrical USB and 110v outlets.
- Manufactured in the USA from commercial grade ¾" plywood and hardwoods. Seats are 18-½"H on all units.
- Table top models feature 1" MDF core with a variety of HPL laminate and edge band options.
- Twelve year limited warranty on seating and five years for table versions.
- Prop 65 and CAL 117-2013 compliant. 400 lb. capacity.
- SCS Indoor Advantage Gold Certified.

VIEW ONLINE

Straight Soft Seating



Single Bench
1000B
18.5"H x 22.5"W x 29.5"D



Single Table
1000T
16"H x 22.5"W x 29.5"D



Chair - Armless
1000C
34.5"H x 22.5"W x 29.5"D



Chair - Right Arm
1000CRH
34.5"H x 26.5"W x 29.5"D



Chair - Left Arm
1000CLH
34.5"H x 26.5"W x 29.5"D



Chair - Both Arms
1000CLR
34.5"H x 30.5"W x 29.5"D



Mobility Chair - Armless
1000CM
34.5"H x 22.5"W x 29.5"D



Mobility Chair - Both Arms
1000CLRM
34.5"H x 22.5"W x 29.5"D



Double Bench
2000B
18.5"H x 45"W x 29.5"D

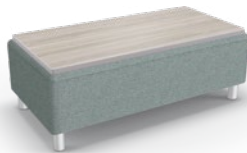

Double Table
2000T
16"H x 45"W x 29.5"D



Loveseat - Armless
2000C
34.5"H x 45"W x 29.5"



Loveseat - Right Arm
2000CRH
34.5"H x 49"W x 29.5"D



Loveseat - Left Arm
2000CLH
34.5"H x 49"W x 29.5"D



Loveseat - Both Arms
2000CLR
34.5"H x 53"W x 29.5"D

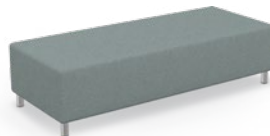

Triple Bench
2500B
18.5"H x 68.5"W x 29.5"D



Sofa - Armless
2500C
34.5"H x 68.5"W x 29.5"D



Sofa - Right Arm
2500CRH
34.5"H x 72.5"W x 29.5"D



Sofa - Left Arm
2500CLH
34.5"H x 72.5"W x 29.5"D



Sofa - Both Arms
2500CLR
34.5"H x 76.5"W x 29.5"D



Round Corner Bench
5000SB
16"H x 49"W x 36"D



Square Corner Bench
6000RB
16"H x 49"W x 34"D



Square Corner Table
5000SBT
16"H x 49"W x 36"D



Round Corner Table
6000RBT
16"H x 49"W x 34"D



Mid Back - Armless
2000BM
37.4"H x 47.1"W x 29.5"D



Mid Back - Arms
2000MB
37.4"H x 56.3"W x 29.5"D



Mid Back Armless + Shelf
2000BMS-29/36
37.4"H x 47.1"W x 41.8"D



Mid Back Arms + Shelf
2000MBS-29/36
37.4"H x 56.3"W x 41.8"D



High Back - Armless
2000BH
49.4"H x 47.1"W x 29.5"D



High Back - Arms
2000HB
49.4"H x 56.3"W x 29.5"D



High Back Armless + Shelf
2000BHS-29/36/42
49.4"H x 47.1"W x 41.8"D



High Back Arms + Shelf
2000HBS-29/36/42
49.4"H x 56.3"W x 41.8"D



Loveseat

22.5° Inside Chair -
Right Arm

22.5° Inside
Chair - Armless

22.5° Outside
Chair - Armless

Single Table

22.5° Table



Chair



Curved Soft Seating

- Soft seating creates a welcoming and comfortable environment by establishing islands of quiet and calm where creativity, collaboration, and socialization can flow naturally.
- Adding flexible seating to your spaces increases a user's sensory experience, shown to improve calmness, focus, and reduce tension. By creating space where humans of all ages can relax, you foster positive attitudes and encourage learning.
- Modular soft seating pieces are designed to work together to create limitless configurations, from circular, straight, to serpentine arrangements that fit any space or architectural detail.
- Top stitched sewing details in upholstery. Textiles available through graded-in fabric program, or COM by approval. Includes aluminum legs.
- Available with optional integrated electrical USB and 110v outlets.
- Manufactured in the USA from commercial grade ¾" plywood and hardwoods. Seats are 18-½"H on all units.
- Table top models feature 1" MDF core with a variety of HPL laminate and edge band options.
- Twelve year limited warranty on seating and five years for table versions.
- Prop 65 and CAL 117-2013 compliant. 400 lb. capacity.
- SCS Indoor Advantage Gold Certified.

VIEW ONLINE

Curved Soft Seating



22.5° Bench
3000B
18.5"H x 33"W x 29.5"D



22.5° Table
3000T
16"H x 33"W x 29.5"D



22.5° Inside Chair -
Armless
3000CIB • 34.5"H x 33"W x 29.5"D



22.5° Inside Chair -
Right Arm
3000CIBRH • 34.5"H x 37"W x 29.5"D



22.5° Inside Chair -
Left Arm
3000CIBLH • 34.5"H x 37"W x 29.5"D



22.5° Inside Chair -
Both Arms
3000CIBLR • 34.5"H x 41"W x 29.5"D



22.5° Outside Chair -
Armless
3000COB • 34.5"H x 33"W x 29.5"D



22.5° Outside Chair -
Right Arm
3000COBRH • 34.5"H x 37"W x 29.5"D



22.5° Outside Chair -
Left Arm
3000COBLH • 34.5"H x 37"W x 29.5"D



22.5° Outside Chair -
Both Arms
3000COBLR • 34.5"H x 41"W x 29.5"D



45° Bench
4000B
18.5"H x 45"W x 29.5"D



45° Table
3000T
16"H x 45"W x 29.5"D



45° Inside Chair -
Armless
4000CIB • 34.5"H x 45"W x 29.5"D



45° Inside Chair -
Right Arm
4000CIBRH • 34.5"H x 49"W x 29.5"D



45° Inside Chair -
Left Arm
4000CIBLH • 34.5"H x 49"W x 29.5"D



45° Inside Chair -
Both Arms
4000CIBLR • 34.5"H x 53"W x 29.5"D



45° Outside Chair -
Armless
4000COB • 34.5"H x 45"W x 29.5"D



45° Outside Chair -
Right Arm
4000COBRH • 34.5"H x 49"W x 29.5"D



45° Outside Chair -
Left Arm
4000COBLH • 34.5"H x 49"W x 29.5"D



45° Outside Chair -
Both Arms
4000COBLR • 34.5"H x 53"W x 29.5"D



Media Space
Flat Panel Cart

Chair

Orbit 45°
Wedge

Orbit
Loveseat

Hierarchy
4-Leg Stool



Sofa

Double
Table



Orbit® Media Space Soft Seating

- Create a communication and collaboration space that is cozy, comfortable, and fosters the open flow of ideas, thoughts, and information. Orbit® Media Space Soft Seating provides configurable and flexible conference space, with soft fabrics, optional back shelves for additional seating, and higher backs that promote quiet and privacy.
- Adding flexible seating to your spaces increases a user's sensory experience, shown to improve calmness, focus, and reduce tension. By creating space where humans of all ages can relax, you foster positive attitudes and encourage learning.
- Top stitched sewing details in upholstery. Textiles available through graded-in fabric program, or COM by approval. Includes aluminum legs.
- Available with optional integrated electrical USB and 110v outlets.
- Manufactured in the USA from commercial grade ¾" plywood and hardwoods. Seats are 18-½"H on all units.
- Table top models feature 1" MDF core with a variety of HPL laminate and edge band options.
- Twelve year limited warranty on seating and five years for table versions.
- Prop 65 and CAL 117-2013 compliant. 400 lb. capacity.
- SCS Indoor Advantage Gold Certified.

[VIEW ONLINE](#)

Orbit® Media Space Soft Seating





Orbit Chair
1000CHBT
42.5"H x 22.5"W x 29.5"D



Orbit Loveseat
2000CHBT
42.5"H x 45"W x 29.5"D



Orbit 45° Wedge
4000CHBT
42.5"H x 52.5"W x 29.5"D

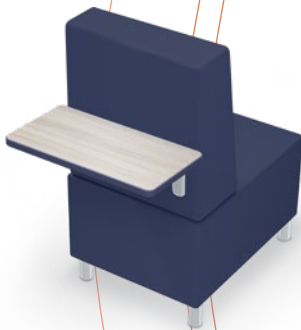

Orbit Chair + 29" Shelf
1000CHBTS-29
42.5"H x 22.5"W x 41.8"D



Orbit Loveseat + 29" Shelf
2000CHBTS-29
42.5"H x 45"W x 41.8"D



Orbit 45° Wedge + 29" Shelf
4000CHBTS-29
42.5"H x 52.5"W x 43.5"D



Orbit Chair + 42" Shelf
1000CHBTS-42
42.5"H x 22.5"W x 41.8"D



Orbit Loveseat + 42" Shelf
2000CHBTS-42
42.5"H x 45"W x 41.8"D



Orbit 45° Wedge + 42" Shelf
4000CHBTS-42
42.5"H x 52.5"W x 43.5"D



Kids Chair

Kids Chair -
Right Arm

Kids Chair -
Left Arm

Kids Single
Table

Kids Shapes
Bench

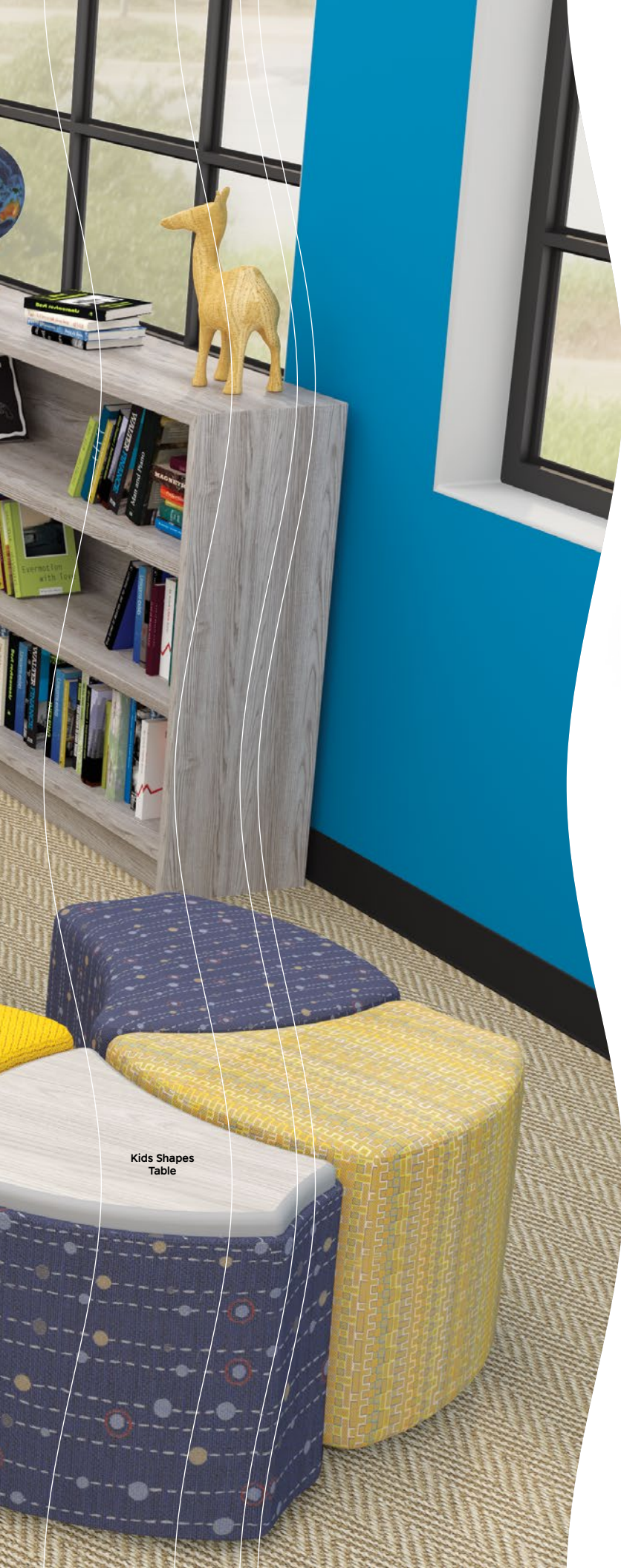

Kids Shapes
Table



Kids Soft Seating

- Soft seating creates a welcoming and comfortable environment by establishing islands of quiet and calm where creativity, collaboration, and socialization can flow naturally.
- Adding flexible seating to your spaces increases a user's sensory experience, shown to improve calmness, focus, and reduce tension. By creating space where humans of all ages can relax, you foster positive attitudes and encourage learning.
- One-third smaller than standard modular seating, kids soft seating is suggested for K-5 age range. Seat heights are 15" on all units.
- Coordinates with other kids soft seating pieces to configure as circular, straight, or serpentine arrangements.
- Top stitched sewing details in upholstery. Textiles available through graded-in fabric program, or COM by approval. Includes aluminum legs.
- Available with optional integrated electrical USB and 110v outlets.
- Manufactured in the USA from commercial grade ¾" plywood and hardwoods.
- Tables feature 1" MDF core with a variety of HPL laminate and edge band options.
- Twelve year limited warranty on seating and five years for table versions.
- Prop 65 and CAL 117-2013 compliant. 400 lb. capacity.
- SCS Indoor Advantage Gold Certified.

VIEW ONLINE

Kids Soft Seating



Kids Single Bench
7000B
15.5"H x 19.5"W x 24.5"D



Kids Single Table
7000T
12.8"H x 19.5"W x 24.5"D



Kids Chair - Armless
7000C
29"H x 19.5"W x 24.5"D



Kids Chair - Right Arm
7000CRH
29"H x 22.9"W x 24.5"D



Kids Chair - Left Arm
7000CLH
29"H x 22.9"W x 24.5"D



Kids Chair - Both Arms
7000CLR
29"H x 26.3"W x 24.5"D



Kids Loveseat - Armless
7500C
29"H x 39"W x 24.5"D



Kids Loveseat - Right Arm
7500CRH
29"H x 42.4"W x 24.5"D



Kids Loveseat - Left Arm
7500CLH
29"H x 42.4"W x 24.5"D



Kids Loveseat - Both Arms
7500CLR
29"H x 45.8"W x 24.5"D



Kids 22.5° Bench
8000B
15"H x 26.8"W x 24.5"D



Kids 22.5° Table
8000T
12.8"H x 26.8"W x 24.5"D



Kids Corner Bench - Square
8500SBT • 12.5"H x 42.8"W x 28"D



Kids 22.5° Inside Chair - Armless
8000B • 29"H x 26.8"W x 24.5"D



Kids 22.5° Inside Chair - Right Arm
8000CIBRH • 29"H x 30.1"W x 24.5"D



Kids 22.5° Inside Chair - Left Arm
8000CIBLH • 29"H x 30.1"W x 24.5"D



Kids Corner Bench - Round
8500RBT • 12.5"H x 42.8"W x 28"D



Kids 22.5° Outside Chair - Armless
8000COB • 29"H x 26.8"W x 24.5"D



Kids 22.5° Outside Chair - Right Arm
8000COBRH • 29"H x 30.1"W x 24.5"D



Kids 22.5° Outside Chair - Left Arm
8000COBLH • 29"H x 30.1"W x 24.5"D



2-Tier
Straight Seat

3-Tier
Straight Seat

2-Tier Inside
Wedge

3-Tier Inside
Wedge



2-Tier Outside Wedge

Pouf Stool



Elevate Steps Soft Seating

- Soft seating creates a welcoming and comfortable environment by establishing islands of quiet and calm where creativity, collaboration, and socialization can flow naturally.
- Adding flexible seating to your spaces increases a user's sensory experience, shown to improve calmness, focus, and reduce tension. By creating space where humans of all ages can relax, you foster positive attitudes and encourage learning.
- Tiered Elevate Soft Seating pieces coordinate to configure in multiple arrangements. Ganging devices included.
- Two-tier seating pieces have step rises of 17-3/4" and 17" bottom to top. Three-tier seating pieces have step rises of 10-1/4", 16", and 8-1/2" bottom to top.
- Top stitched sewing details in upholstery. Textiles available through graded-in fabric program, or COM by approval. Includes nylon glides.
- Manufactured in the USA from commercial grade 3/4" plywood and hardwoods.
- Twelve year limited warranty on seating. Prop 65 and CAL 117-2013 compliant. 400 lb. capacity.
- SCS Indoor Advantage Gold Certified.

[VIEW ONLINE](#)

Elevate Steps Soft Seating



2-Tier Straight Seat
TS1001
35"H x 37"W x 41"D



2-Tier Outside 45° Wedge
TS1011
35"H x 43"W x 41"D

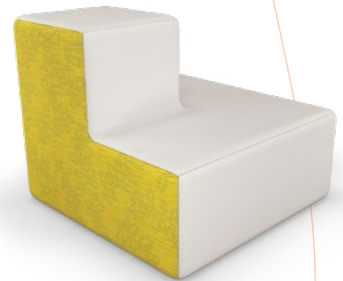

2-Tier Outside Corner
TS1008
35"H x 41"W x 41"D



2-Tier Outside Wedge
TS1003
35"H x 47"W x 41"D



2-Tier Inside 45° Wedge
TS1009
35"H x 43"W x 41"D



2-Tier Inside Wedge
TS1005
35"H x 47"W x 41"D



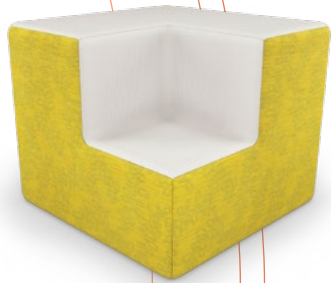

2-Tier Inside Corner

TS1007
35"H x 41"W x 41"D



3-Tier Outside 45° Wedge

TS1012
35"H x 43"W x 41"D



3-Tier Straight Seat

TS1002
35"H x 37"W x 41"D



3-Tier Inside 45° Wedge

TS10010
35"H x 43"W x 41"D



3-Tier Outside Wedge

TS10004
35"H x 47"W x 41"D



3-Tier Inside Wedge

TS10006
35"H x 47"W x 41"D





Quartile Chair

Quartile Bench

Arch Bench

2-Sided Chair

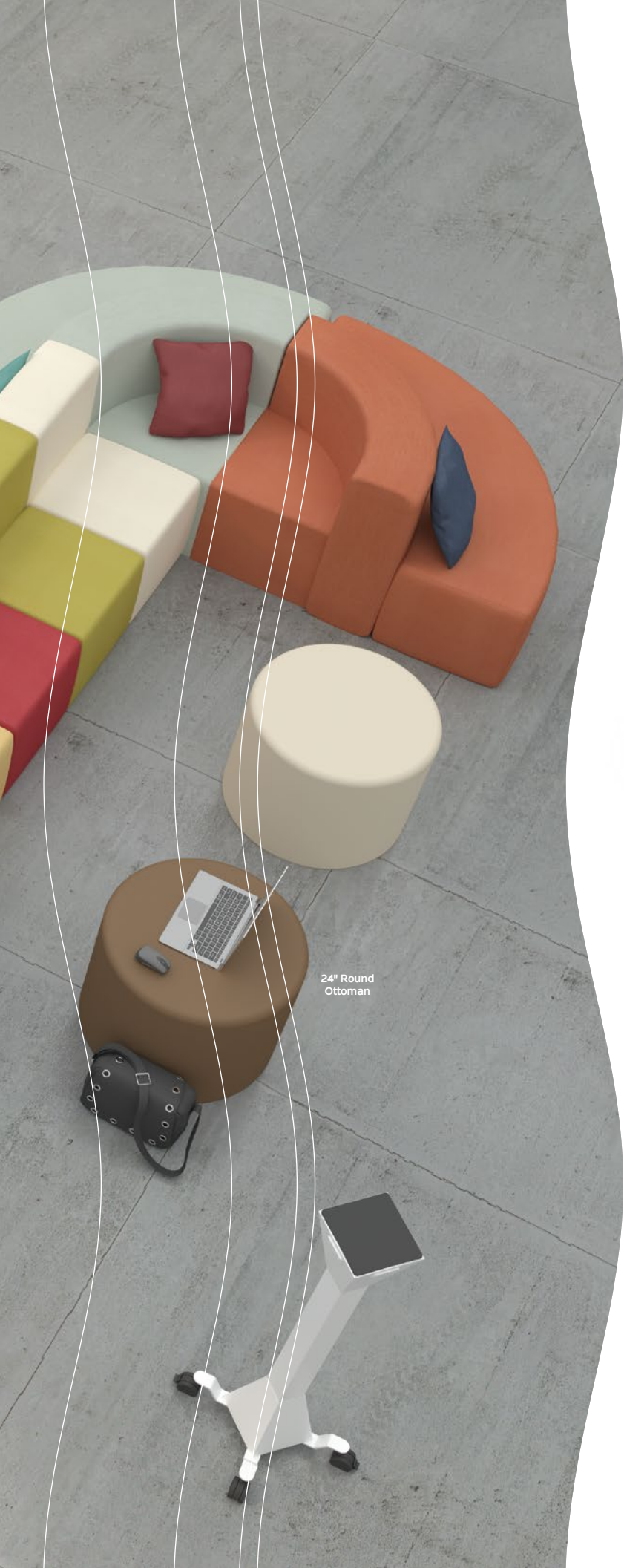

24" Round Ottoman



Elevate Wind Soft Seating

- Soft seating creates a welcoming and comfortable environment by establishing islands of quiet and calm where creativity, collaboration, and socialization can flow naturally.
- Adding flexible seating to your spaces increases a user's sensory experience, shown to improve calmness, focus, and reduce tension. By creating space where humans of all ages can relax, you foster positive attitudes and encourage learning.
- Elevate Wind soft seating works together to configure in multiple arrangements. Ganging devices included.
- Top stitched sewing details in upholstery. Textiles available through graded-in fabric program, or COM by approval. Includes nylon glides.
- Manufactured in the USA from commercial grade ¾" plywood and hardwoods.
- Twelve year limited warranty on seating.
- Prop 65 and CAL 117-2013 compliant. 400 lb. capacity.
- SCS Indoor Advantage Gold Certified.

VIEW ONLINE

Elevate Wind Soft Seating



Lounge Chair
TS1020
30"H x 20"W x 30"D



2-Sided Lounge Chair
TS1021
30"H x 20"W x 50"D



1-1/2 Seat Lounge Chair
TS1022
30"H x 30"W x 30"



2-Sided 1-1/2 Seat Chair
TS1022
30"H x 30"W x 50"D



Loveseat
TS1024
30"H x 40"W x 30"D



2-Sided Loveseat
TS1025
30"H x 40"W x 50"D



Corner Lounge Chair
TS1026
30"H x 30"W x 30"D



Sofa
TS1027
30"H x 60"W x 30"D



1-1/2 Seat Bench
TS1028
18"H x 30"W x 20"D



2 Seat Bench
TS1029
18"H x 40"W x 20"D



3 Seat Bench
TS1030
18"H x 60"W x 20"D



Octagonal Ottoman
TS1031
18"H x 32"W x 32"D



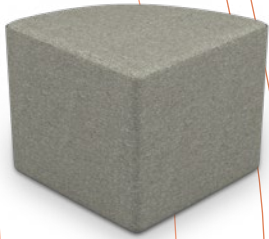

Quartile Bench
TS1032
18"H x 28"W x 20"D



Quartile Chair
TS1033
30"H x 42"W x 30"D



Round Ottoman - 20"
TS1035
18"H x 20"W x 20"D



Round Ottoman - 24"
TS1036
18"H x 24"W x 24"D



Cube
TS1034
18"H x 20"W x 20"D



90° Inside Arch
TS1037
30"H x 85"W x 60"D



90° Outside Arch
TS1038
30"H x 70.5"W x 50"D



90° Arch Bench
TS1039
18"H x 60"W x 20"D



Hexagonal Ottoman
TS1041
18"H x 37"W x 32"D



Wedge Pillow
TS1042
17"H x 18"W x 7.5"D



Crescent Bench
TS1040
18"H x 50"W x 20"D



Chevron
Table

Chevron
Bench

Cloud 9
Bench

Cloud 9
Table

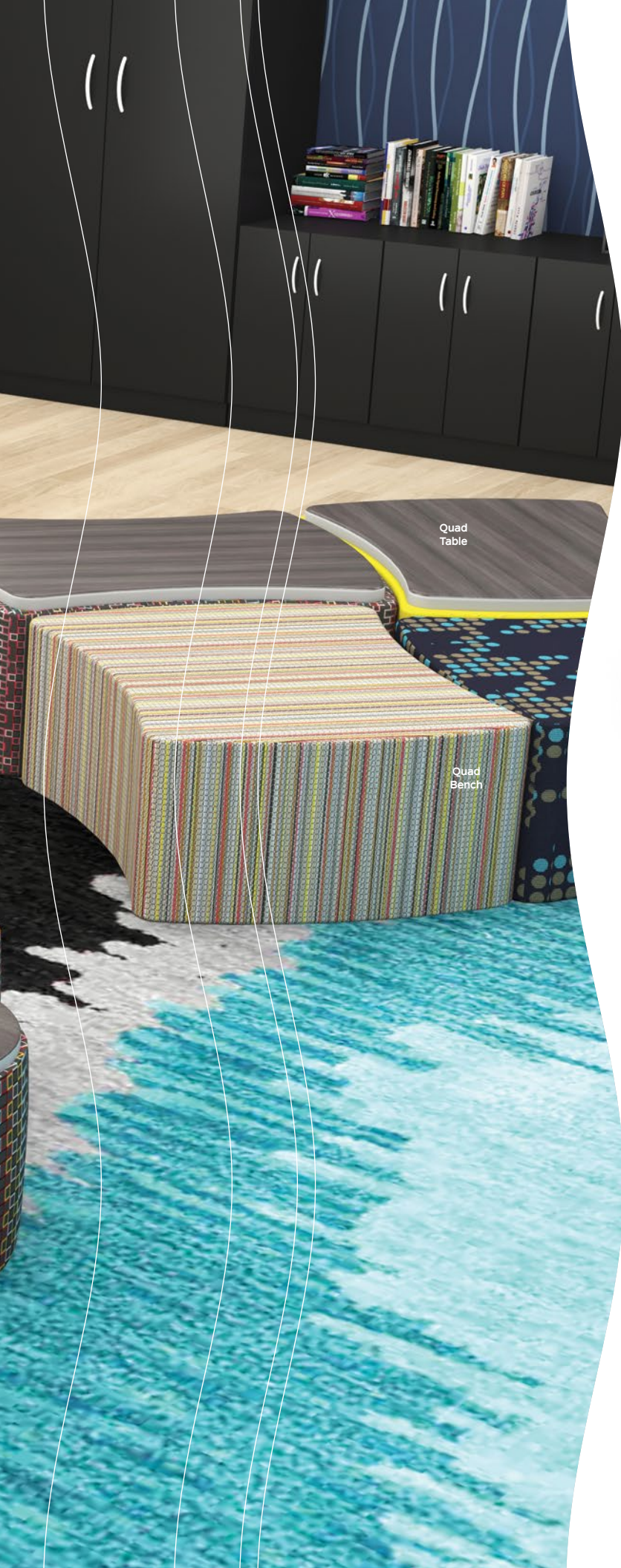

Quad
Table

Quad
Bench



Shape & Pod Soft Seating

- Soft seating creates a welcoming and comfortable environment by establishing islands of quiet and calm where creativity, collaboration, and socialization can flow naturally.
- Adding flexible seating to your spaces increases a user's sensory experience, shown to improve calmness, focus, and reduce tension. By creating space where humans of all ages can relax, you foster positive attitudes and encourage learning.
- Modular soft seating pieces are designed to work together to create limitless configurations, from circular, straight, to serpentine arrangements that fit any space or architectural detail.
- Top stitched sewing details in upholstery. Textiles available through graded-in fabric program, or COM by approval. Includes aluminum legs.
- Available with optional integrated electrical USB and 110v outlets.
- Manufactured in the USA from commercial grade ¾" plywood and hardwoods. Seats are 18-½"H on all units.
- Table top models feature 1" MDF core with a variety of HPL laminate and edge band options.
- Twelve year limited warranty on seating and five years for table versions.
- Prop 65 and CAL 117-2013 compliant. 400 lb. capacity.
- SCS Indoor Advantage Gold Certified.

VIEW ONLINE

Shape & Pod Soft Seating



Chevron Bench
1100S
16"H x 30"W x 24"D

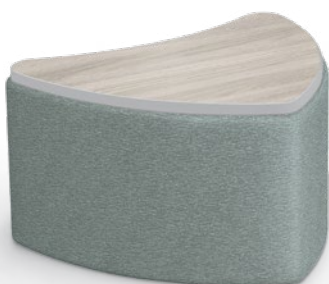

Chevron Table
1100T
16"H x 30"W x 24"D



Cloud 9 Bench
1200S
16"H x 48"W x 33.5"D

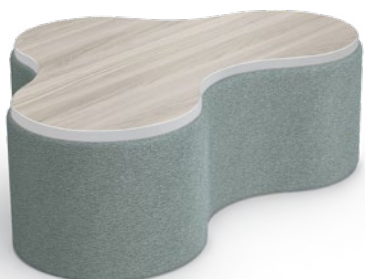

Cloud 9 Table
1200T
16"H x 48"W x 33.5"D

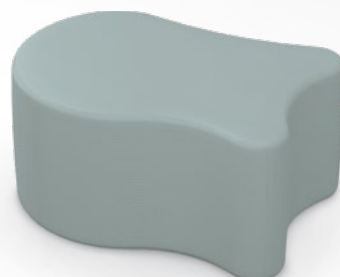

Fender by MooreCo Bench
11RS
16"H x 28"W x 28"D

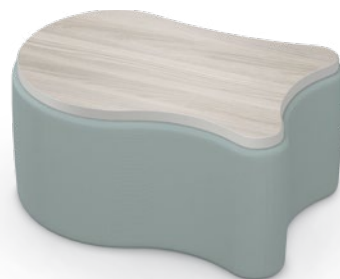

Fender by MooreCo Table
11RST
16"H x 28"W x 28"D





Quad Bench
1300S
16"H x 41.5"W x 32"D



Quad Table
1300T
16"H x 41.5"W x 32"D

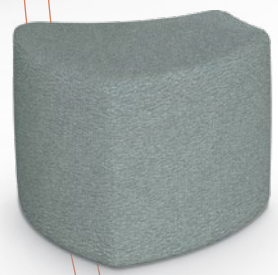

Kids Shapes Bench
915S
16"H x 18"W x 20"D

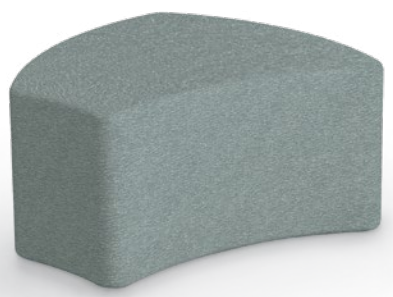

Shapes Bench
900S
16"H x 29"W x 28.5"D

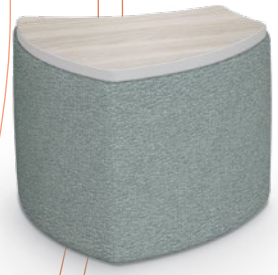

Kids Shapes Table
915T
16"H x 18"W x 20"D

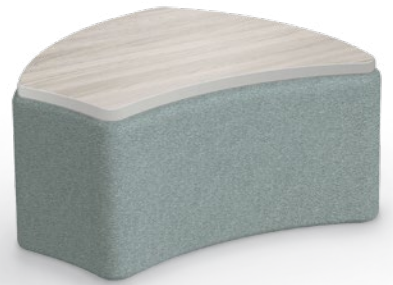

Shapes Table
900T
16"H x 29"W x 28.5"D



Orbit 45°
Wedge

Triangle
Table

Triangle
Bench

Half Round
Bench

Hierarchy
Activity Table

Trapezoid
Table

Hierarchy
4-Leg Chair



D.O.C. Mobile
Room Divider

Square
Bench

Trapezoid
Bench



Creator Soft Seating

- Soft seating creates a welcoming and comfortable environment by establishing islands of quiet and calm where creativity, collaboration, and socialization can flow naturally.
- Adding flexible seating to your spaces increases a user's sensory experience, shown to improve calmness, focus, and reduce tension. By creating space where humans of all ages can relax, you foster positive attitudes and encourage learning.
- Top stitched sewing details in upholstery. Textiles available through graded-in fabric program, or COM by approval. Includes floor safe nylon glides.
- Available with optional integrated electrical USB and 110v outlets.
- Manufactured in the USA from commercial grade 3/4" plywood and hardwoods.
- Tables feature 1" MDF core with a variety of HPL laminate and edge band options.
- Twelve year limited warranty on seating and five years for table versions.
- Prop 65 and CAL 117-2013 compliant. 400 lb. capacity.
- SCS Indoor Advantage Gold Certified.

VIEW ONLINE

Creator Soft Seating



Creator Chevron Bench
16PS
16"H x 29.8"W x 26"D



Creator Rectangle Bench
16QS
16"H x 59.6"W x 31"D



Creator Chevron Table
16PST
16"H x 29.8"W x 26"D



Creator Rectangle Table
16QST
16"H x 59.6"W x 31"D



Creator Half Round Bench
16NS
16"H x 56.9"W x 29.5"D



Creator Half Round Table
16NST
16"H x 56.9"W x 29.5"D

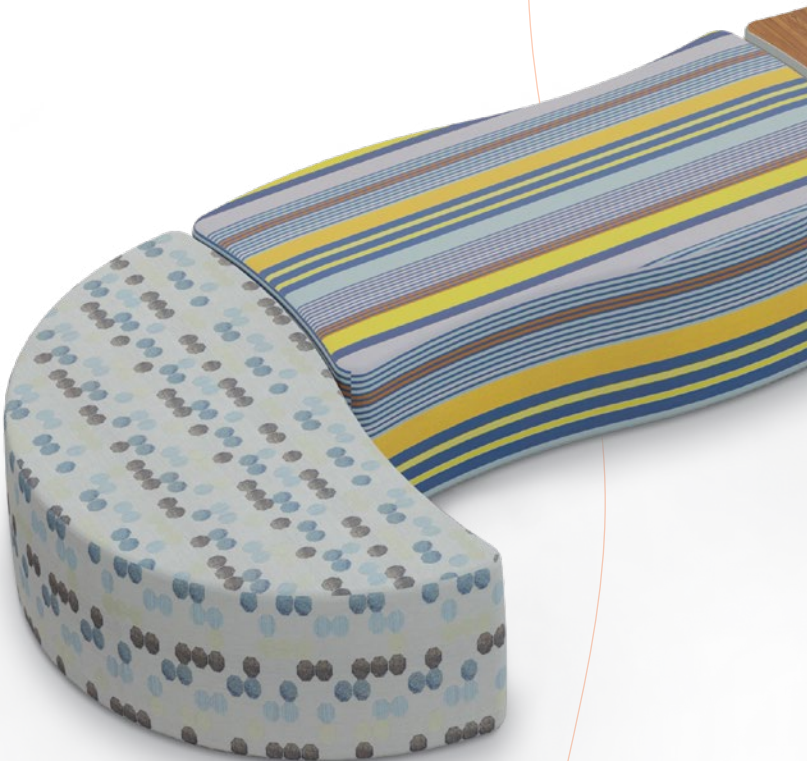

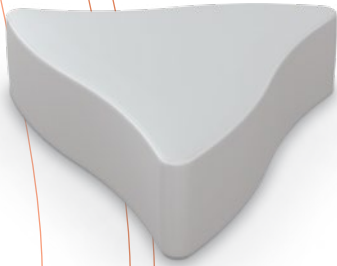

Creator Triangle Bench

16KS
16"H x 54.2"W x 49.2"D



Creator Trapezoid Bench

16JS
16"H x 58"W x 25.4"D

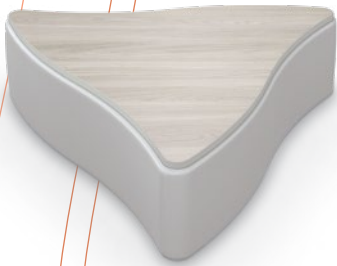

Creator Triangle Table

16KST
16"H x 54.2"W x 49.2"D



Creator Trapezoid Table

16JST
16"H x 58"W x 25.4"D

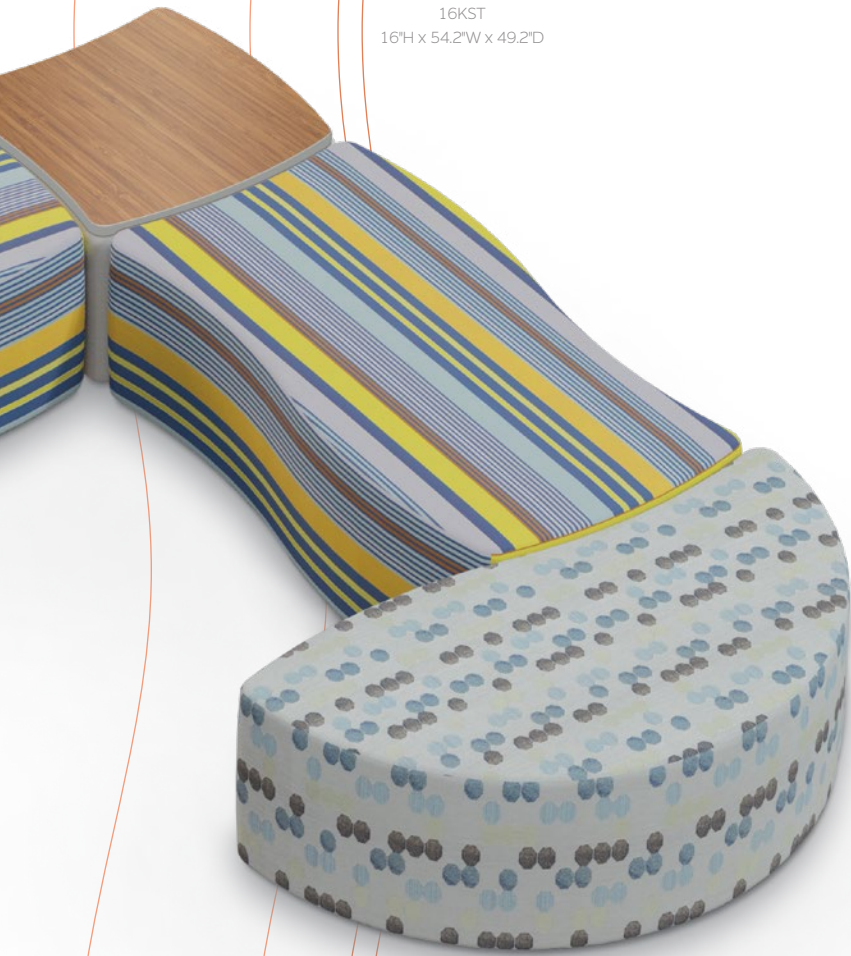

Creator Square Bench

16MS
16"H x 30.8"W x 30.5"D



Creator Square Table

16MST
16"H x 30.8"W x 30.5"D



Curved Variable Height Ottoman



Pouf Stool



Blossom 30° Center Ottoman



Blossom Petal Stool

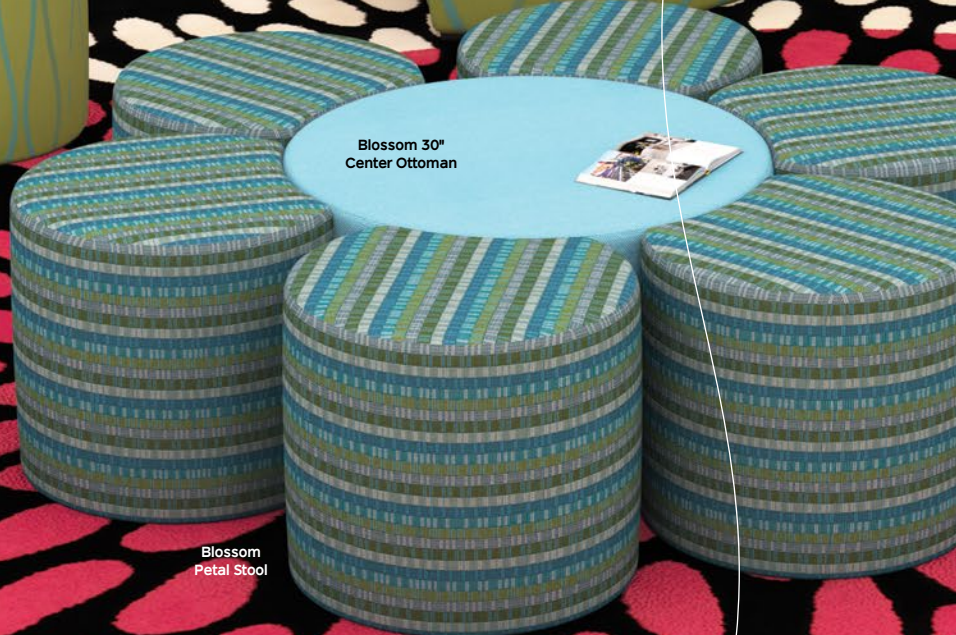

Rectangular Variable Height Ottoman





Blossom Soft Seating

- Put a smile on your space! Blossom soft seating is a fun and vibrant addition to any learning space, adding comfortable, mobile, and configurable seating.
- Adding flexible seating to your spaces increases a user's sensory experience, shown to improve calmness, focus, and reduce tension. By creating space where humans of all ages can relax, you foster positive attitudes and encourage learning.
- Top stitched sewing details in upholstery. Textiles available through graded-in fabric program, or COM by approval. Glides, aluminum legs, or caster feet are available.
- Standard 30" center ottoman fits six petal stools. Center ottoman also available in 26" for five petals, 36" for seven petals, and 42" for eight petals.
- Available with optional integrated electrical USB and 110v outlets.
- Tables feature 1" MDF core with a variety of HPL laminate and edge band options.
- Manufactured in the USA from commercial grade 3/4" plywood and hardwoods.
- Twelve year limited warranty on seating and five years for table versions.
- Prop 65 and CAL 117-2013 compliant. 400 lb. capacity.
- SCS Indoor Advantage Gold Certified.

VIEW ONLINE

Blossom Soft Seating



Petal Stool + Glides
30BSG • 18"H x 20"W x 18"D



Petal Stool + Legs
30BSL • 18"H x 20"W x 18"D



Petal Stool + Casters
30BSC • 18"H x 20"W x 18"D



26" Ottoman + Glides
26BOG • 18"H x 26"W x 26"D



26" Ottoman + Legs
26BOL • 18"H x 26"W x 26"D



26" Ottoman + Casters
26BOC • 18"H x 26"W x 26"D



26" Ottoman Table + Glides
26BOGT • 18"H x 26"W x 26"D



26" Ottoman Table + Legs
26BOLT • 18"H x 26"W x 26"D



26" Ottoman Table + Casters
26BOCT • 18"H x 26"W x 26"D



30" Ottoman + Glides
30BOG • 18"H x 26"W x 26"D



30" Ottoman + Legs
30BOL • 18"H x 26"W x 26"D



30" Ottoman + Casters
30BOC • 18"H x 26"W x 26"D



30" Ottoman Table + Glides
30BOGT • 18"H x 26"W x 26"D



30" Ottoman Table + Legs
30BOLT • 18"H x 26"W x 26"D



30" Ottoman Table + Casters
30BOCT • 18"H x 26"W x 26"D



36" Ottoman + Glides
36BOG • 18"H x 26"W x 26"D



36" Ottoman + Legs
36BOL • 18"H x 26"W x 26"D



36" Ottoman + Casters
36BOC • 18"H x 26"W x 26"D

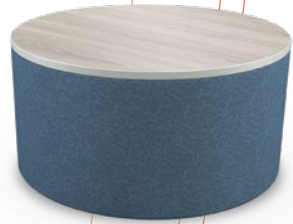

36" Ottoman Table + Glides
36BOGT • 18"H x 26"W x 26"D



36" Ottoman Table + Legs
36BOLT • 18"H x 26"W x 26"D



36" Ottoman Table + Casters
36BOCT • 18"H x 26"W x 26"D



42" Ottoman + Glides
42BOG • 18"H x 26"W x 26"D



42" Ottoman + Legs
42BOL • 18"H x 26"W x 26"D



42" Ottoman + Casters
42BOC • 18"H x 26"W x 26"D

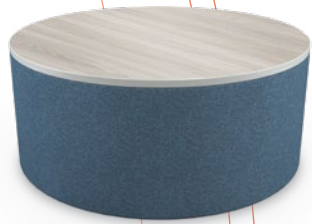

42" Ottoman Table + Glides
42BOGT • 18"H x 26"W x 26"D



42" Ottoman Table + Legs
42BOLT • 18"H x 26"W x 26"D



42" Ottoman Table + Casters
42BOCT • 18"H x 26"W x 26"D





45° Chair

Height Adjustable
Bistro Table

MediaSpace Table - Large

Loveseat

Cloud 9 Bench



Hierarchy
4-Leg Stool

Curved Variable
Height Ottoman

Pouf Stool



Stools & Ottomans

- Handsome and versatile soft seating stools and ottomans come in a variety of sizes and shapes to coordinate with other soft seating furniture choices for a cohesive and inviting environment.
- Adding flexible seating to your spaces increases a user's sensory experience, shown to improve calmness, focus, and reduce tension. By creating space where humans of all ages can relax, you foster positive attitudes and encourage learning.
- Top stitched sewing details in upholstery. Textiles available through graded-in fabric program, or COM by approval. Includes floor safe glides.
- Available with optional integrated electrical USB and 110v outlets.
- Manufactured in the USA from commercial grade ¾" plywood and hardwoods.
- Tables feature 1" MDF core with a variety of HPL laminate and edge band options.
- Twelve year limited warranty on seating and five years for table versions.
- Prop 65 and CAL 117-2013 compliant. 400 lb. capacity.
- SCS Indoor Advantage Gold Certified.

VIEW ONLINE

Stools & Ottomans



Pouf Stool
970 • 16.5"H x 18"W x 18"D



Pouf Stool Table
970T • 16.5"H x 18"W x 18"D



Round Stool - Low
980L • 15"H x 18"W x 18"D



Round Stool - Medium
980M • 20"H x 18"W x 18"D



Round Stool - High
980H • 24"H x 18"W x 18"D



Square Stool - Low
990L • 15"H x 18"W x 18"D



Square Stool - Medium
990M • 20"H x 18"W x 18"D



Square Stool - High
990H • 24"H x 18"W x 18"D

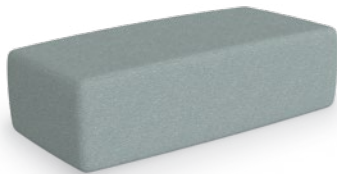

VHO Rectangular - Short
1400S • 12"H x 41.5"W x 20.8"D

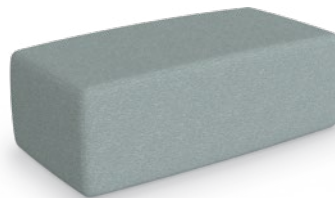

VHO Rectangular - Medium
1400M • 15"H x 41.5"W x 20.8"D



VHO Rectangular - High
1400H • 18"H x 41.5"W x 20.8"D

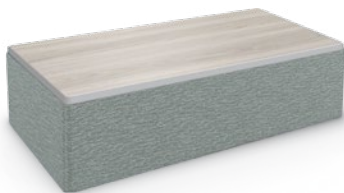

VHO Rectangular Table - Short
1400ST • 12"H x 41.5"W x 20.8"D

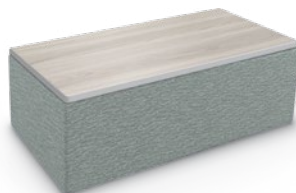

VHO Rectangular Table - Medium
1400MT • 15"H x 41.5"W x 20.8"D

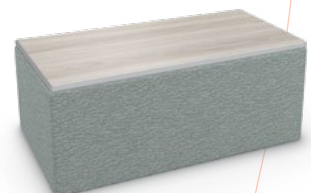

VHO Rectangular Table - High
1400HT • 18"H x 41.5"W x 20.8"D

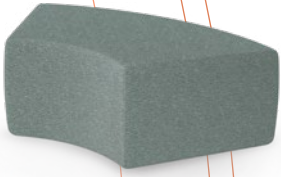

VHO Curved - Short
1500S • 12"H x 43"W x 23.2"D

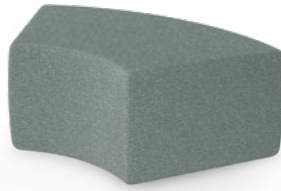

VHO Curved - Medium
1500M • 15"H x 43"W x 23.2"D



VHO Curved - High
1500H • 18"H x 43"W x 23.2"D

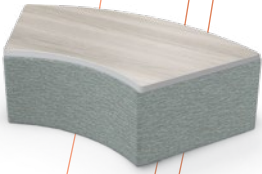

VHO Curved Table - Short
1500ST • 12"H x 43"W x 23.2"D

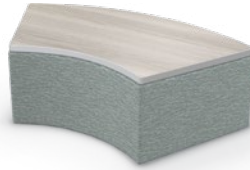

VHO Curved Table - Medium
1500MT • 15"H x 43"W x 23.2"D

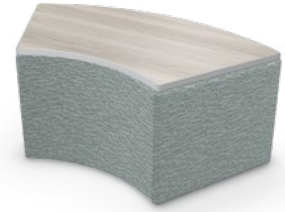

VHO Curved Table - High
1500HT • 18"H x 43"W x 23.2"D

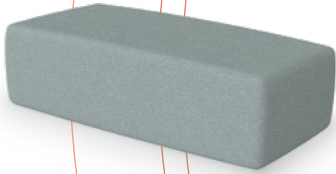

Schoolworks Straight - Short
SG.SWB.422112 • 12"H x 41.5"W x 20.8"D

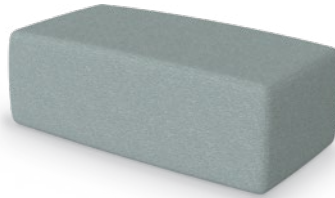

Schoolworks Straight - Medium
SG.SWB.422115 • 15"H x 41.5"W x 20.8"D

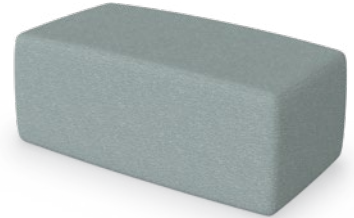

Schoolworks Straight - High
SG.SWB.422118 • 18"H x 41.5"W x 20.8"D

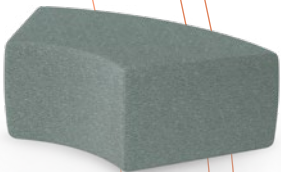

Schoolworks Curved - Short
SG.SWB.422312 • 12"H x 43"W x 23.2"D

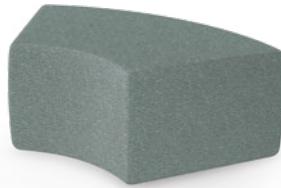

Schoolworks Curved - Medium
SG.SWB.422315 • 15"H x 43"W x 23.2"D

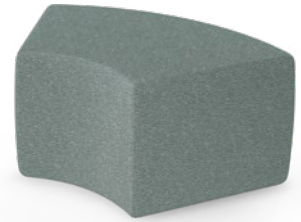

Schoolworks Curved - High
SG.SWB.422318 • 18"H x 43"W x 23.2"D



Mobile Counter Stool
940 • 24"H x 20"W x 20"D



Mobile Bar Stool
950 • 30"H x 20"W x 20"D



Cocoon
Community
Table

Akt Stacking
Stool

Soft Sway
Rocker



Schoolworks
Bookcases

Akt Lounge
Small Ottoman



Rocking Soft Seating

- Moderate and gentle rocking motion allows this soft seating to create rhythmic micro-movements that help release excess energy. All rocking bases are ideal for engaging the core muscles and allowing motion while working to improve focus.
- Adding flexible seating to your spaces increases a user's sensory experience, shown to improve calmness, focus, and reduce tension. By creating space where humans of all ages can relax, you foster positive attitudes and encourage learning.
- The Soft Sway Rocking Chair combines the gentle rhythm of a classic rocker with the cozy relaxation soft seating to provide the comfort your classroom or workspace has been missing with features your floors will love.
- Ideal for use in any common space, library, or other space where relaxation is a plus. Non-skid plastic rocking glides protect fabric and the floor, preventing scuffs, scratches, and marks.
- Interior is made with standard soft seating mixed polyurethane foam. Soft Sway is available in two sizes: small (suggested for K-5 users) and large.
- Stop, drop, and rock with Dot Soft Seating Rocking Stools. Active seating perfectly sized for anyone to provide hours of balanced learning or working with a smooth black convex base that provides a moderate rocking motion to help soothe and relieve excess energy.
- Dot Rocking Stools come in two diameters (15" and 18") and in four heights: extra low (5"), low (12"), medium (15"), or high (18"). The extra low Dot can be used as a stool or kneeling platform.
- Stacks for easy storage or use our Dot Cart for mobile storage. Available with a rocking non-skid base in black plastic.
- Available through our graded-in fabric program or COM on approval.
- SCS Indoor Advantage Gold Certified.

VIEW ONLINE

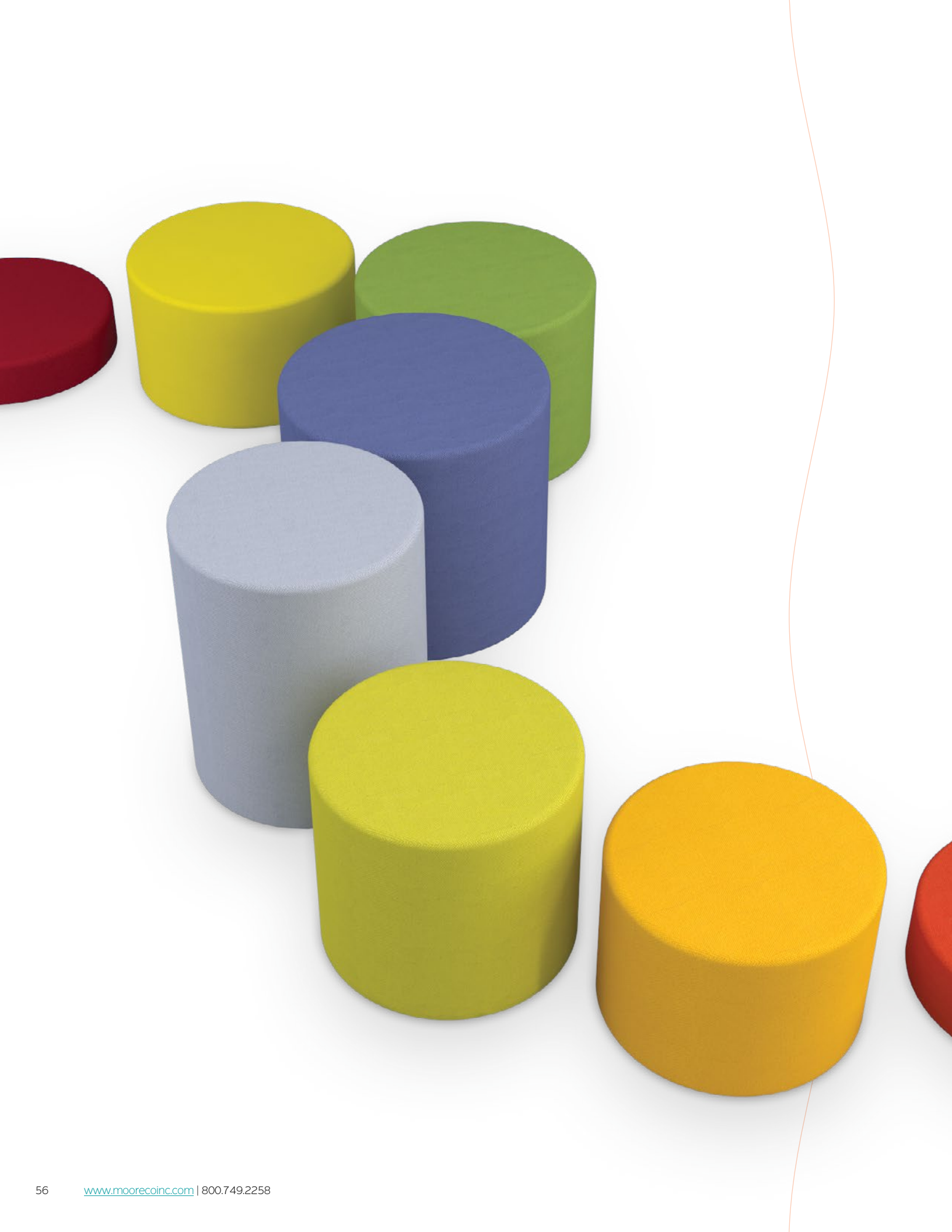

Rocking Soft Seating



Dot Xtra Low (15")

97R105-VX
5"H x 15"W x 15"D



Dot Low (15")

97R112-VX
12"H x 15"W x 15"D



Dot Medium (15")

97R115-VX
15"H x 15"W x 15"D



Dot High (15")

97R118-VX
18"H x 15"W x 15"D



Dot Xtra Low (18")

96R106-VX
5"H x 15"W x 15"D



Dot Low (18")

96R112-VX
12"H x 15"W x 15"D



Dot Medium (18")

96R115-VX
15"H x 15"W x 15"D



Dot High (18")

96R118-VX
18"H x 15"W x 15"D



Soft Sway (Small)

7000RC-VX
26"H x 21"W x 26.5"D



Soft Sway (Large)

1000RC-VX
30.5"H x 22.5"W x 29"D

BURGERS

- #1 Cresecent City Burger \$5.99
Lettuce & Pickles
- #2 Philly Burger \$6.99
Lettuce & Pickles
- #3 BBQ Bacon Cheeseburger \$6.99
'Nuff Said
- #4 Veggie Burger \$5.79
Ditto
- #5 Texas Burger \$6.99
Lettuce, onions, spicy mayo, colby jack
cheese with Texas Sauce on Texas Toast

WRAPS & SANDWICHES

- #1 Buffalo Fried Chicken Wrap \$5.49
Lettuce, cheddar & Jack cheeses,
Buffalo sauce & Bleu cheese dressing
- #2 Sonoma Grilled Chicken Wrap \$4.99
Lettuce, ranch dressing, & Jack cheese
- #3 Kentucky Club Chicken Wrap \$5.99
Lettuce, cheddar & Jack cheese topped
with bacon & honey mustard dressing
- #4 West Coast Veggie Wrap \$4.99
Lettuce, cucumbers, carrots, onions,
mushrooms, Jack cheese with ranch dressing
- #5 Grilled Cheese with Fries \$3.49
- #6 Grilled or Fried Chicken Sandwich \$6.99





Frequency
X-Base Table



Cocoon

- Inspired by modern learning philosophies, the Cocoon has a curved design to create an inviting and welcoming collaboration and discussion space.
- A perfect solution for flexible socializing, meeting, and relaxing, Cocoon fits in-between spaces with ample seating capacity and configurability.
- Low or high laminate surfaces provide generous work space around the outer edge. Soft seating creates cozy and comfortable seating along the inside.
- Fully upholstered soft seating benches available with or without backrest for extra comfort.
- Stadium seating capacity increases line-of-sight, allowing optimum viewing ability for everyone.
- Can be specified in multiple configurations.
- Offered in customizable laminate and fabric options. Use our graded-in program (COM available on approval).
- SCS Indoor Advantage Gold Certified.

VIEW ONLINE



ON AIR

Wall

112" Table

Curved Bench with Back



Insight Glass Board

Array Shelving



Cocoon Media Space

- Cozy and insular, a cocoon is a space where powerful change takes place.
- The Cocoon Media Space is an upscale solution combining technology and functionality, with versatile and independent seating, ideal for situations that require thinking outside the box.
- For students and collaborative learners, the Cocoon Media Space provides the closeness that allows for group thinking, as well as the expansiveness required for big ideas.
- Hybrid learning and integrative educational experiences can take place at the Cocoon Media Space, easily configurable into any library, study hall, or open office area.
- The seating is versatile and independent, with laminate available in countless finishes. The back panel (wall) has been designed to support up to a 55" flat panel. Grommet holes are included for cable management.
- All seating fabric COM or through our graded-in program.
- SCS Indoor Advantage Gold Certified.

VIEW ONLINE

Cocoon



Cocoon Large Bench + Back Rest

BM.CO.B.602930
30"H x 60"W x 29"D



Cocoon Large Bench

BM.CO.B.602918.NB
18"H x 60"W x 29"D



Cocoon Small Bench + Back Rest

BM.CO.B.512830
30"H x 51"W x 28"D



Cocoon Small Bench

BM.CO.B.512818.NB
18"H x 51"W x 28"D

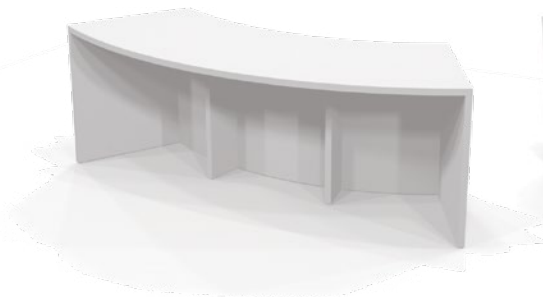

Cocoon Low Surface

BM.CO.TB.883630
30"H x 88"W x 36"D

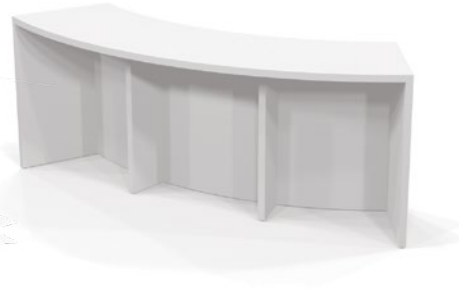

Cocoon High Surface

BM.CO.TB.883641
41"H x 88"W x 36"D

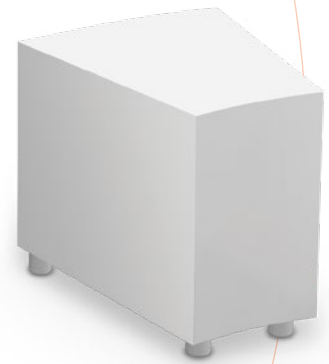

Cocoon Divider

BM.CO.ST.211913
22"H x 24.5"W x 20"D

Cocoon Media Space



Cocoon MS Straight Bench + Back

BM.CO.B.492630
30"H x 49"W x 26"D



Cocoon MS Straight Bench

BM.CO.B.492618.NB
18"H x 49"W x 26"D



Cocoon MS Curved Bench + Back

BM.CO.B.552630
30"H x 55"W x 26"D

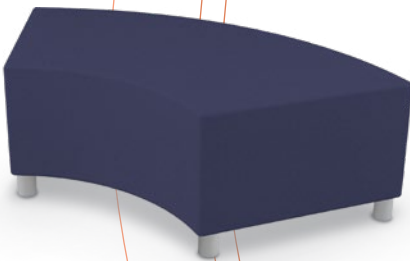

Cocoon MS Curved Bench

BM.CO.B.552618.NB
18"H x 55"W x 26"D

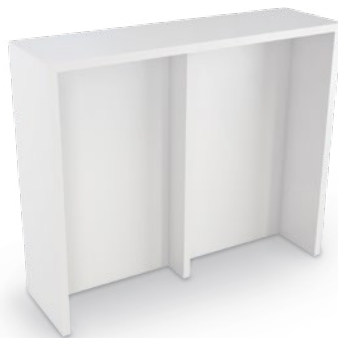

Cocoon MS High Surface (Straight)

BM.CO.TB.491441
41"H x 49"W x 14"D

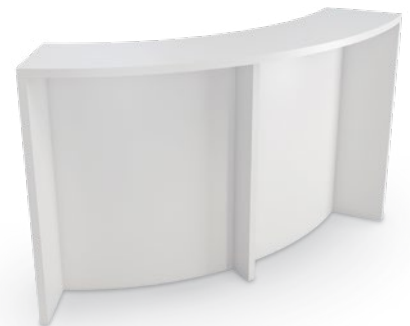

Cocoon MS High Surface (Curved)

BM.CO.TB.711441
41"H x 71"W x 14"D



Cocoon Media Space Wall

BM.CO.WL.540462
62"H x 54"W x 4"D



Cocoon Media Space Table (72")

BM.CO.TB.725429
29"H x 72"W x 54"D



Cocoon Media Space Table (112")

BM.CO.TB.1125429
29"H x 112"W x 54"D



Privacy Pod - Tall



Round Stool



Seed 4-Leg Chair



Akt Table

REMINDER:
SPRING BREAK
NEXT WEEK!

Privacy Pod & Double Privacy Pod

- Cozy and private individual or one-on-one work space makes a comfortable solution for focused study or rest, and distraction-free collaboration or planning.
- Available in single or double models, both provide quiet and confidential space that can be carved out of any busy or community environment. Pods are also ideal for classrooms, libraries, or for use as personal kiosks. Single Privacy Pod available in right- or left-hand orientation.
- Upholstered for sound-dampening, the curved wall shape is designed to reduce noise, providing a quiet workspace. Both short and tall privacy wall options are available.
- Pods feature a built-in work surface that provides ample space for a laptop, and a side table to stow your bag, backpack, or other belongings.
- Available in a variety of fabric combinations through our graded-in program.
- Optional integrated electrical outlets keep your devices powered, charged, and ready to go.
- Designed to allow multiple pods to be arranged in many configurations, fitting any space or nook.
- SCS Indoor Advantage Gold Certified.

VIEW ONLINE



Privacy Pod - Short

SG.SPP.UPP.533948.NP.X • 62"H x 53"W x 39"D



Privacy Pod - Tall

SG.SPP.UPP.533962.NP.X • 62"H x 53"W x 39"D



Double Privacy Pod - Short

SG.DPP.UPP.793648.NP • 62"H x 79"W x 36"D



Double Privacy Pod - Tall

SG.DPP.UPP.793662.NP • 62"H x 79"W x 36"D

Soft Seating Seat Pads



Round Seat Pad (3" x 15")
115R3-VX • 3"H x 15"W x 15"D



Round Seat Pad (5" x 15")
115R5-VX • 5"H x 15"W x 15"D



Round Seat Pad (3" x 18")
118R3-VX • 3"H x 18"W x 18"D



Round Seat Pad (5" x 18")
118R5-VX • 5"H x 18"W x 18"D



Square Seat Pad (3" x 15")
115S3-VX • 3"H x 15"W x 15"D



Square Seat Pad (5" x 15")
115S5-VX • 5"H x 15"W x 15"D



Square Seat Pad (3" x 18")
118S3-VX • 3"H x 18"W x 18"D



Square Seat Pad (5" x 18")
118S5-VX • 5"H x 18"W x 18"D

Soft Seating Seat Pads

- Sit. Stay. Get comfortable with MooreCo's multi-use soft seat pads.
- Adding flexible seating to your spaces increases a user's sensory experience, shown to improve calmness, focus, and reduce tension. By creating space where humans of all ages can relax, you foster positive attitudes and encourage learning.
- Available in multiple sizes, the full-foam construction seat pads are ideal for use as floor cushions or extra padding on harder seats.
- Options range from round and square styles, in 3" or 5" thickness and 15" or 18" widths.
- Seat pads turn any surface into soft seating with mixed polyurethane foam that provides max comfort and softness. Customize through our graded-in fabrics program (COM available on approval).
- Easily stack multiple seat pads in the Dot Cart for accessible and mobile storage.
- SCS Indoor Advantage Gold Certified.

VIEW ONLINE

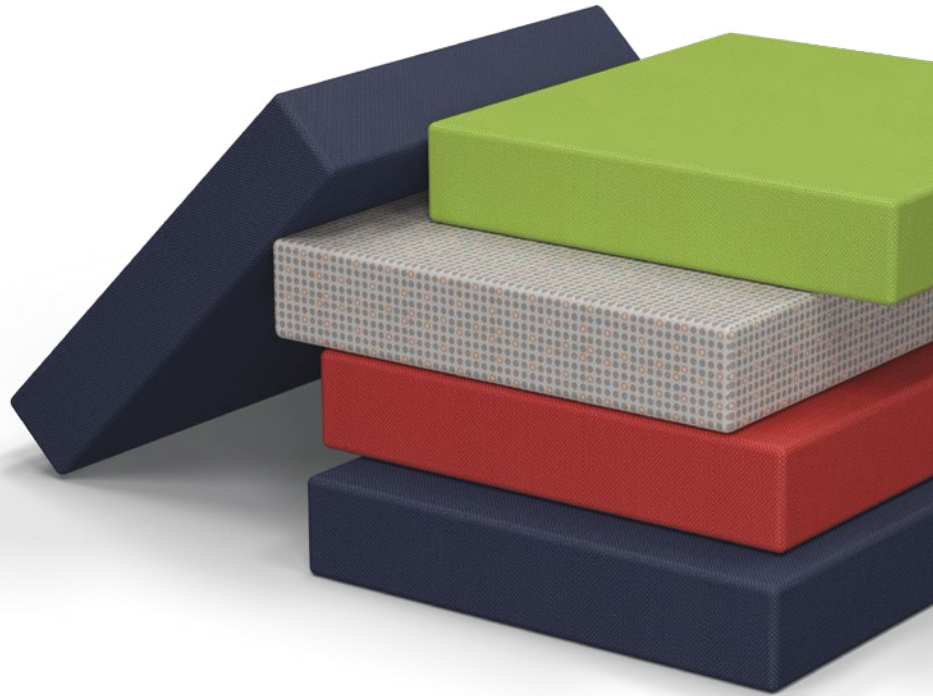

Dot Cart

- Easily store Dots and seat pads to keep your spaces organized and tidy with our Dot Cart.
- Available in four configurations to suit your needs: single and double capacity available for 15" and 18" wide Dots or seat pads.
- The single holds up to five Dots or nine 3" seat pads, while the double holds up to ten Dots or eighteen 3" seat pads.
- Each Dot Cart comes in attractive and neutral Grey Elm laminate. Easily mobile with 3" dual-wheel casters (two locking).
- SCS Indoor Advantage Gold Certified.

VIEW ONLINE



Soft Seating Accessories

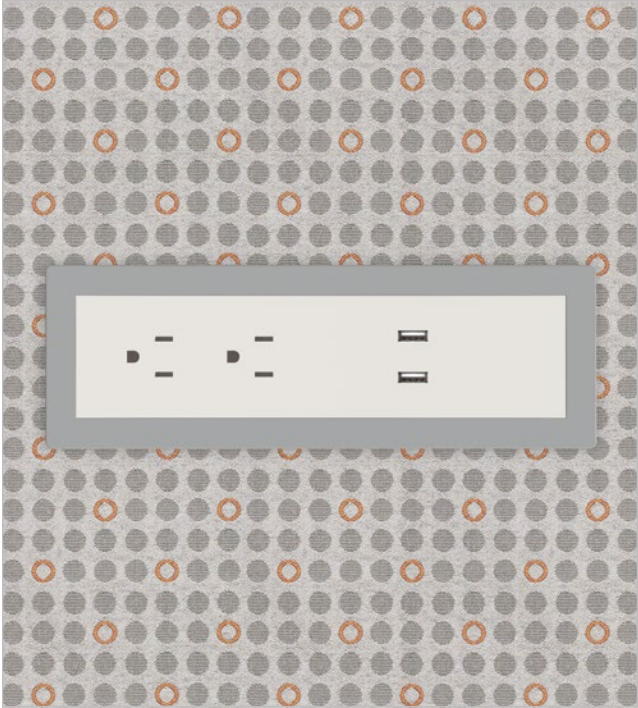

Flat Face Electrical Assembly
Available on table tops or flat upholstery.



Pop-Up Electrical Assembly
Available on table tops or flat upholstery.

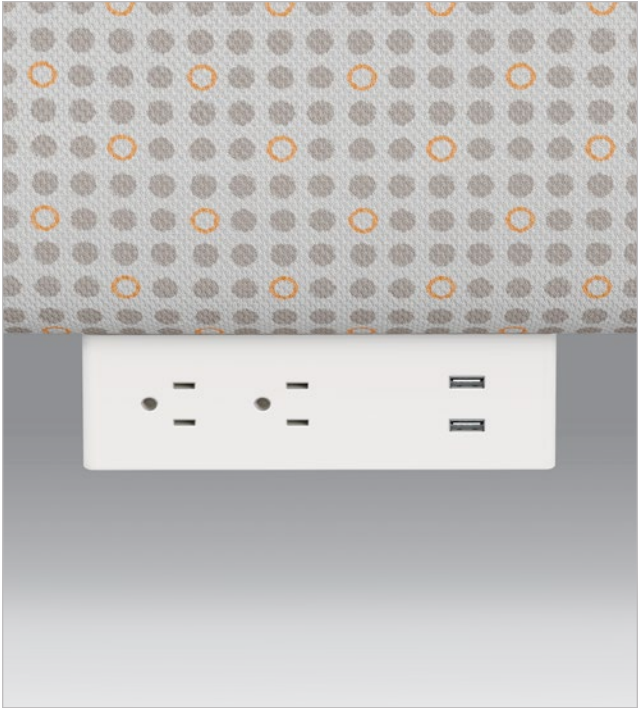

Under Seat Electrical Assembly
Available on soft seating pieces with legs.



Pop-Up Grommet Outlet & USB Charger
Available on table tops.

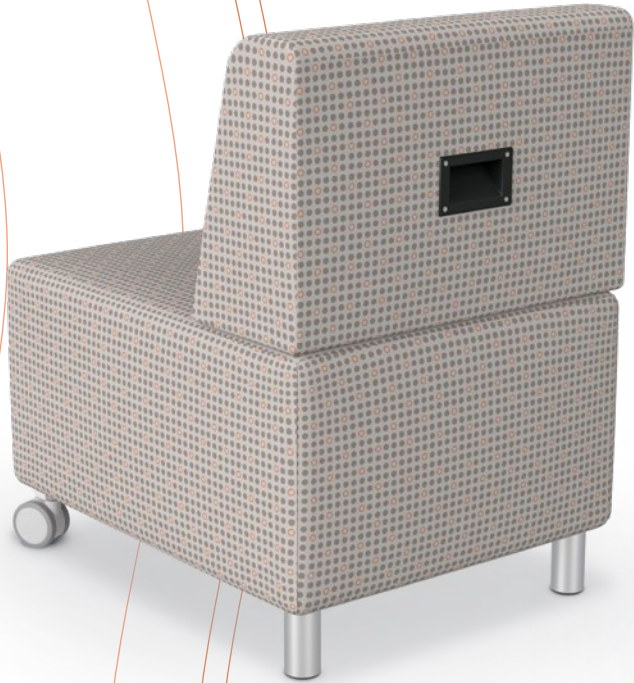

Mobility Package (Handle + Casters)



Tablet Arm + Cup Holder

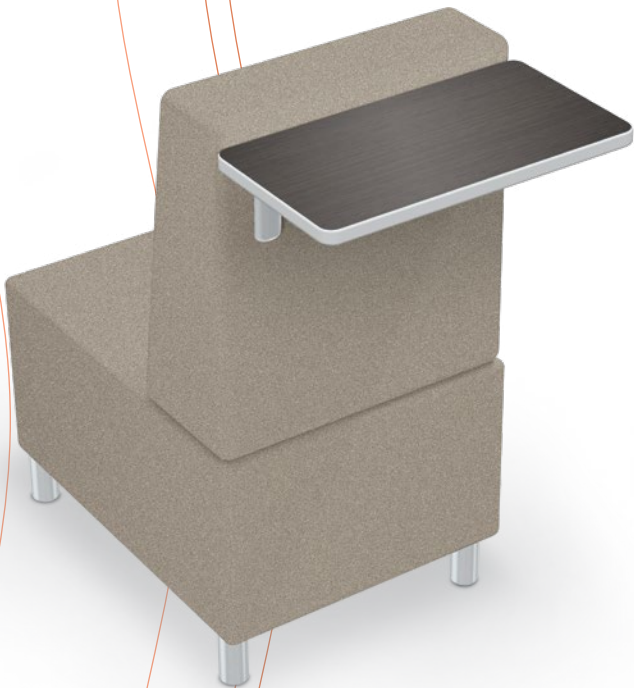

Back Shelf



Tablet Side Table



MoorePower® Tower

Colors & Finishes

HPL Options



Amber Cherry
7919



Asian Night
7949



Castle Oak
7928



Fusion Maple
7909



Graphite Nebula
4623



Grey Elm
8201



Grey Nebula
4622



Low Line
7998

Edge Band Options



Bee
BE



Black
BK



Blue
HBLU



Cayenne
CY



Cool Gray
HGRY



Endless Sea
ES



Green
HGRN



Morning Fog
MF



Moss
MS



Navy
HNKY



Orange
HORG



Platinum
PL



Purple
HPUR



Red
HRED

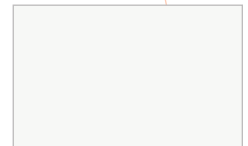

White
WT



Yellow
HYLW



Appendix: Specified Fabrics & Finishes

Please note: fabrics and finishes are chosen for illustration purposes only and do not necessarily represent accurate scale, color, or best purpose of use. Please consult with our professional design team before selecting fabrics and finishes for your space.

Page	Product	Fabric / Finish
Cover	Akt Lounge Chair	Illumina Bashful
	Akt Lounge Table	Laminate: ZebraWood / Edge Band: Morning Fog
	Akt Lounge Loveseat	Ravi Petal
	Akt Lounge Sofa Bench	Illumina Willow
2-3	Akt Lounge Loveseat	Thistle Chambray
	Akt Lounge Single Bench	Wonderland Toffee
	Akt Lounge Table	Laminate: Florence Walnut / Edge Band: Morning Fog
6-7	Elevate Wind Arch Seat	Felt Fanfare
	Akt Lounge Chair 01	Felt Fusion
	Akt Lounge Chair 02	Felt Spritz
	Akt Lounge Small Ottoman	Felt Fusion
	Akt Lounge Loveseat Table	Laminate: Buka Bark / Edge Band: Morning Fog
	Akt Lounge Sofa	Felt Mineral
	Akt Lounge Chair 03	Soho Evergreen
8-9	Akt Lounge Soft Seating	Faux Felt Graphite
	Akt Lounge High Back Seating	Back: Faux Felt Graphite / Seat: Silica Likely Marble
	Akt Lounge Loveseat	Refuge Honey
10-11	Schoolworks Bookcase	Laminate: Buka Bark
	Soft Sway Rocker	Fanfare Wildberry
14-15	Mid Back Loveseat	Back + Arms: Fanfare Tutti Frutti / Seat: Debut Bubblegum
	Single Table	Fabric: Acuco Almond / Laminate: Low Line / Edge Band: Black
	Chair 01	Villa Eggplant
	Chair 02	Acuco Almond
	Sofa	Back + Arms: Fanfare Tutti Frutti / Seat: Debut Bubblegum
	Hierarchy Cloud 9 Table	Laminate: Low Line / Edge Band: Black
16-17	Chair 03	Silica Likely Marble
	Straight Soft Seating	Fuse Pristine
	Table Tops + Back Shelves	Laminate: Grey Elm / Edge Band: Platinum
18-19	Curved Soft Seating	Back: Flower Power Periwinkle / Seat: Kobe Alabaster
	Single Table	Fabric: Neo Bellini / Laminate: Platinum Shagreen / Edge Band: White
	Curved Bench 01	Fabric: Botany Hyacinth / Laminate: Platinum Shagreen / Edge Band: White
	Curved Bench 02	Fabric: Neo Bellini / Laminate: Platinum Shagreen / Edge Band: White
	Curved Chair	Whit Path
20-21	Curved Soft Seating	Fuse Pristine
	Table Tops + Back Shelves	Laminate: Grey Elm / Edge Band: Platinum
	Curved Soft Seating Group	Fabric: Eon Coquette / Laminate: Grey Elm / Edge Band: Platinum
22-23	Orbit Soft Seating	Seat: Continuum Mandarin / Back: Mandala Nordic / Laminate: Grey Elm / Edge Band: Platinum
	Double Table	Fabric: Continuum Turquoise / Laminate: Grey Elm / Edge Band: Platinum
	Sofa	Seat: Continuum Saffron / Back: Mandala Nordic
24-25	Orbit Wedge	Fabric: Core Tide / Laminate: Grey Elm / Edge Band: Platinum
	Orbit Soft Seating Group	Fabric: Milagro Big Sky / Laminate: Grey Elm / Edge Band: Platinum
	Orbit Soft Seating	Fabric: Marathon Toile / Laminate: Grey Elm / Edge Band: Navy
26-27	Kids Chair 01	Riga Daugava
	Kids Chair 02	Civil Bright
	Kids Chair Right Arm	Nagoya Sake
	Kids Chair Left Arm	Civil Bright
	Kids Single Table	Fabric: Nagoya Sake / Laminate: Grey Elm / Edge Band: Platinum
	Kids Shapes Bench 01	Riga Daugava
	Kids Shapes Bench 02	Civil Bright
	Kids Shapes Bench 03	Borders Haven
	Kids Shapes Table	Fabric: Nagoya Sake / Laminate: Grey Elm / Edge Band: Platinum
	Kids Curved Chair	Croquet Navy
28-29	Kids Soft Seating	Ace Bisque
	Table Tops + Back Shelves	Laminate: Grey Elm / Edge Band: Platinum
	Kids Soft Seating Group	Fabric: Canter Ink / Laminate: Grey Elm / Edge Band: Platinum
30-31	2-Tier & 3-Tier Straight Seats	Side: Crazy Quilt Magenta / Seat : Silverweave Graphite
	2-Tier Inside Wedge	Side: Crazy Quilt Magenta / Seat: Silverweave Cyan
	Pillows	Sula Confetti
32-33	Elevate Steps Soft Seating	Side: Silica Likely Maize / Seat: Silica Cumulus
	Elevate Steps Group	Pattern: Suna Niagra / Solid: Mode Chambray

Page	Product	Fabric / Finish
34-35	Elevate Wind	Fabric: Matka (various colors)
	Elevate Wind Corner Chair	Back: La Scalina Flow / Seat: Marathon Cyan
36-37	Elevate Wind Soft Seating	Faux Felt Graphite
	Elevate Wind Group	Pattern: Villa Cherry, Villa Cornflower, Villa Goldenrod / Solid: Continuum Lipstick, Continuum Saffron
38-39	Cloud 9 Table	Fabric: Chromatic Terrace / Laminate: Low Line / Edge Band: Platinum
	Cloud 9 Bench 01	Fringe Zing
	Cloud 9 Bench 02	Hop Marine
	Cloud 9 Bench 03	Borders Weekend
40-41	Shapes Bench	Wander Laguna
	Shape & Pod Soft Seating	Fuse Pristine
	Table Tops	Laminate: Grey Elm / Edge Band: Platinum
42-43	Shapes Bench Group	Knack Filament
	Creator Soft Seating	Fabric Solid: Millennium Spark, Millennium Pool / Fabric Print: Fanfare Desert Sun, Places Spaces Faces Grey / Laminate: Grey Elm / Edge Band: Platinum
	Creator Soft Seating Group	Half Round: Mensa Tranquil / Rectangle: Scan Ondine / Square Table: Laminate: Asian Sun / Edge Band: Platinum
44-45	Blossom Petal 01	Latitude Aquamarine
	Blossom Center	Mode Caribbean
	Variable Height Ottoman 01	Shibori Jade Green
	Variable Height Ottoman 02	Mayfair Mango
	Blossom Petal 02	Marathon Vivacious
46-47	Blossom Soft Seating	Faux Felt Pool
	Table Tops	Laminate: Grey Elm / Edge Band: Platinum
	Blossom Group	Petal: Marathon Vivacious / Center: Marathon Pollen
48-49	Pouf Stool 01	Well Well Well Pink
	Cloud 9 Bench	Tag Fresco
	Pouf Stool 02	Whit Fable
	Variable Height Ottoman	Silica Strata Fuchsia
50-51	Round Stool	Knack Wave
	Stools & Ottomans	Fuse Pristine
	Table Tops	Laminate: Grey Elm / Edge Band: Platinum
52-53	Soft Sway Rocker 01	Soho Evergreen
	Soft Sway Rocker 02	Sensory Clove
	Akt Lounge Small Ottoman	Soho Koi
	Cocoon Community Table	Putty
	Schoolworks Bookcase	Putty
54-55	Dot Soft Seating Group	Mica II various colors
	Dot Soft Seating	Canter Adobe
	Soft Sway Rockers	Canter Adobe
56-57	Cocoon Soft Seating	Origin Eve
	Laminate Pieces	White
62-63	Privacy Pod Tall 01	Wall: Highline Baltic / Seat: Silica Andy Fusion
	Privacy Pod Short	Wall: Dayspell Wasabi + Origin Citron / Seat: Tides Radiant
	Privacy Pod Tall 02	Wall: Ace Regal / Seat: Canter Citrus
	Double Privacy Pod Short	Wall: Capiz Bluestone / Seat: Caravan Zircon
	Double Privacy Pod Tall	Wall: Classique Aegean / Seat: Float Chalk
64-65	Soft Seating Seat Pads	Marathon Toile
	Seat Pad Group	Marathon + Knack
66-67	Creator Rectangle Bench 01	Marcel Snowdrop
	Creator Rectangle Bench 02	Ludwig Steel

Connect With Us:

 [instagram.com/mooreco_inc](https://www.instagram.com/mooreco_inc)

 [pinterest.com/moorecoinc](https://www.pinterest.com/moorecoinc)

 [facebook.com/moorecoinc](https://www.facebook.com/moorecoinc)

 [linkedin.com/company/mooreco-inc](https://www.linkedin.com/company/mooreco-inc)

 twitter.com/moorecoinc

 [youtube.com/moorecoinc](https://www.youtube.com/moorecoinc)

 [tiktok.com/@moorecoinc](https://www.tiktok.com/@moorecoinc)



MooreCo Inc.

2885 Lorraine Avenue | Temple, TX 76501

p: 800.749.2258 | f: 866.888.7483

www.moorecoinc.com