

V984Q/C981Q Installation Guide

[Ver.1.1]

Contents:

Product Description and Notes _____ Page 1
 Rotation _____ Page 1
 Ventilation Recommendations _____ Page 2
 Carrying Handle Positioning _____ Page 2
 Display Dimensions
 Front, Top, Right Side, Left Side, Bottom _____ Page 3
 Back Side _____ Page 4
 Display Dimensions with stand _____ Page 5
 Optional Stand Dimensions _____ Page 6
 Optional Wall Mount Dimensions _____ Page 7
 Optional Speaker Dimensions (SP-TF1) _____ Page 8
 Compute Module Integration _____ Page 9
 Input Panel _____ Page 10
 ASCII Commands _____ Page 10
 Control Codes _____ Page 11
 Cable Connection _____ Page 11
 Browser Control _____ Page 12



Product Description:

Type:	LCD Display	Dimensions without stand:	86.4" (W) x 49.2" (L) x 3.7" (D)
Resolution:	3840 x 2160	Dimensions with stand:	86.4"(W) x 50.6"(H) x 23.9"(D)
Aspect Ratio:	16:9	Weight without stand:	198.4 lbs. / 90.0kg
EMI:	Class B	Weight with stand:	208.1 lbs. / 94.4kg
Power Consumption:	525W (Max C981Q), 650W (Max V984Q)		
BTU's:	1791.37 BTU/hour (C981Q), 2217.89 BTU/hour (V984Q)		

NOTES:

- This document is intended to be used as a reference guide to supply useful information for a design or installation. It is not intended to be a step-by step procedure for installation.
- Any ceilings or walls must be strong enough to support the monitor and the installation must be in accordance with any local building codes. All mounts should make secure contact to wood studs.
- Distances are in inches, for millimeters multiply by 25.4.
- Distances may vary ±5%.

Tilt Angle and Rotation:

- Below is the maximum angle the monitor can be tilted. Note that the monitor can only be tilted in the landscape position.

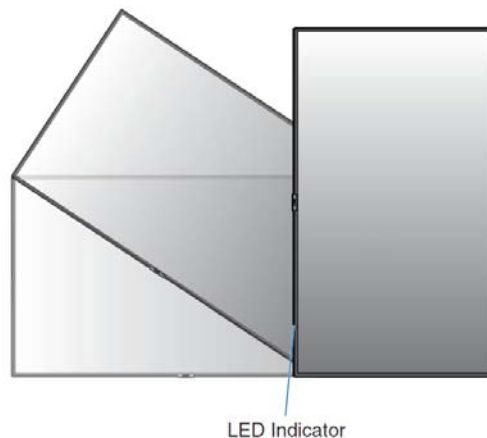

LED Indicator

Ventilation Recommendations:

Dimensions below are minimum required for proper ventilation.

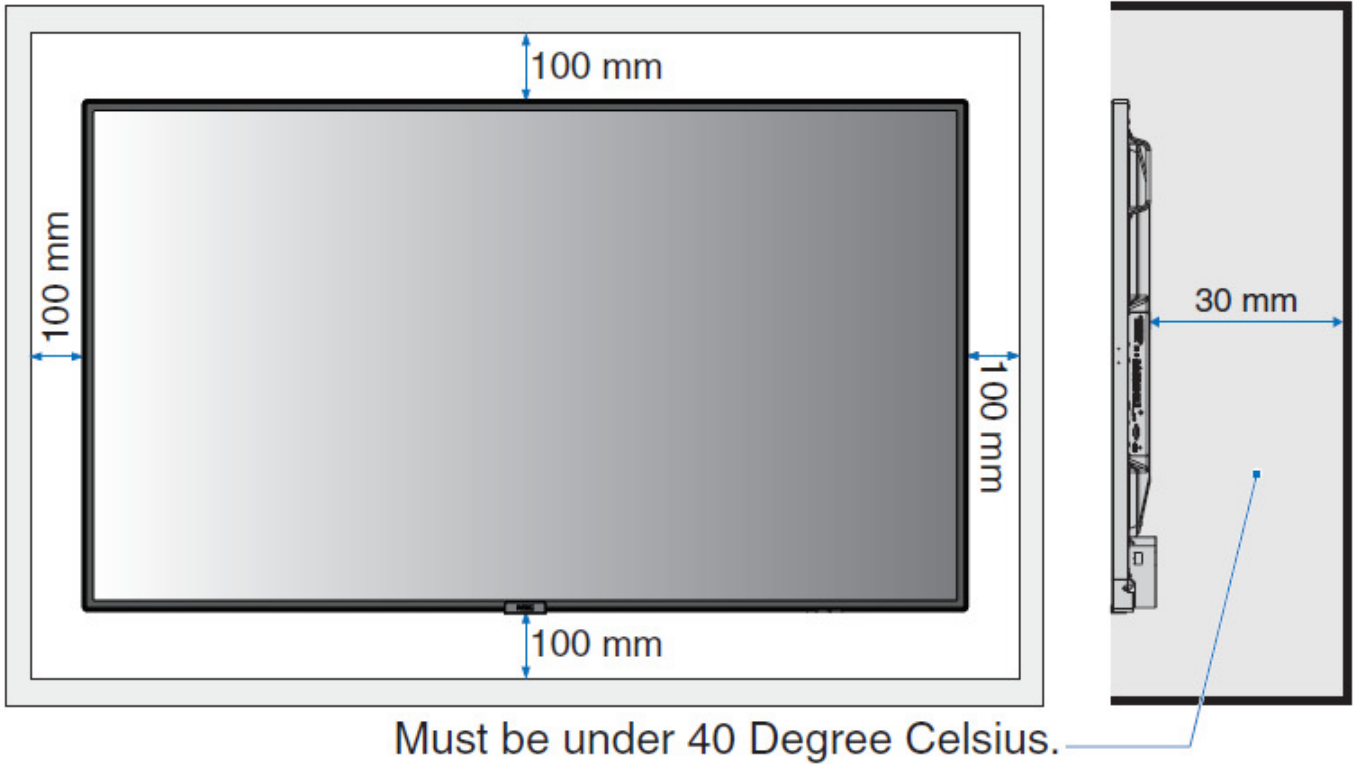

Must be under 40 Degree Celsius.

NOTE:

- The ventilation space should not be covered or closed off at the front of the opening. If for some reason the opening needs to be covered, other means of ventilation will need to be incorporated into the design. Contact NEC for design review and recommendations.

Carrying Handle Positioning:

Changing handles position

◄◄: Factory set position.

◄◄◄: Alternate position.

CAUTION: Four or more handles are required when transporting.

C981Q

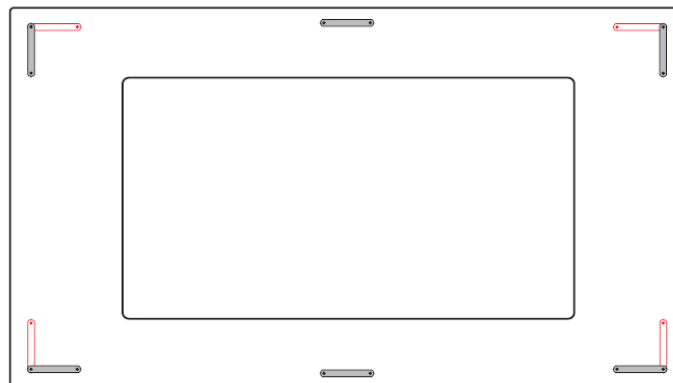

Display Dimensions:

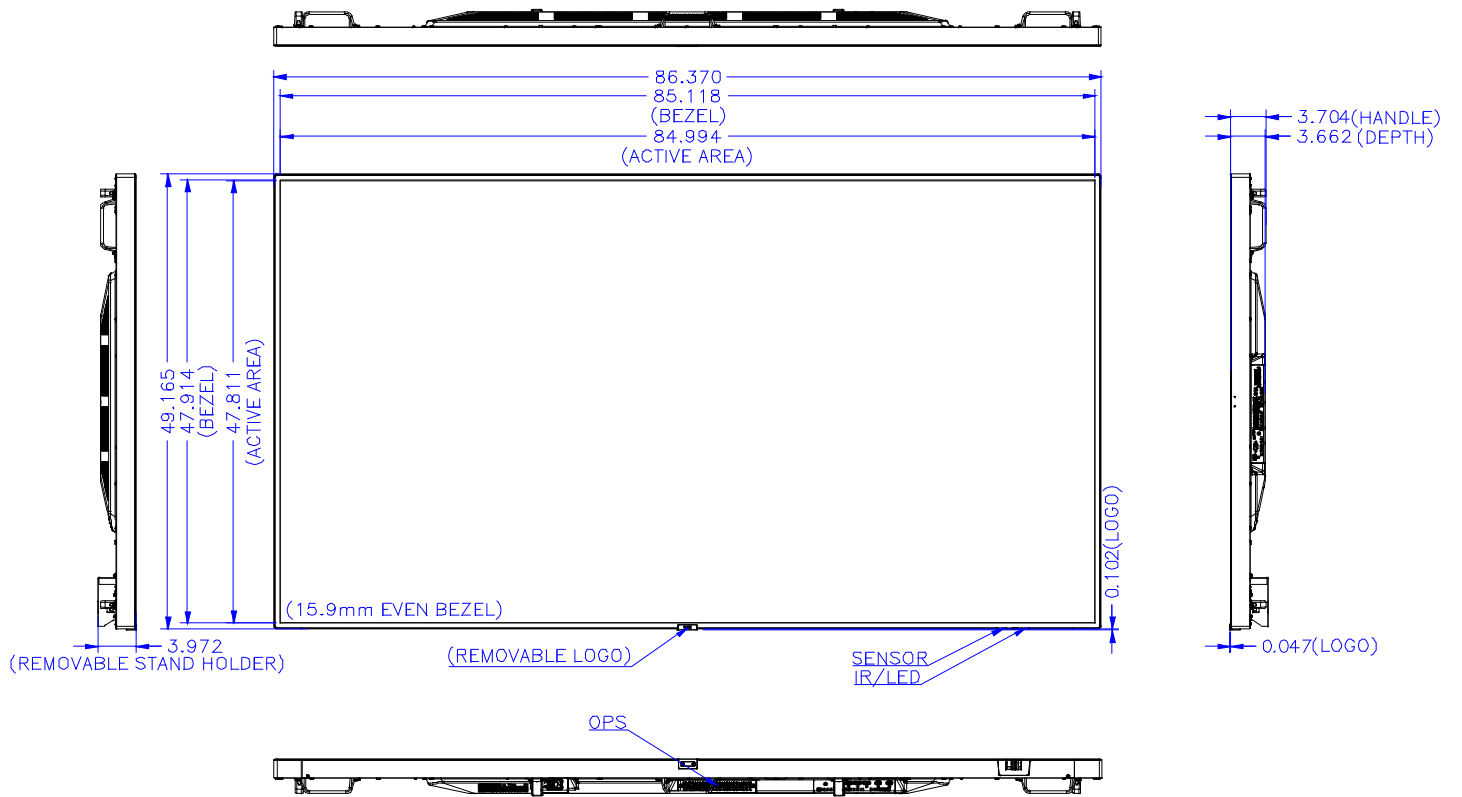

Display Dimensions (cont.):

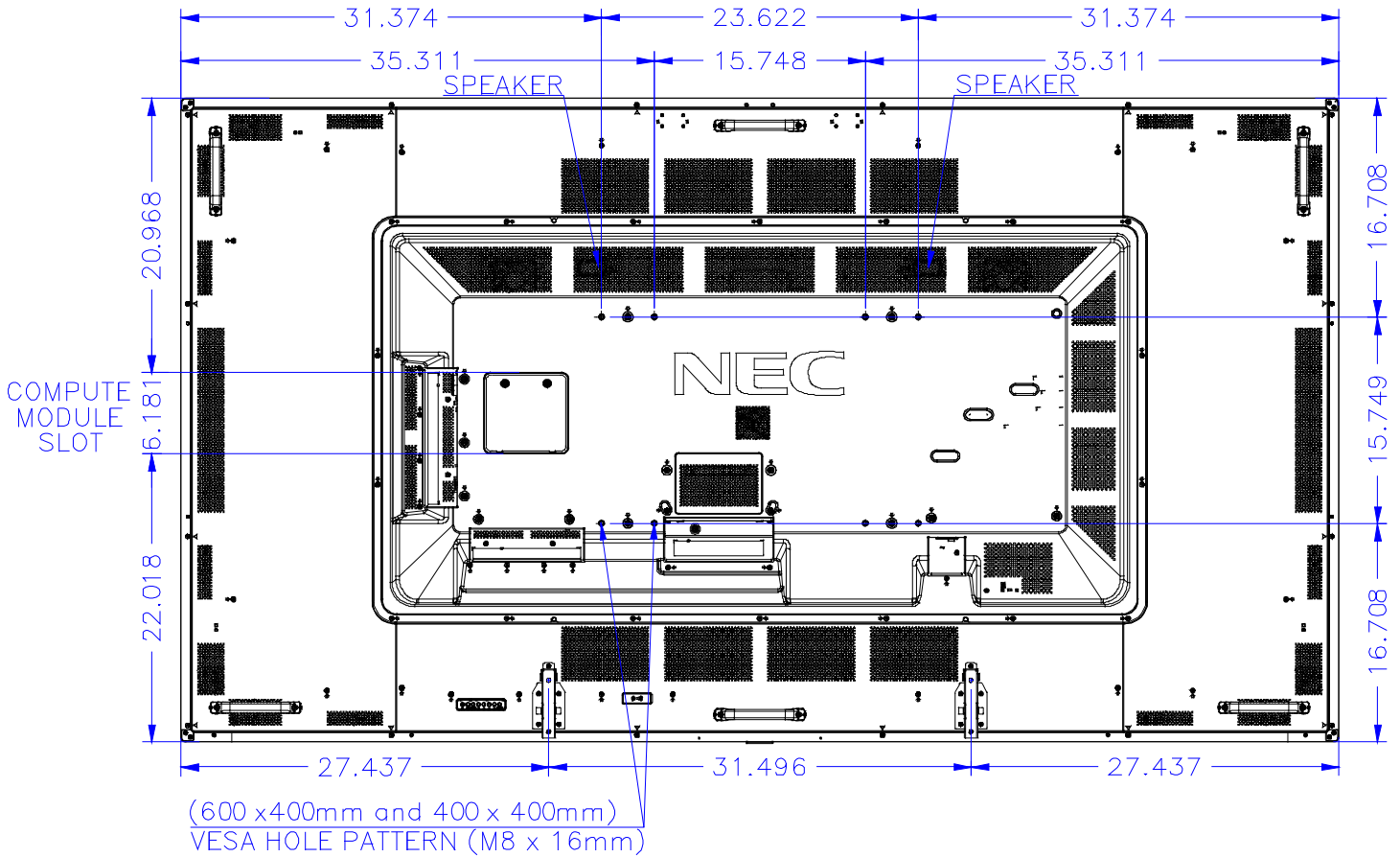

NEC strongly recommends using size M8 screws (15-17mm + the thickness of the bracket and washers in length). If using screws longer than 15-17mm, please check the depth of the hole.

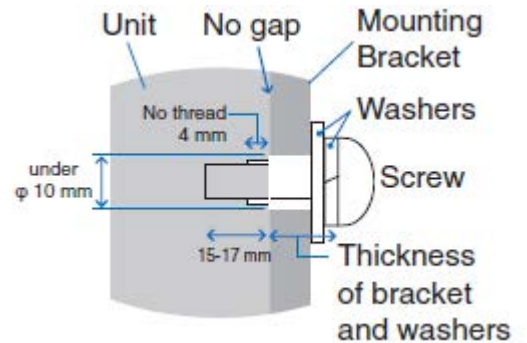

Display Dimensions (with optional ST-801 stand):

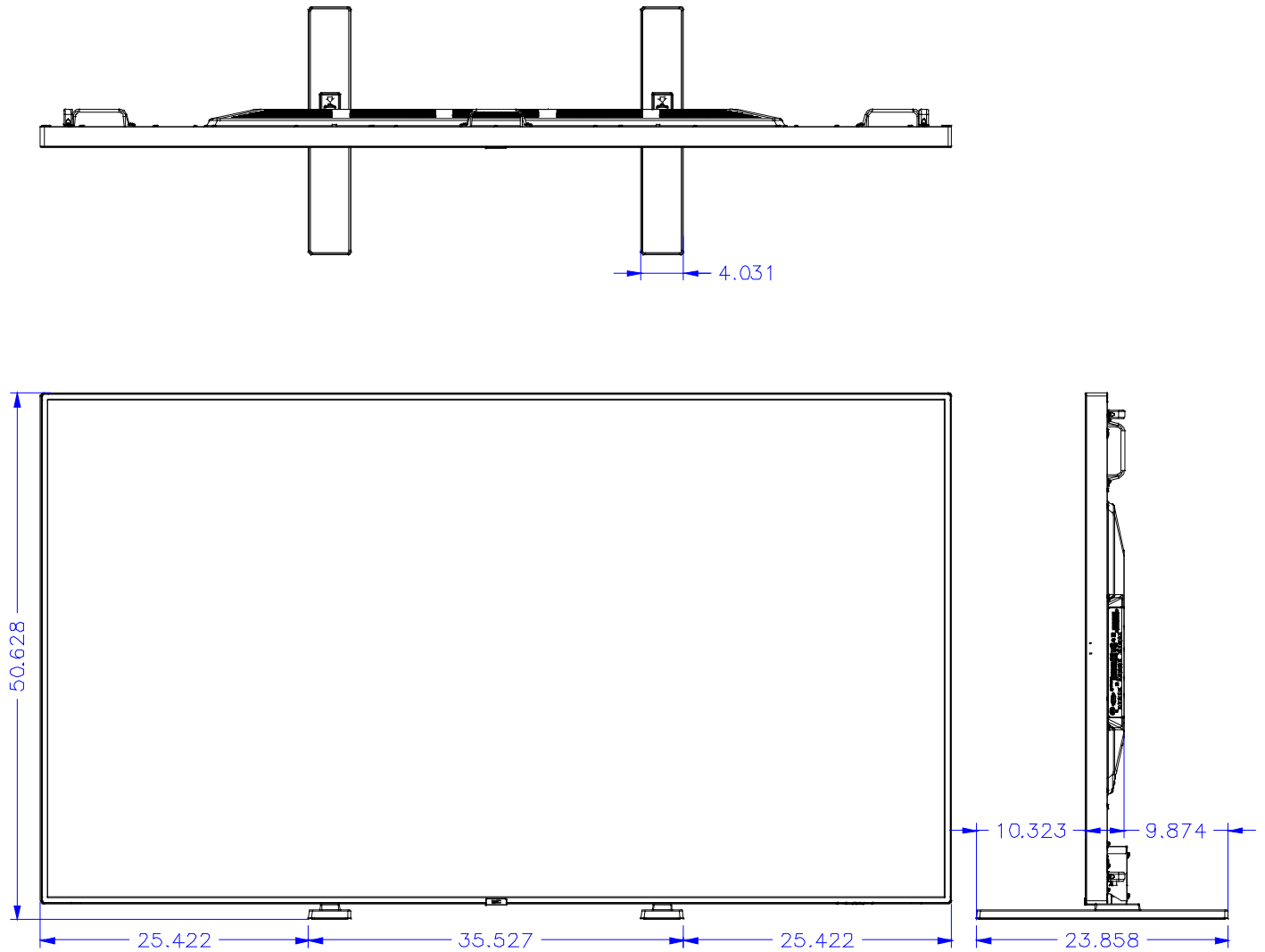
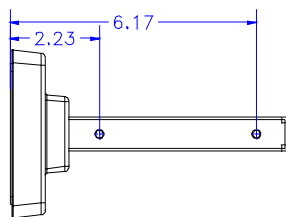
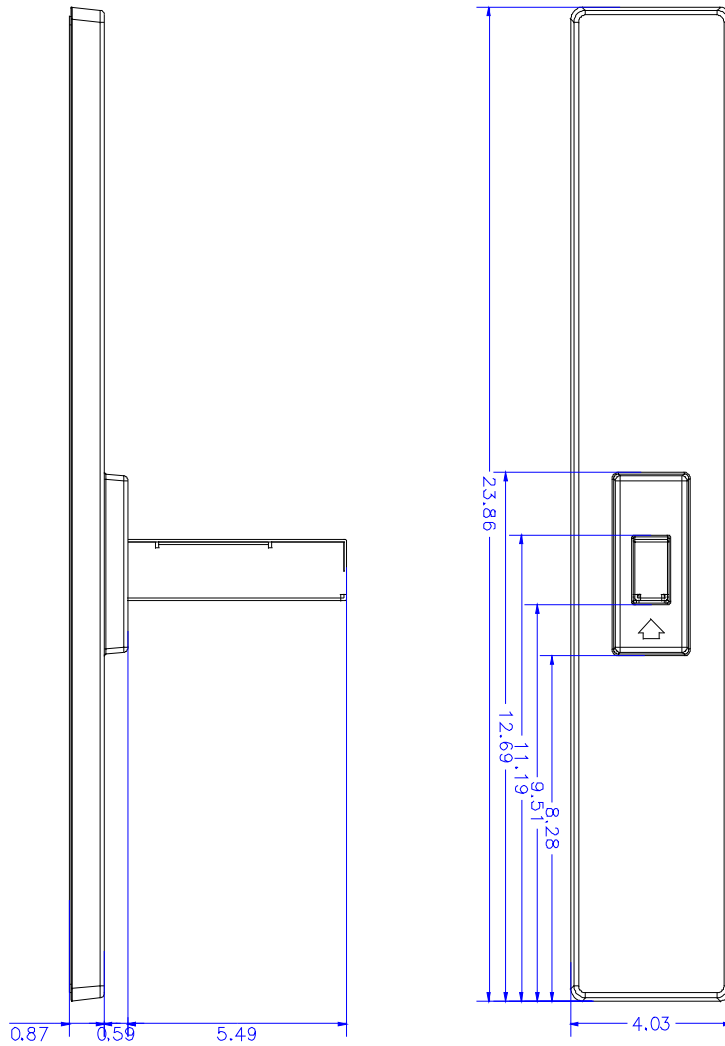
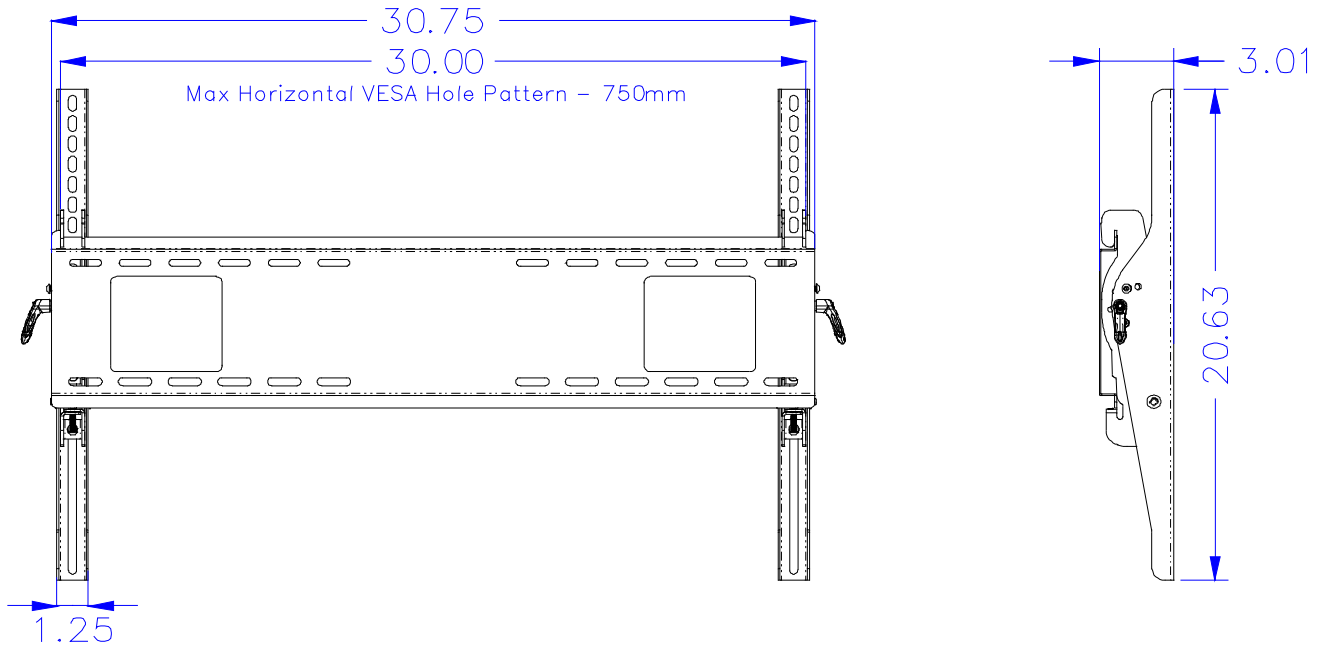

Table Top Stand Dimensions (ST-801):



Optional Large Wall Mount (WMK-6598):



Optional Standard Wall Mount (WMK-3257):

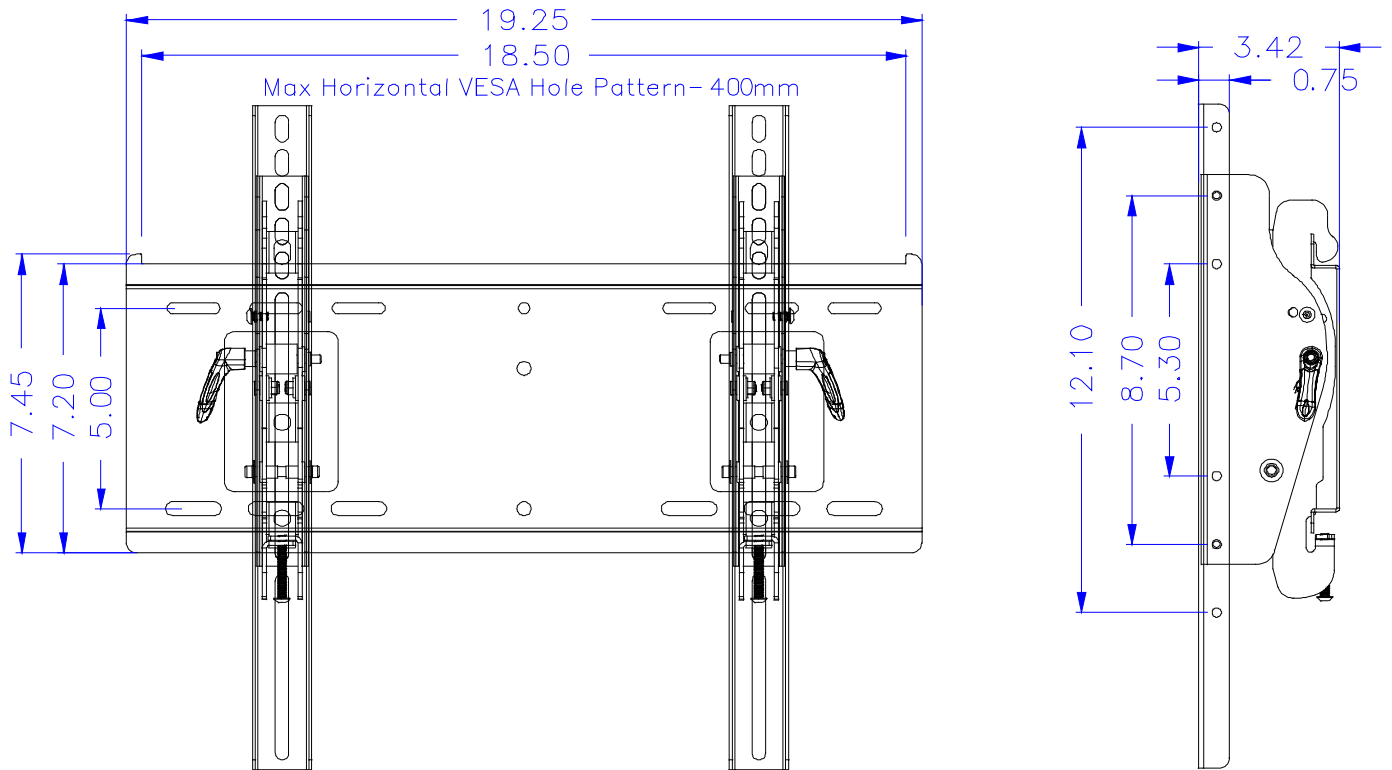

Optional Speaker Dimensions (SP-TF1)

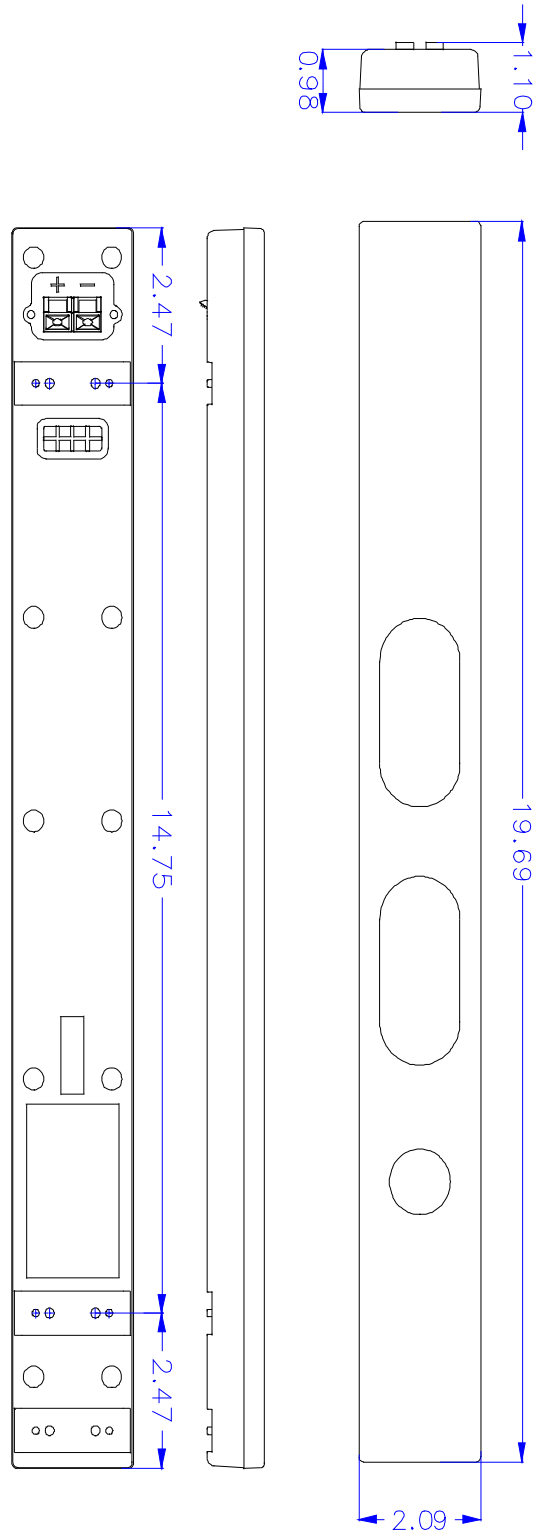

Compute Module Integration:

- Door on the back of the display can be opened by loosening captive screws.
- Separate IO Board is necessary to accompany RPi Compute Module in unit

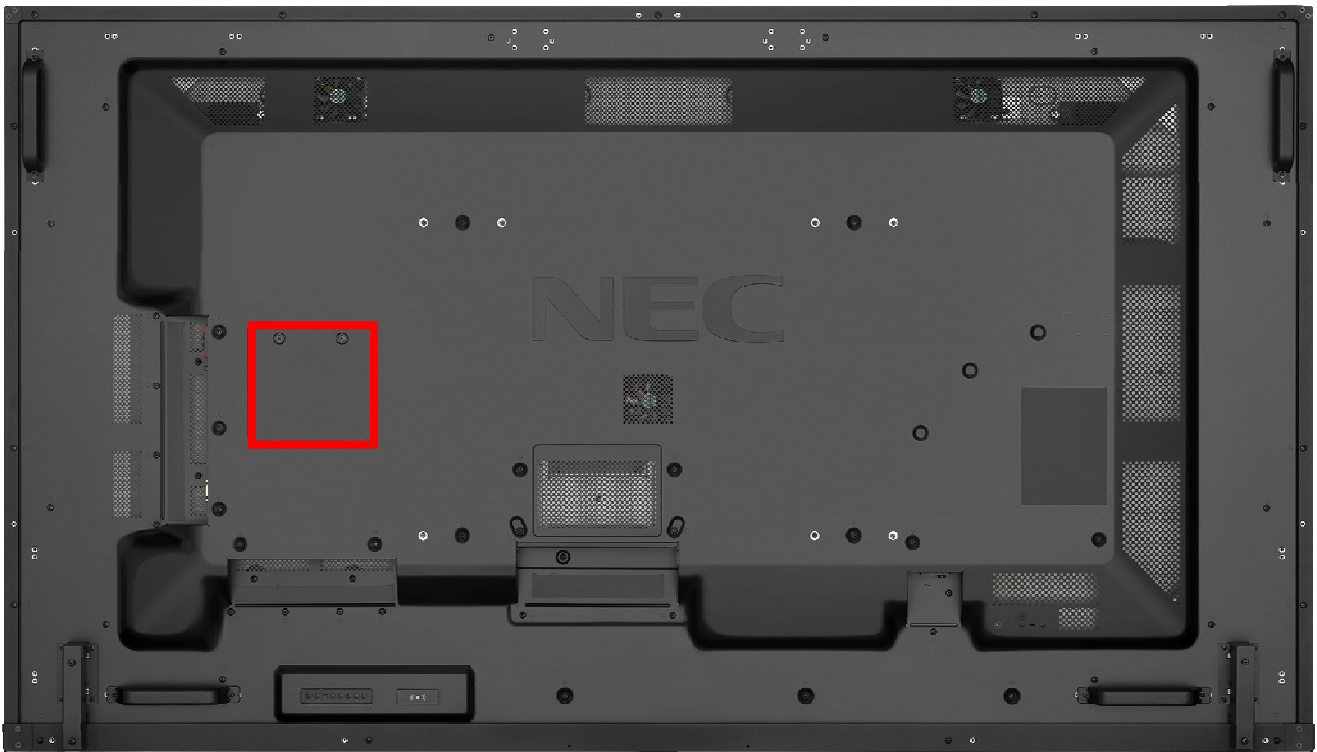

Input Panel:

Bottom



Side (Rotated)



ASCII Common Commands:

- This monitor supports common ASCII control commands with many other NEC projectors. For more information on this, please see our website.

Parameter

Input command

Input signal name	Response	Parameter
DisplayPort1	DisplayPort1	DisplayPort1 or DisplayPort
DisplayPort2	DisplayPort2	DisplayPort2
HDMI1	hdmi1	hdmi1 or hdmi
HDMI2	hdmi2	hdmi2
HDMI3	hdmi3	hdmi3
MP	mp	mp
OPTION	option	option

Status command

Response	Error status
error:temp	Temperature abnormal
error:fan	Cooling fan abnormal
error:light	Inverter or backlight abnormal
error:system	System error

Control Codes:

Function (Monitor ID = 1)	Code Data
Power ON	01 30 41 30 41 30 43 02 43 32 30 33 44 36 30 30 30 31 03 73 0d
Power OFF	01 30 41 30 41 30 43 02 43 32 30 33 44 36 30 30 30 34 03 76 0d
Input Source Select DisplayPort1	01 30 41 30 45 30 41 02 30 30 36 30 30 30 30 46 03 04 0d or 01 30 41 30 45 30 41 02 31 31 30 36 30 30 30 46 03 04 0d
Input Source Select DisplayPort2	01 30 41 30 45 30 41 02 30 30 36 30 30 30 31 30 03 73 0d or 01 30 41 30 45 30 41 02 31 31 30 36 30 30 31 30 03 73 0d
Input Source Select HDMI1	01 30 41 30 45 30 41 02 30 30 36 30 30 30 31 31 03 72 0d or 01 30 41 30 45 30 41 02 31 31 30 36 30 30 31 31 03 72 0d
Input Source Select HDMI2	01 30 41 30 45 30 41 02 30 30 36 30 30 30 31 32 03 71 0d or 01 30 41 30 45 30 41 02 31 31 30 36 30 30 31 32 03 71 0d
Input Source Select HDMI3	01 30 41 30 45 30 41 02 30 30 36 30 30 30 38 32 03 78 0d or 01 30 41 30 45 30 41 02 31 31 30 36 30 30 38 32 03 78 0d
Input Source Select MP	01 30 41 30 45 30 41 02 30 30 36 30 30 30 38 37 03 7D 0d or 01 30 41 30 45 30 41 02 31 31 30 36 30 30 38 37 03 7D 0d
Input Source Select OPTION	01 30 41 30 45 30 41 02 30 30 36 30 30 30 30 44 03 06 0d or 01 30 41 30 45 30 41 02 31 31 30 36 30 30 30 44 03 06 0d
Sound Mute ON	01 30 41 30 45 30 41 02 30 30 38 44 30 30 30 31 03 09 0d
Sound Mute OFF	01 30 41 30 45 30 41 02 30 30 38 44 30 30 30 32 03 0a 0d

NOTE: Contact your NEC representative for codes not listed.

Cable Connection

Communication Protocol:

Interface: RS-232C
 Communication System: Asynchronous
 Baud Rate: 9600 bps
 Data Length: 8 bits
 Parity: None
 Stop Bit: 1 bit
 Communication Code: ASCII

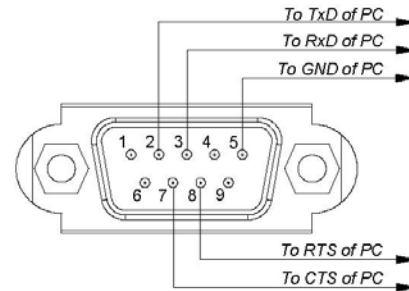

Interface: Ethernet (CSMA/CD)
 Communication System: TCP/IP (Internet Protocol Suite)
 Communication Layer: Transport layer (TCP)
 IP Address: 192.168.0.10 (default out of box)
 Port Number: 7142 (Fixed)

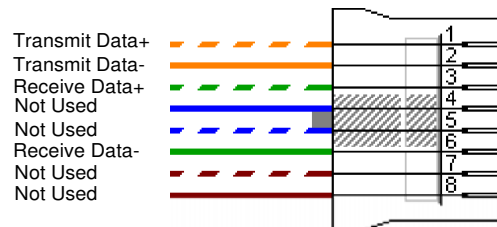

Browser Control:

Information and control can also be available through the HTTP browser control menu.

In order to accomplish this, type: **http://<the Monitor's IP address>/pd_index.html**

Note that the LAN Power needs to be turned on in order for the display to be controlled while the units are off.

All displays are set to the IP address 192.168.0.10 out of the box

Communicating network PC needs to be on the same subnet as display that is being communicated with



HDMI1

- [HOME](#)
- [REMOTE CONTROL](#)
- [PICTURE](#)
- [ADJUST](#)
- [AUDIO](#)
- [SCHEDULE](#)
- [MULTI PICTURE CONTROL](#)
- [OSD](#)
- [MULTI DISPLAY](#)
- [DISPLAY PROTECTION](#)
- [EXTERNAL CONTROL](#)
- [ADVANCED OPTION1](#)
- [ADVANCED OPTION2](#)
- [NETWORK](#)
- [MAIL](#)
- [SNMP](#)
- [AMX](#)
- [CRESTRON](#)
- [NAME](#)
- [NETWORK PASSWORD](#)
- [PD LIST](#)
- [MEMO](#)
- [UPDATE FIRMWARE](#)
- [PORT](#)
- [UPDATE FIRMWARE\(ALL\)](#)

HOME

Welcome to the management and configuration web interface.
You can use the navigation menus on the left to access additional pages.

MONITOR INFORMATION

MODEL NAME	
SERIAL	45S00005TA

FIRMWARE VERSION

FIRMWARE1	0.017
FIRMWARE2	0.008
FIRMWARE3	0.011
FIRMWARE4	0.002

ETHERNET

MAC ADDRESS	58:C2:32:33:00:03
IPv4 ADDRESS	192.168.0.10
SUBNET MASK	255.255.255.0
DEFAULT GATEWAY	0.0.0.0
DNS PRIMARY	0.0.0.0
DNS SECONDARY	0.0.0.0

ID

Copyright © NEC Display Solutions, Ltd. 2014. All rights reserved.