

FTT718-UV, FTT718-USB-UV
FTT724, FTT724-USB, FTT724-699
FTT726-UV, FTT726-USB-UV
FTT730-699-UV
FTT732, FTT732-USB, FTT736-699

Tech Tub² Modular Cart System



Assembly Guide

FTT718, 724, 726, 730, 732, 736_2021_B

Check out our other products online at
www.copernicused.com

For assistance, please contact us:

1-800-267-8494

Email info@copernicused.com

Have your packing slip ready for reference

WARNING



- This product is meant to be assembled by an adult.
- In its unassembled state, small parts present a hazard.
- To be used under direct supervision of an adult.

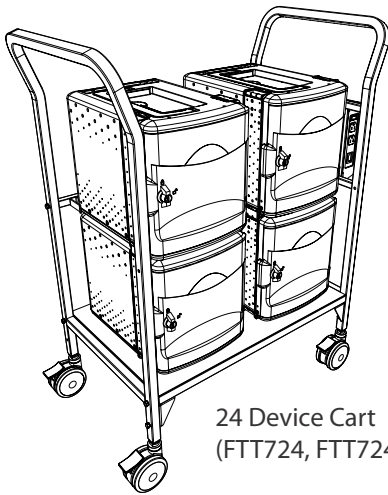

24 Device Cart
(FTT724, FTT724-USB, FTT7249-699)

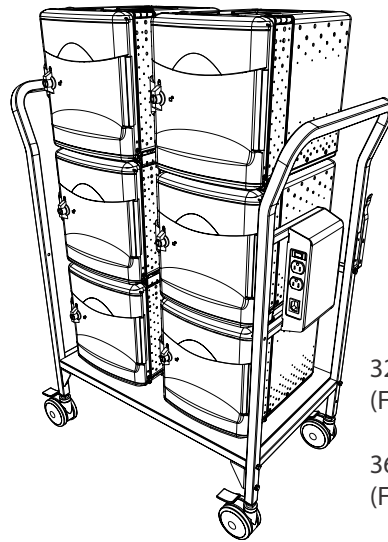

32 Device Cart
(FTT732, FTT732-USB)

36 Device Cart
(FTT736-699)

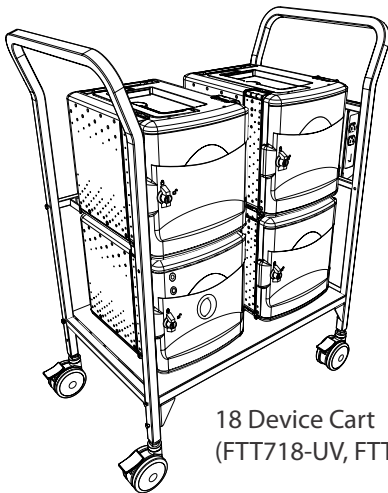

18 Device Cart
(FTT718-UV, FTT718-USB-UV)

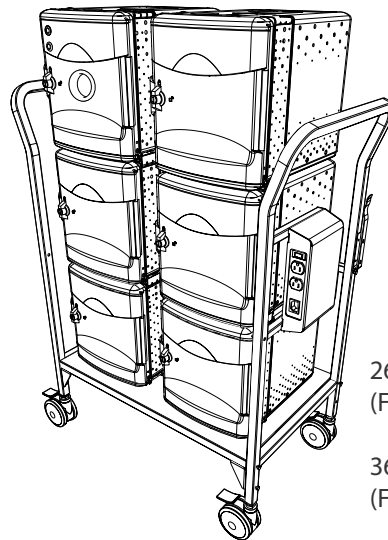

26 Device Cart
(FTT726-UV, FTT726-USB-UV)

36 Device Cart
(FTT730-699-UV)



Please Recycle

Tech Tub²® Modular Cart System



Assembly Guide

FTT718, 724, 726, 730, 732, 736_2021_B

Check out our other products online at
www.copernicused.com

For assistance, please contact us:

1-800-267-8494

Email info@copernicused.com

Have your packing slip ready for reference

Dear Educator,

Thank you for purchasing the Tech Tub 2[®] Modular Cart. We hope it meets all your expectations and you and your students enjoy using it in your school.

If you have any questions, concerns or ideas on how we can improve please let us know by contacting our Customer Solutions Ninjas at 1-800-267-8494 or info@copernicused.com.

Happy teaching,

Kaylyn Belcourt
President

We do not inherit the earth from our ancestors, we borrow it from our children.

NATIVE AMERICAN
PROVERB

Change is the end result of all true learning.

LEO BUSCAGLIA

What you leave behind is not what is engraved in stone monuments, but what is woven into the lives of others.

PERICLES

Education is the most powerful weapon which you can use to change the world.

NELSON MANDELA

Lifetime

Tech Tub2 & Cart
Components
Warranty

Register your Product

Registering your warranty ensures we have all the information we need to make any future warranty claims quick and easy. Please visit www.copernicused.com/warranty and complete the form within 10 business days from product assembly. By registering your product, you will be entered into a draw to win Copernicus product.

Lifetime

UV Tech Tub
Component
Warranty

Make a Warranty Claim

We offer a Lifetime Warranty on almost everything we make. Please call 1-800-267-8494 or email info@copernicused.com to start your warranty claim. Proof of purchase will be required upon warranty claim (i.e. copy of invoice).

1 Year

UV Bulbs &
Electrical
Components



Warning! Hazard Risks!

Please read the warnings below for important safety information regarding your product. Failure to read these warnings or to follow the instructions below could result in personal injury or damage to your product that could void your warranty.



Small
Parts

In its unassembled state, this product contains parts that can be hazardous to small children. This product should be assembled by an adult.



Adult
Supervision

This product is to be used under the supervision of an adult.



Indoor Use
Only

This product is intended for indoor use only. To reduce the risk of fire or electric shock, do not expose this product to rain or moisture. The internal components are not sealed from the environment.



Power Strip
Specifications

Read your power strip electrical specifications. Only plug in devices that are approved for use with this power strip. Connect the supplied power strip directly to a wall outlet. **Do not connect to another power strip or use an extension cord.** Unplug when not in use. **Do not leave this product plugged in for more than 72 consecutive hours.** Turn off power strip before unplugging.

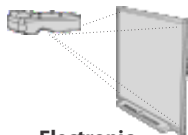

Electronic
Equipment

Read the electrical specifications of any electronic equipment you are using with your Copernicus products. Failure to read these specifications and follow their instructions could result in damage to your equipment or personal injury.



Cable Trip
Hazard

Ensure that any cables extending across the floor to your product are properly bundled and marked to avoid tripping or falling which may lead to personal injury.



Electrical Shock

Do not install or use the electrical components of this unit during a lightning storm.



Climb Hazard

Do not climb on, hang from or suspend objects from any components of your product unless otherwise specified.

Tech Tub² Modular Cart System

Before beginning, you should have:

Contents - FTT401-0

Left Handle
1x

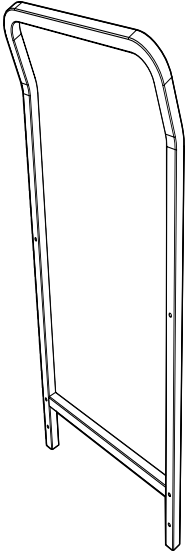

Cart Base
1x

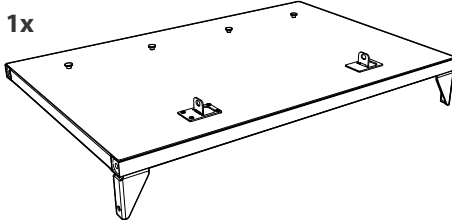

Cable Hook Stretcher
1x

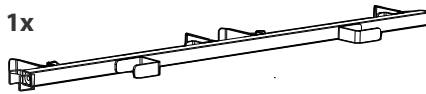

Power Timer
Mounting Bracket
1x

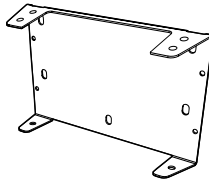

Power Timer
Cover
1x

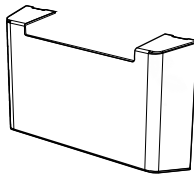

4" Twin Wheel
Locking Caster
4x

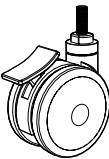

Spring Steel
Cable Hook
1x

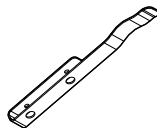



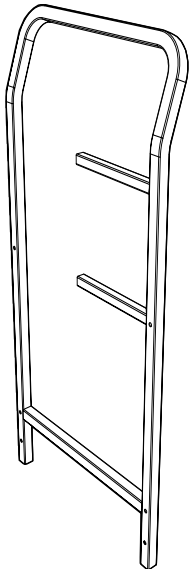



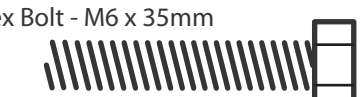

Right Handle
1x

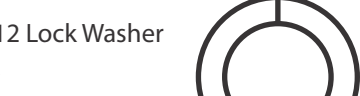

In Box 1

Hardware Actual Size

- (A) Hex Bolt - M6 x 40mm
6x 
- (B) Hex Bolt - M6 x 35mm
2x 
- (C) Hex Bolt - M5 x 15mm
4x 
- (D) Allen Key Screw - M5 x 15mm
2x 
- (E) M6 Star Washer
18x 
- (F) M12 Lock Washer
4x 
- (G) M12 Flat Washer
4x 
- (H) M5 Thumb Nut
4x 
- (I) M6 x 10mm
Thumb Screw
2x 
- (J) Zip Tie
2x 

Caster Wrench
Not to Scale
1x



8mm/10mm
Hex Wrench
Not to Scale
1x



Allen Key
Not to Scale
1x



FTT700 (2x)

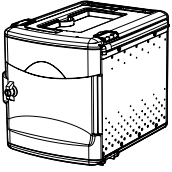

Tech Tub 2[®]
6 Device
Main Body
1x

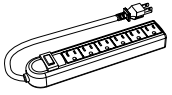

6 outlet
Power Strip
(25515)
1x

FTT700-F (1x)

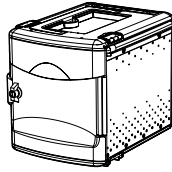

Tech Tub 2[®]
6 Device
Main Body
1x

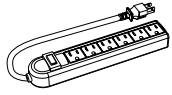

6 outlet
Power Strip
(25515)
1x

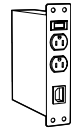

Power
Timer
(25526)
1x



15' Power
Timer Cable
1x

FTT-UV-A (1x)

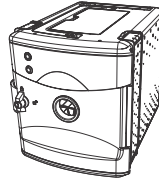

UV Tech Tub
1x

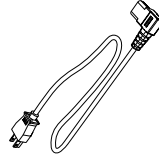

Power Cord
(25528)
1x

FTT700-C (2x)

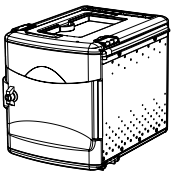

Tech Tub 2[®]
6 Device
Main Body
1x

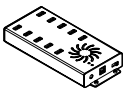

10 Port USB Hub
(255144)
1x



USB "B" Cable
1x

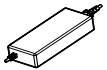

Power Adapter
(255146)
1x



North American
power cord shown.

Power Cord
1x

FTT700-G (1x)

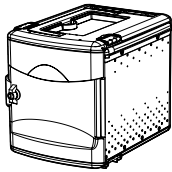

Tech Tub 2[®]
6 Device
Main Body
1x

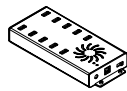

10 Port USB Hub
(255144)
1x



USB "B" Cable
1x

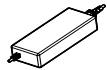

Power Adapter
(255146)
1x



North American
power cord shown.

Power Cord
1x

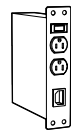

Power Timer
(25526)
1x

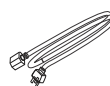

15' Power
Timer Cable
1x

FTT-UV-A (1x)

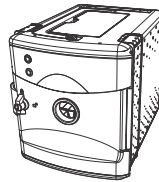

UV Tech Tub
1x

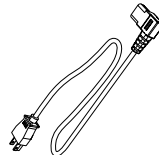

Power Cord
(25528)
1x

FTT724

Tech Tub2® Modular Cart- holds 24 devices

FTT700 (3x)

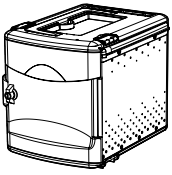

Tech Tub 2®
6 Device
Main Body
1x

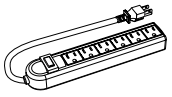

6 outlet
Power Strip
(25515)
1x

FTT700-F (1x)

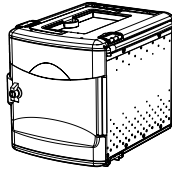

Tech Tub 2®
6 Device
Main Body
1x

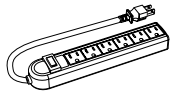

6 outlet
Power Strip
(25515)
1x

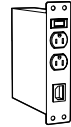

Power
Timer
(25526)
1x



15' Power
Timer Cable
1x

FTT724-USB

Tech Tub2® Modular Cart with sync and charge USB hub - holds 24 iPads

FTT700-C (3x)

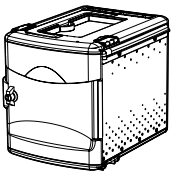

Tech Tub 2®
6 Device
Main Body
1x

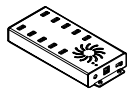

10 Port USB Hub
(255144)
1x



USB "B" Cable
1x

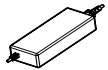

Power Adapter
(255146)
1x



Power Cord
1x

North American
power cord shown.

FTT700-G (1x)

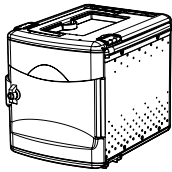

Tech Tub 2®
6 Device
Main Body
1x

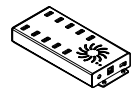

10 Port USB Hub
(255144)
1x



USB "B" Cable
1x

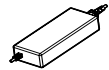

Power Adapter
(255146)
1x



Power Cord
1x

North American
power cord shown.



Power Timer
(25526)
1x

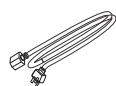

15' Power
Timer Cable
1x

FTT-UV-A (1x)

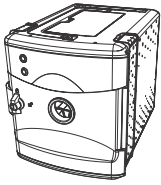

UV Tech Tub
1x

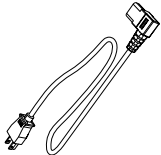

Power Cord
(25528)
1x

FTT700-F (1x)

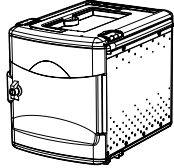

Tech Tub 2[®]
6 Device
Main Body
1x

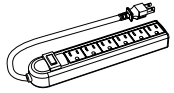

6 outlet
Power Strip
(25515)
1x

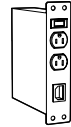

Power
Timer
(25526)
1x

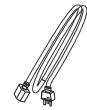

15' Power
Timer Cable
1x

FTT1100 (2x)

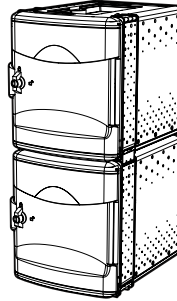

Tech Tub 2[®]
10 Device
Main Body
1x

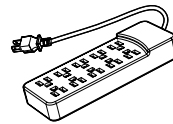

10 outlet
Power Strip
(255159)
1x

FTT-UV-A (1x)

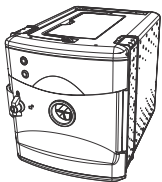

UV Tech Tub
1x

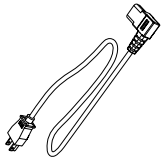

Power Cord
(25528)
1x

FTT700-G (1x)

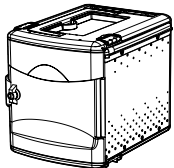

Tech Tub 2[®]
6 Device
Main Body
1x

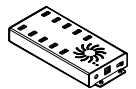

10 Port USB Hub
(255144)
1x



USB "B" Cable
1x

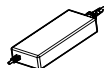

Power Adapter
(255146)
1x



North American
power cord shown.
1x



Power Timer
(25526)
1x



15' Power
Timer Cable
1x

FTT1100-USB (2x)

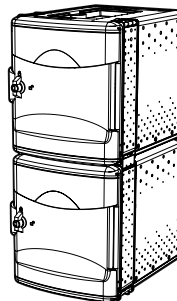

Tech Tub 2[®]
10 Device
Main Body
1x

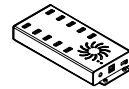

10 Port USB Hub
(255144)
1x



USB "B" Cable
1x

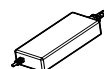

Power Adapter
(255146)
1x



North American
power cord shown.
1x

FTT732

Tech Tub2® Modular Cart - holds 32 devices

FTT700 (1x)

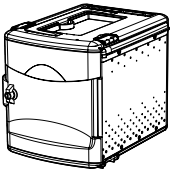

Tech Tub 2®
6 Device
Main Body
1x

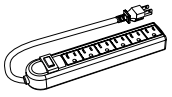

6 outlet
Power Strip
(25515)
1x

FTT700-F (1x)

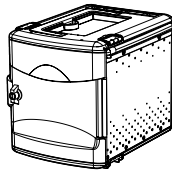

Tech Tub 2®
6 Device
Main Body
1x

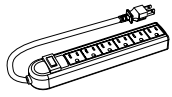

6 outlet
Power Strip
(25515)
1x

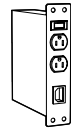

Power
Timer
(25526)
1x



15' Power
Timer Cable
1x

FTT1100 (2x)

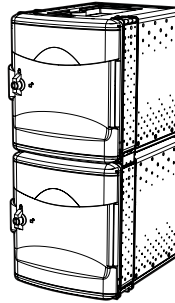

Tech Tub 2®
10 Device
Main Body
1x

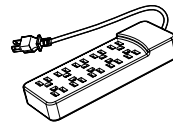

10 outlet
Power Strip
(255159)
1x

FTT732-USB

Tech Tub2® Modular Cart with sync and charge USB hub - holds 32 iPads

FTT700-C (1x)

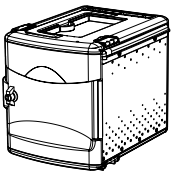

Tech Tub 2®
6 Device
Main Body
1x

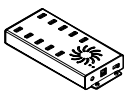

10 Port USB Hub
(255144)
1x



USB "B" Cable
1x

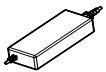

Power Adapter
(255146)
1x



Power Cord
1x

North American
power cord shown.

FTT700-G (1x)

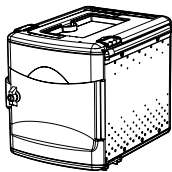

Tech Tub 2®
6 Device
Main Body
1x

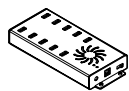

10 Port USB Hub
(255144)
1x



USB "B" Cable
1x

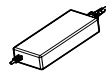

Power Adapter
(255146)
1x



Power Cord
1x

North American
power cord shown.



Power Timer
(25526)
1x

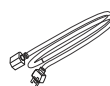

15' Power
Timer Cable
1x

FTT1100-USB (2x)

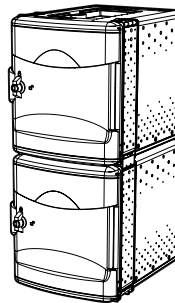

Tech Tub 2®
10 Device
Main Body
1x

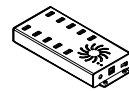

10 Port USB Hub
(255144)
1x



USB "B" Cable
1x

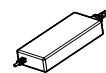

Power Adapter
(255146)
1x



Power Cord
1x

North American
power cord shown.

FTT724-699

**Tech Tub2 Modular Cart for iPads with USB-C 20W Adapter
(holds up to 24 devices)**

FTT699 (3x)

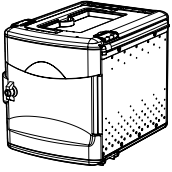

Tech Tub 2®
6 Device
Main Body
1x

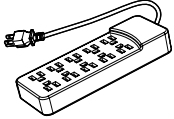

10 outlet
Power Strip
(255159)
1x

FTT699-A(1x)

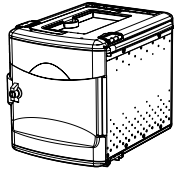

Tech Tub 2®
6 Device
Main Body
1x

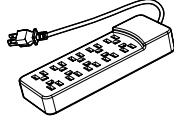

10 outlet
Power Strip
(255159)
1x

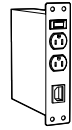

Power
Timer
(25526)
1x



15' Power
Timer Cable
1x

FTT730-699-UV

**Tech Tub2 Modular Cart for iPads with USB-C 20W Adapter
(holds up to 30 devices)**

FTT699 (4x)

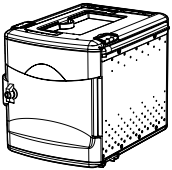

Tech Tub 2®
6 Device
Main Body
1x

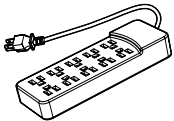

10 outlet
Power Strip
(255159)
1x

FTT699-A(1x)

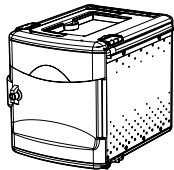

Tech Tub 2®
6 Device
Main Body
1x

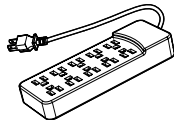

10 outlet
Power Strip
(255159)
1x

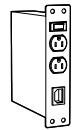

Power
Timer
(25526)
1x



15' Power
Timer Cable
1x

FTT-UV (1x)

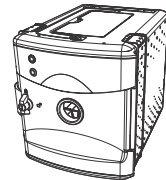

UV Tech Tub
1x

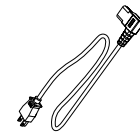

Power Cord
(25528)
1x

FTT736-699

**Tech Tub2 Modular Cart for iPads with USB-C 20W Adapter
(holds up to 36 devices)**

FTT699 (5x)

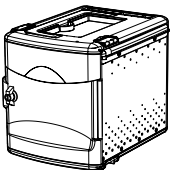

Tech Tub 2®
6 Device
Main Body
1x

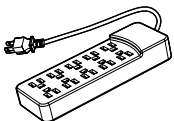

10 outlet
Power Strip
(255159)
1x

FTT699-A(1x)

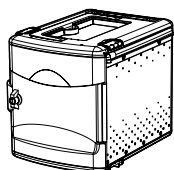

Tech Tub 2®
6 Device
Main Body
1x

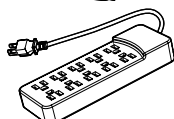

10 outlet
Power Strip
(255159)
1x



Power
Timer
(25526)
1x



15' Power
Timer Cable
1x

Tips for Assembly

Watch for These Helpful Symbols

- This symbol denotes a 2 Person Task. For safety, please ensure that there are the suggested number of people working on steps displaying this symbol.
- Watch for this symbol throughout the Assembly Guide. Wherever you see it, pay close attention. The symbol denotes a step needing extra attention to ensure it is done correctly.
- The star symbol highlights an advisory note.



Before You Begin

- Lay out and identify all of the included parts.
- The hardware has been packed according to **step**.
- Read the assembly guide over once to familiarize yourself with them.



 Please note that in its unassembled state, this product contains parts that can be hazardous to small children. This product should be assembled by an adult.

 Please note, star washers are critical components for electrical safety. Star washers must be included and fasteners fully tightened to prevent the risk of electric shock.



As You Assemble the Unit

- Follow the steps in sequence.
- Before beginning each step, find the part(s) that you need for that step.
- Pay attention to the labels on the parts; they are there to help direct you at certain stages.
- The title of each step states what you will be doing. Review the text and the pictures as you build the unit.

Customer Service - FAQ's



For missing parts and other issues regarding this product:

Please call Copernicus Customer Service, where we will be happy to help.
1-800-267-8494. Monday - Friday 8:30am - 4:30 pm EST.

OR

Email our Tech Support Service at info@copernicused.com

Check out some of our other great products!



www.copernicused.com

Need Tech Support?
Have a Question?



Email our Tech Support Service

1

Actual Size:

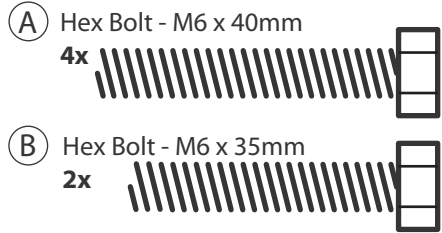

You will need: (Not to Scale)

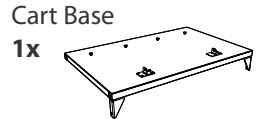
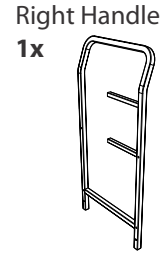
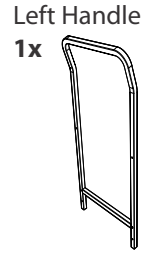

Attach Left Handle and Right Handle to Cart Base

! (E) M6 Star Washer
6x

Please note, star washers are critical components for electrical safety. Star washers must be included and fasteners fully tightened to prevent the risk of electric shock.

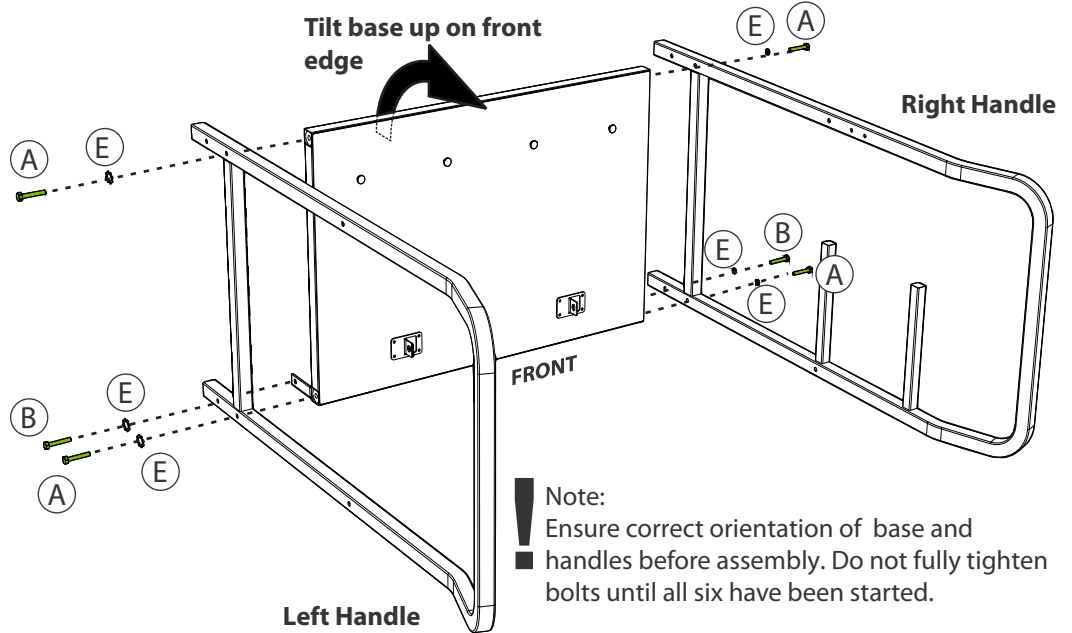

2

Actual Size:

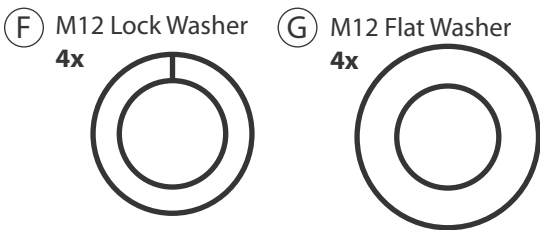

You will need: (Not to Scale)

4" Twin Wheel Locking Caster
4x

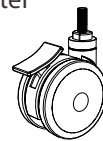

Caster Wrench
1x

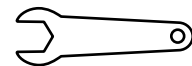

Attach Casters to cart



Lock the casters before installation so you can quickly thread them into the ends of the tube by hand. Use the caster wrench to finish tightening them completely.

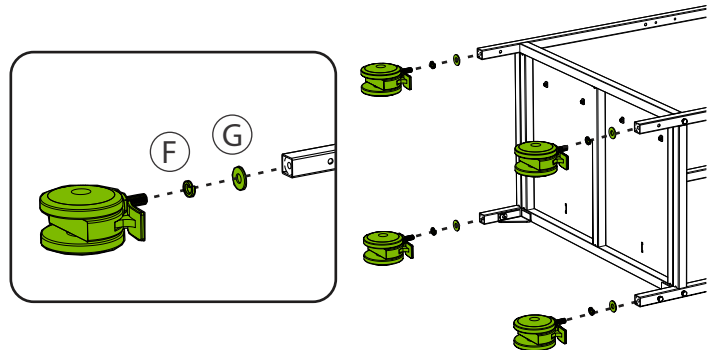
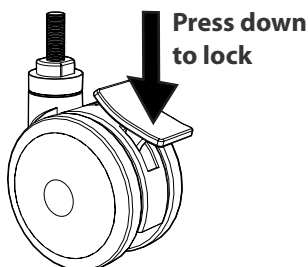

! Note: Return cart to upright position once casters are installed. Check casters every 6 months and tighten as needed.

3

Actual Size:

(A) Hex Bolt - M6 x 40mm
2x



(E) M6 Star Washer
2x



You will need: (Not to Scale)

Cable Hook Stretcher

1x

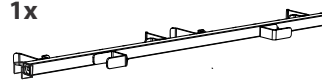

8mm/10mm Hex
Wrench

1x



Fasten Cable Hook Stretcher to Handles

1 Position cable hook stretcher so it aligns with holes on handles



Note:
Ensure cable hooks point toward back of cart.

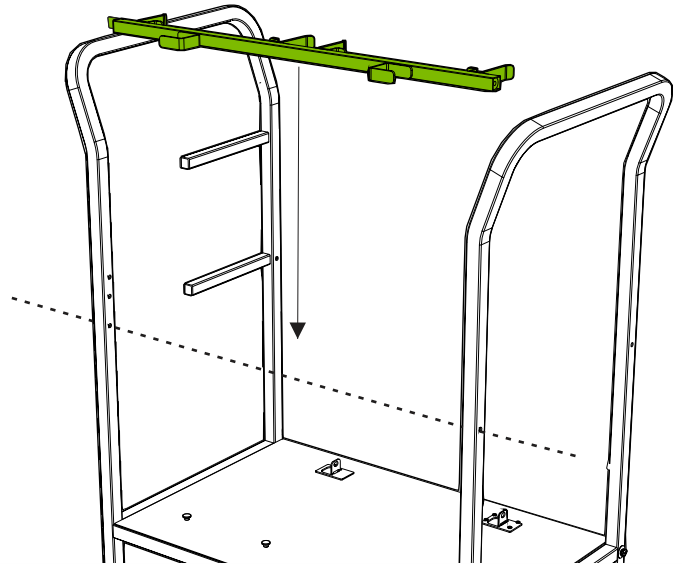
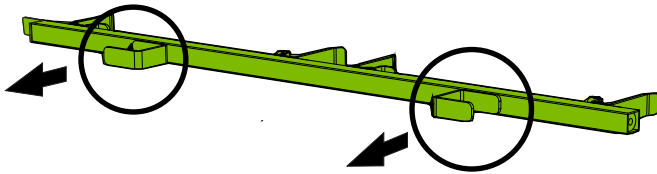

2 Fasten cable hook stretcher to handles

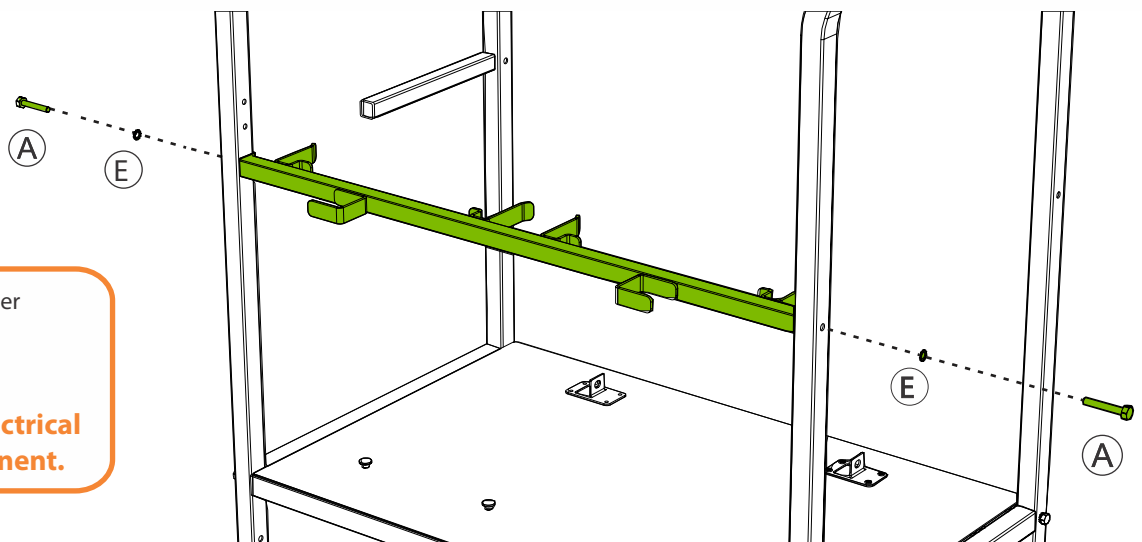

(E) M6 Star Washer
2x



**Important electrical
safety component.**

4

Actual Size:

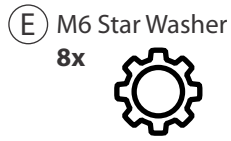
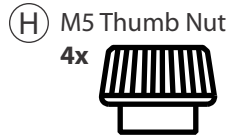

You will need: (Not to Scale)

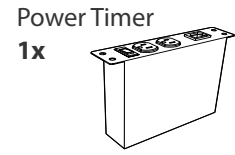
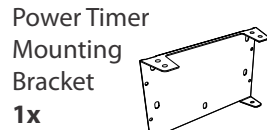

Note:
Power Timer will be shipped
inside one of the Tech Tub boxes

Install Power Timer

1 Fasten mounting bracket to right handle

2 Fasten power timer to mounting bracket



**Important electrical
safety component.**

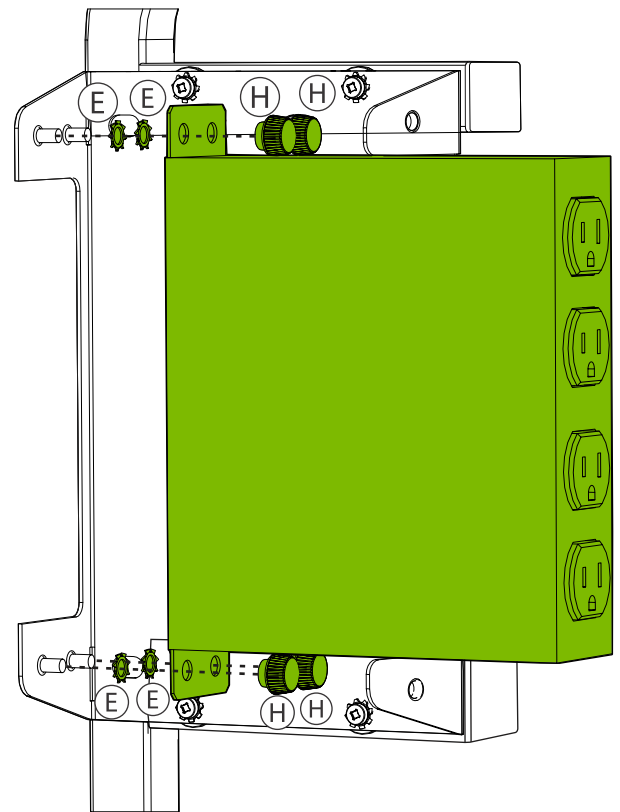
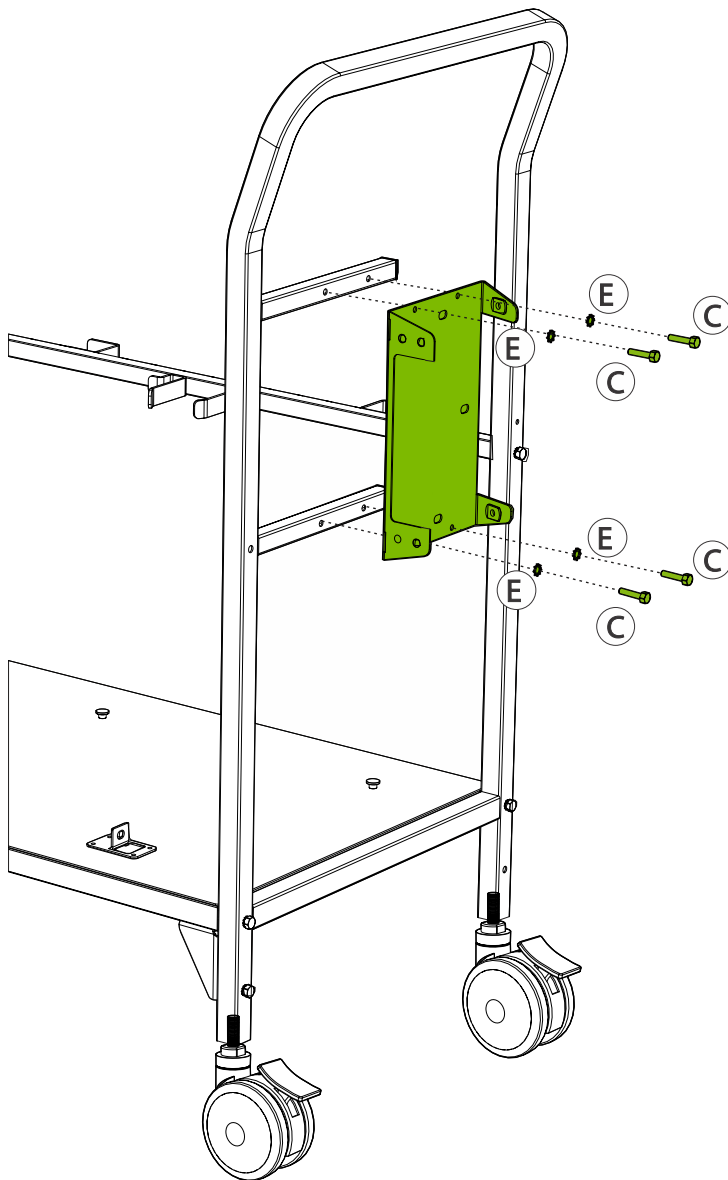
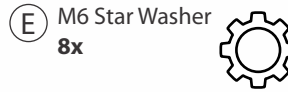

Note:
Ensure the power timer
is mounted in the
correct orientation.

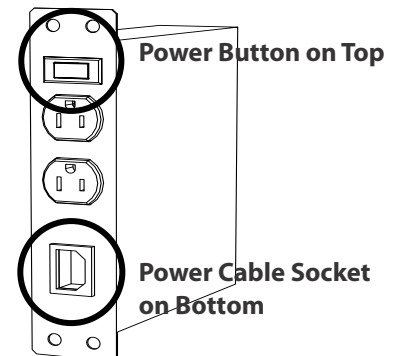

5

Actual Size:

(E) M6 Star Washer
2x



(I) M6 x 10mm Thumb Screw
2x

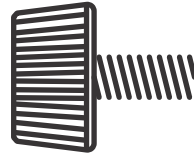

You will need: (Not to Scale)

Power Timer
Cover
1x

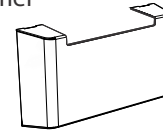

Install Power Timer

1 Hook power timer cover onto mounting bracket

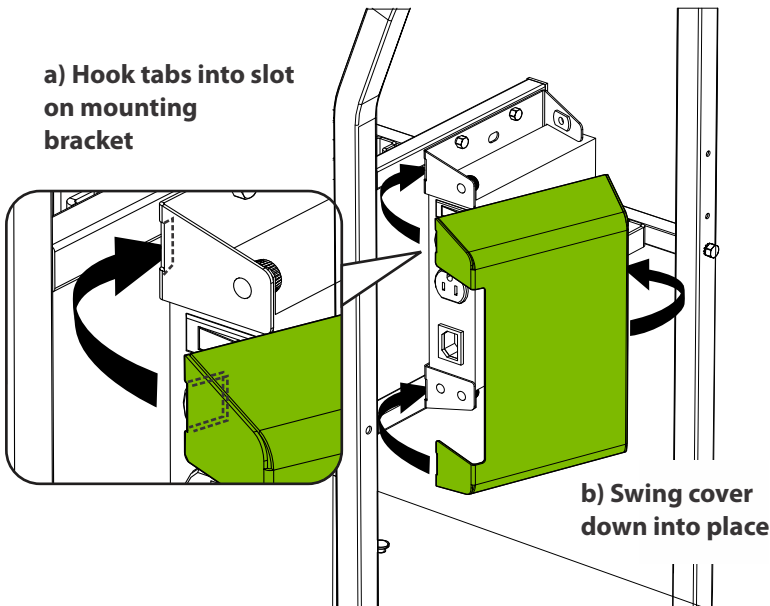

2 Fasten power timer cover to mounting bracket

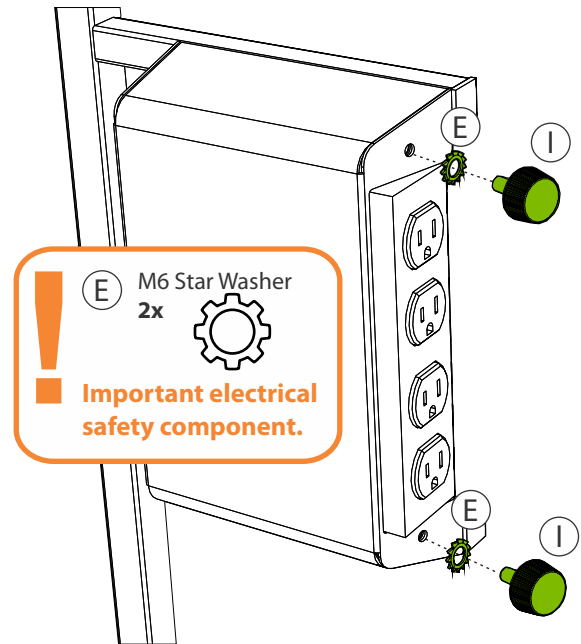

6

Actual Size:

(D) M5 15mm
2x



You will need: (Not to Scale)

Spring Steel
Cable Hook
1x



Allen Key
1x



Install Spring Steel Cable Hook

Fasten to right handle at the back

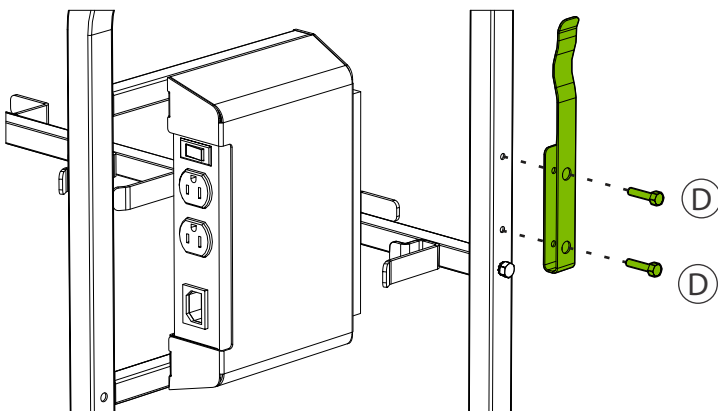

Before proceeding to the next step please check the entire assembly for loose parts; tighten all casters, bolts, screws and nuts.

Tighten all casters using supplied caster wrench.

Keep wrench with unit. Casters must be tightened every 6 months for proper maintenance.

7

You will need: (Not to Scale)

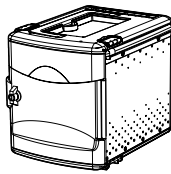

Tech Tub2®
6 Device
2x

OR

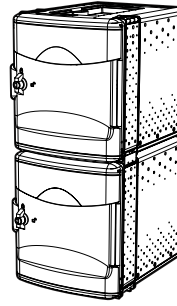

Tech Tub2®
10 Device
2x

Install Tech Tubs onto cart

! Note: Please follow the assembly instructions that accompanied your Tech Tub2® and UV Tech Tub to get it ready for installation on the cart.

★ Lock casters before installing tubs onto cart.

1 Hook rear feet onto pins on the cart base

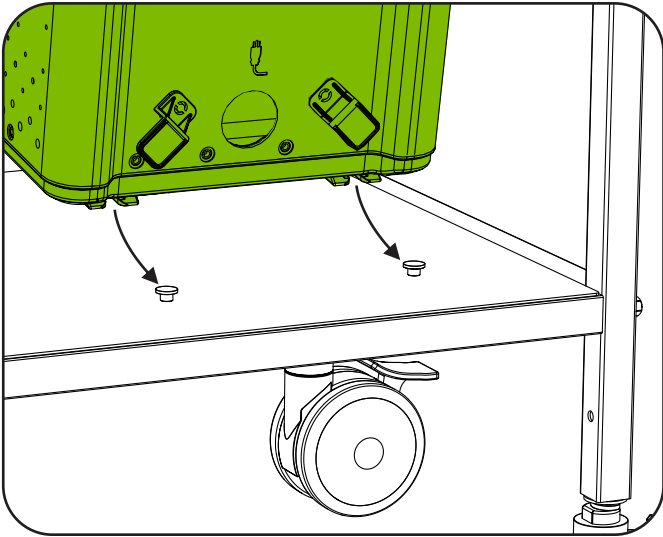

2 Lower front of tub onto metal tab on cart base

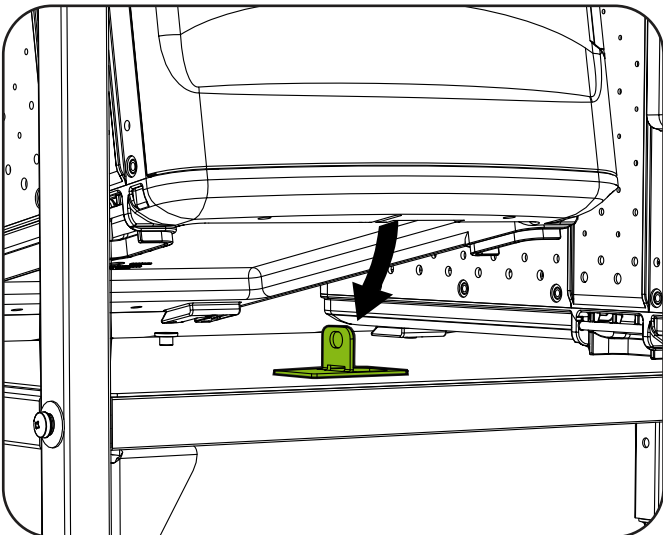

3 Repeat steps 1 and 2 for other side of cart

**18 Device Cart / 24 Device Cart
30 Device Cart / 36 Device Cart**
(FTT718-UV, FTT718-USB-UV, FTT724, FTT724-USB,
FTT724-699, FTT730-699-UV, FTT736-699)

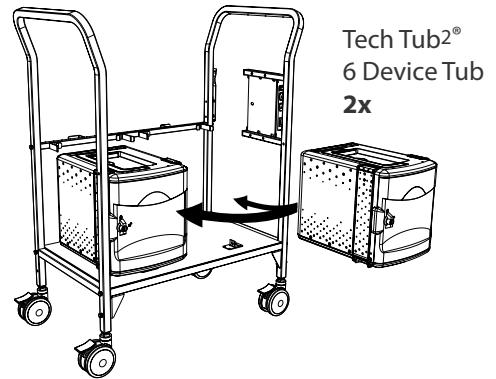

Tech Tub2®
6 Device Tub
2x

OR

26 Device Cart, 32 Device Cart
(FTT726-UV, FTT726-USB-UV, FTT732 or FTT732-USB)

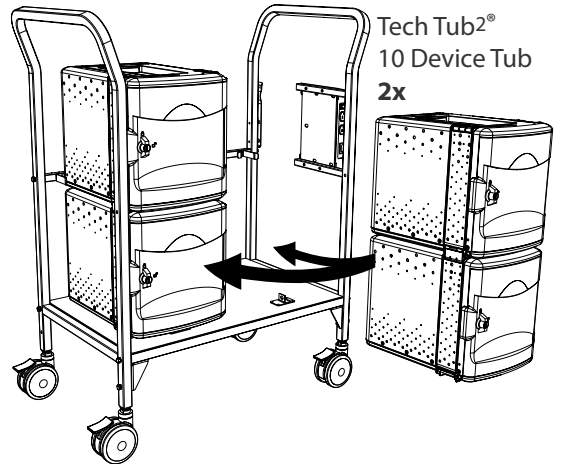

Tech Tub2®
10 Device Tub
2x

! Note: Ensure the 10 Device Tub is always mounted directly to the cart, not stacked on top of a 6 Device Tub.

Continue on next page...

Install Tech Tubs onto cart

- 7 Open front door of Tech Tub and slide metal locking pin through metal tab

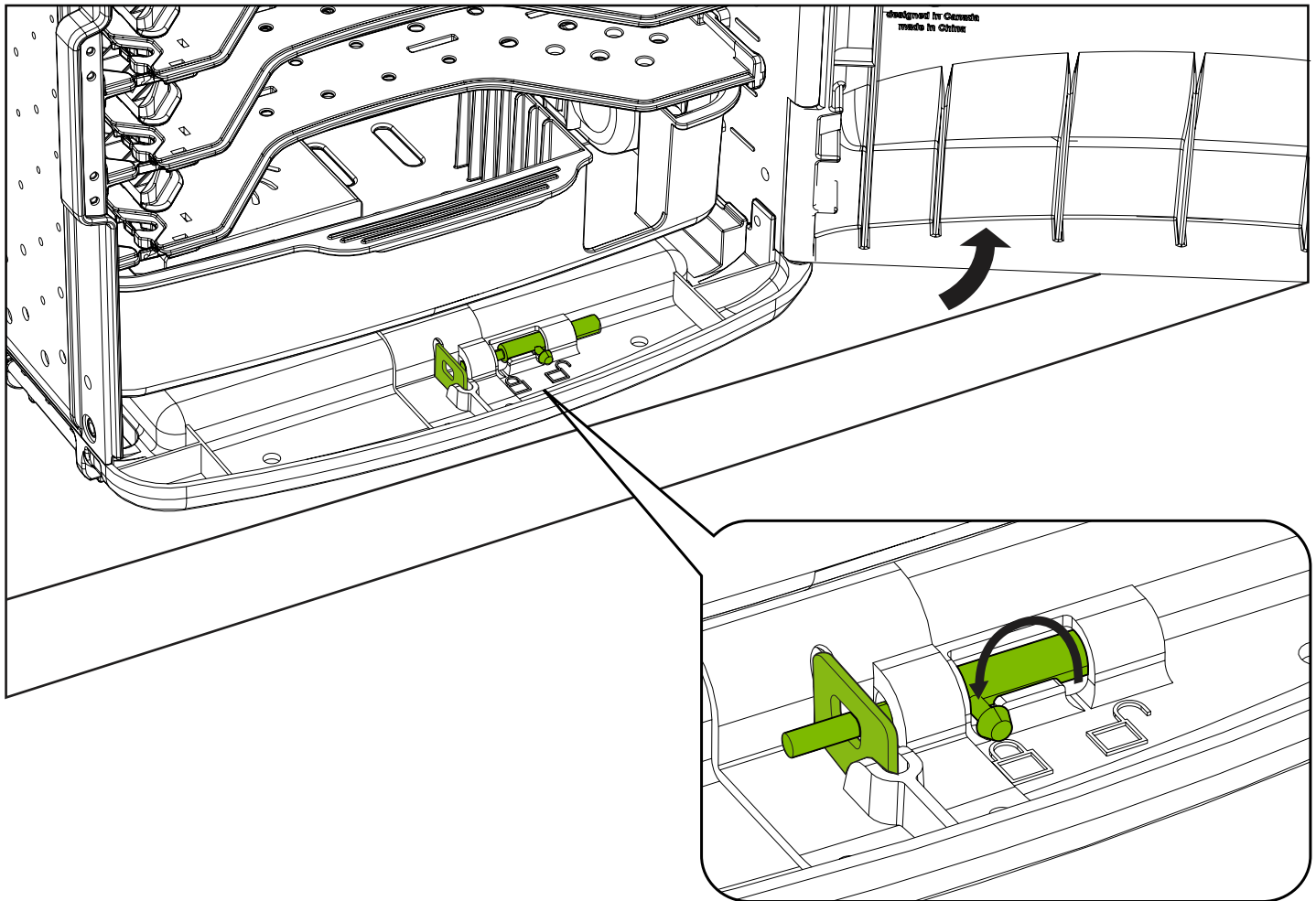

NOTE:

! The locking process is the same for both left and right position on the cart.

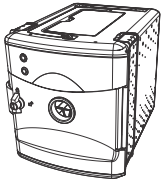

UV Tech Tub
1x
(May not be included with model)

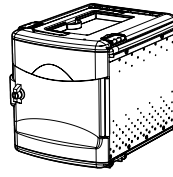

Tech Tub2®
6 Device
1x, 2x, 3x, or 4x
(Quantity depends on model)

Stack remaining tubs onto the cart

Refer to the next page for tub stacking configurations

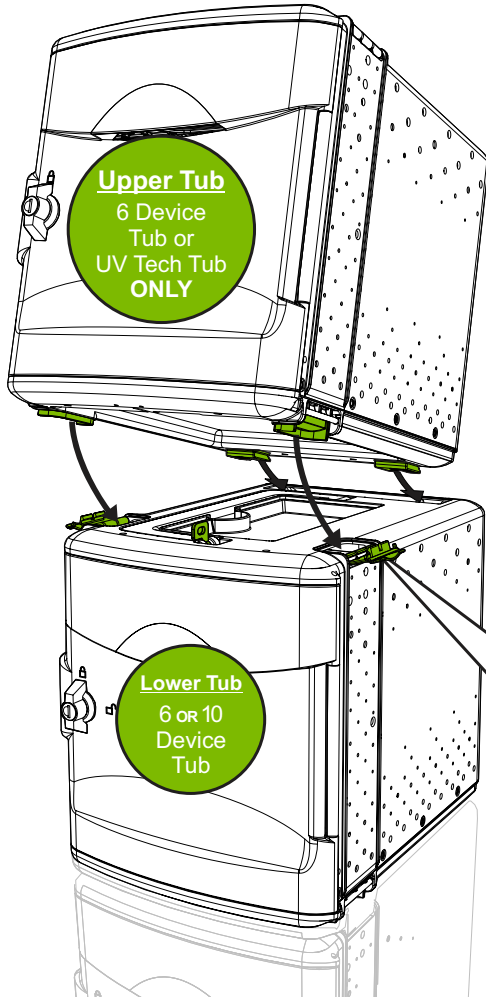

- 1 Flip up locking tab and open side flip locks on lower tub

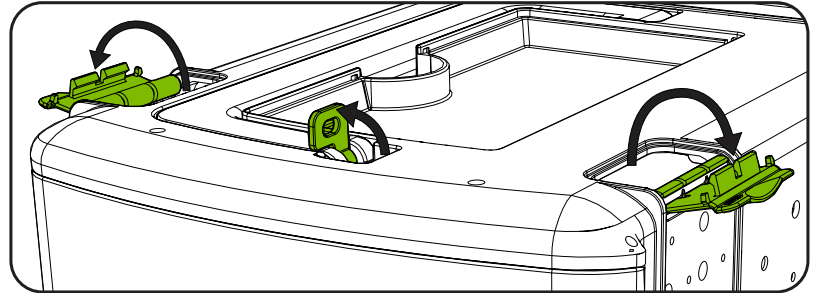

- 2 Insert back feet of upper tub into slot on top of lower tub

- 3 Insert front feet of upper tub into holes on top of lower tub

- 4 Connect upper and lower tub using side flip locks

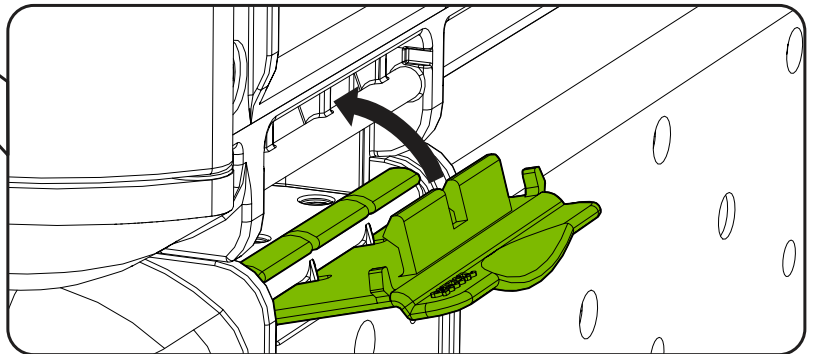

- 5 Open the front door of upper tub and slide locking pin through metal tab

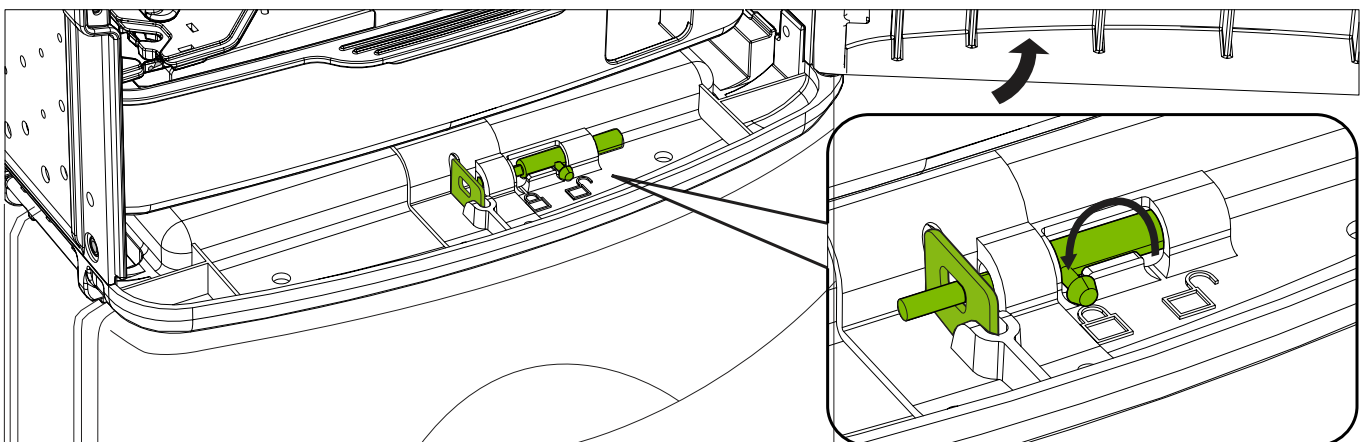

- 6 Close and lock front door of tub to secure devices



Please see below for completed configurations

6 6 device Tech Tub

10 10 device Tech Tub

UV UV Tech Tub

18 Device Cart:

(FTT718-UV, FTT724-USB-UV)

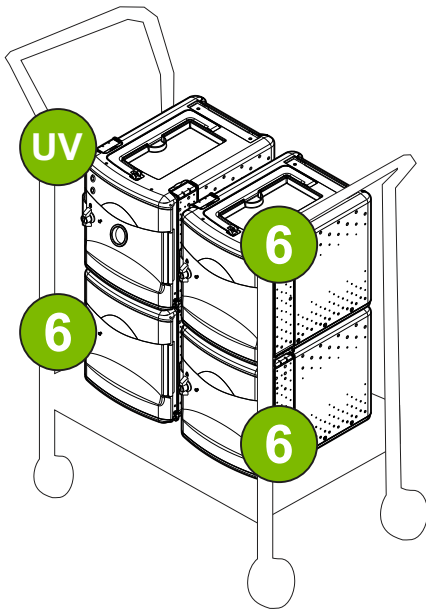

24 Device Cart:

(FTT724, FTT724-USB, FTT724-699)

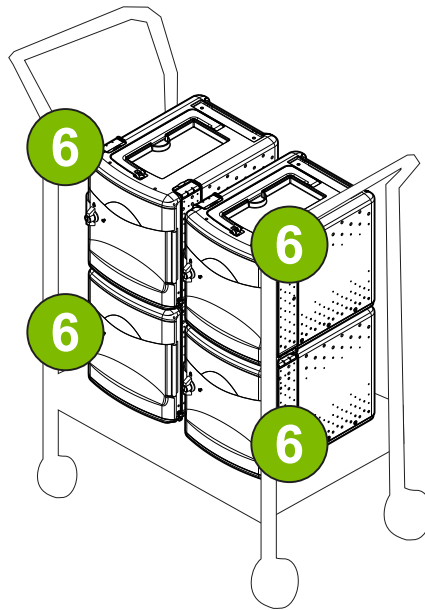

26 Device Cart:

(FTT726-UV, FTT726-USB-UV)

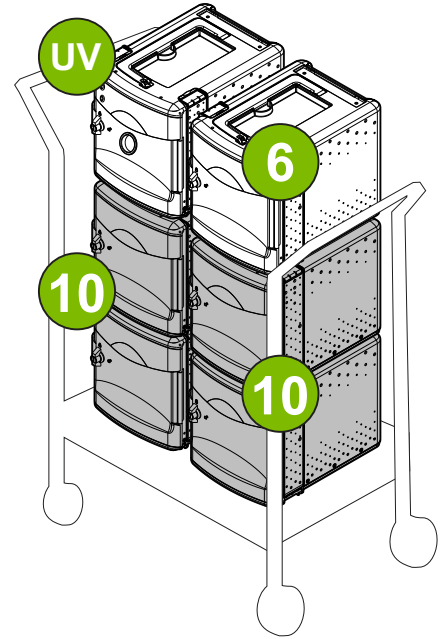

30 Device Cart:

(FTT730-699-UV)

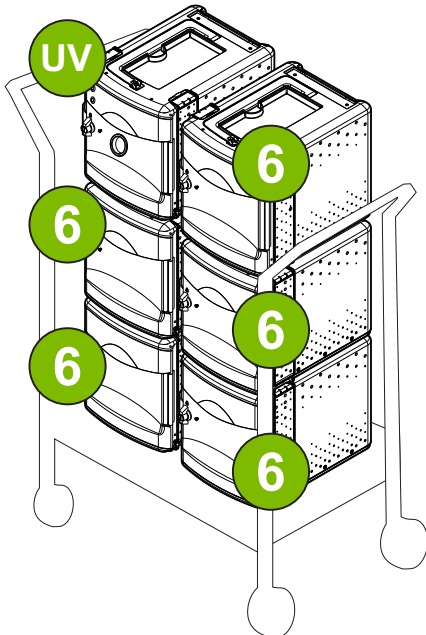

32 Device Cart:

(FTT732, FTT732-USB)

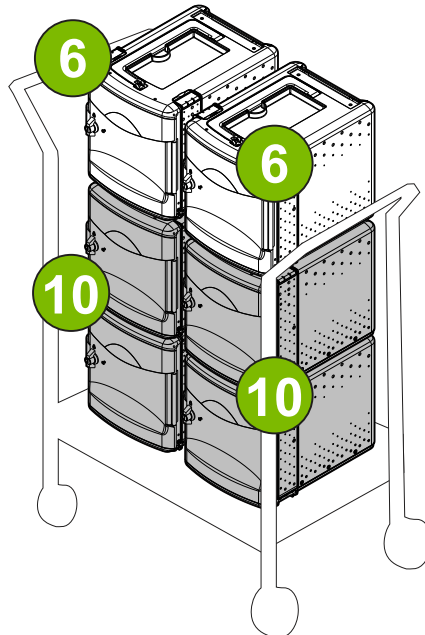

36 Device Cart:

(FTT736-699)

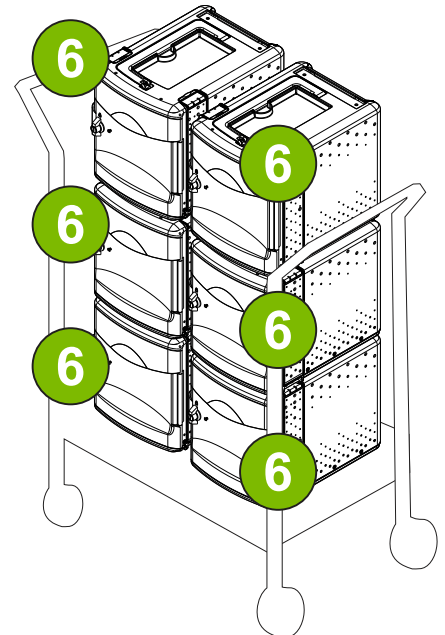

You will need: (Not to Scale)

15' Power Timer
Cable
1x

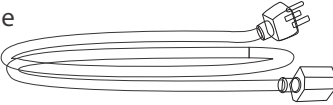

J Zip Tie
2x



Attach Power Cable to Power Timer

1 Plug power cable into power timer

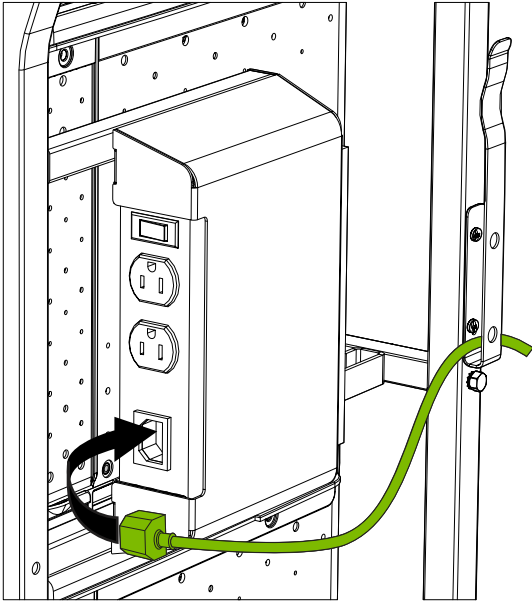

2 Zip tie power timer cable to frame

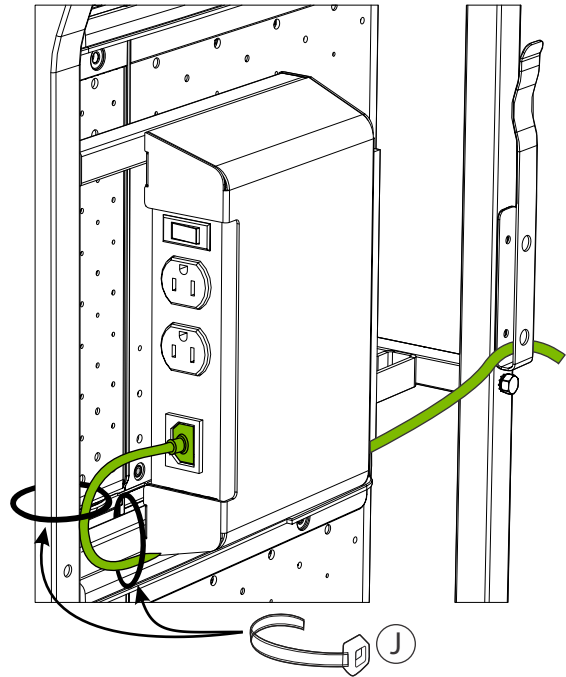

Note:

- Leave some slack in cable when zip tying it to the cart to avoid excess strain on cable or power timer.
- Trim the ends of the zip ties once they are fully tightened around the power cable.

3 Wrap power timer cable on cable hook stretcher before moving cart

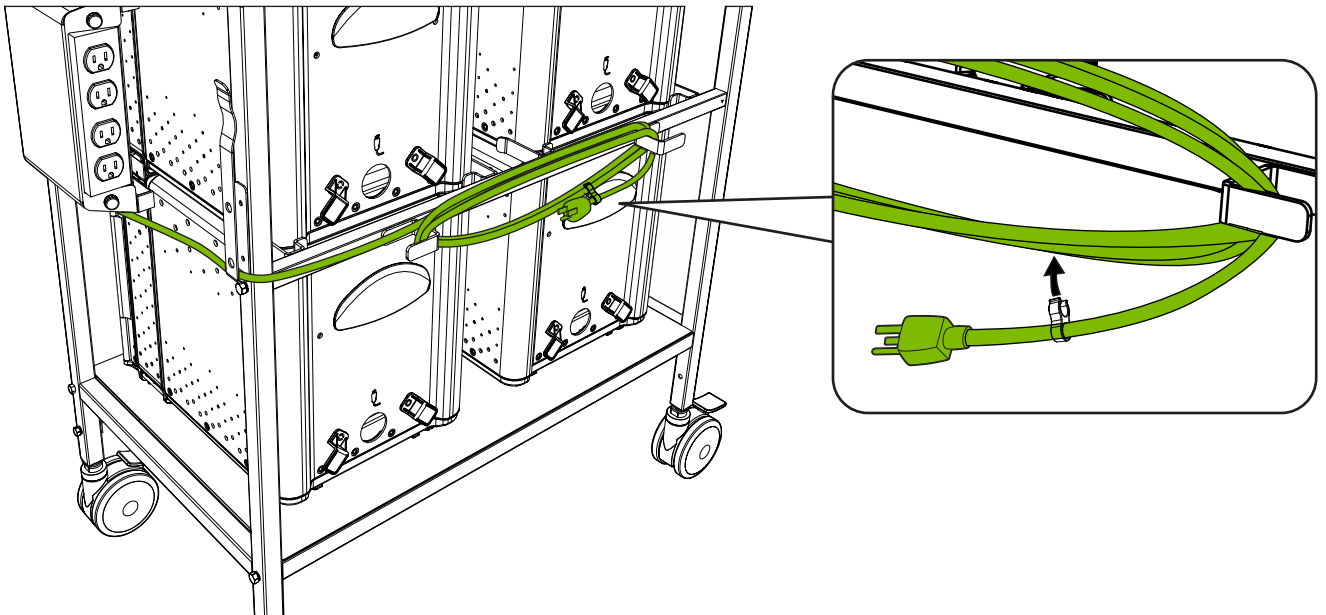

Note:

- Use the attached clip to secure the power cable to itself before moving the cart.

Plug Power Strip From Each Tech Tub Into Power Timer

Route power cables through spring steel cable hook and plug them into the power timer

- Note:**
- ! To keep the power cables organized keep the excess length of cable wrapped on the back of the Tech Tub².
 - Ensure that there is enough slack to prevent unnecessary strain on the power cables or power timer.

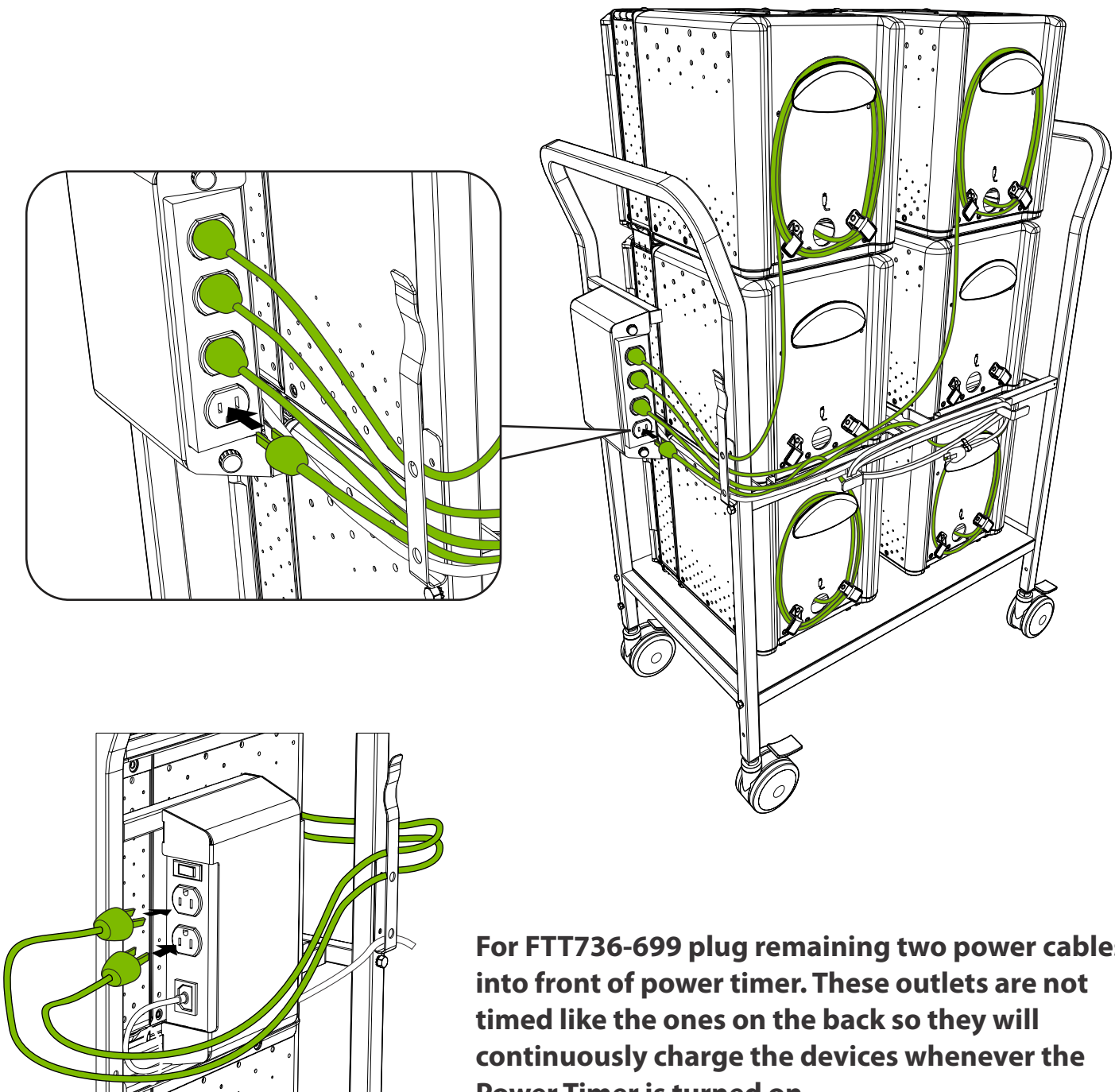

For FTT736-699 plug remaining two power cables into front of power timer. These outlets are not timed like the ones on the back so they will continuously charge the devices whenever the Power Timer is turned on.