

TEC601C

Tech Tub[®] for Chromebooks



Assembly Guide

TEC601C_2018_A

Check out our other products online at
www.copernicused.com

For assistance, please contact us:

1-800-267-8494

Email info@copernicused.com

Have your packing slip ready for reference

WARNING



- This product is meant to be assembled by an adult.
- In its unassembled state, small parts present a hazard.
- To be used under direct supervision of an adult.

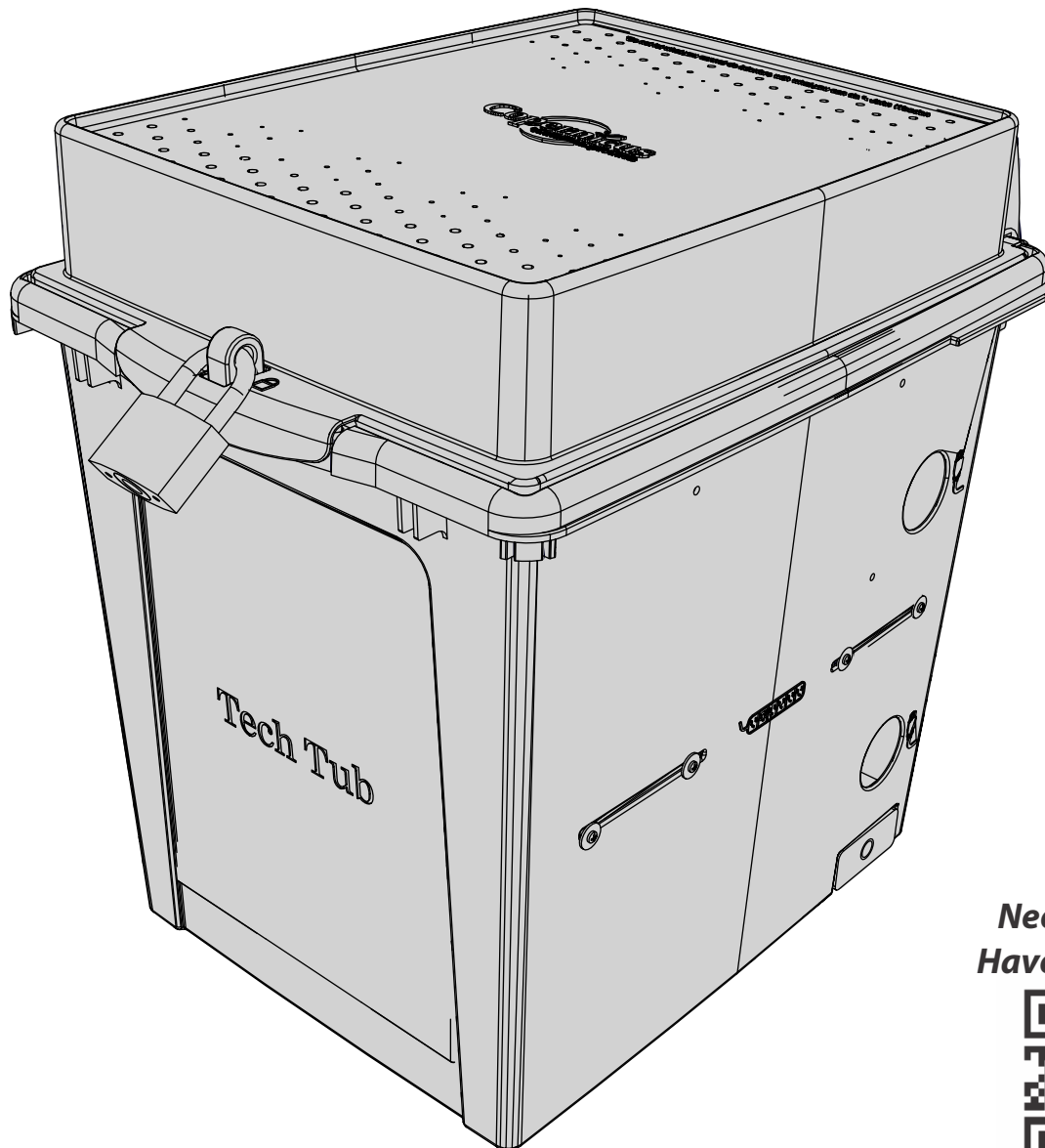

**Need Support?
Have a Question?**



Email our Customer Support



Please Recycle



Assembly Guide

TEC601C_2018_A

Check out our other products online at
www.copernicused.com

For assistance, please contact us:

1-800-267-8494

Email info@copernicused.com

Have your packing slip ready for reference

Dear Educator,

Thank you for purchasing one of our products. I hope that the Tech Tub® is useful in your classroom.

If you have any questions, concerns, or ideas please contact us by telephone at 1-800-267-8494 or email at info@copernicused.com.

Enjoy using your new product and happy teaching.

Jim Phillips
 Chief Cook and Bottle Washer

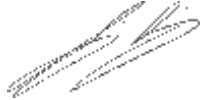

We do not inherit the earth from our ancestors, we borrow it from our children.

NORTH AMERICAN
 PROVERB

Change is the end result of all true learning.

LEO BUSCAGLIA

What you leave behind is not what is engraved in stone monuments, but what is woven into the lives of others.

PERICLES

Education is the most powerful weapon which you can use to change the world.

NELSON MANDELA

Life Time

Tub and Lid
 Warranty

1 Year

Component
 Warranty

Validate Your Warranty

To validate your warranty, submit the ON-LINE form at www.copernicused.com
Enter a draw to win a Copernicus Product for your classroom at the same time!



Warning! Hazard Risks!

Please read the warnings below for important safety information regarding your product. Failure to read these warnings or to follow the instructions below could result in personal injury or damage to your product that could void your warranty.



Small
Parts

In its unassembled state, this product contains parts that can be hazardous to small children. This product should be assembled by an adult.



Adult
Supervision

This product is to be used under the supervision of an adult.



Indoor Use
Only

This product is intended for indoor use only. To reduce the risk of fire or electric shock, do not expose this product to rain or moisture. The internal components are not sealed from the environment.



Power Strip
Specifications

Read your power strip electrical specifications. Only plug in devices that are approved for use with this power strip. Connect the supplied power strip directly to a wall outlet. **Do not connect to another power strip or use an extension cord.** Unplug when not in use. **Do not leave this product plugged in for more than 72 consecutive hours.** Turn off power strip before unplugging.

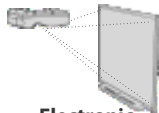

Electronic
Equipment

Read the electrical specifications of any electronic equipment you are using with your Copernicus products. Failure to read these specifications and follow their instructions could result in damage to your equipment or personal injury.



Cable Trip
Hazard

Ensure that any cables extending across the floor to your product are properly bundled and marked to avoid tripping or falling which may lead to personal injury.



Electrical Shock

Do not install or use the electrical components of this unit during a lightning storm.



Climb Hazard

Do not climb on, hang from or suspend objects from any components of your product unless otherwise specified.

Tech Tub[®] for Chromebooks

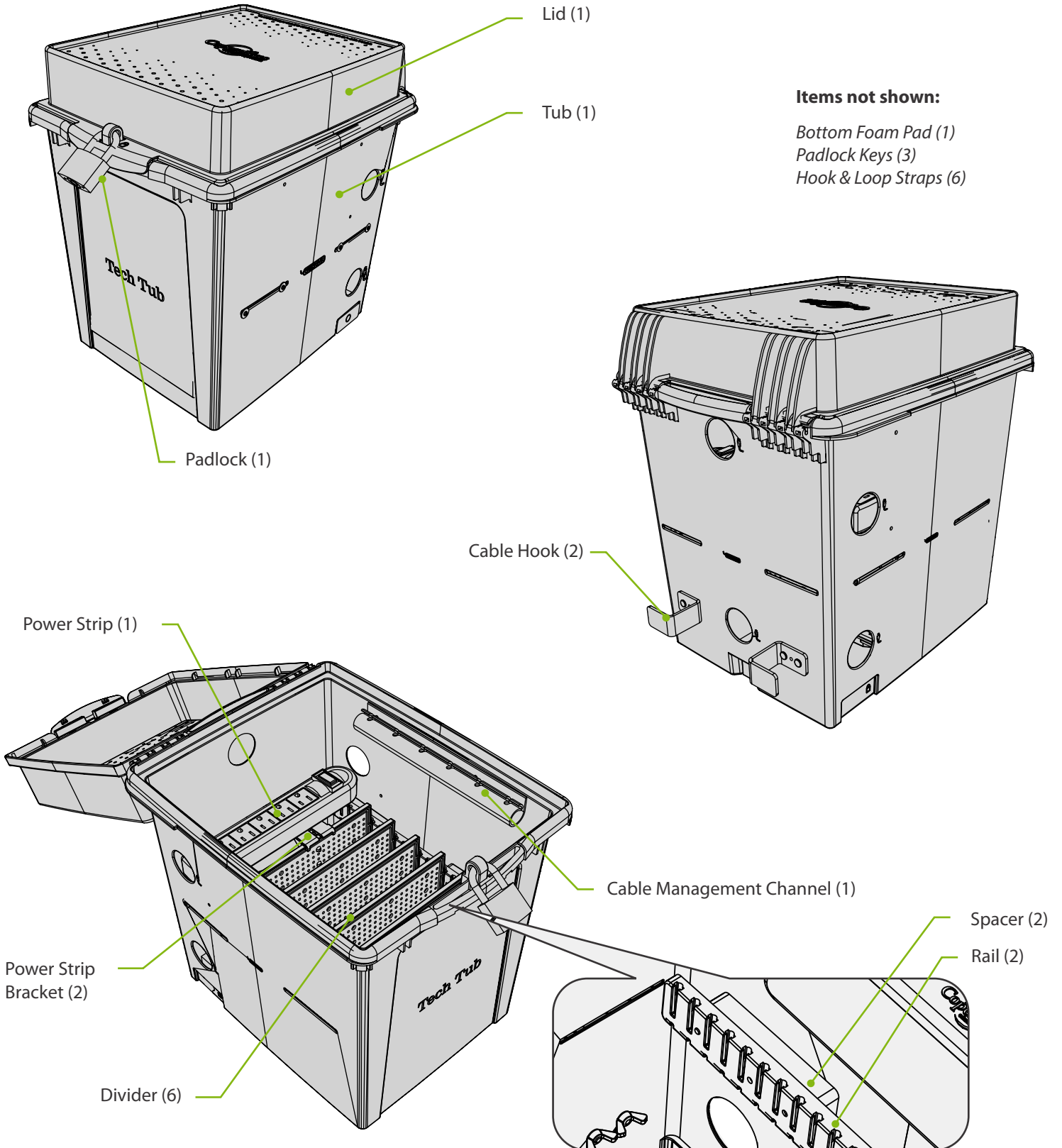

Before beginning, you should have:

Additional tools required:



Adjustable wrench **x2**

OR

11mm Wrench **x2**

Contents - Box 1

Tech Tub®
x1

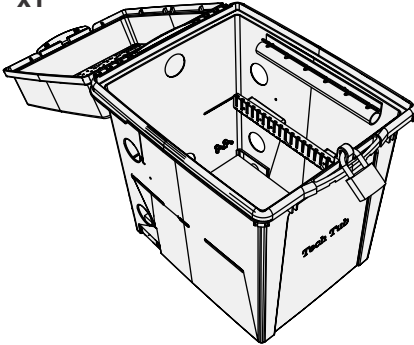

Foam
x1

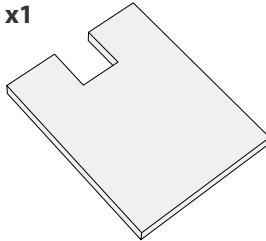

In Box 1

Hook & Loop Straps
x6



Divider
x6
(23229)

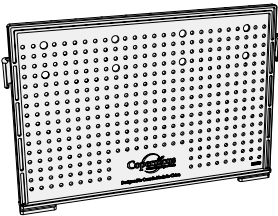

Power Strip
x1
(25515)

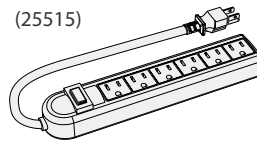

Power Strip Bracket
x2
(232281)

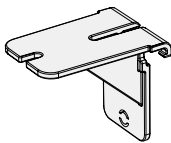

Padlock
x1

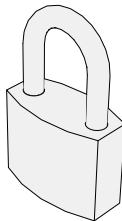

Cable Hook
x2

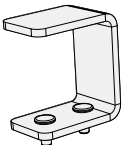

Key
x3

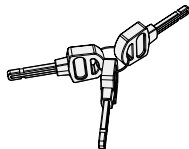

Hardware
Actual Size

(A)

M4 Wing Nut
x8



(B)

M4 Lock Washer
x8



(C)

M4 x 14mm Carriage Screw
x4



(D)

M4 Flat Washer
x4



(E)

M6 Washer
x6



(F)

M6 Lock Nut
x2



(G)

M6 x 70mm Screw
x2



Allen Key 4mm
1x



Tips for Assembly

Watch for These Helpful Symbols

This symbol denotes a 2- or 3- Person Task. For safety, please ensure that there are the suggested number of people working on steps displaying this symbol.



Watch for this symbol throughout the Assembly Guide. Wherever you see it, pay close attention. The symbol denotes a step needing extra attention to ensure it is done correctly.



The star symbol highlights an advisory note.

Before You Begin

- Lay out and identify all of the included parts.
- The hardware has been packed according to step.
- Read the assembly guide over once to familiarize yourself with them.



! Please note that in its unassembled state, this product contains parts that can be hazardous to small children. This product should be assembled by an adult.

As You Assemble the Unit

- Follow the steps in sequence.
- Before beginning each step, find the part(s) that you need for that step.
- Pay attention to the labels on the parts; they are there to help direct you at certain stages.
- The title of each step states what you will be doing. Review the text and the pictures as you build the unit.

Customer Service - FAQ's



For missing parts and other issues regarding this product:

Please call Copernicus Customer Service, where we will be happy to help.
1-800-267-8494. Monday - Friday 8:30am - 4:30 pm EST.

OR

Email our Tech Support Service at info@copernicused.com

Need Tech Support? Have a Question?



Email our Tech Support Service

Check out some of our other great products!



www.copernicused.com

1

Actual Size:

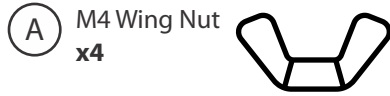

You will need: (Not to Scale)

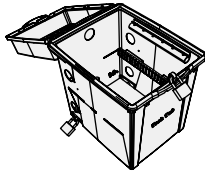

Tech Tub[®]
x1

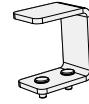

Cable Hook
x2

Install Cable Hooks

Note orientation of cable hooks

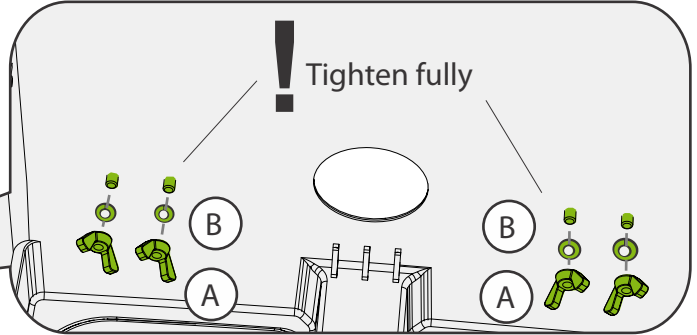
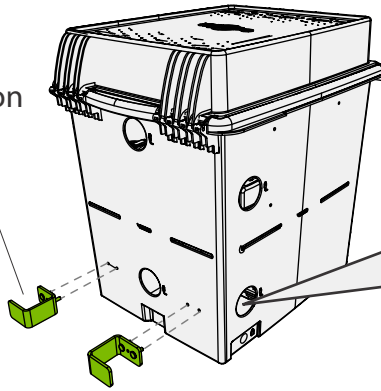

Interior of Tech Tub

! Tighten fully

2

Actual Size:

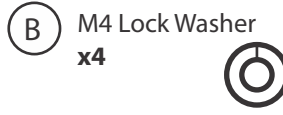
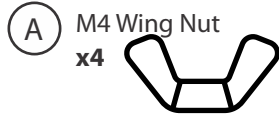

You will need: (Not to Scale)

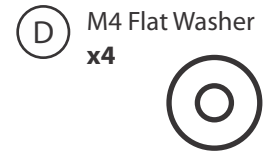
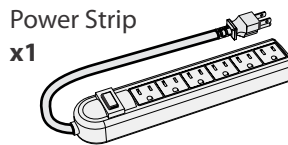
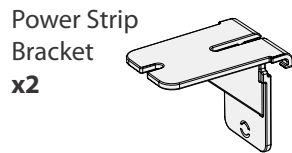

Install Carriage Bolts on Power Strip and Mount to Power Strip Brackets

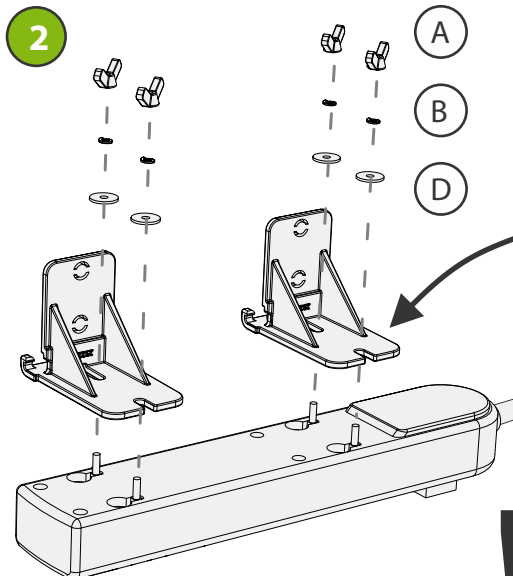
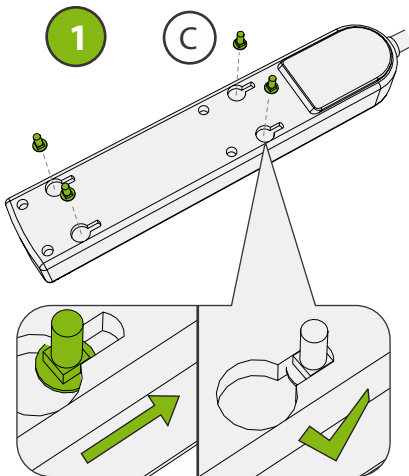

! Hold bracket in place while tightening hardware.
■ Tighten fully.

Power strip cord end

! Pay close attention to orientation of power strip.

 Keep your power strip upside down as shown. This will make the assembly easier!

3

You will need: (Not to Scale)

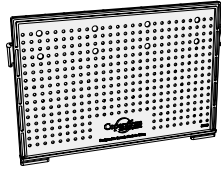

Divider
x1

Assemble Power Strip on Divider

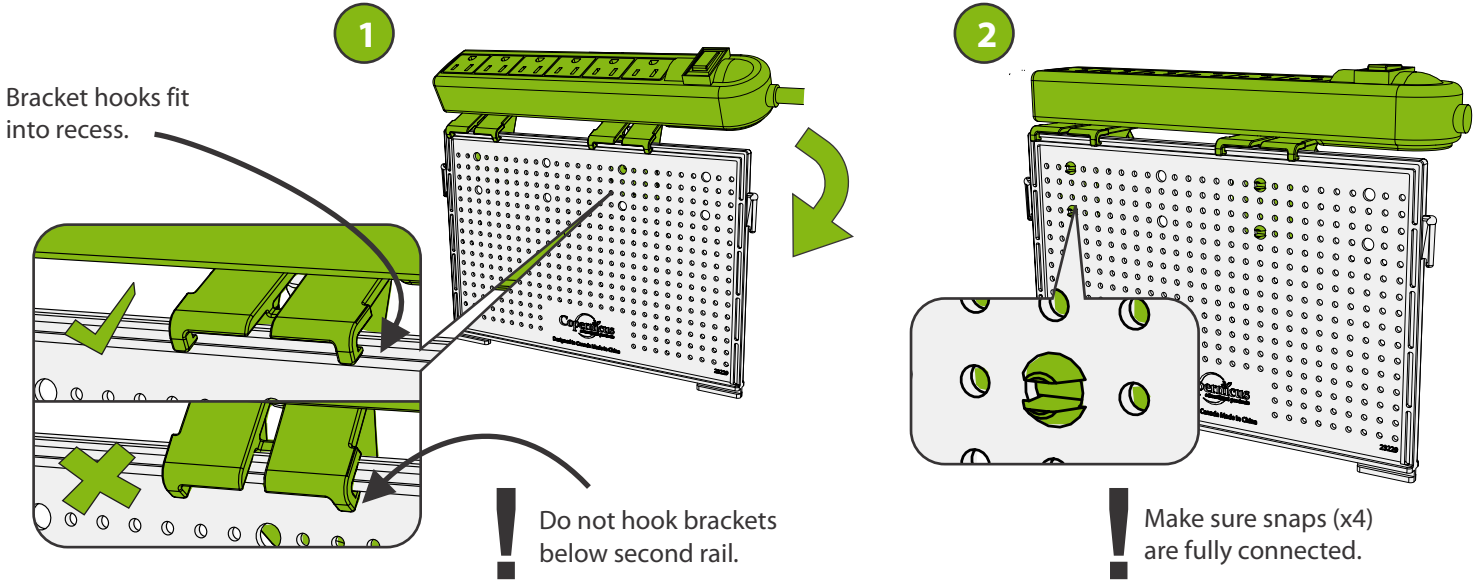

4

Actual Size:

Install Power Strip

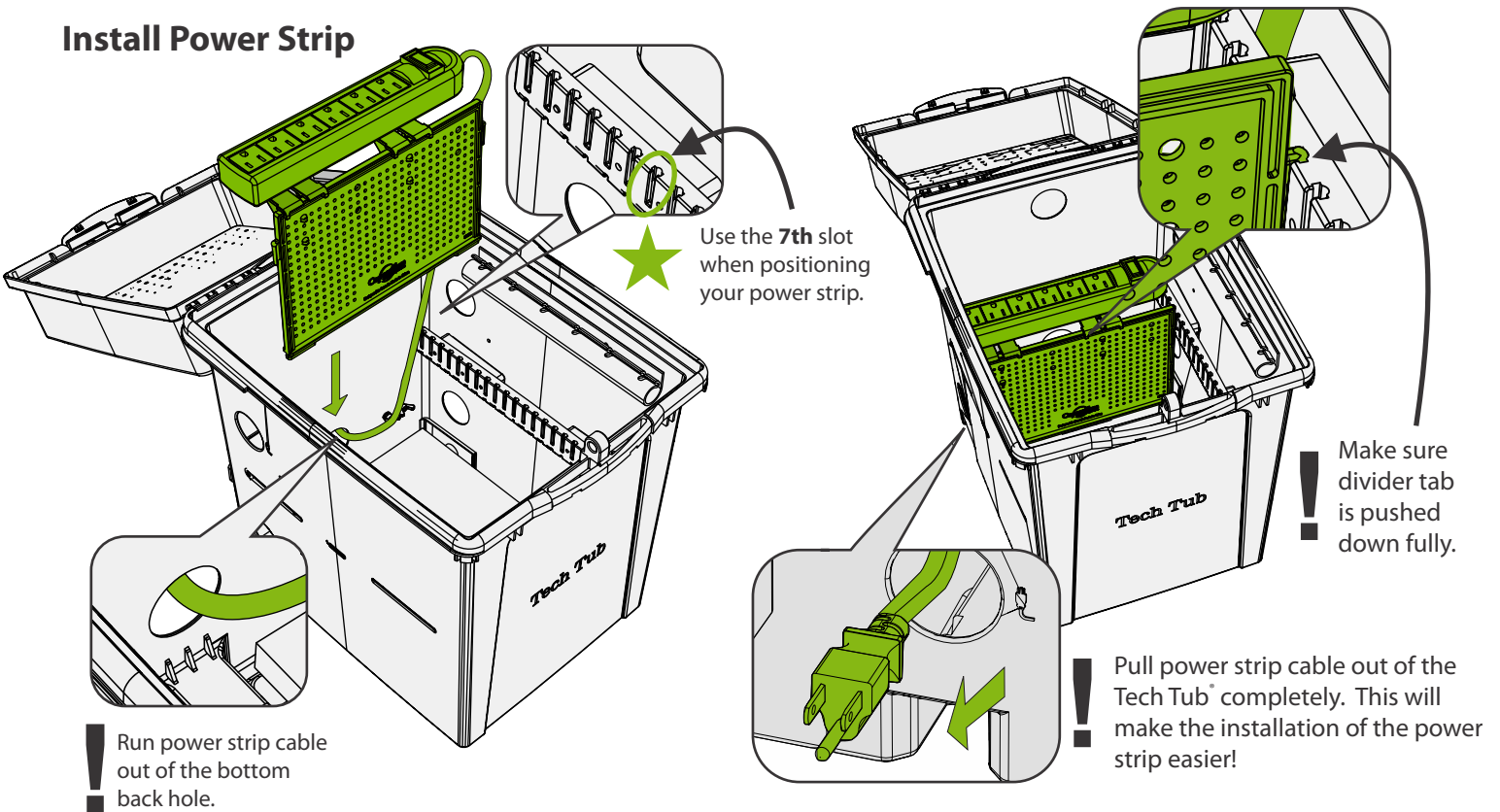

5

You will need: (Not to Scale)

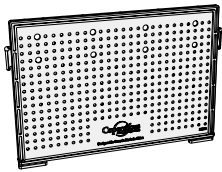

Divider
x5

Install Dividers

Use your devices to setup the spacing in between your dividers. Using a smaller storage space for your device will minimize your device's movement during transport. Don't forget to leave extra room if you have a case!

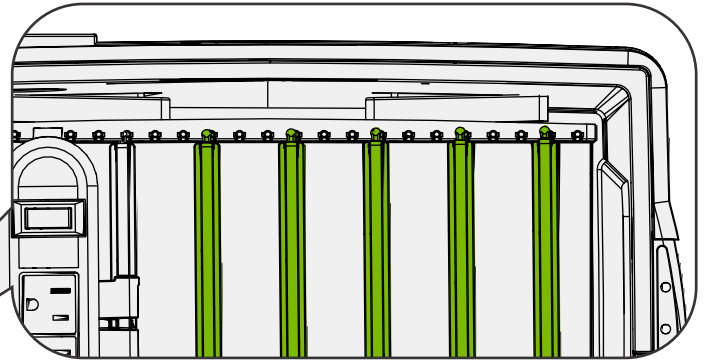
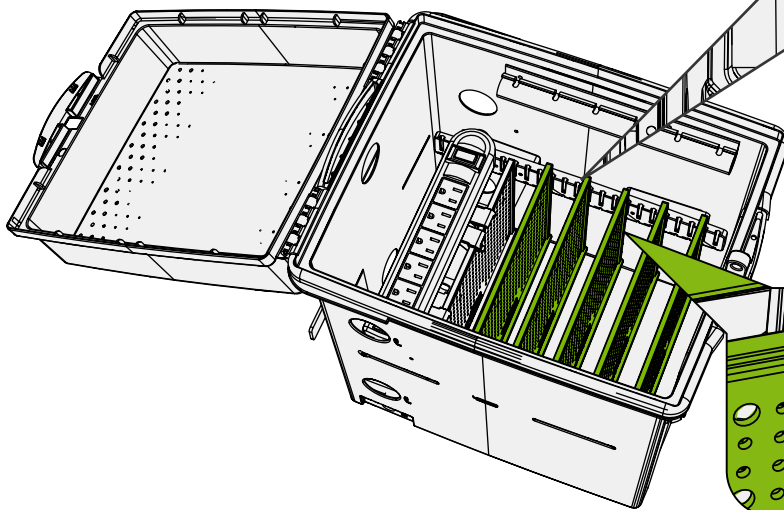

2 Grooves Between Dividers
for Chromebook Spacing

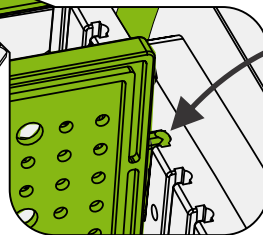

! Make sure divider tabs are pushed down fully.

6

Wrap Power Strip Cable

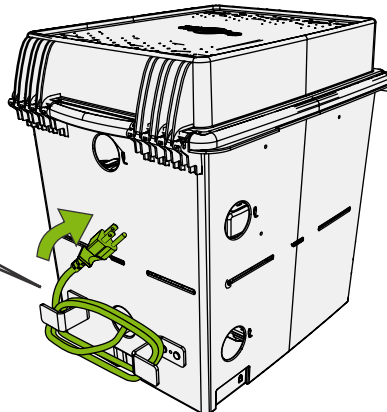
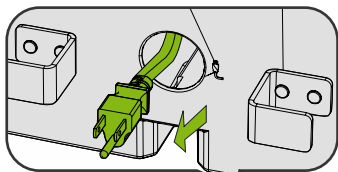

! Plug cable directly into wall outlet.
DO NOT PLUG THIS POWER STRIP INTO ANOTHER POWER STRIP.

7

You will need: (Not to Scale)

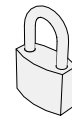

Padlock
x1

Lock Lid with Padlock

Note:
! Padlock will not lock without key

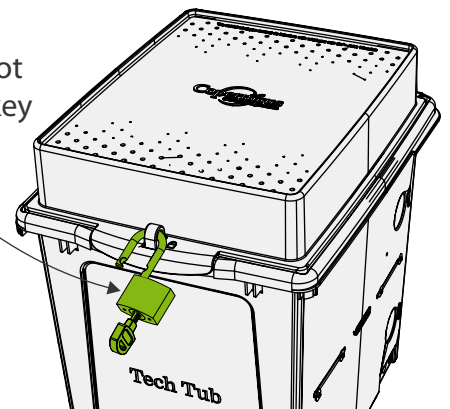



Cable Management

1 Start with the device at the front of the Tech Tub®. Plug cable into power strip and first device.

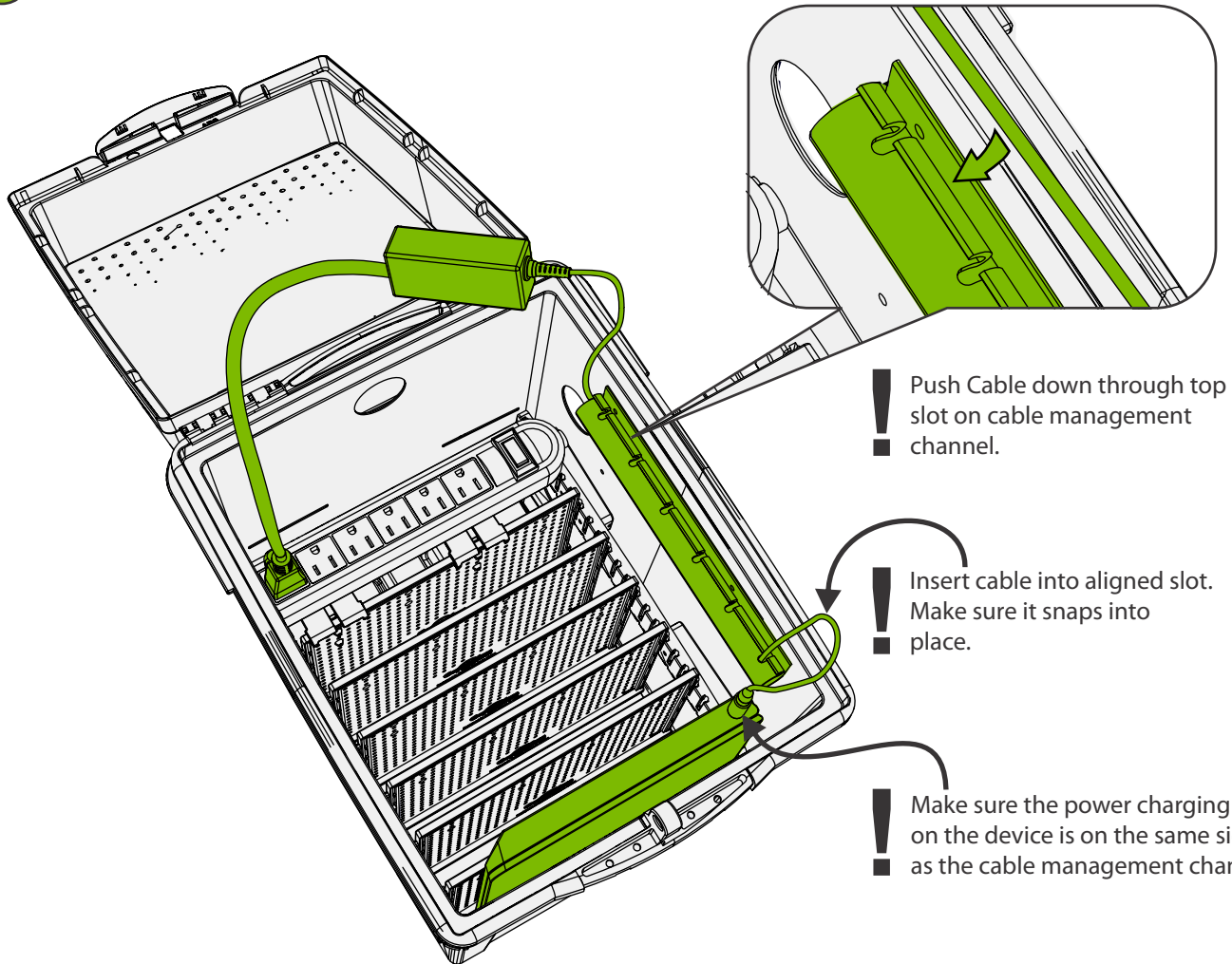

2 Feed excess cables down through the space between the tub and power strip.

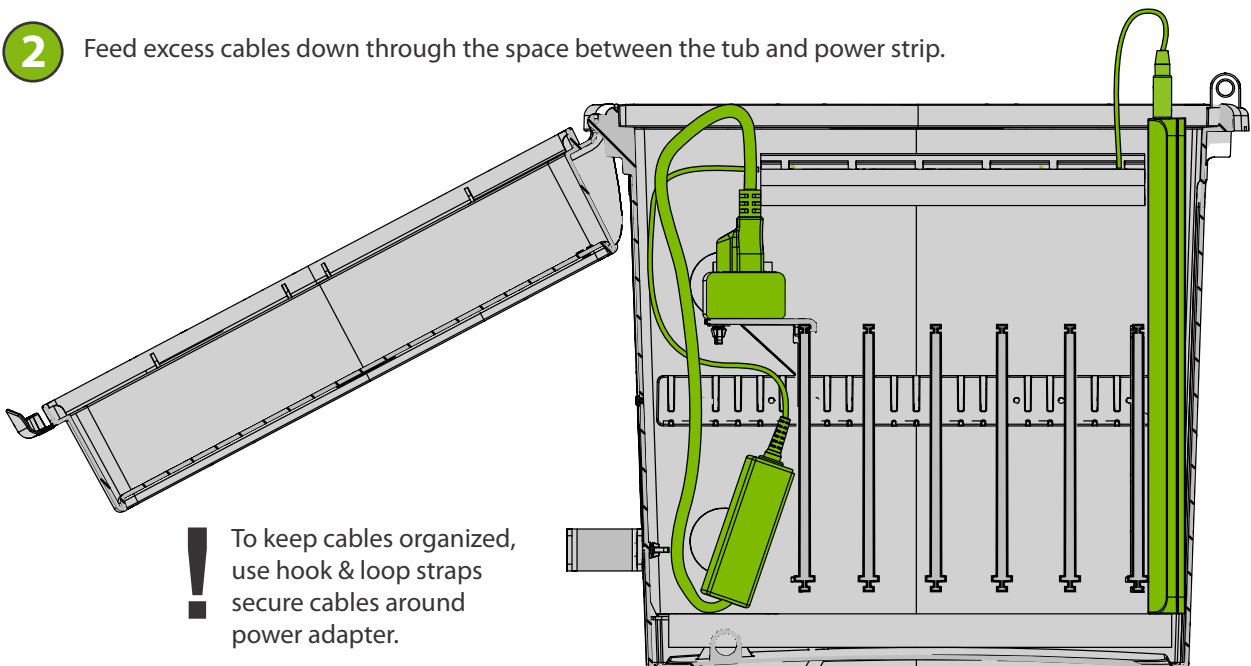



Cable Management

3

Continue steps 1 & 2 for the remainder of the devices.

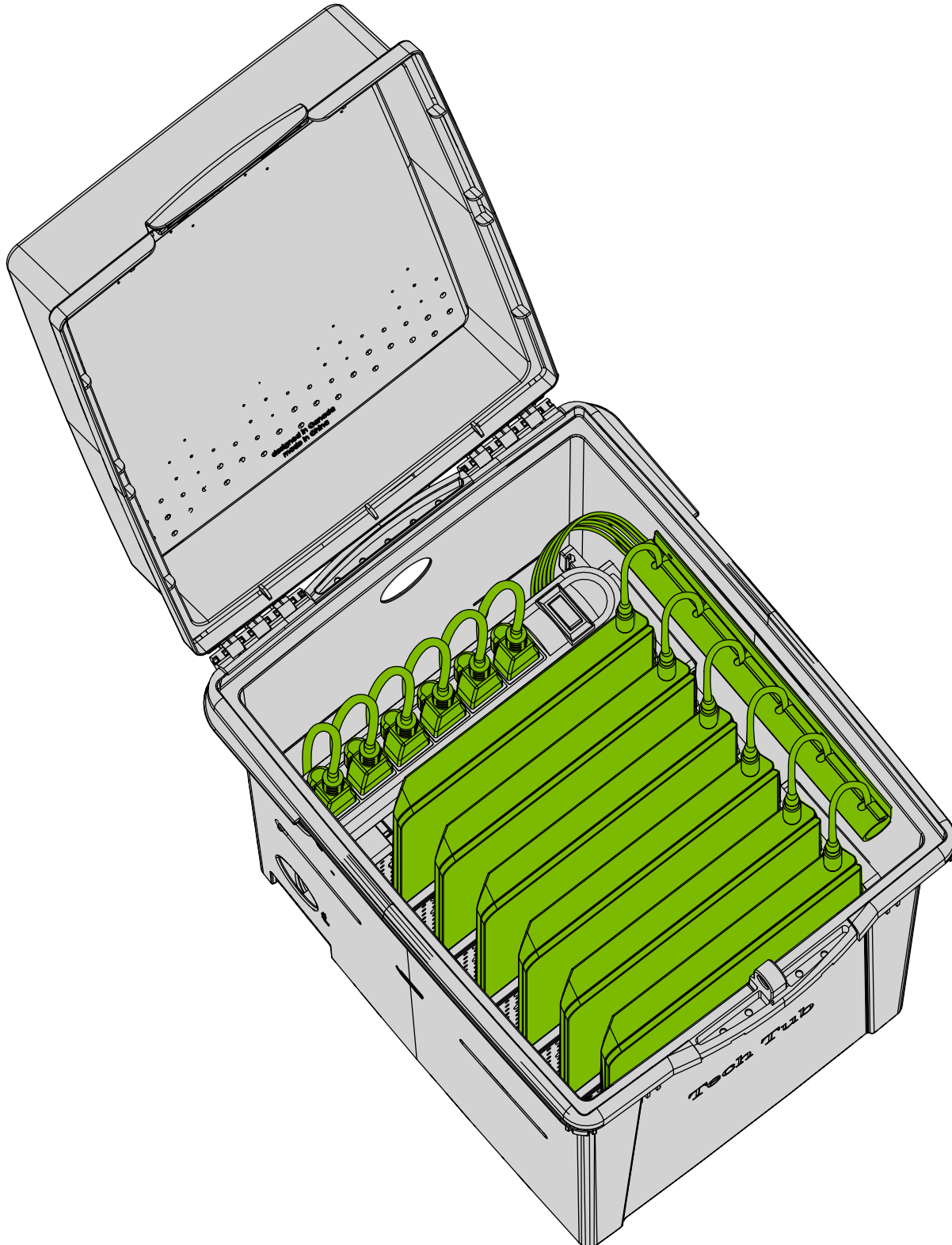



Tips for Use

Device Management

Keeping track of your devices can be made even easier by creating a sign-out program.

There are many automated software solutions available that make setting up and running a device check-out program very easy.

Here is a list of some companies and their products:

ResourceMate® - www.resourcemate.com

Neuton Data Systems - www.neuton.net

IntelliScanner - www.intelliscanner.com

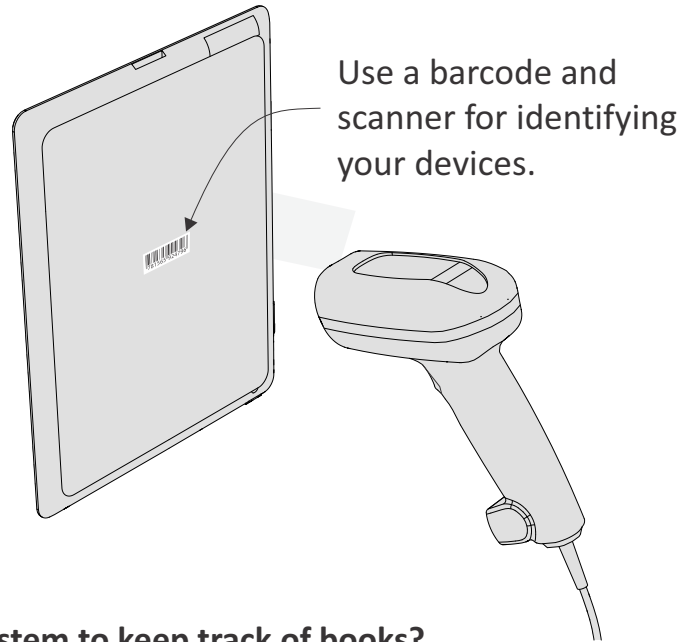

★ Does your school already use an automated system to keep track of books?
You could use this system to also keep track of your devices!

Carrying your Tech Tub®

Use the Handles along the sides of the Tech Tub® for easy lifting and carrying.

