



**i3-TECHNOLOGIES**

# i3TOUCH EX Series

Manual



# Contents

<b>General Safety Precautions</b> .....	<b>4</b>
<b>FCC Statement</b> .....	<b>5</b>
<b>Control Panel</b> .....	<b>6</b>
Prepare to install .....	6
Terminal interface .....	7
Remote control .....	8
Install batteries .....	10
Range of remote control .....	10
<b>Connections</b> .....	<b>11</b>
<b>Home Interface</b> .....	<b>14</b>
Start whiteboarding .....	14
Start presenting .....	15
Hamburger menu .....	15
Video input source .....	16
Other applications .....	16
The settings menu .....	16
<b>Settings</b> .....	<b>17</b>
Connectivity settings .....	18
System firmware update .....	19
Display settings .....	20
Audio settings .....	20
Startup and shutdown .....	21
Multi-function button .....	22

<b>Whiteboard</b> .....	<b>24</b>
Initial calibration .....	24
Floating tools menu .....	24
<b>Annotate</b> .....	<b>29</b>
Floating tools menu .....	29
<b>Browsing</b> .....	<b>31</b>
<b>Present</b> .....	<b>31</b>
<b>Quick Troubleshooting</b> .....	<b>34</b>
<b>Maintenance</b> .....	<b>35</b>

# General Safety Precautions

Before operating, please read this manual thoroughly, and keep it for future reference. Image shown in this manual is indicative only. There may be differences between the pictures and the actual product, please prevail in kind.

## Installation and placement.

- Do not put heavy objects on top of the unit.
- Do not put the unit near appliances that generate magnetic fields.
- Do not expose the unit to direct sunlight and other sources of heat.
- Do not place the unit on an unstable cart, stand, tripod, bracket, table, or shelf.
- Do not put any liquid near or on the unit, make sure do not spill any liquid inside the unit.

## Electrical safety warnings.

- Please keep power cable from physical or mechanical damage.
- Please check and ensure AC source is connected with the ground.
- This power cable comes with the device exclusively for this device only.
- Please unplug power supply when the weather is thunder-storm or lightning.
- Check that the unit's operating voltage is identical with your local power supply.
- Please use the original power cable from the accessory bag, don't modify or lengthen it.
- Please unplug power supply, when there is nobody home or the unit will be in idle for a long time.

## Cleaning and maintenance warnings.

- Unplug the power cable before cleaning.
- Clean the screen with a soft, dustless and dry cloth.
- For deep clean, please contact an authorized service center.
- Never use water or the spray type detergent to clean the unit.
- Never use any other hard or sharp object to replace the touch pen.
- Better for the panel lifetime and display performance, do not display high brightness image for long time.

## Temperature precautions.

- Normal operating temperature is 0 ~ 40 .
- Do not place the unit near or over a radiator or a heater.
- If your unit is suddenly moved from a cold to a warm place, please unplug the power cable and do not turn it on at least 2 hours, making sure the moisture inside the unit is all evaporated.

## Humidity precautions.

- Do not expose the unit in rain, or place in high humidity area.
- Please make sure indoor environment is dry and cool. Normal operating humidity is 10%~90%RH.

## Ventilation precautions.

Please put the unit in a well-ventilated place, so the heating can be released easily.  
Ensure that the unit has enough space for ventilation.  
Space requirement: left, right and back >10cm, top > 20cm.

## Standby mode.

It will enter standby mode but not turn off the unit after press the standby key.

## Batteries for remote control.

Please make sure the battery gets proper disposal or recycle after using.  
Please keep the battery away from kids and don't throw the battery into fire.

## Power switch status signs.

I means power on, O means power off.

## Notes for internal maintenance and repairs.

This machine can only be maintained by certified engineer.

# ■ FCC Statement

This equipment has been tested and found to comply with the limits for a Class B digital device, pursuant to part 15 of the FCC Rules. These limits are designed to provide reasonable protection against harmful interference in a residential installation. This equipment generates, uses and can radiate radio frequency energy and, if not installed and used in accordance with the instructions, may cause harmful interference to radio communications. However, there is no guarantee that interference will not occur in a particular installation. If this equipment does cause harmful interference to radio or television reception, which can be determined by turning the equipment off and on, the user is encouraged to try to correct the interference by one or more of the following measures:

1. Reorient or relocate the receiving antenna.
2. Increase the separation between the equipment and receiver.
3. Connect the equipment into an outlet on a circuit different from that to which the receiver is connected.
4. Consult the dealer or an experienced radio/TV technician for help.

## FCC warning.

This device complies with Part 15 of the FCC Rules. Operation is subject to the following two conditions: (1) this device may not cause harmful interference, and (2) this device must accept any interference received, including interference that may cause undesired operation.

# Control Panel

Prepare to install.

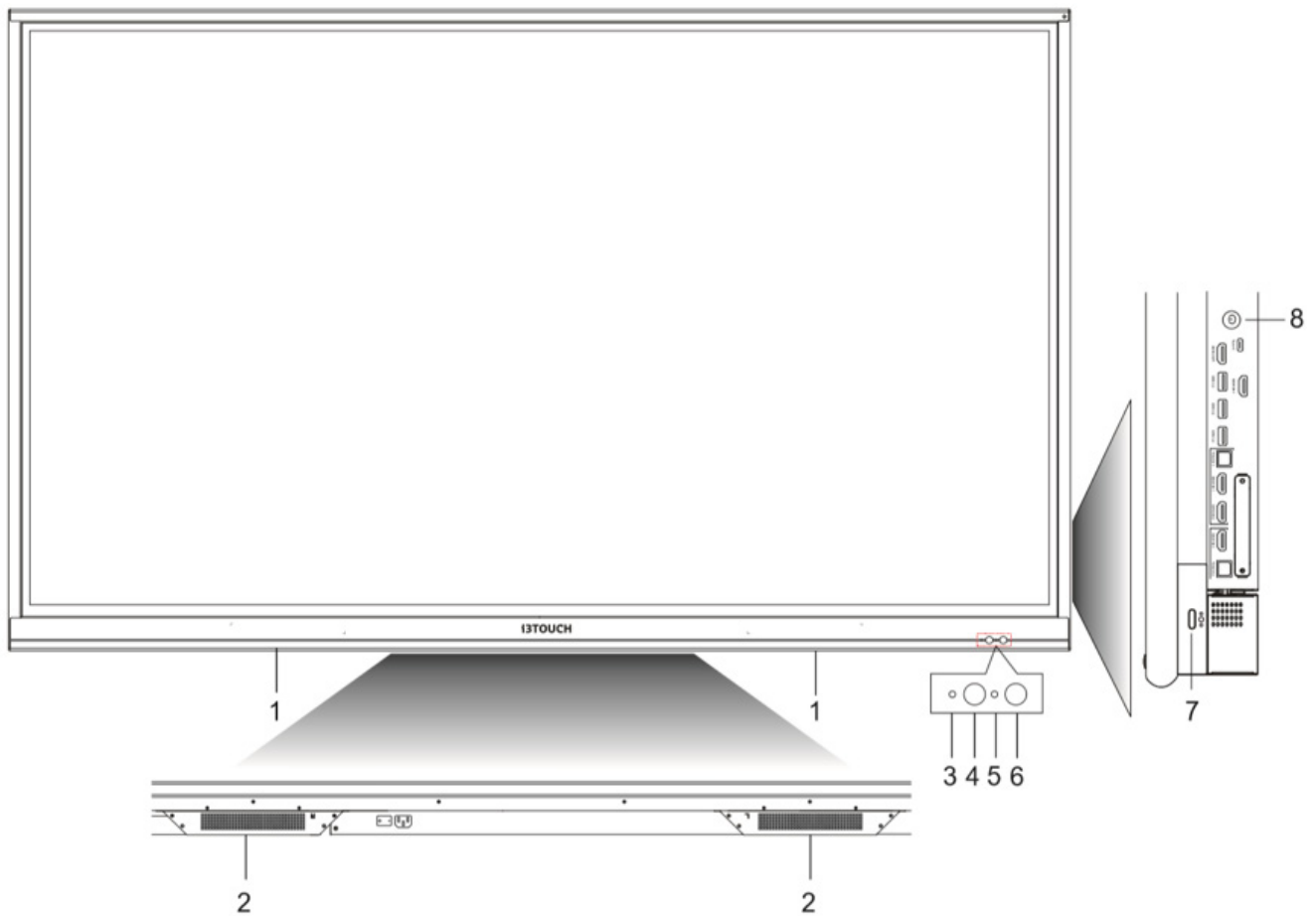

## Parts

- |   |  |
|---|--|
| 1 | Magnetic stylus holders                      |
| 2 | Bottom loudspeakers                          |
| 3 | Power indicator light                        |
| 4 | Remote control signal receiver               |
| 5 | Light sensor                                 |
| 6 | PIR sensor                                   |
| 7 | Multi-function button                        |
| 8 | Press: energy saving mode<br>Hold: Power off |

## Terminal interface.

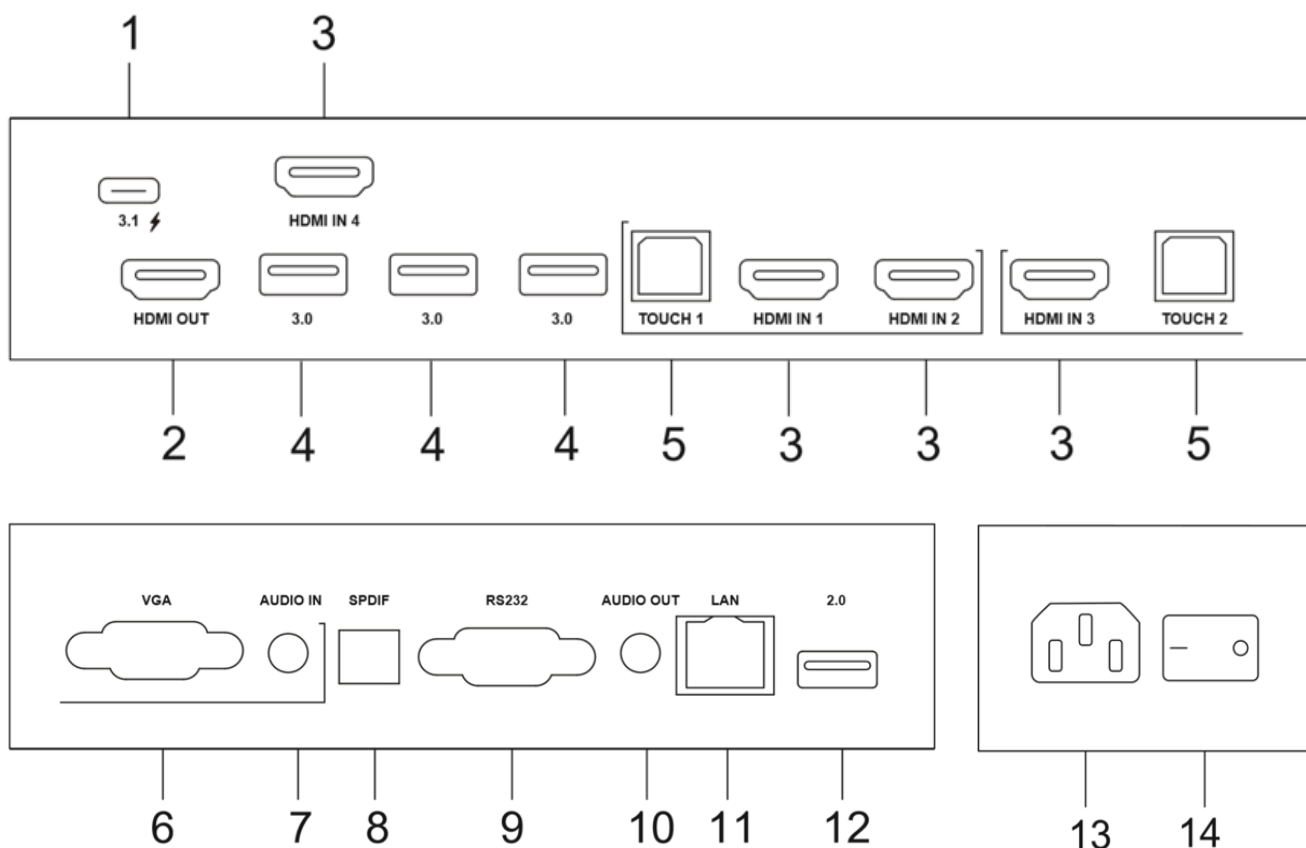

### Function description





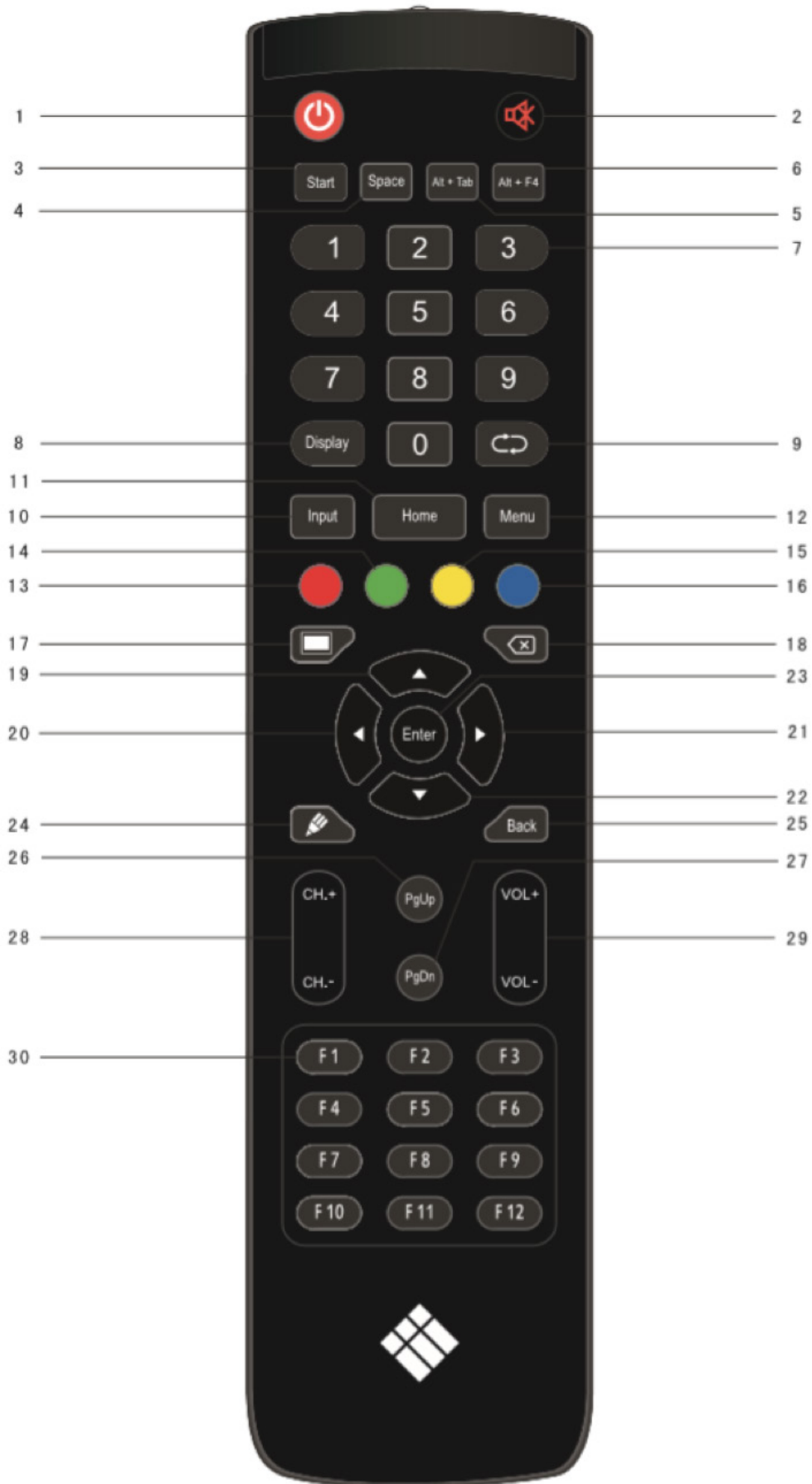

1	USB 3.1	Type-C. Supports charging, Data transmission, Audio and Video.
2	HDMI Out	Connect to another display with HDMI interface.
3	HDMI In	High-definition multimedia interface signal input, connect to devices with HDMI output interface (personal computer with HDMI output, set-top box, or another video device)
4	3.0	USB 3.0, connect USB devices such as mobile hard disk, USB drive, USB keyboard and/or mouse, etc.
5	Touch	Touch signal output to the external computer
6	VGA	External computer video input
7	Audio In	External computer audio input
8	SPDIF	Carry multichannel sound via optical signals.
9	RS232	Serial interface, used for mutual transfer of data between devices
10	Audio Out	Audio output to the external speaker
11	LAN	Connect RJ45 terminals
12	2.0	USB 2.0. Connect USB devices such as mobile hard disk, USB drive, USB keyboard and/or mouse, etc.
13	AC In	AC power input, connect AC power supply
14	AC Switch	To open or shut down AC power supply. "I" means power on, "O" means power off

# Remote control.





## Function description

1		Power on/off
2		Enter or exit mute mode.
3	Start	Windows Start Key (or Linux Super Key)
4	Space	PC's Space key
5	Alt+Tab	PC's Alt+Tab key (Windows or Linux)
6	Alt+F4	PC's Alt+F4 key (Windows or Linux)
7	Numeric keys	Numeric input keys
8	Display	Display channel information
9		/
10	Input	/
11	Home	Return to android system main screen.
12	Menu	Open the settings application.
13	Red	Enable or disable Front keyboard and Touch.
14	Green	Enable or disable Front keyboard.
15	Yellow	Enable or disable Touch.
16	Blue	Screen Freeze application
17		Turn off or turn on the screen backlight.
18		PC's Backspace key
19	▲	Navigate up (Android, Windows, Linux, MacOS)
20	◀	Navigate left (Android, Windows, Linux, MacOS)
21	▶	Navigate right (Android, Windows, Linux, MacOS)
22	▼	Navigate down (Android, Windows, Linux, MacOS)
23	Enter	Confirmation key
24		Open i3NOTES whiteboarding application
25	Back	Return to the last previous page
26	PgUp	Page Up (Windows, Linux, MacOS)
27	PgDn	Page Down (Windows, Linux, MacOS)
28	CH.+ / CH.-	/
29	VOL+ / VOL-	Increase / reduce the volume
30	F1-F12	PC's F1 - F12 function keys (Windows, Linux, MacOS)

NOTE: All computer related function keys are available only when the computer is connected to the display via Touch USB connection.

## Install batteries.

1. Open back cover of battery component on the back of remote control.
2. Install AAA type battery according to the corresponding electrode, make sure battery positive and negative pole are correct ("+" to "+", "-" to "-"), please do not mix using old and new batteries.
3. After battery is installed, close the back cover of battery components, and make the following clip buckled to the bottom.

## Range of remote control.

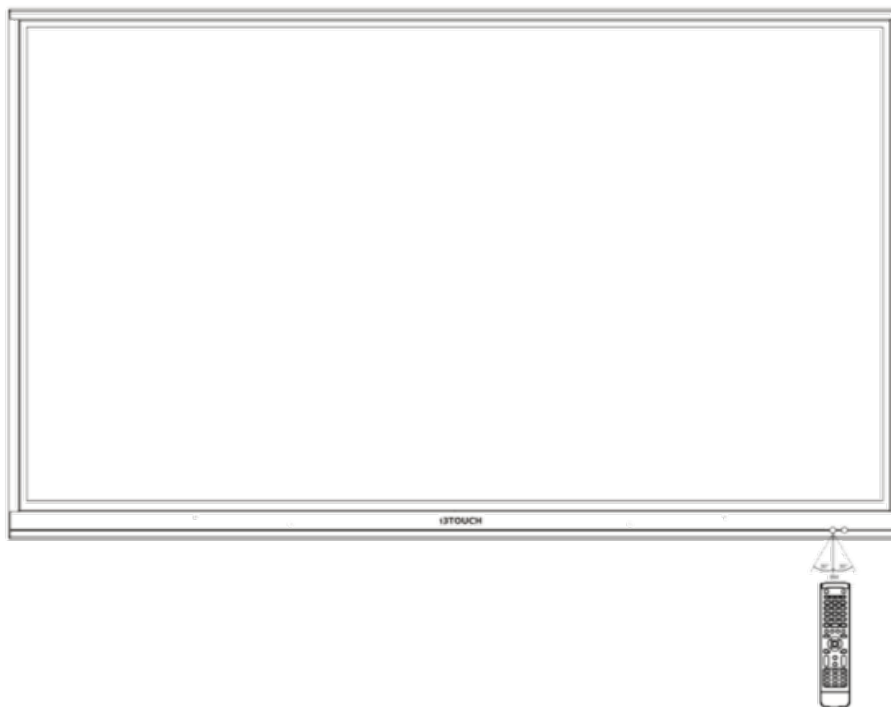

Remote control can work with a maximum range of 8 meters distance, 30 degrees left and right from the remote-control receiver.

In order to protect environment, please dispose waste batteries into recycling box.

Warning: if the battery is replaced by an incorrect type, it may lead to explosion.

# Connections

For the safety of you and the machine, please do not connect any power plug before connection.

## External computer and touch connection.

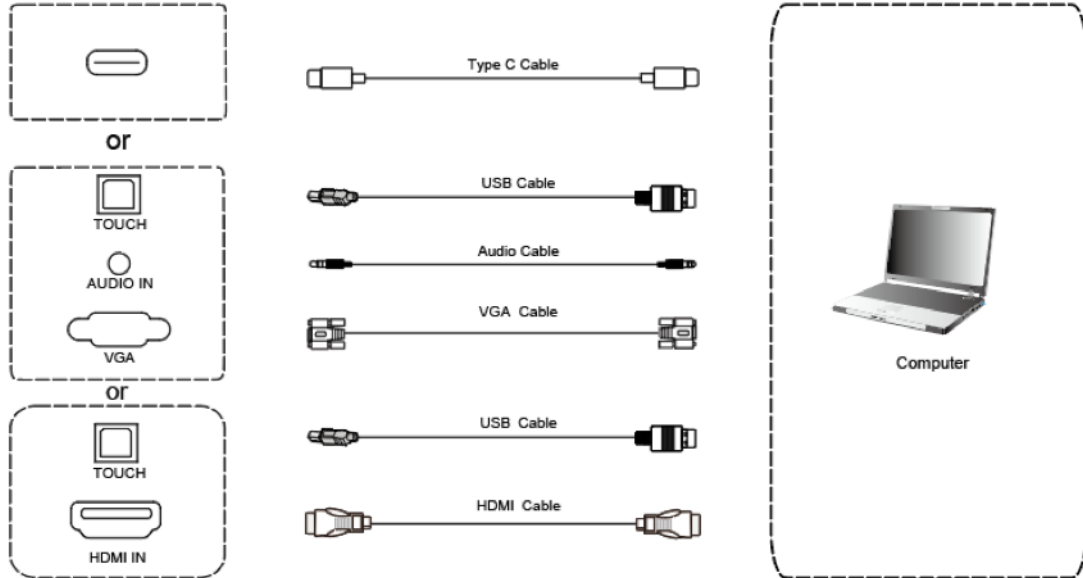

- Use VGA cable to connect to VGA output port of external computer, and meanwhile use headphone audio cable to connect to external computer audio output interface. (Or use HDMI cable to connect to HDMI output port of external computer.) (Or use Type-C cable to connect to Type-C output port of external computer.)
- Use USB cable to connect to external computer USB port. (Or use Type-C cable to connect to Type-C output port of external computer.)
- After cable connection, plug in power cord, and switch power on.
- Start external computer.
- Press  key, and the equipment is power on.
- Press the INPUT key to switch to VGA/HDMI/ Type-C channel

*NOTE: External computer input, equipment's best resolution is 3840\*2160 or 1920\*1080.*

Recommended computer configuration:

- 1 GB Available Hard Drive space
- 2.0 GHz Processor, 1GB RAM
- More than 256 color display cards
- VGA OUT / HDMI OUT, Audio-OUT, USB Interface
- Supported Resolutions 800\*600,1024\*768,1920\*1080,3840\*2160

## Audio and video equipment input.

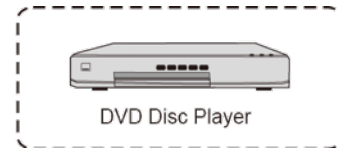
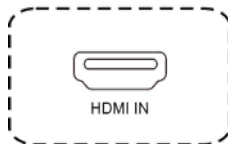

- Use HDMI cable to connect audio and video equipment with HDMI output.
- After cable connection, plug in power cord, and switch power on.
- Press  to turn equipment on.
- Press INPUT key to switch to HDMI port.

## Audio and video equipment output.

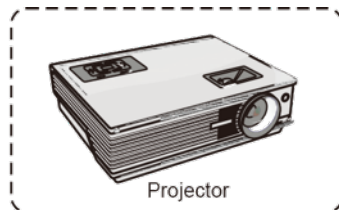
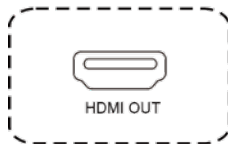

- Use HDMI cable to connect audio and video equipment with HDMI input.
- After cable connection, plug in power cord, and switch power on
- Press  to turn equipment on

## RS232 connection.

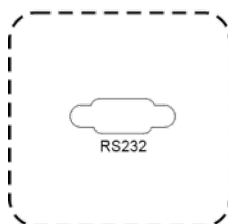

After using serial port cable to connect central control equipment and machine, certain function of the machine can be controlled via central control equipment, such as: machine ON/OFF, and adjustment of sound volume, etc.

## LAN connection.

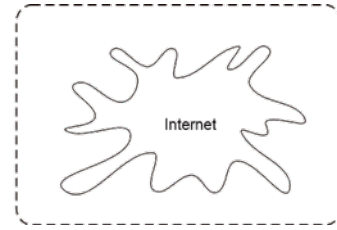
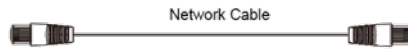
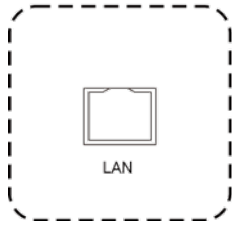

## USB connection.

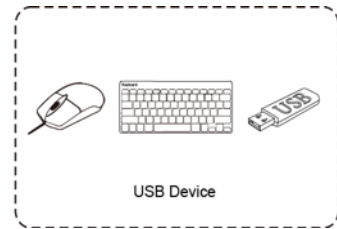
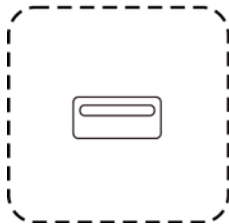

# Home Interface

All our i3TOUCH devices are available with a BIZ or EDU Studio, bringing ease of use and simplicity to your desired workspace. You can choose which studio you want to use at first boot or through the settings menu.

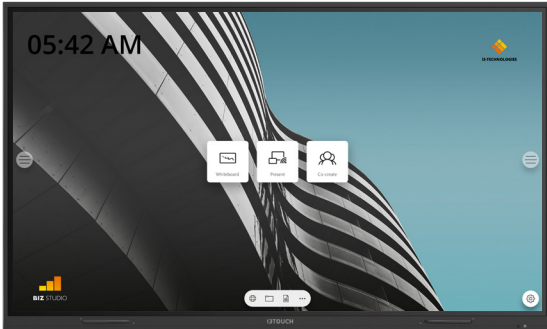

## BIZ STUDIO

The BIZ studio equips the display with a stylish background and extends the user interface with an extra configurable button. You can customize the link and label of this button through the settings menu or in the startup wizard at first boot.

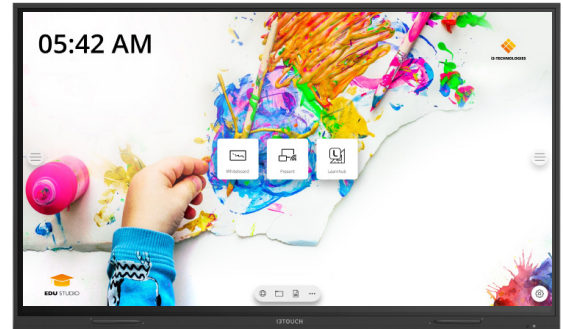

## EDU STUDIO

The EDU studio equips the display with a colorful, fun background and extends the user interface with an extra button for i3LEARNHUB.

## Start whiteboarding.

The whiteboard button opens an interactive whiteboard that allows you to take notes, make drawings or facilitate workshops. The output can be shared very easily with all participants.

### WHITEBOARD

1. Tap the whiteboard button.
2. Start writing in the active tab.
3. Activate the writing options by tapping the eraser.

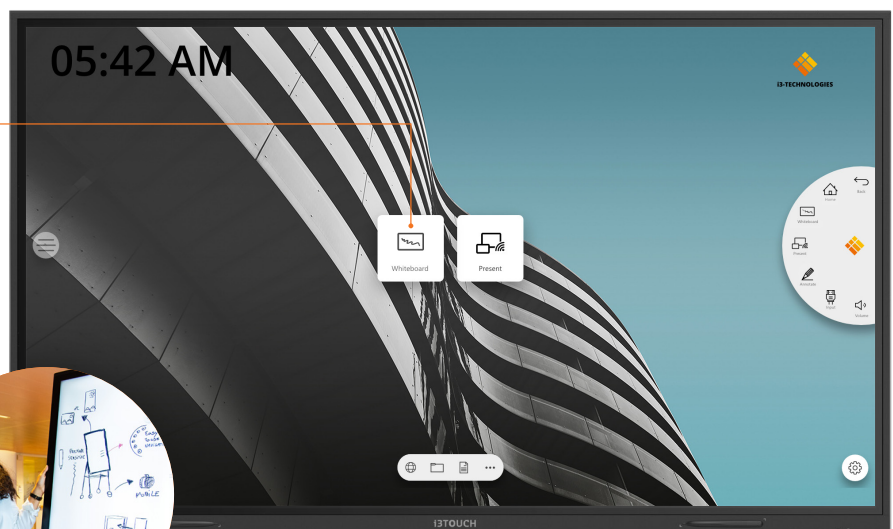

## Start presenting.

Content from other devices can be streamed to the display with a push-of-a-button.

### PRESENT

1. Tap the present button.
2. Choose your platform of choice.
3. Follow the setup guide on screen.

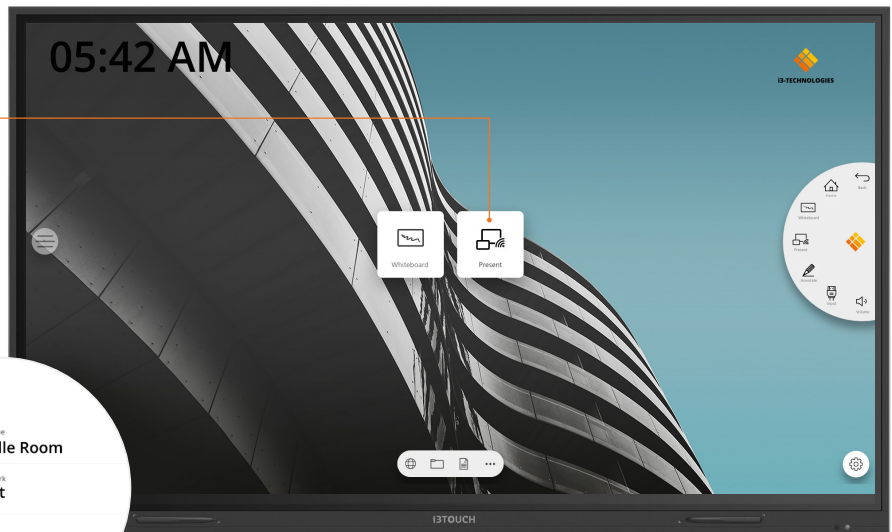

## Hamburger menu.

Use your favourite applications during meetings. Press the hamburger icon on the left or right side of the display to open the menu.

 Clicking the hamburger button will make the menu appear with a number of options:

1. Exit the menu and navigate back.
2. Navigate to the homescreen.
3. Start the Whiteboard application.
4. Start the Present application.
5. Work with Annotate and make annotations on everything that appears on the screen.
6. Switch between the input sources of the display.
7. Adjust volume of the loudspeakers.



## Video input source.

The following options are visible when a video signal is connected.



Clicking the video input button will make the menu appear with a number of options:

1. Switch to the Android video source
2. Switch to the USB-C video input source
3. Switch to the HDMI video input source
4. Switch to the VGA video input source



## Other applications.

At the bottom of the screen, in the middle, there are a few buttons to access other applications.

1. Open the browser app
2. Open the file explorer app
3. Open the WPS offices app
4. Open more apps

APPS



SETTINGS



# Settings

When opening the settings menu, you get an overview of all the settings you can adjust.

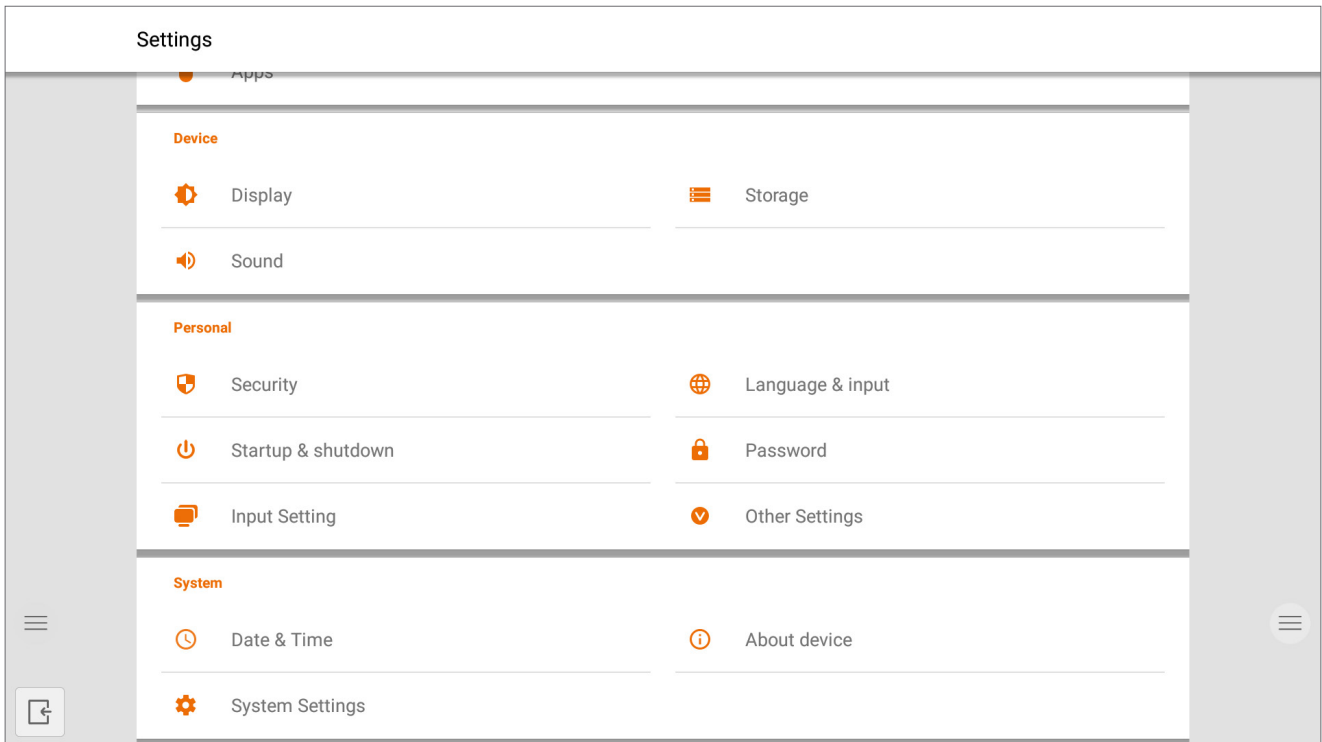
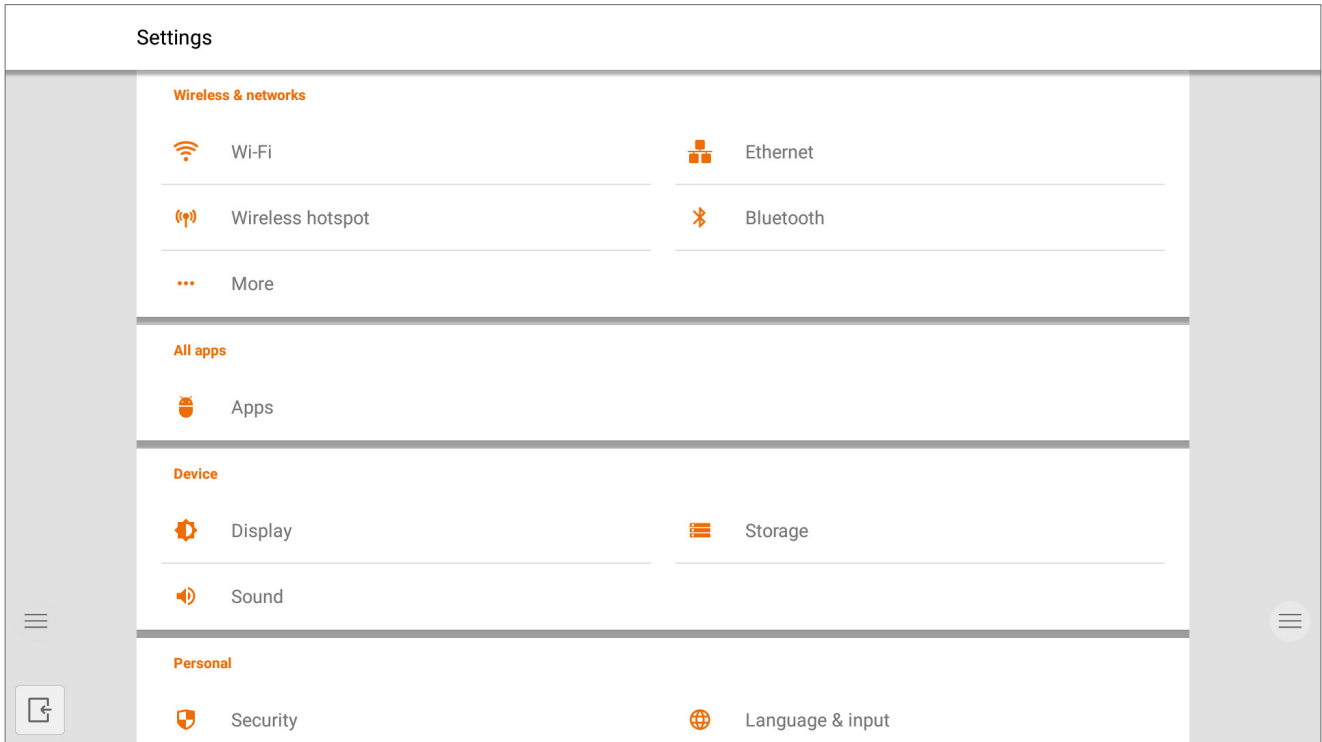

# Connectivity settings.

Make a connection to your network and internet via Wi-Fi or Ethernet cable.

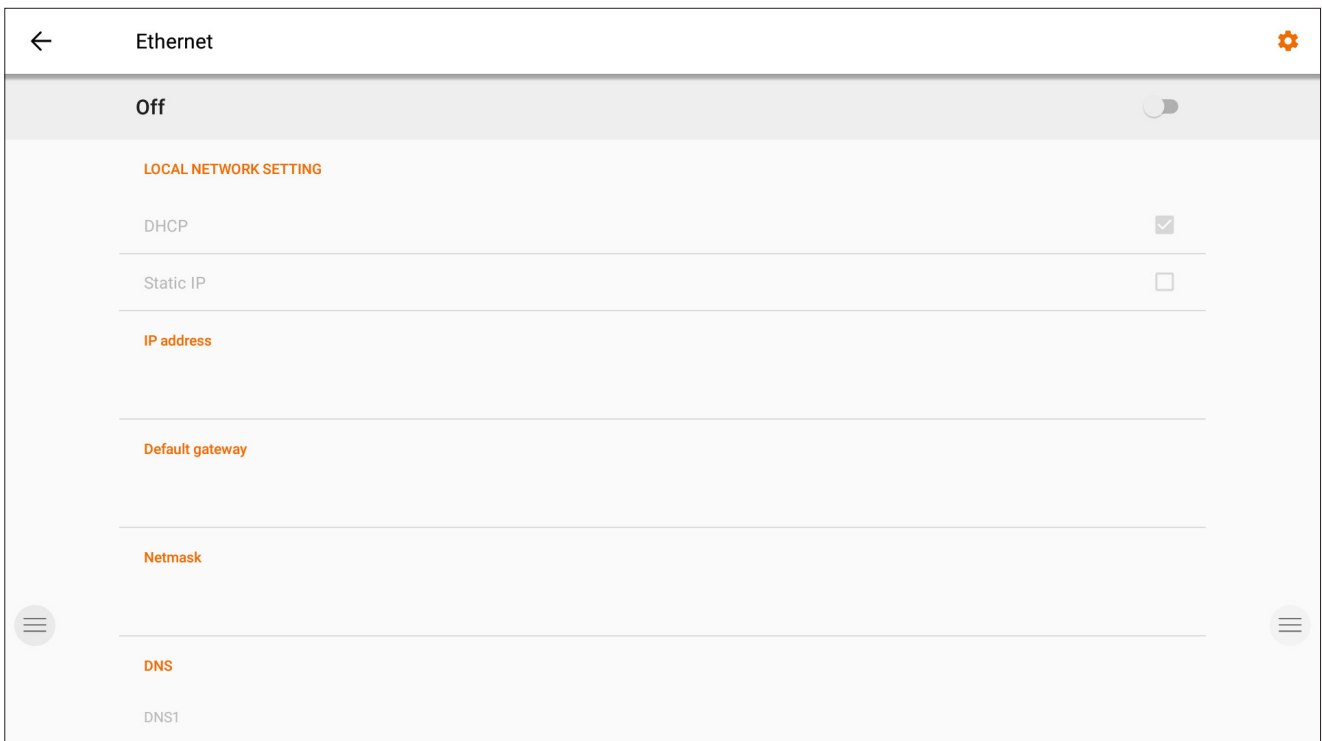

# System firmware update.

After connecting to the internet, verify that your display is running the latest firmware.

In the settings application, press "About Device". Press the "Check Update" button to validate your firmware version online. If a newer version is available, this button will provide instruction to update your device.

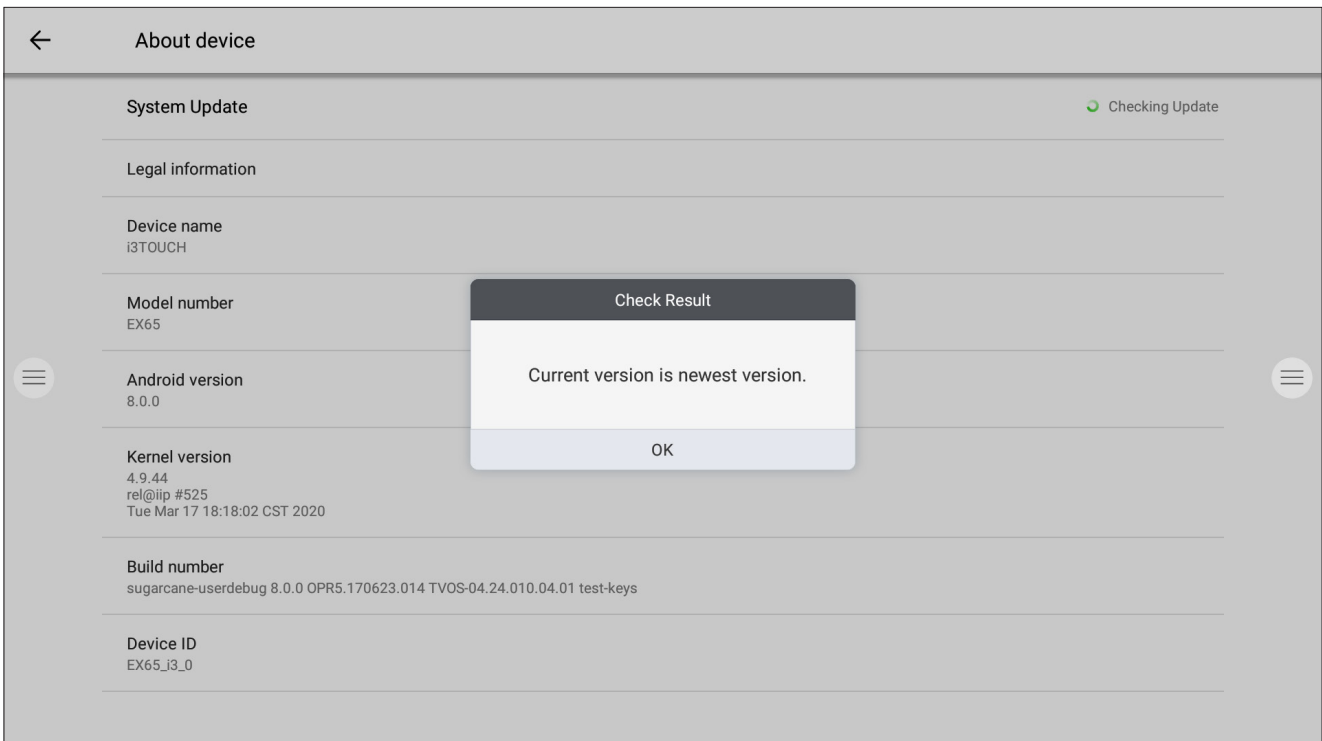
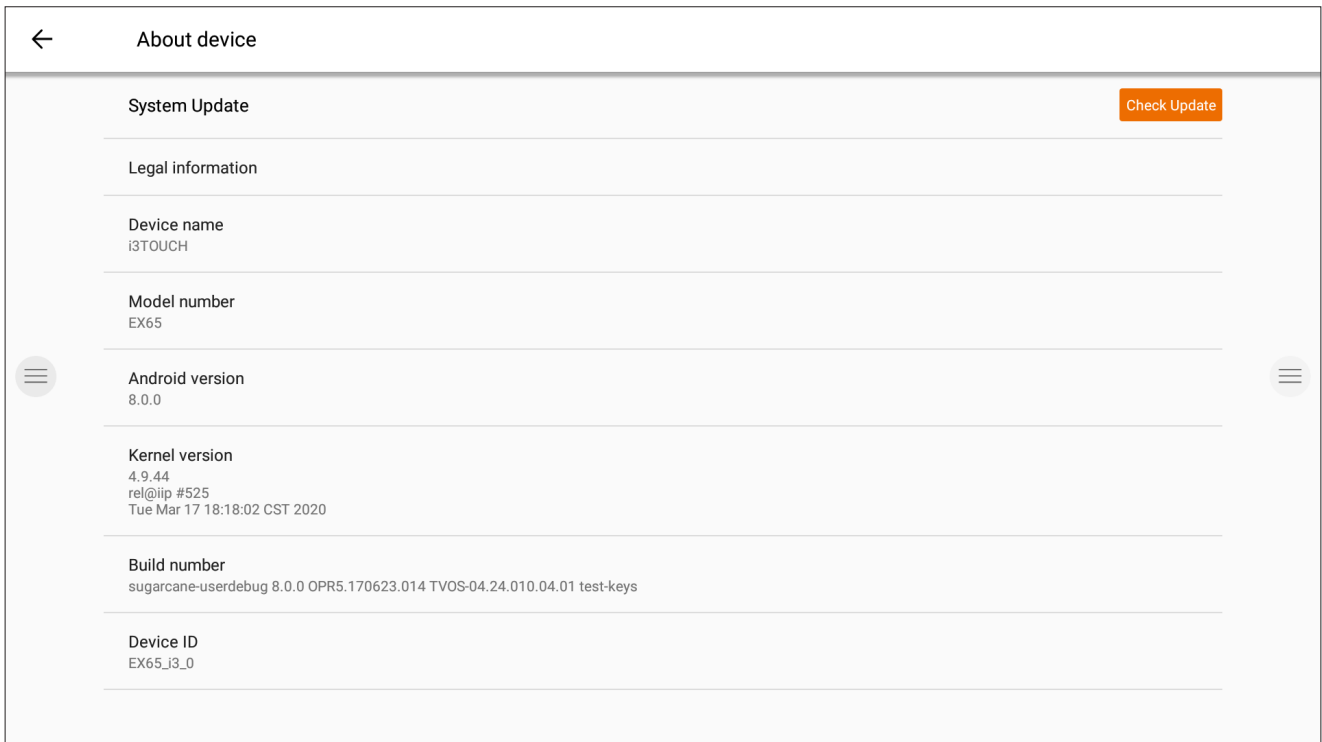

# Display settings.

Control the brightness of the i3TOUCH display in the Display settings menu.

The i3TOUCH EX also features an environment light sensor to automatically adjust the brightness.

Turn "Automatic Brightness Control" on to activate this feature.

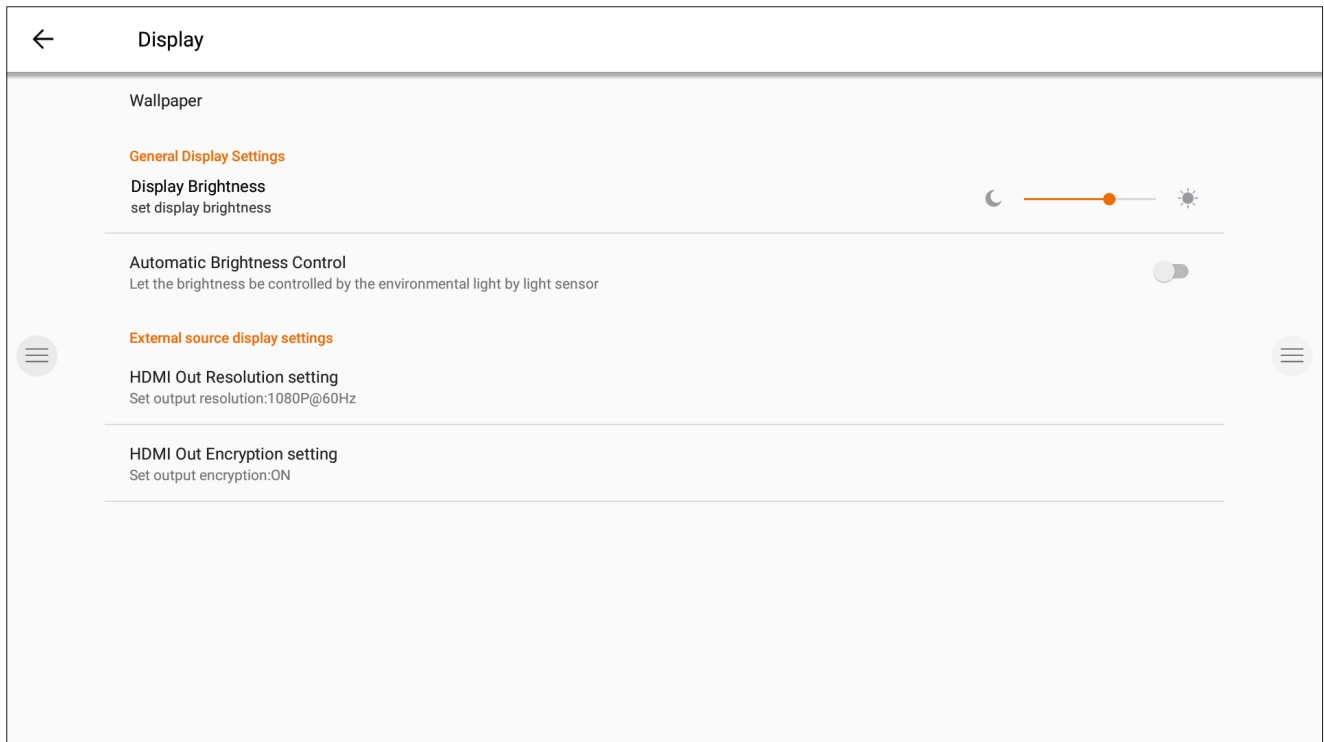

# Audio settings.

Adjust the "Sound Output Settings" and pre-defined audio environment settings.

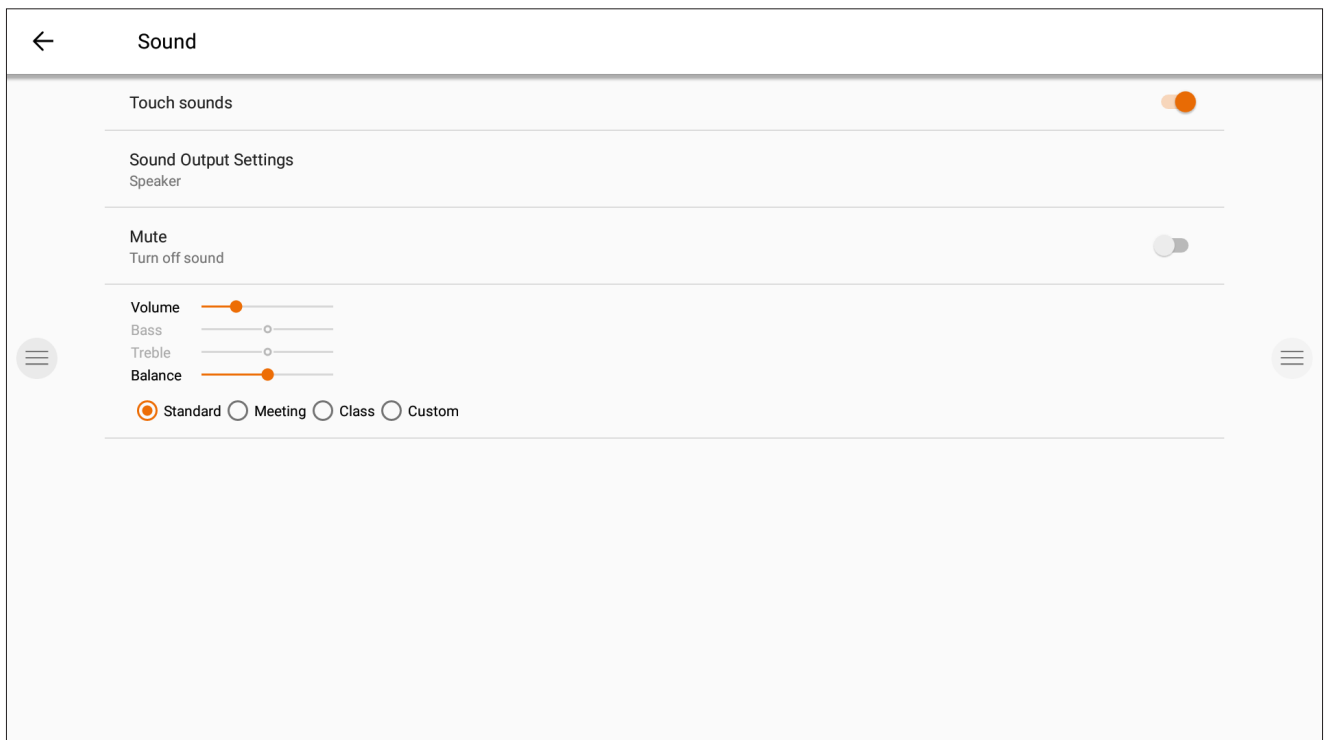

# Startup and shutdown.

Adjust the display's behavior during startup and shutdown.

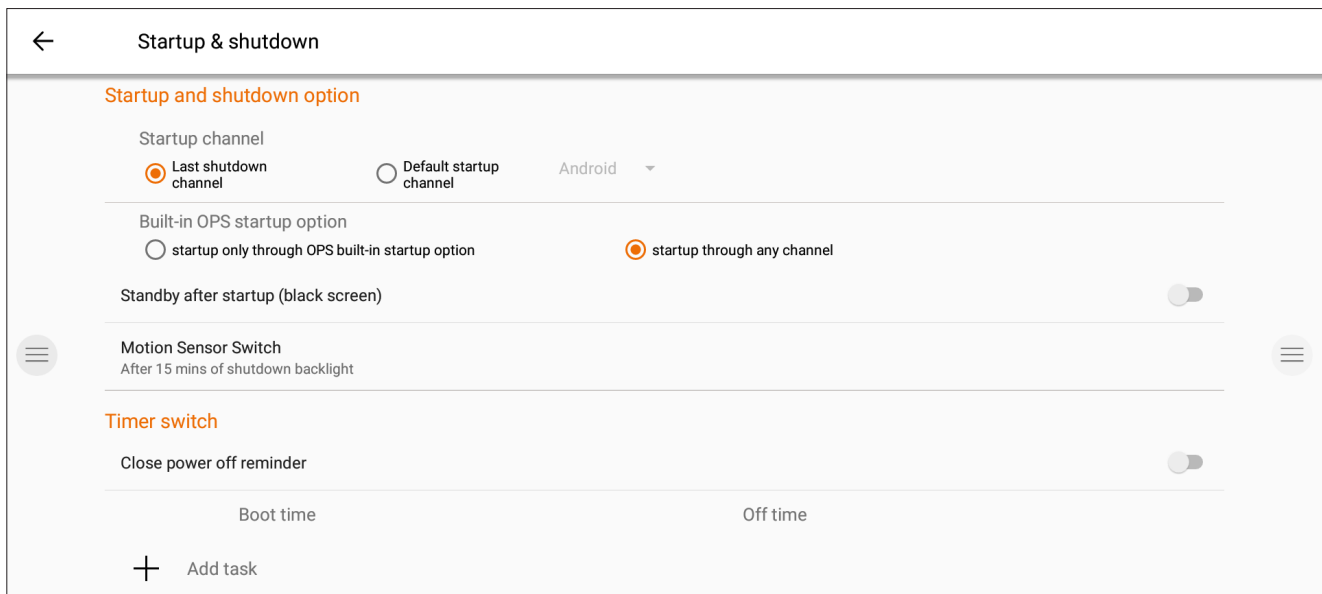

- Define the active video channel after startup:
  - A. Last active video channel before shutdown.
  - B. Always startup on specific video channel (default: Android).
- Define when the OPS Built-in computer should startup (if installed):
  - A. Only after switching to the video channel input.
  - B. Startup on any channel (startup together with display).
- Enable / Disable the Motion Sensor.
  - If the motion sensor does not detect presence/movement in the room for 15 minutes, the display will automatically shut down.

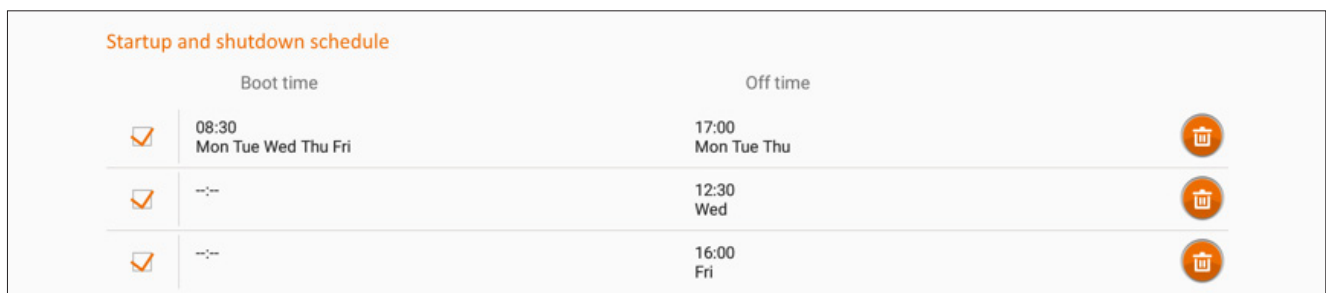

Set an automatic time-based schedule for the device to start up and shut down. Up to 3 scheduling tasks can be defined. Example:

- Automatically start up every weekday at 8:30 AM.
- Automatically shut down every Monday, Tuesday, and Thursday at 5 PM.
- Automatically shut down every Wednesday at 12:30 PM.
- Automatically shut down every Friday at 4 PM.

Note: The display will provide a warning reminder before shutting down, to allow a user to manually cancel the task.

# Multi-function button.

The multi-function button can be found on the rightside of the display. According to the settings you configure, this button will react accordingly.



Possible configuration settings are:

1. Off  
The multi-function button doesn't perform any action.
2. Input source  
Quickly switch to the predefined video input source.
3. Freeze image  
Freeze the current displayed image. The image will be paused until you press the button again.
4. Windows: Task view  
Trigger the task view on a Windows computer connected with USB-C or inserted as OPS.
5. Windows: Function key  
Perform the predefined function key on a Windows computer connected with USB-C or inserted as OPS.
6. Screen capture  
Capture the current image on screen and import into the whiteboard application.

The action of the multi-function button can be defined in the Settings menu.

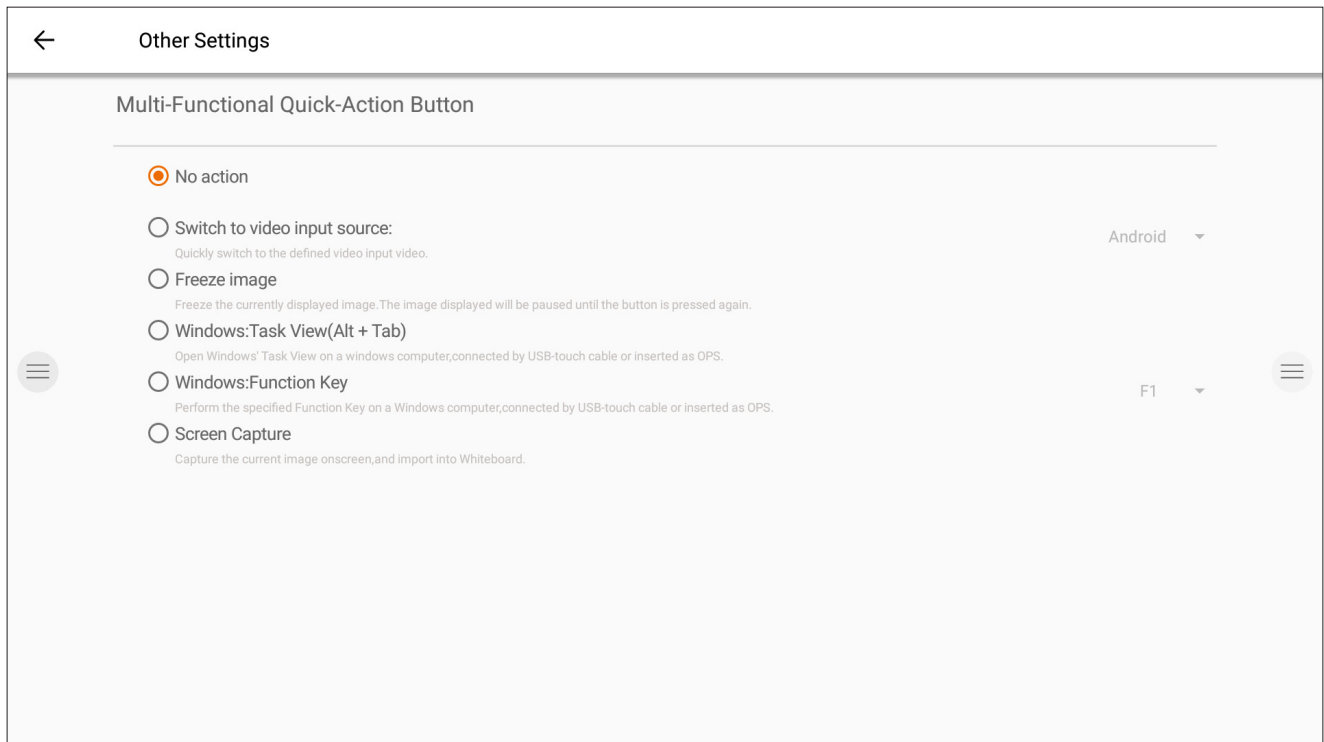

Note: The Task View and Function Key requires: A computer connected via USB, or the internal OPS computer. This computer needs to be the active video signal.

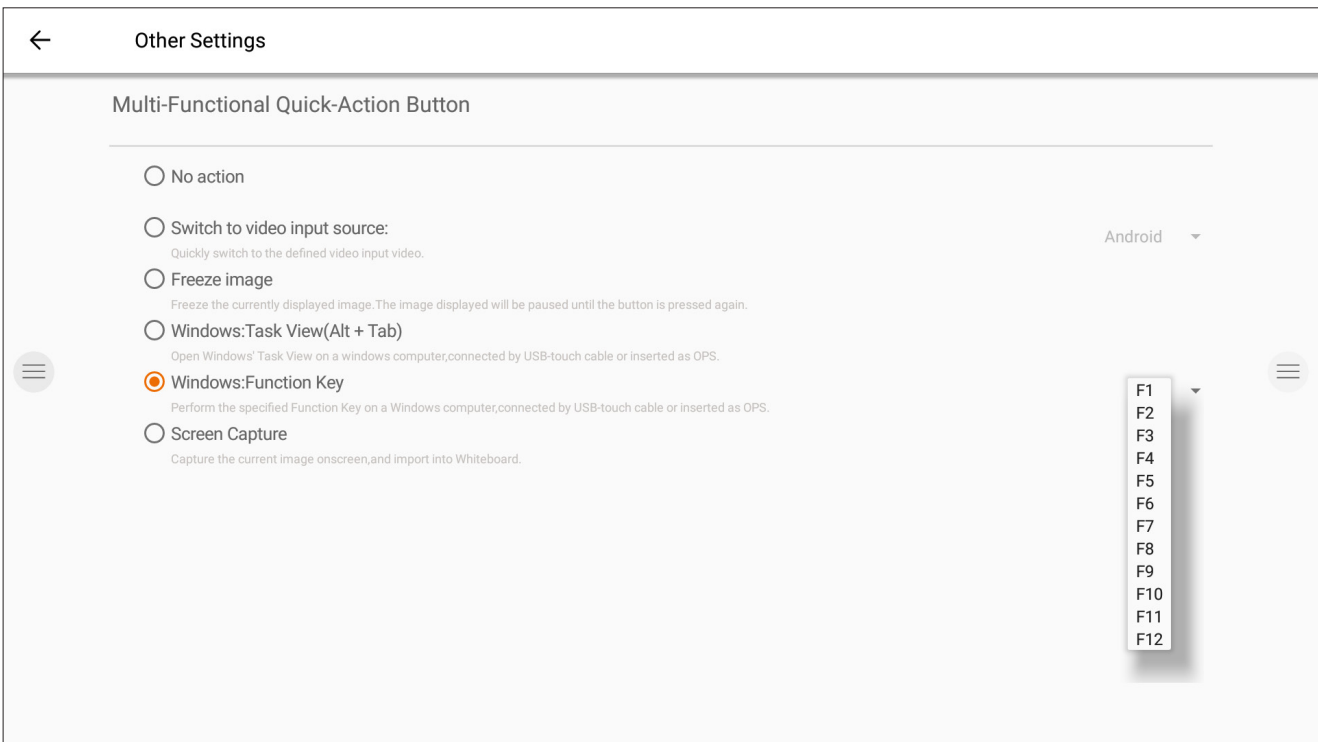
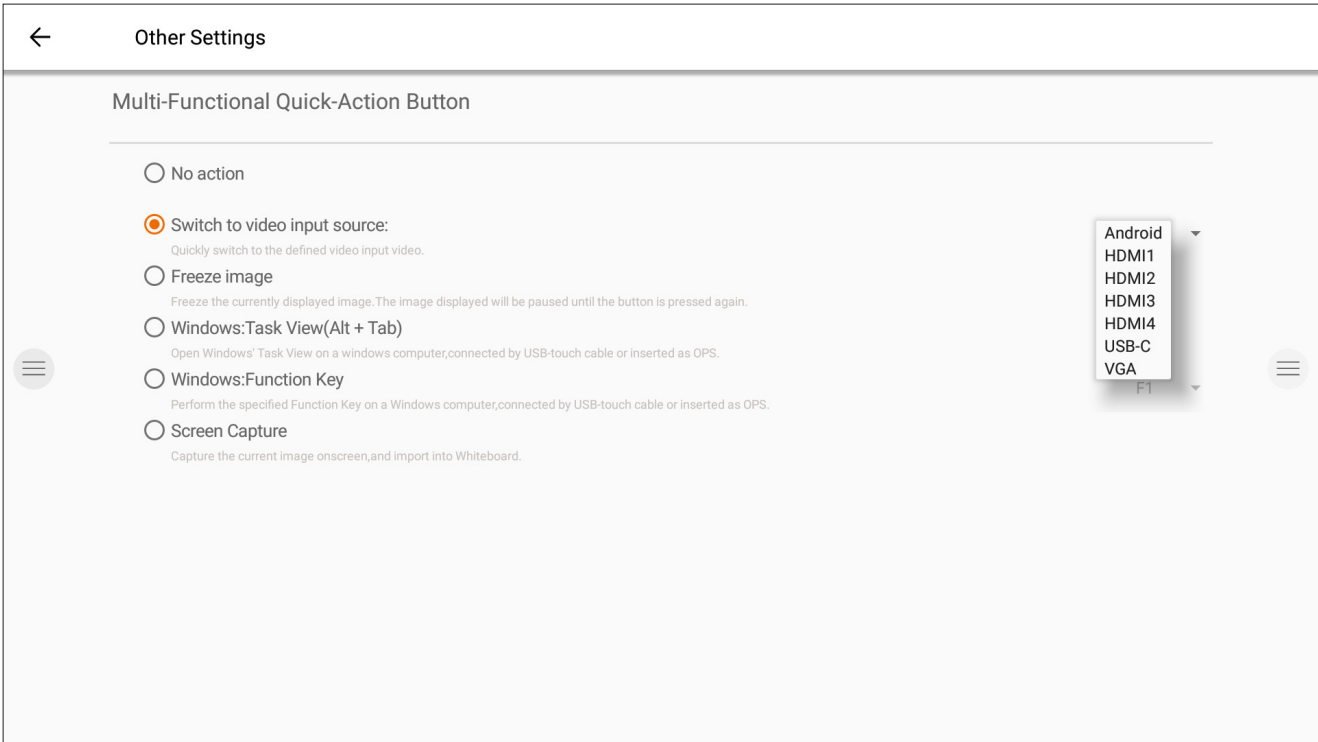

# Whiteboard

## Initial calibration.

Upon first start-up of the whiteboarding application, you will be asked to calibrate the four-finger erase gesture. Follow the instructions on screen to calibrate and activate this quick-erase gesture.

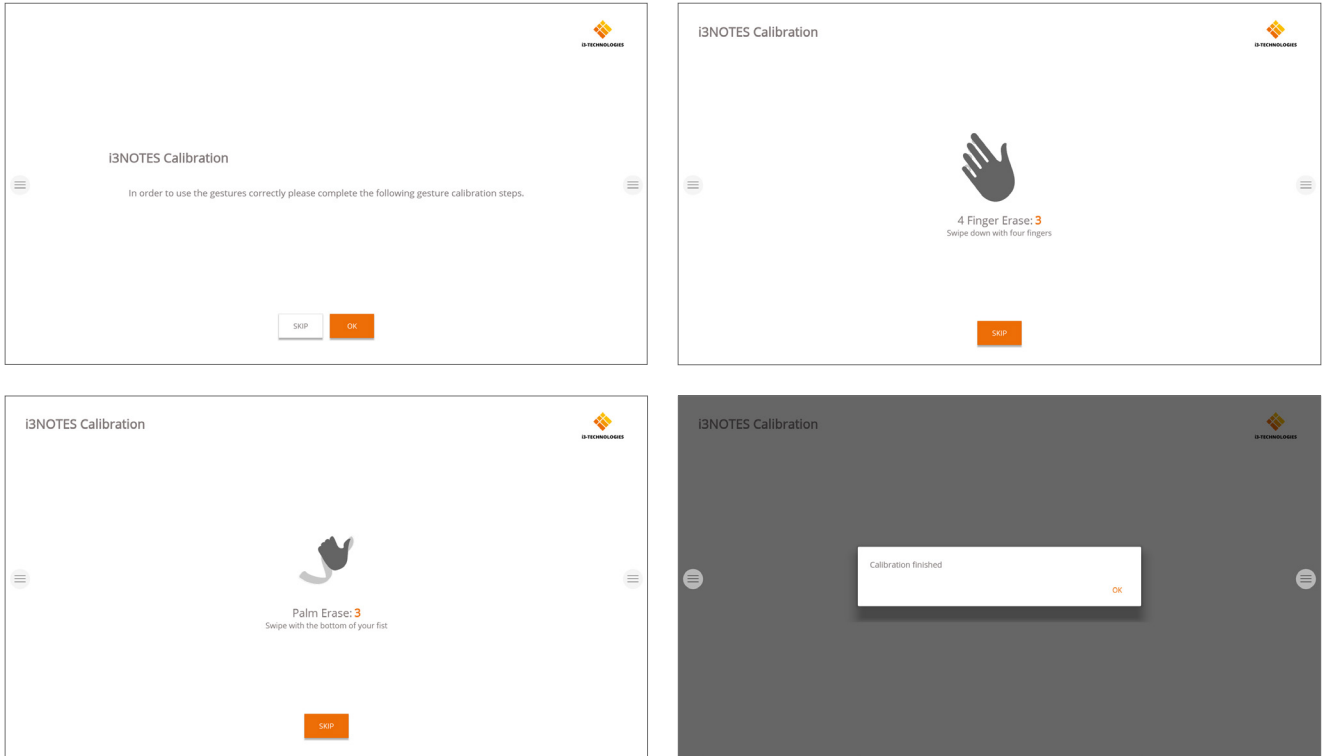

## Floating tools menu.

Clicking on the floating tools menu will activate it and show 6 options.

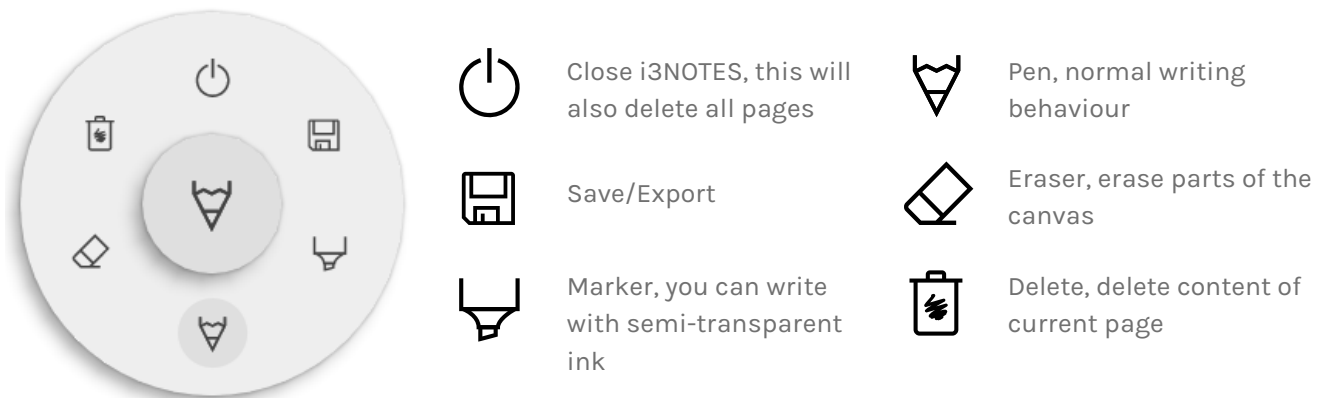



## **Marker, Pen & Eraser**

By selecting one of the canvas tools (marker, pen or eraser) it will open a second level of options. Each tool has its own options, so changing width or color on one tool will not change it for another.

The slider is used to select the tool line thickness, the number at the top indicates the selected thickness ranging from 1 to 10. The 5 colored circles are pre-defined options to quickly change marker or pen colors.

The plus icon ("+") can be used to select a custom color for that tool. After selecting a custom color, the plus icon will be replaced by the selected color. In order to change this again, long press on the custom color circle and the color selection window will show up again.

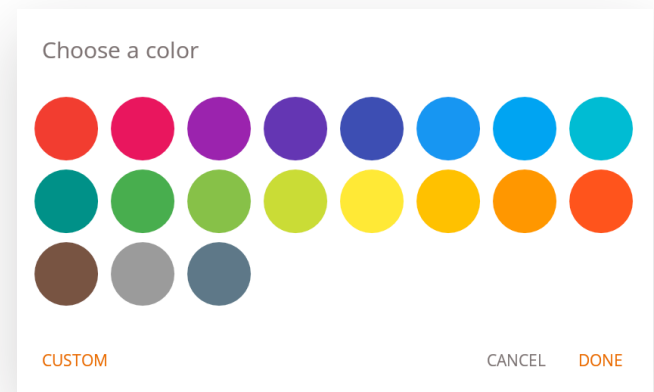

## **Close**

This will close the whiteboard application and deletes all pages permanently. There is no option to retrieve deleted content. You will be asked if you want to save/export your notes first, before closing.

## **Save / export**

The whiteboard application supports multiple save and export options (adjustable in admin settings).

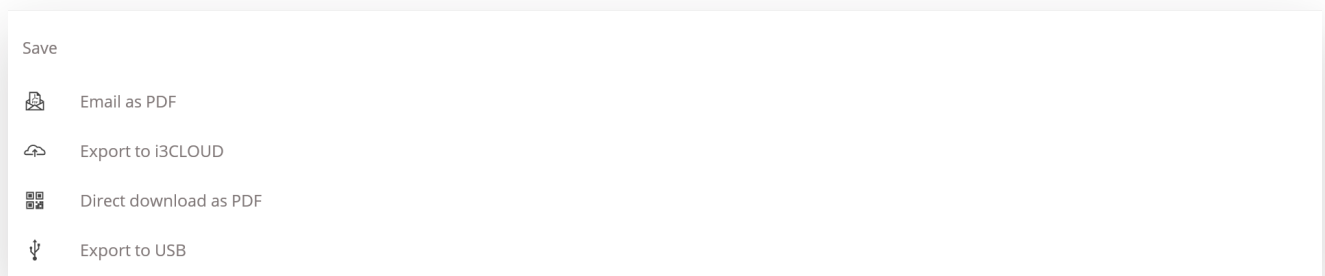

## Email as PDF

You can email the content of the whiteboard to yourself and/or others using one of the 3 available mail options.

### Use i3NOTES

This option will use the i3-Technologies mail service. Enter the email address to whom you want to send the PDF to. You can enter multiple email addresses separated by a space (" ").

### Use Microsoft Exchange

This option uses your Outlook account to send the mail. You will need to login first so that the whiteboard application will receive permission to use your account to send the mail. After successfully logging in and giving the required permissions you can select to stay logged into your Microsoft Exchange account on this device. By default it will not remember and after sending the mail your login credentials will be deleted from the system.

Enter the email address that you want to send the PDF to, you can enter multiple email addresses separated by a space (" "). There are also 2 other options:

- Get meetings: This will get all your calendar events from today. On selecting one it will add all email addresses of that event and add them to the mailing list.
- Get contacts: Will fetch your contacts from Microsoft Exchange.

*A Microsoft Exchange account is a work or school email account.*

*The organization that gave you the Exchange email account is running a Microsoft Exchange Server, or is using Microsoft Office 365 which uses Exchange Server to provide email.*

### Use SMTP

With this option you can use your own SMTP mailing server to send the PDF. Enter the login credentials and SMTP server address to open a connection. If the default SMTP setting gives a connection error you will be given more advanced SMTP options to connect to your SMTP server.

The "Sender's Email" will be pre-filled with the email address that you used to login on your SMTP server.

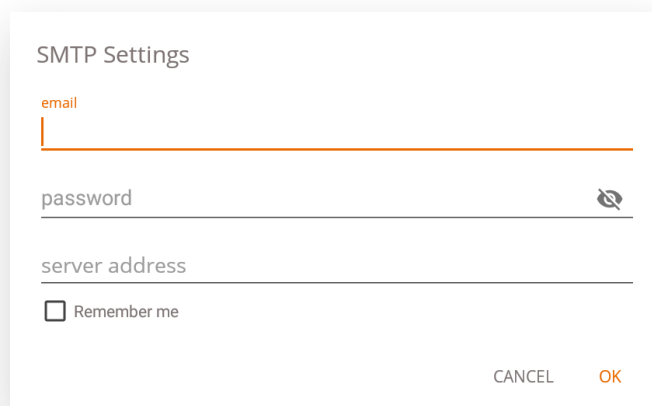

SMTP Settings

email

password

server address

Remember me

CANCEL OK

Some SMTP servers allow to send mail from a different email address. In the receiving email address field enter the email address that you want to send the PDF to, you can enter multiple email addresses separated by a space (" ").

## **Export to i3CLOUD**

After logging in on your i3CAMPFIRE or i3LEARNHUB account, you can export the whiteboard into your personal library.

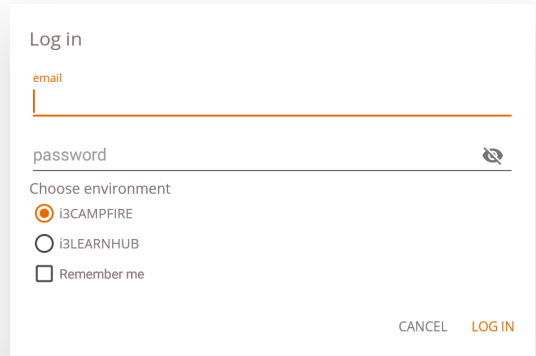

## **Direct download as PDF**

With this option you can download your notes directly to your phone using a QR code. There are 2 options for this.

### **Use internal network**

This option will make the direct download available only on the current network, in order to download the PDF both devices will have to be connected to the same local network. After closing the QR dialog the PDF will immediately be unavailable for download.

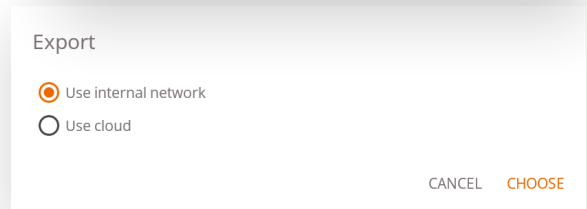

*Required: your network firewall will need to allow peer-to-peer connections.*

### **Use cloud**

The cloud option will export the PDF to the i3-Technologies cloud server and make it publicly available to download for everyone that scans the QR code. After 2 hours the PDF will automatically be removed from our server.

## **Export to USB**

This export option allows the user to save the PDF onto an external storage device. Only FAT32 storage devices are currently supported. The PDF will be saved in the root folder of the connected storage device.

## Delete

The delete option will remove all contents of the current open page without deleting the page from your tab bar. After pressing OK your notes will be permanently removed.

## Whiteboard bar

The tab bar is used to switch between different pages. Each page is numbered by an incremental id that defines the export order. The current visible page will be indicated by a darker colour.

Press the plus icon ("+") on the right side to add new pages.

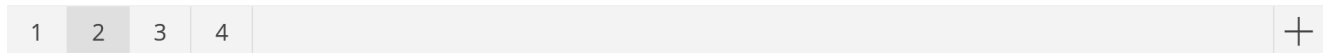

Long press a page number in the tab bar to remove it. This will not only remove the contents of that page but also remove the page itself from the list and update the page numbers of the remaining pages. This action is permanent.

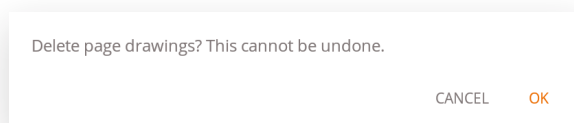

## Whiteboard canvas

This is the biggest part of the whiteboard. Here, you can write using the canvas tools.

### Passive stylus

The passive stylus writes with **black** digital ink by default. At the top of the pen is an eraser, just like a pencil. Turn around your pen to automatically erase parts of the canvas.

### Finger writing / drawing

At start-up of the whiteboard application, touching the canvas with a finger (or fingers) will activate the eraser function on default. This allows for the quickest note-taking experience: open whiteboard, write with stylus, erase with finger.

Changing the drawing tool, or its thickness or color will modify the finger-touch behavior, until the whiteboard is closed and reopened again. The whiteboard canvas supports multi-touch writing.

# ■ Annotating

The annotate interface is very similar to the whiteboard interface. This consists of 2 main parts:

1. Floating Tools Menu
2. Annotation Canvas

## Floating tools menu.

Clicking on the floating tools menu will activate it and show 6 options.



Close i3OVERLAY, this will also delete all notes



Pen, normal writing behaviour



Export to whiteboard



Eraser, erase parts of the canvas



Marker, you can write with semi-transparent ink



Pointer, will hide notes and make the background interactive again

### 🔌 Close annotation

This will close the annotate application and delete all notes permanently, there is no option to retrieve deleted content.

### 📄 Export to whiteboard

This will make an image of your notes combined with the current background and send it to the whiteboard application. It will happen in the background, so you can continue working in the annotate application and once you return to the whiteboard application all your screenshots will be available in separate pages.

There are 2 export options:



#### 📷 Fullscreen Screenshot

This will take a screenshot off the entire visible screen and export it to the whiteboard application.

#### 📏 Crop Screenshot

This option will provide the user with a cropping view. The user can position and resize the rectangle exactly to the area he wants to screenshot. At the bottom there will be 2 buttons, to cancel the cropping and to submit and send it to the whiteboard application.



### **Marker, Pen & Eraser**

By selecting one of the canvas tools (marker, pen or eraser) it will open a second level of options. Each tool has its own options, so changing thickness or colour of one tool will not change it for another. The slider is used for selecting the tool writing thickness, the number at the top indicates the selected width ranging from 1-10. The 5 coloured circles are preselect options to quickly change marker or pen colour, the eraser will not have this option.



### **Eraser**

The eraser also has an other option in the second level of the floating tools menu. The delete option will permanently remove all notes from the current canvas.



### **Pointer**

The pointer option enables the user to interact with the device without needing to close the annotate application. This will hide the current notes but they will not be deleted, they will be temporarily saved in the background.

## **Annotation canvas**

This is the biggest part of the whiteboard. Here, you can write using the canvas tools.

## **Passive stylus**

The passive stylus writes with **black** digital ink by default. At the top of the pen is an eraser, just like a pencil. Turn around your pen to automatically erase parts of the canvas.

## **Finger writing / drawing**

At start-up of the annotate application, touching the canvas with a finger will activate the eraser function on default. This allows for the quickest note-taking experience: write with stylus, erase with finger.

# Browsing

For browsing the web, the i3SIXTY provides the Google Chrome application.

Usage instructions for the Google Chrome browser can be found at <https://support.google.com/chrome>.

# Present

Meeting attendees often bring their own devices to the meeting room. Laptops, smartphones, tablets, etc. The i3TOUCH EX provides multiple tools for streaming to and from other devices.

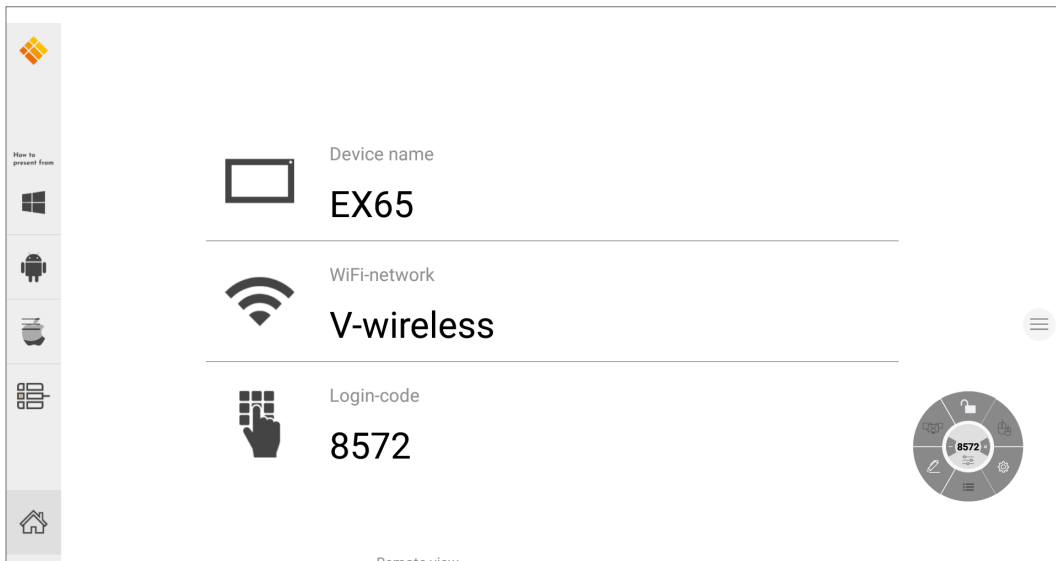

The i3TOUCH EX provides the i3ALLSYNC Wireless Presenting application to quickly and easily stream the screen content of any mobile device to the display.

## Download transmitting client software ...

i3ALLSYNC is our client software, available for most operating systems and devices, and can be downloaded from <https://i3-allsync.com>. The software is available for Windows OS, MacOS, and Android OS. iOS and MacOS can also use their integrated AirPlay function to connect with i3ALLSYNC without any software.

## ... and connect to the i3TOUCH EX with i3ALLSYNC transmitter software

Open the transmitting client i3ALLSYNC application on your device, and follow the instruction on-screen to insert the i3TOUCH EX credentials and cast your screen content.

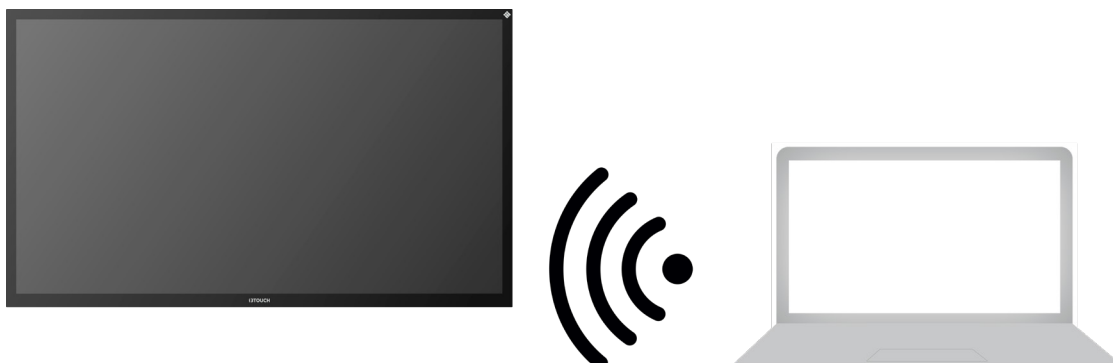

## i3ALLSYNC Menu and Settings

When opening the present feature, this is the interface you will see.

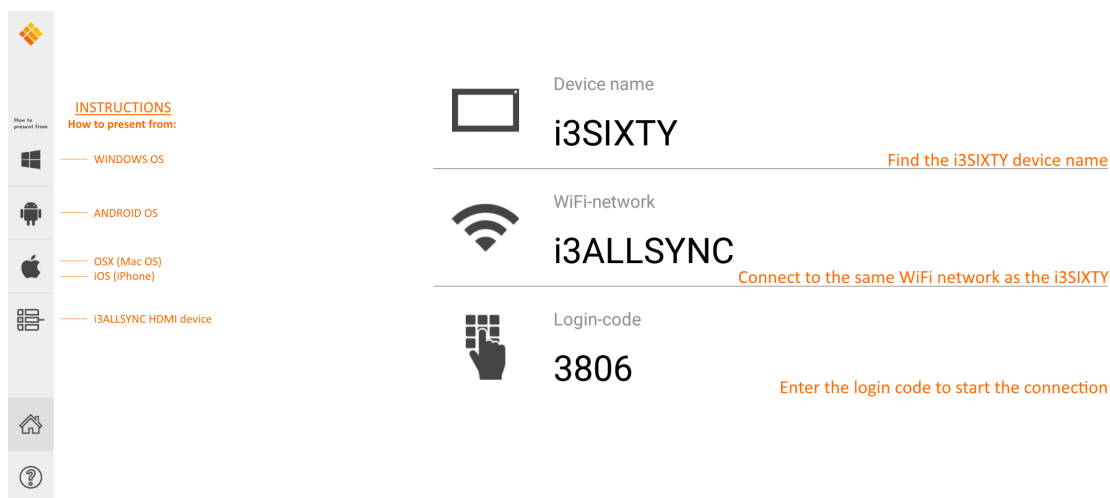

The i3ALLSYNC application offers some settings and tools in the floating circular menu.

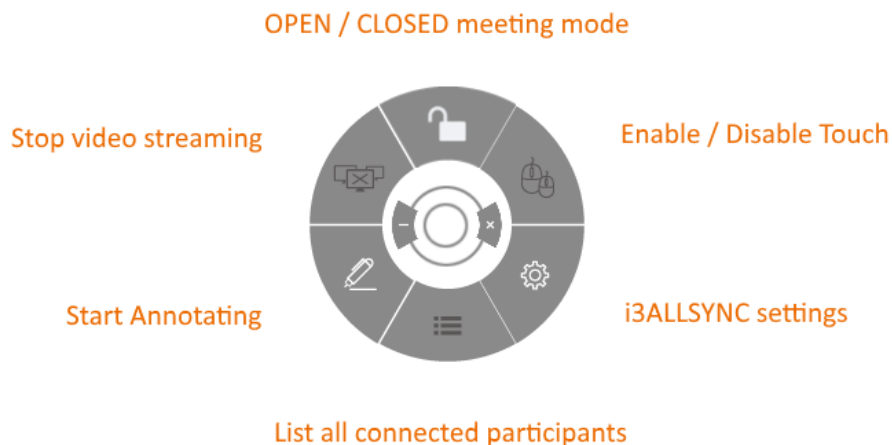

### Stop video stream

Press this button to stop the shared content from all connections.

### Start annotating

Press this button to start the annotating function of the i3TOUCH EX. (This button behaves exactly as the Annotate button in the hamburger menu).

### List all connections

Available only in the CLOSED Meeting Mode. Press this button to display a list with previews of the connected users that are standby to share their screen content. Press the play button on the preview to display the screen content.



## Open / closed meeting mode

Use the Meeting Mode button to change the meeting dynamic according to the type of your meeting.

**OPEN:** Allows anyone to connect and immediately show the screen content.

**CLOSED:** Allows anyone to connect, however, the controls to display the screen content are on the i3TOUCH EX. A connected user is standby in the background, until the screen content is activated through the List button.



Closed Mode  
(presenter starts  
each video stream)



Open Mode  
(everyone can  
video stream freely)

Closed Mode is best suited for a presentation-type meeting (or part of the meeting). The person standing at the display is the operator and switches between the screen content.

Open Mode is better suited for a conference-type meeting (or part of the meeting) where every connected user can take over and show their screen content.

## Enable / disable touch

Allow or deny the touch input on the screen of the i3TOUCH EX to control the connected computer.

*NOTE: Touch functionality only works via the i3ALLSYNC Transmitting clients on Windows and MacOS.*

## Use the i3ALLSYNC HDMI transmitter (optional accessory)

i3-Technologies also offers the i3ALLSYNC HDMI Transmitter (purchased separately) for meeting attendees (guests) that can't or won't install the client software. Once the i3ALLSYNC HDMI Transmitter is paired only once with the display, you only need to plug in the HDMI and USB cable and press the button to immediately share the HDMI content on-screen.

## Connect to i3TOUCH EX with i3ALLSYNC HDMI transmitter (device not included).

If using the i3ALLSYNC HDMI Transmitter device, just connect and screensharing will start with the press of a button. The i3ALLSYNC interface provides useful instructions for each operating system to start the presentation.

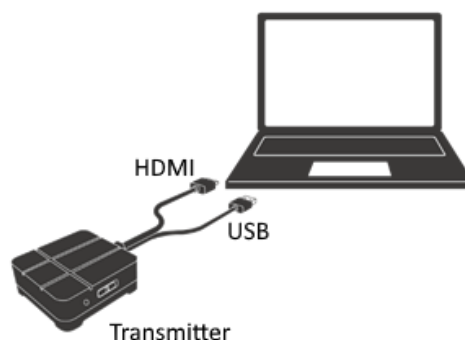

# Quick Troubleshooting

## Device fails to work normally

---

Remote control failure	<p>Check whether there are other objects between remote control and equipment control receiving window, thus leading to failure of remote control.</p> <p>Check whether the battery electrode in the remote control is correct.</p> <p>Check whether the batteries of the remote-control needs to be replaced.</p>
Machine has automatically shut down	<p>Verify sleep settings in the settings app.</p> <p>Check whether there is sudden power outage.</p> <p>The system will automatically shut down if the interactive external video channel has no signal for 5 minutes. Please check the input and connection of the video signal and/or modify sleep settings of the external device.</p>

## PC mode

---

Image lack of color, color is incorrect	<p>Check whether the VGA connector is well connected or has broken pins.</p> <p>Verify the correct operation of the VGA cable. (replace)</p>
---	--

## Touch operation

---

Touch function is not working	<p>Verify that the USB cable is properly connected to the computer. And that the length of the USB cable does not exceed 5 meter without USB amplifier / hub.</p> <p>Verify that the computer hardware and operating system supports touch screen operation. (Windows 7 or earlier does not support HID touch screens). (Some MacBooks do not support HID touch screens). (Older Linux kernels do not support HID touch screens).</p>
-------------------------------	---

## Video signal problems

---

No picture and no sound	<p>Check whether the machine has started.</p> <p>Check whether signal wire is well plugged, whether INPUT is corresponding to it.</p> <p>If in internal computer mode, check whether internal computer is started.</p>
With horizontal or vertical stripes or image dithering	<p>Check whether signal wire is well connected.</p> <p>Check whether other electronic equipment or power tools are placed around the machine.</p>
No color, color is weak, or image is weak	<p>Adjust chromatic and brightness or contrast in menu.</p> <p>Check whether signal wire is well connected.</p>

## Audio problems

---

Image but no sound	Check whether mute button is pressed for mute.
	Press VOL + / - to adjust volume.
	Check whether audio line is connected correctly.
Only one speaker has sound	Adjust sound balance in menu.
	Check whether computer sound control panel only sets up one sound channel.
	Check whether audio line is connected correctly.
HDMI output without sound	Check whether the external device is connected correctly.

---

## Maintenance

Proper maintenance can avoid many early faults and regular careful cleaning can make machine brand new. Please unplug power plug before cleaning and maintenance, to prevent electric shock.

### Clean screen

Please mix and stir even a little fabric softener or tableware detergent with alcohol.

Please use a soft cloth to be completely soaked in the mixture.

Please take out cloth and twist to half dry state to wipe machine screen.

Repeat for several times, pay attention not to squeeze water flow into machine when wiping machine.

### Clean face frame

Please use dry, soft, lint-free cloth to wipe front frame.

### No use of machine for a long time

In case of no use of machine for a long time, such as holiday, please make sure to unplug the plug to prevent any possible dangers caused by power supply ripple from lightning.

**HDMI**<sup>™</sup>

HIGH DEFINITION MULTIMEDIA INTERFACE

*NOTE The terms HDMI and HDMI High-Definition Multimedia Interface, and the HDMI Logo are trademarks or registered trademarks of HDMI Licensing LLC in the United States and other countries.*