



10920 Madison Ave
Cleveland | Ohio | 44102 | USA
+ 1 216 281 1100
www.Meriam.com
(800) 817-7849

A trusted leader in measurement
and calibration solutions.

User Manual

meriGauge® Plus System

meriGauge® Plus Gauge

meriSense Smart Sensor

meriSuite CG Application



Content

meriGauge® Plus System	1
<i>Content.....</i>	<i>2</i>
General information.....	5
<i>Notification Statements.....</i>	<i>5</i>
<i>Glossary.....</i>	<i>6</i>
General warnings and cautions.....	7
<i>Preventing injury.....</i>	<i>7</i>
<i>Safety Symbols</i>	<i>7</i>
<i>Disclaimer: A special condition for the aluminum case</i>	<i>8</i>
<i>Choose the proper gauge and sensor for the right location ..</i>	<i>8</i>
<i>Sample labels for General Purpose gauges</i>	<i>9</i>
<i>Sample labels for Intrinsically Safe gauges</i>	<i>10</i>
Sensors	13
<i>Make a pressure connection.....</i>	<i>13</i>
<i>meriSense information</i>	<i>14</i>
Gauge	17
<i>Batteries</i>	<i>17</i>
<i>Connect the gauge to a sensor.....</i>	<i>19</i>
<i>The display.....</i>	<i>20</i>
<i>Backlight in the LCD display.....</i>	<i>21</i>
<i>Display functions.....</i>	<i>21</i>
<i>What does the Zero (Ø) key do?.....</i>	<i>22</i>
<i>Data Log Lite and Data Log Pro.....</i>	<i>23</i>
<i>Information key.....</i>	<i>24</i>
<i>List of Measurement Units.....</i>	<i>27</i>
<i>Auto Off (Automatic shutoff)</i>	<i>28</i>

<i>Prepare the meriGauge Plus for storage</i>	<i>28</i>
<i>Do not use the USB in hazardous locations</i>	<i>28</i>
Application.....	29
<i>meriSuite CG and USB Drivers required</i>	<i>29</i>
Specifications.....	30
<i>Approvals</i>	<i>30</i>
<i>Display Specifications</i>	<i>31</i>
<i>Dimensional Specifications</i>	<i>31</i>
<i>Material specifications</i>	<i>32</i>
<i>Ingress specifications</i>	<i>32</i>
<i>Altitude specifications.....</i>	<i>32</i>
Safety.....	33
<i>Hazardous locations use.....</i>	<i>33</i>
<i>Intrinsic Safety Control Drawing for the meriGauge Plus gauge 9R525.....</i>	<i>34</i>
<i>Intrinsic Safety Control Drawing for the meriSense sensors 9R526</i>	<i>35</i>
<i>EC Declaration of Conformity – MGP7000X</i>	<i>36</i>
<i>EC Declaration of Conformity – MS700X.....</i>	<i>37</i>
<i>EC Declaration of Conformity – MGP7000.....</i>	<i>38</i>
<i>EC Declaration of Conformity – MS700.....</i>	<i>39</i>
Maintenance and cleaning	40
<i>Protect your sensors from dust</i>	<i>40</i>
<i>Inspect the vent on the sensors.....</i>	<i>40</i>
<i>Hazardous Material and Recycling Compliance</i>	<i>41</i>
Part numbers	42

Help	43
<i>Register your product.....</i>	<i>43</i>
<i>Find downloads and documents.....</i>	<i>43</i>
<i>For repair or calibration</i>	<i>44</i>
<i>Troubleshooting checklist.....</i>	<i>46</i>
<i>Meriam Contact Information</i>	<i>47</i>

General information

Notification Statements

Disclaimer

Every precaution has been taken in the preparation of this manual. Nevertheless, Meriam assumes no responsibility for errors or omissions or any damages resulting from the use of the information contained in this publication, including, without limitation, incidental, special, direct or consequential damages. MERIAM MAKES NO REPRESENTATIONS OR WARRANTIES WITH RESPECT TO THE ACCURACY OR COMPLETENESS OF THE CONTENTS HEREOF AND SPECIFICALLY DISCLAIMS ANY IMPLIED WARRANTIES OF MERCHANTABILITY OR FITNESS FOR ANY PARTICULAR PURPOSE. Meriam reserves the right to revise this publication and to make changes from time to time in the content hereof without obligation to notify any person of such revision or changes.

In no event shall Meriam be liable for any indirect, special, incidental, consequential, or punitive damages or for any lost profits arising out of or relating to any services provided by Meriam or its affiliates.

It is not possible for Meriam to identify all foreseeable uses or misuses, therefore all persons involved in commissioning, using, or maintaining this product must satisfy their self that each intended application is acceptable.

Copyright

This publication is proprietary to Meriam and no ownership rights are transferred. Neither this manual, nor any of the material contained herein, may be reproduced without the prior written consent of Meriam.

Trademark information

meriGauge® *Plus*, meriSense™, and meriSuite™ are trademarks of Meriam.

All other trademarks are the property of their respective owners.

Glossary

Words and phrases with their definitions.

Button or key

- A **button** always refers to an area on the screen that you can click to select functionality.
- A **key** always refers to hardware push buttons on the keyboard that you can press.

IS or Intrinsically Safe

The abbreviation “*IS*” is used in locations where there is limited space.

Meriam Calibration

Meriam calibration refers to any calibration completed at Meriam with *Meriam traceability*. Meriam calibration includes:

- Oven calibration.
- Multipoint Meriam adjustment.

User Calibration

User calibration refers to any calibration done outside of Meriam with *non-Meriam traceability*. User calibration includes:

- Multipoint user calibration or adjustment.

General warnings and cautions

Preventing injury







Failure to follow all instructions could result in injury:

- Read the entire manual before using the meriGauge Plus System.
- Understand the contents before using the meriGauge Plus System.
- Follow all safety warnings and instructions provided with this product.
- Meet or exceed your employer's safety practices.

Safety Symbols

The following table defines the safety symbols, signal words, and corresponding safety messages used in the manual. These symbols:

- Identify potential hazards.
- Warn you about hazards that could result in personal injury or equipment damage.

Safety Symbols	Explaining the symbols
	This is the Read Instruction Manual symbol. This symbol indicates that you must read the instruction manual.
	Indicates a potentially hazardous situation which, if not avoided, will result in death or serious injury.
	Indicates a potentially hazardous situation which, if not avoided, could result in death or serious injury.
	Indicates a potentially hazardous situation which, if not avoided, could result in minor or moderate injury.

Safety Symbols	Explaining the symbols
	Indicates information essential for proper product installation, operation or maintenance.

Disclaimer: A special condition for the aluminum case



Rare incidents: The case is made of aluminum. If you mount it in a location where a category 1 G apparatus is required, you must install it in such a way, that ignition sources due to impact and friction sparks are excluded.

Choose the proper gauge and sensor for the right location



- **Only** use Intrinsically Safe gauges and sensors in hazardous locations.
- **Never** use General Purpose *gauges* or *sensors* in hazardous locations.

Sample labels for General Purpose gauges

General Purpose—The meriGauge Plus label

See the figure of a sample label below.



General Purpose—The meriSense Absolute marking

See the figure of a sample General Purpose label below.

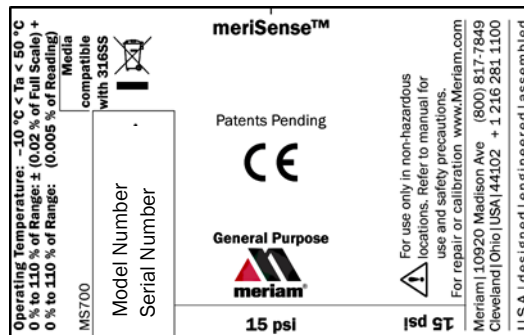

General Purpose—The meriSense Compound marking

See the sample General Purpose figure label below.

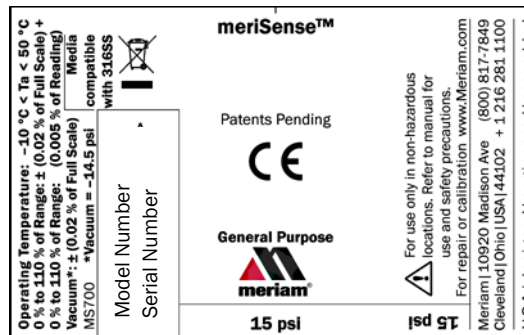

Sample labels for Intrinsically Safe gauges

Intrinsically Safe—meriGauge Plus Marking



Intrinsically Safe versions are identified by the nameplate located on the rear of the gauge. A sample of the Intrinsically Safe nameplate is shown below:





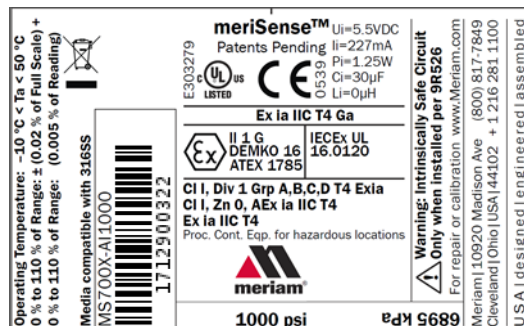

Intrinsically Safe—meriSense Absolute Marking

See the figure of a sample label below.



Intrinsically Safe—meriSense Compound Marking

See the figure of a sample label below.

Operating Temperature: $-10^{\circ}\text{C} < T_a < 50^{\circ}\text{C}$ 0% to 110% of Range: $\pm (0.02\% \text{ of Full Scale}) +$ 0% to 110% of Range: $(0.005\% \text{ of Reading})$ Vacuum*: $\pm (0.02\% \text{ of Full Scale})$ *Vacuum = -14.5 psi · Media compatible with 316SS	 MS700X-C10005 1712900322	 E303279		meriSense™ $U_i=5.5\text{VDC}$ Patents Pending $I_i=227\text{mA}$ $C_i=30\mu\text{F}$ $L_i=0\mu\text{H}$
				Ex ia IIC T4 Ga  II 1 G DEMKO 16 ATEX 1785 IECEx UL 16.0120
CI I, Div 1 Grp A,B,C,D T4 Exia CI I, Zn 0, AEx ia IIC T4 Ex ia IIC T4 Proc. Cont. Eqp. for hazardous locations				
				
5 psi				
35 kPa				
Warning: Intrinsically Safe Circuit Only when installed per 9R526 For repair or calibration: www.Meriam.com Meriam 10920 Madison Ave. (800) 817-7849 Cleveland Ohio USA 44102 + 1 216 281 1100 USA designed engineered assembled				

Intrinsically Safe gauges



MGP7000X meriGauge Plus gauges

Directives for the proper use of equipment are located on [9R525-Intrinsically Safe Control Drawing](#) that accompanies each MGP7000X shipped.

- Component substitution may impair Intrinsic Safety.
- Repairs must be made at Meriam to retain the Intrinsic Safety Certification.
- Service gauges only in a safe location.
- Replace batteries only in a safe location.

Intrinsically Safe sensors



MS700X meriSense sensors

Directives for the proper use of equipment are located on [9R526-Intrinsically Safe Control Drawing](#) that accompanies each MS700X shipped.

- Component substitution may impair Intrinsic Safety.
- Repairs must be made at Meriam to retain the Intrinsic Safety Certification.
- Service sensors only in a safe location.

Sensors

Make a pressure connection

Make a good NPT connection

Each meriSense detachable sensor has a 316 stainless steel 1/4 in. male NPT connection for direct mounting.

- The threads should be coated with a pipe sealant compound before installation.
- Tighten to finger tight plus 1.5 turns to 3 turns using a 23 mm (7/8 in.) wrench.

Remember: The gauge will face the same direction as the Meriam logo on the sensor. See the Meriam logo in the red circle in the figure below.



Use only a wrench on the hex fitting

NOTICE

Never rotate a meriSense sensor by turning the meriGauge Plus gauge.

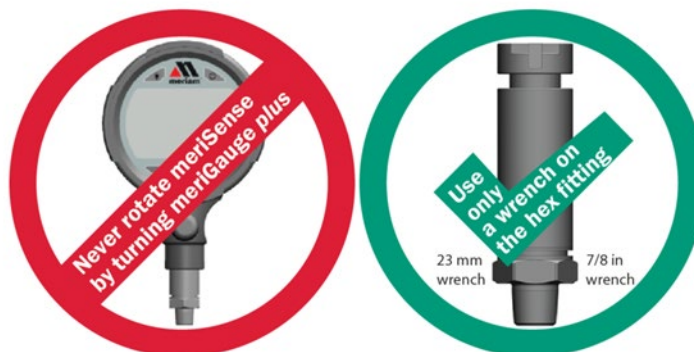

meriSense information

Intrinsically Safe pressure ranges and range limits

MS700X meriSense

Contact sales@meriam.com to purchase these parts and for more information about the following part numbers:

+ 1 216 281 1100 or (800) 817-7849.

MS700X meriSense sensors		
Part number	Ranges	Type
ZMS700X-AI0005	0 psi to 5 psi	Absolute
ZMS700X-CI0005	-15 psi to 5 psi	Compound
ZMS700X-AI0015	0 psi to 15 psi	Absolute
ZMS700X-CI0015	-15 psi to 15 psi	Compound
ZMS700X-AI0030	0 psi to 30 psi	Absolute
ZMS700X-CI0030	-15 psi to 30 psi	Compound
ZMS700X-AI0050	0 psi to 50 psi	Absolute
ZMS700X-CI0050	-15 psi to 50 psi	Compound
ZMS700X-AI0100	0 psi to 100 psi	Absolute
ZMS700X-CI0100	-15 psi to 100 psi	Compound
ZMS700X-AI0300	0 psi to 300 psi	Absolute
ZMS700X-CI0300	-15 psi to 300 psi	Compound
ZMS700X-AI0500	0 psi to 500 psi	Absolute
ZMS700X-CI0500	-15 psi to 500 psi	Compound
ZMS700X-AI1000	0 psi to 1 000 psi	Absolute
ZMS700X-CI1000	-15 psi to 1 000 psi	Compound
ZMS700X-AI3000	0 psi to 3 000 psi	Absolute
ZMS700X-CI3000	-15 psi to 3 000 psi	Compound

- Includes all combined effects of linearity, repeatability, hysteresis, stability, and temperature over the specified calibrated temperature range for one year.
- Not recommended for continuous use below 0.02 psi absolute.

General Purpose pressure ranges

For General Purpose questions about sensor pressure ranges, contact sales@meriam.com to purchase parts and for more information:

+ 1 216 281 1100 or (800) 817-7849.

Media compatibility

316 SS

Temperature limits

Operating temperature

-10 °C to 50 °C (14 °F to 122 °F)

- Up to 95 % RH non-condensing.
- No change in accuracy over operating temperature range.
- Gauge must be zeroed to achieve rated specification.

Process temperature

-10 °C to 50 °C (14 °F to 122 °F)

Warm-up time

Five (5) minutes.

Accuracy Statement

Absolute sensor

0 % to 110 % of Range: \pm (0.02 % of Full Scale) +
0 % to 110 % of Range: (0.005 % of Reading)

Compound sensor

0 % to 110 % of Range: \pm (0.02 % of Full Scale) +
0 % to 110 % of Range: (0.005 % of Reading)
Vacuum*: \pm (0.02 % of Full Scale)

*Vacuum = -14.5 psi

Pressure limits

Operating pressure limits



- Do not exceed the pressure limits listed in [the sensor pressure ranges](#) section for the MS700X meriSense.
- Failure to operate within the specified pressure limits could result in injury.

Overrange limit

Overrange pressure means the value is outside the calibrated upper or lower range.

- Up to 110 % of range, meriGauge Plus displays the accurate pressure.
- Above 110 %, it flashes red. This indicates that the applied pressure exceeds the calibrated range.

Note: *If the calibrated pressure range is exceeded, the pressure displayed may not be accurate*

- Above 120 %, it flashes red and displays dashes.

Burst pressure limit



Burst pressure is the point at which the sensor may mechanically leak.

Rated PSI	Burst Pressure
5	10 times
15	6 times
30	6 times
50	6 times
100	4 times
300	4 times
500	3 times
1000	3 times
3000	3 times

Gauge

Batteries

Know your batteries

A list of batteries for the meriGauge Plus that have been approved (Intrinsically Safe) for use in Hazardous Locations.

No substitutions are allowed.

- Duracell MN1500
- Duracell PC1500
- Energizer EN91
- Panasonic LR6XWA
- Rayovac 815
- Varta 4906

Note: *The meriGauge Plus is powered by four 1.5 volt AA size batteries.*

- **Never** mix batteries—not by manufacturer or by size, by capacity, or by chemistry.
- **Never** mix old and new batteries.
- **Remove** all four batteries in the meriGauge Plus at the same time.
- **Replace** all four batteries with batteries from the same package or with the same expiration date.

Install the batteries

Do not change batteries in hazardous locations.

1. Turn over the meriGauge Plus so the display faces down.
2. Remove the four screws on the battery cover with the Phillips head screwdriver by turning them counterclockwise.
3. Remove plastic battery cap.
4. Insert the four AA batteries.

Note: *Pay attention to the positive (+) and negative (-) battery polarity markings at the bottom of the compartment.*

5. Replace plastic battery cap.

Note: Must be installed for use in hazardous location.

6. Replace the battery cover.
7. To secure the cover, torque the screws clockwise 0.56 N-m (5 in-lbs) maximum.

Watch for low battery indicators

The battery indicator on the display shows the current charge.

Note: *Be prepared to change batteries when you see the outline of the battery icon when the outline of the battery icon flashes.*

Using the Backlight reduces your battery life

Turn it off to optimize battery life.

Refer to the battery manufacturers' instructions

Visit the website of the battery manufacturer to learn more about the care, storage, shipping, use, disposal, and recycling of your batteries.

Consider inserting new batteries

NOTICE

Before you begin data logging or running a Rate of Change.

Connect the gauge to a sensor

- The gauge will face the same direction as the Meriam logo on the sensor. See the circled Meriam logo in the figure below.
- With the sensor already installed in your process, slide the gauge housing on the meriSense until it fully connects.



The display

The keys

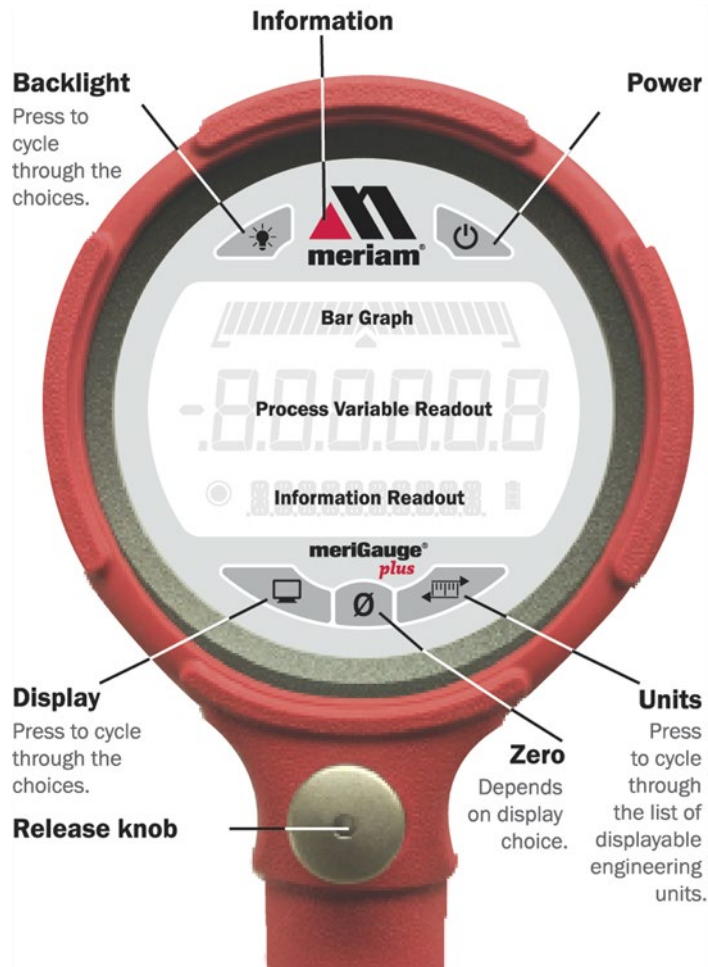

The bar graph

The bar graph displays a live indication of the current pressure applied to the sensor as a % of Full Scale.

Note: When you press the **Information** key, the bar graph displays the remaining state of the charge for the batteries.

Backlight in the LCD display

White backlight

The white backlight has an automatic timeout. If you do not press any keys while the backlight is on, it automatically turns off after *1 minute*.

Note: *You can configure the backlight timeout with meriSuite CG.*

Levels of backlight intensity

Press the **Backlight** key to cycle through the choices:

- Low.
- Medium.
- High.
- Off.

Flashing red backlight

The flashing red backlight indicates an error condition. Possible error conditions are:

- Pressure has exceeded the calibrated accuracy of the meriSense.
- Pressure has fallen below the stated accuracy of the meriSense.

Note: *The red backlight overrides the white backlight.*

Display functions

When meriGauge ships, it has eleven (11) display functions.

1. Home screen	7. T.OFF, T.ON (Tare)
2. MIN (Minimum)	8. AVG (Average)
3. MAX (Maximum)	9. RATE (Rate of Change)
4. +RV (Relief Valve Test - Release)	10. DATA LOG (Data Log)
5. -RV (Relief Valve Test - Reseat)	11. Time & Temperature
6. + / - (Accuracy)	

What does the Zero (Ø) key do?

In normal measure mode

If the sensor is within a tolerance band around zero, press and hold the **Zero** key to zero the pressure measurement and to reset the Min and Max measurements.

Note: *The tolerance band is approximately ± 1 % of the Full Scale pressure value of the sensor.*

In Min or Max mode

Press and hold the **Zero** key to reset the Min and Max measurement. However, this does not zero the pressure measurement.

In Tare mode

When the Tare is off (T.OFF), press and hold the **Zero** key to turn on Tare (T.ON) and to set the Tare value at the current pressure measurement.

Likewise, when the Tare is on (T.ON), press and hold the **Zero** key to turn off the Tare mode.

In Average mode

Press and hold the **Zero** key to restart the rolling average.

In Relief Valve Test mode

The **Zero** key resets the values +RV (release) and –RV (reseat) to the current pressure measurement.

In Data Log mode

Press and hold the Zero key until you see—**STARTING**—appear on the LCD display to start recording a new data log.

Press and release the **Zero** key to log one data point during On Demand type.

Holding the Zero key

The key must be held to perform the Zero or Tare mode. The displayed value(s) dashes out during the zero or tare process.

Data Log Lite and Data Log Pro

View the “BATT %” before you begin

Data Log Lite runs up to one hour.

Note: Do not start data logging if the outline of the battery icon is flashing.

Data Log Lite is limited to one data log

Data Log Lite can record and hold only one data log at a time.

Note: When you press and hold the **Zero** key while **DATA LOG** appears in the LCD display, a new data log begins to record over the existing data log.

Data Log Pro provides a maximum of 128 logs

Data Log Pro provides a maximum of 128 logs or a maximum of 100 000 data points.

Start the data logging process

1. Press the **Display** key until you see **DATA LOG** appear in the LCD display.
2. Press and hold the Zero key until you see **—STARTING—**. The data log symbol starts to flash indicating it is recording data. Data Log Lite records data every 15 seconds for one hour.
3. **—COMPLETE—**appears after one hour.

Note: Auto Off is suspended during data logging. If you selected 5 Minutes for Auto Off, then meriGauge Plus remains on 5 minutes after data logging completes, and then turns off.

Stop the data logging process

Here are some of the actions that can complete the data logging process before the one hour:

- Press and hold the **Zero** key until you see **—STOPPING—**.
- Press the **Power** key to turn off the meriGauge Plus.
- Remove the meriGauge Plus from a sensor.
- Connect the meriGauge Plus to the meriSuite CG app.
- The duration was reached that you selected in the **Setup** tab.

Information key

Where is the Information key on the meriGauge Plus?

The Information key is the red *triangle* in the Meriam logo.



What does the Information key normally display on the meriGauge Plus?

- *BATT %* displays the percentage on the bar graph and in digits or USB POWER displays.
- The type of pressure sensor displays.
- *CAL DATE* displays the date that Meriam calibrated the meriSense sensor.
- *USL* displays the Upper Specification Limit on the sensor.
- *LSL* displays the Lower Specification Limit on the sensor.
- *LT MAX %* displays the Life-Time Maximum that has been reached on the sensor.
- The characters *SENSOR F/W* display first and then they scroll across the screen from right to left to display *VER.* with the *version number* of the firmware.
- The characters *SENSOR S/N* display first and then they scroll across the screen from right to left to display *S/N* with the *serial number* of the sensor.
- The characters *SNSR NAME* display first and then they scroll across the screen from right to left to display the sensor's name.
- The characters *GAUGE F/W VER.* display first and then they scroll across the screen from right to left to display *VER.* with the *version number* of the firmware.
- The characters *GAUGE S/N* display first and then they scroll across the screen from right to left to display *S/N* with the *serial number* of the gauge.
- The characters *GAUGE NAME* display first and then they scroll across the screen from right to left to display the gauge's name.

What does the Information key display while DATA LOG appears on the bottom row on the screen?

It displays the version of Data Log that you have: LITE or PRO.

1. Turn on meriGauge Plus.
2. Press the **Display** key on the gauge until you see **Data Log**.
3. Press the **Information** key once to display the version of data logging on the gauge:
 - **VERS. PRO** for Data Log Pro.
 - **VERS. LITE** for Data Log Lite.

What additional information does the Information key display in Data Log Pro?

Press the **Information** key six more times to see these six notices in the following order on the gauge:

AVAIL PTS.

- The *available* points tell you how many points are available in the gauge memory.
- The maximum number of points is 100 000.

AVAIL LOG

- The *available log* tells you how many data logs are available in the gauge memory.
- The maximum number of data logs is 128.

TYP. MEAS

Type tells you which data logging type was selected in **Setup** tab in meriSuite CG for the gauge. There are four types:

- TYP. MEAS refers to *Individual Samples*.
- TYP. AVG refers to *Average only*.
- TYP. AVG+PK refers to *Average with peaks*.
- TYP. DEMAND refers to *On Demand*.

Note: See the **Parameter Choices** section in the meriSuite CG User Manual 9R609 for a description of the data log types.

INTERVAL.

- Interval tells you the hours, minutes, or seconds that was selected in Setup tab in meriSuite CG for the data log.
- Interval displays dashes "-----" when *On Demand* is the data log type. On Demand has no intervals.

PTS. CFG.

- *Points Configured* tells you the number of points that was selected in **Setup** tab in meriSuite CG for the data log.
- But, *Points Configured* displays dashes "-----" if the gauge was configured for a fixed amount of time.
- Additionally, *Points Configured* displays dashes "-----" if the *Forever* duration was selected.

TIME CFG.**(CFG. MIN, CFG. HR, CFG. DAYS, HR MIN, DAY HR)**

- *Time Configured* tells you the duration that was selected in **Setup** tab in meriSuite CG for the data log.
- But, *Time Configured* displays dashes "-----" if the gauge was set to record a specific number of points.
- Additionally, *Time Configured* displays dashes "-----" if the *Forever* duration was selected.

What does the Information key do while DATA LOG records data?

Toggle key

While recording data, the **Information** key becomes a toggle key. It toggles between the first notice: *Log and point number* and the second notice: *days, hours, minutes, and seconds*.

- Both notices display the remaining duration of points or time.
- When the duration is set for **Minutes, Hours, Days, or Points**, then the *point number* counts down to zero.
- When the *point number* reaches zero, the gauge displays --COMPLETED--.

Formats used in the LCD display

- Hours, minutes, and seconds in this format: HH.MM.SS
- Days, hours, minutes, seconds. DDD HH.MM.SS
- When the days, hours, minutes, and seconds reach zero, the gauge displays --COMPLETED--.

Note: When **Days** or **Forever** are selected for duration, then three additional (3) digits display for days up to a maximum of 366 days. The other six (6) digits display as hours, minutes, and seconds.

List of Measurement Units

Measurement units are stored on a sensor

- Each meriSense sensor stores a complete list of measurement units.
- The meriSuite CG app gives you the ability to configure specific measurement units to specific sensors.
- The meriGauge Plus displays only the units selected in meriSuite CG for individual sensors.
- When the meriSense pressure sensors are shipped, the common 12 measurement units are available. These 12 units appear in bold type in the following Standard Units list.

Standard Units (non-custom)

1. PSI	12. CMW4C	23. KG/M2
2. INW20C	13. CMW60F	24. PA
3. INW4C	14. MW20C	25. HPA
4. INW60F	15. MW4C	26. KPA
5. FTW20C	16. MW60F	27. MPA
6. FTW4C	17. INHG0C	28. BAR
7. FTW60F	18. MHG0C	29. MBAR
8. MMW20C	19. CMHG0C	30. ATM
9. MMW4C	20. MMHG0C	31. OZ/IN2
10. MMW60F	21. TORR	32. LB/FT2
11. CMW20C	22. KG/CM2	

Measurement units can be changed on a sensor

- You must use the meriSuite CG app to select or deselect the Standard Units on a particular sensor from the preceding list.
- By pressing the **Units** key on the gauge, you cycle through all the configured units within the currently attached meriSense that can be displayed on meriGauge plus.

Auto Off (Automatic shutoff)

How long will the gauge remain on if I leave it unattended?

- The default setting is *Always On*.
- You can configure the timeout for the Auto Off with meriSuite CG.

The timeout for Automatic Shutoff is suspended

The timeout for the Auto Off is suspended:

1. During data logging sessions to prevent an accidental loss of information.
2. While the gauge is connected to a computer.

Auto Off is automatically re-instated after data logging is completed and after the gauge is disconnected from the computer.

Prepare the meriGauge Plus for storage

Remove the batteries to store the gauge

1. Remove the batteries from the meriGauge Plus to store it for **30 days or more**.
2. Follow the battery manufacturer's instructions for storing your batteries.

Store the meriGauge Plus

The recommended storage temperature for the meriGauge Plus is between $-20\text{ }^{\circ}\text{C}$ to $70\text{ }^{\circ}\text{C}$ ($-4\text{ }^{\circ}\text{F}$ to $158\text{ }^{\circ}\text{F}$).

Do not use the USB in hazardous locations



Connect a USB in safe locations only.

Application

meriSuite CG and USB Drivers required

First—Install meriSuite CG

1. Read the [meriSuite™ CG Installation Instructions 9R606](#) on the [Downloads](#) page on [www.meriam.com](#).
2. The instructions have a link that you can click to download the meriSuite CG setup file.
3. Follow the on-screen instructions.

Second—Install USB Drivers

1. Read the [USB Drivers Installation Instructions 9R607](#) on the [Downloads](#) page on [www.meriam.com](#).
2. The instructions have links that you can click to download the required USB Driver.
3. Follow the on-screen instructions.

Third—Read the meriSuite CG User Manual



1. Read the [meriSuite CG User Manual](#) on the [Product Manuals](#) page on [www.meriam.com](#).

Note: *You are now ready to use the meriSuite CG app to configure, to view data, and to create reports for the meriGauge Plus System.*



Specifications

Approvals

MGP7000X Intrinsically Safe Model

ATEX	 II 1 G; Ex ia IIC T4 Ga DEMKO 16 ATEX 1809X
cULus Listed	Intrinsically Safe, Exia Class I, Div. 1 Groups A, B, C, D: T4 Class I, Zone 0, AEx ia IIC T4 -10° C < Ta < +50° C
Entity parameters:	Po = 1.249W, Io = 227mA, Co = 35 μF, Lo=0 μH, Uo = 5.5VDC  CE Compliance

MS700X Intrinsically Safe model

ATEX	 II 1 G; Ex ia IIC T4 Ga DEMKO 16 ATEX 1785
IECEX	Ex ia IIC T4 Ga -10° C < Ta < +50° C IECEX UL 16.0120
cULus Listed	Intrinsically Safe, Exia Class I, Div. 1 Groups A, B, C, D: T4 Class I, Zone 0, AEx ia IIC T4 -10° C < Ta < +50° C
Entity parameters:	Pi = 1.249W, Ii = 227mA, Ci = 30 μF, Li=0 μH, Ui = 5.5VDC  CE Compliance

MGP7000 and MS700 (General Purpose models)

 CE Compliance

Display Specifications

Display rate

The meriGauge Plus displays five (5) updates per second.

LCD Display

- The LCD displays six (6) digits.
- The numerical display height is 17.8 mm (0.7 in.)

Dimensional Specifications

The meriGauge Plus gauge
with the meriSense smart sensor

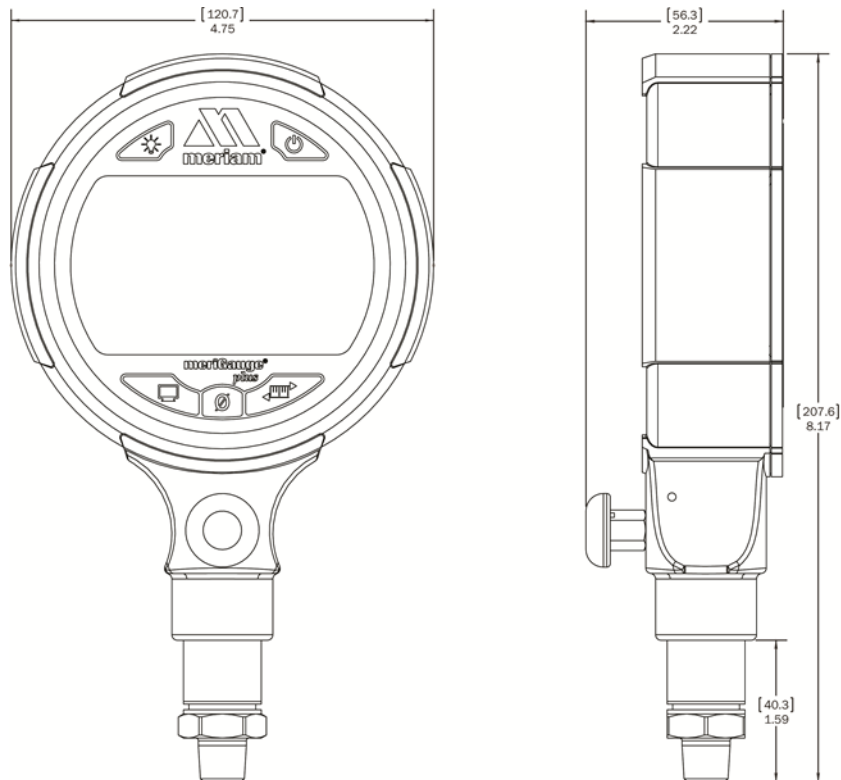

Material specifications

meriGauge Plus aluminum housing

The meriGauge Plus housing is made of these two types of aluminum:

- A356 Aluminum.
- 6061 Aluminum.

Disclaimer: Special condition for the aluminum case



Rare incidents: The case is made of aluminum. If you mount it in a location where a category 1 G apparatus is required, you must install it in such a way, that ignition sources due to impact and friction sparks are excluded.

meriSense

The meriSense is made from 300 series stainless steel.

Ingress specifications

- The meriGauge Plus is rated IP66.
- The meriSense is rated IP67.

Altitude specifications



Do not use the meriSense at an altitude above 2000 m (6561 ft).

Safety

Hazardous locations use

Intrinsically Safe Model

The meriGauge Plus MGP7000X and meriSense MS700X include certification for Intrinsically Safe operation.

Refer to the *Intrinsic Safety Control Drawing* for [meriGauge 9R525](#) and for [meriSense 9R526](#) in the *Safety* section in this manual for more information.

Hazardous locations and non-hazardous locations (safe locations)

The following table identifies model numbers and locations of acceptable use:

Model Number	Location	Non-hazardous location (Safe location)	Hazardous location
MGP7000	General Purpose	Yes	NO
MGP7000X	Intrinsically Safe	Yes	Yes
MS700	General Purpose	Yes	NO
MS700X	Intrinsically Safe	Yes	Yes

Intrinsic Safety Control Drawing for the meriGauge Plus gauge 9R525

NON-HAZARDOUS LOCATION
MGP7min
MGP7minx

HAZARDOUS LOCATION
MGP7minx

The device complies with the following standards:

- UL 913 - Edition 8 - Revision 8 - Revision Date: 2017/03/05
- CSA C22.2 NO. 137-92 - Edition 3 - Revision Date: 2007/06/03
- IEC 60079-11 - Edition 5 - Revision Date: 2014/01/01
- IEC 60079-0 - Edition 2 - Revision Date: 2015/07/01
- EN 60079-11 - Edition 2 - Revision Date: 2015/07/01
- EN 60079-0 - Edition 2 - Revision Date: 2015/07/01
- UL 60079-0 - Edition 6 - Issue Date: 2015/07/01
- UL 60079-11 - Edition 5 - Issue Date: 2015/07/01
- CSA C22.2 NO. 60079-0 - Edition 3 - Issue Date: 2015/01/01
- CSA C22.2 NO. 60079-11-2 - Edition 2 - Issue Date: 2014/02/01

CERTIFICATION MARKINGS

MGP7minx
NOTE: FOR MODEL NUMBER R ALLOWED TO BE R-9 OR A-Z.
INTRINSICALLY SAFE
SERIES 9R525

ATTENTION: LA SURETÉ EN LA SCÉNARIO DE HAZARDOUS LOCATION

HAZARDOUS LOCATION

1. EQUIPMENT DISTRIBUTION SHALL BE LIMITED TO THE FOLLOWING:
 - Do not open or service until it is permissible in explosion atmosphere.
 - Do not use any battery other than the following approved batteries:
 - Duracell FC1500
 - Rayovac 1100MA
 - Varta 4R05
 - Eveready 1N91
2. To prevent ignition of flammable or explosive atmospheres.
3. Approved separation equipment must be installed by a qualified electrician and must be installed in a straight line between open-circuit voltage and short-circuit current.
4. Selected approved separation must be fully installed in providing intrinsically safe circuits for the application and have the 'Type' or 'Version' of the approved separation equipment clearly marked for not exceeding 10, and the type of the approved separation must be clearly marked on the frame of the intrinsically safe equipment. All devices in Table 1.
5. Approved separation must be used in combination unless permitted by the associated approval certificate.
6. SPECIAL INSTALLATION CONDITIONS BY THE INSTALLING: - The thread shall be according with ISO 961.3 AND ISO 961.1 - The head of the screw shall be galvanized type and the fastener shall only be replaced by identical one.

Serial/Component for SMD100

1. Marking of the serial number and model number to prevent impact and removal from the gauge.

Certification Markings

NOT TO SCALE

meriam

meriGauge Plus

9R525

A



EC Declaration of Conformity

This is to declare, in accordance with Directive 2014/34/EU, that the following product(s) are designed and manufactured in accordance with Annex II of 2014/34/EU.



The manufacturer attests on their own responsibility that the apparatus has been constructed in accordance with the principles of good engineering in safety matters, and that any routine verification and test required by Clause 27 of EN 60079-0:2012+A11:2013 has been successfully completed.

Manufacturer

Meriam Process Technologies, a Scott Fetzer Company
10920 Madison Avenue, Cleveland, Ohio 44102, USA

Product Description

meriGauge plus MGP7000X Series

 0539  II 1 G
DEMKO 16 ATEX 1809X
Ex ia IIC T4 Ga

Entity parameters:

Po = 1.249 W Io = 227 mA
Co = 35 μ F Lo=0 μ H
Uo = 5.5 VDC

This Declaration is based on compliance with the following standards at the time of original delivery:

Regarding Hazardous Environments

- EN 60079-11:2012 Electrical apparatus for explosive gas atmospheres - Intrinsic safety 'i'
- EN 60079-0:2012 Electrical apparatus for explosive gas atmospheres - General requirements +A11:2013

Regarding Ingress Protection

- EN60529:1991 Degrees of Protection Provided by Enclosures (IP Code: IP66)
+A1:2000+A2:2013

Regarding Electromagnetic Compatibility (EMC) for Handheld Class A device

meriGauge plus MGP7000X Series compliant with EMC Directive 2014/30/EU

- EN 61326-1:2013 Electrical equipment for measurement, control and laboratory use-EMC requirements

The manufacturer also attests that the products listed above conform to the essential requirements of RoHS Directive 2011/65/EU and WEEE directive 2012/19/EU by self-declaration.

For and on behalf of
Meriam Process Technologies,



19-APR-2017

John Merrill Date:
Standards Engineer
Meriam Process Technologies



EC Declaration of Conformity

This is to declare, in accordance with Directive 2014/34/EU, that the following product(s) are designed and manufactured in accordance with Annex II of 2014/34/EU.

The manufacturer attests on their own responsibility that the apparatus has been constructed in accordance with the principles of good engineering in safety matters, and that any routine verification and test required by Clause 27 of EN 60079-0:2012+A11:2013 has been successfully completed.

Manufacturer

Meriam Process Technologies, a Scott Fetzer Company
10920 Madison Avenue, Cleveland, Ohio 44102, USA

Product Description

meriSense MS700X Series

Entity parameters:

Pi = 1.249 W Ii = 227 mA

Ci = 30 μ F Li=0 μ H

Ui = 5.5 VDC

 0539  II 1 G
DEMKO 16 ATEX 1785
Ex ia IIC T4 Ga

This Declaration is based on compliance with the following standards at the time of original delivery:

Regarding Hazardous Environments

- EN 60079-11:2012 Electrical apparatus for explosive gas atmospheres - Intrinsic safety 'i'
- EN 60079-0:2012 +A11:2013 Electrical apparatus for explosive gas atmospheres - General requirements

Regarding Ingress Protection

- EN60529:1991 +A1:2000+A2:2013 Degrees of Protection Provided by Enclosures (IP Code: IP67)

Regarding Electromagnetic Compatibility (EMC) for Handheld Class A device

meriSense MS700X Series compliant with EMC Directive 2014/30/EU

- EN 61326-1:2013 Electrical equipment for measurement, control and laboratory use-EMC requirements

The manufacturer also attests that the products listed above conform to the essential requirements of RoHS Directive 2011/65/EU and WEEE directive 2012/19/EU by self-declaration.

For and on behalf of
Meriam Process Technologies,



19-APR-2017

John Merrill Date:
Standards Engineer
Meriam Process Technologies



EC Declaration of Conformity

Manufacturer

Meriam Process Technologies, a Scott Fetzer Company
10920 Madison Avenue, Cleveland, Ohio 44102, USA

This Declaration is based on compliance with the following standards at the time of original delivery:

Regarding Ingress Protection

- EN60529:1991 +A1:2000+A2:2013 Degrees of Protection Provided by Enclosures (IP Code: IP66)

Regarding Electromagnetic Compatibility (EMC) for Handheld Class A device

meriGauge plus MGP7000 Series compliant with EMC Directive 2014/30/EU

- EN 61326-1:2013 Electrical equipment for measurement, control and laboratory use-EMC requirements

The manufacturer also attests that the products listed above conform to the essential requirements of RoHS Directive 2011/65/EU and WEEE directive 2012/19/EU by self-declaration.

For and on behalf of
Meriam Process Technologies,



19-APR-2017

John Merrill Date:
Standards Engineer
Meriam Process Technologies



EC Declaration of Conformity

Manufacturer

Meriam Process Technologies, a Scott Fetzer Company
10920 Madison Avenue, Cleveland, Ohio 44102, USA

This Declaration is based on compliance with the following standards at the time of original delivery:

Regarding Ingress Protection

- EN60529:1991 +A1:2000+A2:2013 Degrees of Protection Provided by Enclosures (IP Code: IP67)

Regarding Electromagnetic Compatibility (EMC) for Handheld Class A device

meriSense MS700 Series compliant with EMC Directive 2014/30/EU

- EN 61326-1:2013 Electrical equipment for measurement, control and laboratory use-EMC requirements

The manufacturer also attests that the products listed above conform to the essential requirements of RoHS Directive 2011/65/EU and WEEE directive 2012/19/EU by self-declaration.

For and on behalf of
Meriam Process Technologies,



19-APR-2017

John Merrill Date:
Standards Engineer
Meriam Process Technologies

Maintenance and cleaning

Protect your sensors from dust

Keep the dust cap on sensors

- Make sure you put the dust cap on the sensor after the meriGauge Plus gauge has been detached from the sensor.
- The dust cap protects both the *electrical contacts* and the *vent*.



Inspect the vent on the sensors

Do not block vent

1. If the vent becomes blocked, it will cause inaccurate measurements.
2. Meriam recommends that you visually inspect the vent area each time you use a meriSense sensor to make sure it is not blocked.

Cleaning sensors

NOTICE

- Use **only water** to clean sensors.
- **Do not use** solvents or cleaners.

Hazardous Material and Recycling Compliance

Compliant with European Union Directives

This product is compliant with these European Union Directives:

Directive	Description
RoHS Directive 2011/65/EU	Reduction of Hazardous Substances
WEEE 2012/19/EU	Waste from Electrical and Electronic Equipment Note: <i>The following marking indicates that you must not discard this electrical / electronic product in domestic household waste.</i> 

Part numbers

Contact sales@meriam.com for more information about these part numbers:

+ 1 216 281 1100 or (800) 817-7849

Part Numbers	Descriptions
Z9P1521	USB A to right angle mini B –3 ft black cable
Z9P1055-2	Protective Boot
Z9A1354	Hard carrying case
Z9A878	“AA” Battery kit (4 pack)
Z9P1641	Activation Key for Data Log Pro

Help

Register your product

We want you to get the most out of your purchase, and that starts with a few, easy registration steps.

1. Go to www.meriam.com
2. On the **Resources** menu, click [Register Your Product](#)

Note: Or, click the link in step 2 to go directly to **Register Your Product**.

Find downloads and documents

1. Go to www.meriam.com/resources page.
2. Or, on the [Resources](#) menu, select one of these categories to find the files you need.

Product manuals | User Manuals and Quick Start Guides

Downloads | Applications (apps), firmware, updates, installation instructions

Certifications | Certifications and approvals

SDS (MSDS) | Safety Data Sheets

Control Drawings | Intrinsically Safe Drawings

For repair or calibration

Contact Meriam for repair or calibration

Meriam offers service and calibration on your products by certified technicians.

Reminder: You must have the *model number* and *serial number* ready when you contact us.

You have three options for requesting service:

Option 1: Complete and submit the **For Repair & Calibration** online form.

1. Go to www.meriam.com and click the **Resources** menu button.
2. Move the mouse pointer over **For Repair & Calibration** to see these two options:
 - a. **Repair & Calibration.**
 - b. **RMA Request.**
3. Complete either one online.

Reminders:

- You can see an **estimated total** price using the online form.
- You must include *model* number and *serial* number.
- Select *Repair* or *Recalibration* as the **Service Type**.
- 4. Click the **Submit** button to send the form to Meriam.

Option 2: Download a form to print and send to Meriam.

1. Click **Service & Repair** to see the link for [Download form here](#) in the first paragraph. You can download it and complete it later.
2. You can scan this form and send it by e-mail to returnforms@meriam.com or fax it to us at:

+ 1 216 281 0228

USA and International Customers

Option 3: Call Meriam to request repair or calibration.

+ 1 216 281 1100

USA (800) 817-7849

Before you ship anything to Meriam

NOTICE

1. You must receive a RMA number from Meriam first.
2. Clearly write on the package or place a shipping label on it with the **RMA number** (Return Material Authorization Number).

Note: *we will return the gauge or sensor at **your expense** if we have not given you an RMA number.*

3. An RMA number must appear on all packages that arrive at Meriam to properly track, process, and repair your gauge.

Do you have any questions? Call Meriam

+ 1 216 281 1100

USA (800) 817-7849

Ship the box to

Meriam
10920 Madison Avenue
Cleveland | Ohio | 44102
USA

Troubleshooting checklist

The words “NO SENSOR” display on the gauge

Follow these steps to troubleshoot the meriGauge Plus connection with meriSense sensor when the message **NO SENSOR** appears:

1. Turn off the meriGauge Plus gauge.
2. Remove the gauge from the sensor.
3. Re-attach the gauge to the sensor.

Remember: *The gauge will face the same direction as the Meriam logo on the sensor. (You may hear it click when it locks in place.) See the Meriam logo in the red circle in the figure below.*



Note: *The locking pin prevents the gauge from accidentally disconnecting from the sensor.*

4. Turn on the meriGauge Plus gauge.

Note: *If the preceding steps do not work, contact [Meriam Sales](#).*

Meriam Contact Information

Address

Meriam Process Technologies
10920 Madison Avenue
Cleveland | Ohio | 44102 | USA

Telephone

US customers (800) 817-7849
International customers + 1 216 281 1100

Fax

US & International customers + 1 216 281 0228

E-mail addresses

Return Material Authorization / Service & Repair Department

returnforms@meriam.com

Sales

sales@meriam.com

Website

meriam.com

Find a local Meriam representative

Use this map to help you find a Meriam representative.

<http://www.meriam.com/representatives-map/>