



# VADDIO™ CLEARVIEW™ HD-20SE

## ClearVIEW HD-20SE High Definition, Robotic PTZ Camera

Model Number 999-6980-000 (North America)

Model Number 999-6980-001 (International)

Model Number 999-6980-000AW (North America) Arctic White Camera

Model Number 999-6980-001AW (International) Arctic White Camera



# Touchboards

**205 Westwood Ave, Long Branch, NJ 07740**

**Phone: 866-94 BOARDS (26273) / (732)-222-1511**

**Fax: (732)-222-7088 | E-mail: [sales@touchboards.com](mailto:sales@touchboards.com)**



## TABLE OF CONTENTS

Overview .....	3
Unpacking: .....	4
Front View with Feature Call-outs .....	5
Image: ClearVIEW HD-20SE HD PTZ Camera .....	5
Rear Panel Connections with Feature Call-outs .....	6
Image: ClearVIEW HD-20SE HD PTZ Camera .....	6
First Time Set-up with the ClearVIEW HD-20SE: .....	7
Image: Rear Panel Connections .....	7
Drawing: Dip Switch and Resolution Label on the Bottom of the ClearVIEW HD-20SE .....	7
Image: Basic Connectivity Example of the ClearVIEW HD-20SE .....	8
Installation Basics: .....	8
Compliance and CE Declaration of Conformity - ClearVIEW HD-20SE .....	9
Warranty Information .....	10
General Specifications: .....	11
Appendix 1: YPbPr Video Pin-Out for the HD-20SE Camera .....	11
EZ-Power Video RJ-45 Connector Pin-outs .....	12
Drawing: ClearVIEW HD-20SE Dimensions .....	12
Communication Specification .....	13
HD-20SE Command List (1/2) .....	13
HD-20SE Command List (2/2) .....	14
HD-20SE Inquiry List (1/1) .....	15
Table: HD-20SE OSD Menu Structure .....	16

## OVERVIEW:

The amazing ClearVIEW HD-20SE HD PTZ Camera quite literally combines all of the best features of the ClearVIEW HD-18, HD-19 and HD-20 HD PTZ cameras into ONE! The innovation of the HD-18 EZCamera™ Cat-5 interfaces, the low light capability of the HD-19 and the FULL HD performance of the HD-20 are all represented, and improved upon with the ClearVIEW HD-20SE. The ClearVIEW HD-20SE is clearly the best ClearVIEW ever, and here's why.

The HD-20SE is a native 1080p/60 camera using the latest 1/2.8-Type Exmor® high-speed, low noise CMOS image sensor technology with 2.38 Megapixels (total) and 2.14 Megapixels (effective). The ISP (image signal processor) is off-the-hook, not only, providing fast, razor-sharp auto-focus routines with incredible detail, realistic textures and vivid colors with an impressive low-light performance of 0.3 Lux color and 0.03 Lux (B/W). The lens is a 20X optical zoom multi-element glass lens with an impressive horizontal field of view of 63° on the wide end to 3.47° on the tele end. The outputs are simultaneous HDMI, YPbPr and HSDS™ (differential video for use with Quick-Connect™ Interfaces) and supports both drop frame and non-drop frame HD video resolutions of 1080p/60/59.94/50/30/25, 1080i/60/59.94/50 and 720p/60/59.94/50.

So to recap, latest technology, awesome ISP, superb low-light performance, powerful yet wide angle lens, lots and lots of video outs, drop and non-drop frame video, Full HD and there's more!

The ClearVIEW HD-20SE can be used stand-alone or with one of four Quick-Connect Interface options. The Quick-Connect SR (YPbPr out), Quick-Connect DVI/HDMI-SR (HDMI or DVI-D and YPbPr outs) and the Quick-Connect USB (USB 2.0 or IP-H.264 streaming with simultaneous HDMI and YPbPr outputs) and the Quick-Connect Universal CCU.

The ClearVIEW HD-20SE is an exceptional value and a remarkable camera for even the most demanding HD video applications including House of Worship productions, pro A/V system integrations, distance learning classrooms, live events, IMAG systems, UCC applications, videoconferencing, distance learning, lecture capture and more!. To top it all off, the ClearVIEW HD-20SE cameras are available in black or arctic white and are made in the USA.

## Intended Use:

Before operating the device, please read the entire manual thoroughly. The system was designed, built and tested for use indoors with the power supply provided. The use of a power supply other than the one provided or outdoor operation has not been tested and could damage the device and/or create a potentially unsafe operating condition.

## Important Safeguards:

Read and understand all instructions before using. Do not operate any device if it has been dropped or damaged. In this case, a Vaddio technician must examine the product before operating. To reduce the risk of electric shock, do not immerse in water or other liquids and avoid extremely humid conditions.



**Use only the power supply provided with the system. Use of any unauthorized power supply will void any and all warranties.**



Please do not use "pass-thru" type RJ-45 connectors. These pass-thru type connectors do not work well for professional installations and can be the cause of intermittent connections which can result in the RS-232 control line failing and locking up, and/or compromising the HSDS (high speed differential) signals. For best results please use standard RJ-45 connectors and test all cables for proper pin-outs prior to use and connection to Vaddio product.



ClearVIEW  
HD-20SE in  
Black

ClearVIEW  
HD-20SE in  
Arctic White  
(AW)

### Save These Instructions:

The information contained in this manual will help you install and operate your product. If these instructions are misplaced, Vaddio keeps copies of Specifications, Installation and User Guides and most pertinent product drawings for the Vaddio product line on the Vaddio website. These documents can be downloaded from [www.vaddio.com](http://www.vaddio.com) free of charge.

### UNPACKING:

Carefully remove the product and all of the included parts from the packaging. Identify the following parts for each camera:

#### ClearVIEW HD-20SE, HD PTZ Camera (North America):

Part Number: 999-6980-000

- One (1) ClearVIEW HD-20SE Camera (998-6980-000)
- One (1) Vaddio IR Remote Commander
- One (1) EZCamera™ Control Adapter (RJ-45 to DB-9)
- One (1) 12 VDC, 3.0 Amp Power Supply with Power Cord for North America
- Quick-Start Guide (1-pager)

*Note: Full Manuals are downloaded from [support.vaddio.com](http://support.vaddio.com)*

#### ClearVIEW HD-20SE, HD PTZ Camera (International):

Part Number: 999-6980-001

- One (1) ClearVIEW HD-20SE Camera (998-6980-000)
- One (1) Vaddio IR Remote Commander
- One (1) EZCamera™ Control Adapter (RJ-45 to DB-9)
- One (1) 12 VDC, 3.0 Amp Power Supply
- One (1) Euro Power Cable
- One (1) UK Power Cable
- Quick-Start Guide (1-pager)

*Note: Full Manuals are downloaded from [support.vaddio.com](http://support.vaddio.com)*



#### ClearVIEW HD-20SE, HD PTZ Camera (North America):

Part Number: 999-6980-000AW (Artic White Version)

- One (1) ClearVIEW HD-20SE Camera (998-6980-000AW)
- One (1) Vaddio IR Remote Commander
- One (1) EZCamera™ Control Adapter (RJ-45 to DB-9)
- One (1) 12 VDC, 3.0 Amp Power Supply with Power Cord for North America
- Quick-Start Guide (1-pager)

*Note: Full Manuals are downloaded from [support.vaddio.com](http://support.vaddio.com)*

#### ClearVIEW HD-20SE, HD PTZ Camera (International):

Part Number: 999-6980-001AW (Artic White Version)

- One (1) ClearVIEW HD-20SE Camera (998-6980-000AW)
- One (1) Vaddio IR Remote Commander
- One (1) EZCamera™ Control Adapter (RJ-45 to DB-9)
- One (1) 12 VDC, 3.0 Amp Power Supply
- One (1) Euro Power Cable
- One (1) UK Power Cable
- Quick-Start Guide (1-pager)

*Note: Full Manuals are downloaded from [support.vaddio.com](http://support.vaddio.com)*



### Front View with Feature Call-outs

Image: ClearVIEW HD-20SE HD PTZ Camera



#### 1) Camera and Zoom Lens:

The 20X optical zoom lens is built around a (1/2.8 Type) high-speed, low-noise Exmor CMOS image sensor with a total of 2.38 total megapixels for precise HD video image acquisition.

#### 2) Red Tally Light:

A red tally light is illuminated when the camera receives a command from an external control system.

#### 3) IR Sensors:

IR sensors are built into the front of the ClearVIEW HD-20SE to receive IR signals from the IR remote control supplied with the camera.

#### 4) Blue Power Light:

A Vaddio blue LED power light is illuminated when the camera is turned on. This LED will blink when IR signals are received.



## Rear Panel Connections with Feature Call-outs

Image: ClearVIEW HD-20SE HD PTZ Camera



### 5) RS-232 IN & IR Out:

The RS-232 accepts modified VISCA protocol for camera control, as well as transmits IR signaling received by the IR receivers, which can be transmitted to third party devices (color coded blue).

### 6) Dip Switch Settings:

Settings for IR remote, baud rate and image flip can be configured on these switches. See the Switch Settings page for additional information.

### 7) HD Video Select:

A rotary switch allows the user to choose the component HD output video resolution and format. See the Switch Settings page for additional information.

**HD Resolution Note:** When changing the resolution of the camera, the camera may have to be power-cycled after the change. The switcher typically will require a reboot or rescan.

### 8) 12 VDC Input:

Power input for the standard, ClearVIEW HD-20SE camera power supply.

### 9) HDMI Output:

The HDMI output feeds out HD digital video only (no copy protect or device communication is included). The HDMI output is optimized for HD video signals (seems logical).

### 10) YPbPr Output:

Component HD video (YPbPr) is output through the DE-15 connector. YPbPr and HDMI signals are simultaneous. Limited SD resolutions are supported.

### 11) EZ Power Video Port:

This RJ-45 connector is only used with the Quick-Connect SR Interface, Quick-Connect DVI-D/HDMI SR Interface and the Quick-Connect USB Interface to supply power and return HS-DS (differential) video from the camera (color coded orange)..

### 12) Slot for Optional Cards:

Optional slot cards can be plugged into the ClearVIEW HD-20SE camera (the HD-SDI and the EZIM CCU Slot Cards are available).

### FIRST TIME SET-UP WITH THE CLEARVIEW HD-20SE:

The ClearVIEW HD-20SE was designed to be a high quality camera that is very easy to use and operate. There is documentation at the back of this manual for pin-outs of the connectors on the ClearVIEW HD-20SE camera.

**Step 1:** Using the HD VIDEO SELECT rotary switch and CAMERA SETTINGS dip switches on the back of the camera, set up the camera's output resolution and functional preferences. There is a label on the bottom of the camera that identifies the choices.

**Important Dip Switch Note:** Setting all dip switches down and power cycling the camera will load the factory default camera settings. For the first time set-up, loading the defaults may be a good idea.

### Image: Rear Panel Connections

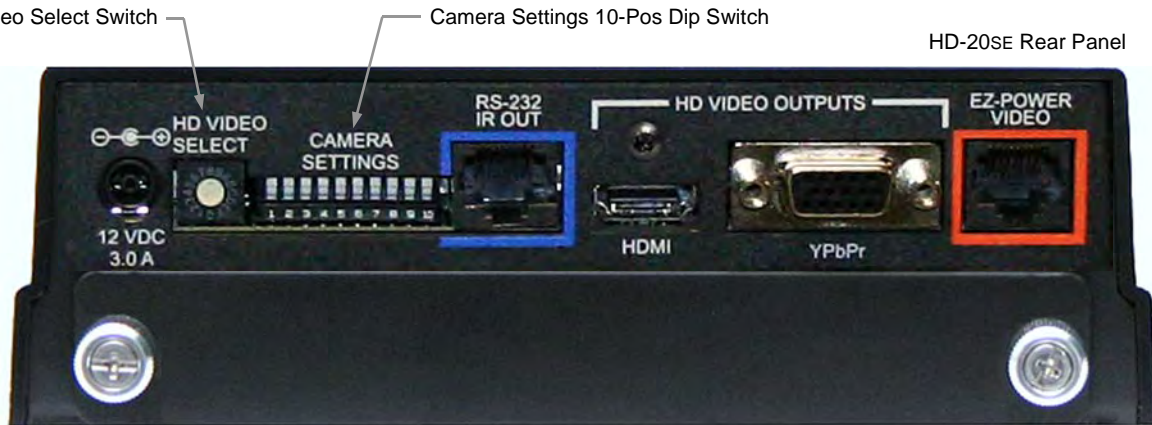

### Drawing: Dip Switch and Resolution Label on the Bottom of the ClearVIEW HD-20SE

DIP SWITCH SETTINGS										HD VIDEO SELECT			
IR 1 1 & 2 UP	IR OUT OFF	9600 bps	5 OFF	6 OFF	HDMI COLOR YCbCr	IMAGE FLIP OFF	9 OFF	10 OFF	0	720p/59.94	8	1080p/50	
<input checked="" type="checkbox"/>	<input checked="" type="checkbox"/>	<input checked="" type="checkbox"/>	<input checked="" type="checkbox"/>	<input checked="" type="checkbox"/>	<input checked="" type="checkbox"/>	<input checked="" type="checkbox"/>	<input checked="" type="checkbox"/>	<input checked="" type="checkbox"/>	1	1080i/59.94	9	---	
<input checked="" type="checkbox"/>	<input checked="" type="checkbox"/>	<input checked="" type="checkbox"/>	<input checked="" type="checkbox"/>	<input checked="" type="checkbox"/>	<input checked="" type="checkbox"/>	<input checked="" type="checkbox"/>	<input checked="" type="checkbox"/>	<input checked="" type="checkbox"/>	2	1080p/59.94	A	---	
<input checked="" type="checkbox"/>	<input checked="" type="checkbox"/>	<input checked="" type="checkbox"/>	<input checked="" type="checkbox"/>	<input checked="" type="checkbox"/>	<input checked="" type="checkbox"/>	<input checked="" type="checkbox"/>	<input checked="" type="checkbox"/>	<input checked="" type="checkbox"/>	3	720p/60	B	---	
<input checked="" type="checkbox"/>	<input checked="" type="checkbox"/>	<input checked="" type="checkbox"/>	<input checked="" type="checkbox"/>	<input checked="" type="checkbox"/>	<input checked="" type="checkbox"/>	<input checked="" type="checkbox"/>	<input checked="" type="checkbox"/>	<input checked="" type="checkbox"/>	4	1080i/60	C	---	
<input checked="" type="checkbox"/>	<input checked="" type="checkbox"/>	<input checked="" type="checkbox"/>	<input checked="" type="checkbox"/>	<input checked="" type="checkbox"/>	<input checked="" type="checkbox"/>	<input checked="" type="checkbox"/>	<input checked="" type="checkbox"/>	<input checked="" type="checkbox"/>	5	1080p/60	D	---	
IR 2 ON	IR 3 ON	ON	38400 bps	---	---	sRGB COLOR	ON	---	6	720p/50	E	1080p/30	
<input checked="" type="checkbox"/>	<input checked="" type="checkbox"/>	<input checked="" type="checkbox"/>	<input checked="" type="checkbox"/>	<input checked="" type="checkbox"/>	<input checked="" type="checkbox"/>	<input checked="" type="checkbox"/>	<input checked="" type="checkbox"/>	<input checked="" type="checkbox"/>	7	1080i/50	F	1080p/25	
1	2	3	4	5	6	7	8	9	10				

- Set the desired and available HD output resolution for the camera with the Rotary Switch.
- Set the IR frequency of the camera if it is to respond to the IR remote control.
- If using the IR forwarding feature, set the IR OUT switch to ON (SW3).
- Set the Baud Rate dip switch (SW4) to 9600bps for most applications. Default for Vaddio EZCamera Cabling Systems is 9600bps.
- To set the HDMI or DVI color space, use dip switch 7 (SW7).
- If inverting the camera, turn the IMAGE FLIP ON (SW8).

### Dip Switch Settings:

**IR 1 & 2:** The IR remote has the capability of operating up to three different PTZ cameras from one remote. Use the selector buttons at the top of the IR remote to select the frequency.

**IR Out 3:** The IR output is sent out on the RS-232 RJ-45 jack on the back of the camera. Turning on the IR output will allow IR signals to be transmitted over the Cat-5 cable to the head end. When using RS-232 control or Vaddio CCU controllers (also via RS-232), turn the IR OUT to OFF (up).

**Baud Rate 4:** The options for baud rate are either 9600 bps or 38,400 bps.

**HDMI Color or sRGB Color space 7:** Default is YCbCr. Use sRGB color space with older DVI-D 1.0 monitors only. The YCbCr color space is best for HDMI digital video.

**Image Flip 8:** To invert the HD-20, turn the IMAGE FLIP ON (switch down).

**Switches 5, 6, 9 and 10:** Leave up - or in the OFF position.

**Image: Basic Connectivity Example of the ClearVIEW HD-20SE**

Camera with local power connected to ProductionVIEW™ Precision Camera Controller

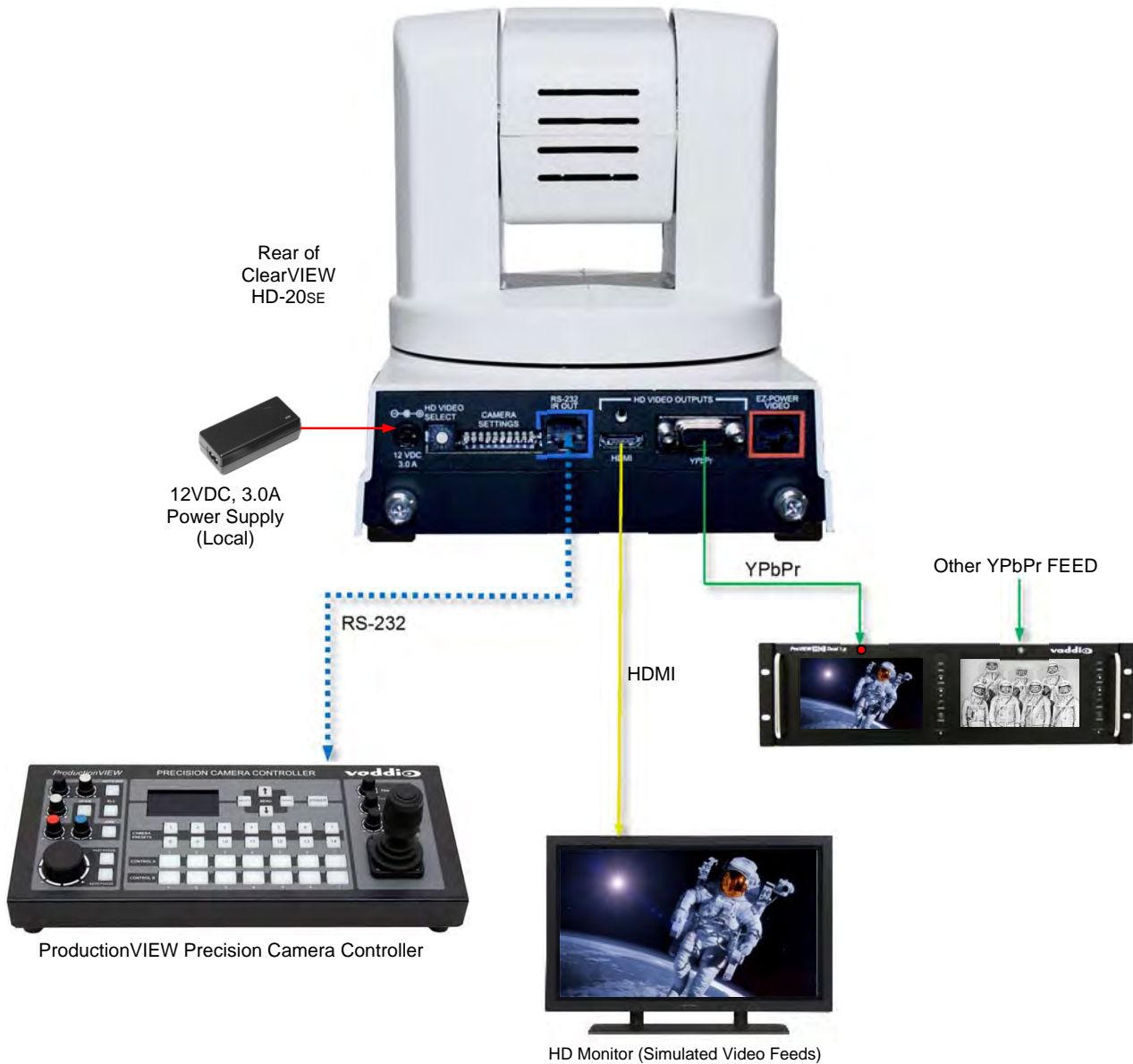

**Installation Basics:**

Locate the camera mounting location paying close attention to camera viewing angles, lighting conditions, possible line of site obstructions, and checking for in-wall obstructions where the camera is to be mounted. Pick a mounting location that will optimize the performance of the camera.

**RS-232 Cabling:**

For RS-232, use a standard Cat-5 cable (568B termination for RJ-45 connectors) from the RS-232 port on the back of a Vaddio ProductionVIEW camera controller or switcher. If the camera will be connected to a third-party control system (such as AMX or Crestron), a DE-9 to RJ-45 adapter is supplied with the camera for RS-232.



## COMPLIANCE AND CE DECLARATION OF CONFORMITY - CLEARVIEW HD-20SE

Compliance testing was performed to the following regulations:

- **FCC Part 15** (15.107, 15.109), **Subpart B**
- **ICES-003, Issue 4: 2004**
- **EN 55022 A: 2006 + A1: 2007**
- **KN24 2008 (CISPR 24: 1997 + A1: 2000 + A2: 2002)**
- **KN22 2008 (CISPR 22: 2006)**
- **EMC Directive 2004/108/EC**
- **EN 55024: A2: 2003**

Class A  
Class A  
Class A  
Class A  
Class A  
Class A  
Class A



### FCC Part 15 Compliance

This equipment has been tested and found to comply with the limits for a Class A digital device, pursuant to Part 15, Subpart B, of the FCC Rules. These limits are designed to provide reasonable protection against harmful interference when the equipment is operated in a commercial environment. This equipment generates, uses, and can radiate radio frequency energy and, if not installed and used in accordance with the instruction manual, may cause harmful interference to radio communications. Operation of this equipment in a residential area is likely to cause harmful interference in which case the user will be required to correct the interference at his/her own expense.

Operation is subject to the following two conditions: (1) This device may not cause interference, and (2) This device must accept any interference including interference that may cause undesired operation of the device.

Changes or modifications not expressly approved by Vaddio can affect emission compliance and could void the user's authority to operate this equipment.



### ICES-003 Compliance

This digital apparatus does not exceed the Class A limits for radio noise emissions from digital apparatus set out in the Radio Interference Regulations of the Canadian Department of Communications.

Le présent appareil numérique n'émet pas de bruits radioélectriques dépassant les limites applicables aux appareils numériques de la classe A prescrites dans le Règlement sur le brouillage radioélectrique édicté par le ministère des Communications du Canada.



### European Compliance

This product has been evaluated for Electromagnetic Compatibility under the EMC Directive for Emissions and Immunity and meets the requirements for a Class A digital device. In a domestic environment this product may cause radio interference in which case the user may be required to take adequate measures.

### Standard(s) To Which Conformity Is Declared:

#### EMC Directive 2004/108/EC

#### EN 55022 A: 2006 + A1: 2007(CISPR 22:2005/A1:2005)

#### EN 55024: 1998 + Amendments A1: 2001 + A2: 2003

- EN 61000-4-2: 1995 + Amendments A1: 1998 + A2: 2001
- EN 61000-4-3: 2006 + A1: 2008
- EN 61000-4-4: 2004 + Corrigendum 2006
- EN 61000-4-5: 2006
- EN 61000-4-6: 2009
- EN 61000-4-8: 2010
- EN 61000-4-11: 2004

#### KN24 2008 (CISPR 24: 1997 + A1: 2000 + A2: 2002)

- EN 61000-4-2
- EN 61000-4-3
- EN 61000-4-4
- EN 61000-4-5
- EN 61000-4-6
- EN 61000-4-8
- EN 61000-4-11

#### IEC 60950-1:2005 (2nd Edition); Am 1:2009

#### EN 60950-1:2006+A11:2009+A1:2010+A12:2011

Radiated and Conducted Emissions

Immunity

Electrostatic Discharge

Radiated Immunity

Electrical Fast Transients

Surge Immunity

Conducted Immunity

Power Frequency Magnetic Field

Voltage Dips, Interrupts and Fluctuations

IT Immunity Characteristics

Electrostatic Discharge

Radiated Immunity

Electrical Fast Transients

Surge Immunity

Conducted Immunity

Power Frequency Magnetic Field

Voltage Dips, Interrupts and Fluctuations

Safety

Safety

## WARRANTY INFORMATION

(See Vaddio Warranty, Service and Return Policies posted on vaddio.com for complete details):

**Hardware\* Warranty:** Two (2) year limited warranty on all parts and labor for Vaddio manufactured products. Vaddio warrants its manufactured products against defects in materials and workmanship for a period of two years from the day of purchase, to the original purchaser, if Vaddio receives notice of such defects during the warranty. Vaddio, at its option, will repair or replace products that prove to be defective. Vaddio manufactures its hardware products from parts and components that are new or equivalent to new in accordance with industry standard practices.

**Exclusions:** The above warranty shall not apply to defects resulting from improper or inadequate maintenance by the customer, customers applied software or interfacing, unauthorized modifications or misuse, mishandling, operation outside the normal environmental specifications for the product, use of the incorrect power supply, modified power supply or improper site operation and maintenance. OEM products and products manufactured by other companies are excluded and are covered by the manufacturer's warranty.

**Vaddio Customer Service:** Vaddio will test, repair, or replace the product or products without charge if the unit is under warranty. If the product is out of warranty, Vaddio will test then repair the product or products. The cost of parts and labor charge will be estimated by a technician and confirmed by the customer prior to repair. All components must be returned for testing as a complete unit. Vaddio will not accept responsibility for shipment after it has left the premises.

**Vaddio Technical Support:** Vaddio technicians will determine and discuss with the customer the criteria for repair costs and/or replacement. Vaddio Technical Support can be contacted through one of the following resources: e-mail support at [support@vaddio.com](mailto:support@vaddio.com) or online at vaddio.com.

**Return Material Authorization (RMA) Number:** Before returning a product for repair or replacement request an RMA from Vaddio's technical support. Provide the technician with a return phone number, e-mail address, shipping address, product serial numbers and original purchase order number. Describe the reason for repairs or returns as well as the date of purchase. See the General RMA Terms and Procedures section for more information. RMA's are valid for 30 days and will be issued to Vaddio dealers only. End users must return products through Vaddio dealers. Include the assigned RMA number in all correspondence with Vaddio. Write the assigned RMA number clearly on the shipping label of the box when returning the product. All products returned for credit are subject to a restocking charge without exception.

**Voided Warranty:** The warranty does not apply if the original serial number has been removed or if the product has been disassembled or damaged through misuse, accident, modifications, use of incorrect power supply, use of a modified power supply or unauthorized repair.

**Shipping and Handling:** Vaddio will not pay for inbound shipping transportation or insurance charges or accept any responsibility for laws and ordinances from inbound transit. Vaddio will pay for outbound shipping, transportation, and insurance charges for all items under warranty but will not assume responsibility for loss and/or damage by the outbound freight carrier. If the return shipment appears damaged, retain the original boxes and packing material for inspection by the carrier. *Contact your carrier immediately.*

**Products not under Warranty:** Payment arrangements are required before outbound shipment for all out of warranty products.

### Other General Information:

#### Care and Cleaning

Do not attempt to take this product apart at any time. There are no user-serviceable components inside.

- Do not spill liquids in the product
- Keep this device away from food and liquid
- For smears or smudges on the product, wipe with a clean, soft cloth
- Use a quality lens cleaner on the lens
- Do not use any abrasive chemicals.

#### Operating and Storage Conditions:

Do not store or operate the device under the following conditions:

- Temperatures above 40°C (104°F) or temperatures below 0°C (32°F)
- High humidity, condensing or wet environments
- In inclement weather
- In swimming pools or beaver dams
- Dry environments with an excess of static discharge
- In orbit (vacuum, temperature and re-entry problem)
- Under severe vibration



205 Westwood Ave, Long Branch, NJ 07740  
 Phone: 866-94 BOARDS (26273) / (732)-222-1511  
 Fax: (732)-222-7088 | E-mail: [sales@touchboards.com](mailto:sales@touchboards.com)

**GENERAL SPECIFICATIONS:**

ClearVIEW HD-20se, HD PTZ Camera	
Part Numbers	999-6980-000 (North America), 999-6980-001 (Int'l) - Black Camera Version 999-6980-000AW (North America), 999-6980-001AW (Int'l) - Artic White Camera Version
Image Sensor	1/2.8-Type Exmor, high-speed, low-noise CMOS Image Sensor 2.38 Megapixels (2.14M effective pixels).
Zoom	20X Optical Zoom with Multi-element Glass Lens
Field of View	Horizontal: 63° Wide End to 3.47° Tele End, (16:9 Aspect Ratio) Vertical: 36.8° Wide End to 1.85° Tele End
Lens Focal Length	f=4.44mm to 89mm / F1.6 - F3.4
Minimum Illumination	Color: 0.3 Lux (F1.6, 1/30 sec, 50 IRE), B/W: 0.03 Lux (F1.6, 1/30 sec, 50 IRE)
Video Resolutions	HD: 1080p/60/59.94/50./30/25, 1080i60/59.94/50 and 720p/60/59.94/50 HD Video Resolutions Only at 16:9
White Balance	Auto, Manual (Red and Blue Gain), OPWB, Indoor, Outdoor and Fluorescent
Video Output Formats	HDMI, Analog Component, HSDS (Differential Video, Power and Control for Quick-Connects)
Signal to Noise Ratio	Greater than 50 dB (AGC: Off)
Compatible Quick-Connects	Quick-Connect SR, Quick-Connect DVI/HDMI SR, Quick-Connect USB and Quick-Connect Universal CCU
Pan Range	Pan: +170 degrees to -170 degrees, Tilt: +90 degrees to -30 degrees
Preset Positions	16 (internal), 6 recalled via IR Remote
Control Methods	RS-232, IR Remote Commander and OSD (on screen display)
Tally Light	Available through RS-232 Control
HD Video Select	16-Position Rotary Switch: Used to set HD Video Resolution Output
Camera Settings	10-Position Dip Switch: Settings for IR Select, Baud Rate 9600, Image Flip and Color Space
Accessory Slot Cards	HD-SDI Slot Card, Part Number 998-6900-007 (3Gb/s Single Link) EZIM CCU Slot Card, Part Number 998-6900-006
Dimensions/Weight	7.81" (198.37mm) H x 6.67" (169.42mm) W x 7.057" (179.25. mm) D / 5.6 lbs. (2.630835643 kg.)

**APPENDIX 1: YPbPr VIDEO PIN-OUT FOR THE HD-20SE CAMERA**

Pin	YPbPr
1	Pr
2	Y
3	Pb
4	-
5	-
6	Pr GND
7	Y GND
8	Pb GND
9	-
10	GND
11	-
12	-
13	-
14	-
15	-

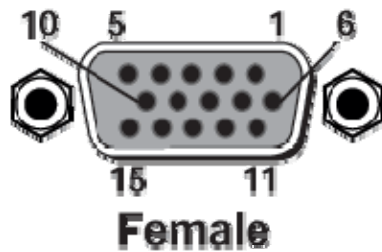

**EZ-Power Video RJ-45 Connector Pin-outs**



**Important Note:** The EZ-POWER VIDEO RJ-45 Connector is for use with the **Quick-Connect SR, Quick-Connect DVI/HDMI SR** and **Quick-Connect USB Interfaces ONLY** (568B Wiring Standard). The video signals are differential (HSDS) and can only be received by the interfaces above.

Pin	YPbPr
1	Power+
2	Power-
3	Y+
4	PB+
5	PB -
6	Y -
7	PR+
8	PR-

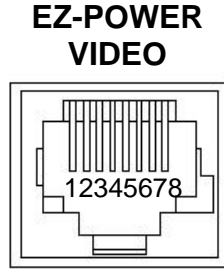

**Drawing: ClearVIEW HD-20SE Dimensions**

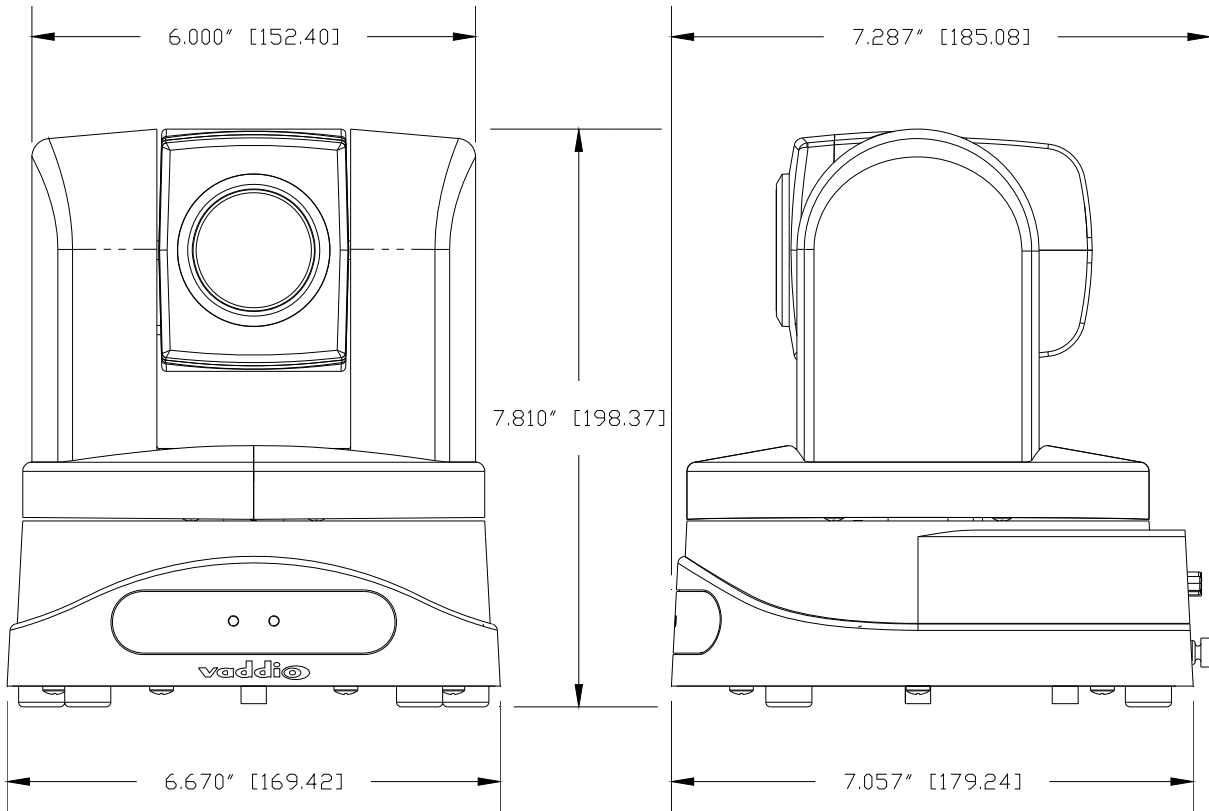

**Optional Accessories:**



**Thin Profile Wall Mount**  
Part Number: 535-2020-230



## COMMUNICATION SPECIFICATION

Communication Speed: 9600 bps (default)  
 Start bit: 1  
 Stop bit: 1  
 Data bits: 8  
 Parity: None  
 No Flow control

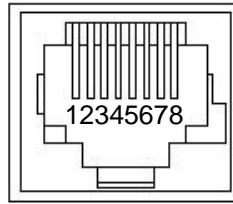

Pin #	RJ-45 RS-232 and IR Out Pins
1)	Unused
2)	Unused
3)	Unused
4)	IR Output (Diff Signal to Quick-Connect SR)
5)	IR Ground (Diff Signal to Quick-Connect SR)
6)	GND (GND of IR Short Range - Pin 3)
7)	RXD (from TXD of control source)
8)	TXD (to RXD of control source)

**NOTE:** The Vaddio ClearVIEW HD-20SE Control Protocol is similar, but not identical to, the Sony® VISCA™ command set in order to be compatible with several popular control devices. Not all VISCA commands are supported and there are many HD-Series specific commands in the following Command and Inquiry Lists.

### HD-20SE Command List (1/2)

Command Set	Command	Command Packet	Comments
Address Set	Broadcast	88 30 01 FF	Address Set (Daisy chain)
IF_Clear	Broadcast	88 01 00 01 FF	IF Clear
Command Cancel		8x 2p FF	p:socket number(1,2)
CAM_Power	On	8x 01 04 00 02 FF	Power On/Off
	Off(Standby)	8x 01 04 00 03 FF	
CAM_Zoom	Stop	8x 01 04 07 00 FF	pqrs: Zoom Position* v:(Speed) 0-7
	Tele(Standard)	8x 01 04 07 02 FF	
	Wide(Standard)	8x 01 04 07 03 FF	
	Tele(Variable)	8x 01 04 07 2p FF	
	Wide(Variable)	8x 01 04 07 3p FF	
	Direct	8x 01 04 47 0p 0q 0r 0s FF	
CAM_Focus	Direct(Variable)	8x 01 7E 01 4A 0v 0p 0q 0r 0s FF	pqrs: Focus position*
	Stop	8x 01 04 08 00 FF	
	Far(Standard)	8x 01 04 08 02 FF	
	Near(Standard)	8x 01 04 08 03 FF	
	Far(Variable)	8x 01 04 08 2p FF	
	Near(Variable)	8x 01 04 08 3p FF	
	AutoFocus	8x 01 04 38 02 FF	
	ManualFocus	8x 01 04 38 03 FF	
CAM_WB	Auto/Manual	8x 01 04 38 10 FF	pqrs: Focus position*
	Direct	8x 01 04 48 0p 0q 0r 0s FF	
	Auto	8x 01 04 35 00 FF	
	Manual	8x 01 04 35 05 FF	
	Indoor	8x 01 04 35 01 FF	
CAM_RGain	Outdoor	8x 01 04 35 02 FF	pqrs:00-0xffff
	One Push WB	8x 01 04 35 03 FF	
	Reset	8x 01 04 03 00 FF	
	Up	8x 01 04 03 02 FF	
CAM_BGain	Down	8x 01 04 03 03 FF	pqrs:00-0xffff
	Direct	8x 01 04 43 0p 0q 0r 0s FF	
	Reset	8x 01 04 04 00 FF	
	Up	8x 01 04 04 02 FF	
CAM_AE	Down	8x 01 04 04 03 FF	Auto Exposure Mode Manual Control Mode Shutter Priority Mode Exposure Priority Mode (default)
	Direct	8x 01 04 44 43 0p 0q 0r 0s FF	
	Full Auto	8x 01 04 39 00 FF	
	Manual	8x 01 04 39 03 FF	
CAM_Iris	Shutter Priority	8x 01 04 39 0A FF	pq(0x00-0x08)
	Iris Priority	8x 01 04 39 0B FF	
	Reset	8x 01 04 0B 00 FF	
	Up	8x 01 04 0B 02 FF	
CAM_Gain	Down	8x 01 04 0B 03 FF	pq(0x00-0x2A)
	Direct	8x 01 04 4B 00 00 0p 0q FF	
	Reset	8x 01 04 0C 00 FF	
	Up	8x 01 04 0C 02 FF	
CAM_Bright	Down	8x 01 04 0C 03 FF	pq(0x01-0x64)
	Direct	8x 01 04 4C 00 00 0p 0q FF	
	Reset	8x 01 04 0D 00 FF	
	Up	8x 01 04 0D 02 FF	
CAM_Bright	Down	8x 01 04 0D 03 FF	pq(0x01-0x64)
	Direct	8x 01 04 4D 00 00 0p 0q FF	
	Reset	8x 01 04 0D 00 FF	

**HD-20SE Command List (2/2)**

Command Set	Command	Command Packet	Comments
CAM_Backlight	On	8x 01 04 33 02 FF	
	Off	8x 01 04 33 03 FF	
CAM_Aperture	Reset	8x 01 04 02 00 FF	
	Up	8x 01 04 02 02 FF	
	Down	8x 01 04 02 03 FF	
	Direct	8x 01 04 42 00 00 0p 0q FF	pq(0x00-0x1F)
CAM_Memory	Reset	8x 01 04 3F 00 0p FF	
	Set	8x 01 04 3F 01 0p FF	
	Recall	8x01 04 3F 02 0p FF	p:Memory No(=0-0xF)
CAM_IDWrite		8x 01 04 22 0p 0q 0r 0s FF	pqrs:0x0000 – 0xFFFF
CAM_LR_Reverse On	On	8x 01 04 61 02 FF	Mirror (Horizontal) on
	Off	8x 01 04 61 03 FF	Mirror (Horizontal) off
IR_Receive##	On	8x 01 06 08 02 FF	
	Off	8x 01 06 08 03 FF	
	On/Off	8x 01 06 08 10 FF	IR forwarding/Local IR
Pan-tiltDrive	Up	8x 01 06 01 VV WW 03 01 FF	VV: Pan Speed (0x01-0x18)
	Down	8x 01 06 01 VV WW 03 02 FF	WW: Tilt Speed(0x01-0x14)
	Left	8x 01 06 01 VV WW 01 03 FF	
	Right	8x 01 06 01 VV WW 02 03 FF	
	UpLeft	8x 01 06 01 VV WW 01 01 FF	
	UpRight	8x 01 06 01 VV WW 02 01 FF	
	DownLeft	8x 01 06 01 VV WW 01 02 FF	
	DownRight	8x 01 06 01 VV WW 02 02 FF	
	Stop	8x 01 06 01 VV WW 03 03 FF	
	Absolute Position	8x 01 06 02 VV WW 0Y 0Y 0Y 0Y 0Z 0Z 0Z 0Z FF	YYYY: Pan Position** ZZZZ: Tilt Position**
	Home	8x 01 06 04 FF	
Reset	8x 01 06 05 FF		
Pan-tilt-zoom Drive	Up	8x 01 06 0A VV WW XX 03 01 03 FF	VV: Pan Speed (0x01-0x18)
	Down	8x 01 06 0A VV WW XX 03 02 03 FF	WW: Tilt Speed(0x01-0x14)
	Left	8x 01 06 0A VV WW XX 01 03 03 FF	XX: ZoomSpeed(0x00-0x07)
	Right	8x 01 06 0A VV WW XX 02 03 03 FF	
	Tele	8x 01 06 0A VV WW XX 03 03 01 FF	
	Wide	8x 01 06 0A VV WW XX 03 03 02 FF	
	UpLeft	8x 01 06 0A VV WW XX 01 01 03 FF	
	UpRight	8x 01 06 0A VV WW XX 02 01 03 FF	
	DownLeft	8x 01 06 0A VV WW XX 01 02 03 FF	
	DownRight	8x 01 06 0A VV WW XX 02 02 03 FF	
	Stop	8x 01 06 0A VV WW XX 03 03 03 FF	YYYY: Pan Position** ZZZZ: Tilt Position** RRRR: ZoomPosition**
	Absolute Position	8x 01 06 0B VV WW XX 0Y 0Y 0Y 0Y 0Z 0Z 0Z 0Z 0R 0R 0R 0R FF	
	Tally	On	8x 01 7E 01 0A 00 02 FF
Off		8x 01 7E 01 0A 00 03 FF	
Preset Pan Speed	Pan/Tilt/Zoom Speed	8x 01 7E 01 0B WW SS ZZ FF	WW: Pan Speed (0x01-0x18) SS:Tilt Speed(0x01-0x14) ZZ:Zoom Speed(0-7);
Motor Config	Hard Motor Stops	8x 01 7E 01 70 00 00 FF	
	Soft Motor Stops	8x 01 7E 01 70 00 01 FF	
BLK.Enhance	Pedestal	No Support	No Support
GMA.Enhance	Gamma	8x 01 7E 54 00 00 0p 0q FF	pq: Gamma (0x00-0x10)
CRM.Enhance	Chroma	8x 01 7E 55 00 00 0p 0q FF	pq: Chroma (0x00-0x64)
KNE.Enhance	Knee	No Support	No Support
DIS.Enhance	Digital Image	8x 01 7E 57 02 FF	On
	Stabilizer	8x 01 7E 57 03 FF	Off
SNR.Enhance	Super Noise	8x 01 7E 58 02 FF	On
	Reduction	8x 01 7E 58 03 FF	Off
AGC.Enhance	AGC Mode	8x 01 7E 59 00 FF	Off
		8x 01 7E 59 01 FF	Low
		8x 01 7E 59 02 FF	Medium
		8x 01 7E 59 03 FF	High
CAM_Shutter	Reset	8x 01 04 0A 00 FF	
	Up	8x 01 04 0A 02 FF	
	Down	8x 01 04 0A 03 FF	
	Direct	8x 01 04 4A 00 00 0p 0q FF	pq(0x00-0x1C)
CAM_ExpComp	On	8x 01 04 3E 02 FF	AutoExposure Off
	Off	8x 01 04 3E 03 FF	AutoExposure On
	Reset	8x 01 04 0E 00 FF	
	Up	8x 01 04 0E 02 FF	
	Down	8x 01 04 0E 03 FF	
CAM_ICR	ICR On	8x 01 04 01 02 FF	ICR On - Cut Filter Out
	ICR Off	8x 01 04 01 03 FF	ICR Off - Cut Filter In

## HD-20SE Command List (2/2) Notes

### \*Zoom and Focus Data:

CAM\_Zoom: Range(0x000-0x071A)

CAM\_Focus: Range (0x0ed-0x0944) dependent on Zoom Position

### \*\*Additional Information:

Pan Range: 8044 – 7FBC (-32,700 to +32,700)

Tilt Range: E891 – 4C2B (-5,999 to +19,499)

Actual Pan/Tilt ranges defined in Inquiry list

## HD-20SE Inquiry List (1/1)

Inquiry Command	Command	Response Packet	Comments
CAM_PowerInq	8x 09 04 00 FF	y0 50 02 FF y0 50 03 FF	On Off(Standby)
CAM_ZoomPosInq	8x 09 04 47 FF	y0 50 0p 0q 0r 0s FF	pqr: 0-0x071A
CAM_FocusPosInq	8x 09 04 48 FF	y0 50 0p 0q 0r 0s FF	pqrs: Focus Position
CAM_WBModelInq	8x 09 04 35 FF	y0 50 00 FF y0 50 05 FF y0 50 01 FF y0 50 02 FF y0 50 03 FF	Auto Manual Indoor Outdoor One Push WB
CAM_RGain	8x 09 04 43 FF	y0 50 0p 0q 0r 0s FF	pqrs: 000-0xffff
CAM_BGain	8x 09 04 44 FF	y0 50 0p 0q 0r 0s FF	pqrs: 000-0xffff
CAM_Iris	8x 09 04 4B FF	y0 50 00 00 0p 0q FF	pq(0x00-0x08)
CAM_Gain	8x 09 04 4C FF	y0 50 00 00 0p 0q FF	pq(0x00-0x2A)
CAM_Bright	8x 01 04 4D FF	y0 50 00 00 0p 0q FF	pq(0x01-0x64)
CAM_BacklightModelInq	8x 09 04 33 FF	y0 50 02 FF y0 50 03 FF	On Off
CAM_ApertureInq	8x 09 04 42 FF	y0 50 00 00 0p 0q FF	Pq:x00-0x1F
CAM_MemoryInq	8x 09 04 3F FF	y0 50 0p FF	p:Preset 0-0xf
CAM_IDInq	8x 09 04 3F FF	y0 50 0p 0q 0r 0s FF	pqrs:0x0000 – 0xFFFF
CAM_ReceiveInq	8x 09 06 08 FF	y0 50 02 FF y0 50 03 FF	On Off
CAM_LR_Reverse	8x 09 04 61 FF	y0 50 02 FF y0 50 03 FF	On Off
Pan-TiltMaxSpeedInq	8x 09 06 11 FF	y0 50 pp qq FF	pp:Pan 0x01-0x18 qq:Tilt 0x01-0x14
Pan-tiltPositionInq	8x 09 06 12 FF	FF y0 50 0p 0p 0p 0p 0q 0q 0q 0q FF	pppp: Pan 0x8044-0x7FB2 qqqq: Tilt 0xE890-0x4C2C
TallyInq	8x 09 7E 01 0A FF	y0 50 02 FF y0 50 03 FF	On Off
PresetSpeedInq	8x 09 7E 01 0B FF	y0 50 pp qq rr FF	pp:Pan 0x01-0x18 qq:Tilt 0x01-0x14 rr:Zoom 0x00-0x07
Motor Config	8x 09 7E 01 70 FF	y0 50 00 FF y0 50 01 FF	Hard Motor Stops Soft Motor Stops
BLK.Enhance	No support	No Support	Pedestal
GMA.Enhance	8x 09 7E 54 FF	y0 50 00 00 0p 0q FF	pq: Gamma (0x00-0x10)
CRM.Enhance	8x 09 7E 55 FF	y0 50 00 00 0p 0q FF	pq: Chroma (0x00-0x64)
KNE.Enhance	No support	No Support	Knee
DIS.Enhance	8x 09 7E 57 FF	y0 50 02 FF y0 50 03 FF	On Off
SNR.Enhance	8x 09 7E 58 FF	y0 50 02 FF y0 50 03 FF	On Off
AGC.Enhance	8x 09 7e 59 FF	y0 50 00 FF y0 50 01 FF y0 50 02 FF y0 50 03 FF y0 50 04 FF	Off Low Medium High Manual AGC
CAM_AEModeInq	8x 09 04 39 FF	y0 50 00 FF y0 50 03 FF y0 50 0A FF y0 50 0B FF	Auto Exposure Mode Manual Control Mode Shutter Priority Mode Exposure Priority Mode
CAM_ShutterPosInq	8x 09 04 4A FF	y0 50 00 00 0p 0q FF	pq: 0x0-0x1C
CAM_ExpCompModelInq	8x 09 04 3E FF	y0 50 02 FF y0 50 03 FF	On - AE Mode Off Off - AE Mode On
CAM_ExpCompPosInq	8x 09 04 4E FF	y0 50 00 00 0p 0q FF	pq: ExpComp Pos
CAM_ICRModelInq	8x 09 04 01 FF	y0 50 02 FF y0 50 03 FF	On - ICR filter Out Off - ICR filter In



**TABLE: HD-20SE OSD MENU STRUCTURE**

Use this OSD menu with the IR Commander to make video adjustments (AWB, COLOR, EXP, etc...) on the HD-20SE Camera.

Menu	Controls	Modes/Range	Default	Notes
<b>SSDR</b>	OFF		OFF	Dynamic Range Adjustment
	ON	SSDR 0-15	8*	*When Dynamic Range is ON
	Return			Return to Main Menu
<b>WHITE BAL</b>	ATW		ON	Auto White Balance - ON
	MANUAL>	RED 0 - 1000	560	Adjust Red Level
		BLUE 0 - 1000	480	Adjust Blue Level
		RETURN<		Return to WHITE BAL Menu
	AWC-SET			
	OUTDOOR			
	INDOOR			
	MERCURY			
	SODIUM			
	RETURN<			Return to Main Menu
<b>BACKLIGHT</b>	OFF		OFF	Default BLC is off
	WDR>	LEVEL (LOW / MED / HIGH)	OFF	Wide Dynamic Range
		RETURN<		
	BLC>	LEVEL (LOW / MED / HIGH)	OFF	
		BOTTOM 1-100		
		LEFT 1-100		
		RIGHT 1-100		
		RETURN<		Return to BACKLIGHT Menu
	HLC>	LEVEL (LOW / MED / HIGH)	OFF	
		MASK TONE 1-15		
		RETURN<		Return to BACKLIGHT Menu
	RETURN<			Return to Main Menu
<b>INTELLIGENCE</b>	OFF	<b>Intelligence, motion detection analytics and masking are not processed or used by the HD-20SE camera, however the OSD menu still works.</b>		
<b>FOCUS</b>	MODE	AUTO / MANUAL / ONE PUSH	AUTO	
	ZOOM TRACK>	OFF / TRACK / AUTO TRACK	AUTOTRACK	
	ZOOM SPEED>	SLOW / MEDIUM / FAST		
	DIGITAL ZOOM>	OFF/ON	OFF	Default is OFF
		ON>LIMIT X2 - X16		Avoid Digital Zoom if possible
		RETURN<		Return to FOCUS Menu
	Zoom POS INIT>	OFF/AUTO		Zoom position initialization
		MANUAL>		
		POS INIT 1X - 20X	1X	Sets INIT Zoom Position
		RETURN<		Return to FOCUS Menu
	USER PRESET>	OFF/ON	OFF	
		ON > PRESET NO 1-128	1	Zoom Presets
	PRESET SAVE			
	PRESET CLEAR			
	RETURN<		Return to FOCUS Menu	
LENS INIT	MANUAL / AUTO			
RETURN<			Return to Main Menu	
<b>EXPOSURE</b>	BRIGHTNESS	0-100	50	Brightness Sets Luminance Target
	IRIS>	AUTO	AUTO	Automatic Gain Control
		MANUAL>	Closed to F28	Manual Iris
		RETURN<		Return to EXPOSURE Menu
	SHUTTER	A FLK		Anti-Flicker
		ESC		
		MANUAL> 1/30 - 1/30,000 sec.		Shutter Speed
		RETURN<		Return to EXPOSURE Menu
	AGC	OFF / LOW / MED / HIGH	LOW	
		MANUAL (OFF)>		
	AGC VALUE 0 - 36dB	0 dB	Automatic Gain Control	
	RETURN<			
SSNR	OFF / LOW / MED / HIGH	LOW	Noise Reduction - Don't use above Low	
SENS-UP	OFF	OFF	<b>OFF - Do not Use</b>	
RETURN<			Return to Main Menu	



**HD-20se OSD Menu Structure (continued)**

Menu	Controls	Range/Modes	Default	Notes
SPECIAL	DAY/NIGHT>	COLOR / B/W / AUTO	COLOR	<b>Do not use</b>
	DIS>	OFF / ON	OFF	Digital Image Stabilization - leave off
	DEFOG	OFF / ON / MANUAL/AUTO	OFF	<b>Do not use</b>
	COMM ADJUST>	<b>BAUD RATE</b>	<b>NEVER CHANGE THE BAUD RATE OR THE UART SETTINGS - Control is lost if these are changed. Factory default reboot will be required.</b> 	
		<b>UART</b>		
		RETURN<		Return to SPECIAL Menu
	IMAGE ADJUST>	H-REV ON / OFF	OFF	Use Dip Switch on Camera to Flip Image
		V-REV ON / OFF	OFF	Use Dip Switch on Camera to Flip Image
		SHARPNESS ON/OFF	ON	Picture Detail
		ON> 0-30	15	
		RETURN<		Return to IMAGE ADJUST Menu
		MONITOR LCD>		
		GAMMA .0 -1.0	0.50	
		COLOR LEVEL 0-100	50	
		RETURN<		Return to IMAGE ADJUST Menu
		USER>		
		GAMMA .0 - 1.0	0.50	
		COLOR LEVEL 0-100	50	
		RETURN<		Return to IMAGE ADJUST Menu
		RETURN<		Return to Main Menu
	DISPLAY	CAM TITLE ON / OFF	OFF	
		ON> A-Z, 1-9		
		RETURN<		Return to DISPLAY Menu
		CAM ID ON / OFF	OFF	
		CAM INFO ON / OFF	OFF	
		ZOOM MAG ON/OFF	OFF	
		OSD COLOR	WHITE	WHITE/YELLOW/GREEN/RED/BLUE
		LANGUAGE	ENGLISH	(ENG, FR, KOR, SP, CHIN, JAP, PORT, RUS, DUT, ITAL)
		SET LANGUAGE		
		RETURN<		Return to Main Menu
	VIDEO OUT FORM	COMPONENT ON / OFF	ON	<b>Do not change this parameter</b>
		RETURN<		Do not change resolutions here - Use the Rotary Switch on the back of the camera
RESET				
EXIT				



**205 Westwood Ave, Long Branch, NJ 07740**  
**Phone: 866-94 BOARDS (26273) / (732)-222-1511**  
**Fax: (732)-222-7088 | E-mail: sales@touchboards.com**



Toll Free: 800-572-2011 ▪ Phone: 763-971-4400 ▪ FAX: 763-971-4464

[www.vaddio.com](http://www.vaddio.com)

©2015 Vaddio - All Rights Reserved. Reproduction in whole or in part without written permission is prohibited. Specifications and pricing are subject to change without notice or obligation. Vaddio, ClearVIEW, ProductionVIEW, EZCamera, Quick-Connect and HSDS are trademarks of Vaddio. All other trademarks are property of their respective owners. Document Number 342-0933 Rev A, SD: 68503.2