



Complete Manual for the

OneLINK Bridge Express

AV Interface

Document 411-0062-30 Rev A
March 2022

Contents

Overview	1
What's in this Guide	1
Features	1
A Quick Look at the OneLINK Device	2
Front Panel of the Receiver	2
Connector Panel of the Receiver	2
Installing the OneLINK Device	3
Don't Void Your Warranty!	3
Cabling Notes	3
RS-232 Connector Pin-Out	4
Mounting the OneLINK Device	4
About Installations Using Half-Recessed Ceiling Mounts	4
Connections for HDBaseT Cameras	5
Connections for HDBaseT Cameras Used with Codecs	6
Connecting a Vaddio HDBaseT Camera and Polycom Codec	6
Connecting a Vaddio HDBaseT Camera and Cisco Codec	7
Hardware Note: Connections and Configuration Changes	10
OneLINK Device Configuration for Audio Using a Codec	10
Powering Up the Equipment	10
Web Interface	11
Working with the Connected Camera	11
Compatible Web Browsers	11
Initial Device Set-Up and System Administration Tasks	12
Initial Device Set-Up Using the Vaddio Device Controller	12
Initial Device Set-Up Using the Vaddio Deployment Tool	12
Accessing the Web Interface Manually	13
If the Device Is At 169.254.10.1	13
Completing the Initial Device Set-up	14
System Administration	15
Configuring Access and Other Security Settings	15
Configuring a Static IP Address for a Device Currently at 169.254.10.1	16
Changing from an Automatically Assigned Address to a Static IP Address	17
Changing the Device's Hostname	17
Specifying Time Zone and NTP Server	18
Adding Room Information to the Web Interface	18
Serial Control Settings	19
Accessing the Connected Camera's Web Interface	19
Performance and Behavior Settings	20
Configuring USB Streaming Settings	20
Configuring Audio Settings	21

Quick Adjustments – Muting and Volume	21
Enabling Phantom Power to Microphones	22
Reading the Audio Matrix	23
Routing Audio	23
Default Microphone Settings	24
Microphone Settings for Environments with Audiences	24
Microphone Adjustments	25
Speaker Adjustments	26
About Echo Cancellation	27
Preventing Audio Feedback	27
System Maintenance	28
Exporting and Importing Configuration Data	28
Starting a Firmware Update	29
Rebooting the OneLINK Device	29
Contacting Vaddio Technical Support and Viewing Diagnostics	30
Serial Command API	31
Audio Management Commands	32
Channels Available for Audio Commands	32
audio volume	33
audio mute	33
audio route	34
audio crosspoint-gain	34
Communication and Power Commands	35
network settings get	35
link power	35
Maintenance and Troubleshooting Commands	36
version	36
network ping	36
system reboot	37
system factory-reset	37
Telnet Information and Session Management Commands	38
history	38
help	38
exit	38
Troubleshooting	39
Power Issues	39
Communication Issues	40
Video and Audio Issues	40
Restoring Factory Defaults	41
Operation, Storage, and Care	41
Index	42

Overview

This guide covers the OneLINK™ Bridge Express AV Interface:

- 999-9595-070 – OneLINK Bridge Express, North America
- 999-9595-071 – OneLINK Bridge Express, Europe and UK
- 999-9595-079 – OneLINK Bridge Express, Australia and New Zealand

The OneLINK Bridge Express AV interface is also available as a component of several kits and camera systems.



What's in this Guide

This guide provides information about:

- Physical features
- Installation
- System administration and configuration
- Serial API for third-party control
- Troubleshooting and maintenance

For your convenience, the information you need to install this product is also available in the smaller, stand-alone **Installation Guide for the OneLINK Bridge Express AV Interface**, which covers physical features, installation, and initial power-on.

Features

- Compatible with Vaddio HDBaseT™ cameras and other compliant HDBaseT sources
- Simple, clutter-free camera installation – power, control, video, and streaming over one cable
- Extends camera installation distance up to 100 m (328 ft.) using Cat-6 cable
- Administrative control via web interface
- Passes web, Telnet, and RS-232 serial control to connected devices
- Converts any conference room to a BYOD environment, connecting professional AV equipment and delivering a USB 3.0 stream for soft-conferencing clients
- Simultaneous uncompressed USB 3.0 and HDMI 1.4b; passes IP stream if available from source
- Two balanced audio inputs, line level or mic level; two balanced audio outputs, line level
- Kits available for use with Polycom and Cisco codecs

A Quick Look at the OneLINK Device

This section covers the physical features of the OneLINK Bridge Express AV interface.

Front Panel of the Receiver



- **USB light** – On when a USB stream is active.
- **Network light** – On when connected to the IP network.
- **Source light** – On when a video input is detected.
- **Display IP and MAC Address button** (illuminated blue) – Displays the OneLINK Bridge IP and MAC addresses as an overlay on all video outputs.
- **Power System Reset button** (illuminated red) – reboots the device. This does not affect the connected camera.

Connector Panel of the Receiver

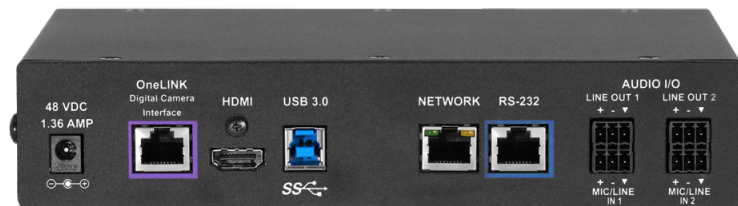

From the left:

- **Power input jack** – Connect the supplied 48 VDC, 1.36 A power supply.
- **OneLINK interface port** – Connection to the HDBaseT camera: video, audio (if available), network connectivity including H.264 IP streaming from the camera (if available), RS-232 control, and 12 VDC camera power.
- **HDMI output** – Connection for a display.
- **USB 3.0** – Connect to a computer for uncompressed video output with PCM audio for conferencing applications.
- **Network port** – Web interface access, H.264 IP streaming (if available from the camera), and third-party IP control via Telnet API.
- **RS-232 port** – Connection for a camera controller or third-party control system.
- **Audio I/O Line Out 1 and Line Out 2** – Far-end audio from conferencing application or as configured in the audio matrix.
- **Audio I/O Mic/Line In 1 and Mic/Line In 2** – Connections for microphones or other audio inputs.

Installing the OneLINK Device

This section covers:

- Things to know before you start the installation
- Basic connection examples

Don't Void Your Warranty!

Caution

Use only the power supply included with this product. Using a different one will void the warranty, and could create unsafe operating conditions or damage the product.

Do not connect the OneLINK power supply to a Vaddio camera. It does not provide the correct voltage for Vaddio cameras, and will damage the camera and void the camera's warranty.

This product is for indoor use only. Do not install it outdoors or in a humid environment. Do not allow it to come into contact with any liquid. Do not install or operate this product if it has been dropped, damaged, or exposed to liquids. If any of these things happen, return it to Vaddio for safety and functional testing.

Note

Disassembling this product will void the warranty.

Cabling Notes

- Maximum cable distance between the OneLINK device and the camera is 328 ft (100 m) using Cat-6 or Cat-7 cable, or 230 ft (70 m) using Cat-5e cable.
- Cat-6 or Cat-7 cabling allows longer maximum cabling distance, and may provide better performance in noisier RF or EMF environments.
- We recommend shielded cabling if the cables will be coiled, run tightly with other cables, or routed near sources of electromagnetic interference such as power lines or fluorescent light fixtures. When in doubt, use shielded Cat-6 cable.

Caution

When making cables for Vaddio products, do not use pass-through RJ-45 connectors. If they are crimped incorrectly, they can damage the connectors on the product, cause intermittent connections, and degrade signal quality. Physical damage to the connectors will void your warranty.

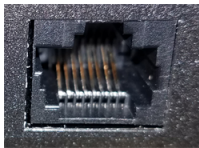

Intact

Contact fingers will make reliable contact with the cable connector

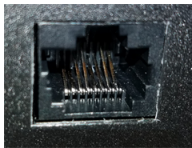

Damaged

Some contact fingers are bent and will NOT make reliable contact with the cable connector

We recommend using high-quality connectors and a high-quality crimping tool.



Pro Tip

To prevent tragic mishaps, label both ends of every cable.

RS-232 Connector Pin-Out

The OneLINK device passes signals from a third-party device to the connected camera.

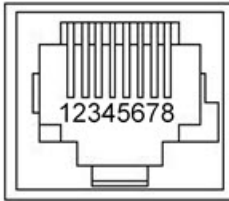

OneLINK Receiver - RS-232 Control Port

Pin	Signal
1	(not used)
2	(not used)
3	(not used)
4	(not used)
5	(not used)
6	GND
7	RX (from TX of controller)
8	TX (to RX of controller)

Mounting the OneLINK Device

Rack and under-table mounting kits are available for the receiver. Follow the mounting instructions supplied with the kit.

About Installations Using Half-Recessed Ceiling Mounts

If the connected camera is mounted in an In-CEILING Half-Recessed Ceiling Mount for RoboSHOT[®] series cameras, and the mount's IR receiver will be used to forward commands to the camera, this must be powered separately using Power Extension Module 998-2225-051. Cameras powered by OneLINK devices cannot supply power to the mount's IR receiver.

Connections for HDBaseT Cameras

The OneLINK Bridge Express extends network connectivity, power, and control to an HDBaseT camera, and sends HDMI video from the camera to a display. In addition, the device provides audio connections and originates a USB stream to bridge the equipment into a USB-based conferencing application.

The camera can optionally be controlled by a camera controller via the OneLINK connection. Depending on the equipment, the camera controller may connect directly to the OneLINK device's RS-232 port, or it may control the camera over the network. In either case the OneLINK device passes communication between the controller and the camera.

If an IP stream is available from the camera, the OneLINK device passes it to the network. Ethernet pass-through is limited to 100 Mb/s. HDMI output resolution and streaming parameters (including resolution) are configured on the camera, not the OneLINK device.

The RoboSHOT HDBT, RoboSHOT UHD, RoboFLIP®, and RoboSHOT In-Wall models are HDBaseT cameras.

This diagram shows a RoboFLIP 30 HDBT camera. Other Vaddio HDBaseT cameras connect in the same way.

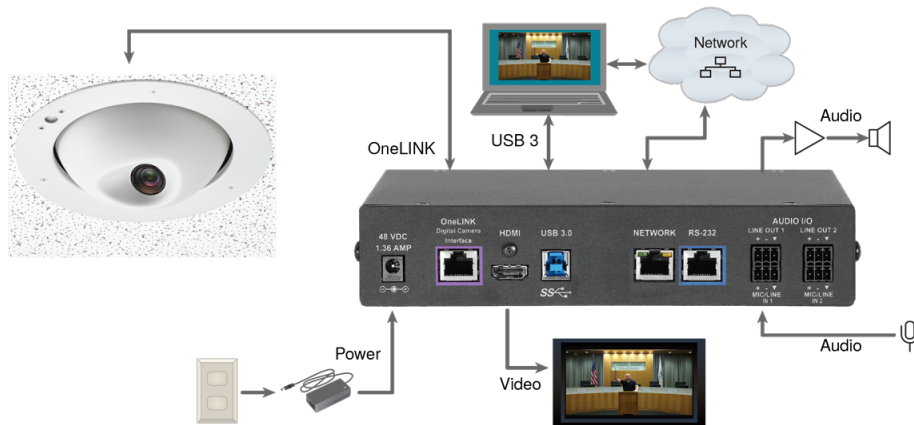

Connections for HDBaseT Cameras Used with Codecs

A codec may be connected to the OneLINK device via RS-232 or over the IP network, depending on the codec.

If an IP stream is available from the camera, the OneLINK device passes it to the network. Ethernet pass-through is limited to 100 Mb/s. HDMI output resolution and streaming parameters (including resolution) are configured on the camera, not the OneLINK device.

Connecting a Vaddio HDBaseT Camera and Polycom Codec

These diagrams show a OneLINK Bridge AV interface with a RoboSHOT HDBT camera. The OneLINK Bridge Express connects in the same way. Other Vaddio HDBaseT cameras connect in the same way.

The Polycom RealPresence Group 500 codec is similar to the RealPresence Group 310 codec, and connects to the OneLINK device in the same way.

RoboSHOT HDBT Camera and Polycom RealPresence Group 310 Codec

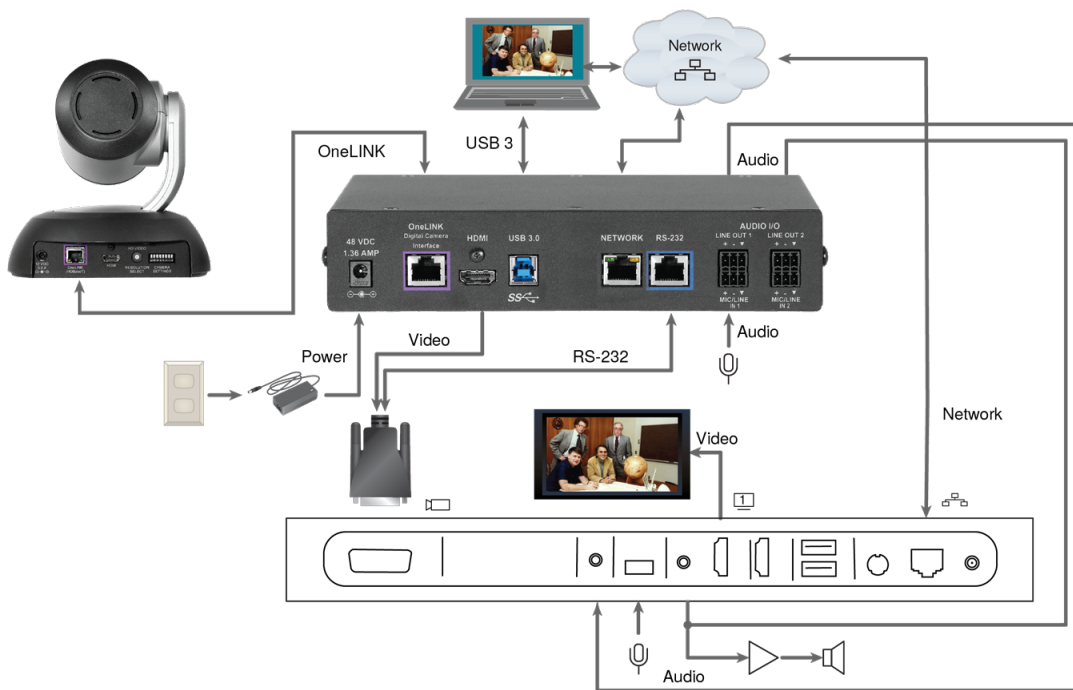

RoboSHOT HDBT Camera and Polycom RealPresence Group 700 Codec

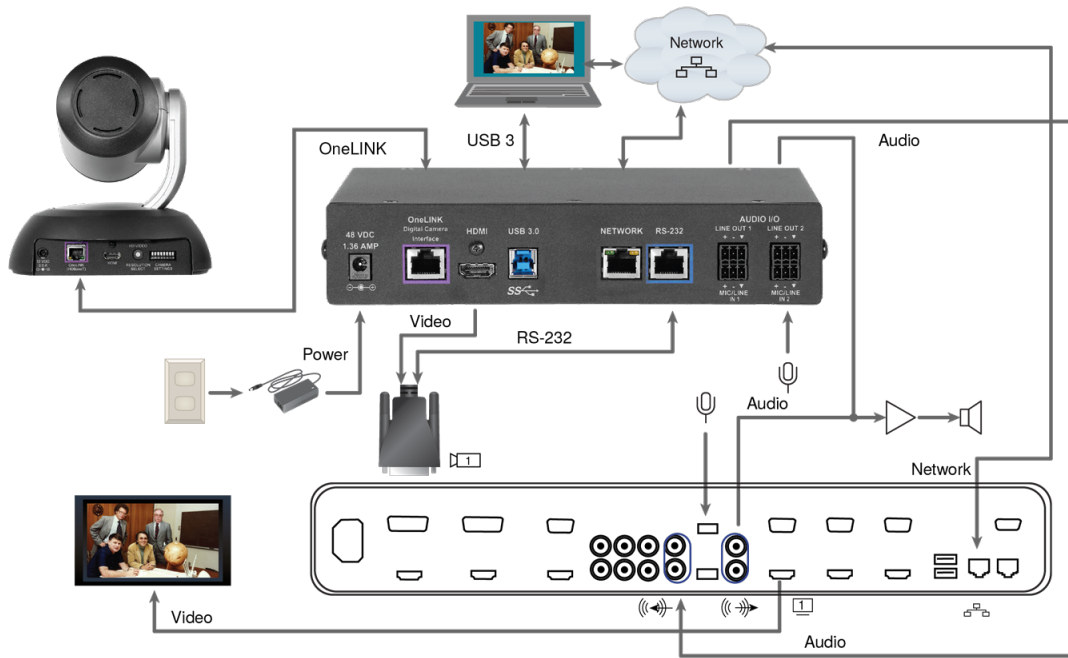

Connecting a Vaddio HDBaseT Camera and Cisco Codec

RoboSHOT HDBT Camera and Cisco C20 Codec

This diagram shows a OneLINK Bridge AV interface with a RoboSHOT HDBT camera. The OneLINK Bridge Express connects in the same way. Other Vaddio HDBaseT cameras connect in the same way.

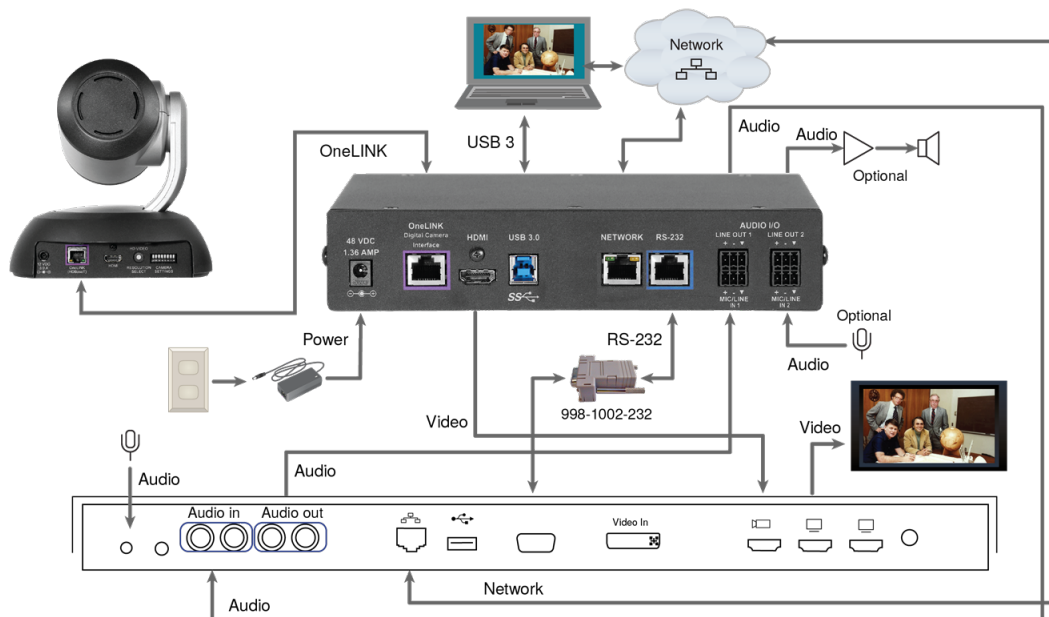

RoboSHOT HDBT Camera and Cisco C60 Codec

This diagram shows a OneLINK Bridge AV interface with a RoboSHOT HDBT camera. The OneLINK Bridge Express connects in the same way. Other Vaddio HDBaseT cameras connect in the same way. The Cisco C40 codec looks similar and connects in the same way.

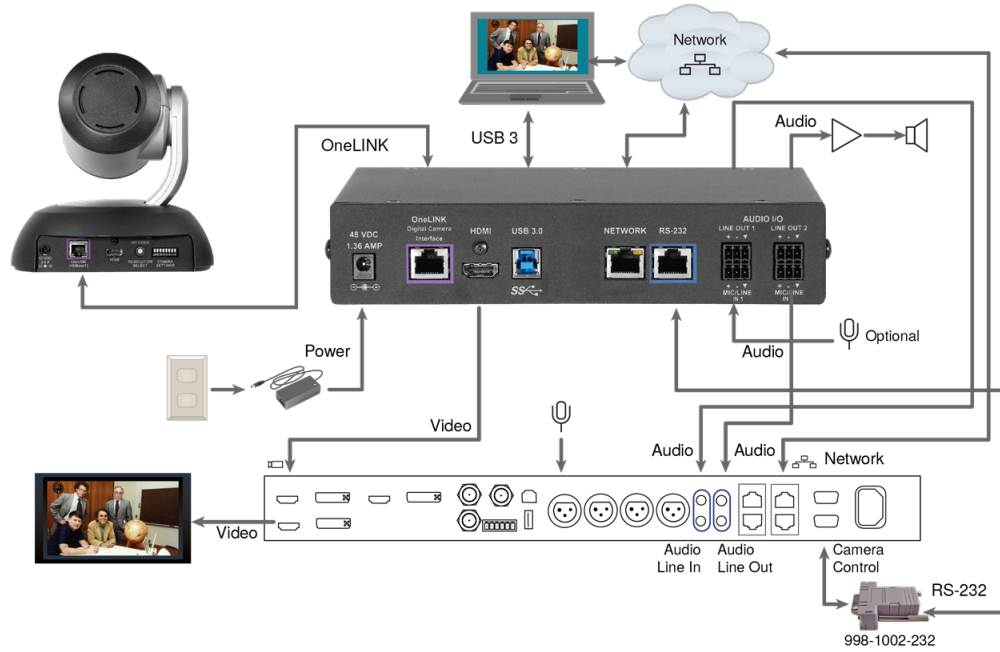

RoboSHOT HDBT Camera and Cisco SX20 Codec

This diagram shows a OneLINK Bridge AV interface with a RoboSHOT HDBT camera. The OneLINK Bridge Express connects in the same way. Other Vaddio HDBaseT cameras connect in the same way.

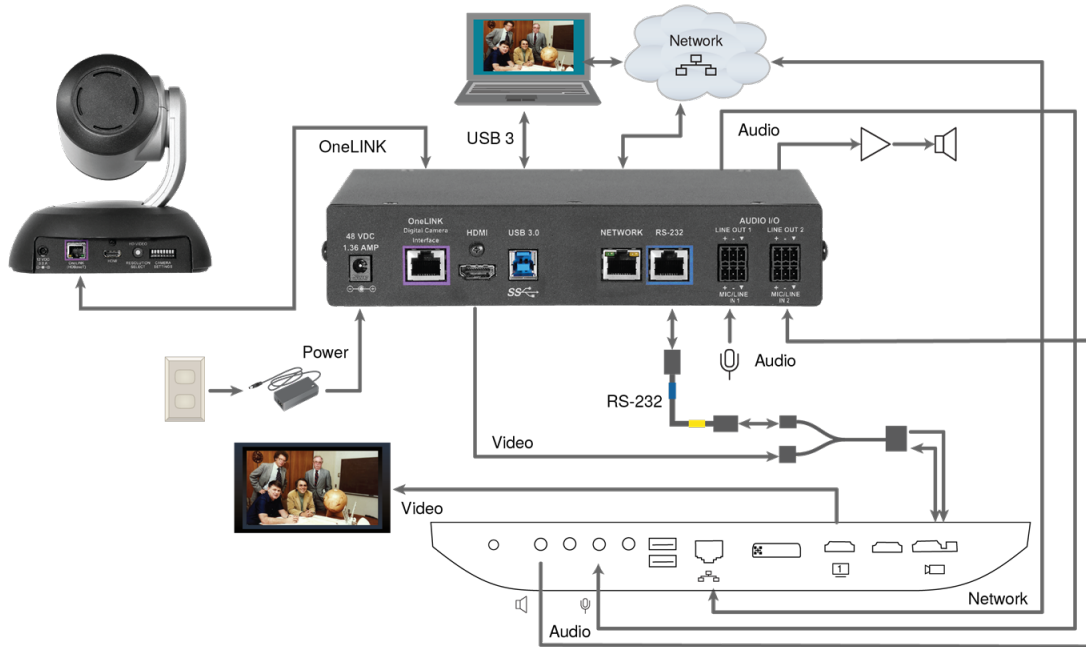

Note

If connecting to a Cisco SX20 codec, you will need to provide a Cisco split cable, Cisco part number CAB-PHD4XS2-SPLIT.

RoboSHOT HDBT Camera and Cisco SX80 Codec

This diagram shows a OneLINK Bridge AV interface with a RoboSHOT HDBT camera. The OneLINK Bridge Express connects in the same way. Other Vaddio HDBaseT cameras connect in the same way.

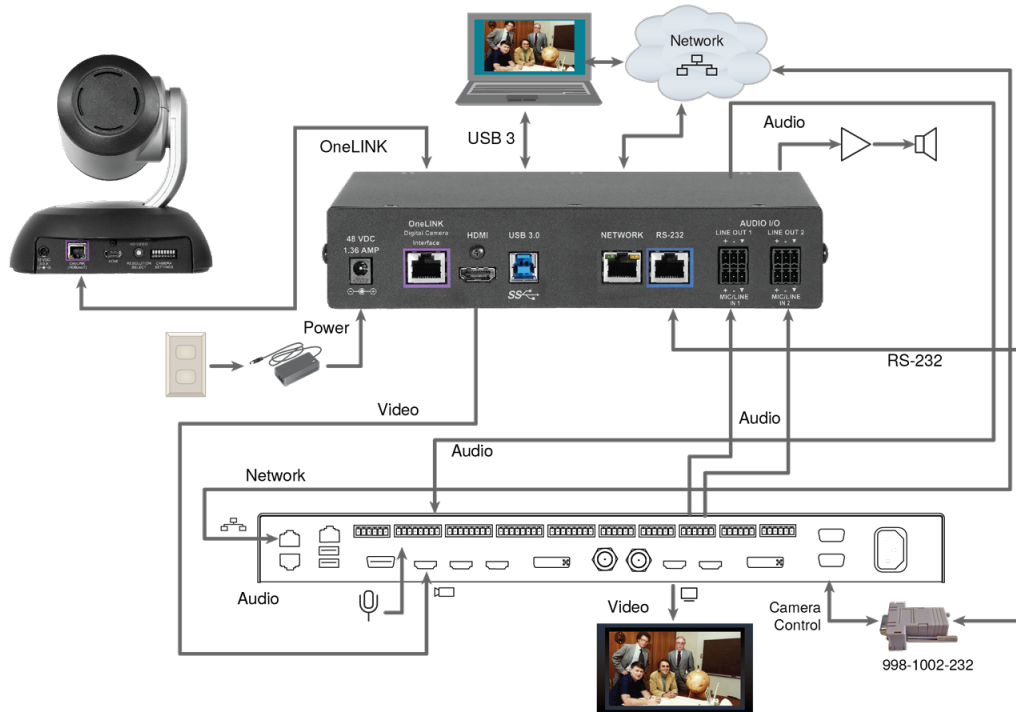

Hardware Note: RS-232 Connections

For RS-232 connections to Cisco gear using DE-9 connectors, use the 998-1002-232 RJ-45 to DE-9 adapter. Its wiring differs from the 998-1001-232 adapter used with many Vaddio products.

For RS-232 connections to Cisco gear using the Cisco split cable, use the appropriate null-modem cable to the RJ-45 side of the split cable. Connect the null-modem cable as indicated on the cable labels.

Hardware Note: Connections and Configuration Changes

After configuring the equipment, reboot the OneLINK device, camera, and codec individually. Rebooting the OneLINK device does not affect the camera and codec.

If you connect a camera or other device while it has power, reboot the OneLINK device and the newly connected device.

OneLINK Device Configuration for Audio Using a Codec

After installation is complete and the OneLINK device and camera are operational, you will need to change the AEC reference if you made the audio connections as shown in these diagrams. Set Master Output/AEC Reference to Output 2 if using Line Out 2 for the speaker connection. See [Preventing Audio Feedback](#).

Powering Up the Equipment

Power up the connected equipment that is not powered by the OneLINK device (such as displays and third-party control devices), then connect power to the OneLINK device. The connected camera and the OneLINK device power up together.

Web Interface

The OneLINK device provides a web interface to allow configuration and administration using a browser.

The web interface allows you to:

- Set idle session behavior and passwords
- Manage streaming settings
- Add identifying information to the web interface
- Back up, reboot, reset, or update the device
- View information about the camera connection
- View network-related information
- View information about the device's firmware and current settings

Many of the screen shots in this manual are from the OneLINK BridgeAV interface, which has some capabilities that are not available in the OneLINK Bridge Express device.

Working with the Connected Camera

The OneLINK device is not a camera control device. To operate the camera, use the camera's web interface. You can access this from the Pairing page. Refer to the camera's documentation for details.

The connected camera is configured separately from the OneLINK device. Changes to the OneLINK device's configuration do not affect the configuration of the camera or other connected equipment. If you need to change the way the camera is configured, log in to the camera's web interface.

Compatible Web Browsers

We have tested this product with these web browsers:

- Chrome®
- Firefox®
- Microsoft® Internet Explorer®
- Safari®

We test using the browser version available from the vendor at that time. Older versions of these browsers are likely to work, and other browsers may also work.

Initial Device Set-Up and System Administration Tasks

When any Vaddio product is shipped from the factory, there is no admin password and the administrative controls are not available. You will need to access the web interface and set the admin password. This gives you access to the administrative controls.

Initial Device Set-Up Using the Vaddio Device Controller

The Vaddio Device Controller is a stand-alone tablet for working with Vaddio products' web interfaces.

To complete the initial device set-up with the Vaddio Device Controller:

1. Connect the touch-panel to the network on the same subnet as the products you need to work with – for example, connect both to the same PoE+ switch.
2. Go to the touch-panel's Configuration page (gear icon) and select Scan.
3. Locate the device you need to work with, and select Use.
4. Select Exit to leave the Configuration page and open the device's web interface.

Note

The first time you access a device at a specific IP address, the Vaddio Device Controller's screen may remain blank for 20 seconds or more.

5. Set the admin password. This logs you in.

If the Vaddio Device Controller does not find the device, verify that the Vaddio Device Controller and the device are connected to the same subnet. You may need to [access the web interface manually](#).

Initial Device Set-Up Using the Vaddio Deployment Tool

Be sure you have the current version of the Vaddio Deployment Tool. If you have a copy of the tool already, compare its version information to the version shown on the release notes. You can find both at https://www.legrandav.com/en/products/vaddio/accessories/vaddio_deployment_tool. Release notes are under the Resources tab.

To complete the initial device set-up with the Vaddio Deployment Tool:

1. Download and install the Vaddio Deployment Tool if you have not done so already, then open it.
2. Power up the OneLINK device if you have not done so already.
3. On the Find Devices page, click Scan. If the scan does not locate the device, your computer may be on a different subnet. Click Advanced and specify the appropriate portion of the network to scan.
4. In the list of equipment that the scan discovers, locate the devices marked Not Set Up.

<input type="checkbox"/>	Name	Location	IP / Hostname	Firmware	Status	Video
<input type="checkbox"/>	RoboSHOT 12E HD-SDI Camera	Karen	10.30.219.51	3.3.0	Password <input type="password"/> Login	...
<input type="checkbox"/>	RoboSHOT 12E HDMI Camera	Very Large University Dept of Theoretical Ekphrasis	10.30.219.54	3.4.1	Password <input type="password"/> Login	...
<input type="checkbox"/>	OneLINK HDMI Camera Extension		10.30.219.56	1.2.1	Password <input type="password"/> Login	...
<input type="checkbox"/>	RoboSHOT 12E Camera		10.30.219.64	3.3.0	Password <input type="password"/> Login	...
<input type="checkbox"/>	RoboSHOT 20 UHD Camera		10.30.219.65	2.4.0	Password <input type="password"/> Login	...
<input type="checkbox"/>	OneLINK Bridge Camera Extension		10.30.219.66	1.5.1	Not set up	...

5. For each device that you need to work with, click the Not Set Up button and set the admin password on the device detail page that opens. Other people using the Vaddio Deployment Tool then have the option to log in, as shown for the other devices in the screen shot.

You can use the Vaddio Deployment Tool to access the web interface of any device in the device list, if it is set up and you have provided the admin password.

If the Vaddio Deployment Tool cannot discover the OneLINK device, you may need to [access the web interface manually](#).

Accessing the Web Interface Manually

To get the IP address:

Press the button labeled Display IP and MAC Address, on the front of the unit. The information is overlaid on the video outputs.

The OneLINK device uses the default address of 169.254.10.1 if no DHCP server is available. In this situation, you will need to connect a computer to the OneLINK device's network port and configure network settings.

To access the web interface:

Enter the IP address in your browser's address bar. You may need to enter `https://` as a prefix to keep the browser from treating it as a search query.

After the device is set up, you can access its web interface by its hostname instead of its IP address.

If the Device Is At 169.254.10.1

This is the device's default IP address. This means one of these things:

- The device is not connected to the network – check the cable connected to the Network port.
- The network does not automatically assign IP addresses, and you need to configure the device for the network.

To communicate directly with the device:

Connect a cable from your computer's network port to the device's network port. You do not need to disconnect other devices.

After completing the initial device set-up, you will need to configure the device with a static IP address. Work with your network administrator.

Completing the Initial Device Set-up

Set the admin password and complete any other required tasks, such as accepting agreements. The full administrative interface opens when you finish.

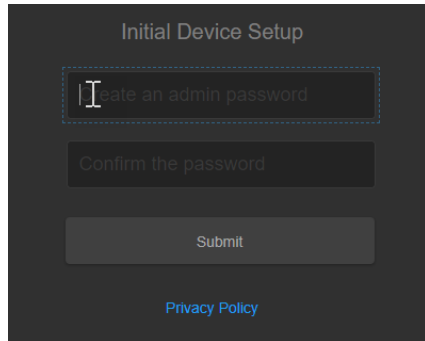

The screenshot shows a dark-themed web interface titled "Initial Device Setup". It features three input fields: "Create an admin password" (highlighted with a dashed red border), "Confirm the password", and "Submit". A "Privacy Policy" link is located at the bottom of the form.

Note

The web interface provides links to the company's standard privacy policy because the device's IP address is considered "personally identifiable information". This product does not record or save audio or video files, and it does not store any identifying information other than what you may choose to enter on the Room Labels page of the web interface.

You may also need to complete the initial device set-up and administrative configuration on the connected camera.

System Administration

Administrative tasks are on these pages of the web interface:

- **Networking** – Network configuration, time zone and NTP server
- **Security** – Passwords, guest access, other IT security-related settings
- **Room Labels** – Helpful information to display in the web interface

Some of the screen shots in this manual are from other OneLINK products, and may differ somewhat from the web interface that you see.

Configuring Access and Other Security Settings

SECURITY PAGE

The Account Passwords and Web Server areas of the Security page provide basic security for the web interface:

- Admin Password – Required for access to the admin pages of the web interface and for serial API access (via Telnet session or RS-232 connection) to the device.
- Automatically Expire Idle Sessions – Logs you out after 30 minutes of inactivity.
- Allow Telnet Access – disabled by default.
- Allow Zeroconf DNS-SD Discovery – allowed by default.
- Advanced Settings – Enable HTTP Access (disabled by default) and Manage SSL Certificate.

Note

Consult your network security specialist before changing any of these settings. Seek explicit guidance concerning the SSL certificate.

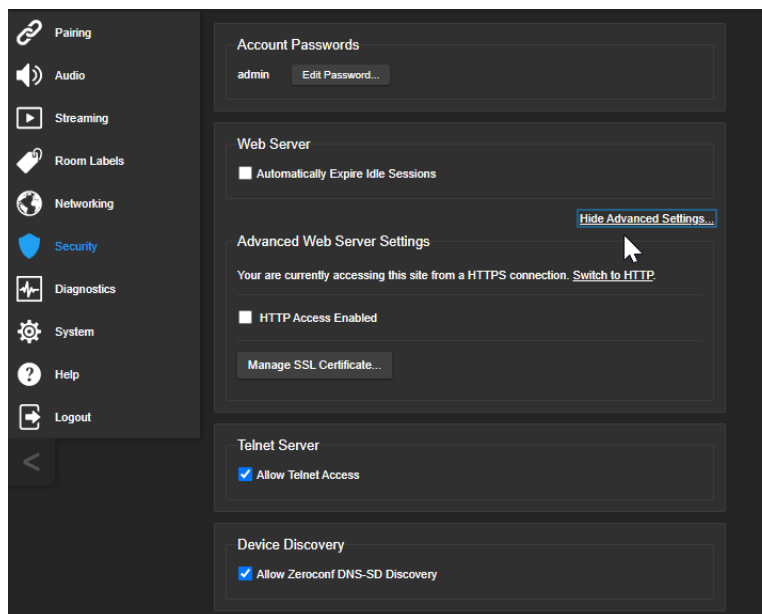

Configuring a Static IP Address for a Device Currently at 169.254.10.1

NETWORKING PAGE

These settings are for the OneLINK device only. The camera is configured separately.
If the device is currently at an IP address other than 169.254.10.1, skip this section.

By default, the device is set to DHCP, and will receive an IP address automatically if your network assigns IP addresses. However, if no DHCP server is available to automatically assign an address, the device uses its default IP address of 169.254.10.1. If you install more than one OneLINK device on a non-DHCP network, you must follow this procedure to prevent IP address conflicts.

Caution

Consult your IT department before editing network settings. Errors in network configuration can make the device inaccessible from the network. Do not change DHCP/Static addressing, IP address, subnet mask, or gateway unless you are very familiar with the characteristics and configuration of the network where you install the device.

To access the device's Networking page after initial device setup:

1. Leave the device connected as for initial device setup.
2. Log in to the web interface, if you have not done so already.
3. On the Networking page, set IP Address to Static; then enter the IP address, subnet mask, and gateway as directed by the network specialist. You will need to log in again after saving your changes.

The device is now ready to be connected to the network.

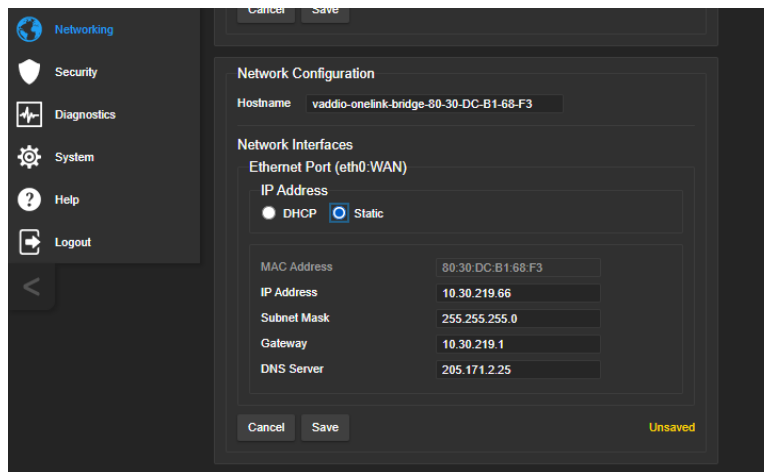

Changing from an Automatically Assigned Address to a Static IP Address

NETWORKING PAGE

In a network that assigns IP addresses automatically, the device's IP address may change from time to time. Setting a static IP address will keep this from happening,

You may wish to change the IP addresses of other connected equipment to static addresses as well. The process is the same for all Vaddio products with web interfaces.

1. Consult your network specialist to determine what the IP address should be.
2. Set the IP address to Static. If this is the only change you make, you will not be logged out.
3. If necessary, enter the IP address, subnet mask, and gateway that your network specialist instructs you to use. You will need to browse to the new IP address and log in again.

Changing the Device's Hostname

NETWORKING PAGE

If your network supports hostname resolution, you may find it convenient to change the device's hostname to something easy to remember. This allows you to access the device by its hostname instead of its IP address – for example, by entering `https://fred` to open the web interface of the device named `fred`.

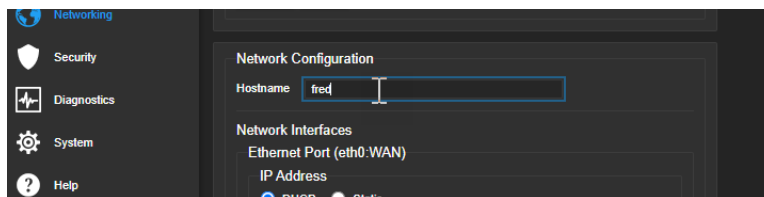

Work with your IT department to ensure that the hostname conforms to the organization's naming conventions.

Specifying Time Zone and NTP Server

NETWORKING PAGE

Using automatic NTP updating ensures that the timestamps in the device's diagnostic log are accurate. Specifying your time zone may make it easier to match logged events with other actions and external events.

1. To make the time zone and NTP server editable, enable Automatic NTP Updating.
2. Select the desired time zone from the list.
3. Optional: Specify the NTP server to use. If you are not sure about this, use the default.
4. Save your changes.
5. To update the system time immediately, select Refresh. Otherwise, the time will update the next time the device contacts the NTP server.

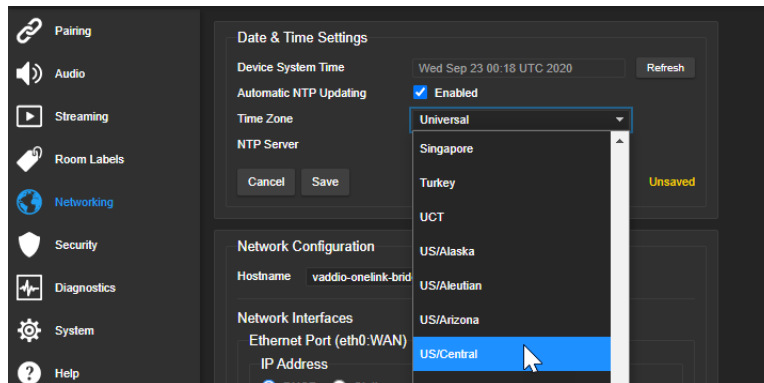

Adding Room Information to the Web Interface

ROOM LABELS PAGE

Enter information about the location of the equipment and the local IT or A/V help line. This information will be displayed on all pages of the web interface.

Note

This does not affect the room information (if any) presented on the web interface for the attached camera.

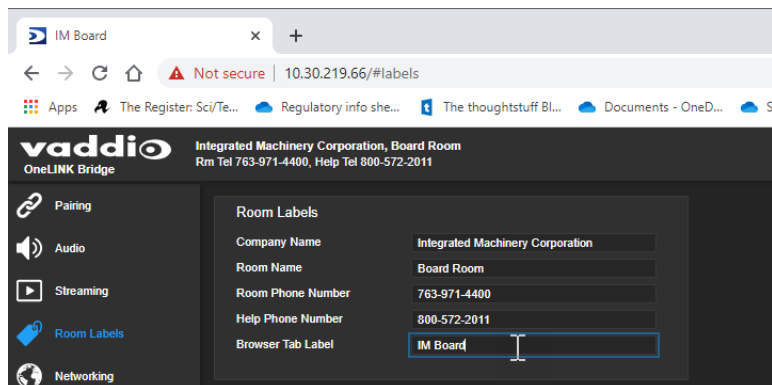

Serial Control Settings

Enhanced VISCA Mode – Enabled by default; provides enhanced support for some capabilities in HDBaseT cameras.

Baud Rate – If the installation includes devices that use RS-232 communication, set them all to use the same baud rate.

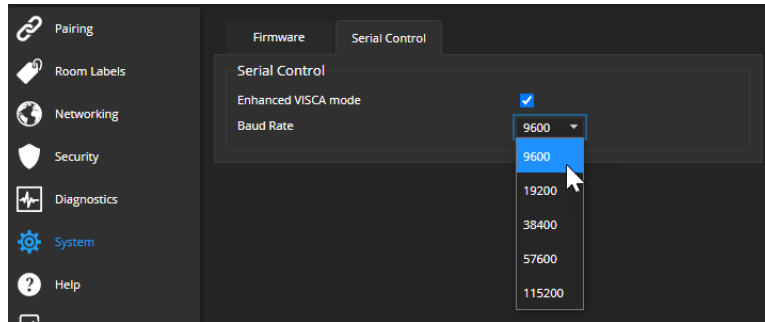

Accessing the Connected Camera's Web Interface

The Pairing page provides a link to the connected HDBaseT camera's web interface. You can also access the camera's web interface using the Vaddio Deployment Tool or a Vaddio Device Controller (if the room includes one).

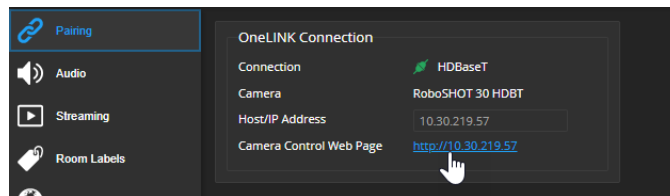

Performance and Behavior Settings

Performance and behavior settings are on these pages of the web interface:

- **Streaming** – USB streaming settings
- **Audio** – Audio adjustments; phantom power to connected microphones; audio matrix

The screen shots in this chapter are from the OneLINK Bridge, and may differ somewhat from the web interface that you see.

Configuring USB Streaming Settings

STREAMING PAGE

The camera's settings are used for IP streaming; the OneLINK device passes the IP stream from the camera and does not require additional IP streaming configuration.

For non-USB cameras, the OneLINK device provides USB streaming capability.

These settings affect how the camera works with soft conferencing applications.

- **Enable USB Streaming** – The OneLINK device can originate a USB stream only when this is selected.
- **USB Device Name** – Specify how the camera shows up in your soft client's camera selection list.
- **HID Audio Controls** – Enable to allow conferencing applications to control the audio.
- **Enable UVC Extensions** – Allow conferencing applications to control the camera.

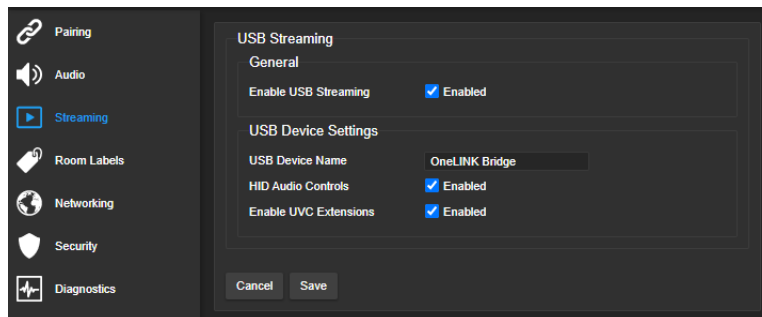

Note

When HID Audio Controls are enabled, the conferencing application manages the volume automatically. If necessary, you can disable HID Audio Controls to control volume manually.

Configuring Audio Settings

AUDIO PAGE

The web interface provides separate controls for each of the audio inputs and outputs:

- Analog (Mic/Line In 1 and 2, and Line Out 1 and 2)
- Digital (HDBT Input left and right, HDMI Output left and right)
- Streaming (USB Playback left and right, HDBT Output left and right, USB Record left and right)

The Matrix tab of the Audio page defines audio routing.

Quick Adjustments – Muting and Volume

AUDIO PAGE, ANALOG, DIGITAL, AND STREAMING TABS

To mute all microphones:

Use the Mute control at the top of any page.



To control volume on individual inputs or outputs:

Use the button to mute the desired audio input or output. Use the slider to set the volume.

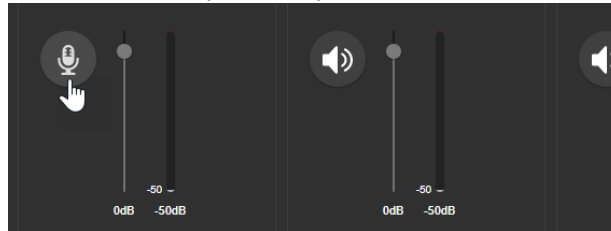

Note

For best performance with most computers, we recommend setting the USB Record volume high.

Enabling Phantom Power to Microphones

AUDIO PAGE, ANALOG TAB

To supply 48 VDC phantom power to a connected microphone, check the Phantom Power checkbox below the controls for the Line/Mic input.

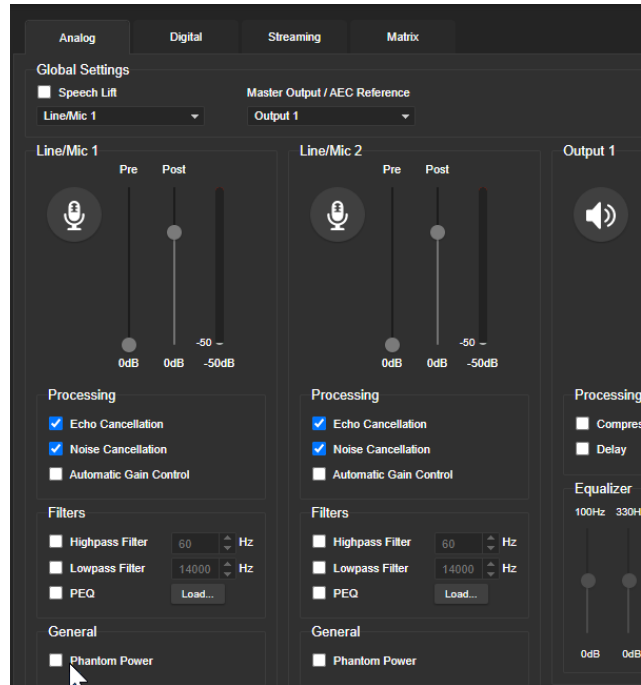

Reading the Audio Matrix

AUDIO PAGE, MATRIX TAB

The audio matrix shows where each audio output originates. Each column of the matrix shows one audio output, and each row shows one audio input. Table cells highlighted in blue mean that the input represented in that row is routed to the output represented in that column. More than one input may be routed to a given output. The defaults are:

- **USB Playback** left and right (far-end audio from the soft conferencing client) route to **line output 1** (typically the speaker in your conference room).
- **Line/Mic 1** (your room's microphone) routes to **USB Record** left and right (the audio that the participants on the far end hear).
- **HDBT** left and right (far-end audio received as part of the HDMI signal over the HDBT connection) routes to **HDMI Output** left and right, and goes to the HDMI display's speakers.

The screenshot shows the 'Matrix' tab in the audio settings. At the top, there are tabs for 'Analog', 'Digital', 'Streaming', and 'Matrix'. Below these are 'Global Settings' including 'Speech Lift', 'Master Output / AEC Reference', and 'Chairman Override Input'. A dropdown menu shows 'Line/Mic 1' selected for 'Output 1'. The main part of the interface is a grid with rows for 'Auto Mic Mixer', 'Line/Mic 1', 'Line/Mic 2', 'USB Playback Left', 'USB Playback Right', 'HDBT Input Left', and 'HDBT Input Right'. The columns are 'Output 1', 'Output 2', 'USB Record Left', 'USB Record Right', 'HDMI Output Left', 'HDMI Output Right', and 'HDBT Output Left', 'HDBT Output Right'. The grid cells show 'On 0db' (blue) or 'Off 0db' (grey). A legend on the right indicates 'In Auto Mic Mixer' (green), 'Enabled' (blue), 'Disabled' (grey), 'Unavailable' (black), and 'Speech Lift' (red).

	Output 1	Output 2	USB Record Left	USB Record Right	HDMI Output Left	HDMI Output Right	HDBT Output Left	HDBT Output Right
Auto Mic Mixer	Off 0db	Off 0db	Off 0db	Off 0db	Off 0db	Off 0db	Off 0db	Off 0db
Line/Mic 1	Off 0db	Off 0db	On 0db	On 0db	Off 0db	Off 0db	Off 0db	Off 0db
Line/Mic 2	Off 0db	Off 0db	Off 0db	Off 0db	Off 0db	Off 0db	Off 0db	Off 0db
USB Playback Left	On 0db	Off 0db			Off 0db	Off 0db	Off 0db	Off 0db
USB Playback Right	On 0db	Off 0db			Off 0db	Off 0db	Off 0db	Off 0db
HDBT Input Left	Off 0db	Off 0db	Off 0db	Off 0db	On 0db	Off 0db	Off 0db	Off 0db
HDBT Input Right	Off 0db	Off 0db	Off 0db	Off 0db	Off 0db	On 0db	Off 0db	Off 0db

Routing Audio

AUDIO PAGE, MATRIX TAB

To specify how the OneLINK Bridge uses a given audio input, locate its row. Locate the column representing the desired output and select the table cell where the desired row and column intersect.

Example: The USB stream has left and right audio channels, but by default Line/Mic 1 provides the source for both channels of outbound USB audio (USB Record left and right) and both channels of incoming USB audio are routed to Output 1 (Audio Line Out 1). You might choose to change the default matrix to provide separate right and left channels of outbound and inbound USB audio.

Default Microphone Settings

AUDIO PAGE, ANALOG TAB

Acoustic Echo Cancellation – Enabled; prevents audio feedback by cancelling the specified output signal out of the line/mic input.

Note

If using the OneLINK Bridge with a conferencing codec, ensure that echo cancellation is enabled on only one device, whether it is the OneLINK Bridge or the codec. If echo cancellation is enabled on both the OneLINK Bridge and the codec, unexpected audio effects may result. We recommend disabling echo cancellation on the OneLINK Bridge and allowing the conferencing codec to handle it.

Noise Cancellation – Enabled; suppresses ambient noise.

Automatic Gain Control – Disabled; adjusts gain to compensate for differences in volume as different people speak.

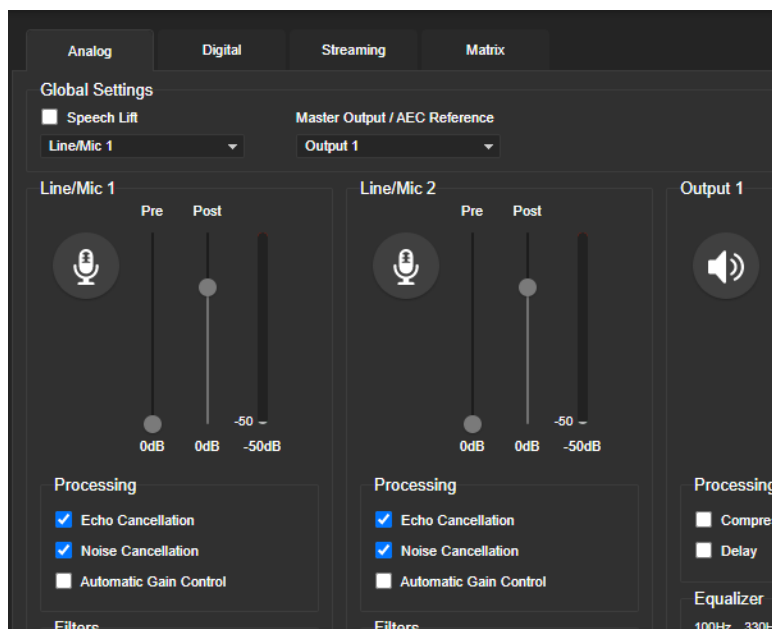

Microphone Settings for Environments with Audiences

AUDIO PAGE, ANALOG AND MATRIX TABS

Speech Lift: Feeds the signal from the specified microphone to the speakers in the room, so that people in the back of the room can hear the person who is speaking.

Chairman Override: Gives priority to the specified microphone when more than one person is speaking. (Matrix tab only)

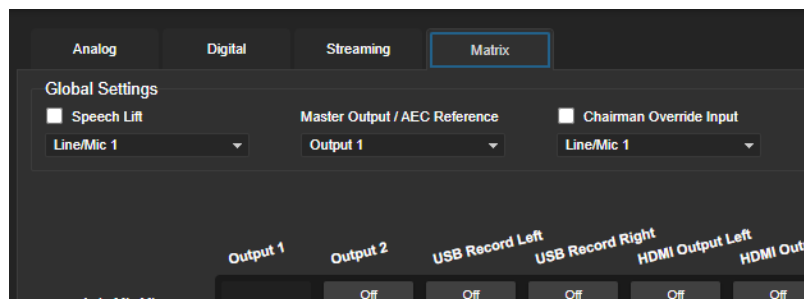

Microphone Adjustments

AUDIO PAGE, ANALOG TAB

To adjust for more natural speech reproduction:

- **High-pass filter** – Specify the lowest frequency that the microphone should pick up. Use this setting to reduce low-frequency background noise such as heating/air conditioning systems.
- **Low-pass filter** – Specify the highest frequency that the microphone should pick up. Use this setting to reduce hissing sounds and make speech sound natural.
- **PEQ** (parametric equalizer) – Increase or reduce the volume of specific frequency ranges to compensate for the audio challenges unique to the situation.

Note

As a best practice, use the equalizer to attenuate undesirable frequency ranges rather than to boost the desirable frequencies.

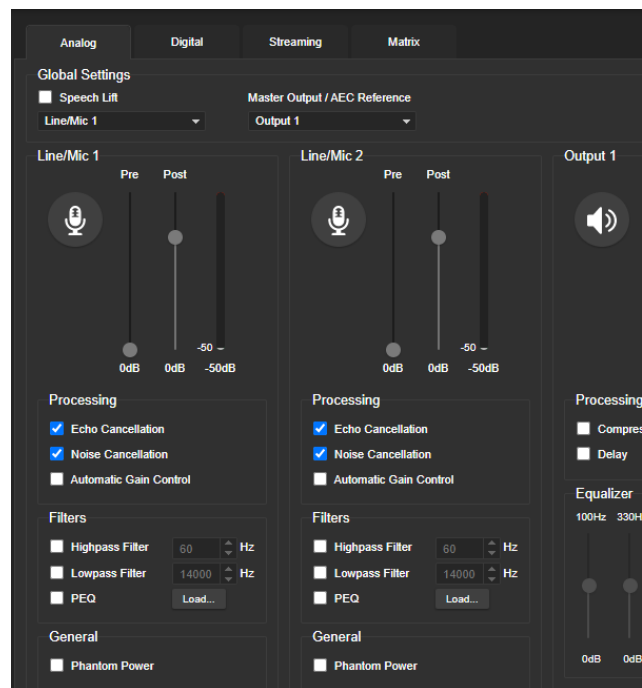

Speaker Adjustments

AUDIO PAGE, ANALOG AND STREAMING TABS

To sync the sound with the video:

If the video lags noticeably behind the audio, check the Delay box for the appropriate audio outputs (Analog or Streaming tab) and enter a delay value in msec. The delay may differ from one output to another.

To compensate for differing speech volumes:

If some people on the far end are inaudible while others are too loud, check the Compressor box to reduce the dynamic range from the connected speakers. (Analog tab only.)

To compensate for specific audio issues on the far end:

Use the equalizers for the analog outputs to attenuate specific frequency ranges. This can help if the far-end audio includes unwanted elements such as a rumbling HVAC system or a cricket in the room.



About Echo Cancellation

When a microphone picks up the audio from a speaker (far-end audio) during a conference, it sends the far-end audio back to the participants at the far end, creating an echo. Acoustic echo cancellation prevents this.

Here's how it works:

1. The speaker feeds the far-end audio into the room. This signal also goes to the audio processor as the reference that needs to be canceled.
2. The audio processor inverts the signal and sends it to the microphone.
3. The sum of the audio that the microphone picks up from the speaker and the inverted signal is 0: The echo is canceled.

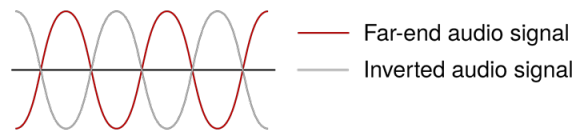

With the audio from the speaker canceled out, the audio from the microphone includes only the sounds originating at your end of the conference.

Preventing Audio Feedback

AUDIO PAGE, ANALOG TAB

Audio feedback results when the microphones pick up audio from the speakers.

1. Select Echo Cancellation on any line inputs that are connected to signal sources.
2. In the Global Settings, under Master Output/AEC Reference, select the audio output to use as the reference - the signal that will be cancelled out of the inputs. Set Master Output/AEC Reference to Output 2 if using Line Out 2 for the speaker connection, as shown in some of the connection diagrams in this manual.

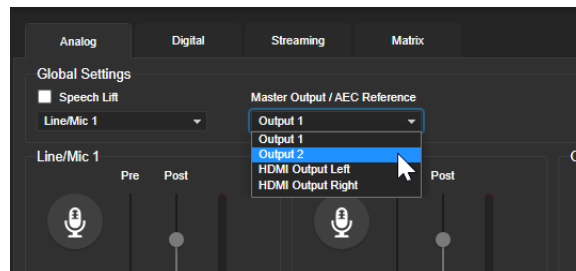

System Maintenance

This chapter covers the tasks on the System page:

- Exporting (backing up) and importing configuration data
- Updating firmware
- Rebooting

It also includes information that you may need if you contact Vaddio Technical Support.

Some of the screen shots in this chapter are from other OneLINK products, and may differ somewhat from the web interface that you see.

Exporting and Importing Configuration Data

SYSTEM PAGE, FIRMWARE TAB

You can export a device's configuration and save it as a backup. This allows you to quickly restore customized information if you need to [restore factory defaults](#) or replace the unit, or import a configuration to multiple devices.

The exported data includes settings that may be the same on several devices – the room label, NTP and time zone information, audio settings, and streaming settings.

Security and network settings are not included in the export file.

When importing a configuration to multiple devices:

- All the devices must be of the same model.
- All the devices must have compatible firmware versions installed.

To export a configuration:

To save a copy of the current configuration, select Export Data.

The configuration exports as a `.dat` file and downloads to your default file download location. The filename is the device's hostname followed by the `.dat` file extension.

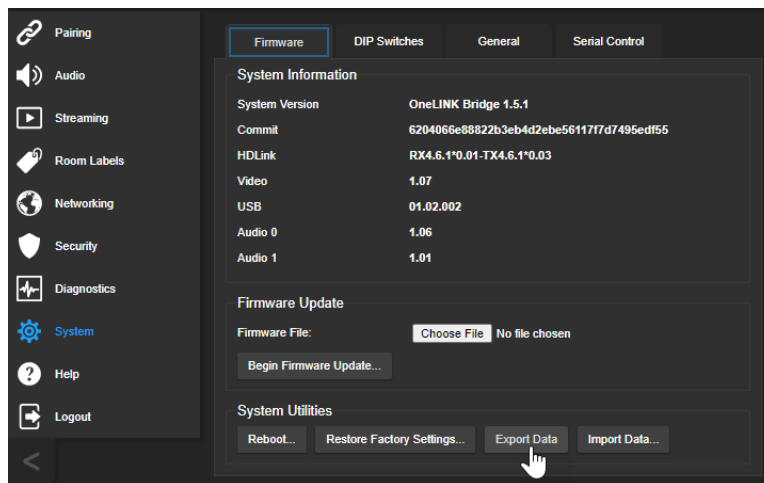

To import a configuration:

1. Select Import. The Import Data box opens.
2. Select Choose File, and browse to the `.dat` file to be imported.
3. Select Begin Importing Data. When the import is complete, the device reboots.

Starting a Firmware Update

SYSTEM PAGE

Caution

Do not remove power or disconnect the OneLINK device while a firmware update in progress. Interrupting a firmware update can make the OneLINK device unusable.

1. Be sure you have downloaded the appropriate update file to your computer.
2. OPTIONAL: Select Export Data to save a copy of the OneLINK device's current configuration. You probably won't need it, but it could save time if you need to roll back the update.
3. Select Choose File, browse to the firmware update file that you downloaded, and select it. The filename ends with .p7m. The System page then displays the filename beside the Choose File button.
4. Select Begin Firmware Update.

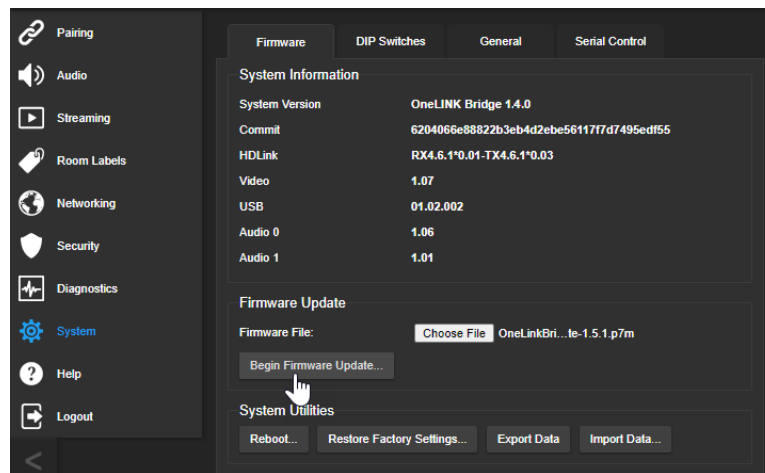

5. READ the information in the Confirm dialog box and be sure you understand it.
6. When you are ready to start the update, select Continue.
7. If you have any problems with the update, take screen shots if possible, and contact Vaddio technical support. We can help you better when we have the exact text of any warnings or error messages that you encounter. See [Contacting Vaddio Technical Support and Viewing Diagnostics](#).

Rebooting the OneLINK Device

SYSTEM PAGE

This may help if the OneLINK device stops responding as you expect.

In the System Utilities section of the System page, select Reboot.

Contacting Vaddio Technical Support and Viewing Diagnostics

HELP PAGE, DIAGNOSTICS PAGE

If you encounter an issue that you can't resolve using your superior troubleshooting skills (and the [Troubleshooting](#) section of this guide), go to the Help page for information on contacting Vaddio Technical Support.

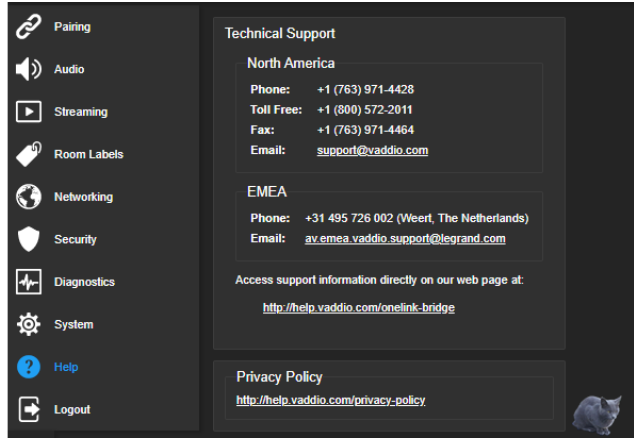

Note

The web interface provides links to the company's standard privacy policy because the device's IP address is considered "personally identifiable information". This product does not record or save audio or video files, and it does not store any identifying information other than what you may choose to enter on the Room Labels page of the web interface.

Your Vaddio technical support representative may ask you to download and email the event log file available from the Diagnostics page. The log may include large numbers of internal events even when no errors have occurred. Rebooting generates over 100 log entries.

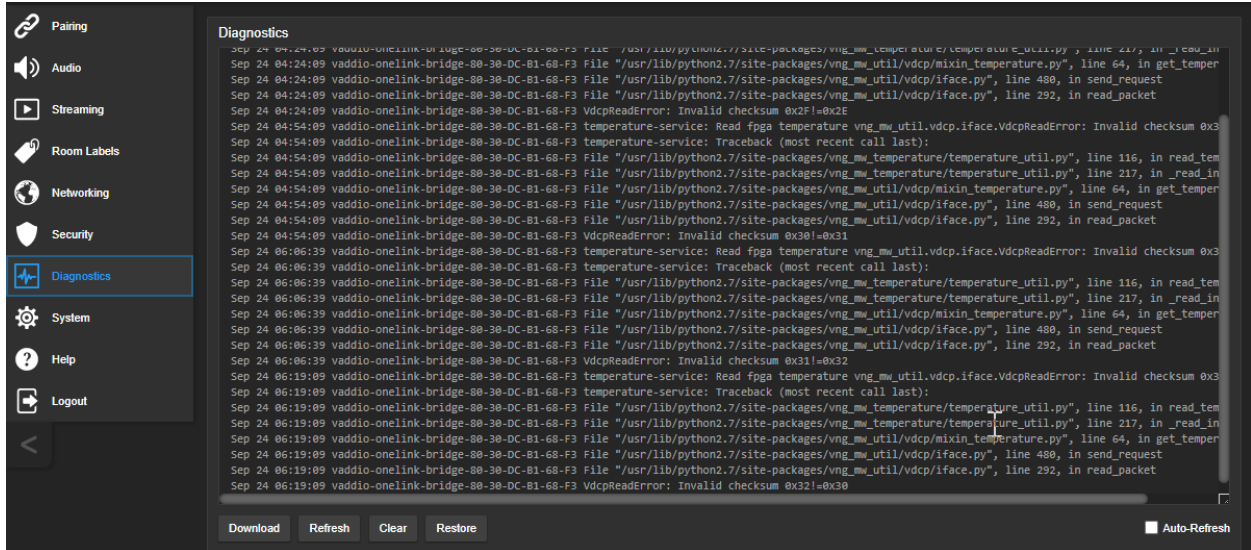

Serial Command API

The Vaddio serial command API is a high-level, text-based command line interface to allow an external device such as AMX or Crestron to control the OneLINK device. The serial command API can be accessed via Telnet. Windows provides a built-in Telnet client; PuTTY can also be used.

Telnet connections use port 23.

Note

At the start of the session, you must log in using the admin account.

Note

By default, Telnet access is disabled in all firmware releases issued after December 2019. Enable it on the Security page of the web interface.

Usage notes:

- The > character is the command prompt.
- Using a question mark as a command or command parameter will bring up a list of available commands, subcommands, or command parameters. For example, ? returns all top-level commands; system ? returns the valid subcommands for the system command; and system reboot ? returns the parameter available for the system reboot command.
- CTRL-5 clears the current serial buffer on the device.

Typographical conventions:

- { x | y | z } – Choose x, y, or z.
- <variable> – Substitute the desired value here.
- < x - y > – Valid range of values is from x through y.
- [parameter] – Parameter is not required.

Note

The commands in this manual refer to the OneLINK device. To control the connected camera, open a Telnet session to the camera's IP address and use the camera's Telnet commands, or connect a camera controller to the OneLINK device's RS-232 port and use the camera's VISCA-compatible RS-232 serial control API.

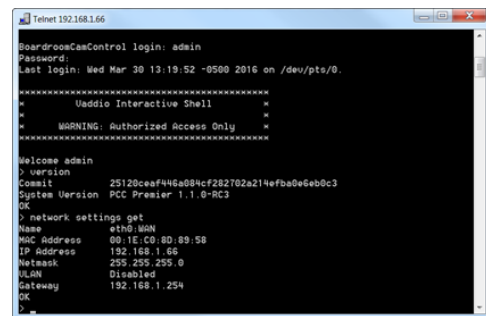

```

Telnet 192.168.1.66
BoardroomCamControl login: admin
Password:
Last login: Wed Mar 30 13:19:52 -0500 2016 on /dev/pts/0.

*****
*           Uaddio Interactive Shell           *
*****
*           WARNING: Authorized Access Only           *
*****

Welcome admin
> version
Commit      25120ceaf446a884cf282702a214fba0e6eb0c3
System Version PCC Premier 1.1.0-RC3
OK

> network settings get
Name        eth0 WAN
Mac Address 00:1C:00:00:89:58
IP Address  192.168.1.66
Netmask     255.255.255.0
DNS         Disabled
Gateway     192.168.1.254
OK
>

```

Audio Management Commands

The following commands are available for audio management:

- audio volume
- audio mute
- audio route
- audio crosspoint-gain

Channels Available for Audio Commands

Audio mute and volume commands may be applied to all audio channels at once (`master`) or one specific input or output. Routing and crosspoint gain commands must specify individual channels.

Inputs

<code>master</code>	All audio inputs (Not available for <code>audio route</code> and <code>audio crosspoint-gain</code> commands)
<code>line_in_1</code> and <code>line_in_2</code>	Microphones or other line-level inputs
<code>usb3_playback_left</code> and <code>usb3_playback_right</code>	Left and right USB audio channels from the far end
<code>hdbt_in_left</code> and <code>hdbt_in_right</code>	Left and right audio channels from a connected HDBaseT input device

Outputs

<code>master</code>	All audio outputs
<code>line_out_1</code> and <code>line_out_2</code>	Speakers or other line-level outputs
<code>usb3_record_left</code> and <code>usb3_record_right</code>	Left and right USB audio channels from your site
<code>hdmi_out_left</code> and <code>hdmi_out_right</code>	Left and right audio channels out to a connected HDMI device
<code>hdbt_out_left</code> and <code>hdbt_out_right</code>	Left and right audio channels out to a connected HDBaseT device

audio volume

Gets or sets the volume of the specified audio channel.

See [Channels Available for Audio Commands](#) for the audio input and output channels available.

Synopsis	audio <channel> volume {get on off toggle}	
Options	get	Returns the current volume of the specified channel.
	up	Increases the volume of the specified channel.
	down	Reduces the volume of the specified channel.
	set	Sets the volume of the specified channel.
Examples	<pre>audio line_in_1 volume set -5 OK ></pre> <p>Sets -5 dB as the volume for the device connected to the Line In 1 port.</p> <pre>audio line_out_1 volume get volume -10.0 dB OK ></pre> <p>Returns the current volume for the speaker connected to the line out port.</p>	

audio mute

Gets or sets the mute status of the specified audio channel.

See [Channels Available for Audio Commands](#) for the audio input and output channels available.

Synopsis	audio <channel> mute {get on off toggle}	
Options	get	Returns the current mute status of the specified channel.
	on	Mutes the audio for the specified channel.
	off	Unmutes the audio for the specified channel.
	toggle	Changes the mute state for the specified channel – unmutes if it was muted, mutes if it was not.
Examples	<pre>> audio line_out_1 mute get mute: off OK ></pre> <p>Returns the current mute state of the device connected to audio line out 1. Mute is off, so the audio is on.</p> <pre>>audio master mute on OK ></pre> <p>Mutes all audio.</p>	

audio route

Gets or sets the input routed to the specified output.

See [Channels Available for Audio Commands](#) for the audio input and output channels available.

Synopsis	audio <output channel> route {get set <input channel>}	
Options	get	Returns the routing for the specified output.
	set <input channel>	Sets the routing for the specified input. More than one input may be specified.
Examples	<pre>> audio line_out_1 route get [usb3_playback_left usb3_playback_right] OK ></pre> <p>Returns the current source of the audio output on Line Out 1 (typically a speaker). Both channels of far-end audio from the USB stream are currently routed to this output.</p>	

audio crosspoint-gain

Returns or sets the current routing gain, in dB, for the crosspoint between a given output and input.

See [Channels Available for Audio Commands](#) for the audio input and output channels available.

Synopsis	audio <output channel> crosspoint-gain <input channel> {get set <level>}	
Options	get	Returns the gain from the specified input to the specified output.
	set <-12.0 .. 12.0>	Sets the gain from the specified input to the specified output. Valid range is -12.0 dB to 12.0 dB.
Examples	<pre>> audio line_out_1 crosspoint-gain usb3_in_left get 3.9 OK ></pre> <p>Returns the gain from the left channel of the USB 3 playback to the Line Out 1 output.</p> <pre>> audio line_out_1 crosspoint-gain usb3_in_left set -3 OK ></pre> <p>Sets the gain from the left channel of the USB 3 playback to the Line Out 1 output to -3 dB.</p>	

Communication and Power Commands

These commands are available for managing power and sequences of actions:

- network settings get
- link power

network settings get

Returns the current network settings for MAC address, IP address, subnet mask, and gateway.

Synopsis	network settings get
Example	<pre>> network settings get Name eth0:WAN MAC Address 00:1E:C0:F6:CA:7B IP Address 192.168.1.67 Netmask 255.255.255.0 VLAN Disabled Gateway 192.168.1.254 OK ></pre>

link power

Sets the camera's power connection on or off.

Note

The OneLINK device does not provide camera control. To set the camera to standby instead of powering it off, use the camera's remote or other camera control interface to issue a standby command directly to the camera.

Synopsis	link power { on off }	
Options	off	Powers off the camera connection. Camera power remains off until the OneLINK device receives a <code>link power on</code> command or a reboot.
	on	Powers on the camera connection.
Examples	<pre>>link power off OK ></pre> <p> Powers off the camera connection.</p>	

Maintenance and Troubleshooting Commands

The following commands are available for maintenance and troubleshooting:

- version
- network ping
- system reboot
- system factory-reset

version

Returns the current firmware version of the OneLINK device.

Synopsis	version
Example	version Returns current firmware version information in a form something like this:

network ping

Sends an ICMP ECHO_REQUEST to the specified IP address or hostname.

Synopsis	network ping [count <count>] [size <size>] <destination-ip>	
Options	<count>	The number of ECHO_REQUEST packets to send. Default is five packets.
	<size>	The size of each ECHO_REQUEST packet. Default is 56 bytes.
	<destination-ip>	The IP address where the ECHO_REQUEST packets will be sent.
Examples	<pre>>network ping 192.168.1.66 PING 192.168.1.66 (192.168.1.66): 56 data bytes 64 bytes from 192.168.1.66: seq=0 ttl=64 time=0.476 ms 64 bytes from 192.168.1.66: seq=1 ttl=64 time=0.416 ms 64 bytes from 192.168.1.66: seq=2 ttl=64 time=0.410 ms 64 bytes from 192.168.1.66: seq=3 ttl=64 time=0.410 ms 64 bytes from 192.168.1.66: seq=4 ttl=64 time=3.112 ms --- 192.168.1.66 ping statistics --- 5 packets transmitted, 5 packets received, 0% packet loss round-trip min/avg/max = 0.410/0.964/3.112 ms ></pre> <p>Sends five ECHO_REQUEST packets of 56 bytes each to the host at 192.168.1.66.</p>	
	<pre>>network ping count 10 size 100 192.168.1.1</pre> <p>Sends 10 ECHO_REQUEST packets of 100 bytes each to the host at 192.168.1.1. The command returns data in the same form as above.</p>	

system reboot

Reboots the system either immediately or after the specified delay. Note that a reboot is required when resetting the system to factory defaults (system factory-reset).

Synopsis	system reboot [<seconds>]	
Options	<seconds>	The number of seconds to delay the reboot.
Examples	<p>Reboots the system immediately.</p> <pre>>system reboot 30</pre> <p>Reboots the system in 30 seconds. The response appears at the end of the delay.</p>	

system factory-reset

Gets or sets the factory reset status. When the factory reset status is on, the OneLINK device resets to factory defaults on the next reboot.

Note

This does not reset the camera.

Synopsis	system factory-reset { get on off }	
Options	get	Returns the camera's current factory reset status.
	on	Enables factory reset on reboot.
	off	Disables factory reset on reboot.
Examples	<pre>>system factory-reset get factory-reset (software): off factory-reset (hardware): off OK ></pre> <p>Returns the factory reset status.</p> <p>This evaluates the most recent <code>system factory-reset on</code> or <code>off</code> command, if one has been received, then reads the rear panel DIP switches and returns the status <code>on</code> if they are all in the down position.</p> <pre>>system factory-reset on factory-reset (software): on factory-reset (hardware): off OK ></pre> <p>Enables factory reset upon reboot.</p> <p>Note <i>This command does not initiate a factory reset. The factory reset takes place on the next reboot.</i></p>	

Telnet Information and Session Management Commands

The following commands are available for Telnet help and session management:

- help
- history
- exit

You can also use a question mark as a command or command parameter to display a list of available commands, subcommands, or command parameters. For example, `?` returns all top-level commands; `system ?` returns the valid subcommands for the system command; and `system reboot ?` returns any parameters available for the system reboot command.

history

Returns the most recently issued commands from the current session.

Synopsis	history <limit>	
Options	<limit>	Integer value specifying the maximum number of commands to return.
Examples	<p>history Displays the current command buffer.</p> <p>history 5 Sets the history command buffer to remember the last 5 unique entries.</p>	
Additional information	<p>You can navigate the command history using the up and down arrow keys. This command supports the expansion functionality from which previous commands can be recalled from within a single session. History expansion is performed immediately after a complete line is read.</p> <p>Examples of history expansion:</p> <ul style="list-style-type: none"> * !! Substitute the last command line. * !4 Substitute the 4th command line (absolute as per 'history' command) * !-3 Substitute the command line entered 3 lines before (relative) 	



help

Displays an overview of the CLI syntax.

Synopsis	help
Example	<p>help</p>



exit

Ends the command session and closes the socket.

Synopsis	exit
Example	exit

Troubleshooting

When the equipment doesn't behave as you expect, check for error indications and messages first.

Check the camera:

If the problem might be with the Vaddio camera connected to the OneLINK device, check the color of the camera's status light before you do anything else – but keep in mind that the camera's status light can be turned off in the administrative interface.

- Purple – booting or in standby (low power) mode.
- Blue – normal operation.
- Red – Tally function; the camera is on-air.
- Blinking blue – video is muted.
- Blinking red – video is muted, or fault condition.
- Yellow – firmware update in progress.

Check the OneLINK device:

Now check the OneLINK device's web interface for error messages.

If neither of these reveal the problem, use these tables to determine whether it's time to call Vaddio Technical Support.

Power Issues

What is it doing?	Possible causes	Check and correct
Nothing. The lights are off. The camera is not receiving power. 	The OneLINK device's power pack is not plugged in to main power.	Plug the power pack into a wall outlet.
	The wall outlet is not active. (Check by finding out if it powers something else, such as a laptop or phone charger.)	Plug the OneLINK power pack into a different outlet.
	"He's dead, Jim."	Contact your reseller or Vaddio Technical Support.
The camera is not receiving power but the OneLINK device has power.	The camera cable is bad.	Replace the cable.
Camera does not finish booting or does not go to the ready state.	Possible cable issue.	Test with shorter cables. Try re-terminating the cable.

Communication Issues

What is it doing?	Possible causes	Check and correct
The camera is on, but its web interface is not available.	A cable is not connected.	Make sure all network and OneLINK cables are connected.
	The network or OneLINK cable is bad.	Replace the bad cable.
	The camera is not using the IP address you browsed to.	Vaddio cameras: Press the Data Screen button on the remote to see the camera's IP address.

Video and Audio Issues

What is it doing?	Possible causes	Check and correct
The camera is on but not transmitting video.	Possible cable length issue.	Try a better grade of cable (Cat-6 or Cat-7) for the OneLINK connection.
Video drops out repeatedly.	Possible cable inductance issue.	Do not store excess cable by coiling it neatly. Best practice: Build cables to the required length.
Video and audio don't match up – speech is audible before the person on the far end appears to start speaking.	The audio signal is arriving before the video signal, which is normal but not desirable.	For the affected audio outputs (Line Out, HDMI Out, or USB Record), enable Delay and enter a value in milliseconds.
When connected to a conferencing codec: Far-end audio drops out periodically, and the issue may intensify.	Echo cancellation is enabled on both the codec and the OneLINK device.	Disable echo cancellation on the OneLINK device.
Audio feedback or echo that intensifies.	Echo cancellation is disabled.	If using the OneLINK device with a conferencing codec, enable echo cancellation on the codec. Otherwise, enable echo cancellation on the OneLINK device.

Restoring Factory Defaults

This operation returns the device to its original state.

- Any settings you have customized will be lost.
- Anyone who is logged in to the web interface is logged out.
- You will need to do the initial device setup again to be able to communicate with the device.

You can restore factory defaults from the web interface (System page, Firmware tab) or by sending the Telnet command `system factory-reset on` followed by `system reboot`. If you are not able to log in to the device, contact Vaddio Technical Support.

If the password is unknown:

1. Disconnect power.
2. Press and hold the IP address button while reconnecting power; continue to hold the button for 15 seconds.

Operation, Storage, and Care

For smears or smudges on the product, wipe with a clean, soft cloth. Use a lens cleaner on the lens. Do not use any abrasive chemicals.

Keep this device away from food and liquids.

Do not operate or store the device under any of the following conditions:

- Temperatures above 104°F (40°F) or below 32°F (0°C)
- High humidity, condensing or wet environments
- Inclement weather
- Severe vibration
- In or on top of a pizza oven
- Dry environments with an excess of static discharge

Do not attempt to take this product apart. There are no user-serviceable components inside.

Index

A

- acoustic echo cancellation 24
- adjusting microphones 24
- admin login 15
- admin password 14
 - initial 14
- AEC 27
- AGC (automatic gain control) 24-25
- ambient noise, suppressing 24
- anatomy of the OneLINK device 2
- API 31-32, 35-36, 38
 - syntax help 38
- audio 21, 23-27, 32-34
 - controls 21, 24-26
 - crosspoint gain 34
 - delay 25-26
 - feedback, preventing 24, 27
 - matrix, default 23
 - matrix, editing 23, 34
 - muting 21, 33
 - routing 23
 - volume 21, 33
- Audio page (web) 21-27
- automatic gain control 24
- automatic inactivity time-out (web session) 15
- automatic NTP updating 18

B

- backing up a configuration 28
- browser compatibility 11

C

- cable connectors 2-3
- cables 1, 3, 10
 - maximum length 1, 3
 - null-modem 10
- capabilities 1
- chairman override (microphone setting) 24
- cleaning 41
- command history 38
- commands 32
- compatibility, browsers 11
- configuration data 28
 - exporting 28

- importing 28
- configuration, saving or restoring 28
- configuring 27
 - AEC reference 27
- connection diagram 5-10
 - block, HDBaseT camera 5
 - block, HDBaseT camera with codec 6
 - Vaddio HDBaseT with Cisco C20 7
 - Vaddio HDBaseT with Cisco C40 8
 - Vaddio HDBaseT with Cisco C60 8
 - Vaddio HDBaseT with Cisco SX20 9
 - Vaddio HDBaseT with Cisco SX80 10
 - Vaddio HDBaseT with Polycom RPG 310 6
 - Vaddio HDBaseT with Polycom RPG 500 6
 - Vaddio HDBaseT with Polycom RPG 700 7
- connectors 2-3
 - identification 2
- cycle power to the camera 35

D

- damage, preventing 3
- date and time 18
- default settings, restoring 37, 41
- DHCP addressing 17
- DHCP vs. non-DHCP networks 13
- Diagnostics page (web) 30
- dynamic range 25

E

- echo cancellation 24-25, 27
- equalizer 25-26
- equipment location information 18
- exporting configuration data 28

F

- factory defaults, restoring 37, 41
- fault isolation 39
- firmware update 29
- firmware version 36

G

- getting help 30
- graphic equalizer 26

H

- Help page (web) 30
- HID audio controls 20

high-pass filter adjustment (microphones) 25
hostname 17

I

importing a configuration 28
inactive sessions (web interface) 15
indicator lights 39
information, equipment location 18
initial device set-up 12-14
 using the Vaddio Device Controller 12
 using Vaddio Deployment Tool 13
installation 4
 mounting 4
IP address 13, 16-17
 changing to static 17
 configuring 16-17
 conflicts, preventing 16
 default 13, 16-17

L

locations of connectors 2
low-pass filter adjustment (microphones) 25

M

mic boost 25
microphones 21-22, 24, 32-33
 acoustic echo cancellation 24
 adjusting volume 21
 automatic gain control 24
 chairman override 24
 default settings 24
 filter adjustments 25
 muting 21, 33
 noise cancellation 24
 PEQ (parametric equalizer) 25
 powering 22
 speech lift adjustment 24
muting audio 21, 33
 microphones 21
 speakers 21

N

network configuration 16-17
 default 17
network configuration information
 (Telnet) 35
Networking page (web) 16-18
noise cancellation 24-25
NTP server 18

O

operating environment 41

P

page 15-18, 20-30
 Audio 21-27
 Diagnostics 30
 Help 30
 Networking 16-18
 Room Labels 18
 Security 15
 Streaming 20
 System 28-29
password 14
passwords 15
 changing 15
PEQ (parametric equalizer) 25
phantom power 22
ping command 36
power on/power off 10, 35
 camera 35
powering microphones 22
problems, solving 39
product capabilities 1

R

rebooting 29, 37
restoring a configuration 28
restoring default settings 37, 41
RJ-45 connectors, recommendation 3
room information, adding 18
Room Labels page (web) 18
routing audio 23, 34
RS-232 32, 35-36, 38
RS-232 adapter for Cisco products 10

S

saving a configuration 28
Security page (web) 15
serial command API 32, 35-36, 38
settings, default, restoring 37
software update 29
solving problems 39
speakers 21, 26, 32-33
 adjusting for differing speech volumes 26
 adjusting volume 21
 equalizer 26
 muting 21, 33

- synchronizing audio with video 26
- speech lift (microphone setting) 24
- static IP address 16-17
- storage environment 41
- storing a configuration 28
- Streaming page (web) 20
- streaming settings 20
- supported web browsers 11
- synchronizing audio with video 26
- System page (web) 28-29
- system time 18

- Room Labels page 18
- Security page 15
- Streaming page 20
- System page 28-29

T

- tablet 12
- technical support 30
- Telnet command help 38
- Telnet commands 32, 35-36, 38
- Telnet session 31, 38
 - ending 38
 - history 38
- temperature, operating and storage 41
- third-party control 32, 35-36, 38
- time zone 18
- troubleshooting 39
- typographical conventions for command reference 31

U

- updating firmware 29
- USB device name 20
- USB Record volume 21
- USB streaming 20

V

- Vaddio Deployment Tool 12-13
 - check for the latest version 12
 - initial device set-up 13
- Vaddio Device Controller 12
- version, firmware 36
- volume controls 21, 33

W

- web browsers supported 11
- web interface 12, 15-18, 20-30
 - accessing 12
 - Audio page 21-27
 - Diagnostics page 30
 - Help page 30
 - Networking page 16-18

Vaddio is a brand of Legrand AV Inc. · www.legrandav.com · Phone 800.572.2011 / +1.763.971.4400 · Fax +1.763.971.4464 · Email av.vaddio.support@legrand.com ·

Vaddio is a registered trademark of Legrand AV Inc. All other brand names or marks are used for identification purposes and are trademarks of their respective owners. All patents are protected under existing designations. Other patents pending.

©2022 Legrand AV Inc.

VADDIO®

A brand of  **legrand**®