



## Integrator's Complete Guide to the **RoboTRAK Presenter Tracking System**

Document 342-1229 Rev. E

November 2016

# Contents

What's in this Guide .....	1
Overview .....	1
Features .....	1
IR Camera .....	1
IR Source Lanyard .....	1
Unpacking the System .....	2
North America .....	3
Europe and UK .....	3
Australia and New Zealand .....	4
A Quick Look at the RoboTRAK System .....	5
Front of the IR Camera .....	5
Status Indications .....	5
Connectors .....	6
Lanyard .....	6
Before You Start .....	7
Network Requirements .....	7
Additional Equipment .....	7
Lighting and IR .....	7
Camera Location .....	9
Camera Placement – Small Room .....	9
Camera Placement – Medium Room .....	10
Camera Placement – Large Room .....	11
Installation .....	12
Don't Void Your Warranty! .....	12
Cabling Notes .....	12
The IR Camera's Default Hostname .....	13
Before You Install the Camera .....	13
Placing the PoE Splitter .....	14
Installing the Camera Mount .....	15
Wall Installation .....	15
Ceiling Installation .....	15
Basic Connection Diagram .....	16
Connections for Configuring the System .....	16
Installing the Cameras .....	17
Preparing the Tracking Lanyard for Use .....	17
Powering Up the Cameras .....	17
Configuring the Tracking System .....	18
Establishing Communication Between the Cameras .....	18
Accessing the IR Camera's Web Interface .....	18
Loading the Room Configuration File .....	20

Accessing the Video Camera's Web Interface .....	21
Assigning Hostnames or IP Addresses to the Cameras .....	22
Configuring the Video Camera .....	23
Pairing the Cameras .....	24
Setting the Video Camera's Standby Behavior .....	24
Setting up the IR and Video Camera Lanyard Shots .....	25
Viewing the Stream from the IR Camera .....	25
Storing the IR Camera's Lanyard Shot .....	26
Storing the Video Camera's Lanyard Shot .....	28
Testing and Fine-Tuning .....	30
Tuning Cheat Sheet .....	31
Setting the IR Camera's Home Position .....	32
Setting the Lanyard Searching Behaviors .....	33
Setting the Presenter Area and Search Area .....	34
Adjusting AGC Gain .....	36
Setting the Tracking Speed: Speed Scaler .....	37
Setting IR Camera Responsiveness: Tracking Sensitivity .....	38
Adjusting the Video Camera Window Width .....	39
Dealing with Stray IR .....	40
Configuring the Video Camera .....	42
Exporting the Configuration .....	43
Web Interface Cheat Sheet .....	44
System Administration .....	45
Security Settings .....	45
Setting the Room Label Information .....	46
Specifying Time Zone and NTP Server .....	46
Pan-Tilt Reset, Reboot, and Factory Reset .....	47
Reset the Pan and Tilt Motors .....	47
Reboot the Camera .....	47
Restore Factory Settings .....	47
Downloading and Installing Firmware Updates .....	48
Getting Help .....	49
Presenting with the RoboTRAK System .....	49
How It Works .....	50
Tips for Great Presentations .....	50
Starting Your Presentation .....	50
Switching Between Tracking and Camera Presets .....	50
How the Cameras Behave .....	51
Tips for Handling and Storing the Lanyard .....	51
Telnet Serial Command API .....	52
About Controlling the Video Camera via Telnet .....	52

Commands to Avoid .....	52
camera master tracking .....	53
camera master recalibrate .....	53
camera master standby .....	53
camera master standby config peripheral .....	54
camera master ccu .....	54
camera slave1 preset recall .....	55
network ping .....	55
network settings get .....	55
streaming settings .....	56
system reboot .....	56
system factory-reset .....	57
sleep .....	57
help .....	58
history .....	58
version .....	59
exit .....	59
Troubleshooting and Care .....	60
Status Indications .....	60
Fault Isolation .....	60
Operation, Storage, and Care .....	61
Specifications .....	62
Compliance Statements and Declarations of Conformity .....	63
FCC Part 15 Compliance .....	63
ICES-003 Compliance .....	63
European Compliance .....	64
Warranty Information .....	65
Index .....	66

## What's in this Guide

This guide provides information on the following topics:

- Unpacking and installing RoboTRAK cameras
- The camera's physical features and switch settings
- Controlling the camera using the IR remote or web interface
- Controlling the camera using Telnet or RS-232 commands
- Specifications
- Troubleshooting and maintenance
- Warranty and compliance/conformity information

For your convenience, this information is also available in smaller, limited-purpose manuals:

- **Installation Guide for the RoboTRAK Presenter Tracking System** (unpacking, physical features, switch settings, installation, initial power-up)
- **Configuration and Administration Guide for the RoboTRAK Presenter Tracking System** (physical features, controlling the camera, troubleshooting, and specifications)

Download manuals, dimensional drawings, and other information from [www.vaddio.com/support](http://www.vaddio.com/support).

## Overview

This guide covers the RoboTRAK presenter tracking system with IR camera:

- RoboTRAK, North America – 999-7270-000
- RoboTRAK, Europe and UK – 999-7270-001
- RoboTRAK, Australia and New Zealand – 999-7270-009

This system requires a video camera, which is sold and documented separately. The RoboTRAK system works with RoboSHOT™ series cameras. Refer to the video camera's documentation for information on how to connect and configure it.



## Features

- IR-based presenter tracking for medium to large rooms
- Designed for educators, in consultation with educators, using Vaddio's proven, industry-leading technology
- Reliable tracking: Move around, turn your head, invite others to the front of the room... the camera stays on you
- Switch between tracking and preset positions
- Camera sold separately – use with the RoboSHOT™ camera of your choice

## IR Camera

- Simple configuration and administration using the Vaddio web interface
- Adjust the system's tracking behavior to match the presenter's style
- Operational range of 12 to 50 ft (3.7 to 15.2 m), any height from 6 to 15 ft. (1.8 to 4.6 m)

## IR Source Lanyard

- No belt pack – comfortable, highly wearable design that does not interfere with clothing
- Up to 40 hours of battery power; 25 hours typical
- Recessed switch for full power-down – Conserve battery life during storage; no risk of accidental actuation

## Unpacking the System

Make sure you received all the items you expected.

Vaddio recommends purchasing a second lanyard as a spare or for smooth transitions between multiple presenters.

**Note**

*In addition to the items listed here, you will need a video camera. Any RoboSHOT series camera can be used.*

*If remote viewing is desired, you must use a video camera that is capable of streaming. These include RoboSHOT 10 USB, RoboSHOT HD-SDI, and RoboSHOT 20 UHD cameras.*



**Caution**

*Always support the camera's base when picking it up. Lifting the camera by its head or mounting arm will damage it.*

**Note**

*Copy the default hostname from the label on the bottom of the camera, and keep this information in a place where it will be available to anyone who needs to work with the camera's web interface. This information is required to access the camera for initial configuration, or after a factory reset.*

## North America

Part number 999-7270-000, RoboTRAK

- Vaddio RoboTRAK IR camera
- PoE+ power injector
- AC cord set for North America
- PoE splitter
- Power cable, 1 ft (30 cm)
- Cat-5e cable, 1 ft (30 cm)
- Cat-5e cable, 10 ft (3 m)
- Wall mount with mounting hardware
- IR lanyard
- USB charger
- USB charger cable
- Ferrite bead
- Quick Start Guide



Part number 999-7271-000, additional lanyard kit (optional, purchased separately):

- Lanyard
- USB charger
- USB charger cable
- Ferrite bead

## Europe and UK

Part number 999-7270-001, RoboTRAK

- Vaddio RoboTRAK IR camera
- PoE+ power injector
- AC cord sets for Europe and UK
- PoE splitter
- Power cable, 1 ft (30 cm)
- Cat-5e cable, 1 ft (30 cm)
- Cat-5e cable, 10 ft (3 m)
- Wall mount with mounting hardware
- IR lanyard
- USB charger
- USB charger cable
- Ferrite bead
- Quick Start Guide



Part number 999-7271-001, additional lanyard kit (optional, purchased separately):

- Lanyard
- USB charger
- USB charger cable
- Ferrite bead

## Australia and New Zealand

Part number 999-7270-009, RoboTRAK in silver and black

- VaddioRoboTRAK IR camera
- PoE+ power injector
- AC cord set for Australia and New Zealand
- PoE splitter
- Power cable, 1 ft (30 cm)
- Cat-5e cable, 1 ft (30 cm)
- Cat-5e cable, 10 ft (3 m)
- Wall mount with mounting hardware
- IR lanyard
- USB charger
- USB charger cable
- Ferrite bead
- Quick Start Guide



Part number 999-7271-009, additional lanyard kit (optional, purchased separately):

- Lanyard
- USB charger
- USB charger cable
- Ferrite bead



## A Quick Look at the RoboTRAK System

This section covers the physical features of the RoboTRAK system:

- IR camera
- Tracking Lanyard

The RoboTRAK system requires a video camera as well. You can use any Vaddio RoboSHOT camera as the video component of the system.

### **Note**

*If remote viewing is desired, you must use a video camera that is capable of streaming. These include RoboSHOT 10 USB, RoboSHOT HD-SDI, and RoboSHOT 20 UHD cameras.*

Refer to the documentation for your RoboSHOT camera for detailed information on connections and camera control.

## Front of the IR Camera



- **Camera assembly** – based on the same reliable hardware as our latest generation of video cameras.
- **Reflective lens** – reduces interference from spurious IR sources. The reflective lens also provides a simple visual cue that it's not a standard video camera.
- **Indicator light** – shows the IR camera's current status.

## Status Indications

In normal use, the RoboTRAK IR camera's status light will provide more useful information than the video camera's indicator light.

- Green – Tracking or waiting at the home position
- Blue – Not in tracking mode (may be at a video camera preset position)
- Blinking green – Searching for the lanyard
- Blinking blue – Not paired or not in contact with the video camera
- Purple – In standby mode or booting
- Blinking yellow – Executing a pan-tilt reset
- Yellow – Updating firmware

## Connectors

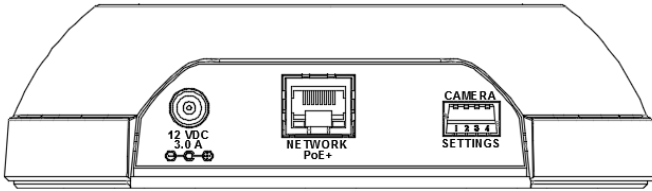

- **12 VDC, 3.0 Amp power connector** – Connect only the PoE splitter shipped with the camera.
- **Network/PoE+** – 10/100 Ethernet/PoE+ port allows the RoboTRAK™ IR camera to control the video camera, and provides access to the web interface.
- **DIP switches** – Factory use only.

## Lanyard

Vaddio recommends purchasing a second lanyard as a spare or for smooth transitions between multiple presenters.

**Medallion** – Houses charging and control circuitry, switches to standby (low-power) mode when the IR camera switches to standby.

- **Button** – On/off switch for IR sources
- **Illuminated ring** – Visual status indicator directs light toward the wearer, not the audience
- **Battery** – Rechargeable Li-ion battery; up to 25 hour battery life, roughly 4 hour charging time
- **USB micro-B charging port** – Connect the supplied battery charger
- **Recessed power switch** – Allows you to turn off the lanyard completely to extend battery life



**Ribbon** – Holds the medallion and contains the IR sources.

- **Strand of IR LEDs** – Provide a characteristic image pattern that the camera identifies and tracks
- **Safety clasp** – Automatically releases under tension

### Caution

*Do not pinch, crease, or stretch the lanyard ribbon. Do not pull the lanyard ribbon to release the clasp. Any of these will damage the circuitry in the ribbon.*

## Before You Start

Ensure that the room is suitable for the RoboTRAK system, and that all the required elements of the installation are present. This section covers the requirements for a successful installation.

### Note

*Copy the default hostname from the label on the bottom of the camera, and keep this information in a place where it will be available to anyone who needs to work with the camera's web interface. This information is required to access the camera for initial configuration, or after a factory reset.*

## Network Requirements

- Network connections for both cameras
- Hostname resolution

## Additional Equipment

Side-by-side displays – The team or individual tuning the RoboTRAK system will need to see the IP stream from the IR camera and the live video feed from the video camera at the same time. The display for the IR camera is not needed after the system is configured and fine-tuned.

Tablet or other device with wifi access – If you do not have an assistant for the tuning process, you will need to be able to work with the RoboTRAK IR camera's web interface while moving around the room.

## Lighting and IR

### Note

*The RoboTRAK IR camera works best in an IR-sterile environment. Natural lighting and halogen lamps produce enough stray IR to overwhelm the system.*

- If the room has windows, blackout curtains or blinds are required - standard window blinds admit enough IR at the edges to keep the IR camera from identifying the tracking lanyard.
- Fluorescent or LED lighting is preferred.



This is a shot from the IR stream of a RoboTRAK camera in an IR-sterile room. Other than the presenter's lanyard, the room is dark. This is what you should see when you view the stream from the IR camera. (If the camera is not in setup mode, the image will not include the white rectangle.)

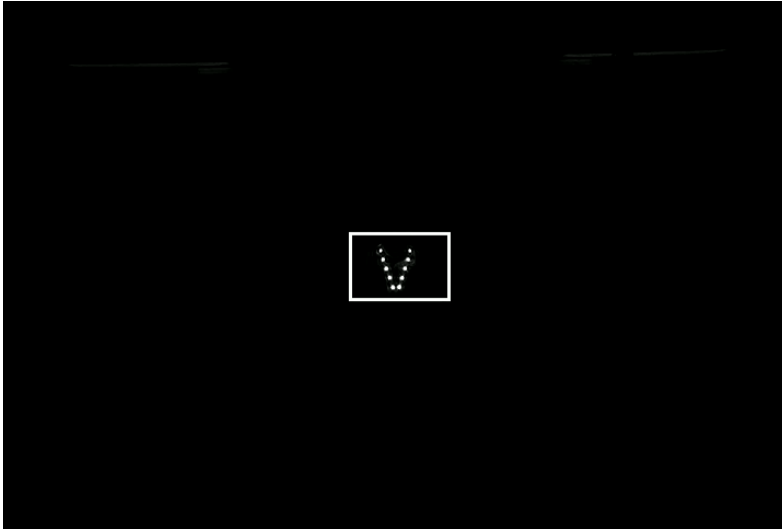

In the photograph below, the two displays both show virtually the same shot from the RoboTRAK IR camera as shown in the previous photograph, but in a different room. The window shades are closed and the room looks dark - but the IR image shows that the whole room is flooded with IR, and the lanyard does not emit enough IR to be detected.

This room requires IR remediation.



Certain types of room systems also emit IR, and can keep the tracking system from working properly:

- Assisted listening systems
- IR-based audio systems
- Room occupancy sensors

Turning any of these off may not be an option. In such cases, cover or remove reflective objects if possible. IR reflects the same way as visible light – an object that looks shiny to you also looks shiny to the IR camera.



Contact the Vaddio Applications Engineering team ([appse@vaddio.com](mailto:appse@vaddio.com)) for help with stray IR mitigation.

## Camera Location

Siting requirements for the IR camera are similar to those for the video camera you use with it.

- Clear line of sight to the desired viewable area
- Acceptable camera distance 12 to 50 ft (3.7 to 15.2 m) from area of interest; best performance at 20 to 35 ft (6.1 to 10.7 m) from area of interest
- Height 7 to 15 ft (2.1 to 4.6 m) depending on distance
- Viewing angle as close as possible to the centerline of the tracking area

## Camera Placement – Small Room

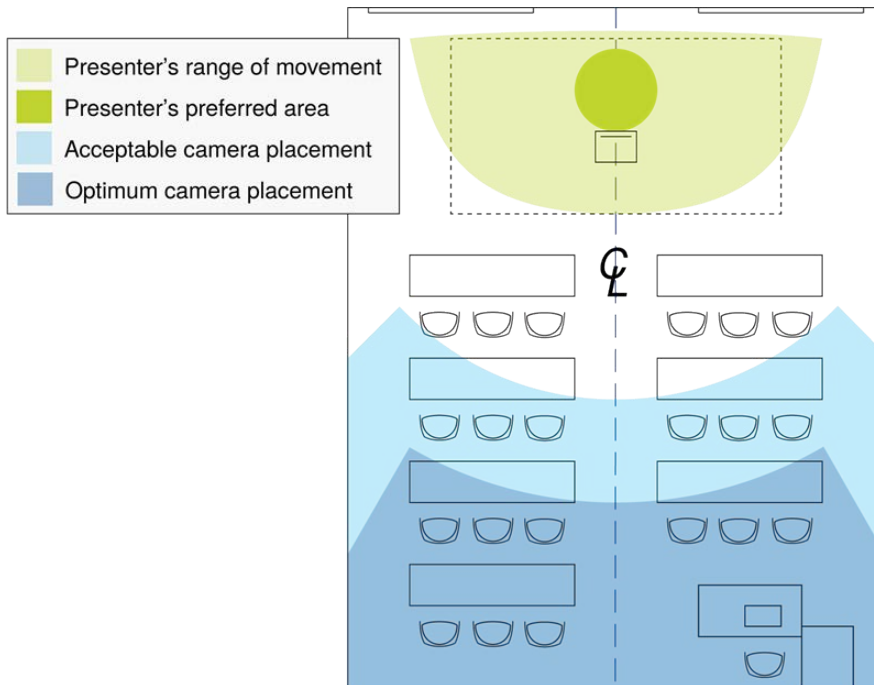

## Camera Placement – Medium Room

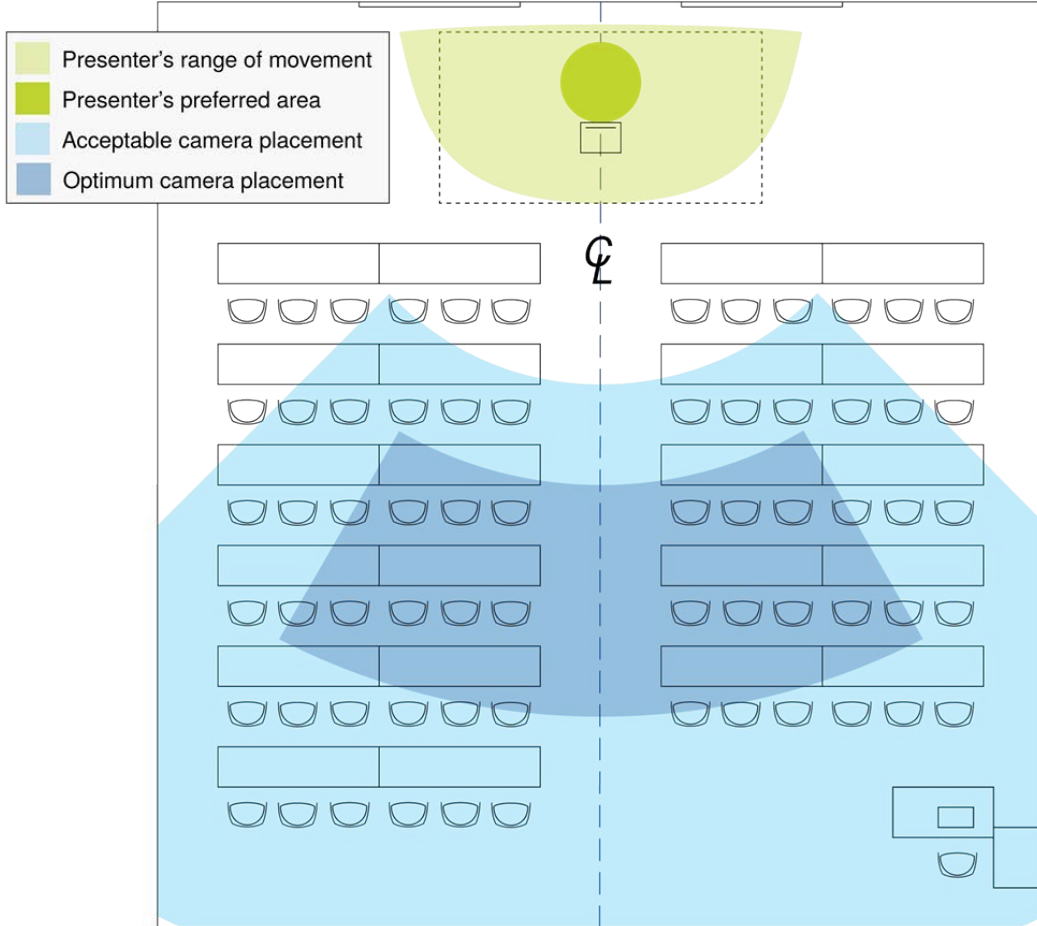

## Camera Placement – Large Room

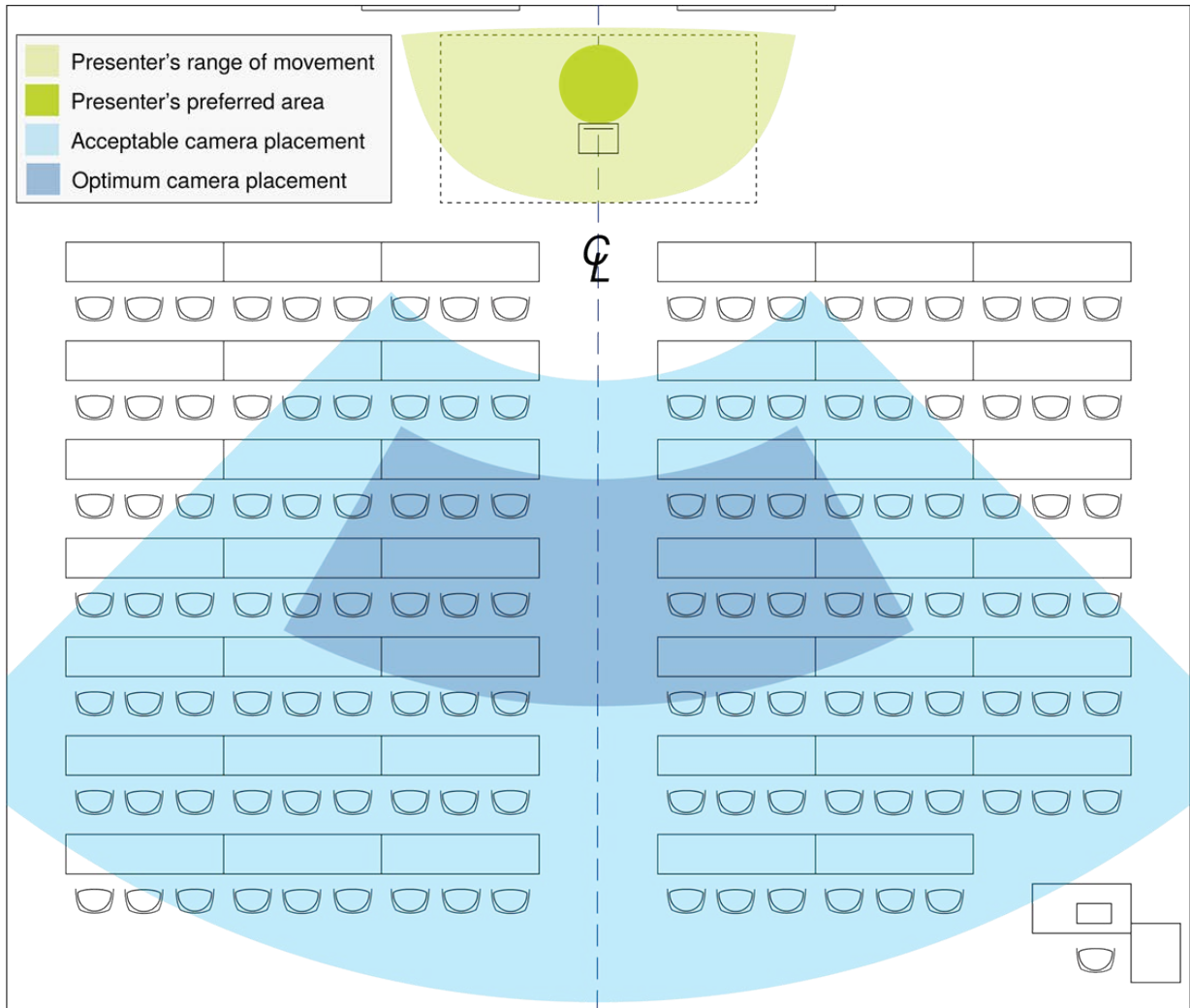

## Installation

This section covers selecting the camera location, installing the mount, and connecting the camera.

### Don't Void Your Warranty!

#### **Caution**

*This product is for indoor use. Do not install it outdoors or in a humid environment without the appropriate protective enclosure. Do not allow it to come into contact with any liquid.*

*Use only the power supply included with this product. Using a different one will void the warranty, and could create unsafe operating conditions or damage the product.*

*Do not install or operate this product if it has been dropped, damaged, or exposed to liquids. If any of these things happen, return it to Vaddio for safety and functional testing.*

### Cabling Notes

Use Cat-5e or better cable and standard RJ-45 connectors (568B termination). We recommend using high-quality connectors and a high-quality crimping tool.

#### **Note**

*Do not use pass-through RJ-45 connectors. These can cause intermittent connections and degraded signal quality, resulting in problems that may be hard to diagnose. Use standard RJ-45 connectors.*



#### **Caution**

*Check Cat-5 cables for continuity before using them. Using the wrong pin-out may damage the camera system and void the warranty.*



#### **Pro Tip**

*To prevent tragic mishaps, label both ends of every cable.*



## The IR Camera's Default Hostname

### **Note**

*Copy the default hostname from the label on the bottom of the camera, and keep this information in a place where it will be available to anyone who needs to work with the camera's web interface. This information is required to access the camera for initial configuration, or after a factory reset.*

Be sure to record the default hostname exactly as it is shown on the label.

The RoboTRAK IR camera can only be configured via its web interface. Ensure that the team or individual configuring the RoboTRAK system has the IR camera's default hostname.

## Before You Install the Camera

The RoboTRAK presenter tracking system includes a dual wall mount which can be used with Vaddio's Offset Drop-down Ceiling Mount for RoboTRAK, part number 535-2000-045. Contact us if you don't have the camera mount you need.

### **Note**

*Install the cameras with the IR camera directly above the video camera. Other physical orientations are not supported, as they pose tuning/configuration challenges.*

- Choose a camera mounting location that will optimize camera performance. Consider camera viewing angles, lighting conditions, line-of-sight obstructions, and in-wall obstructions where the camera is to be mounted.
- Ensure that the camera body can move freely and will point away from the ceiling and lights.
- Follow the installation instructions included with the camera mount.

## Placing the PoE Splitter

Both connections to the IR camera are from the PoE splitter.

1. Remove the backing from one side of the rectangle of 3M<sup>®</sup> Dual Lock<sup>™</sup> material to expose the adhesive, and press it firmly against the back of the PoE splitter.
2. Connect the long Cat-5e cable to the Power & Data connector on the PoE splitter.
3. Connect the short Cat-5e cable to the Data Out connector on the PoE splitter.
4. On the short power cable, identify the connector with no center pin and connect it to the PoE splitter.

### **Caution**

*The connectors on the short power cable are NOT identical. One has a center pin. Attempting to connect the wrong end of the cable to the PoE splitter will damage the connector. (We did this in the lab, and we're admitting it so you can avoid our mistake.)*

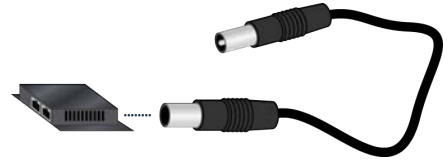

5. Holding the PoE splitter under the top shelf of the camera mount, route the two short cables through the cable opening for the upper camera.
6. Determine the best position for the PoE splitter, then remove the backing from the exposed side of the 3M Dual Lock material and press the PoE splitter into place within the camera mounting shelf.



## Installing the Camera Mount

The dual camera mount can be attached to a wall, or mounted to the ceiling.

### Wall Installation

#### **Note**

You can install the camera mount to a 2-gang wall box or directly to the drywall. If you install the wall mount on drywall, use the wall anchors provided with the wall mount. If you install it over a wall box, use the cover plate screws supplied with the wall box.

1. Route cables through the appropriate cable opening in the mount.
2. Attach the mount to the wall, using wall anchors if not attaching it to a wall box.
3. Level the mount and tighten the mounting screws.
4. Check the level again.

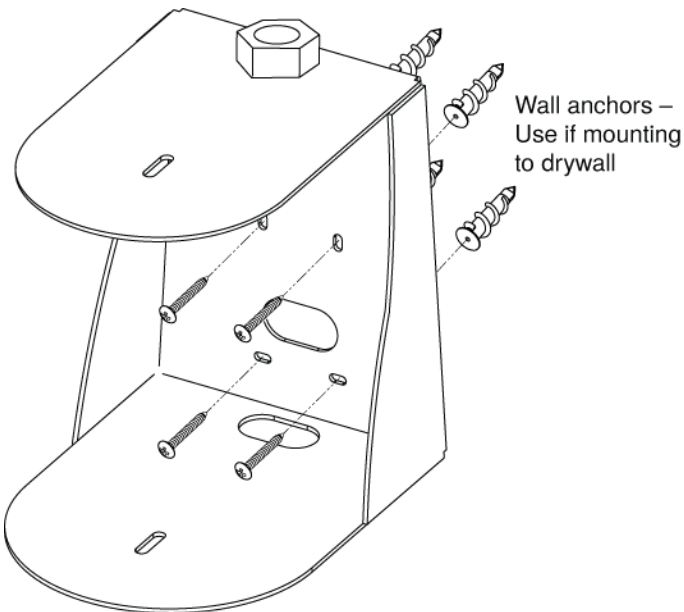

### Ceiling Installation

For a ceiling installation, you will need Vaddio's Offset Drop-down Ceiling Mount for RoboTRAK, part number 535-2000-045.

Vaddio does not recommend using a non-offset ceiling mount pole, as the system's center of mass is significantly forward of the 1" NPT threaded nut. Contact Vaddio if you don't have a suitable ceiling mount kit.

1. Install the ceiling mount kit according to the instructions provided with it.
2. At the appropriate step, route the cables for both cameras through the pipe.
3. At the appropriate step, attach the dual camera mount to the end of the threaded pipe.

#### **Note**

*Inverted operation is not supported.*

## Basic Connection Diagram

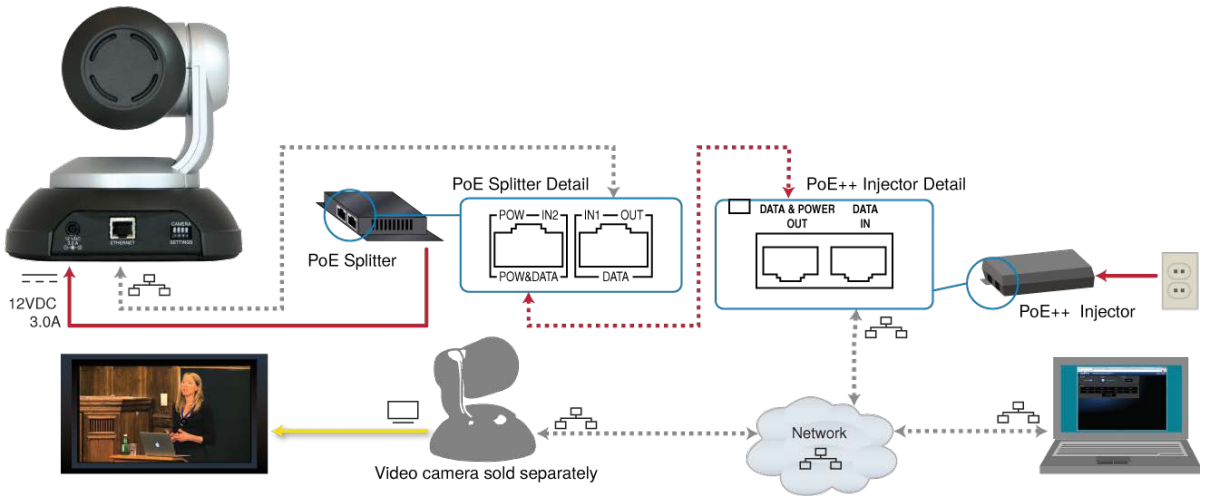

## Connections for Configuring the System

To configure the system for the room and set up the desired tracking behavior, you will need to view the IP stream from the IR camera. Side-by-side displays of the IR camera stream and the video camera output are strongly recommended.

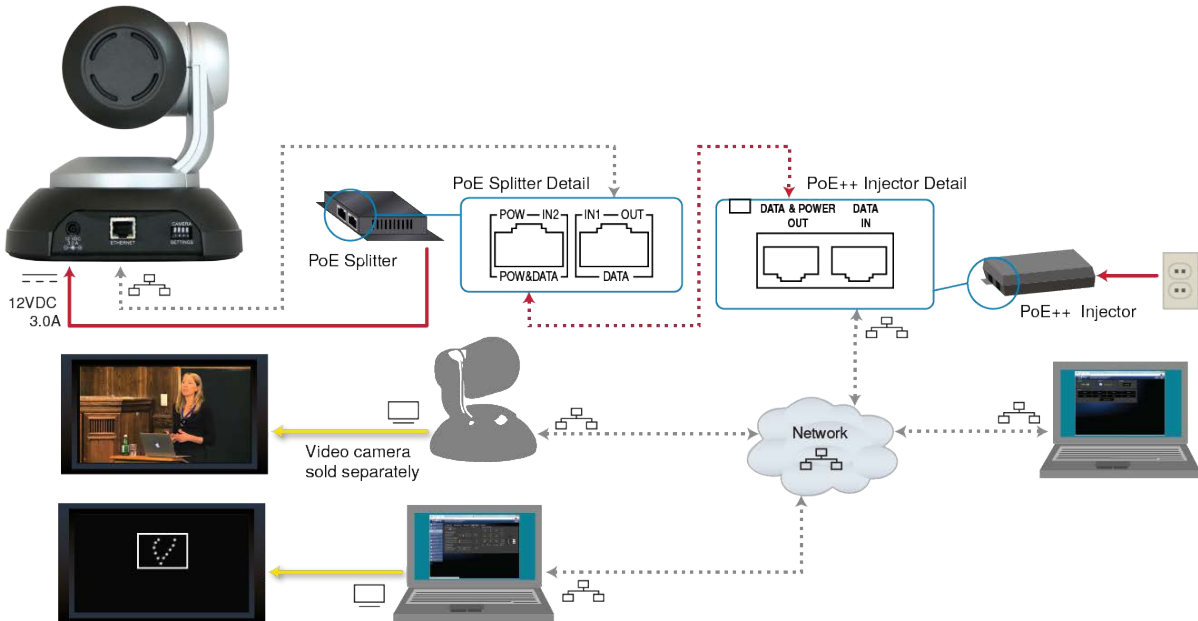

## Installing the Cameras

### Caution

Before you start, be sure you can identify all cables correctly. Connecting a cable to the wrong port can result in equipment damage.

### Caution

Check Cat-5 cables for continuity before using them. Using the wrong pin-out may damage the camera system and void the warranty.

1. Connect the cables from the PoE splitter to the IR camera.
2. Place the camera on the upper shelf of the mount.
3. Attach the camera to the mount using the ¼"-20 x .375 mounting screw supplied with the camera.
4. Ensure that the video camera's resolution switch the DIP switches are set appropriately. Refer to the video camera's manual for this information.
5. Connect the cables to the video camera.
6. Place the video camera on the lower shelf of the mount.
7. Attach the camera to the mount using the ¼"-20 x .375 mounting screw supplied with the camera.

## Preparing the Tracking Lanyard for Use

You will need all the items from the box that the lanyard was shipped in:

- Lanyard
- USB charger
- USB charging cable
- Ferrite bead

1. Snap the ferrite bead onto the charger cable about 2 inches (5 cm) from the connector that plugs into the lanyard.

### Note:

To ensure compliance with FCC regulations, you must install the ferrite bead as directed.

2. Make sure the recessed power switch is in the ON position.
3. Plug the charger into a power source, and connect the charger cable.
4. Plug the charger cable into the lanyard.
5. Leave the lanyard connected to the charger until the medallion blinks only occasionally. Charging may take several hours.



## Powering Up the Cameras

Connect camera power.

The cameras will wake up and initialize. This will take a few seconds. When the cameras are ready to accept control information, their front indicators are blue. At this point, the system is ready to configure.

## Configuring the Tracking System

Phases of the configuration process include:

- Establishing communication between the cameras
- Setting up the lanyard shots for both cameras
- Testing the basic set-up
- Fine-tuning the system

Most of these phases include several tasks.

You will need:

- An assistant to wear the lanyard and move around the room as a presenter would do, or a tablet and wi-fi access so that you can do this while tuning the system.
- Equipment to view the IP streams from both cameras
- A stream viewer application such as VideoLAN VLC Media Player – set caching time to 300 ms for best results when tuning the system.

Before you start, be sure the lanyard is fully charged and the ring glows blue to indicate it is powered up.

## Establishing Communication Between the Cameras

This phase of RoboTRAK configuration includes:

- Accessing the RoboTRAK IR camera's web interface
- Accessing the video camera's web interface
- Assigning camera hostnames (optional)
- Pairing the cameras

## Accessing the IR Camera's Web Interface

This product is compatible with the current versions of these web browsers:

- Chrome®
- Firefox®
- Microsoft® Internet Explorer®
- Safari®
- Microsoft® Edge

Older versions of these browsers are likely to work, and other browsers may also work.

If the RoboTRAK IR camera has not already been assigned a hostname or IP address, you will need to know its default hostname. This information is on a label on the camera's base, and should be copied before the camera is installed on the camera mount.

If the RoboTRAK system is not installed on a network that is capable of hostname resolution, you will need to assign static IP addresses to both the IR camera and the video camera. See [Assigning Hostnames or IP addresses to Cameras](#).

Default IP addresses for the cameras are:

- IR camera: 169.254.1.2
- RoboSHOT series video camera: 169.254.1.1

**To access the IR camera's web interface:**

1. Open a new browser tab or window. In the address bar, enter the RoboTRAK IR camera's hostname or IP address.

If you are doing the initial setup and configuration, use the default hostname. Enter

`http://` followed by the RoboTRAK camera's default hostname  
(for example, `http://vaddio-robotrak-00-1E-C0-90-E5-6F`)

to open the web interface. The guest view of the Room UI page opens.

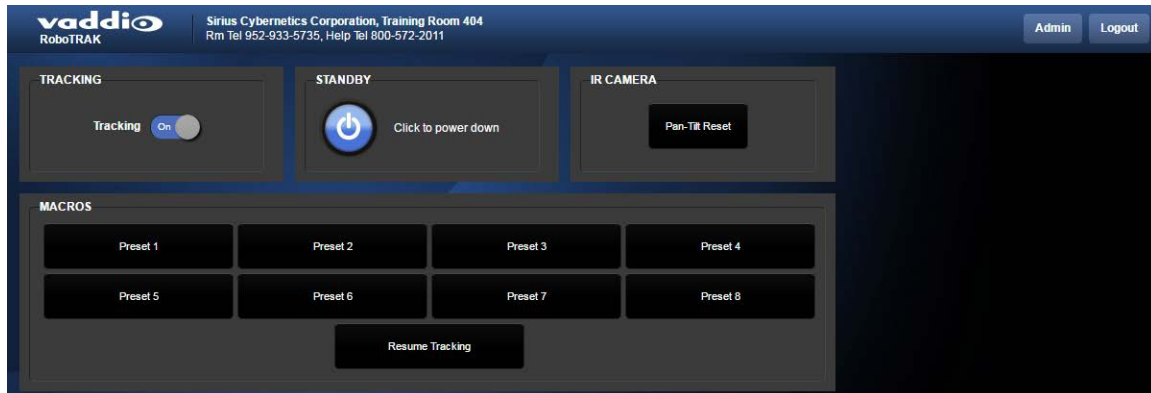

2. Select Admin, and log in. The default password is `password`.

## Loading the Room Configuration File

### SYSTEM PAGE

Do this before you do any set-up or configuration. Loading a configuration will overwrite any configuration changes you have already made.

Vaddio provides RoboTRAK room configuration files for common room sizes and layouts.

1. On the [vaddio.com](http://vaddio.com) website, search for RoboTRAK, and go to the main RoboTRAK product page.
2. On the Drawings and Manuals tab, locate the room configuration files. Select the link to download the file that best matches the room you are setting up.
3. Go to the System page. Under System Utilities, select Import Data and browse to the configuration file you downloaded. The filename ends in `.dat`.

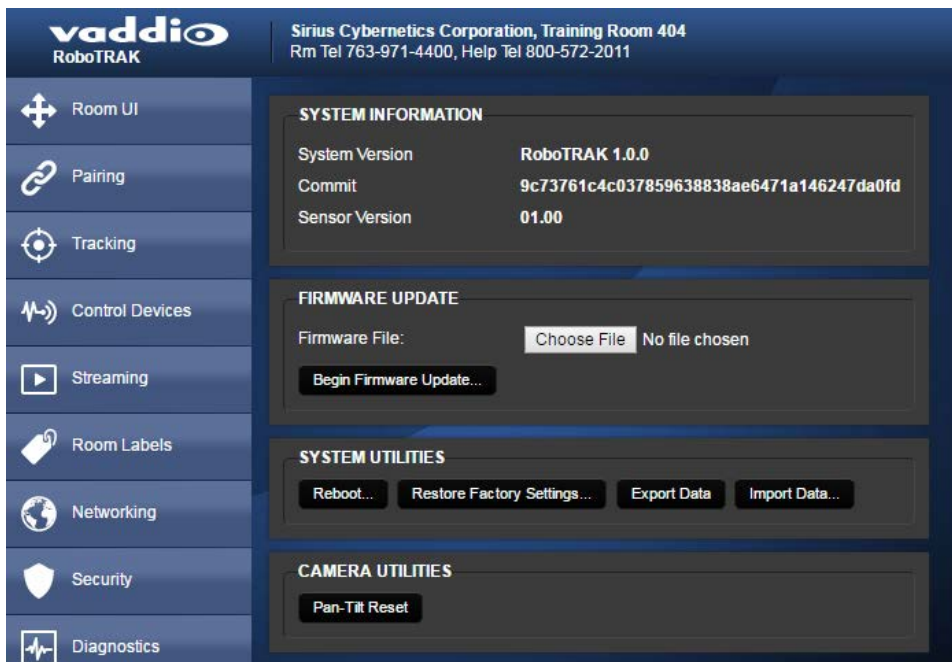

4. Confirm that you want to import the data.
5. Log in again after the camera finishes importing the data and reboots.



## Accessing the Video Camera's Web Interface

You can use the same computer or mobile device that you use to access the IR camera's web interface.

### Note

If you know the video camera's hostname, you can use it in place of the IP address to access the camera's web interface.

### To access the video camera's web interface before it is paired to the IR camera:

1. Ensure that the camera's video output is visible on the display.
2. Press and hold the Data Screen button on the remote. After 3 seconds, the room display presents the information.
3. Open a new browser tab or window and enter `http://` followed by the video camera's IP address in the address bar (for example, `http://10.30.200.74`) to open its web interface. The guest view of the Camera Controls page opens.

### Note

The camera's web interface may differ from the illustration here.



4. Select Admin, and log in. The default password is `password`.

### To access the video camera's web interface after it is paired to the IR camera:

On the Pairing page, follow the Device Web Page link.

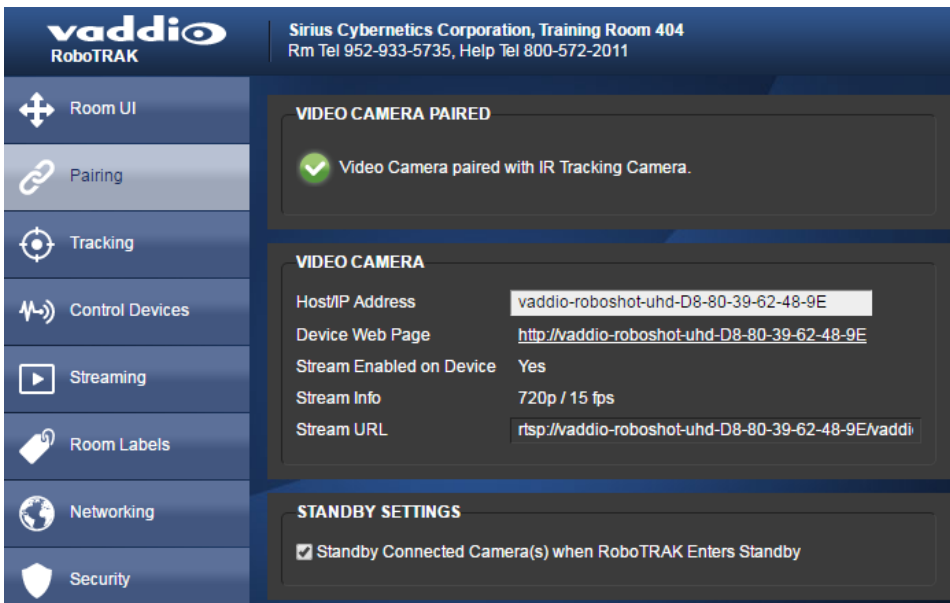

## Assigning Hostnames or IP Addresses to the Cameras

### NETWORKING PAGE

In a network that supports hostname resolution, you can assign a hostname that conforms to the organization's network policies. Note that the hostname reverts to the default if a factory reset is done. Assigning a hostname is optional; you can continue to use the cameras' default hostnames.

If the network does not support hostname resolution, assign static IP addresses to both cameras to ensure that after they are paired, they remain paired.

#### Note

If you change hostnames or IP addresses after the cameras have been paired, you will need to update the camera information on the Pairing page. See [Pairing the Cameras](#).

#### To assign a new hostname:

This is an optional configuration task. Vaddio recommends using the video camera's hostname rather than its IP address to identify it to the RoboTRAK IR camera, so that the cameras remain paired even if IP addresses change.

Work with the IT staff to define camera hostnames that conform to network policies.

The procedure for assigning a hostname is the same on both cameras:

1. Go to the Networking page of the web interface.
2. Replace the current hostname with the new hostname.
3. Save the change.

This will end your session. Log in again to continue configuring the system.

The screenshot displays the Vaddio RoboTRAK web interface. The top header includes the Vaddio logo and contact information for Sirius Cybernetics Corporation. A left-hand navigation menu lists various system functions, with 'Networking' currently selected. The main interface area is split into two panels. The upper panel, 'DATE & TIME SETTINGS', allows for adjusting the device's system time, NTP settings, and time zone. The lower panel, 'NETWORK CONFIGURATION', is the focus, showing the 'Hostname' field populated with 'vaddio-robotrak-00-1E-C0-90-E4-A9'. Below the hostname, the 'NETWORK INTERFACES' section is expanded to show 'Ethernet Port (eth0:WAN)' settings, where 'Static' IP addressing is selected. The static IP configuration shows a MAC address of 00:1E:C0:90:E4:A9, an IP address of 10.1.2.146, a subnet mask of 255.255.0.0, and a gateway of 10.1.255.254.

**To assign a static IP address:**

Work with the IT staff to determine the appropriate IP address, subnet mask, and gateway information.

The procedure for assigning a hostname is the same on both cameras:

1. Go to the Networking page of the web interface.
2. Under Network Interfaces, set the IP address to Static.
3. Enter the new IP address, subnet mask, and gateway.
4. Save the changes.

This will end your session. Log in again to continue configuring the system.

**Configuring the Video Camera**

You will need to configure the video camera as well as the IR camera. Configuration options vary somewhat, depending on the camera. Refer to the video camera's manual for configuration tasks. All manuals are available at [support.vaddio.com](http://support.vaddio.com). They are also available on the product pages of the Vaddio website.

Key tasks:

- Define position presets
- Enable IP streaming, if available

Video camera presets typically provide a tighter shot at a specific location – for example the presenter at the lectern, a close-up of a demonstration, or a wider static shot of the presentation area for multiple presenters.

Other common configuration tasks:

- Save custom color settings (CCU scenes)
- Define the room label information
- Set the time zone

You can access the video camera's web interface from the IR camera's Pairing page, using the Device Web Page link.

**vaddio**  
RoboTRAK

Sirius Cybernetics Corporation, Training Room 404  
Rm Tel 952-933-5735, Help Tel 800-572-2011

Room UI  
Pairing  
Tracking  
Control Devices  
Streaming  
Room Labels  
Networking  
Security

**VIDEO CAMERA PAIRED**

✓ Video Camera paired with IR Tracking Camera.

**VIDEO CAMERA**

Host/IP Address: vaddio-roboshot-uhd-D8-80-39-62-48-9E  
 Device Web Page: <http://vaddio-roboshot-uhd-D8-80-39-62-48-9E>  
 Stream Enabled on Device: Yes  
 Stream Info: 720p / 15 fps  
 Stream URL: rtsp://vaddio-roboshot-uhd-D8-80-39-62-48-9E/vaddi

**STANDBY SETTINGS**

Standby Connected Camera(s) when RoboTRAK Enters Standby

## Pairing the Cameras

### PAIRING PAGE

This is simplest if you access both cameras' web interfaces from the same computer or mobile device.

#### Notes

Load the configuration file of your choice before you pair the cameras.

If you plan to assign camera hostnames rather than using the default hostnames, assign them before pairing the cameras. See [Assigning Hostnames to the Cameras](#).

1. On the video camera's Networking page, select and copy the hostname.
2. On the IR camera's Pairing page, paste the video camera's hostname in the Host/IP Address box. A check mark and message confirm that the IR camera has recognized the video camera, and can now control it.

In this illustration, the default hostname is used

Now the cameras are ready for you to set up tracking.

## Setting the Video Camera's Standby Behavior

### PAIRING PAGE

By default, the video camera remains powered up when the IR camera goes to standby mode. Through the IR camera's web interface, the operator can switch between tracking and conventional video camera behavior using the Standby control.

If the video camera will only be used for tracking, check the Standby Connected Cameras box in the Standby Settings. This provides privacy by ensuring that the video camera does not continue to stream video when the IR camera is put into standby mode.

## Setting up the IR and Video Camera Lanyard Shots

This phase of RoboTRAK configuration includes:

- Loading the appropriate room/distance configuration
- Viewing the IP stream from the RoboTRAK IR camera
- Framing the IR camera's lanyard shot
- Framing the video camera's lanyard shot

For the framing tasks and subsequent tuning, someone will need to wear the lanyard and move around in the area where the presenter will normally be. In this manual, "the presenter" refers to anyone wearing a lanyard in range of the camera.

### Viewing the Stream from the IR Camera

You will need a stream viewer for this. Several stream viewing applications are available; some of us here at Vaddio like VLC Media Player, which is available free of charge.

1. On the Streaming page, locate the address for the IR camera's RTSP stream.

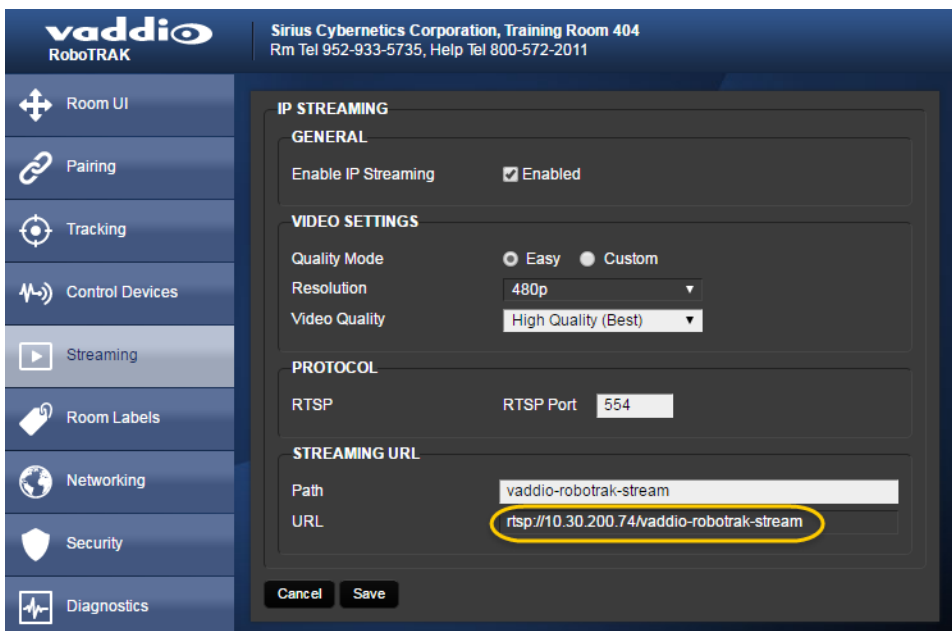

2. Open a stream viewer and point it to the streaming URL.

What you see depends on what you are doing in the web interface. It also depends on the room itself.

## Storing the IR Camera's Lanyard Shot

TRACKING PAGE, IR CAMERA SHOT TAB

This shot ensures that tracking is smooth and accurate.

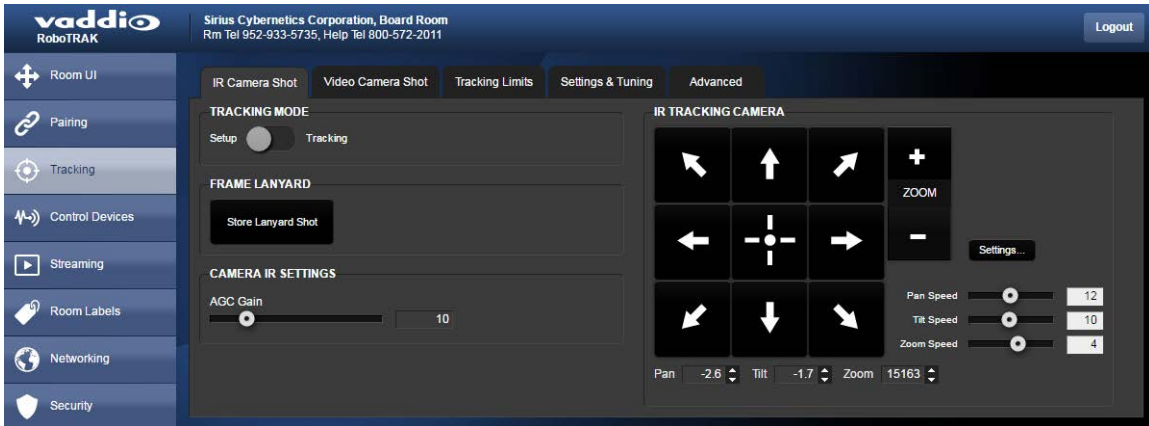

1. Select Setup mode. The IR stream shows a white rectangle outline at the center of the image. The lanyard also shows up if the camera is pointing at the presenter. (That's you, if you're the one wearing the lanyard).

**Fun Fact**

*If the presenter is in front of a reflective surface such as a display or dry-erase board that is mounted at a certain angle, the IR image may show a reflection of the IR sources near the lanyard's clasp. This can resemble glowing eyes.*

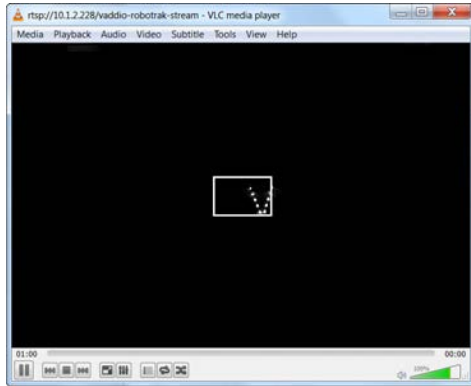

2. Have the presenter go to exactly where a presenter will normally be when the system is in use. If presenters are expected to move around a lot (for example, in a demonstration or lab setup), have the presenter go to a location about halfway between the nearest and farthest presenter distances from the camera.
3. Have the presenter face the camera directly.
4. On the IR Camera Shot tab of the Tracking page, use the arrow buttons to center the lanyard image side to side. This keeps the presenter centered in the video shot.
5. Use the zoom controls to adjust the shot so that the lanyard reaches the top and bottom edges of the framing rectangle without going outside the lines. This ensures smooth, reliable tracking. If the lanyard is too large in this shot, tracking is likely to be choppy. If it is too small, the IR camera may lose the lanyard entirely.

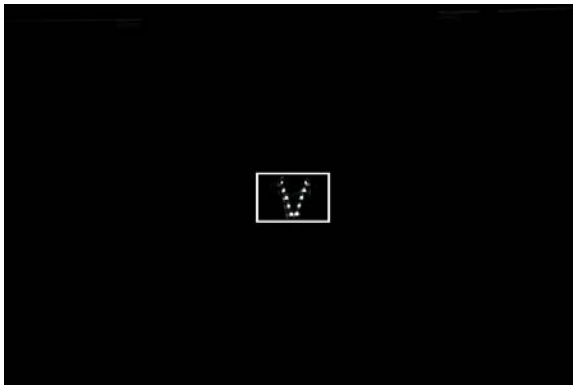

**Note**

*In large rooms, it may not be possible to zoom in far enough to frame the lanyard in this way. You may need to [increase the AGC gain](#) for reliable tracking.*

6. Select Store Lanyard Shot.

## Storing the Video Camera's Lanyard Shot

TRACKING PAGE, VIDEO CAMERA SHOT TAB

**Note**

You must [store the IR camera's lanyard shot](#) before you do this task.

The video camera does not zoom while tracking. The video lanyard shot ensures that the zoom level is appropriate and the presenter remains well-framed in the shot when approaching the camera.

The way you set up the shot depends on how presenters will use the room.

**Example 1: The presenter typically stays behind a podium or lectern**

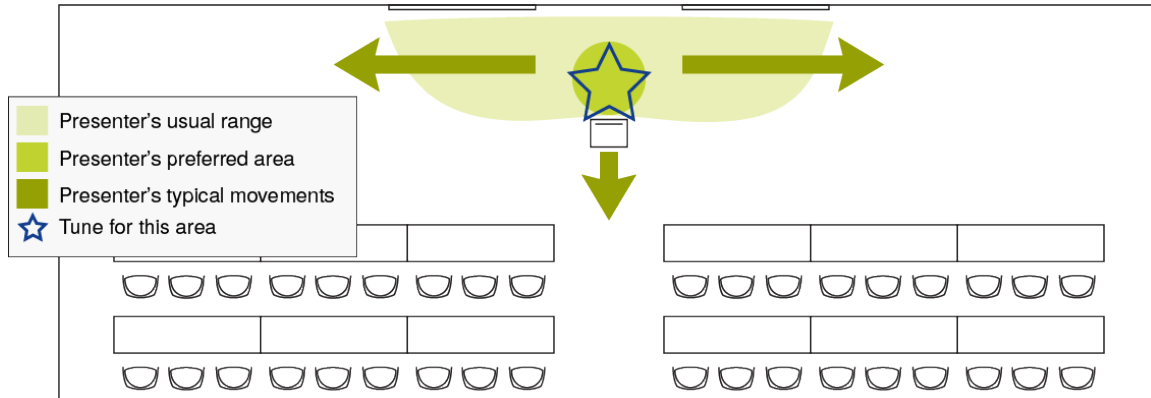

**Example 2: The presenter typically moves across the room and often approaches the audience**

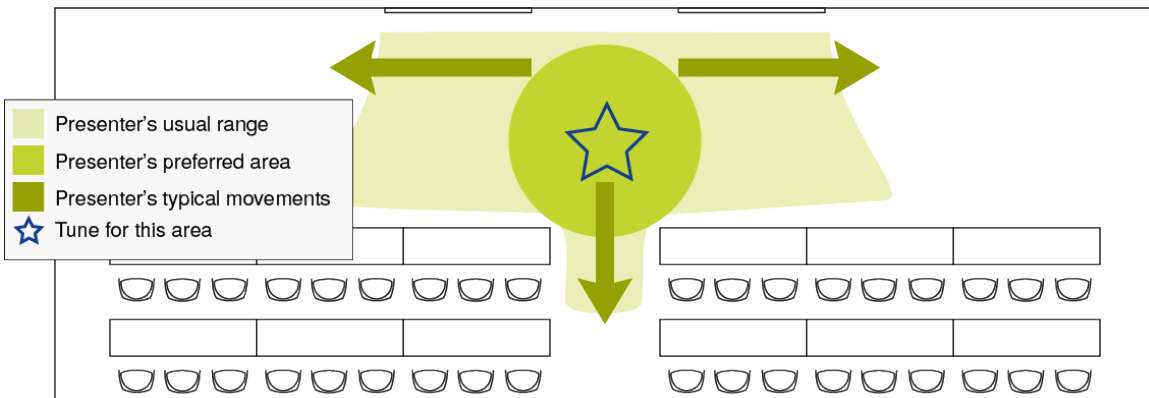

**Example 3: The presenter typically gives demonstrations that require moving around**

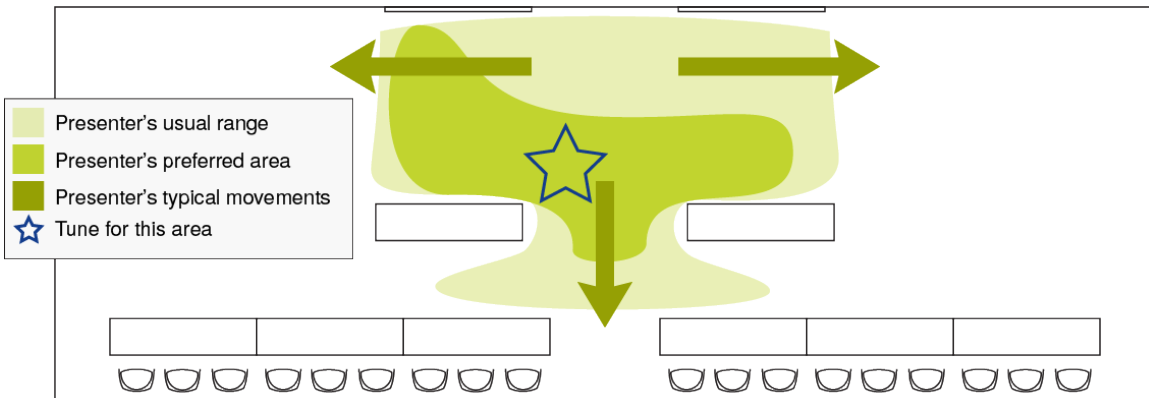



**To compose and store the video camera's lanyard shot:**

1. Change Tracking Mode to Setup if it is not already in setup mode.
2. Have the presenter go to exactly same place as for the IR lanyard shot.
3. Be sure the lanyard is perfectly framed in the IR image.
4. Using the arrow buttons and zoom controls on the Video Camera Shot tab of the Tracking page, compose the video shot:
  - o The presenter is centered in the shot
  - o The shot includes the presenter's knees
  - o The shot includes 12 inches (30 cm) or more of space above the presenter's head - the closer the presenter moves to the camera, the more "head space" is needed in the lanyard shot.
5. Select Store Lanyard Shot.

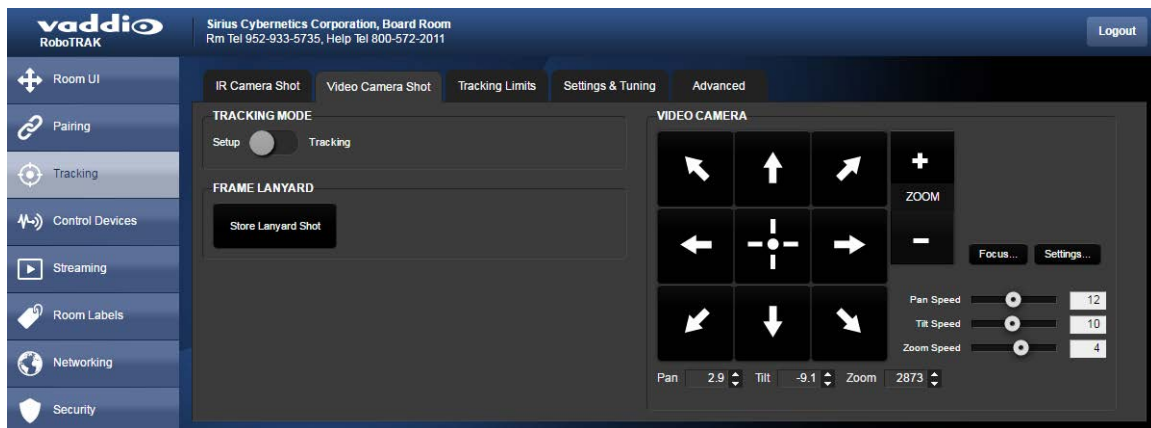

6. Change Tracking Mode to Tracking.
7. Test the shot by asking the presenter to move toward the cameras. At the nearest part of the presenter's area, the presenter's face and upper torso should still be in the frame.
8. If the presenter is not well-framed at the closest approach to the cameras, repeat steps 1 through 4, but compose a wider shot.
9. Test and recompose as needed, until the presenter is framed well at both the closest and most distant points in the presenter's area.

## Testing and Fine-Tuning

### TRACKING PAGE

Basic configuration and tuning – pairing the cameras and setting up the lanyard shots – is enough to make the system work. As the IR camera tracks the lanyard, the software drives the video camera based on the IR camera's motion. The tuning process tailors the system's response to the lanyard's motion.

#### To test the system:

On the Tracking page, set the IR camera to Tracking Mode. This control is available on all tabs of the Tracking page.

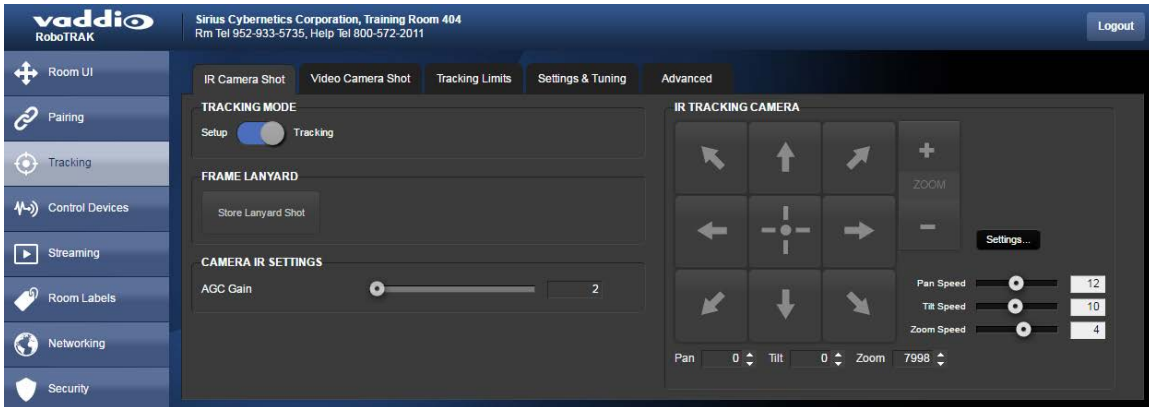

Ask the presenter to move around in the presentation area, and observe the video camera's tracking behavior. What needs improvement?

## Tuning Cheat Sheet

Many adjustments affect each other, so the tuning process may require some experimenting.

Tracking behavior	What it means	How to fix it
The presenter is consistently off-center, even when not moving.	The IR and video lanyard shots don't line up properly	Be sure that the lanyard is exactly centered in the white rectangle of the IR image as you store a new video camera lanyard shot. See <a href="#">Framing the Video Lanyard Shot</a> .
	The IR camera pan/tilt is out of calibration.	Reset the pan/tilt position. See <a href="#">Pan-Tilt Reset, Reboot, and Factory Reset</a> .
At the closest approach to the camera, part of the presenter's face is not in the frame.	The video camera's lanyard shot is too tight.	Store a new video camera lanyard shot, with more head space than the current one. See <a href="#">Storing the Video Camera's Lanyard Shot</a> .
The presenter consistently "outruns" the camera and moves out of the frame.	Video camera tracking speed is too slow.	Slightly increase the speed scalar for the video camera. See <a href="#">Setting the Tracking Speed</a> .
	The video window is too large.	Make the video window slightly smaller. See <a href="#">Adjusting the Video Window Width</a> .
	The presenter is too close to the cameras, and outruns the IR camera.	Store a new IR lanyard shot, with the IR camera zoomed out to size the lanyard appropriately. See <a href="#">Storing the IR Camera's Lanyard Shot</a> .
	IR tracking speed is too slow.	Slightly increase tracking sensitivity. See <a href="#">Setting IR Camera Responsiveness</a> .
The video camera constantly makes small adjustments during the presentation.	The video window is too small.	Make the video window slightly larger. See <a href="#">Adjusting the Video Window Width</a> .
Tracking is interrupted when the presenter turns away.	The IR camera does not detect enough IR to recognize the lanyard.	Be sure the back of the lanyard is not covered by the presenter's hair or clothing. <a href="#">Store a new IR lanyard shot</a> , zoomed in from the existing shot. <a href="#">Increase AGC gain</a> slightly.

## Setting the IR Camera's Home Position

TRACKING PAGE, TRACKING LIMITS TAB

As with RoboSHOT cameras, you can set a custom home position for the IR camera. It returns to this position when it is not tracking. A typical home position might be a shot of the presenter's podium or lectern.

**To set the home position:**

1. Be sure the See Room option is checked.
2. Use the arrow buttons to aim the IR camera. If necessary, you can reduce the pan speed when the video shot is close to what you want. This does not affect camera operation during tracking. It only changes how fast the camera moves in response to the arrow buttons.
3. When the IR image shows the home position you want, select Save Current Pan Position.

The screenshot displays the vaddio RoboTRAK web interface. The top navigation bar includes the vaddio logo, the text "Sirius Cybernetics Corporation, Board Room Rm Tel 952-933-5735, Help Tel 800-572-2011", and a "Logout" button. The left sidebar contains a menu with options: Room UI, Pairing, Tracking (selected), Control Devices, Streaming, Room Labels, Networking, Security, Diagnostics, System, Help, and Logout. The main content area is divided into several sections:

- TRACKING MODE:** Includes radio buttons for "Setup", "Tracking", and a checked "See Room" checkbox.
- IR TRACKING CAMERA HOME PAN POSITION:** Features a "Store Current Pan Position" button.
- IR TRACKING CAMERA PAN LIMITS:** Contains two sliders. The first slider is for "IR TRACKING CAMERA PAN LIMITS" with a range from -90.0° to 90.0° and a current value of -2.6°. The second slider is for "LANYARD SEARCH PAN LIMITS" with a range from -50.0° to 50.0° and a current value of -2.6°. Both sliders have "Store Left" and "Store Right" buttons.
- IMAGE MASK:** Includes two sliders for "Mask Top Area" (set to 15.0%) and "Mask Bottom Area" (set to 0.0%).
- IR TRACKING CAMERA:** A control panel with directional arrow buttons, a "ZOOM" section with "+" and "-" buttons, and a "Settings..." button. Below the buttons are three sliders: "Pan Speed" (set to 12), "Tilt Speed" (set to 10), and "Zoom Speed" (set to 4). At the bottom, it shows "Pan -2.6", "Tilt -1.7", and "Zoom 15163".

## Setting the Lanyard Searching Behaviors

TRACKING PAGE, TRACKING LIMITS TAB AND ADVANCED TAB

When the IR camera does not detect the lanyard for a specified length of time, it begins searching. If it does not find the lanyard, it moves to its home position.

Default behavior	What to change	Where to find the control
Begin searching after 5 seconds	Increase the time the camera waits before it starts searching: Max Blind Time slider.	Tracking page, Advanced tab, Lanyard Search area
Stop searching after 60 seconds if the lanyard is not found	Increase or decrease the time the camera searches before it returns to the IR home position: Lanyard Search Timeout slider.	Tracking page, Advanced tab, Lanyard Search area
Pan 50° to right and to left when searching	Increase or decrease the searching area: Lanyard Search Pan Limit sliders and Store Left/Store Right buttons. <b>Note</b> <i>The search pan limits must be inside the tracking pan limits. <a href="#">See Setting the Presenter Area: Pan Limits.</a></i>	Tracking page, Tracking Limits tab, Lanyard Search Pan limits
Search at an appropriate pan speed	Select a different speed: Lanyard Search Speed buttons. For a large room where the presenter is far from the camera, use the Medium or Slow setting to ensure that the IR camera recognizes the lanyard. (If it moves too fast, it will just be-bop on past the presenter.)	Tracking page, Advanced tab, Lanyard Search area

Pan limits and search pan limits may be asymmetric.

## Setting the Presenter Area and Search Area

TRACKING PAGE, TRACKING LIMITS TAB

By default, the IR camera tracks the presenter anywhere within 90° to either side of its straight-ahead (0°) position. This area is defined by the tracking pan limits. If the IR camera stops detecting the lanyard, it searches a smaller area, defined by the search pan limits. The default is 50° to either side of the camera's 0° position. This allows the camera to track the presenter anywhere in a large part of the room, but limits the search to the front of the room.

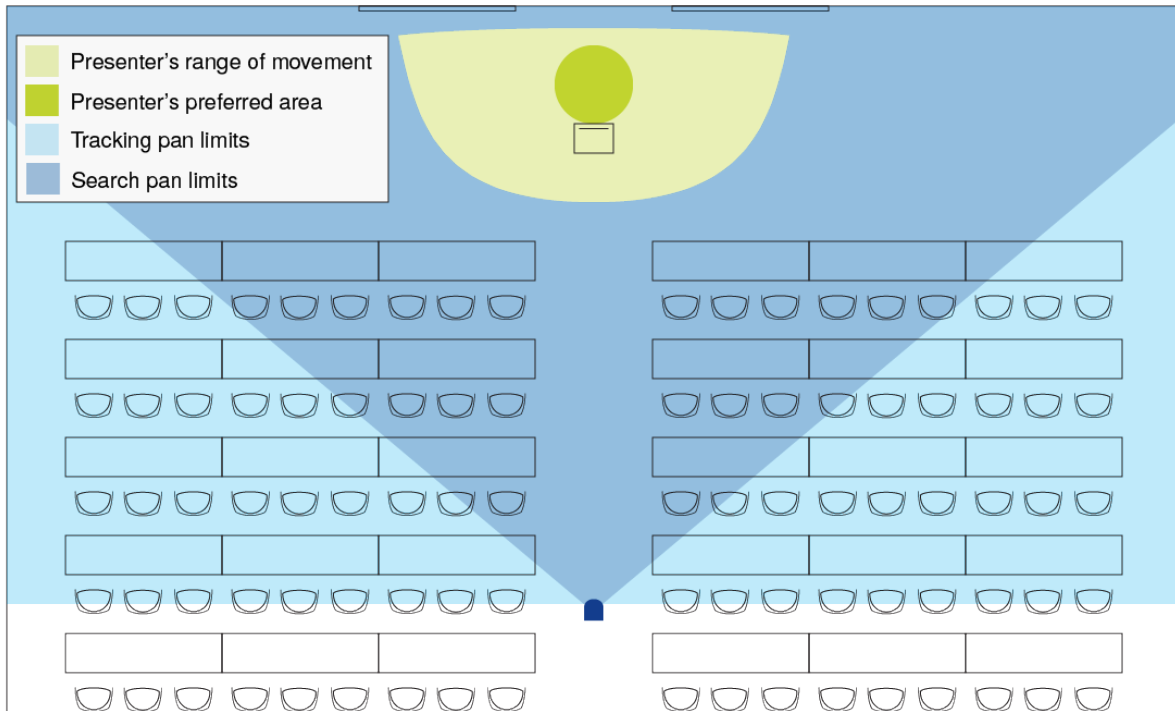

Narrowing the pan limits can be helpful in excluding sources of unwanted IR.

Both sets of limits can be modified. Right and left limits are independent of each other, but search pan limits must always be narrower than tracking pan limits.

### **Example**

*If you narrow the left side of the presenter area to 45°, you must reduce the search pan limit on the left side to less than 45°.*

**To adjust the IR Tracking Camera Pan Limits or Lanyard Search Pan Limits:**

1. Use the pan left and pan right arrows to move the camera to the desired pan limit. The camera position dot moves along the pan limit indicators.
2. For greater precision, you can reduce the pan speed using the Pan Speed slider – or you can use the Pan position increment/decrement arrows below the directional controls to dial in the pan position to within 0.1°.
3. Use the appropriate Store button to save the new pan limit.



## Adjusting AGC Gain

### TRACKING PAGE, IR CAMERA SHOT TAB

Skip this adjustment if the IR camera tracks the lanyard reliably.

Do this if these things are true:

- You are tuning the system for a large room
- It's not possible to zoom in enough to store an ideal IR camera lanyard shot – the lanyard is too small in the shot.
- The IR camera has trouble "seeing" the lanyard – tracking is erratic.

If the IR camera does not track reliably due to the target size, increase the AGC gain using the the AGC gain slider.

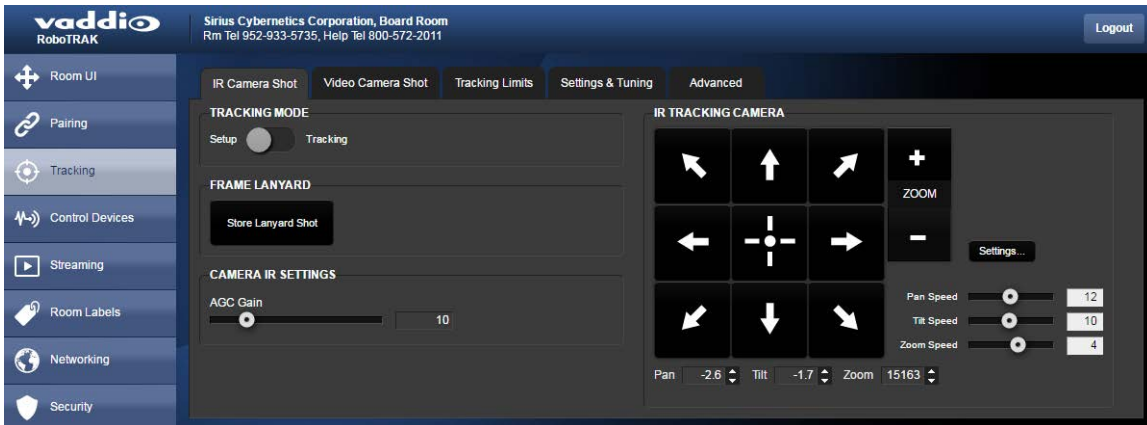



## Setting the Tracking Speed: Speed Scaler

### TRACKING PAGE, ADVANCED TAB

The speed scaler controls how quickly the video camera responds when the IR camera starts moving. The default value is 0.5 second, which works well for wide shots. For tighter shots, or in cases where the presenter will get closer to the camera, you may need to reduce this value to keep the presenter in the frame.

This adjustment differs from the Tracking Sensitivity adjustment, which controls how quickly the IR camera begins following the lanyard when the presenter moves.

The screenshot shows the vaddio RoboTRAK web interface. The 'Advanced' tab is selected under 'Settings & Tuning'. The 'TRACKING MODE' is set to 'Tracking'. The 'TRACKING SENSITIVITY' section is highlighted with a yellow box, showing 'Tracking Sensitivity' at 0.25 sec and 'Speed Scaler' at 0.60. Below this, the 'LANYARD TRIGGER WINDOW' section shows 'IR Camera Window Width' and 'IR Camera Window Height' both at 8%. The 'LANYARD SEARCH' section shows 'Max Blind Time' at 5 sec, 'Lanyard Search Timeout' at 60 sec, and 'Lanyard Search Speed' set to 'Medium'. The 'IR TRACKING CAMERA' section shows a directional pad, zoom controls, and speed sliders for Pan (12), Tilt (10), and Zoom (4). The current camera position is Pan: 20.7, Tilt: -4.7, and Zoom: 9425.

#### Adjustments:

- Increase the speed scaler value for wider shots
- Decrease the speed scaler value for tight shots, or if the presenter tends to outrun the camera.

Adjust in increments of 0.05 second for best control.

## Setting IR Camera Responsiveness: Tracking Sensitivity

### TRACKING PAGE, SETTINGS AND TUNING TAB

Tracking sensitivity controls how quickly the IR camera responds to the lanyard's motion. If the presenter will be relatively close to the camera, sensitivity may need to be increased slightly to ensure accurate tracking. As the presenter approaches the camera, the lanyard appears larger to the IR camera, and movements are proportionally larger. The IR camera needs to respond faster so that the presenter does not move out of the frame.

This adjustment differs from the Speed Scaler adjustment, which controls how quickly the video camera responds when the IR camera starts moving.

The default value for sensitivity is 0.24 second. Moving the slider to the right increases sensitivity by reducing the camera's response time. When changing the tracking sensitivity, adjust in increments of 0.02 second.

The screenshot displays the vaddio RoboTRAK interface. On the left is a navigation menu with options: Room UI, Pairing, Tracking, Control Devices, Streaming, Room Labels, Networking, Security, Diagnostics, System, Help, and Logout. The main area is titled 'Settings & Tuning' and contains several sections:

- TRACKING MODE:** Includes a toggle for 'Setup' and 'Tracking'.
- TRACKING SENSITIVITY:** A slider set to 0.25 sec, highlighted with a yellow box.
- SPEED SCALER:** A slider set to 0.60.
- LANYARD TRIGGER WINDOW:** IR Camera Window Width and Height, both set to 8%.
- LANYARD SEARCH:** Max Blind Time (5 sec), Lanyard Search Timeout (60 sec), and Lanyard Search Speed (Fast, Medium, Slow).
- IR TRACKING CAMERA:** A directional pad, zoom controls (+, -), and sliders for Pan Speed (12), Tilt Speed (10), and Zoom Speed (4). Current camera coordinates are Pan: 20.7, Tilt: -4.7, Zoom: 9425.

### Adjustments:

- Increase sensitivity if the presenter stays relatively close to the camera (for example, in a small classroom) and the tracking camera lags behind the presenter's movements through the room.
- Decrease sensitivity if the tracking appears jittery or "aggressive."

## Adjusting the Video Camera Window Width

### TRACKING PAGE, ADVANCED TAB

People move around as they give their presentations. The system should accommodate natural gestures and body language without moving, and track only when the presenter is moving through the room. The video camera window width determines the distance that the presenter can move before the system starts following.

This adjustment differs from the Tracking Sensitivity and Speed Scaler adjustments, which control camera response speed.

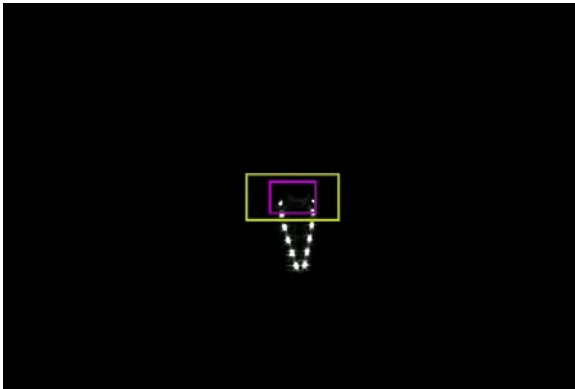

The screenshot shows the vaddio RoboTRAK Advanced settings interface. The 'WINDOWS' section is highlighted with a yellow circle. The settings are as follows:

Setting	Value
IR Camera Window Width	8 %
IR Camera Window Height	8 %
<b>Video Camera Window Width</b>	<b>16 %</b>
<b>Video Camera Window Height</b>	<b>12 %</b>

Other visible settings include:

- TUNING:** Tracking Sensitivity (0.24 sec), Speed Scaler (0.60), History Time (0.60 sec), Smoothing Span (2 points), Max Bright Pixels (2000 pixels), Brightness Threshold (165).
- SUBJECT OF INTEREST:** Tracking Left Limit (-90 °), Tracking Right Limit (90 °), Mask Top Area (15.0 %), Mask Bottom Area (0.0 %).
- LANYARD SEARCH:** Max Blind Time (5 sec), Lanyard Search Timeout (60 sec), Lanyard Search Left Limit (-50 °), Lanyard Search Right Limit (50 °), Lanyard Search Speed (Fast, Medium, Slow).
- OVERLAYS:** IR Camera Window, Video Camera Window, Mask Top Area, Mask Bottom Area, Lanyard Location, Projected Location, Weighted Pixel Field.

### Adjustments:

- If the cameras move every time the presenter moves, or there seems to be too much camera movement, increase the width of the video camera window.
- If the system is sluggish in responding to motion and the presenter moves out of the frame, decrease the width of the video camera window.

The default setting for the video frame is 16%. Make any needed adjustments in increments of 4%. The window must always be wider than it is tall, to ensure that the camera tilts appropriately.

## Dealing with Stray IR

### TRACKING PAGE, TRACKING LIMITS AND ADVANCED TABS

The RoboTRAK system is designed for environments without stray IR, but tuning can compensate for a limited amount of certain types of stray IR.

The IR camera's web interface provides adjustments to compensate for IR interference. These adjustments may help in cases where the stray IR is significantly less intense than the IR from the lanyard. They will not help if the room is flooded with IR.

### Stray IR Mitigation Cheat Sheet

Problem	Adjustment	Over-adjusting looks like...
Light fixtures emit significant IR	Mask top area – increase. (Tracking page, Tracking Limits tab)	Tracking may become erratic when the presenter is far from the camera.
Reflective tabletops or other objects near the bottom of the frame	Mask bottom area - increase. (Tracking page, Tracking Limits or Advanced tab)	Tracking stops when the presenter approaches the camera.
Bright area (IR bloom)	Max bright pixels - decrease. (Tracking page, Advanced tab)	Tracking may become erratic.
	If the problem is near the edge of the presentation area: <a href="#">reduce IR tracking pan limits</a> on the appropriate side to exclude the stray IR. (Tracking page, Tracking Limits tab) You may also need to reduce the lanyard search pan limit on the same side. Lanyard search pan limits must always be inside the area defined by the IR tracking camera pan limits.	Part of the presenter's preferred area may be out of tracking range.
Camera tracks a reflection of the lanyard	Brightness threshold - increase. (Tracking page, Advanced tab)	Tracking may become erratic.

Tracking page, Tracking Limits tab: Mask top and bottom areas, change pan limits

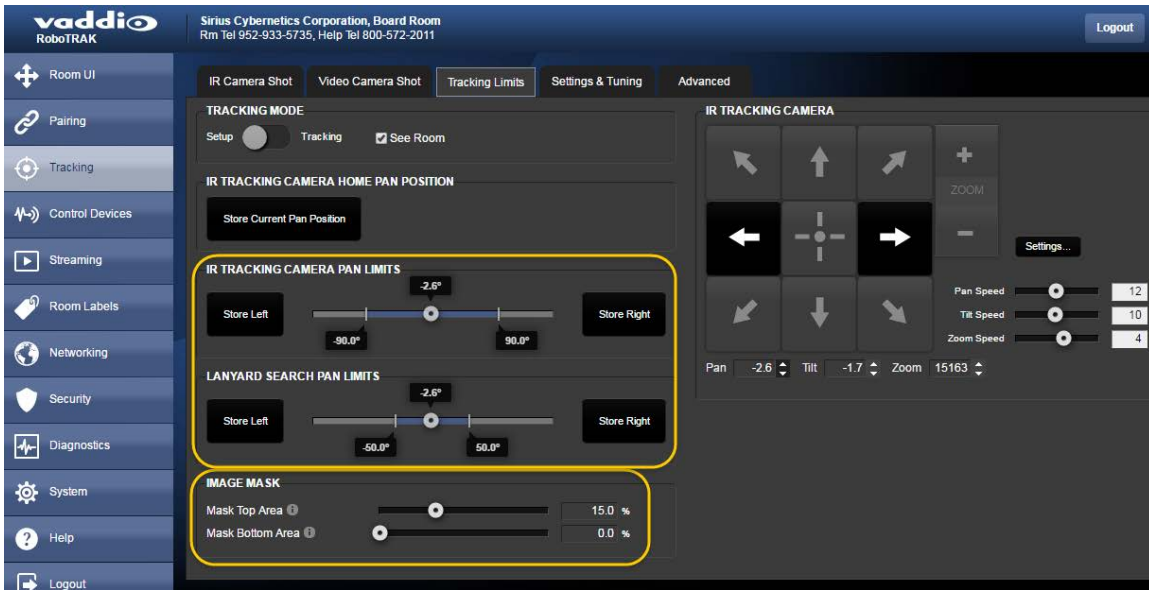

Tracking page, Advanced tab: Adjust brightness threshold and max bright pixels, mask top and bottom areas

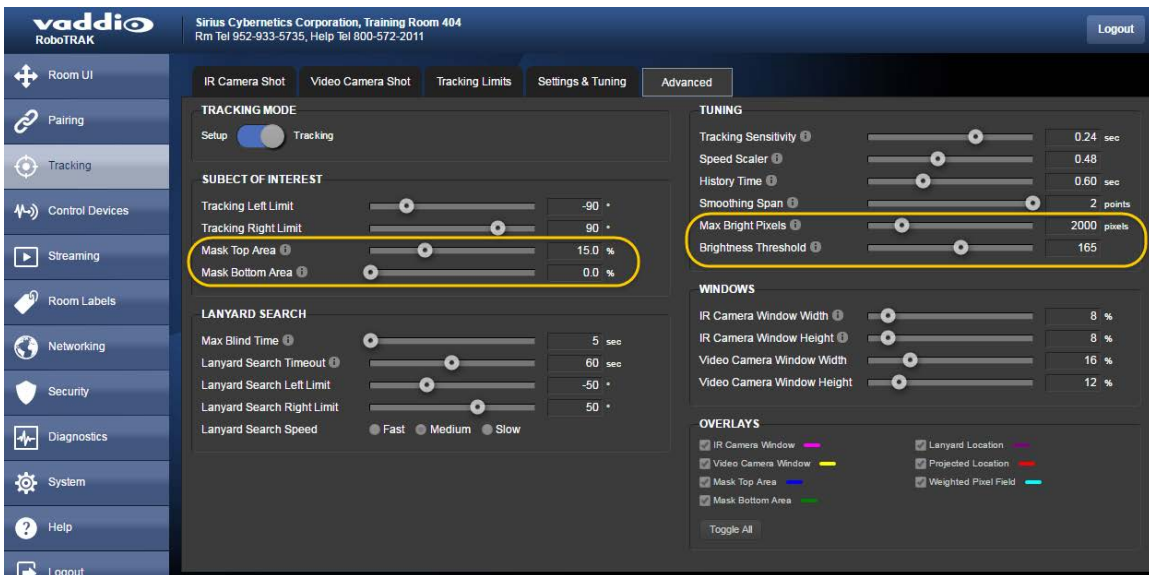

## Configuring the Video Camera

You will need to configure the video camera as well as the IR camera. Configuration options vary somewhat, depending on the camera. Refer to the video camera's manual for configuration tasks. All manuals are available at [support.vaddio.com](http://support.vaddio.com). They are also available on the product pages of the Vaddio website.

Key tasks:

- Define position presets
- Enable IP streaming, if available

Video camera presets typically provide a tighter shot at a specific location – for example the presenter at the lectern, a close-up of a demonstration, or a wider static shot of the presentation area for multiple presenters.

Other common configuration tasks:

- Save custom color settings (CCU scenes)
- Define the room label information
- Set the time zone

You can access the video camera's web interface from the IR camera's Pairing page, using the Device Web Page link.

The screenshot displays the Vaddio RoboTRAK web interface. The top header includes the Vaddio logo and the text "Sirius Cybernetics Corporation, Training Room 404 Rm Tel 952-933-5735, Help Tel 800-572-2011". A left-hand navigation menu contains icons and labels for Room UI, Pairing, Tracking, Control Devices, Streaming, Room Labels, Networking, and Security. The main content area is divided into three sections:

- VIDEO CAMERA PAIRED:** A green checkmark icon is followed by the text "Video Camera paired with IR Tracking Camera."
- VIDEO CAMERA:** A table of configuration details:
 

Host/IP Address	vaddio-roboshot-uhd-D8-80-39-62-48-9E
Device Web Page	<a href="http://vaddio-roboshot-uhd-D8-80-39-62-48-9E">http://vaddio-roboshot-uhd-D8-80-39-62-48-9E</a>
Stream Enabled on Device	Yes
Stream Info	720p / 15 fps
Stream URL	rtsp://vaddio-roboshot-uhd-D8-80-39-62-48-9E/vaddi
- STANDBY SETTINGS:** A checkbox labeled "Standby Connected Camera(s) when RoboTRAK Enters Standby" is checked.

## Exporting the Configuration

### SYSTEM PAGE

Now that you have everything working exactly the way you want it to, save your work.

#### To export the RoboTRAK configuration:

On the System page, select Export Data. The configuration file downloads to your computer. Its filename is the camera's hostname, with the file extension `.dat`.

#### Note

*The RoboTRAK IR camera cannot import a `.dat` file that was exported from a different version of software than what is currently installed. Example: You cannot export the configuration from a RoboTRAK camera and import it to another one that is using an older or newer firmware version.*

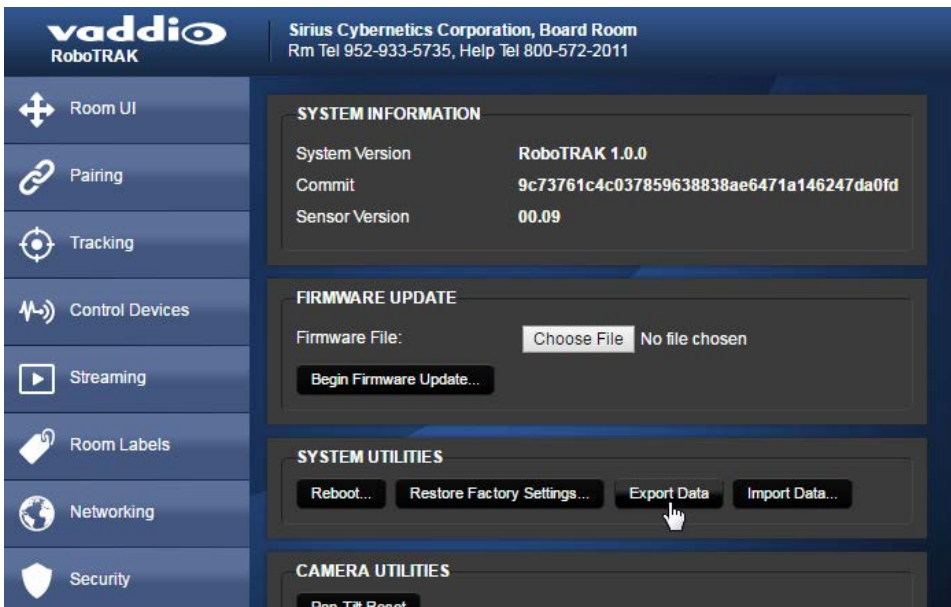

## Web Interface Cheat Sheet

Where to find the controls you need right now.

What do you need?	Go to this screen
Set the RoboTRAK IR camera in standby mode, or bring it out of standby	Room UI
Stop or resume tracking; use the video camera's presets	Room UI
Associate the video camera with the RoboTRAK IR camera	Pairing
View network information about the video camera	Pairing
Set up the lanyard shots	Tracking
Set up tracking behavior	Tracking
Tune the cameras to the room	Tracking
Store the video camera's presets	Do this in the video camera's web interface (access from the Device Web Page link on the Pairing page)
Recall the video camera's presets	Room UI
IR camera streaming settings	Streaming
IP settings <ul style="list-style-type: none"> <li>■ Hostname</li> <li>■ DHCP or static addressing</li> <li>■ Static: IP address, subnet mask, gateway</li> </ul>	Networking
Access management <ul style="list-style-type: none"> <li>■ Guest access</li> <li>■ Account passwords</li> </ul>	Security
Time zone and NTP server (source for system time/date)	Networking
Diagnostic logs	Diagnostics
Information about the camera location	Room Labels
Helpdesk phone number for end users	Room Labels
Vaddio Technical Support contact information	Help



## System Administration

This section covers basic system administration tasks:

- Security settings
- Setting the room label information
- Specifying time zone and NTP server
- Pan-tilt reset, reboot, and factory reset
- Downloading and installing firmware updates
- Getting help

These tasks are nearly identical to the corresponding system administration tasks for the video camera. The exception is the pan-tilt reset task, which is unique to the RoboTRAK IR camera.

## Security Settings

### SECURITY PAGE

Things you can do on this screen:

- Allow people to access the Camera Control screen without logging on (Allow Guest Access)
- Set whether inactive sessions log off automatically or not
- Change the password for the admin account (default is `password`)
- Change the password for the user account (default is `password`)

For security, Vaddio recommends changing the account passwords on both cameras. The Security page for the RoboSHOT video camera is nearly identical to the RoboTRAK Security page.



## Setting the Room Label Information

### ROOM LABELS PAGE

To display the organization name, room name and phone number, and the number for in-house A/V support, enter this information on the Room Labels screen.



## Specifying Time Zone and NTP Server

### NETWORKING PAGE

1. To make the time zone and NTP server editable, enable Automatic NTP Updating.
2. Select the desired time zone from the list.
3. If desired, specify the NTP server to use. Otherwise, use the default.

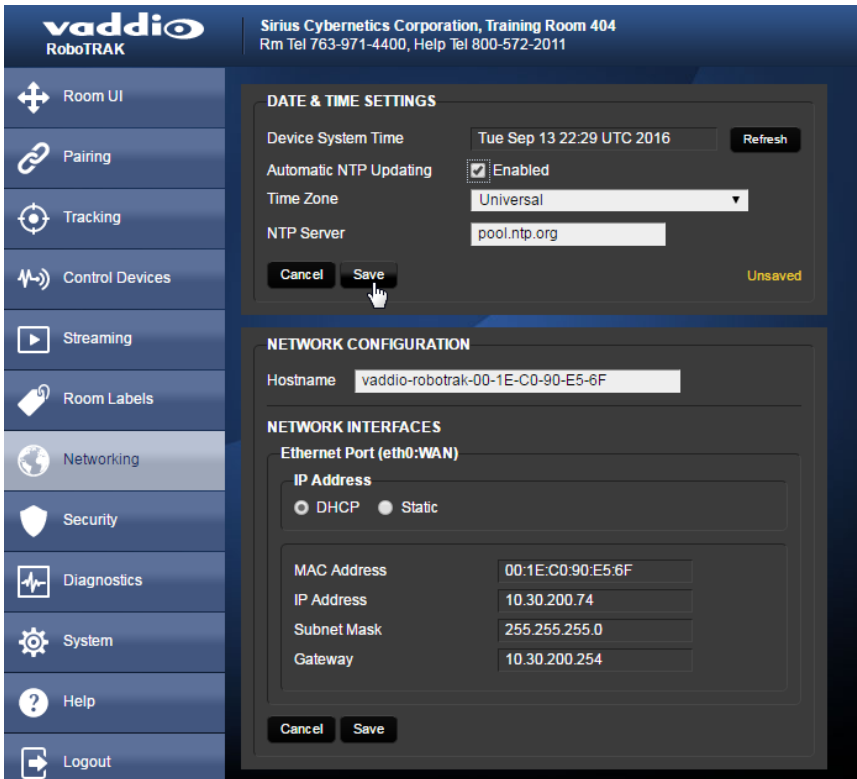

## Pan-Tilt Reset, Reboot, and Factory Reset

SYSTEM PAGE, SYSTEM UTILITIES AND CAMERA UTILITIES

### Reset the Pan and Tilt Motors

Unlike Vaddio RoboSHOT cameras, the RoboTRAK IR camera's pan and tilt information can occasionally become inaccurate – for example, if the camera is jostled during operation. To recalibrate the 0° position for the pan and tilt motors, select Pan-Tilt Reset.

### Reboot the Camera

This can help if the camera stops responding as you expect. In the System Utilities section, select Reboot.

### Restore Factory Settings

Occasionally it's easiest to just start over. To restore the original factory settings...select Restore Factory Settings.

#### **Caution**

*Factory reset will erase camera pairing information and the room configuration that you loaded, and overwrite everything else you have customized. Following this operation, you will need to configure and tune the system from scratch.*

The screenshot displays the Vaddio RoboTRAK web interface. The top header includes the Vaddio logo and contact information for Sirius Cybernetics Corporation. A left-hand navigation menu lists various system functions. The main content area is divided into several sections:

- SYSTEM INFORMATION:** Displays System Version (RoboTRAK 1.0.0), Commit (9c73761c4c037859638838ae6471a146247da0fd), and Sensor Version (01.00).
- FIRMWARE UPDATE:** Features a 'Choose File' button and a 'Begin Firmware Update...' button.
- SYSTEM UTILITIES:** Contains buttons for 'Reboot...', 'Restore Factory Settings...', 'Export Data', and 'Import Data...'.
- CAMERA UTILITIES:** Includes a 'Pan-Tilt Reset' button.
- SOFT DIP SWITCHES:** Shows a vertical slider for 'Pro A/V LED Color Scheme' and 'UC LED Color Scheme'.

At the bottom of the interface, the text 'REAR DIP SWITCHES' is partially visible.

## Downloading and Installing Firmware Updates

### SYSTEM PAGE

The RoboTRAK IR camera and the RoboSHOT video camera use the same procedure for firmware updates.

1. Locate the link to download the camera's firmware update from the website, and select it. It's with the link for the release notes.
2. Select Choose File, browse to the firmware update file that you downloaded, and select it. The filename ends with .p7m.

The screen then displays the filename beside the Choose File button.

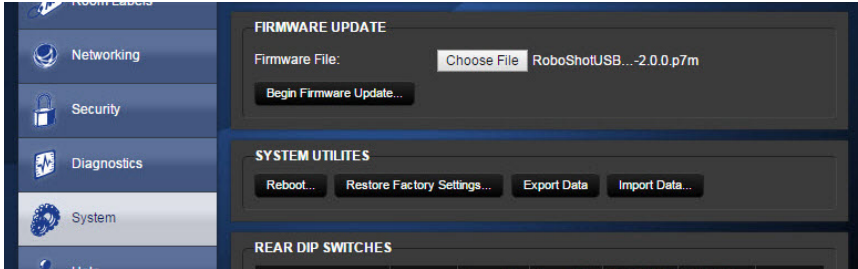

3. OPTIONAL: Select Export Data to save a copy of the camera's current configuration. You probably won't need it, but it could save time if you need to roll back the update.

#### Note

*The RoboTRAK IR camera cannot import a .dat file that was exported from a different version of software than what is currently installed. Example: You cannot export the configuration from a RoboTRAK camera and import it to another one that is using an older or newer firmware version.*

4. Select Begin Firmware Update. A confirmation dialog box opens.
5. Please READ the information in the dialog box and be sure you understand it. It's boring, but it could save you a lot of time and aggravation.
6. When you are ready to start the update, select Continue. A progress message box opens and the indicator light on the front of the camera turns yellow to show the firmware update is in progress. The process may take a few minutes.
7. If the update process presents warnings or error messages, read them carefully.

When the update is complete, the camera restarts. This logs you out of the web interface.

Contact Vaddio technical support if you encounter any problems with the update.

#### Caution

*Do not remove power or reset the camera while the indicator is yellow, showing a firmware update in progress. Interrupting a firmware update can make the camera unusable.*

## Getting Help

### HELP PAGE

If you can't resolve an issue using your superior troubleshooting skills (and maybe the [Troubleshooting](#) information in this manual), we are here to help.

You'll find information for contacting Vaddio Technical Support on the Help screen.

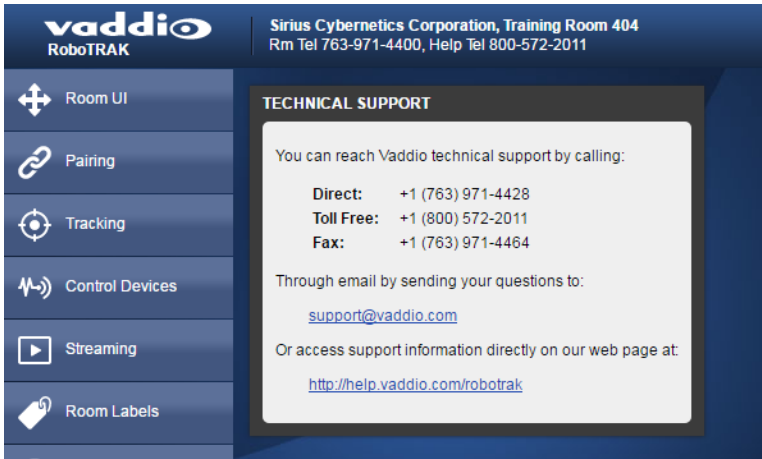

Your technical support representative may ask you to download the diagnostic log.

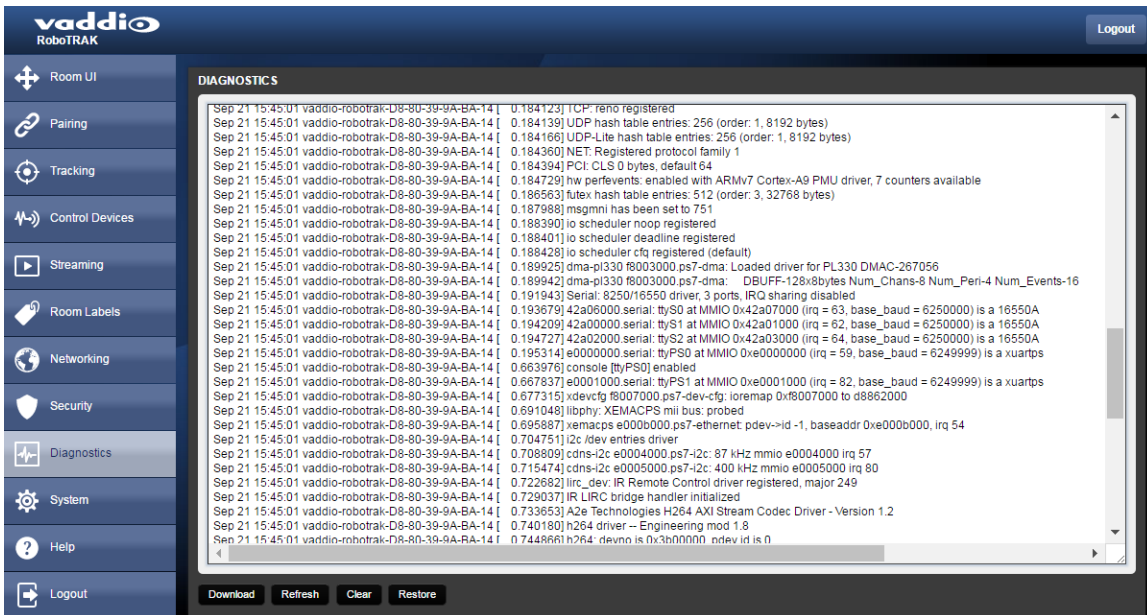

## Presenting with the RoboTRAK System

This section covers:

- How it works
- Tips for great presentations
- Starting your presentation
- Switching between tracking and camera presets
- Camera behaviors
- Tips for handling and storing the lanyard

## How It Works

Elements of the tracking system:

- **IR source** – The presenter wears an infrared signal source on a lanyard.
- **IR camera** – Follows the lanyard and directs the video camera.
- **Video Camera** (sold separately) – Follows the IR camera. Any RoboSHOT camera may be used as the video component of the RoboTRAK system.

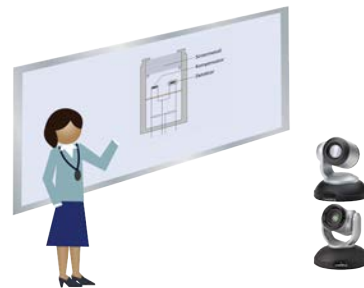

## Tips for Great Presentations

As the presenter, you can do these things to get the most out of the RoboTRAK presenter tracking system.

- Wear the IR lanyard outside your clothing. The IR camera needs to "see" the IR emitters in the lanyard to identify it when tracking starts.
- Be sure the back of the lanyard is clearly visible, not tucked under your collar or hair. This allows the IR camera to continue tracking you when you turn around.
- If you are moving and the light on the IR camera starts blinking green, the IR camera has lost you. Be sure the lanyard is visible over your clothing and hair.
- Stay at least 12 feet (3.7 m) from the cameras. The video camera does not zoom as you move around the room.
- If you are co-presenting with another person, it is helpful for both of you to have lanyards. Ensure smooth transitions by turning off your lanyard as your co-presenter turns on their own.
- When you invite others to the front of the room, be sure they do not block the line of sight between the IR camera and your lanyard.

## Starting Your Presentation

Be sure the light on the IR camera is green, meaning the system is in tracking mode. Then press the button at the center of the medallion to turn it on, and walk in front of the IR camera. The system starts tracking you immediately.

## Switching Between Tracking and Camera Presets

Some rooms are set up with video camera presets – shots that have been set up in advance, such as

- a tight shot of each dry-erase board in the classroom
- a close-up of the lab apparatus for a demonstration
- a wide shot of the entire front of the room

Check with your A/V staff to find out whether your RoboTRAK system uses presets, and how to use them if they are available to you.

## How the Cameras Behave

If the cameras are doing this...	It means...
Both cameras are pointed in the same direction. They are not moving. The light on the IR camera is green.	The cameras are ready to track. To start tracking, turn on your lanyard.
Both cameras are moving together, and the light on the IR camera is green.	The cameras are tracking.
The cameras are pointed in different directions. The lights on both cameras are blue.	The video camera is on a camera preset or tracking mode is turned off.
The IR camera pans and its light blinks green. The video camera does not move.	The IR camera is searching for the lanyard ribbon. Check to be sure nothing is covering or obscuring the lanyard ribbon – especially in the back. The entire length of the ribbon contains IR sources.
After the IR camera searches, its light turns green and the video camera follows its movements.	The IR camera found the lanyard when it searched, and it is tracking again.
After the IR camera searches, its light turns green. Both cameras move to the home position and stop.	The IR camera did not find the lanyard when it searched. The cameras are now "parked" at the home position and ready to track. This happens when you turn off the lanyard.
The IR camera's light is blinking blue.	The IR camera is unable to communicate with the video camera. Contact your A/V team for help.

## Tips for Handling and Storing the Lanyard

Please handle the lanyard with care. Both the medallion and the ribbon contain electronic components that can be damaged if handled roughly.

- When you take off the lanyard, slip it over your head rather than using the safety clasp.
- Do not bend the lanyard ribbon where it joins the medallion.
- Coil the ribbon loosely. Pinching or creasing it will damage it.
- Connect the lanyard to its charging cable at the end of each day.



## Telnet Serial Command API

The Vaddio serial command protocol is a high-level, text-based command line interface supported via Telnet session on the camera. The API is accessed by a telnet client on the Ethernet port; the default Telnet port is 23. Telnet sessions require the administrator account login.

The command application protocol interface is intended to allow external device such as AMX or Crestron to control the system. The protocol is based upon ASCII format following the VT100 terminal emulation standard and uses an intuitive text command nomenclature for ease of use.

General format usage follows a get/set structure. Usage examples for each type are:

### Set Example

COMMAND: > **camera pan right**

RESPONSE: > OK

### Get Example

COMMAND: > **camera ccu get iris**

RESPONSE: > iris 11

### Syntax Error Example

COMMAND: > **camera right pan**

RESPONSE: > ERROR

Using a question mark as a command parameter will bring up a list of available commands for the menu you are in.

Things to know about control via Telnet session:

- Command lines are terminated with a carriage return.
- All ASCII characters (including carriage returns) are echoed to the terminal program and appended with the VT100 string ESC[J (hex 1B 5B 4A), which most terminal programs automatically strip.
- CTRL-5 Clears the current serial buffer on the device.

## About Controlling the Video Camera via Telnet

A Telnet session with the RoboTRAK IR camera does not provide communication to the video camera, except in the case of commands that instruct the IR camera to send a command to the video camera. The video camera can be controlled separately via Telnet; however, tracking should be disabled whenever you control the video camera directly.

Refer to the video camera's manual for information about the commands available.

## Commands to Avoid

**Do not** send the following commands to the video camera while the IR camera is in tracking mode:

- Camera pan or tilt commands – the video camera will only respond momentarily, as the IR camera may send tracking coordinates several times per second.
- Preset recall commands – turn off tracking on the IR camera, or invoke the preset from the IR camera (camera slave1 preset recall command to go to a preset).

### Note

*Unless otherwise stated, the commands documented in this manual affect only the camera to which they are directed. Many of them are specific to the IR camera and are not valid for video cameras.*

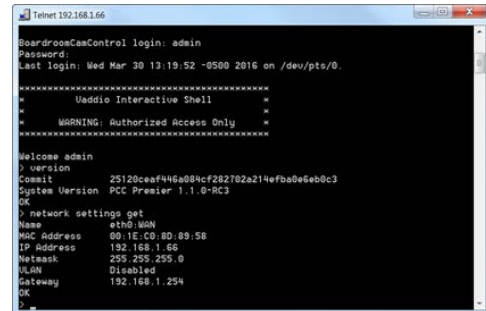

```

Telnet 192.168.1.66
BoardroomCcaControl login: admin
Password:
Last login: Wed Mar 30 13:19:52 -0500 2016 on /dev/pts/0.
*****
*      Uaddio Interactive Shell      *
*****
WARNING: Authorized Access Only
*****

Welcome admin
> version
Commit      25120ceaf446a084cf282702a214efba0e6eb0c3
System Verion PCC Premier 1.1.0-RC3
OK
> network settings get
Name        eth0 WAN
MAC Address 08:1E:C0:8D:89:58
IP Address  192.168.1.66
Netmask     255.255.255.0
DUPN       Disabled
Gateway     192.168.1.254
OK
>

```



## camera master tracking

Stop or start tracking mode. Tracking mode should be off (stopped) for direct operation of the video camera.

Synopsis	camera master tracking [ stop   resume ]	
Parameters and Values	stop	halts tracking and park cameras at the home position
	resume	starts tracking
Example	<pre>camera master tracking stop</pre> <p>Takes the system out of tracking mode.</p>	

## camera master recalibrate

Executes a pan-tilt reset. This takes a few seconds.

This command is for the RoboTRAK IR camera only. It is not used for video cameras.

Synopsis	camera master recalibrate
Example	<b>camera master recalibrate</b>

## camera master standby

Gets or sets the IR camera's standby state.

To control whether the video camera goes to standby mode when the IR camera does, use the command [camera master standby config peripheral](#).

Synopsis	camera master standby [ get   on   off   toggle ]	
Parameters and Values	get	Returns the current standby status for the IR camera.
	on	Places the IR camera in standby mode.
	off	Brings the IR camera out of standby, placing it in full-power mode.
	toggle	Changes the IR camera's standby state - if it was in standby mode, <code>toggle</code> brings it to full-power mode, and vice-versa.
Examples	<pre>camera master standby on</pre> <p>Places the IR camera in standby mode.</p>	
	<pre>camera master standby get</pre> <pre>standby:      off</pre> <pre>OK</pre> <p>Returns the IR camera's current standby state – standby is off, meaning the camera is in full-power mode.</p>	

## camera master standby config peripheral

Returns or sets the standby behavior for the RoboTRAK system's video camera.

Synopsis	camera master standby config peripheral [ get   on   off   toggle ]	
Parameters and Values	get	Returns the current standby configuration for the video camera.
	on	Sets the video camera to go to standby mode when the IR camera goes to standby.
	off	Sets the video camera to remain fully powered up when the IR camera goes to standby.
	toggle	Changes the video camera's standby behavior - if its previous standby configuration was <code>on</code> , the <code>toggle</code> parameter changes it to <code>off</code> .
Examples	<b>camera master standby config peripheral on</b> Sets the video camera to go to standby mode when the IR camera does so.	
	<b>camera master standby config peripheral get</b> <pre>peripheral:    on OK &gt;</pre> Returns the standby configuration for the video camera. In this example, it is currently set to go to standby when the IR camera does so.	

## camera master ccu

Returns or sets the value for the IR (master) camera's AGC gain. This value can be increased if the system is in a large room where it is not possible to zoom in far enough to set up an optimal IR camera lanyard shot. The AGC gain setting is also available through the IR camera's web interface.

Synopsis	camera master ccu [get   set ] agc_gain	
Parameters and Values	get agc_gain	Returns the current AGC gain value.
	set agc_gain <1..48>	Sets the AGC gain value to an integer in the range of 1 to 48.
Example	<b>camera master ccu get agc_gain</b> <pre>AGC gain      18 OK &gt;</pre>	

## camera slave1 preset recall

Recalls the RoboTRAK system's video camera to the specified preset. The video camera only responds to this command if it has stored the specified preset.

When the video camera's presets are accessed via the IR camera, it moves to the preset but the IR camera continues to track.

Presets are stored in the video camera and can be accessed from the IR camera while tracking is paused. Refer to the API information in the video camera's manual for details on storing presets.

Up to 16 presets are available through the Telnet API. In the IR camera's web interface, eight video camera presets are available. Twelve presets are available from the video camera's web interface.

Synopsis	camera slave1 preset recall <1..16>	
Parameters and Values	<1..16>	Moves the video camera to the specified preset position.
Example	<b>camera slave1 preset recall 3</b> Moves the video camera to preset 3 (if stored).	

## network ping

Sends an ICMP ECHO\_REQUEST to the specified IP address.

Synopsis	network ping [count <count>] [size <size>] <destination-ip>	
Options	count	The number of ECHO_REQUEST packets to send. If this is not specified, the default is five packets.
	size	The size of each ECHO_REQUEST packet. If this is not specified, the default is 56 bytes.
	<destination-ip>	The IP address where the ECHO_REQUEST packets will be sent.
Examples	<b>network ping 192.168.1.1</b> Sends five ECHO_REQUEST packets of 56 bytes each to the host at 192.168.1.1.	
	<b>network ping count 10 size 100 192.168.1.1</b> Sends 10 ECHO_REQUEST packets of 100 bytes each to the host at 192.168.1.1.	

## network settings get

Returns the current network settings for MAC address, IP address, subnet mask, and gateway.

Synopsis	network settings get
Example	<b>network settings get</b>  MAC Address: 00:04:a3:85:0a:ee IP Address: 10.10.8.116 Netmask: 255.255.255.0 Gateway: 10.10.8.100

## streaming settings

Retrieves or specifies the IP streaming settings for the camera.

Synopsis	streaming settings {get   set [ip_enabled]   [ip_port]   [ip_protocol]   [ip_quality]   [ip_resolution]   [ip_url]}	
Options	ip_enabled [true   false]	true enables streaming; false disables it.
	ip_port <port number>	Specifies the port that the IP stream uses. Port 554 is the default.
	ip_protocol [rtsp]	Specifies the streaming protocol. Only RTSP is supported at this time.
	ip_quality [low   standard   high]	Specifies the video quality. Low is useful for low-bandwidth situations.
	ip_resolution <480p>	Specifies streaming video resolution. For the RoboTRAK IR camera, 480p is the only valid streaming resolution.
	ip_url <URL>	Specifies the URL where the stream is available.
Examples	<pre>&gt; streaming settings get IP Enabled      true IP Port         554 IP Protocol     RTSP IP Quality      High Quality (Best) IP Resolution   480p IP URL          vaddio-robotrak-stream &gt; OK</pre>	

## system reboot

Reboots the system either immediately or after the specified delay. Note that a reboot is required when resetting the system to factory defaults (system factory-reset).

Synopsis	system reboot [<seconds>]	
Options	<seconds>	The number of seconds to delay the reboot
Examples	<b>system reboot</b> Reboots the system immediately.	
	<b>system reboot 30</b> Reboots the system in 30 seconds.	

## system factory-reset

Gets or sets the factory reset status. When the factory reset status is on, the system resets to factory defaults on reboot.

Synopsis	<code>system factory-reset { get   on   off }</code>	
Options	<code>get</code>	Returns the camera's current factory reset status.
	<code>on</code>	Enables factory reset on reboot.
	<code>off</code>	Disables factory reset on reboot.
Examples 	<b><code>system factory-reset get</code></b> Returns the factory reset status in this form: <pre>factory-reset (software): off</pre> (This evaluates the most recent <code>system factory-reset on</code> or <code>off</code> command, if one has been received.) <pre>factory-reset (hardware): off</pre> (This reads the rear panel DIP switches and returns the status <code>on</code> if they are all in the down position.)	
	<b><code>system factory-reset on</code></b> Enables factory reset upon reboot. Returns current status in this form: <pre>factory-reset (software): on</pre> <pre>factory-reset (hardware): off</pre>	

## sleep

Pauses for the specified number of milliseconds.

Synopsis	<code>sleep &lt;milliseconds&gt;</code>	
Options	<code>&lt;milliseconds&gt;</code>	The number of milliseconds (1 - 10000) to pause
Example	<b><code>sleep 7000</code></b> Pause for 7000 milliseconds before returning.	

## help

Displays an overview of the CLI syntax.

Synopsis	help
Example 	<b>help</b> 

## history

Returns the most recently issued commands from the current Telnet session. Since many of the programs read user input a line at a time, the command history is used to keep track of these lines and recall historic information.

Synopsis	history <limit>	
Options	<limit>	Integer value specifying the maximum number of commands to return.
Examples	<b>history</b> Displays the current command buffer.  <b>history 5</b> Sets the history command buffer to remember the last 5 unique entries.	
Additional information 	You can navigate the command history using the up and down arrow keys.  This command supports the expansion functionality from which previous commands can be recalled from within a single session. History expansion is performed immediately after a complete line is read.  Examples of history expansion: <ul style="list-style-type: none"> <li>* !! Substitute the last command line.</li> <li>* !4 Substitute the 4th command line (absolute as per 'history' command)</li> <li>* !-3 Substitute the command line entered 3 lines before (relative)</li> </ul>	

## version

Returns the current firmware version.

Synopsis	<code>version</code>
Example	<p><b>version</b></p> <p>Returns current firmware version information in a form something like this:</p> <pre>Commit: d033ddb2378357a871011eb820706dcaa64ec0e2 Sensor Version: 01.00 System version: RoboTRAK 1.0.0</pre>

## exit

Ends the command session and then closes the socket.

Synopsis	<code>exit</code>
Example	<b>exit</b>

## Troubleshooting and Care

Stuff happens – we get it. Use this section to determine whether it's time to call Vaddio Technical Support. For details on camera interactions during normal use, see [How the Cameras Behave](#).

For issues with tracking, see the diagnostic tables in [Dealing with Stray IR](#) and [Testing and Fine-Tuning](#).

### Status Indications

When the cameras don't behave as you expect, check the indicator lights. In the RoboTRAK system, the IR camera's light provides the best troubleshooting guidance.

RoboTRAK IR camera:

- Green – Tracking or waiting at the home position
- Blue – Not in tracking mode (may be at a video camera preset position)
- Blinking green – Searching for the lanyard
- Blinking blue – Not paired or not in contact with the video camera
- Purple – In standby mode or booting
- Blinking yellow – Executing a pan-tilt reset
- Yellow – Updating firmware

### Fault Isolation

What is it doing?	Possible causes	Check and correct
Nothing. The light on the front is off.	No power to the camera	Check the cables: <ul style="list-style-type: none"> <li>■ Power cable from the PoE splitter</li> <li>■ Cat-5 cable from the PoE+ power injector to the splitter</li> </ul>
		Check the wall outlet to see if it powers another item such as a cell phone charger.
		Possible hardware issue: <ul style="list-style-type: none"> <li>■ PoE splitter</li> <li>■ PoE+ power injector</li> <li>■ Camera</li> </ul> Contact Vaddio Technical Support.
Can't access the IR camera's web interface	The camera is not at the specified IP address or using the specified hostname.	Be sure you have entered the IP address or hostname correctly.
Can't view the stream from the IR camera.	Streaming is not enabled.	Enable streaming on the Streaming page in the web interface.



What is it doing?	Possible causes	Check and correct
RoboTRAK IR camera can't find the video camera	Cameras are not paired	Enter or update the video camera's hostname (or static IP address) on the Pairing page. Ensure that the video camera is connected to the network.
Video camera does not respond to preset requests from the IR camera	The requested preset has not been saved on the video camera	Take the system out of tracking mode. Then use the video camera's IR remote or web interface to save the desired presets.
Video camera does not zoom while tracking	This is normal.	

## Operation, Storage, and Care

For smears or smudges on any component of the system, wipe with a clean, soft cloth. Use a lens cleaner on the lens. Do not use any abrasive chemicals.

Keep this system away from food and liquids.

Do not operate or store the device under any of the following conditions:

- Temperatures above 40°C (104°F) or below 0°C (32°F)
- High humidity, condensing or wet environments
- Inclement weather
- Severe vibration
- Dry environments with an excess of static discharge
- Outside a spacecraft during or after launch

Do not attempt to take any component of this system apart. There are no user-serviceable parts inside.

## Specifications

### IR Camera

<b>Operational Distance</b>	12 to 50 ft (3.7 to 15.2 m)	<b>Peak IR Sensitivity</b>	850 nm
<b>Horizontal range</b>	±90°	<b>Vertical Placement</b>	7 to 15 ft (2.1 to 4.6 m)
<b>Max. Vertical Offset</b>	20°	<b>Position Presets</b>	10
<b>Communication</b>	10/100 Ethernet	<b>Power</b>	12 VDC, 3.0A
<b>Height</b>	6.3 in (163 mm)	<b>Depth</b>	5.5 in (145 mm)
<b>Width</b>	6.1 in (155 mm)	<b>Weight</b>	3.0 lbs (1.36 kg)

### IR Source Lanyard

<b>Battery Life</b>	Up to 40 hrs (25 typical)	<b>Charging time</b>	About 4 hrs
<b>Diameter</b>	2 in (51 mm)	<b>Depth</b>	1.0 in (25 mm)
<b>Weight</b>	3.2 oz (91 g)	<b>Lanyard length</b>	24 in (610 mm)

### System Mounting Weight

<b>Mounted to Wall</b>	15.3 to 16.4 lbs (6.95 to 7.45 kg)	<b>Mounted to Ceiling</b>	16.7 to 17.8 lbs (7.55 to 8.05 kg)
------------------------	------------------------------------	---------------------------	------------------------------------

*Weight varies depending on the video camera used.*

### Environmental and Room Requirements

<b>Operating temperature</b>	0 °C to +24°C (32°F to 75°F)	<b>Storage temperature</b>	-5° to +60° C (23°F to 140°F)
<b>Operating humidity</b>	15% to 80% RH (non-condensing)	<b>Storage humidity</b>	20% to 80% RH (non-condensing)
<b>Lighting Restrictions</b>	No natural or halogen-based lighting, no IR-based communication systems		

**Video Camera – see specifications for the purchased camera**

## Compliance Statements and Declarations of Conformity

Compliance testing was performed to the following regulations:

FCC Part 15 (15.107, 15.109), Subpart B	Class A
ICES-003, Issue 54: 2012	Class A
EMC Directive 2004/108/EC	Class A
EN 55022: December 2010	Class A
EN 55024: November 2010	Class A
KN22 2008 (CISPR 22: 2006)	Class A
KN24 2008 (CISPR 24: 1997 + A1: 2000 + A2: 2002)	Class A
IEC 60950-1:2005 (2nd Edition); Am 1: 2009 + Am 2: 2013	Safety
EN 60950-1: 2006 + A11: 2009 + A1: 2010 + A12: 2011 + A2: 2013	Safety

### FCC Part 15 Compliance

This equipment has been tested and found to comply with the limits for a Class A digital device, pursuant to Part 15, Subpart B, of the FCC Rules. These limits are designed to provide reasonable protection against harmful interference when the equipment is operated in a commercial environment. This equipment generates, uses, and can radiate radio frequency energy and, if not installed and used in accordance with the instruction manual, may cause harmful interference to radio communications. Operation of this equipment in a residential area is likely to cause harmful interference in which case the user will be required to correct the interference at his/her own expense.

Operation is subject to the following two conditions: (1) This device may not cause interference, and (2) This device must accept any interference including interference that may cause undesired operation of the device.

Changes or modifications not expressly approved by Vaddio can affect emission compliance and could void the user's authority to operate this equipment.



### ICES-003 Compliance

This digital apparatus does not exceed the Class A limits for radio noise emissions from digital apparatus set out in the Radio Interference Regulations of the Canadian Department of Communications.

Le présent appareil numérique n'émet pas de bruits radioélectriques dépassant les limites applicables aux appareils numériques de la classe A prescrites dans le Règlement sur le brouillage radioélectrique édicté par le ministère des Communications du Canada.



Industry  
Canada

Industrie  
Canada

## European Compliance

This product has been evaluated for electromagnetic compatibility under the EMC Directive for Emissions and Immunity and meets the requirements for a Class A digital device. In a domestic environment this product may cause radio interference in which case the user may be required to take adequate measures.

Standard(s) To Which Conformity Is Declared:



**EMC Directive 2004/108/EC**

**EN 55022: December 2010**

**EN 55024: November 2010**

EN 61000-4-2: 1995 + Amendments A1: 1998 + A2: 2001

EN 61000-4-3: 2006 + A1: 2008

EN 61000-4-4: 2004 + Corrigendum 2006

EN 61000-4-5: 2006

EN 61000-4-6: 2009

EN 61000-4-8: 2010

EN 61000-4-11: 2004

**KN22 2008 (CISPR 22: 2006)**

**KN24 2008 (CISPR 24: 1997 + A1: 2000 + A2: 2002)**

EN 61000-4-2

EN 61000-4-3

EN 61000-4-4

EN 61000-4-5

EN 61000-4-6

EN 61000-4-8

EN 61000-4-11

**IEC 60950-1: 2005 (2nd Edition); Am 1: 2009 + Am 2: 2013**

**EN 60950-1: 2006 + A11: 2009 + A1: 2010 + A12: 2011 + A2: 2013**

Conducted and Radiated Emissions

Immunity

Electrostatic Discharge

Radiated Immunity

Electrical Fast Transients

Surge Immunity

Conducted Immunity

Power Frequency Magnetic Field

Voltage Dips, Interrupts and Fluctuations

Conducted and Radiated Emissions

IT Immunity Characteristics

Electrostatic Discharge

Radiated Immunity

Electrical Fast Transients

Surge Immunity

Conducted Immunity

Power Frequency Magnetic Field

Voltage Dips, Interrupts and Fluctuations

Safety

Safety

## Warranty Information

See Vaddio Warranty, Service and Return Policies posted on [support.vaddio.com](http://support.vaddio.com) for complete details.

**Hardware\* warranty:** Two (2) year limited warranty on all parts and labor for Vaddio manufactured products. Vaddio warrants its manufactured products against defects in materials and workmanship for a period of two years from the day of purchase, to the original purchaser, if Vaddio receives notice of such defects during the warranty. Vaddio, at its option, will repair or replace products that prove to be defective. Vaddio manufactures its hardware products from parts and components that are new or equivalent to new in accordance with industry standard practices.

**Exclusions:** The above warranty shall not apply to defects resulting from improper or inadequate maintenance by the customer, customers applied software or interfacing, unauthorized modifications or misuse, mishandling, operation outside the normal environmental specifications for the product, use of the incorrect power supply, modified power supply or improper site operation and maintenance. OEM and special order products manufactured by other companies are excluded and are covered by the manufacturer's warranty.

**Vaddio Customer Service:** Vaddio will test, repair, or replace the product or products without charge if the unit is under warranty. If the product is out of warranty, Vaddio will test then repair the product or products. The cost of parts and labor charge will be estimated by a technician and confirmed by the customer prior to repair. All components must be returned for testing as a complete unit. Vaddio will not accept responsibility for shipment after it has left the premises.

**Vaddio Technical Support:** Vaddio technicians will determine and discuss with the customer the criteria for repair costs and/or replacement. Vaddio Technical Support can be contacted by email at [support@vaddio.com](mailto:support@vaddio.com) or by phone at one of the phone numbers listed on [support.vaddio.com](http://support.vaddio.com).

**Return Material Authorization (RMA) number:** Before returning a product for repair or replacement request an RMA from Vaddio's technical support. Provide the technician with a return phone number, e-mail address, shipping address, product serial numbers and original purchase order number. Describe the reason for repairs or returns as well as the date of purchase. See the General RMA Terms and Procedures section for more information. RMAs are valid for 30 days and will be issued to Vaddio dealers only. End users must return products through Vaddio dealers. Include the assigned RMA number in all correspondence with Vaddio. Write the assigned RMA number clearly on the shipping label of the box when returning the product. All products returned for credit are subject to a restocking charge without exception. Special order product are not returnable.

**Voided warranty:** The warranty does not apply if the original serial number has been removed or if the product has been disassembled or damaged through misuse, accident, modifications, use of incorrect power supply, use of a modified power supply or unauthorized repair.

**Shipping and handling:** Vaddio will not pay for inbound shipping transportation or insurance charges or accept any responsibility for laws and ordinances from inbound transit. Vaddio will pay for outbound shipping, transportation, and insurance charges for all items under warranty but will not assume responsibility for loss and/or damage by the outbound freight carrier. If the return shipment appears damaged, retain the original boxes and packing material for inspection by the carrier. Contact your carrier immediately.

**Products not under warranty:** Payment arrangements are required before outbound shipment for all out of warranty products.

# Index

## A

- accessing the video camera's web interface 21
- additional products required 2, 5
- adjustments 30-41
  - home position 32
  - IR camera gain 36
  - presenter distance 38
  - room size 36-37
  - search behavior 33
  - search limits 34-35
  - stray IR mitigation 40-41
  - tracking limits 34-35
  - tracking sensitivity 38
  - tracking speed 37
  - video window width 39
- admin login 18-19, 21
- AGC gain 36, 54
- anatomy of the camera 5-6
- anatomy of the lanyard 6
- API 52, 58
  - syntax help 58
- area to search 33

## B

- backing up the configuration 43
- behavior on power-up 17
- browser compatibility 18

## C

- cable 14
  - network, IR camera 14
  - power, IR camera 14
- cable connectors 6, 12
- camera behavior during presentations 51
- camera mount 9, 13, 15
  - ceiling 13, 15
  - installing 15
  - location 9, 13
  - wall 15
- camera placement 9-11, 13
- camera sensitivity 36
- ceiling mount 13, 15
- cheat sheet 31, 40, 44, 51
  - camera behavior 51

- IR mitigation 40
  - tuning 31
  - web interface 44
- cleaning 61
- command history 58
- communicating with the IR camera 13
- compatibility, browsers 18
- compensating for stray IR 40-41
- configuration, exporting 43
- connecting cameras 17
- connection diagram 16
- connectors 6
- contacting Vaddio Technical Support 49
- custom home position 32

## D

- damage, preventing 12, 14
- default hostname 7
- default password 19
- default settings, restoring 47
- Diagnostics page 49
- dimensions 62
- DIP switches 6
- downloading the room configuration file 20

## E

- equipment for installation and tuning 7, 18
- Ethernet port 6

## F

- factory defaults, restoring 47, 57
- fault isolation 60
- ferrite bead for lanyard charging cable 17
- fine-tuning 30-39
- firmware update 48
- firmware version 59

## G

- gain, IR camera 36

## H

- help 49
- Help page 49
- home position 32
- hostname 2, 7, 13, 18, 22, 24
  - assigning 22
  - default 2, 7, 13, 18

**I**

- idle position 32
- idle session timeout 45
- importing the room configuration file 20
- indicator lights 5, 51, 60
- installation 7, 9, 13-17
  - basic 16
  - camera mount 15
  - cameras 17
  - requirements 7, 9, 13
  - with equipment needed for tuning 16
- instructions for presenting 50
- IP address 18, 22-23
  - default 18
  - static, assigning 22-23
- IP streaming 56
  - settings 56
- IR camera response time 38
- IR camera sensitivity 36
- IR lanyard shot 26
- IR mitigation 7-8, 40-41
- IR stream 25, 27

**L**

- lanyard 6, 17, 50-51
  - charging 17, 51
  - handling 6, 51
  - packing list 17
  - wearing 50
- lanyard shot 25-29
  - IR camera 26-27
  - video camera 28-29
- large room layout 11
- layouts, room 9-11, 28
- lighting requirements 7-8
- limits 34-35, 41
  - search 34-35
  - tracking 34-35
- location of the camera 9-11, 13
- locations of connectors 6
- login 18, 21, 45

**M**

- medium room layout 10
- mount 13, 15
  - ceiling 13, 15
  - wall 13, 15
- mounting cameras 13, 15, 17

**N**

- network cable 14
- network configuration 55
- network port 6
- network requirements 7
- Networking page 22-23, 46
- NTP server 46

**O**

- operating environment 12, 61

**P**

- packing lists 2, 17
  - camera 2
  - lanyard 17
- pairing cameras 24
- Pairing page 21, 23-24, 42
- pan limits 33-35, 41
  - search 34-35
  - tracking 34-35
- pan/tilt recalibration 47, 53
- passwords 18, 21, 45
  - changing 45
  - default 18-19, 21
- ping command 55
- PoE splitter 14
- power cable 14
- power connector 6
- power on/power off 17
- precautions 2, 6, 12, 51
  - for handling cameras 2
  - for handling the lanyard 6, 51
  - for operating the system 12
- presentation, starting 50
- presenter's style 28
- presenter area 28, 34
- presenter information 50
- product returns and repairs 65

**Q**

- quick reference 31, 40, 44, 51
  - camera behavior 51
  - IR mitigation 40
  - tuning 31
  - web interface 44

**R**

- rebooting the camera 47, 56

recalibrating pan and tilt 47  
 requirements 7-9, 13, 18, 62  
     camera location 9  
     configuration 18  
     installation 9  
     lighting 7-8  
     mounting 13  
     network 7  
     operating environment 62  
     room 7  
     system 7  
 response time 37-38  
     IR camera 38  
     video camera 37  
 restoring default settings 47, 57  
 RJ-45 connectors 12  
 room configuration file 20  
 Room Labels page 46  
 room layouts 9-11, 28  
 room lighting 8  
 room requirements 7, 9  
 room size adjustments 37

## **S**

saving the configuration 43, 48  
 search area 33-34  
 search behavior 33  
 search speed 33  
 Security page 45  
 sensitivity 36, 38  
     IR 36  
     tracking 38  
 settings, default, restoring 57  
 setup mode 27  
 shelf, camera mount 15  
 small room layout 9  
 solving problems 60  
 specifications 62  
 speed 33, 37  
     search 33  
     tracking 37  
 splitter, PoE 14  
 standby behavior 24, 53-54  
 starting a presentation 50  
 static IP address 22  
 storage environment 61  
 stray IR 7-8, 34, 40-41  
     common sources 8  
     example 8

    excluding 34, 40-41  
 stream viewer 25  
 Streaming page 25  
 streaming settings 56  
 streaming URL 25  
 supported web browsers 18  
 System page 20, 43, 47-48  
 system requirements 7

## **T**

technical specifications 62  
 technical support 49  
 Telnet command help 58  
 Telnet session 52, 58-59  
     ending 59  
     history 58  
 temperature, operating and storage 61  
 theory of operation 50  
 time to search 33  
 time to wait before searching 33  
 time zone 46  
 tips for presenting 50  
 tracking 26, 28, 30, 33-34, 37-38, 53  
     basic setup 26, 28  
     limits 33-34  
     mode 30, 53  
     sensitivity 38  
     speed 37  
 Tracking page 26, 28-30, 32-39, 41  
 troubleshooting 60  
 tuning 25-26, 28-32, 34-39

## **V**

version, firmware 59  
 video camera 21, 23-24, 28-29, 42, 55  
     accessing web interface 21, 23, 42  
     lanyard shot 28-29  
     pairing to the IR camera 24  
     presets 55  
     required configuration tasks 23, 42  
     standby 24  
 video shot 28

## **W**

wall mount 15  
     installing 15  
 warranty 12, 65  
 web browsers supported 18



web interface 18-19, 21-26, 29-30, 32-39, 41-43, 45-49

- accessing 18-19, 28
- default password 21
- Diagnostics page 49
- guest access 45
- Help page 49
- Networking page 22-23, 46
- Pairing page 21, 23-24, 42
- Room Labels page 46
- Security page 45
- Streaming page 25
- System page 20, 43, 47-48
- Tracking page 26, 28-30, 32-39, 41
- video camera, accessing 21

weight 62

RoboTRAK, RoboSHOT, and Vaddio are trademarks or registered trademarks of Vaddio. All other trademarks in this document are the property of their respective owners.

Copyright © 2016 Vaddio. All rights reserved.

Vaddio

131 Cheshire Ln., Suite 500

Minnetonka, MN 55305

The logo for Vaddio, featuring the word "vaddio" in a bold, blue, lowercase sans-serif font. The letter "o" is stylized as a circle with a smaller solid circle inside it, resembling an eye or a camera lens.