

# RoboTRAK IR Source Lanyard

999-7271-000 Lanyard, North America  
999-7271-001 Lanyard, Europe and UK  
999-7271-009 Lanyard, Australia and New Zealand  
999-7272-000 Extended Lanyard, North America  
999-7272-001 Extended Lanyard, Europe and UK  
999-7272-009 Extended Lanyard, Australia and New Zealand



999-7271-000/001/009





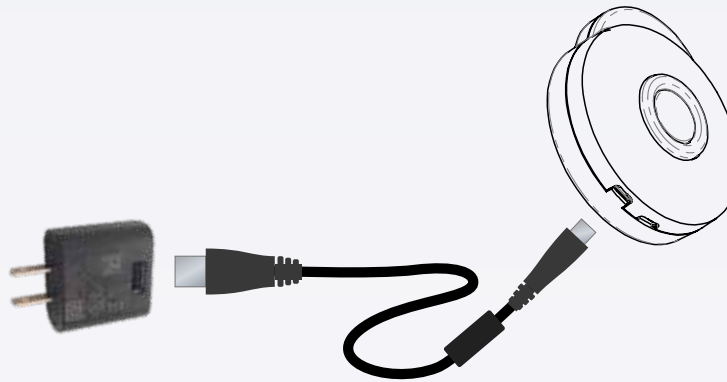
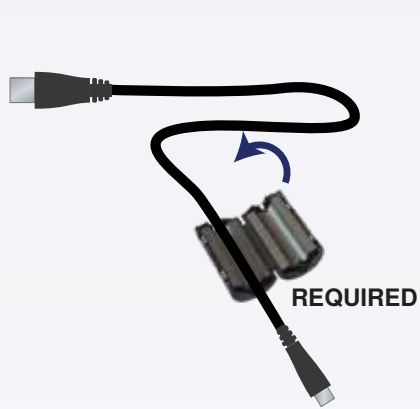

999-7272-000/001/009

## What's in the box





-  On
-  Battery Low
-  Charging
-  Battery Fault

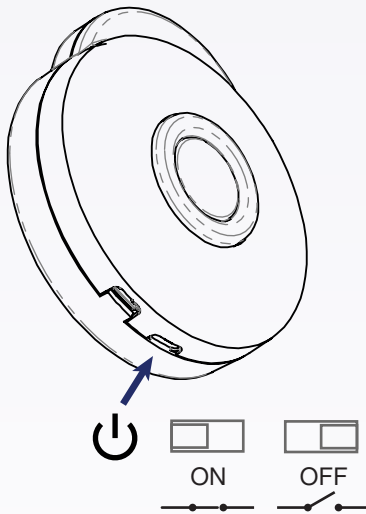

Ribbon contains electronic components.  
Do not fold or bend at the medallion.

Document 342-1257 Rev C  
November 2018

Vaddio is a brand of Milestone AV Technologies · [www.vaddio.com](http://www.vaddio.com) · Phone 800.572.2011 / +1.763.971.4400 · Fax +1.763.971.4464 · Email [info@vaddio.com](mailto:info@vaddio.com)

Visit us at [support.vaddio.com](http://support.vaddio.com) for firmware updates, specifications, drawings, manuals, technical support information, and more.

Vaddio and AV Bridge are trademarks or registered trademarks of Milestone AV Technologies. All other brand names or marks are used for identification purposes and are trademarks of their respective owners. In British Columbia, Milestone AV Technologies ULC carries on business as MAVT Milestone AV Technologies ULC.

©2018 Milestone AV Technologies.

MILESTONE IS NOW LEGRAND  
AV Brands Chief | Da-Lite | Middle Atlantic | Projecta | Sanus | Vaddio  
A brand of  **legrand**

**vaddio**