



DisplayPort / HDMI / VGA Switch with HDBaseT Transmitter

VE3912T User Manual



www.aten.com

EMC Information

FEDERAL COMMUNICATIONS COMMISSION INTERFERENCE

STATEMENT: This equipment has been tested and found to comply with the limits for a Class A digital device, pursuant to Part 15 of the FCC Rules. These limits are designed to provide reasonable protection against harmful interference when the equipment is operated in a commercial environment. This equipment generates, uses, and can radiate radio frequency energy and, if not installed and used in accordance with the instruction manual, may cause harmful interference to radio communications. Operation of this equipment in a residential area is likely to cause harmful interference in which case the user will be required to correct the interference at his own expense.

FCC Caution: Any changes or modifications not expressly approved by the party responsible for compliance could void the user's authority to operate this equipment.

Warning: Operation of this equipment in a residential environment could cause radio interference.

This device complies with Part 15 of the FCC Rules. Operation is subject to the following two conditions:

- (1) this device may not cause harmful interference, and
- (2) this device must accept any interference received, including interference that may cause undesired operation.

Suggestion: Shielded twisted pair (STP) cables must be used with the unit to ensure compliance with FCC & CE standards.

Achtung: Der Gebrauch dieses Geräts in Wohnumgebung kann Funkstörungen verursachen.

KCC Statement:

유선 제품용 / A 급 기기 (업무용 방송 통신 기기)

이 기기는 업무용 (A 급) 전자파적합기기로서 판매자 또는 사용자는 이 점을 주의하시기 바라며, 가정 외의 지역에서 사용하는 것을 목적으로 합니다.

RoHS

This product is RoHS compliant.



© Copyright 2021 ATEN® International Co., Ltd.
Released Date: 2021-01-14

ATEN and the ATEN logo are registered trademarks of ATEN International Co., Ltd. All rights reserved. All other brand names and trademarks are the registered property of their respective owners. The terms HDMI, HDMI High-Definition Multimedia Interface, and the HDMI Logo are trademarks or registered trademarks of HDMI Licensing Administrator, Inc.

User Information

Online Registration

Be sure to register your product at our online support center:

International	http://eservice.aten.com
---------------	---

Telephone Support

For telephone support, call this number:

International	886-2-8692-6959
China	86-400-810-0-810
Japan	81-3-5615-5811
Korea	82-2-467-6789
North America	1-888-999-ATEN ext 4988 1-949-428-1111

User Notice

All information, documentation, and specifications contained in this manual are subject to change without prior notification by the manufacturer. The manufacturer makes no representations or warranties, either expressed or implied, with respect to the contents hereof and specifically disclaims any warranties as to merchantability or fitness for any particular purpose. Any of the manufacturer's software described in this manual is sold or licensed as *is*. Should the programs prove defective following their purchase, the buyer (and not the manufacturer, its distributor, or its dealer), assumes the entire cost of all necessary servicing, repair and any incidental or consequential damages resulting from any defect in the software.

The manufacturer of this system is not responsible for any radio and/or TV interference caused by unauthorized modifications to this device. It is the responsibility of the user to correct such interference.

The manufacturer is not responsible for any damage incurred in the operation of this system if the correct operational voltage setting was not selected prior to operation. PLEASE VERIFY THAT THE VOLTAGE SETTING IS CORRECT BEFORE USE.

Package Contents

- ◆ 1 VE3912T DisplayPort / HDMI / VGA Switch with HDBaseT Transmitter
- ◆ 1 RS-232 Terminal Block
- ◆ 1 Power Adapter
- ◆ 4 Foot Pads
- ◆ 1 User Instructions

-
- Note:**
1. Check to make sure that all the components are present and that nothing got damaged in shipping. If you encounter a problem, contact your dealer.
 2. Read this manual thoroughly and follow the installation and operation procedures carefully to prevent any damage to the unit, and/or any of the devices connected to it.
-

Table of Contents

EMC Information	ii
RoHS	ii
User Information	iii
Online Registration	iii
Telephone Support	iii
User Notice	iii
Package Contents	iv
About this Manual	vii
Conventions	viii
Product Information	ix

1. Introduction

Overview	1
Features	2
Planning the Installation	3
Requirements	3
Considerations	3
Compatible ATEN Video Extenders	3
Components	4
VE3912T Front View	4
VE3912T Rear View	5
VE3912T Top View	6

2. Hardware Setup

Mounting the VE3912T Unit	7
Wall Mounting	7
Rack Mounting	7
Connecting the VE3912T Unit	8
RS-232 Channel Transmission	10

3. Operation

Selecting the Input Mode	11
Input Modes	11
Source Switch Pushbutton	12
RS-232 Serial Transmission	13
Bypass	13
Command	13
Long Reach Mode	15

Appendix

Safety Instructions	17
General	17
Rack Mounting	19

Technical Support	20
International	20
North America	20
Specifications	21
Supported VGA Resolutions	23
Limited Warranty	24

About this Manual

This user manual is provided to help you get the most from the VE3912T unit. It covers all aspects of installation, configuration, and operation. An overview of the information found in the manual is provided below.

Chapter 1, *Introduction* introduces you to the DisplayPort / HDMI / VGA Switch with HDBaseT Transmitter. Its purpose, features, installation considerations, and panel components are presented and described.

Chapter 2, *Hardware Setup* describes the steps that are necessary to quickly and safely set up your installation.

Chapter 3, *Operation* explains the Long Reach Mode and limitations, and how to set up the input detection mode using the a pushbutton and RS-232 commands.

An *Appendix* provides a list of safety instructions and precautions, contact information for ATEN technical support, product specifications, and other technical information.

Note:

- ◆ Read this manual thoroughly and follow the installation and operation procedures carefully to prevent any damage to the unit or any connected devices.
 - ◆ ATEN regularly updates its product documentation for new features and fixes. For an up-to-date VE3912T documentation, visit <http://www.aten.com/global/en/>
-

Conventions

This manual uses the following conventions:

- | | |
|---|--|
| Monospaced | Indicates text that you should key in. |
| [] | Indicates keys you should press. For example, [Enter] means to press the Enter key. If keys need to be chorded, they appear together in the same bracket with a plus sign between them: [Ctrl+Alt]. |
| 1. | Numbered lists represent procedures with sequential steps. |
| ◆ | Bullet lists provide information, but do not involve sequential steps. |
| → | Indicates selecting the option (on a menu or dialog box, for example), that comes next. For example, Start → Run means to open the <i>Start</i> menu, and then select <i>Run</i> . |
|  | Indicates critical information. |

Product Information

For information about all ATEN products and how they can help you connect without limits, visit ATEN on the Web or contact an ATEN Authorized Reseller. Visit ATEN on the Web for a list of locations and telephone numbers:

International	http://www.aten.com
North America	http://www.aten-usa.com

This Page Intentionally Left Blank

Chapter 1

Introduction

Overview

The ATEN VE3912T is an HDBaseT transmitter that extends 4K DisplayPort, HDMI, or VGA video signals up to 100m over a single Cat 6/6a or ATEN 2L-2910 Cat 6 cable. Featuring multiple video input formats and output resolutions up to 4K, it ensures a superior video quality for applications that require digital/analog sources conversion and extension.

This HDCP 2.2compliant transmitter meets the HDMI specification, including 3D, Deep Color, and 4Kx2K video quality. The Auto Switch Mode allows the VE3912T to automatically switchto a newly plugged-in source. With its built-in PoH (Power over HDBaseT) function, it can receive power from the HDBaseT output port on the connected device, eliminating the need for a power adapter. As a combination of extension and switch for both digital and analog inputs, VE3912T is recommended to be deployed in settings with multiple source inputs, such as conference rooms, digital educational environment or wherever integration and simplification are required.

Features

- ◆ Extends DisplayPort, HDMI or VGA signals up to 100 m over a single Cat 5e/6/6a or ATEN 2L-2910 Cat 6 cable
- ◆ Supports multiple source inputs (DisplayPort/HDMI/VGA) – easily switching among sources via a pushbutton
- ◆ Auto Switch Mode – allows the VE3912T to automatically switch to a newly plugged-in source
- ◆ HDMI (3D, Deep color, 4K); HDCP 2.2 compliant
- ◆ Superior video quality:
 - ◆ HDMI/DisplayPort: 4K at distance up to 100 m via a Cat 6a or ATEN 2L-2910 Cat 6 cable
 - ◆ VGA: 1600 x 1200 and 1920 x 1200 up to 100 m via a Cat 6a or ATEN 2L-2910 Cat 6 cable
- ◆ HDBaseT Long Reach Mode – up to 150 m via a single Cat 5e/6 cable at resolutions up to 1080p
- ◆ Mirrored video output – supports 4K @ 30Hz, 4:4:4 over the HDBaseT output, and full 4Kx2K @ 60Hz, 4:4:4 over the local HDMI output
- ◆ PoH (Power over HDBaseT) – with its built-in PoH function, it receives power from the HDBaseT output port on the connected device
- ◆ Perfect HDBaseT Compatibility – compatible with ATEN HDBaseT receivers, available to deliver crystal audio and video signals to DisplayPort/HDMI/VGA output port
- ◆ Features RS-232 Serial Communication Switch – Command mode and Bypass mode to meet application requirements, user can command input port switch through RS-232 of receiver, such as VE2812R
- ◆ EDID Expert™ – selects optimum EDID settings for high-quality display and use HDBaseT output as priority of optimum video resolution
- ◆ High-performance scaling – scales videos of different resolutions to their optimal output for display and to avoid black screen
- ◆ Plug-and-play with no software installation required
- ◆ Rack-mountable
- ◆ Built- in 8KV / 15 KV ESD protection

Planning the Installation

Requirements

Prepare the following before installing the VE3912T unit:

- ◆ 1 DisplayPort, HDMI, and/or VGA source device
- ◆ 1 Cat 5e/6/6a or ATEN 2L-2910 Cat 6 cable

Considerations

- ◆ To ensure video quality, ATEN recommends using a Cat 5e/6/6a cable.

Note: For best results, ATEN recommends using the ATEN 2L-2910 Cat 6 cable.

- ◆ The maximum transmission distance varies at different parts of the transmission:

Connection	Interface	Distance
Computer to the VE3912T	DisplayPort	3 m
	HDMI	3 m (True 4K) / 5 m
	VGA	10 m
The VE3912T to a compatible ATEN Video Extender	Cat 5e/6/6a	100 m / 150 m (up to 1080p in Long Reach Mode)
A compatible ATEN Video Extender to the display	HDMI	5 m

Compatible ATEN Video Extenders

The VE3912T is designed to work with a wide range of ATEN HDBaseT video extenders. Visit our official web site for more details.

Components

VE3912T Front View

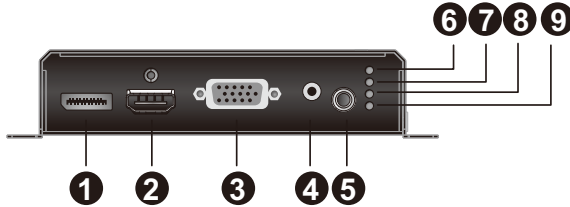

No.	Component	Description
1	DisplayPort Input Port	Connects to the DisplayPort Out port on the source device.
2	HDMI Input Port	Connects to the HDMI Out port on the source device.
3	VGA Input Port	Connects to the VGA Out port on the source device.
4	Audio Input	Connects to the Audio Out port on the source device.
5	Source Switch Pushbutton	Press to switch among the Auto Switch, DisplayPort, HDMI, and VGA input mode. The input mode status is indicated by the four LEDs to the right of this pushbutton. For details, see <i>VE3912T Top View</i> , page 6. To switch between Bypass Mode and Command mode, see <i>RS-232 Serial Transmission</i> , page 13.
6	Auto LED	Lights orange when the unit is set to the Auto Switch mode. For details, see <i>Selecting the Input Mode</i> , page 11.
7	DisplayPort LED	Lights orange when the unit is set to transmit DisplayPort input.
8	HDMI LED	Lights orange when the unit is set to transmit HDMI input.
9	VGA LED	Lights orange when the unit is set to transmit VGA input.

VE3912T Rear View

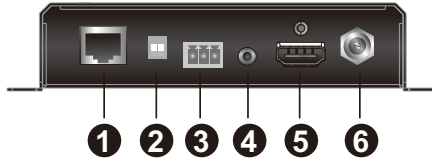

No.	Component	Description
1	HDBaseT Output Port	Connects to the HDBaseT Output port on a compatible ATEN video receiver via an RJ-45 cable.
2	HDBaseT Long Reach Mode Switch / Firmware Upgrade Switch	Put the switch to ON to enable the Long Reach Mode. For more details on Long Reach Mode, see <i>Long Reach Mode</i> , page 15. The firmware upgrade switch is reserved for ATEN Technical Support. If you would like to do a firmware upgrade yourself, please contact your dealer.
3	RS-232 Port	Connects to an RS-232 main controller, such as a PC or Control system.
4	IR Port	Connects to an IR transmitter/receiver.
5	HDMI Output Port	Connects to an HDMI-enabled display.
6	Power Jack	Connects to the Power Adapter.

VE3912T Top View

You can find the unit's LEDs on the top and front panel as illustrated below. See the table below for details on LED indication.

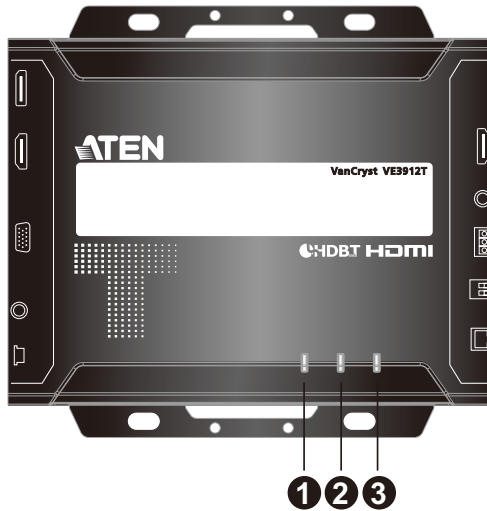

No.	LED	Indication	Description
1	DisplayPort / HDMI / VGA Input Status LED	Lights red	The DisplayPort signal is stable.
		Lights orange	The HDMI signal is stable.
		Lights green	The VGA signal is stable.
2	Link LED	Lights orange	The transmission to the receiver is stable.
		Blinks orange	The transmission to the receiver is unstable.
3	Power LED	Lights green	The unit is receiving power.

Note:

- ◆ The Power, Link, Auto Switch Mode, DisplayPort Mode, HDMI Mode, and VGA Mode LEDs blink at the same time to indicate that the firmware upgrade is in progress.
- ◆ Auto Switch Mode LED, DisplayPort Mode LED, HDMI Mode LED, and VGA Mode LED light and blink at the same time to indicate that the RS-232 mode is changed.

Chapter 2

Hardware Setup



1. Please review the safety information regarding the placement of this device in *Safety Instructions*, page 17.
2. Do not power on the VE3912T until all the necessary hardware is connected.

Mounting the VE3912T Unit

You can mount the VE3912T to the wall or on a rack.

Wall Mounting

Secure or hang the VE3912T unit to the wall using the built-in mounting brackets.

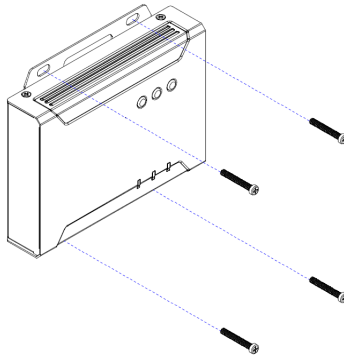

Rack Mounting

Use the VE-RMK 1U Rack Mount Kit to rack-mount the VE3912T. For more information about this accessory, go to www.aten.com/products

Connecting the VE3912T Unit

Follow the steps below to connect the VE3912T to a source, a compatible ATEN Video Extender, and other controls as required.

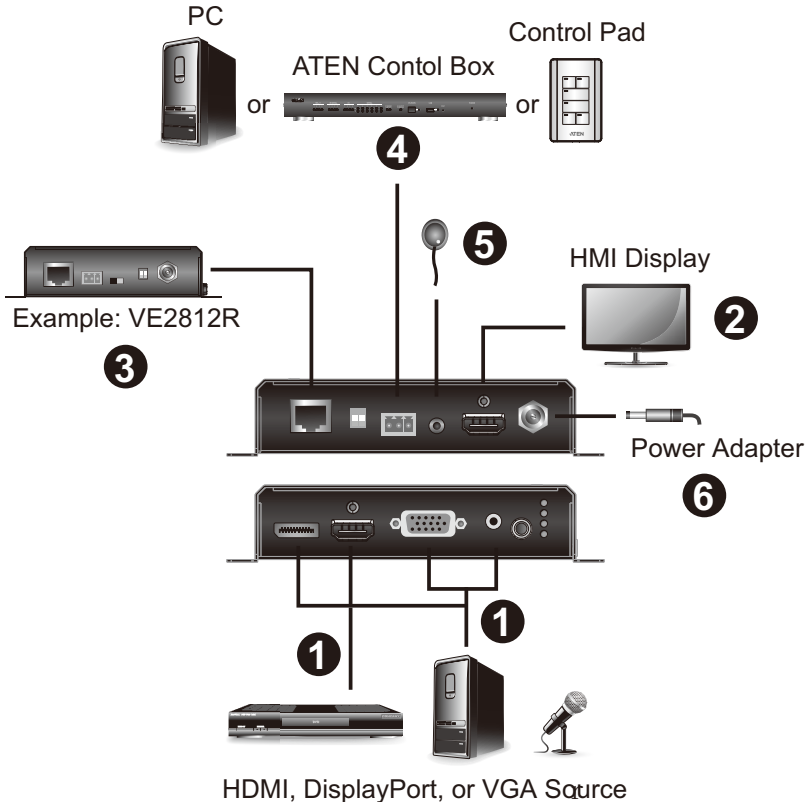

1. Connect the DisplayPort, HDMI, and/or VGA Input Port on the VE3912T to the DisplayPort, HDMI, and/or VGA sources using the required cables respectively. If VGA is connected, then you need to connect the VGA audio jack to the Audio Input on the VE3912T to transmit sound.

2. Connect the HDMI Output Port on the VE3912T to an HDMI-enabled display.
3. Connect an Ethernet cable to the HDBaseT Output port on the transmitter, and connect the other end to the HDBaseT input port on the receiver for transmission and power supply.

Note: This HDBaseT output port is PoH PD ready, therefore you can connect the PoH PSE ready device such as VP1421 for power delivery, and there is no need to plug power adapter to the VE3912T.

4. (Optional) Connect your computer or a control system to the terminal block on the VE3912T. The RS-232 Serial Port supports Command Mode and Bypass Mode, see *RS-232 Serial Transmission*, page 13.
 - ◆ To control the VE2812R using an ATEN Control System/Control Pad, connect a Control Box/Control Pad to the VE3912T's RS-232 Serial port and then put the RS-232 Serial Communication Switch to **Command**.

Note: By default, the VE3912T is set to **Command** mode.

- ◆ To bypass RS-232 serial control signals to a PC or a serial device, connect the PC or serial device (e.g. touch pad) to the VE3912T's RS-232 Serial port and put the RS-232 Serial Communication Switch to Bypass.
5. (Optional) To receive IR signals to remotely control a device (e.g. blu-ray disc) connected to the video receiver, connect an IR emitter to the VE3912T's IR Port and an IR receiver to the VE2812R's IR Port or vice versa.

Note: To purchase an IR emitter and an IR remote control, contact your local sales representative for more information.

6. (Optional) Plug the power adapter cable into the Power Jack for additional power supply.

Note: The VE3912T prioritizes the power supply from the power adapter when the Power Adapter is plugged in.

RS-232 Channel Transmission

You can manage the VE3912T via RS-232 serial devices, such as computers or bar code scanners. The RS-232 signal transmission flow can be illustrated as follows:

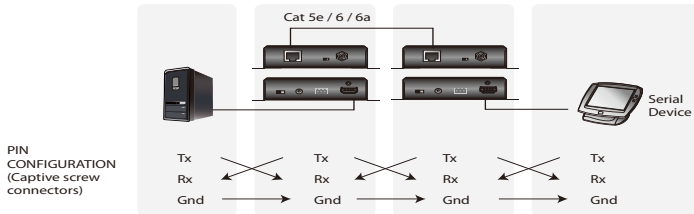

From a source device, the RS-232 signal is transmitted (Tx) to the VE3912T receiving (Rx) unit; the a compatible ATEN Video Receiver transmits (Tx) signals to the display device (Rx).

You can set the VE3912T to either bypass serial data or to receive RS-232 commands. By default, the VE3912T is set to receive serial data. To set the unit to bypass RS-232 commands, press the Input Switch pushbutton for 3 seconds. For details on RS-232 commands, see *RS-232 Serial Transmission*, page 13.

Chapter 3

Operation

Selecting the Input Mode

Input Modes

You can switch among different input modes based on your needs. Refer to the table below for how each mode works. The default setting is Auto Switch.

Input Mode	Description
Auto Switch (LED lights orange)	<ul style="list-style-type: none">◆ Before power on, the VE3912T prioritizes HDMI transmission if all three DisplayPort, HDMI and VGA inputs are plugged in at the same time.◆ After power on, the VE3912T prioritizes the latest detected input source transmission to the connected receiver. <p>Note: You can disable this part of the Auto Switch mode (automatic input switching) using an RS-232 command. For more details, see <i>Command</i>, page 13.</p>
DisplayPort (LED lights orange)	The VE3912T only transmits DisplayPort source to the connected receiver.
HDMI (LED lights orange)	The VE3912T only transmits HDMI source to the connected receiver.
VGA (LED lights orange)	The VE3912T only transmits VGA source and its audio input to the connected receiver.

Source Switch Pushbutton

Press the **Source Switch Pushbutton** located on the front panel to switch among the Auto Switch, DisplayPort, HDMI, and VGA input mode.

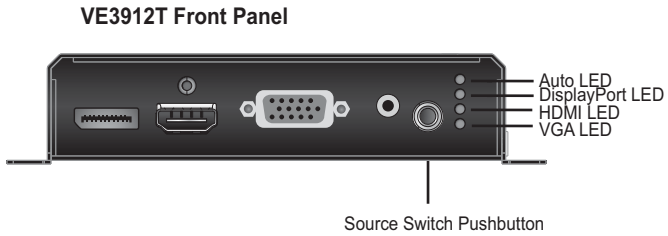

RS-232 Serial Transmission

The RS-232 Serial Transmission allows you to choose whether to bypass serial data or to remotely control the VE3912T using commands depending on your installation.

To switch the VE3912T RS-232 mode, do the following:

1. Press the Source Switch Pushbutton for 5 seconds as shown in the diagram below.

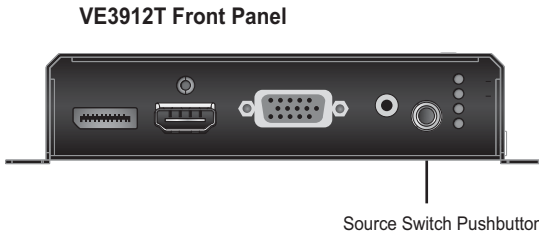

- ◆ Bypass mode: the Auto LED, DisplayPort LED, HDMI LED, and VGA LED light orange and blink once per second for three seconds.
- ◆ **Command mode:** the Auto LED, DisplayPort LED, HDMI LED, and VGA LED light orange and blink once every 0.3 seconds for three seconds.

Note: 1. By default, the VE3912T is set to **Command** mode.

2. The RS-232 status is kept even VE3912T is powered on and off.
For detailed LEDs behavior, see *VE3912T Top View*, page 6.

Bypass

RE-232 serial data is bypassed from the controller PC or Pad to other connected devices.

Command

You can change the input mode using RS-232 commands. Refer to the table below for a list of available tasks and the corresponding commands.

Type the corresponding command to execute a task. For example, to enable automatic input switching, type **swmode plugin auto** and then press **[Enter]**.

Task	Command		
	Control	Input	Port
Enables automatic input switching	swmode plugin auto	N/A	N/A
Disables automatic input switching	swmode plugin off	N/A	N/A
Enables automatic plug-out switching	swmode plugout prev	N/A	N/A
Disables automatic plug-out switching	swmode plugout off	N/A	N/A
Enables HDMI scaling. HDMI local output: video resolution up to 4Kx2K @ 60Hz (4:4:4). HDBaseT output: video resolution downscaled to 1920 x 1080 @ 60Hz.	scaling o02 hor 1920 ver 1080	N/A	N/A
Disables HDMI scaling. HDMI local output: video resolution up to 4Kx2K @ 30 Hz (4:4:4). HDBaseT output: video resolution up to 4Kx2K @ 30 Hz (4:4:4).	scaling o02 off	N/A	N/A
Switches the unit to the DisplayPort Mode	sw	N/A	N/A
Sets the unit to the DisplayPort mode	sw	i	01
Sets the unit to the HDMI mode	sw	i	02
Sets the unit to the VGA mode	sw	i	03
Views the current input mode settings	read	N/A	N/A

Note:

- ◆ Press **[Enter]** to execute a command.
- ◆ The current input mode setting is also indicated by the Auto Switch, HDMI, and VGA LEDs.
- ◆ The automatic input switching is enabled by default.
- ◆ The automatic plug-out switching is enabled by default.
- ◆ The HDMI scaling is disabled by default.

Long Reach Mode

Long Reach Mode is a modulation that extends the transmission distance up to 150 m using a Cat 5e/6 cable while compromising the maximum frame rate to 1080p, 24 bpp, 60 Hz via a single Cat 5e/6 cable. To enable Long Reach Mode, put the HDBaseT Long Reach Mode Switch to **ON** at either the transmitter or the connected receiver.

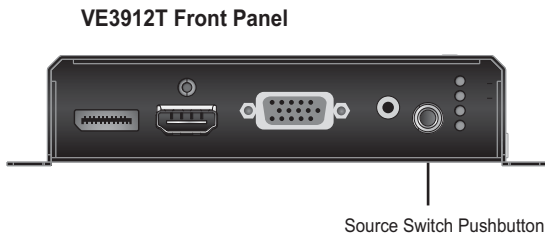

Note: When Long Reach Mode is enabled, the VE3912T will not be able to transmit 4K signals, in which case, the output display will be blank.

This Page Intentionally Left Blank

Safety Instructions

General

- ◆ This product is for indoor use only.
- ◆ Read all of these instructions. Save them for future reference.
- ◆ Follow all warnings and instructions marked on the device.
- ◆ Do not place the device on any unstable surface (cart, stand, table, etc.). If the device falls, serious damage will result.
- ◆ Do not use the device near water.
- ◆ Do not place the device near, or over, radiators or heat registers.
- ◆ The device cabinet is provided with slots and openings to allow for adequate ventilation. To ensure reliable operation, and to protect against overheating, these openings must never be blocked or covered.
- ◆ The device should never be placed on a soft surface (bed, sofa, rug, etc.) as this will block its ventilation openings. Likewise, the device should not be placed in a built in enclosure unless adequate ventilation has been provided.
- ◆ Never spill liquid of any kind on the device.
- ◆ Unplug the device from the wall outlet before cleaning. Do not use liquid or aerosol cleaners. Use a damp cloth for cleaning.
- ◆ The device should be operated from the type of power source indicated on the marking label. If you are not sure of the type of power available, consult your dealer or local power company.
- ◆ To prevent damage to your installation it is important that all devices are properly grounded.
- ◆ Do not allow anything to rest on the power cord or cables. Route the power cord and cables so that they cannot be stepped on or tripped over.
- ◆ Position system cables and power cables carefully; Be sure that nothing rests on any cables.
- ◆ Never push objects of any kind into or through cabinet slots. They may touch dangerous voltage points or short out parts resulting in a risk of fire or electrical shock.
- ◆ Do not attempt to service the device yourself. Refer all servicing to qualified service personnel.
- ◆ If the following conditions occur, unplug the device from the wall outlet and bring it to qualified service personnel for repair.

- ◆ The power cord or plug has become damaged or frayed.
- ◆ Liquid has been spilled into the device.
- ◆ The device has been exposed to rain or water.
- ◆ The device has been dropped, or the cabinet has been damaged.
- ◆ The device exhibits a distinct change in performance, indicating a need for service.
- ◆ The device does not operate normally when the operating instructions are followed.
- ◆ Only adjust those controls that are covered in the operating instructions. Improper adjustment of other controls may result in damage that will require extensive work by a qualified technician to repair.

Rack Mounting

- ◆ Before working on the rack, make sure that the stabilizers are secured to the rack, extended to the floor, and that the full weight of the rack rests on the floor. Install front and side stabilizers on a single rack or front stabilizers for joined multiple racks before working on the rack.
- ◆ Always load the rack from the bottom up, and load the heaviest item in the rack first.
- ◆ Make sure that the rack is level and stable before extending a device from the rack.
- ◆ Use caution when pressing the device rail release latches and sliding a device into or out of a rack; the slide rails can pinch your fingers.
- ◆ After a device is inserted into the rack, carefully extend the rail into a locking position, and then slide the device into the rack.
- ◆ Do not overload the AC supply branch circuit that provides power to the rack. The total rack load should not exceed 80 percent of the branch circuit rating.
- ◆ Make sure that all equipment used on the rack – including power strips and other electrical connectors – is properly grounded.
- ◆ Ensure that proper airflow is provided to devices in the rack.
- ◆ Ensure that the operating ambient temperature of the rack environment does not exceed the maximum ambient temperature specified for the equipment by the manufacturer.
- ◆ Do not step on or stand on any device when servicing other devices in a rack.

Technical Support

International

- ◆ For online technical support – including troubleshooting, documentation, and software updates: <http://support.aten.com>
- ◆ For telephone support, see *Telephone Support*, page iv:

North America

Email Support		support@aten-usa.com
Online Technical Support	Troubleshooting Documentation Software Updates	http://www.aten-usa.com/support
Telephone Support		1-888-999-ATEN ext 4988

When you contact us, please have the following information ready beforehand:

- ◆ Product model number, serial number, and date of purchase
- ◆ Your computer configuration, including operating system, revision level, expansion cards, and software
- ◆ Any error messages displayed at the time the error occurred
- ◆ The sequence of operations that led up to the error
- ◆ Any other information you feel may be of help

Specifications

Function	VE3912T
Video Input	
Interfaces	1 x HDMI Type A Female (Black) 1 x HDB-15 (VGA) Male (Blue) 1 x DisplayPort Female (Black)
Impedance	HDMI: 100 Ω HDB-15 (VGA): 75 Ω DisplayPort: 100 Ω
Max. Distance	DisplayPort: 3 m HDMI: 3 m (True 4K) / 5 m VGA: 10 m
Video Output	
Interfaces	1 x HDMI Type A Female (Black)
Impedance	100 Ω
Video	
Max. Data Rate	10.2 Gbps (3.4 Gbps per lane)
Max. Pixel Clock	340 MHz
Compliance	HDMI (3D, Deep Color, 4K)
	HDCP Compatible
	Consumer Electronics Control (CEC)
Max. Resolutions	HDMI Local Output: 4Kx2K @ 60Hz (4:4:4) HDBaseT Output: 4Kx2K @ 60Hz (4:2:0) / 4Kx2K @ 60Hz (4:4:4)
Max. Resolutions / Distances	HDMI/DisplayPort: <ul style="list-style-type: none"> ◆ Up to 4k @70m (Cat 5e/6) / 100m (Cat 6a/ATEN 2L-2910 Cat6) ◆ Up to 1080p @100m (Cat 5e/6/6a) VGA: <ul style="list-style-type: none"> ◆ Up to 1920 x 1200 & 1600 x 1200 @70m (Cat 5e/6) / 100m (Cat 6a/ATEN 2L-2910 Cat 6) ◆ Up to 1920 x 1080 @100m (Cat 5e/6/6a) 4k supported: <ul style="list-style-type: none"> ◆ 4096 x 2160 / 3840 x 2160 @60Hz (4:2:0) ◆ 4096 x 2160 / 3840 x 2160 @30Hz (4:4:4)
Audio	
Input	1 x HDMI Type A Female (Black) 1 x Mini Stereo Jack Female (Green) 1 x DisplayPort Female (Black)

Function		VE3912T
Connectors		
Unit To Unit		1 x RJ-45 Female
Power		1 x DC Jack (Black) with locking or, 1 x RJ-45 Female (PoE)
Control		
RS-232	Connector	1 x Terminal Block, 3 Pole; Type: DTE
	Baud Rate	115200
	Data Bits	8
	Stop Bits	1, no parity and flow control
IR		1 x Mini Stereo Jack Female (Black)
Switches		
Video Input Port Selection		1 x Pushbutton - HDMI, VGA, DisplayPort, and AUTO
Long Reach Mode Switch		1 Slide Switch - ON/OFF
Firmware Upgrade		1 Slide Switch - ON/OFF
Power		
Consumption		DC 5V; 7.02W; 40BTU DC48V; 8.77W; 48BTU
Environmental		
Operating Temperature		0 - 40°C
Storage Temperature		-20 - 60°C
Humidity		0 x 80% RH, Non-Condensing
Physical Properties		
Housing		Metal
Weight		0.65 Kg (1.43 lb)
Dimensions (L x W x H) with Bracket		17.29 x 14.69 x 3.00 cm (6.81 x 5.78 x 1.18 in.)
Dimensions (L x W x H) without Bracket		16.60 x 12.49 x 2.90 cm (6.54 x 4.92 x 1.14 in.)

Supported VGA Resolutions

The VE3912T supports the following VGA resolutions:

VGA Resolution	Frame Rate (Hz)
640 x 480	60
640 x 480	75
800 x 600	60
800 x 600	75
1024 x 768	60
1024 x 768	75
1152 x 864	60
1152 x 864	75
1280 x 600	60
1280 x 720	60
1280 x 768	60
1280 x 800	60
1280 x 800	75
1280 x 960	60
1280 x 1024	60
1280 x 1024	75
1360 x 768	60
1366 x 768	60
1400 x 1050	60
1440 x 900	60
1600 x 900	60
1600 x 1200	60
1680 x 1050	60
1920 x 1080	60

Limited Warranty

ATEN warrants its hardware in the country of purchase against flaws in materials and workmanship for a Warranty Period of two [2] years (warranty period may vary in certain regions/countries) commencing on the date of original purchase. This warranty period includes the [LCD panel of ATEN LCD KVM switches](#). Select products are warranted for an additional year (see [A+ Warranty](#) for further details). Cables and accessories are not covered by the Standard Warranty.

What is covered by the Limited Hardware Warranty

ATEN will provide a repair service, without charge, during the Warranty Period. If a product is defective, ATEN will, at its discretion, have the option to (1) repair said product with new or repaired components, or (2) replace the entire product with an identical product or with a similar product which fulfills the same function as the defective product. Replaced products assume the warranty of the original product for the remaining period or a period of 90 days, whichever is longer. When the products or components are replaced, the replacing articles shall become customer property and the replaced articles shall become the property of ATEN.

To learn more about our warranty policies, please visit our website: <http://www.aten.com/global/en/legal/policies/warranty-policy/>