

R&S® ZNL VECTOR NETWORK ANALYZER

Specifications

3
year
warranty



Data Sheet
Version 05.00

ROHDE & SCHWARZ

Make ideas real



CONTENTS

Definitions	3
Specifications.....	4
Measurement range	4
Measurement speed.....	5
Measurement accuracy	6
Effective system data.....	7
Factory-calibrated system data.....	7
Test port output	8
Test port input	9
Display	10
Front panel connectors	10
Rear panel connectors.....	10
Options	11
R&S®ZNL3-B1, R&S®ZNL4-B1 and R&S®ZNL6-B1 spectrum analysis	11
<i>Input</i>	11
<i>Frequency</i>	11
<i>Sweep time</i>	12
<i>Resolution bandwidths</i>	12
<i>Level</i>	13
<i>Measurement speed</i>	14
<i>Trigger functions</i>	15
<i>I/Q data</i>	15
R&S®ZNL3-B22, R&S®ZNL4-B22 and R&S®ZNL6-B22 extended power range	15
R&S®ZNL3-B31/-B32, R&S®ZNL4-B31/-B32 and R&S®ZNL6-B31/-B32 receiver step attenuators	15
R&S®FPL1-B5 additional interfaces	16
R&S®FPL1-B4 precision frequency reference (OCXO)	16
R&S®FPL1-B10 GPIB interface	16
R&S®FPL1-B30 DC power input 12 V/24 V.....	17
R&S®FPL1-B31 internal lithium-ion battery	17
R&S®FSV-B34 charger (only necessary to charge spare batteries)	17
General data	18
Dimensions (in mm).....	19
Ordering information	20
Recommended extras.....	20
Power sensors supported by the R&S®FPL1-K9 option	21

Definitions

General

Product data applies under the following conditions:

- Three hours storage at ambient temperature followed by 30 minutes warm-up operation
- Specified environmental conditions met
- Recommended calibration interval adhered to
- All internal automatic adjustments performed, if applicable

Specifications with limits

Represent warranted product performance by means of a range of values for the specified parameter. These specifications are marked with limiting symbols such as $<$, \leq , $>$, \geq , \pm , or descriptions such as maximum, limit of, minimum. Compliance is ensured by testing or is derived from the design. Test limits are narrowed by guard bands to take into account measurement uncertainties, drift and aging, if applicable.

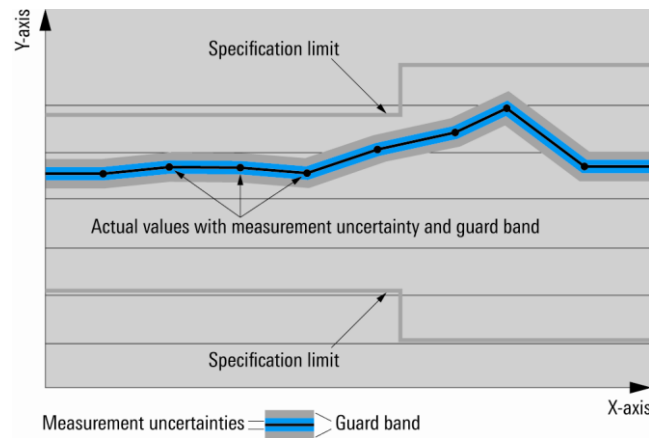

Specifications without limits

Represent warranted product performance for the specified parameter. These specifications are not specially marked and represent values with no or negligible deviations from the given value (e.g. dimensions or resolution of a setting parameter). Compliance is ensured by design.

Typical data (typ.)

Characterizes product performance by means of representative information for the given parameter. When marked with $<$, $>$ or as a range, it represents the performance met by approximately 80 % of the instruments at production time. Otherwise, it represents the mean value.

Nominal values (nom.)

Characterize product performance by means of a representative value for the given parameter (e.g. nominal impedance). In contrast to typical data, a statistical evaluation does not take place and the parameter is not tested during production.

Measured values (meas.)

Characterize expected product performance by means of measurement results gained from individual samples.

Uncertainties

Represent limits of measurement uncertainty for a given measurand. Uncertainty is defined with a coverage factor of 2 and has been calculated in line with the rules of the Guide to the Expression of Uncertainty in Measurement (GUM), taking into account environmental conditions, aging, wear and tear.

Device settings and GUI parameters are indicated as follows: "parameter: value".

Typical data as well as nominal and measured values are not warranted by Rohde & Schwarz.

Specifications

Measurement range

Impedance		50 Ω
Test port connector		N female
Number of test ports		2
Frequency range ¹	R&S®ZNL3	5 kHz to 3 GHz
	R&S®ZNL4	5 kHz to 4.5 GHz
	R&S®ZNL6	5 kHz to 6 GHz

Static frequency accuracy		(time since last adjustment \times aging rate) + temperature drift + calibration accuracy
Aging per year	standard	$\pm 1 \times 10^{-6}$
	with R&S®FPL-B4 precision frequency reference option	$\pm 1 \times 10^{-7}$
Temperature drift (+5 °C to +40 °C)	standard	$\pm 1 \times 10^{-6}$
	with R&S®FPL-B4 precision frequency reference option	$\pm 1 \times 10^{-8}$
Achievable initial calibration accuracy	standard	$\pm 5 \times 10^{-7}$
	with R&S®FPL-B4 precision frequency reference option	$\pm 5 \times 10^{-8}$

Frequency resolution		1 Hz
Number of measurement points	per trace	1 to 100 001
Measurement bandwidth	1/1.5/2/3/5/7 steps	1 Hz to 500 kHz

		specification	typical
Dynamic range ^{1, 2}	5 kHz to 100 kHz	> 85 dB	110 dB
	100 kHz to 10 MHz	> 100 dB	120 dB
	10 MHz to 50 MHz	> 110 dB	120 dB
	50 MHz to 4.5 GHz	> 120 dB	130 dB
	4.5 GHz to 6 GHz	> 115 dB	125 dB

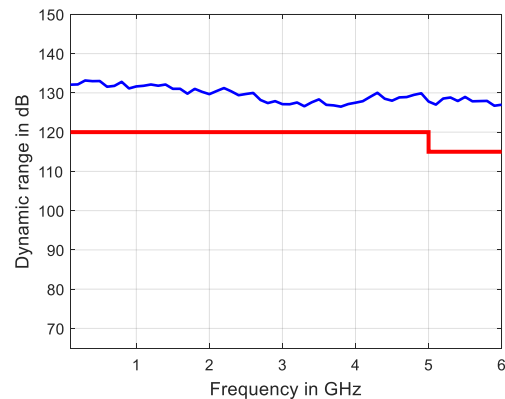
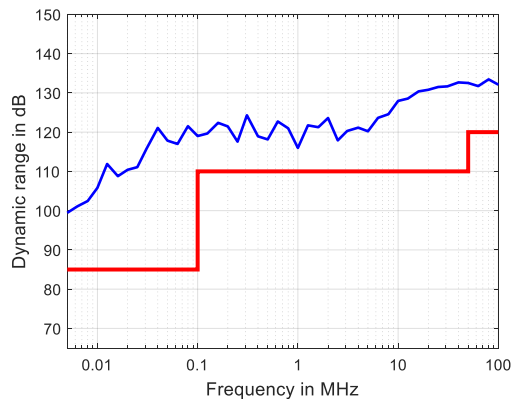

Dynamic range in dB versus frequency for the R&S®ZNL

¹ Specified and typical data given in this data sheet applies to the R&S®ZNL3, R&S®ZNL4 and R&S®ZNL6; please note their respective frequency ranges.

² The dynamic range is defined as the difference between 0 dBm source power and the RMS value of the data trace of the transmission magnitude, which is produced by noise and crosstalk with the test ports short-circuited. The specification applies at 10 Hz measurement bandwidth, without system error correction. The dynamic range can be increased by using a measurement bandwidth of 1 Hz.

Measurement speed

Measured with firmware version 1.00 and Windows 10, 64 bit.

Measurement time	for 201 measurements points, with 200 MHz span, 500 kHz measurement bandwidth			
	with 900 MHz center frequency	T_{SWEEP}	T_{CYCLE}	
Acquisition time per point (T_{ACQ})	500 kHz measurement bandwidth, CW mode	< 4.0 ms	< 5.0 ms	
Sampling time per point (T_{SAMPLE}) IF filter: normal	at 500 kHz measurement bandwidth	< 10 μ s		
Time for measurement and data transfer	for 201 measurements points, with 800 MHz start frequency, 1 GHz stop frequency, 500 kHz measurement bandwidth ³	IEC/IEEE	VXI11	HiSLIP
		meas. 10 ms	over 1 Gbit/s LAN	
Data transfer time	for 201 measurements points (magnitude)	meas. 3 ms	meas. 2.5 ms	meas. 2.5 ms
Switching time between channels	with a maximum of 2001 points	< 5 ms		
Switching time between two preloaded instrument settings	with a maximum of 2001 points	< 5 ms		

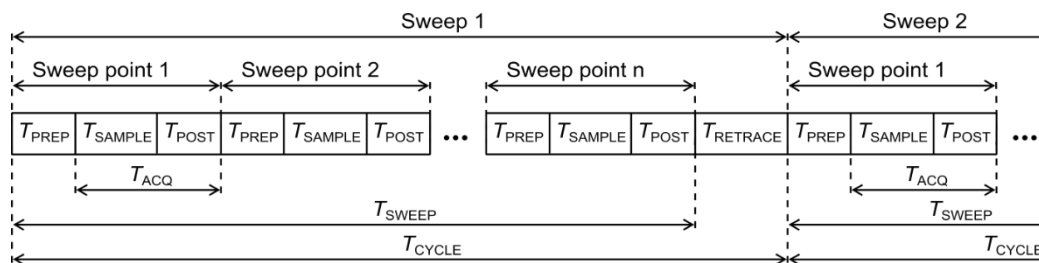

T_{PREP}	Preparation time required to set up the internal hardware components
T_{SAMPLE}	Sampling time (approximately equal to the settling time of the digital filters)
T_{POST}	Time required for hardware postprocessing
T_{ACQ}	Acquisition time ($T_{\text{SAMPLE}} + T_{\text{POST}}$)
T_{SWEEP}	Time required for one sweep
T_{RETRACE}	Time between two sweeps
T_{CYCLE}	Sweep cycle time ($T_{\text{SWEEP}} + T_{\text{RETRACE}}$)

Measurement sequence

Typical sweep times versus number of measurement points ^{1, 4}					
Number of measurement points	51	201	401	1601	5001
800 MHz start frequency, 1 GHz stop frequency, 100 kHz measurement bandwidth					
With correction switched off	2.4 ms	4.9 ms	8.7 ms	31.2 ms	94 ms
With 2-port TOSM calibration	3.9 ms	9.6 ms	16.7 ms	61.7 ms	189 ms
800 MHz start frequency, 1 GHz stop frequency, 1 kHz measurement bandwidth					
With correction switched off	66 ms	258 ms	515 ms	2055 ms	6400 ms
With 2-port TOSM calibration	132 ms	515 ms	1028 ms	4100 ms	12780 ms
100 MHz start frequency, 3 GHz stop frequency, 100 kHz measurement bandwidth					
With correction switched off	3.9 ms	9.1 ms	14.5 ms	36.7 ms	102 ms
With 2-port TOSM calibration	7.3 ms	17.7 ms	28.8 ms	73.3 ms	206 ms
100 MHz start frequency, 3 GHz stop frequency, 1 kHz measurement bandwidth					
With correction switched off	68 ms	262 ms	519 ms	2055 ms	6390 ms
With 2-port TOSM calibration	136 ms	524 ms	1040 ms	4110 ms	12800 ms
100 MHz start frequency, 6 GHz stop frequency, 100 kHz measurement bandwidth					
With correction switched off	3.9 ms	9.5 ms	15.4 ms	47 ms	104 ms
With 2-port TOSM calibration	7.3 ms	18.8 ms	30.5 ms	95 ms	209 ms
100 MHz start frequency, 6 GHz stop frequency, 1 kHz measurement bandwidth					
With correction switched off	68 ms	263 ms	521 ms	2070 ms	6400 ms
With 2-port TOSM calibration	136 ms	525 ms	1042 ms	4120 ms	12800 ms

³ In continuous mode, no additional time for data transfer is needed as this occurs simultaneously during the measurement.

⁴ Sweep time is to be understood as cycle time; static frequency accuracy of the instrument applies; measured with firmware version 1.00, Windows 10.

Measurement accuracy

This data is valid between +18 °C and +28 °C, provided the temperature has not varied by more than 1 °C since calibration. Validity of the data is conditional on the use of an R&S®ZV-Z270 calibration kit and TOSM/SOLT calibration. This calibration kit is used to achieve the effective system data specified below. Frequency points, measurement bandwidth and sweep time have to be identical for measurement and calibration (no interpolation allowed).

Accuracy of transmission measurements		
Above 5 kHz	+5 dB to -35 dB	< 0.05 dB or < 0.5°
	-35 dB to -50 dB	< 0.1 dB or < 1°
	-50 dB to -65 dB	< 0.2 dB or < 2°
Specifications are based on a matched DUT, a measurement bandwidth of 10 Hz and a nominal source power of -10 dBm.		

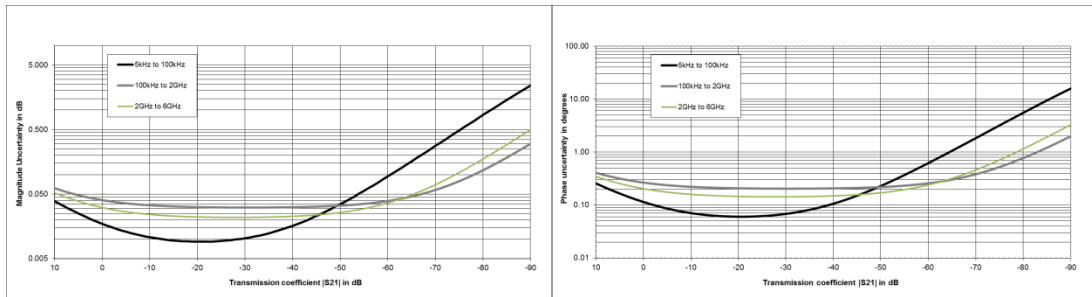

Typical accuracy of transmission magnitude and transmission phase measurements for the R&S®ZNL 1; analysis conditions: $S_{11} = S_{22} = 0$, calibrated power -10 dBm, measured power -10 dBm

Accuracy of reflection measurements	logarithmic			linear	
		magnitude	phase		magnitude
100 kHz to 2 GHz	0 dB	≤ 0.12 dB	≤ 0.8°	0 dB to -3 dB	0.014
	-3 dB	≤ 0.12 dB	≤ 0.8°	< -3 dB to -6 dB	0.009
	-6 dB	≤ 0.12 dB	≤ 0.8°	< -6 dB to -15 dB	0.007
	-15 dB	≤ 0.30 dB	≤ 2.0°	< -15 dB to -25 dB	0.006
	-25 dB	≤ 0.90 dB	≤ 6.0°	< -25 dB to -35 dB	0.006
2 GHz to 6 GHz	0 dB	≤ 0.20 dB	≤ 1.3°	0 dB to -3 dB	0.024
	-3 dB	≤ 0.20 dB	≤ 1.3°	< -3 dB to -6 dB	0.016
	-6 dB	≤ 0.23 dB	≤ 1.5°	< -6 dB to -15 dB	0.013
	-15 dB	≤ 0.60 dB	≤ 4.0°	< -15 dB to -25 dB	0.012
	-25 dB	≤ 1.70 dB	≤ 13°	< -25 dB to -35 dB	0.012
	-35 dB	≤ 4.50 dB	≤ 42°		

Specifications are based on an isolating DUT, a measurement bandwidth of 10 Hz and a nominal source power of -10 dBm.

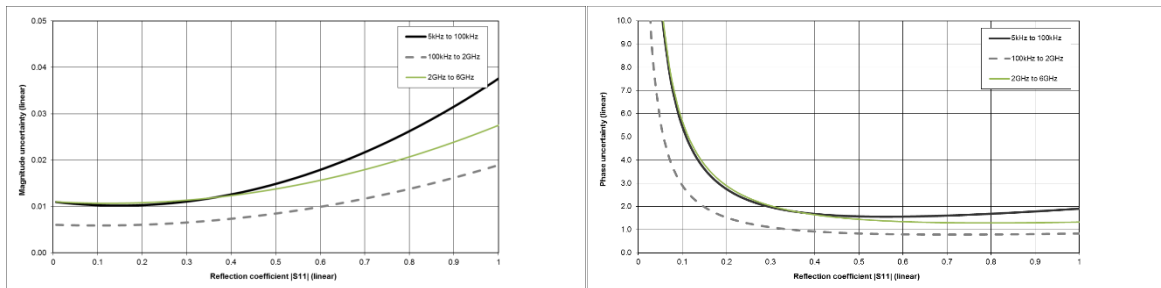

Typical accuracy of reflection magnitude and reflection phase measurements for the R&S®ZNL 1; analysis conditions: $S_{12} = S_{21} = 0$, calibrated power -10 dBm, measured power -10 dBm

Effective system data

This data is valid between +18 °C and +28 °C, provided the temperature has not varied by more than 1 °C after calibration. Frequency points, measurement bandwidth and sweep time have to be identical for measurement and calibration (no interpolation allowed). The data is based on a measurement bandwidth of 10 Hz and system error calibration using TOSM/SOLT with an R&S®ZV-Z270 calibration kit.

R&S®ZNL	100 kHz to 2 GHz	>2 GHz to 6 GHz
Directivity	≥ 46 dB	≥ 40 dB
Source match	≥ 40 dB	≥ 36 dB
Load match	≥ 46 dB	≥ 40 dB
Reflection tracking	≤ 0.03 dB	≤ 0.05 dB
Transmission tracking	≤ 0.03 dB	≤ 0.05 dB

Factory-calibrated system data

This data is valid between +18 °C and +28 °C. It is based on a source power of -10 dBm and a measurement bandwidth of 1 kHz.

		specification	typical
Directivity	100 kHz to 6 GHz	≥ 20 dB	35 dB
Source match	100 kHz to 6 GHz	≥ 20 dB	35 dB
Reflection tracking	100 kHz to 6 GHz	≤ 1 dB	0.1 dB
Transmission tracking	100 kHz to 3 GHz	≤ 1 dB	0.1 dB
Transmission tracking	3 GHz to 6 GHz	≤ 1.5 dB	0.2 dB
Load match (raw testport match)	100 kHz to 3 GHz	≥ 14 dB	20 dB
Load match (raw testport match)	3 GHz to 6 GHz	≥ 12 dB	16 dB

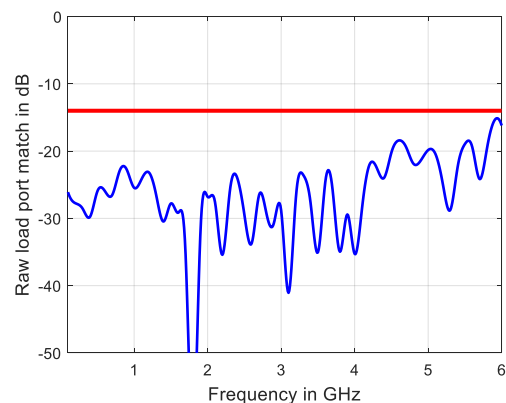
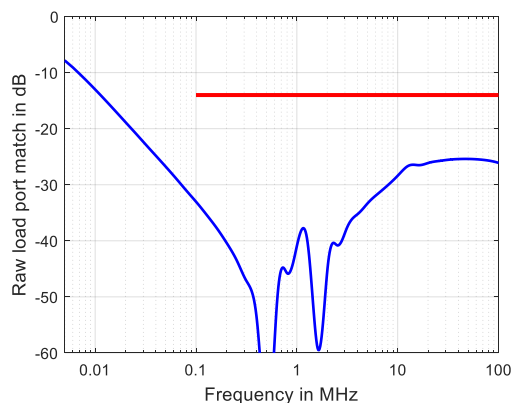

Raw load port match versus frequency for the R&S®ZNL

Trace stability		specification	typical	
Trace noise magnitude (RMS)	at 0 dBm source power, 0 dB reflection	IF bandwidth		
	100 kHz to 10 MHz	10 kHz	< 0.0035 dB	0.0005 dB
	10 MHz to 6 GHz	10 kHz	< 0.0025 dB	0.0005 dB
Trace noise phase (RMS)	at 0 dBm source power, 0 dB reflection	IF bandwidth		
	100 kHz to 10 MHz	10 kHz	< 0.05	
	10 MHz to 6 GHz	10 kHz	< 0.03	0.005°
Temperature dependence	at 0 dB transmission or reflection			
	100 kHz to 6 GHz	magnitude		0.03 dB/K
		phase		0.8°/K

Test port output

This data is valid from +18 °C to +28 °C.

		specification	typical
Power range of the R&S®ZNL ¹	without R&S®ZNL-B22 extended power range option ¹		
	5 kHz to 100 kHz	-10 dBm to -3 dBm	up to +3 dBm
	100 kHz to 6 GHz	-10 dBm to 0 dBm	up to +3 dBm
	with R&S®ZNL-B22 extended power range option ¹		
	5 kHz to 100 kHz	-40 dBm to -3 dBm	up to +3 dBm
	100 kHz to 6 GHz	-40 dBm to 0 dBm	up to +3 dBm
Power accuracy of the R&S®ZNL ¹	source power -10 dBm		
	5 kHz to 100 kHz	≤ 3 dB	
	100 kHz to 6 GHz	≤ 2 dB	0.5 dB
Power linearity	referenced to -10 dBm		
	100 kHz to 6 GHz	≤ 1 dB	0.25 dB
Power resolution		0.01 dB	
Harmonics	source power -10 dBm		
	100 kHz to 6 GHz	≤ -25 dBc	-40 dBc

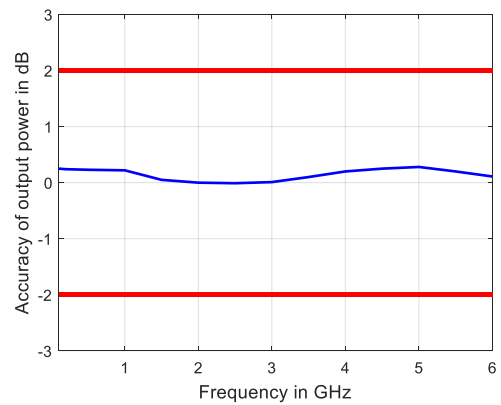
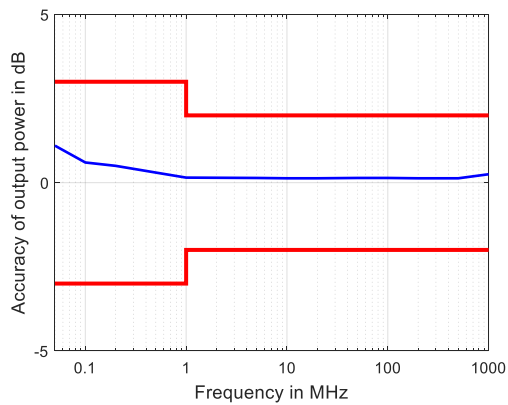

Output power accuracy in dB versus frequency for the R&S®ZNL base unit

Test port input

		specification	typical
Maximum nominal input level		0 dBm	
Power measurement accuracy	at -10 dBm without power calibration		
	9 kHz to 100 kHz	≤ 2 dB	0.3 dB
	100 kHz to 6 GHz	≤ 1.5 dB	0.3 dB
Receiver linearity referenced to -10 dBm	+10 dB to +5 dB	≤ 0.25 dB	0.1 dB
	+5 dB to -40 dB	≤ 0.15 dB	0.05 dB
Damage level		+27 dBm	
Damage DC voltage		30 V	
Noise level at 1 kHz measurement bandwidth, normalized to 1 Hz	5 kHz to 100 kHz	< -95 dBm (1 Hz)	-120 dBm (1 Hz)
	100 kHz to 50 MHz	< -120 dBm (1 Hz)	-130 dBm (1 Hz)
	50 MHz to 4.5 GHz	< -130 dBm (1 Hz)	-140 dBm (1 Hz)
	4.5 GHz to 6 GHz	< -125 dBm (1 Hz)	-135 dBm (1 Hz)

The noise level is defined as the RMS value of the specified noise floor.

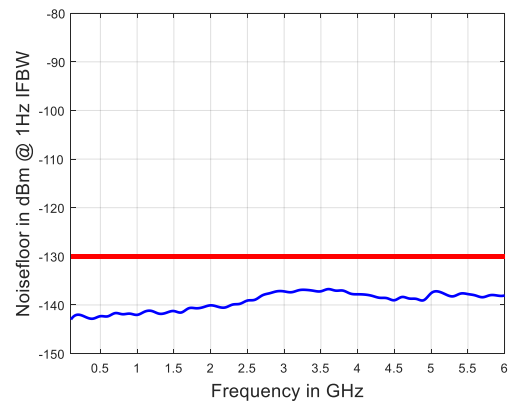
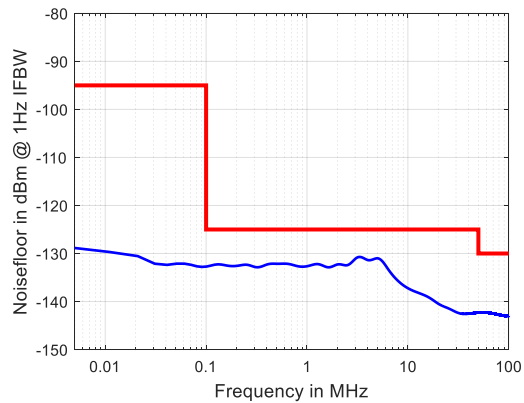

Noise level in dBm (1 Hz) versus frequency for the R&S®ZNL

Display

Screen	26.4 cm (10.1") diagonal WXGA color LCD with touchscreen
Resolution	1280 × 800 × 262144 (high color, 125 dpi)
Pixel failure rate	$< 1 \times 10^{-5}$

Front panel connectors

USB	two universal serial bus connectors for connecting USB devices (USB 2.0); two additional USB 3.0 connectors on rear panel
-----	--

Rear panel connectors

LAN	local area network connector, 10/100/1000BASE-T, 8-pin, RJ-45
-----	---

USB	two universal serial bus connectors for connecting USB devices (USB 3.0); two additional USB 2.0 connectors on front panel
-----	---

MONITOR	DVI-D connector (for external monitor)
---------	--

REF IN	input for external frequency reference signal	
Connector type		BNC, female
Input frequency		10 MHz
Maximum permissible deviation		1 kHz
Input power		-10 dBm to +15 dBm at 50 Ω
Input impedance		> 10 kΩ

REF OUT	output for external frequency reference signal	
Connector type		BNC, female
Output frequency		10 MHz
Output frequency accuracy		80 Hz
Output power		+6 dBm ± 4 dB at 50 Ω

EXT TRIG IN	trigger input for analyzer	
Connector type		BNC, female
TTL signal (edge-triggered or level-triggered)		3 V, 5 V tolerant
Polarity (selectable)		positive or negative
Minimum pulse width		1 μs
Input impedance		> 10 kΩ

Options

R&S®ZNL3-B1, R&S®ZNL4-B1 and R&S®ZNL6-B1 spectrum analysis

Input

RF input		
Impedance		50 Ω
Connector		N female
VSWR	10 MHz ≤ f ≤ 3 GHz	< 1.5 (nom.)
	3 GHz < f ≤ 6 GHz	< 1.7 (nom.)
Setting range of attenuator		0 dB to 30 dB, in 10 dB steps

Frequency

Frequency range	R&S®ZNL3-B1	5 kHz to 3 GHz
	R&S®ZNL4-B1	5 kHz to 4.5 GHz
	R&S®ZNL6-B1	5 kHz to 6 GHz
Frequency resolution		0.01 Hz

Reference frequency, internal	see section: Measurement range
-------------------------------	--------------------------------

Frequency readout		
Marker resolution		0.01 Hz
Uncertainty		±(marker frequency × reference uncertainty + 10 % × resolution bandwidth + ½ (span/(sweep points – 1)) + 1 Hz)
Number of sweep (trace) points	default value	1001
	range	101 to 100001
Marker tuning frequency step size	marker step size = sweep points	span/(sweep points – 1)
	marker step size = standard	span/(default sweep points – 1)
Frequency counter resolution		1 Hz
Count accuracy		±(frequency × reference uncertainty + ½ (last digit))
Display range for frequency axis		0 Hz, 10 Hz to max. frequency
Resolution		0.1 Hz
Maximum span deviation		0.1 %

Spectral purity SSB phase noise	frequency = 1000 MHz, carrier offset	specification	typical	nominal
	100 Hz			
1 kHz				-107 dBc (1 Hz)
10 kHz		< -103 dBc (1 Hz)	-108 dBc (1 Hz)	
100 kHz		< -110 dBc (1 Hz)	-115 dBc (1 Hz)	
1 MHz		< -128 dBc (1 Hz)	-133 dBc (1 Hz)	
10 MHz				-153 dBc (1 Hz)

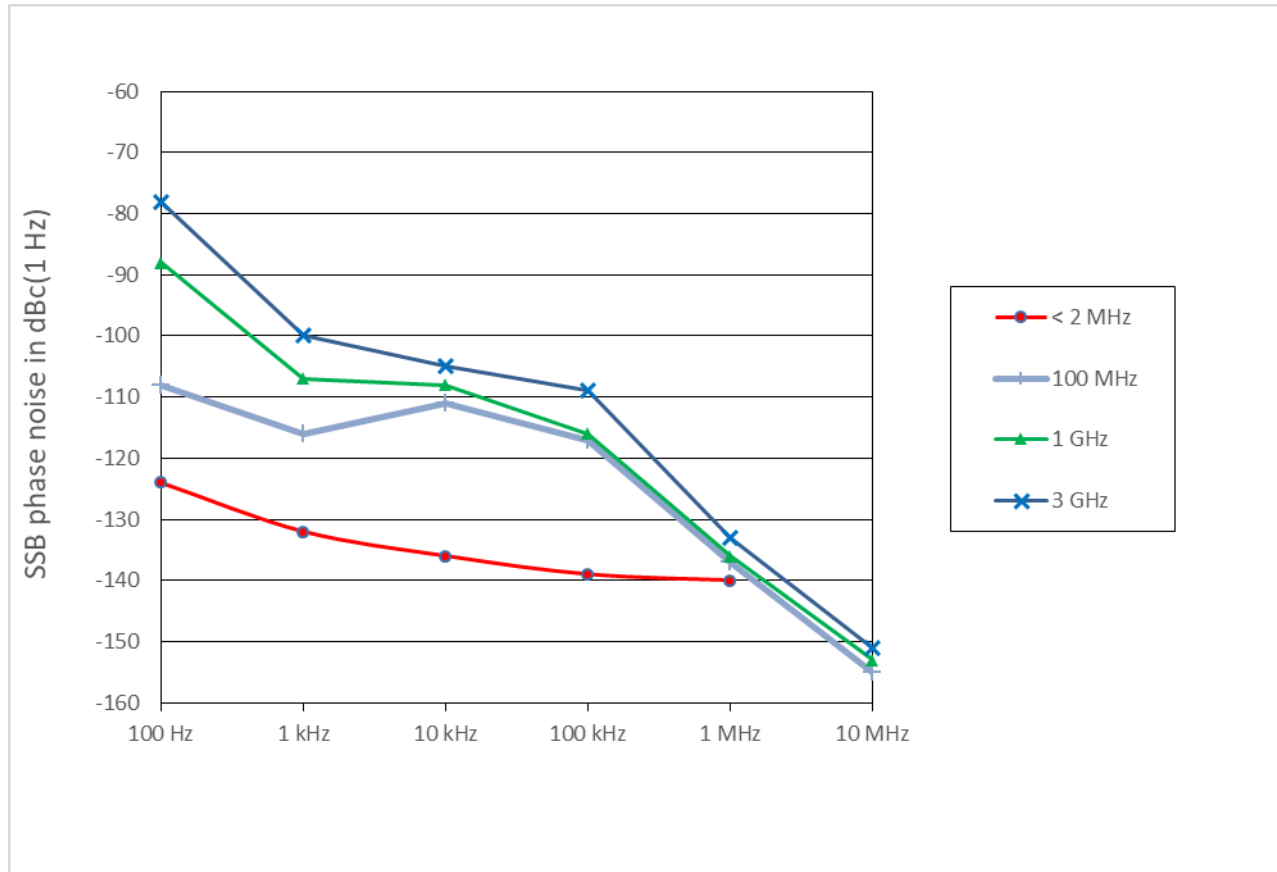

Typical phase noise at different center frequencies

Sweep time

Range	span = 0 Hz	1 μ s to 8000 s
	span \geq 10 Hz, RBW \geq 100 kHz	1 ms to 8000 s ⁵
	span \geq 10 Hz, RBW < 100 kHz	75 μ s to 8000 s ⁶
Sweep time accuracy	span = 0 Hz	0.1 % (nom.)
	span \geq 10 Hz, RBW \geq 100 kHz	3 % (nom.)

Resolution bandwidths

Sweep filters and FFT filters		
Resolution bandwidths (-3 dB)	sweep filters	100 kHz to 10 MHz in 1/2/3/5 sequence
	FFT filters	1 Hz to 50 kHz in 1/2/3/5 sequence
Bandwidth uncertainty		< 3 % (nom.)
Shape factor 60 dB:3 dB		< 5 (nom.)

⁵ Net sweep time without additional hardware settling time.

⁶ Time for data acquisition for FFT calculation.

Channel filters		
Bandwidths (-3 dB)		100 Hz, 200 Hz, 300 Hz, 500 Hz 1/1.5/2/2.4/2.7/3/3.4/4/4.5/5/6/7.5/8.5/9/ 10/12.5/14/15/16/20/21/25/30/50/ 100/150/192/200/300/500 kHz 1/1.228/1.5/2/3/3.75/5/10 MHz
Bandwidth uncertainty		< 2 % (nom.)
Shape factor 60 dB:3 dB		< 2 (nom.)

Video bandwidths	standard	1 Hz to 10 MHz in 1/2/3/5 sequence
-------------------------	----------	------------------------------------

Signal analysis bandwidth (equalized)	standard	10 MHz (nom.)
	with R&S®FPL1-B40 option	40 MHz (nom.)

Level

Display range		displayed noise floor up to +30 dBm
---------------	--	-------------------------------------

Intermodulation		
Third order intercept point (TOI)	RF attenuation 0 dB, level 2×-20 dBm, $\Delta f > 5 \times$ RBW or 10 kHz, whichever is larger	
	$10 \text{ MHz} \leq f_{in} < 300 \text{ MHz}$	> 13 dBm, 20 dBm (typ.)
	$300 \text{ MHz} \leq f_{in} < 3 \text{ GHz}$	> 16 dBm, 22 dBm (typ.)
	$3 \text{ GHz} \leq f_{in} < 6 \text{ GHz}$	> 13 dBm, 18 dBm (typ.)
Second harmonic intercept (SHI)	RF attenuation 0 dB, level -13 dBm	
	$1 \text{ MHz} < f_{in} \leq 900 \text{ MHz}$	45 dBm (nom.)
	$900 \text{ MHz} < f_{in} \leq 1.5 \text{ GHz}$	70 dBm (nom.)

Displayed average noise level (DANL)		
termination 50 Ω , log. scaling, normalized to 1 Hz RBW, RBW = 1 kHz, VBW = 1 Hz, sample detector, +18 °C to +28 °C		
RF attenuation 0 dB	$5 \text{ kHz} \leq f < 100 \text{ kHz}$	-130 dBm (typ.)
	$100 \text{ kHz} \leq f < 5 \text{ MHz}$	< -135 dBm, -145 dBm (typ.)
	$5 \text{ MHz} \leq f < 4.5 \text{ GHz}$	< -140 dBm, -150 dBm (typ.)
	$4.5 \text{ GHz} \leq f < 6 \text{ GHz}$	< -137 dBm, -147 dBm (typ.)

Spurious responses	RF attenuation 0 dB, sweep optimization: auto or dynamic	
Image response	$10 \text{ MHz} \leq f \leq 3 \text{ GHz}$	
	$f_{in} - 2 \times 4020.4 \text{ MHz}$ (1st IF)	< -90 dBc (nom.)
	$f_{in} - 2 \times 820.4 \text{ MHz}$ (2nd IF)	< -80 dBc
	$f_{in} - 2 \times 20.4 \text{ MHz}$ (3rd IF), RBW $\leq 5 \text{ MHz}$	< -80 dBc
	$3 \text{ GHz} < f \leq 6 \text{ GHz}$	< -70 dBc (nom.)
Intermediate frequency response	$2 \text{ MHz} \leq f \leq 3 \text{ GHz}$	
	1st IF (4020.4 MHz)	< -80 dBc (nom.)
	2nd IF (820.4 MHz)	< -80 dBc
	3rd IF (20.4 MHz)	< -80 dBc
	$3 \text{ GHz} < f \leq 6 \text{ GHz}$	< -70 dBc (nom.)
Residual spurious response	RF attenuation 0 dB,	
	$f \leq 1 \text{ MHz}$	< -90 dBm (nom.)
	$f > 1 \text{ MHz}$	< -90 dBm
Local oscillator related spurious	$f < 3 \text{ GHz}$, RF attenuation 10 dB, RF input -10 dBm	
	$1 \text{ kHz} \leq$ carrier offset $\leq 10 \text{ MHz}$	< -70 dBc (nom.)
	carrier offset $> 10 \text{ MHz}$	< -80 dBc (nom.)
	$3 \text{ GHz} < f \leq 6 \text{ GHz}$	< -70 dBc (nom.)
Other interfering signals		
Subharmonic of 1st LO	$20 \text{ MHz} \leq f < 3 \text{ GHz}$, spurious at $4020.4 \text{ MHz} - 2 \times f_{in}$	< -80 dBc (nom.)
Harmonic of 1st LO	mixer level $< -25 \text{ dBm}$, spurious at $f_{in} - 2010.2 \text{ MHz}$	< -80 dBc (nom.)

Level display		
Logarithmic level axis		1 dB to 200 dB, in 1 dB steps
Linear level axis		10 % of reference level per level division, 10 divisions or logarithmic scaling
Number of traces		6
Trace detector		Max. peak, min. peak, auto peak (normal), sample, RMS, average
Trace functions		clear/write, max. hold, min. hold, average, view
Setting range of reference level		-130 dBm to (-10 dBm + RF attenuation) in steps of 0.01 dB
Units of level axis		dBm, dB μ V, dBmV, dB μ A, dBpW, V, A, W

Level measurement uncertainty		
Absolute level uncertainty at 50 MHz	RBW = 10 kHz, level -10 dBm, reference level -10 dBm, RF attenuation 10 dB	
	+18 °C to +28 °C	< 0.5 dB (σ = 0.1 dB)
	+5 °C to +40 °C	< 1 dB (σ = 0.17 dB)
R&S®ZNL3	RF attenuation 0 dB, 10 dB, 20 dB, 30 dB, +18 °C to +28 °C	
Frequency response referenced to 50 MHz	5 kHz \leq f \leq 3 MHz	< 1 dB (nom.)
	3 MHz < f \leq 10 MHz	< 0.8 dB (nom.)
	10 MHz < f \leq 3 GHz	< 0.8 dB (σ = 0.1 dB)
R&S®ZNL4 and R&S®ZNL6	RF attenuation 0 dB, 10 dB, 20 dB, 30 dB, +18 °C to +28 °C	
Frequency response referenced to 50 MHz	5 kHz \leq f \leq 3 MHz	< 1 dB (nom.)
	3 MHz < f \leq 10 MHz	< 0.8 dB (nom.)
	10 MHz < f \leq 2.9 GHz	< 0.8 dB (σ = 0.1 dB)
	2.9 GHz < f \leq 6 GHz	< 1.3 dB (σ = 0.1 dB)
Attenuator switching uncertainty	f = 50 MHz, 0 dB to 30 dB, referenced to 10 dB attenuation	< 0.3 dB (σ = 0.07 dB)
Uncertainty of reference level setting		0 dB ⁷
Bandwidth switching uncertainty	referenced to RBW = 10 kHz	
	RBW \geq 1 MHz	< 0.3 dB (nom.)
	100 kHz \leq RBW < 1 MHz	< 0.2 dB (nom.)
	RBW < 100 kHz	< 0.1 dB (nom.)

Nonlinearity of displayed level		
Logarithmic level display	S/N > 16 dB, 0 dB to -50 dB	< 0.2 dB (σ = 0.07 dB)
Linear level display	S/N > 16 dB, 0 dB to -70 dB	5 % of reference level (nom.)

Total measurement uncertainty		
	signal level 0 dB to -50 dB below reference level, S/N > 20 dB, sweep time auto, sweep type = sweep, RF attenuation 10 dB, 20 dB, 30 dB, span/RBW < 100, 95 % confidence level, +18 °C to +28 °C	
R&S®ZNL3	3 MHz < f \leq 3 GHz	1 dB
R&S®ZNL4 and R&S®ZNL6	3 MHz < f \leq 2.9 GHz	1 dB
	2.9 GHz < f \leq 6 GHz	1.5 dB

Measurement speed

Local measurement and display update rate	1001 sweep points, sweep optimization set to "speed"	1 ms (1000/s) (nom.)
Max. sweep rate, remote operation ^{8,9}	trace average = on	0.9 ms (1100/s) (nom.)
Remote measurement and LAN transfer ⁸		2.8 ms (357/s) (nom.)
Marker peak search ⁸		1.3 ms (nom.)
Center frequency tune + sweep + sweep data transfer ⁸		15 ms (nom.)

⁷ The setting of the reference level affects only the graphical representation of the measurement result on the display, not the measurement itself. Therefore, the reference level setting causes no additional uncertainty in measurement results.

⁸ Measured with personal computer equipped with Intel® Core™ i7 2.8 GHz and Gbit LAN interface.

⁹ Measurement is performed with a sweep count of 1000. The indicated speed is the average speed of 1 sweep.

Trigger functions

Trigger		
Trigger source		free run, video, external, IF power
Trigger offset	span \geq 10 Hz	50 ns to 40 s, min. resolution 50 ns (or 0.5 % of offset)
	span = 0 Hz	(–sweep time) to 40 s, min. resolution 50 ns (or 0.5 % of offset)
Maximum deviation of trigger offset		$\pm(7.8125 \text{ ns} + (0.1 \% \times \text{trigger offset}))$
IF power trigger		
Sensitivity	min. signal power	–60 dBm + RF attenuation
	max. signal power	–15 dBm + RF attenuation
IF power trigger bandwidth	RBW > 5 MHz	40 MHz (nom.)
	RBW \leq 5 MHz	6 MHz (nom.)
Gated sweep		
Gate source		video, external, IF power
Gate delay		50 ns to 30 s, min. resolution 50 ns (or 0.5 % of delay)
Gate length		125 ns to 30 s, min. resolution 50 ns (or 0.5 % of gate length)
Maximum deviation of gate length		$\pm(7.8125 \text{ ns} + (0.1 \% \times \text{gate length}))$

I/Q data

Interface		GPIO or LAN interface
Memory length		max. 25 Msample I and Q
Word length of I/Q samples		14 bit
Sampling rate	standard	100 Hz to 45 MHz
	with R&S®FPL-B40 option	100 Hz to 100 MHz
Maximum signal analysis bandwidth (equalized)	standard	10 MHz
	with R&S®FPL-B40 option	40 MHz
Signal analysis bandwidth \leq 10 MHz		
Amplitude flatness		$\pm 0.3 \text{ dB (nom.)}$
Deviation from linear phase		$\pm 1^\circ \text{ (nom.)}$
Signal analysis bandwidth \leq 40 MHz		
Amplitude flatness		$\pm 0.5 \text{ dB (nom.)}$
Deviation from linear phase		$\pm 1.5^\circ \text{ (nom.)}$

R&S®ZNL3-B22, R&S®ZNL4-B22 and R&S®ZNL6-B22 extended power range

Extended power range		specification	typical
Frequency range	R&S®ZNL3-B22	5 kHz to 3 GHz	
	R&S®ZNL4-B22	5 kHz to 4.5 GHz	
	R&S®ZNL6-B22	5 kHz to 6 GHz	
Power range for the R&S®ZNL ¹	5 kHz to 50 kHz	–40 dBm to –3 dBm	up to +3 dBm
	50 kHz to 6 GHz	–40 dBm to +0 dBm	up to +3 dBm

R&S®ZNL3-B31/-B32, R&S®ZNL4-B31/-B32 and R&S®ZNL6-B31/-B32 receiver step attenuators

Receiver step attenuators		
Frequency range	R&S®ZNL3-B31/R&S®ZNL3-B32	5 kHz to 3 GHz
	R&S®ZNL4-B31/R&S®ZNL4-B32	5 kHz to 4.5 GHz
	R&S®ZNL6-B31/R&S®ZNL6-B32	5 kHz to 6 GHz
Attenuation		0 dB to 30 dB in 10 dB steps

R&S®FPL1-B5 additional interfaces

User port		
Connector		25-pin D-Sub female
Output		TTL-compatible, 0 V/5 V, max. 15 mA
Input		TTL-compatible, max. 5 V

Noise source control		
Connector		BNC female
Output		0 V/28 V, max. 100 mA, switchable, supply for noise source

Power sensor		
Connector		6-pin LEMOSA female for supported R&S®NRP-Zxx power sensors

IF/video/demod out		
Connector		BNC female, 50 Ω
IF out		
Bandwidth		equal to RBW setting
IF frequency		25 MHz
Output level	center frequency > 10 MHz, span = 0 Hz, signal at reference level and center frequency	0 dBm (nom.)
Video out		
Bandwidth		equal to VBW setting
Output scaling	log. display scale	logarithmic
	lin. display scale	linear
Output level	center frequency > 10 MHz, span = 0 Hz, signal at reference level and center frequency	1 V (nom.), open circuit

Audio output		
Loudspeaker		built-in, adjustable
AF out		
Connector		3.5 mm mini jack
Output impedance		10 Ω
Open-circuit voltage		up to 1.5 V, adjustable

R&S®FPL1-B4 precision frequency reference (OCXO)

Static frequency accuracy		(time since last adjustment × aging rate) + temperature drift + calibration accuracy
Aging per year	with R&S®FPL-B4 precision frequency reference option	$\pm 1 \times 10^{-7}$
Temperature drift (+5 °C to +40 °C)	with R&S® FPL-B4 precision frequency reference option	$\pm 1 \times 10^{-8}$
Achievable initial calibration accuracy	with R&S® FPL-B4 precision frequency reference option	$\pm 5 \times 10^{-8}$

R&S®FPL1-B10 GPIB interface

GPIB interface	remote control interface in line with IEEE 488, IEC 60625; 24-pin
----------------	---

R&S®FPL1-B30 DC power input 12 V/24 V

Input voltage range		10.4 V to 28 V, switch-on voltage > 11 V
Input current	$V_{in} = 12\text{ V/24 V}$, operating mode, without internal batteries (R&S®FPL1-B31)	5.5 A/2.7 A (nom.)
	$V_{in} = 12\text{ V/24 V}$, operating mode, internal batteries in charge mode	11 A/5 A (nom.)
	$V_{in} = 12\text{ V/24 V}$, instrument standby mode, internal batteries in charge mode	6.5 A/3 A (nom.)
Temperature	operating temperature range	+5 °C to +40 °C
	storage temperature range	-20 °C to +70 °C

R&S®FPL1-B31 internal lithium-ion battery

Operating time		3.5 h (nom.)
Charge time	standby mode, AC supply	< 2 h (nom.)
	standby mode, external DC supply (R&S®FPL1-B30)	< 2 h (nom.)
	operating mode	< 4 h (nom.)
Temperature	operating temperature	+5 °C to +40 °C
	storage temperature range	-20 °C to +60 °C ¹⁰

R&S®FSV-B34 charger (only necessary to charge spare batteries)

AC input voltage range		100 V to 240 V, ±10 % (nom.)
AC supply frequency		50 Hz to 60 Hz (nom.)
Power consumption		max. 300 W (nom.)
Number of charger bays		4
Dimensions	W × H × D	400 mm × 127 mm × 203 mm (15.75 in × 5 in × 8 in)
Net weight		3.1 kg (6.9 lb)

¹⁰ The battery packs should be stored in an environment with low humidity, free from corrosive gas at a recommended temperature range < +21 °C. Extended exposure to temperatures above +40°C could degrade battery performance and life.

General data

Data storage		
Internal	standard	solid-state drive 32 Gbyte (nom.)
External		supports USB-2.0-compatible memory devices

Environmental conditions		
Temperature	operating temperature range	+5 °C to +40 °C
	storage temperature range	−20 °C to +70 °C
Climatic loading		+40 °C at 85 % rel. humidity, in line with EN 60068-2-30, without condensation

Mechanical resistance		
Vibration	sinusoidal	5 Hz to 55 Hz 0.15 mm constant amplitude (1.8 g at 55 Hz); 55 Hz to 150 Hz acceleration: 0.5 g constant; in line with EN 60068-2-6
	random	10 Hz to 300 Hz, acceleration 1.2 g (RMS); in line with EN 60068-2-64
Shock		40 g shock spectrum; in line with MIL-STD-810E method No. 516.4 procedure I, MIL-PRF-28800F

EMC		in line with EMC Directive 2014/30/EU including IEC/EN 61326-1 ^{11, 12} , IEC/EN 61326-2-1, CISPR 11/EN 55011 ¹¹ , IEC/EN 61000-3-2, IEC/EN 61000-3-3
-----	--	---

Recommended calibration interval		1 year
----------------------------------	--	--------

Power supply		
AC supply	without battery option	100 V to 240 V ± 10 %, 50 Hz to 60 Hz ± 5 %, 400 Hz ± 5% class of protection I; in line with VDE 411
	with battery option	100 V to 240 V ± 10 %, 50 Hz to 60 Hz ± 5 %
Current consumption	without options	1.7 A to 0.8 A
	with internal battery (R&S®FPL1-B31 option) in charge mode	3 A to 1.5 A
Power consumption		max. 300 W, 90 W (typ.)
Safety		in line with EN 61010-1, IEC 61010-1, UL 61010-1, CAN/CSA-C22.2 No. 61010-1
Test mark		CSA, CSA-NRTL

Dimensions and weight		
Dimensions	W × H × D	408 mm × 186 mm × 235 mm (16.06 in × 7.32 in × 9.25 in)
Net weight, nominal	without options	6 kg (13.22 lb)
	with internal battery	7.3 kg (16 lb)

¹¹ Emission limits for class A equipment.

¹² Immunity test requirement for industrial environment (EN 61326 table 2).

Dimensions (in mm)

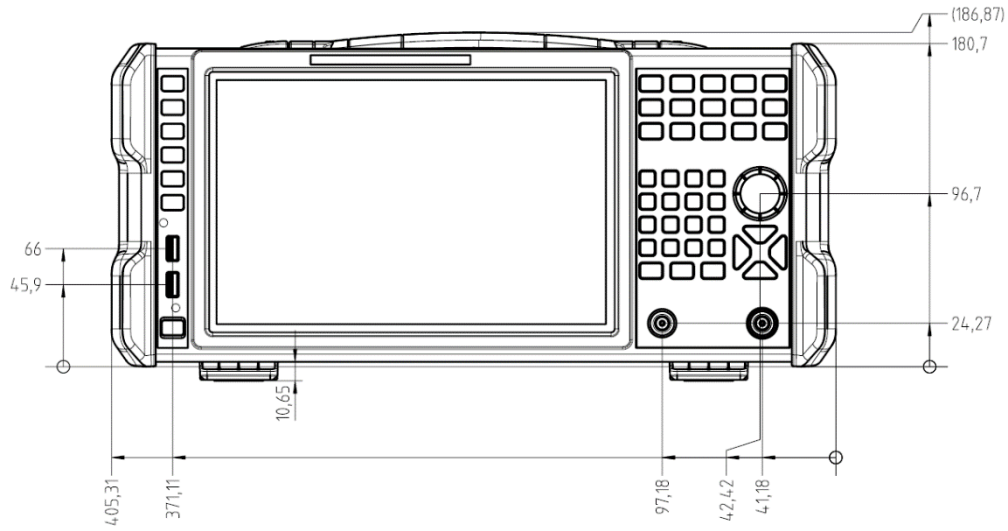

Front view of the R&S®ZNL

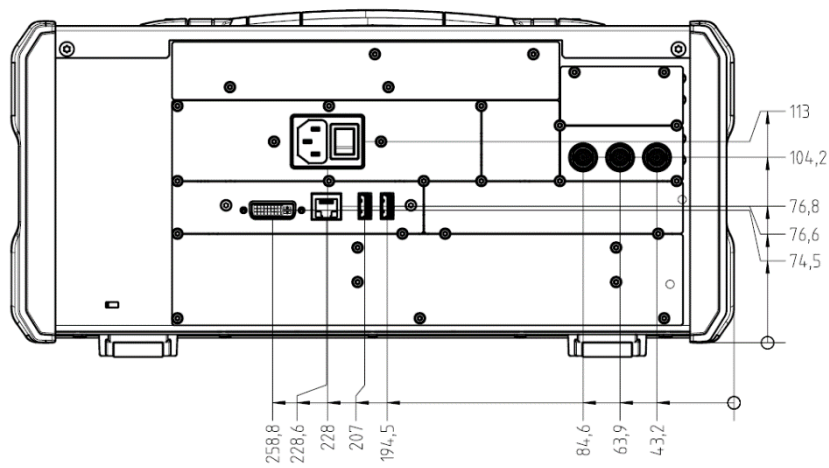

Rear view of the R&S®ZNL

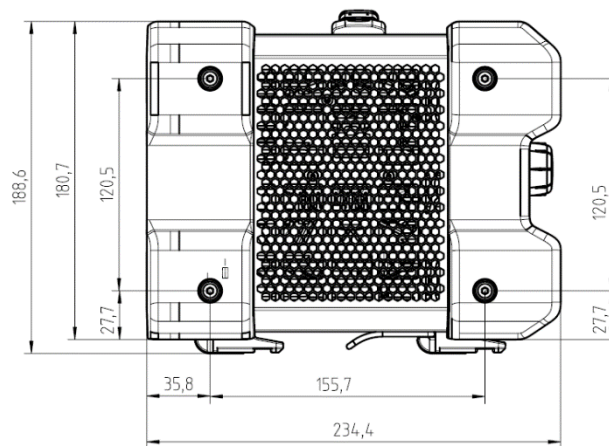

Side view of the R&S®ZNL

Ordering information

Designation	Type	Retrofit ¹³	On Site ¹⁴	Order No.
Base unit				
Vector network analyzer, two ports, 3 GHz, N	R&S [®] ZNL3			1323.0012K03
Vector network analyzer, two ports, 4.5 GHz, N	R&S [®] ZNL4			1323.0012K04
Vector network analyzer, two ports, 6 GHz, N	R&S [®] ZNL6			1323.0012K06
Options				
Spectrum analysis for R&S [®] ZNL3	R&S [®] ZNL3-B1	•		1323.1802.02
Spectrum analysis for R&S [®] ZNL4	R&S [®] ZNL4-B1	•		1303.8099.02
Spectrum analysis for R&S [®] ZNL6	R&S [®] ZNL6-B1	•		1323.2067.02
Extended power range				
Extended power range for two-port R&S [®] ZNL3	R&S [®] ZNL3-B22	•		1323.1860.02
Extended power range for two-port R&S [®] ZNL4	R&S [®] ZNL4-B22	•		1303.8118.02
Extended power range for two-port R&S [®] ZNL6	R&S [®] ZNL6-B22	•		1323.2021.02
Receiver step attenuators				
Receiver step attenuator, port 1, for R&S [®] ZNL3	R&S [®] ZNL3-B31	•		1323.1848.02
Receiver step attenuator, port 2, for R&S [®] ZNL3	R&S [®] ZNL3-B32	•		1323.1854.02
Receiver step attenuator, port 1, for R&S [®] ZNL4	R&S [®] ZNL4-B31	•		1303.8124.02
Receiver step attenuator, port 2, for R&S [®] ZNL4	R&S [®] ZNL4-B32	•		1303.8130.02
Receiver step attenuator, port 1, for R&S [®] ZNL6	R&S [®] ZNL6-B31	•		1323.2038.02
Receiver step attenuator, port 2, for R&S [®] ZNL6	R&S [®] ZNL6-B32	•		1323.2044.02
Precision frequency reference (OCXO)	R&S [®] FPL1-B4	•		1323.1902.02
Additional interface	R&S [®] FPL1-B5	•	•	1323.1883.02
GPIB interface	R&S [®] FPL1-B10	•	•	1323.1890.02
Second hard disk (SSD) Remark: mounted on PC board, including analyzer firmware	R&S [®] ZNL-B19	•	•	1323.2938.02
DC-power supply 12 V/24 V	R&S [®] FPL1-B30	•		1323.1877.02
Internal lithium-ion battery	R&S [®] FPL1-B31	•		1323.1725.02
40 MHz analysis bandwidth ¹⁵	R&S [®] FPL1-B40	•	•	1323.1931.02
Firmware/software				
Time domain analysis	R&S [®] ZNL-K2	•	•	1323.1819.02
Distance-to-fault measurement	R&S [®] ZNL-K3	•	•	1323.1825.02
AM/FM/φM measurement demodulator ¹⁵	R&S [®] FPL1-K7	•	•	1323.1731.02
Power sensor measurement with R&S [®] NRP power sensors ¹⁵	R&S [®] FPL1-K9	•	•	1323.1754.02
Noise figure and gain measurements ¹⁶	R&S [®] FPL1-K30	•	•	1323.1760.02

Recommended extras

Designation	Type	Order No.
Protective hard cover	R&S [®] FPL1-Z1	1323.1960.02
Soft carrying bag for transport and outdoor operation	R&S [®] FPL1-Z2	1323.1977.02
Carrying vest holster (requires R&S [®] FPL1-Z2)	R&S [®] FPL1-Z3	1323.1683.02
Spare lithium-ion battery pack ¹⁷	R&S [®] FPL1-Z4	1323.1677.02
Anti-glare display film for outdoor operation	R&S [®] FPL1-Z5	1323.1690.02
Lithium-ion battery charger for charging spare batteries ¹⁴	R&S [®] FSV-B34	1321.3950.02
19" rackmount kit	R&S [®] FPL1-Z6	1323.1954.02
Broadband limiter, N(m to f), 50 Ω, 50 MHz to 6 GHz	R&S [®] ZN-B13	1303.7840.02
Headphones		0708.9010.00
Matching pads, 50/75 Ω		
L section, matching at both ends	R&S [®] RAM	0358.5414.02
Series resistor, 25 Ω, matching at one end (taken into account in instrument function RF INPUT 75 Ω)	R&S [®] RAZ	0358.5714.02
Smart noise source		
Smart noise source for noise figure and gain measurements (requires R&S [®] FPL1-K30)	R&S [®] FS-SNS26	1338.8008.26

¹³ Option may also be ordered at a later stage, upgrade in service.

¹⁴ Option may be installed by the customer on site.

¹⁵ Requires R&S[®]ZNL3-B1, R&S[®]ZNL4-B1 or R&S[®]ZNL6-B1 spectrum analysis option.

¹⁶ Requires R&S[®]ZNL3-B1, R&S[®]ZNL4-B1 or R&S[®]ZNL6-B1 spectrum analysis option + R&S[®]FPL1-B5 additional interface.

¹⁷ Requires R&S[®]FPL1-B31 internal lithium-ion battery.

Designation	Type	Order No.
High-power attenuators		
Attenuator 100 W, 3/6/10/20/30 dB, 1 GHz	R&S®RBU100	1073.8495.xx (xx = 03/06/10/20/30)
Attenuator 50 W, 3/6/10/20/30 dB, 2 GHz	R&S®RBU50	1073.8695.xx (xx = 03/06/10/20/30)
Attenuator 50 W, 20 dB, 6 GHz	R&S®RDL50	1035.1700.52
Connectors and cables		
N-type adapter for R&S®RT-Zx probes	R&S®RT-ZA9	1417.0909.02
IEC/IEEE bus cable, length: 1 m	R&S®PCK	0292.2013.10
IEC/IEEE bus cable, length: 2 m	R&S®PCK	0292.2013.20
DC block		
DC block, 10 kHz to 18 GHz (type N)	R&S®FSE-Z4	1084.7443.02

Power sensors supported by the R&S®FPL1-K9 option ¹⁸

Designation	Type	Order No.
Universal power sensor, 10 MHz to 8 GHz, 200 mW	R&S®NRP-Z11	1138.3004.02
Universal power sensor, 10 MHz to 18 GHz, 200 mW	R&S®NRP-Z21	1137.6000.02
Universal power sensor, 10 MHz to 18 GHz, 2 W	R&S®NRP-Z22	1137.7506.02
Universal power sensor, 10 MHz to 18 GHz, 15 W	R&S®NRP-Z23	1137.8002.02
Universal power sensor, 10 MHz to 18 GHz, 30 W	R&S®NRP-Z24	1137.8502.02
Power sensor module with power splitter, DC to 18 GHz, 500 mW	R&S®NRP-Z27	1169.4102.02
Power sensor module with power splitter, DC to 26.5 GHz, 500 mW	R&S®NRP-Z37	1169.3206.02
Thermal power sensor, 0 Hz to 18 GHz, 100 mW	R&S®NRP-Z51	1138.0005.02
Thermal power sensor, 0 Hz to 40 GHz, 100 mW	R&S®NRP-Z55	1138.2008.02
Thermal power sensor, 0 Hz to 50 GHz, 100 mW	R&S®NRP-Z56	1171.8201.02
Thermal power sensor, 0 Hz to 67 GHz, 100 mW	R&S®NRP-Z57	1171.8401.02
Thermal power sensor, 0 Hz to 110 GHz, 100 mW	R&S®NRP-Z58	1173.7031.02
Wideband power sensor, 50 MHz to 18 GHz, 100 mW	R&S®NRP-Z81	1137.9009.02
Average power sensor, 9 kHz to 6 GHz, 200 mW	R&S®NRP-Z91	1168.8004.02
Average power sensor, 9 kHz to 6 GHz, 2 W	R&S®NRP-Z92	1171.7005.02
Two-path diode power sensor, 10 MHz to 8 GHz, 100 mW	R&S®NRP-Z211	1417.0409.02
Two-path diode power sensor, 10 MHz to 18 GHz, 100 mW	R&S®NRP-Z221	1417.0309.02
Three-path diode power sensor, 100 pW to 200 mW, 10 MHz to 8 GHz	R&S®NRP8S	1419.0006.02
Three-path diode power sensor, 100 pW to 200 mW, 10 MHz to 8 GHz, LAN version	R&S®NRP8SN	1419.0012.02
Three-path diode power sensor, 100 pW to 200 mW, 10 MHz to 18 GHz	R&S®NRP18S	1419.0029.02
Three-path diode power sensor, 100 pW to 200 mW, 10 MHz to 18 GHz, LAN version	R&S®NRP18SN	1419.0035.02
Three-path diode power sensor, 100 pW to 200 mW, 10 MHz to 33 GHz	R&S®NRP33S	1419.0064.02
Three-path diode power sensor, 100 pW to 200 mW, 10 MHz to 33 GHz, LAN version	R&S®NRP33SN	1419.0070.02

¹⁸ For average power measurement only.

Warranty		
Base unit		3 years
All other items ¹⁹		1 year
Options		
Extended warranty, one year	R&S [®] WE1	Please contact your local Rohde & Schwarz sales office.
Extended warranty, two years	R&S [®] WE2	
Extended warranty with calibration coverage, one year	R&S [®] CW1	
Extended warranty with calibration coverage, two years	R&S [®] CW2	
Extended warranty with accredited calibration coverage, one year	R&S [®] AW1	
Extended warranty with accredited calibration coverage, two years	R&S [®] AW2	

Extended warranty with a term of one and two years (WE1 and WE2)

Repairs carried out during the contract term are free of charge ²⁰. Necessary calibration and adjustments carried out during repairs are also covered.

Extended warranty with calibration coverage (CW1 and CW2)

Enhance your extended warranty by adding calibration coverage at a package price. This package ensures that your Rohde & Schwarz product is regularly calibrated, inspected and maintained during the term of the contract. It includes all repairs ²⁰ and calibration at the recommended intervals as well as any calibration carried out during repairs or option upgrades.

Extended warranty with accredited calibration (AW1 and AW2)

Enhance your extended warranty by adding accredited calibration coverage at a package price. This package ensures that your Rohde & Schwarz product is regularly calibrated under accreditation, inspected and maintained during the term of the contract. It includes all repairs ²⁰ and accredited calibration at the recommended intervals as well as any accredited calibration carried out during repairs or option upgrades.

¹⁹ For options that are installed, the remaining base unit warranty applies if longer than 1 year. Exception: all batteries have a 1 year warranty.

²⁰ Excluding defects caused by incorrect operation or handling and force majeure. Wear-and-tear parts are not included.

Service that adds value

- ▶ Worldwide
- ▶ Local und personalized
- ▶ Customized and flexible
- ▶ Uncompromising quality
- ▶ Long-term dependability

Rohde & Schwarz

The Rohde&Schwarz electronics group offers innovative solutions in the following business fields: test and measurement, broadcast and media, secure communications, cybersecurity, monitoring and network testing. Founded more than 80 years ago, the independent company which is headquartered in Munich, Germany, has an extensive sales and service network with locations in more than 70 countries.

www.rohde-schwarz.com

Sustainable product design

- ▶ Environmental compatibility and eco-footprint
- ▶ Energy efficiency and low emissions
- ▶ Longevity and optimized total cost of ownership

Certified Quality Management

ISO 9001

Certified Environmental Management

ISO 14001

Rohde & Schwarz training

www.training.rohde-schwarz.com

Rohde & Schwarz customer support

www.rohde-schwarz.com/support

