











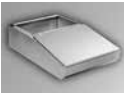









Operator Interface Enclosures

Operator Interface Enclosures

	Type 4, 4X Mild Steel and Stainless Steel Base Units Series 2000 Modular Console System 150		Heavy Duty 50/80 mm Suspension Systems HDSS Series NEMA 12, 13 169
	Type 4, 4X Mild Steel and Stainless Steel Desk Units Series 2000 Modular Console System 151		Type 12 Mild Steel Miniature Pushbutton Enclosures MPB Series..... 172
	Type 4, 4X Mild Steel and Stainless Steel Turret Units Series 2000 Modular Console System 152		Type 12 Mild Steel Pushbutton Enclosures 1435 Series 173
	Type 4, 4X Mild Steel and Stainless Steel Console Series 2000 Modular Console System 153		Type 4, 4X Stainless Steel Pushbutton Enclosures 1435SS Series..... 174
	Type 4, 4X Mild Steel and Stainless Steel Terminal Series 2000 Modular Console System 154		Type 12 Mild Steel Pushbutton Enclosures 1437 Series Extra Deep..... 175
	S2000 Accessories..... 155		Type 4, 4X Stainless Steel Pushbutton Enclosures 1437SS Series Extra Deep..... 176
	Type 12 Consolets 1488 Series Hinged Cover..... 162		Type 12 Mild Steel Pushbutton Enclosures 1489 Series Hinged Cover..... 177
	Type 12 Console Cabinet 1471 Series Sloped Front, Continuous Hinged Cover 163		Type 12 Mild Steel Pushbutton Enclosures 1490 Series Sloped Consolet 178
	Type 12 Modular Console Cabinet 1472 Series Sloped Front 164		Type 4, 4X Polycarbonate Pushbutton Enclosure 1554 PB Series..... 179
	Eclipse Command System - NEMA 12 ECP Series Command Enclosure..... 165		Type 4, 4X Polyester Pushbutton Enclosure PJPB Series 180
	Tara Plus Suspension System TPSS Series NEMA 12, 13 166		Type 4, 4X Polyester Pushbutton Enclosure PJPBLC Series..... 181

Configurations

Series 2000 Modular Console System

The Series 2000 Modular Console System offers designers numerous assembly and configuration choices. This system allows units to be “stacked” in multiple combinations to provide equipment support and display functions exactly where you want them.

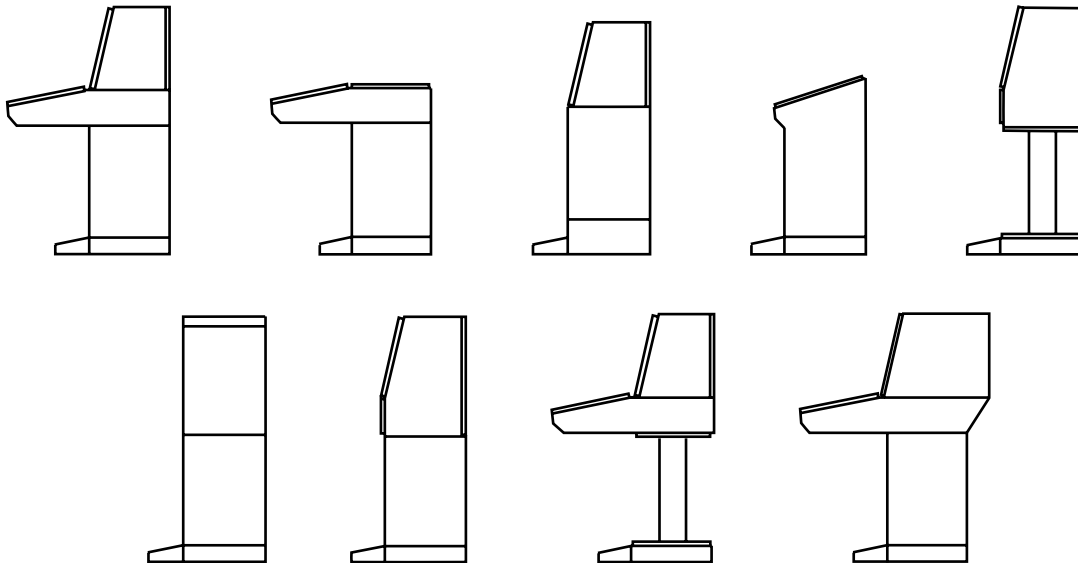

How to Configure your System

To configure your system you'll need to go through the following steps:

Step 1 - Protection requirements

- Type 4 RAL 7035 light gray = “2CL...” part numbers
- Type 4X stainless steel = “2CS...” part numbers

Step 2 - Width requirements (24, 36, 48, 60 inch)

Step 3 - Basic component requirements:

- Bottom - (a) base, (b) dual access base, or (c) pedestal
- Top - (a) standard desk and desk cover, (b) deep desk and desk cover, (c) standard turret, (d) deep turret, (e) standard desk/turret combination, (f) deep desk/turret combination, (g) another base and base cover, or (h) data terminal
- Stand Alone - Consolet

Step 4 - External Accessories (if applicable): plinth, footrest, window doors or depth extension

Step 5 - Internal Accessories (if applicable): electrical mounting panels, electronic mounting rails, swing frames, etc.

Type 4, 4X Mild Steel and Stainless Steel Base Units *Series 2000*

Modular Console System

Operator Interface Enclosures Modular Console System



Quick Link: hammfg.com/S2CB

Application

- Flexible design provides panel mount or rack mount capabilities for a variety of applications.
- Generally used in combination with other modular console components (ie. another base, terminal, desk and/or turret).
- Available in either single or dual access format.
- Smooth lines and clean edges provide an attractive, contemporary appearance.

Standards

- UL 508A Type 3R, 4, 12
- CSA Type 3R, 4, 12, 13
- EIA RS-310-D
- Complies with
 - NEMA Type 3R, 4, 12
 - IEC 60529, IP66

Construction

- Formed 14 gauge steel bodies with 14 gauge steel door.
- Also offered with formed 14 gauge 304 stainless steel bodies with 14 gauge 304 stainless steel door.
- Smooth, continuously welded seams.
- Body stiffeners are provided where required for increased strength and rigidity.
- Offered in 4 widths 24", 36", 48" and 60".
- Single access version has solid sides and back, solid door on front, open top, and closed bottom with removable access panel.
- Dual access version is same as above except has solid door on both front and back.
- 24" and 36" widths have single door on the front (and back for dual access) whereas 48" and 60" widths have two outside hinged doors on the front (and back for dual access).
- Doors can be hinged from either side on 24" and 36" units.

- Door profiles provide increased strength and are pre-punched to provide mounting options.
- Formed lip on enclosure excludes flowing liquids and contaminants.
- Slotted quarter turn oil-tight latches secure the door, with optional tamper resistant and locking latches available.
- Stainless steel models utilize stainless steel hardware.
- Oil resistant gaskets are permanently secured.
- Features several internal stud locations for mounting of various accessories.
- A bonding screw is provided on the door and a grounding stud is provided in the enclosure.

Finish

- Available in RAL 7035 light gray textured powder coating and natural stainless steel with a smooth, brushed finish.
- Base Covers are available in the same finishes.

Accessories

- S2000 Internal Components...*See Page 155*
- S2000 External Components...*See Page 159*
- Quarter Turn Assemblies...*See Page 273*
- Quarter Turn Inserts and Keys...*See Page 273*
- Padlock Adaptor...*See Page 272*
- Climate Control...*See Page 234*
- Lighting...*See Page 298*
- General Accessories...*See Page 268*

Single Access

RAL 7035 Light Gray Part No.	Stainless Steel Part No.	Enclosure		
		H	W	D
2CLB262418	2CSB262418	26.00	24.00	17.30
2CLB263618	2CSB263618	26.00	36.00	17.30
2CLB264818	2CSB264818	26.00	48.00	17.30
2CLB266018	2CSB266018	26.00	60.00	17.30

Dual Access

RAL 7035 Light Gray Part No.	Stainless Steel Part No.	Enclosure		
		H	W	D
2CLBX262418	2CSBX262418	26.00	24.00	16.50
2CLBX263618	2CSBX263618	26.00	36.00	16.50
2CLBX264818	2CSBX264818	26.00	48.00	16.50
2CLBX266018	2CSBX266018	26.00	60.00	16.50

Type 4, 4X Mild Steel and Stainless Steel Desk Units *Series 2000*

Modular Console System

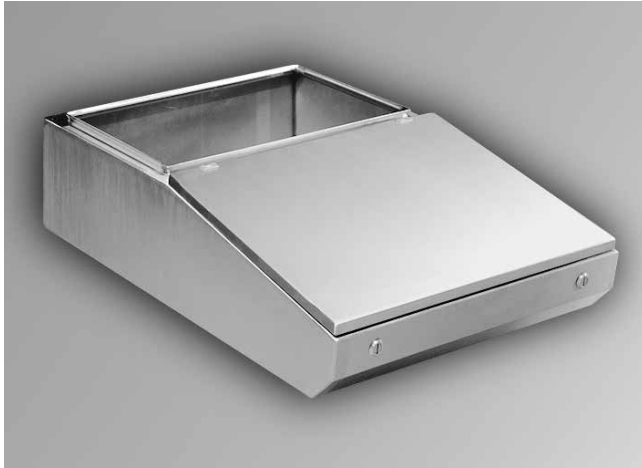

Quick Link: hammfg.com/S2CD

Application

- Generally used in combination with other modular console components (ie. base, pedestal, and/or turret).
- Provides an ideal sloped surface for mounting keyboards, switches, indicator lights, and/or dials.
- Open top permits mounting of a turret (usually for CRT applications) or an optional hinged desk cover (providing a flat, sturdy desk surface).
- Available in either Standard (will support Standard Turret only) or Deep (will support Deep Turret only) format.
- Smooth lines and clean edges provide an attractive, contemporary appearance.

Standards

- UL 508A Type 3R, 4, 12
- CSA Type 3R, 4, 12, 13
- EIA RS-310-D
- Complies with
 - NEMA Type 3R, 4, 12
 - IEC 60529, IP66

Construction

- Formed 14 gauge steel bodies with 14 gauge steel lid.
- Also offered with formed 14 gauge 304 stainless steel bodies with 14 gauge 304 stainless steel lid.
- Smooth, continuously welded seams without knockouts or holes.
- Body stiffeners are provided where required for increased strength and rigidity.
- Offered in 4 widths 24", 36", 48" and 60".
- Solid sides and back, lid on sloped top area, open on flat top area, bottom is solid under lid area and open under flat top area.
- Deep Desk has a 6.7" deeper top opening than standard desk allowing for support of Deep Turret - see drawings as Deep Desk has different profile (angled back) from Standard Desk (flat back.)
- Lid profiles provide increased strength.
- Formed lip on enclosure excludes flowing liquids and contaminants.
- Slotted quarter turn oil-tight latches secure the lid, with optional tamper resistant and locking latches available.
- Stainless steel models utilize stainless steel hardware.
- Oil resistant gaskets are permanently secured.
- Features several internal stud locations for mounting Desk Inner Panel.
- A bonding screw is provided on the lid and a grounding stud is provided in the enclosure.

Finish

- Available in RAL 7035 light gray textured powder coating and natural stainless steel with a smooth, brushed finish.
- Desk covers available in same finishes.

Accessories

- Desk Cover...See Page **161**
- Desk Inner Panel...See Page **155**

Standard Depth Desk

RAL 7035 Light Gray	Stainless Steel	Enclosure		
Part No.	Part No.	H	W	D
2CLD82436	2CSD82436	8.50	24.00	36.68
2CLD83636	2CSD83636	8.50	36.00	36.68
2CLD84836	2CSD84836	8.50	48.00	36.68
2CLD86036	2CSD86036	8.50	60.00	36.68

Extra Deep Desk

RAL 7035 Light Gray	Stainless Steel	Enclosure		
Part No.	Part No.	H	W	D
2CLD82443	2CSD82443	8.50	24.00	43.38
2CLD83643	2CSD83643	8.50	36.00	43.38
2CLD84843	2CSD84843	8.50	48.00	43.38
2CLD86043	2CSD86043	8.50	60.00	43.38

Technical references and CAD downloads available at www.hammondmfg.com

All dimensions in inches unless specified otherwise

Quality Products. Service Excellence.

Type 4, 4X Mild Steel and Stainless Steel Turret Units *Series 2000*

Modular Console System

Operator Interface Enclosures

Modular Console System



Quick Link: hammfg.com/S2CT

Application

- Ideal as a housing for video screens.
- Flexible design provides panel mount or rack mount capabilities for a variety of applications.
- Generally used in combination with other modular console components (ie. base, pedestal, and/or desk).
- Available in either Standard (supported by Base, Pedestal, or Standard Desk) or Deep (supported by Deep Desk only) format.
- Smooth lines and clean edges provide an attractive, contemporary appearance.

Standards

- UL 508A Type 3R, 4, 12
- CSA Type 3R, 4, 12, 13
- EIA RS-310-D
- Complies with
 - NEMA Type 3R, 4, 12
 - IEC 60529, IP66

Construction

- Formed 14 gauge steel bodies with 14 gauge steel doors. Also offered with formed 14 gauge 304 stainless steel bodies with 14 gauge 304 stainless steel doors.
- Smooth, continuously welded seams without knockouts or holes.
- Body stiffeners are provided where required for increased strength and rigidity.
- Offered in 4 widths 24", 36", 48" and 60".
- Features solid sides and top, solid door on front (opens down) and back (opens up), and open bottom.

- Front door features sliding rod mechanism, which allows a 102° opening when in the lowered position.
- Rear door features manual, 3 position adjustable door stop which provides convenient support while door in open position.
- Formed lip on enclosure excludes flowing liquids and contaminants.
- Slotted quarter turn oil-tight latches secure the door, with optional tamper resistant and locking latches available.
- Stainless steel models utilize stainless steel hardware.
- Oil resistant gaskets are permanently secured.
- Features several internal stud locations for mounting of various accessories.
- A bonding screw is provided on the door and a grounding stud is provided in the enclosure.

Finish

- Available in RAL 7035 light gray textured powder coating and natural stainless steel with a smooth, brushed finish.
- 24" Front Window Door available in same finishes.

Accessories

- S2000 Internal Components...*See Page 155*
- S2000 External Components...*See Page 159*
- Quarter Turn Assemblies...*See Page 273*
- Quarter Turn Inserts and Keys...*See Page 273*
- Padlock Adaptor...*See Page 272*
- Climate Control...*See Page 234*
- Lighting...*See Page 298*
- General Accessories...*See Page 268*

Standard Depth Turret

RAL 7035 Light Gray Part No.	Stainless Steel Part No.	Enclosure			
		H	W	D1	D2
2CLT202436	2CST202436	20.00	24.00	12.38	16.62
2CLT203636	2CST203636	20.00	36.00	12.38	16.62
2CLT204836	2CST204836	20.00	48.00	12.38	16.62
2CLT206036	2CST206036	20.00	60.00	12.38	16.62

Extra Deep Turret

RAL 7035 Light Gray Part No.	Stainless Steel Part No.	Enclosure			
		H	W	D1	D2
2CLT202443	2CST202443	20.00	24.00	16.62	23.31
2CLT203643	2CST203643	20.00	36.00	16.62	23.31
2CLT204843	2CST204843	20.00	48.00	16.62	23.31
2CLT206043	2CST206043	20.00	60.00	16.62	23.31

Type 4, 4X Mild Steel and Stainless Steel Consolet *Series 2000*

Modular Console System



Quick Link: hammfg.com/S2CC

Application

- Serves as an economical housing for operator interface applications.
- Provides an ideal sloped surface for mounting keyboards, switches, indicator lights, and/or dials.
- Provides panel mounting capabilities for a variety of applications. Generally used as a stand alone enclosure. Possible to put side by side with base on a single plinth (ie. 36" wide consolet with 24" base with terminal all together on a 60" plinth).
- Optional casters (require plinth) allow for a completely mobile, NEMA rated work station.
- Smooth lines and clean edges provide an attractive, contemporary appearance.

Standards

- UL 508A Type 3R, 4, 12
- CSA Type 3R, 4, 12, 13
- EIA RS-310-D
- Complies with
 - NEMA Type 3R, 4, 12
 - IEC 60529, IP66

Construction

- Formed 14 gauge steel bodies with 14 gauge steel door and lid.
- Also offered with formed 14 gauge 304 stainless steel bodies with 14 gauge 304 stainless steel door and lid.
- Smooth, continuously welded seams without knockouts or holes.
- Body stiffeners are provided where required for increased strength and rigidity.
- Offered in 4 widths 24", 36", 48" and 60".
- Has solid sides and back, solid door on front, 3 point adjustable lid on sloped (20°) top, and closed bottom with removable access panel.
- 24" and 36" widths have single door on the front whereas 48" and 60" widths have two outside hinged doors on the front.
- Doors can be hinged from either side on 24" and 36" units.
- Door profiles provide increased strength and are pre-punched to provide mounting options.
- Formed lip on enclosure excludes flowing liquids and contaminants.
- Slotted quarter turn oil-tight latches secure the door and lid, with optional tamper resistant and locking latches available.
- Stainless steel models utilize stainless steel hardware.
- Oil resistant gaskets are permanently secured.
- Features internal stud locations for mounting optional inner panel.
- A bonding screw is provided on the door and a grounding stud is provided in the enclosure.

Finish

- Available in RAL 7035 light gray textured powder coating and natural stainless steel with a smooth, brushed finish.

Accessories

- Consolet Panel...*See Page 155*
- Quarter Turn Assemblies...*See Page 273*
- Quarter Turn Inserts and Keys...*See Page 273*
- Modular Plinth...*See Page 160*
- Footrest...*See Page 160*
- Climate Control...*See Page 234*
- Padlock Adaptor...*See Page 272*
- Lighting...*See Page 298*
- General Accessories...*See Page 268*

RAL 7035 Light Gray	Stainless Steel	Enclosure			
Part No.	Part No.	H1	H2	W	D
2CLC2024	2CSC2024	30.36	38.03	24.00	17.30
2CLC2036	2CSC2036	30.36	38.03	36.00	17.30
2CLC2048	2CSC2048	30.36	38.03	48.00	17.30
2CLC2060	2CSC2060	30.36	38.03	60.00	17.30

Type 4, 4X Mild Steel and Stainless Steel Terminal *Series 2000*

Modular Console System

Operator Interface Enclosures

Modular Console System



Quick Link: hammfg.com/S2CDT

Application

- Ideal as a housing for a complete personal computer system including video screen, keyboard and PLC.
- Flexible design provides panel mount or rack mount capabilities for a variety of applications.
- Generally used in combination with other modular console components (ie. base or pedestal). Mounting on base provides extra room for PLC's and/or printer-paper stands.
- Optional casters (require plinth) allow for a completely mobile, NEMA rated work station.
- Smooth lines and clean edges provide an attractive, contemporary appearance.

Standards

- UL 508A Type 3R, 4, 12
- CSA Type 3R, 4, 12, 13
- EIA RS-310-D
- Complies with
 - NEMA Type 3R, 4, 12
 - IEC 60529, IP66

Construction

- Formed 14 gauge steel bodies with 14 gauge steel doors.
- Also offered with formed 14 gauge 304 stainless steel bodies with 14 gauge 304 stainless steel doors.
- Smooth, continuously welded seams.
- Body stiffeners are provided where required for increased strength and rigidity.
- Offered in 24" width only.
- Features solid sides and top, 2 solid doors on front (both open downlower, smaller door for keyboard shelf and back (opens up), and open bottom.
- Lower drop down door provides access to optional slide-out keyboard drawer.
- Front doors feature sliding rod mechanism which allows a 102° opening when in the lowered position.
- Rear door features manual, 3 position adjustable door stop which provides convenient support while door in open position.
- Formed lip on enclosure excludes flowing liquids and contaminants.
- Slotted quarter turn oil-tight latches secure the door, with optional tamper resistant and locking latches available.
- Stainless steel models utilize stainless steel hardware.
- Oil resistant gaskets are permanently secured.
- Features several internal stud locations for mounting of various accessories.
- A bonding screw is provided on the door and a grounding stud is provided in the enclosure.

Finish

- Available in RAL 7035 light gray textured powder coating and natural stainless steel with a smooth, brushed finish.
- 24" Front Window Door available in same finishes.

Accessories

- S2000 Internal Components...*See Page 155*
- S2000 External Components...*See Page 159*
- Quarter Turn Assemblies...*See Page 273*
- Quarter Turn Inserts and Keys...*See Page 273*
- Padlock Adaptor...*See Page 272*
- Climate Control...*See Page 234*
- Lighting...*See Page 298*
- General Accessories...*See Page 268*

RAL 7035 Light Gray	Stainless Steel	Enclosure			
Part No.	Part No.	H	W	D1	D2
2CLD24R	2CSD24R	28.50	24.00	16.63	12.38

Base Panel



- 14 gauge steel panels are finished in white.
- Used in both single access and dual access bases.
- Available in 4 widths.
- Mounts into “C” Channel Mounting Kit (not included.)
- Hardware required for mounting into “C” channels is included.

Part No.	Fits Base			
	Width	Height	Width	Depth
2CWBP24	24.00	22.50	20.00	0.75
2CWBP36	36.00	22.50	32.00	0.75
2CWBP48	48.00	22.50	44.00	0.75
2CWBP60	60.00	22.50	56.00	0.75

Consolet Panel



- 12 gauge steel panels.
- Available in 4 widths.
- Mounts onto panel mounting studs in consolet.
- Finished in white.

Part No.	Fits			
	Consolet Width	Height	Width	Depth
2CWCP24	24.00	30.50	20.50	0.75
2CWCP36	36.00	30.50	32.50	0.75
2CWCP48	48.00	30.50	44.50	0.75
2CWCP60	60.00	30.50	56.50	0.75

Desk Inner Panel

- 12 gauge steel panels.
- Used in both Standard and Deep desks.
- Available in 4 widths.
- Mounts horizontally onto panel mounting channels in bottom of desk.
- Finished in white.

Part No.	Fits			
	Consolet Width	Height	Width	Depth
2CWDP24	24.00	0.50	22.00	16.00
2CWDP36	36.00	0.50	34.00	16.00
2CWDP48	48.00	0.50	46.00	16.00
2CWDP60	60.00	0.50	58.00	16.00

Terminal Keyboard Shelf



- Designed specifically for use in Data Terminal.
- Sloped wrist rest provides comfort for operator.
- Locks in place when extended.
- 20" width accommodates standard width keyboards.
- Finished in textured black.
- Slides included.
- Slide-out mouse pad (left or right) included.

Part No.	Height	Width	Depth
2CWDSR	3.88	20	15.63

Swing Frame

For use with Series 2000 Enclosures

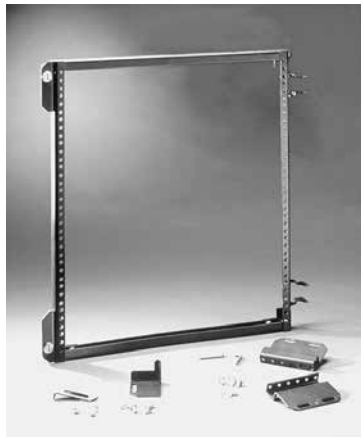

- Available in 19" and 24" widths.
- Variable depth feature allows front to rear adjustment.
- Installs with either left or right hinging.
- Mounts onto Rail Support Kits (not included).
- Clip nuts required for mounting to punched rails.
- Finished in textured black.

Part No.	Fits Console Unit	Fits Console Size	Panel			
			Width	Height	A	B
2CSFT19	Turrets/Terminal	24,36,48,60	19"	8U	15.75	19.28
2CSFT24	Turrets/Terminal	36,48,60	24"	8U	15.75	24.28
2CSFB19	Bases	24,36,48,60	19"	12U	22.09	19.28
2CSFB24	Bases	36,48,60	24"	12U	22.09	24.28

"C" Channel Mounting Kit

- For use in Turrets, Data Terminals and Bases.
- Provide adjustable (side to side) mounting support for Base Panels and all Rail Support Kits.
- Available in 4 widths.
- Finished in textured black.



Part No.	Fits Console Width	A
2CMC24	24.00	23.50
2CMC36	36.00	33.50
2CMC48	48.00	47.50
2CMC60	60.00	59.50

Rail Support Kit

- Separate kits for Standard Turret/Data Terminal, Deep Turret and Bases.
- For use with Swing Frame, CRT Mounting Kit and Combination Rails.
- Mount into "C" channels (not included).
- Finished in textured black.

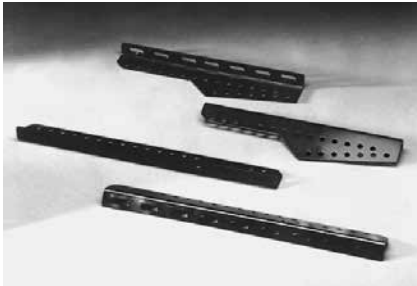

Part No.	Fits Console Unit
2CTRSK36	Turret/Terminal
2CTRSK43	Deep Turret
2CBRSK	Base

Combination Rails

- Features punched universal EIA spacing.
- Mounts onto Rail Support Kits (not included - see above).
- Clip nuts required for mounting to punched rails
- Finished in black.

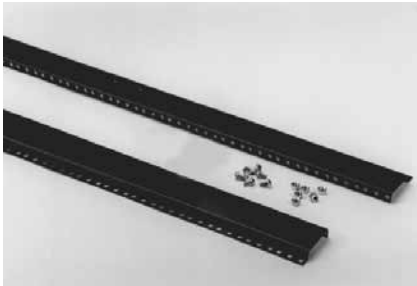

Part No.	Units	Fits Console Unit
2CTRK	9	Turrets/Terminal
2CBRK	13	Base

CRT Mounting Kit

- Adjustable width allows for mounting of most CRT models.
- For use in Turrets or Data Terminal.
- Mounts onto Rail Support Kits (not included - see above).
- Finished in textured black.

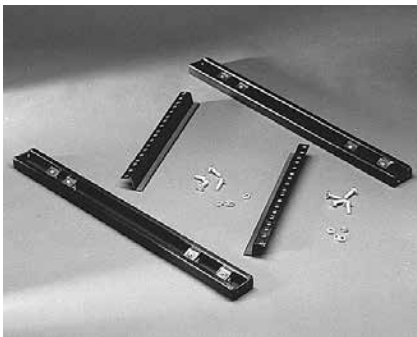

Part No.	2CRTK

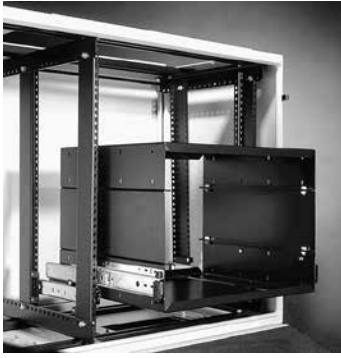

Printer and Paper Stand

- Provides convenient pullout access and support for printers in bases.
- Two versions available for high or low applications.
- Mounts onto Combination Rails (not included).
- Finished in textured black.
- Slides included.

Part No.	Description	Height
2CLPS	Low Printer Stand	7.00
2CHPS	High Printer Stand	12.25



Gas Filled Door Support

- Provide "lift assist" and door support for rear Turret/Data Terminal doors and Desk lids.
- Replace standard manual door supports.
- Minimum enclosure width of 16" is required
- Finished in black.
- Sold individually.
- Recommend 1 for 24"/36" and 2 for 48"/60".

Part No.	2CDSTP
----------	--------

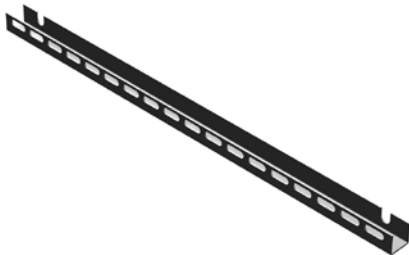

DIN Rail Support Kit

- Provide adjustable mounting support for DIN rails (sold separately.)
- For use in Bases only.
- Mount into "C" channels (not included).

Part No.	2CDMK
----------	-------

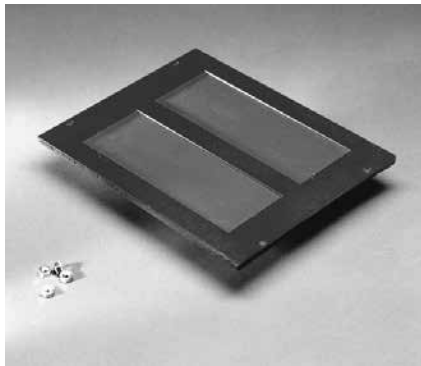

Micro Cell Cable Entry Kit

- For use in Single or Dual Access Bases.
- Constructed of 14 gauge steel.
- Features 2 cutouts for cable access.
- Underside of cutouts covered with black foam rubber, which when punctured for cable access, still maintains a virtually sealed bottom.
- Finished in textured black.

Part No.	2CMBPK
----------	--------



Mobile Keyboard Support

- Installs easily at any location along front of Desks or Consolet.
- Provides temporary keyboard support.
- 20" width accommodates standard width keyboards.
- Finished in textured black.

Part No.	
	2CMKS75



Pedestal

- Maintains NEMA rating of system.
- Formed 14 gauge steel.
- Also offered with formed 14 gauge stainless steel.
- Stiffeners added for solid stability.
- Open top and bottom provides an unobstructed wireway for pull through cabling.
- Can be mounted directly on floor or on a plinth.
- Available in light gray and stainless steel.

Part No.	Finish
2CLS	RAL7035 Light Gray
2CSS	Stainless Steel



Data Terminal Extension Ring

- Formed 14 gauge steel.
- Adds 6" to Data Terminal Depth.
- Maintains NEMA rating.
- Utilizes door from Data Terminal.
- Fastens flush to back of Data Terminal.
- Available in light gray and natural stainless steel.

Part No.	Finish
2CLD24X	ANSI 61 Gray (smooth)
2CSD24X	Stainless Steel



Turret/Terminal Window Door

- Maintains the NEMA rating of the enclosure.
- Constructed of 14 gauge steel and lexan window.
- Easy field installation.
- Fits Standard Turret, Deep Turret, and Data Terminal.
- Offered in 24" width only.
- Available in light gray and stainless steel.

Part No.	Finish
2CLTW24	RAL7035 Light Gray (textured)
2CSTW24	Stainless Steel

Modular Plinth



- Features removable front and rear panels for easy access to bottom for cabling or transport by forklift.
- For cable access, features 3 double knockouts on each end.
- Available in 4" and 8" heights.
- Available in 24", 36", 48" and 60" widths.
- Maintains NEMA rating of system.
- Formed 14 gauge steel.
- Also offered with formed 14 gauge stainless steel.
- Available in light gray and stainless steel.

RAL 7035 Light Gray		Stainless Steel		
Part No.	Part No.	A	B1	B2
2CLP42418	2CSP42418	4.00	24.00	-
2CLP43618	2CSP43618	4.00	36.00	-
2CLP44818	2CSP44818	4.00	-	48.00
2CLP46018	2CSP46018	4.00	-	60.00
2CLP82418	2CSP82418	8.00	24.00	-
2CLP83618	2CSP83618	8.00	36.00	-
2CLP84818	2CSP84818	8.00	-	48.00
2CLP86018	2CSP86018	8.00	-	60.00

Footrest



- Generally used in combination with plinth.
- Provides a raised foot support to relieve back stress.
- Gives the installation a "finished" appearance.
- Available in 24", 36", 48" and 60" widths.
- Maintains NEMA rating of system.
- Formed 14 gauge steel.
- Also offered with formed 14 gauge stainless steel.
- Rubber tread for added traction on footrest surface.
- Available in light gray and natural stainless steel.

RAL 7035 Light Gray		Stainless Steel	
Part No.	Part No.	B	
2CLF24	2CSF24	24.00	
2CLF36	2CSF36	36.00	
2CLF48	2CSF48	48.00	
2CLF60	2CSF60	60.00	

Base Cover



- Should be used to close top opening (of either single or dual access) base when no other components are mounted on the base's top.
- Constructed of 14 gauge steel.
- Available light gray and stainless steel.
- Can also be used on the underside of a Standard Desk Unit, Standard Turret and Data Terminal.

RAL 7035 Light Gray		Stainless Steel	
Part No.	Part No.	B	
2CLBC2436	2CSBC2436	24.00	
2CLBC3636	2CSBC3636	36.00	
2CLBC4836	2CSBC4836	48.00	
2CLBC6036	2CSBC6036	60.00	

Desk Cover



- For use when no turret is used on top of desk.
- Provides a hinged, flat, sturdy desk surface.
- Available for either Standard or Deep desks.
- Constructed of 14 gauge steel.
- Features quarter turn latches for easy access into flat desk top.
- Available in light gray and stainless steel.

RAL 7035 Light Gray		Stainless Steel			
Part No.	Part No.	B1	B2	B3	C
Standard Depth Desk Cover					
2CLDC2436	2CSDC2436	23.75	-	-	16.38
2CLDC3636	2CSDC3636	-	35.75	-	16.38
2CLDC4836	2CSDC4836	-	-	47.75	16.38
2CLDC6036	2CSDC6036	-	-	59.75	16.38
Deep Depth Desk Cover					
2CLDC2443	2CSDC2443	23.75	-	-	24.03
2CLDC3643	2CSDC3643	-	35.75	-	24.03
2CLDC4843	2CSDC4843	-	-	47.75	24.03
2CLDC6043	2CSDC6043	-	-	59.75	24.03

Base Window Door



- Maintains the NEMA rating of the enclosure.
- Constructed of 14 gauge steel and lexan window.
- Easy field installation.
- Available for the 4 base widths.
- On 2 door units, a window can be installed on one side only.
- Available in light gray and stainless steel.

RAL 7035 Light Gray		Stainless Steel		Fits Base	
Part No.	Part No.	Width	B	C	
2CLBW24	2CSBW24	24.00	23.75	16.75	
2CLBW36	2CSBW36	36.00	35.75	28.75	
2CLBW48	2CSBW48	48.00	23.75	16.75	
2CLBW60	2CSBW60	60.00	29.75	22.75	

Console Casters



- Locking and non-locking versions.
- Mount directly to plinths.
- Sold in pairs to provide ability to mix locking and non-locking.
- Recommend 4 casters for 24"/36" and 6 casters for 48"/60".
- Weight capacity of 500 lbs. per pair.

Part No.	Type	No. of Casters
2CCSTL	Locking	2
2CCSTN	Non-Locking	2

Type 12 Consolets *1488 Series*

Hinged Cover

Operator Interface Enclosures

Consolet Enclosures



Quick Link: hammfg.com/1488

Application

- Designed for use as electric, hydraulic or pneumatic control and instrument enclosures.
- Ideal for flat or surface mounting/pedestal to provide the necessary 30° or 60° control slope.
- Provides protection from dirt, dust, oil and water.

Standards

- UL 508A Type 12, 13
- CSA Type 12, 13
- Complies with
 - NEMA Type 12, 13
 - IEC 60529, IP54

Construction

- Formed 14 gauge steel.
- Smooth, continuously welded seams.
- Construction provides either 30° or 60° slope on front cover depending on mounting position.
- Continuously hinged cover may be removed by pulling the hinge pin.
- Captive cover screws thread into sealed wells.
- Oil resistant gasket and adhesive.
- A bonding stud is provided on the door and a ground stud is provided on the enclosure.

Finish

- Cover and enclosure are phosphatized and finished in ANSI 61 gray powder coating.

Accessories

- Pedestal and Base...*See Page 303*
- Climate Control...*See Page 234*
- General Accessories...*See Page 268*

Part No.	Cover H	Enclosure			
		H1	H2	W	D
1488EE7	8.00	2.50	7.16	8.00	7.44
1488EH7	8.00	2.50	7.16	12.00	7.44
1488EJ7	8.00	2.50	7.16	16.00	7.44
1488EL7	8.00	2.50	7.16	20.00	7.44
1488HH9	12.00	2.50	9.16	12.00	10.90
1488HJ9	12.00	2.50	9.16	16.00	10.90
1488HL9	12.00	2.50	9.16	20.00	10.90
1488HN9	12.00	2.50	9.16	24.00	10.90
1488JJ11	16.00	2.50	11.16	16.00	14.37
1488JL11	16.00	2.50	11.16	20.00	14.37
1488JN11	16.00	2.50	11.16	24.00	14.37
1488JQ11	16.00	2.50	11.16	30.00	14.37
1488JS11	16.00	2.50	11.16	36.00	14.37
1488LL13	20.00	2.50	13.16	20.00	17.83
1488LN13	20.00	2.50	13.16	24.00	17.83
1488LQ13	20.00	2.50	13.16	30.00	17.83

Type 12 Console Cabinet 1471 Series

Sloped Front, Continuous Hinged Cover



Quick Link: hammfg.com/1471

Application

- Designed to house electrical, electronic, hydraulic or pneumatic controls and instruments.
- Heavy-duty construction provides protection from dirt, dust, oil and water.
- Sloping front control panel provides an ideal surface for mounting operator controls or instrumentation.
- Interior mounting provision on removable inner panels located on the rear and sides of the enclosure.

Standards

- UL 508A Type 12
- CSA Type 12
- Complies with
 - NEMA Type 12
 - IEC 60529, IP54

Construction

- Formed 14 gauge steel.
- Smooth, continuously welded seams, without knockouts, cutouts or holes.
- Sloped front instrument panel is continuously hinged on the front (bottom) edge and secured with captive panel screws, threaded into sealed wells.
- Continuously hinged door and front instrument panel may be removed by pulling the hinge pin.
- Doors are secured with a three point latch and operated with a key locking automotive type handle.
- Oil resistant gaskets are permanently secured.
- Includes three removable inner panels formed from 12 gauge steel, mounted to the back and sides of the enclosure interior.

- Collar studs are provided for mounting inner panels.
- A bonding stud is provided on the door and a grounding stud is provided in the enclosure for each door.
- A literature pocket is provided for the inside of the door.

Finish

- Cover and enclosure are phosphatized and finished in ANSI 61 gray powder coating on the outside and on the inside.
- Removable inner panels are finished in white powder coating.

Accessories

- Door Stop Kit...*See Page 304*
- Type 12 Handle Kits...*See Page 271*
- Window Kits...*See Page 294*
- Climate Control...*See Page 234*
- Lighting...*See Page 298*
- General Accessories...*See Page 268*

Part No.	Enclosure				Panel	
	H1	H2	W	D	H	W
1471C24	32.00	48.00	24.00	18.00	27.00	17.00
1471C36	32.00	48.00	36.00	18.00	27.00	29.00

Type 12 Modular Console Cabinet 1472 Series

Sloped Front

 Operator Interface Enclosures
Console Enclosures

 Quick Link: hammfg.com/1472

Application

- Designed to house electrical, electronic, hydraulic or pneumatic controls and instruments.
- Heavy-duty construction provides protection from dirt, dust, oil and water. Sloping front control and instrument panels provide an ideal surface for mounting operator controls or instrumentation.
- Interior mounting is provided for with a removable inner panel located on the rear of the basic console.

Standards

- UL 508A Type 12
- CSA Type 12
- Complies with
 - NEMA Type 12
 - IEC 60529, IP65

Base Console Construction

- Formed 14 gauge steel.
- Smooth, continuously welded seams, without knockouts, cutouts or holes.
- Sloped front instrument panel is continuously hinged on the front (bottom) edge and secured with captive panel screws, threaded into sealed wells.
- Front instrument panel may be removed by pulling the hinge pin.
- Flush doors are secured with a three point latch and operated with a key locking automotive type handle.
- Two door model has overlapping front doors, with three point latch on right door.
- Oil resistant gaskets are permanently secured.

- Includes a removable inner panel formed from 12 gauge steel, mounted to the back of the enclosure interior.
- Collar studs are provided for mounting inner panels.
- A bonding stud is provided on the door and a grounding stud is provided in the enclosure for each door.
- A literature pocket is provided.

Turret Construction

- Formed and welded from 14 gauge steel.
- Sloping instrument panel and vertical rear access are completely removable.
- Captive panel screws fasten into sealed wells.

Writing Surface Construction

- Formed and welded from 14 gauge steel.
- Fastens to the front of the console with screws

Finish

- Cover and enclosure are phosphatized and finished in ANSI 61 gray powder coating on the outside and on the inside.
- Removable inner panels are finished in white powder coating.

Accessories

- Door Stop Kit...*See Page 304*
- Type 12 Handle Kits...*See Page 271*
- Window Kits...*See Page 294*
- Climate Control...*See Page 234*
- Lighting...*See Page 298*
- General Accessories...*See Page 268*

Base Console

Part No.	Enclosure					Panel	
	H1	H2	W	D1	D2	H	W
1472-24 ¹	36.00	40.00	24.00	17.00	20.00	18.75	27.25
1472-36 ¹	32.00	36.00	36.00	20.00	24.00	30.00	32.00
1472-48 ^{1,2}	32.00	36.00	48.00	20.00	24.00	42.00	32.00

¹ UL Listed

² 2 Door Version

Turret

Part No.	H	W	D1	D2
1472-24T	16.00	24.00	5.00	3.00
1472-36T	20.00	36.00	10.00	6.00
1472-48T	20.00	48.00	10.00	6.00

Writing Surface

Part No.	H	W	D
1472-24W	4.00	24.00	10.00
1472-36W	4.00	36.00	10.00
1472-48W	4.00	48.00	10.00

Eclipse Command System - NEMA 12 *ECP Series*

Command Enclosure



Quick Link: hammfg.com/ECP

Application

- Designed to enclose electronic controls, instruments and components in indoor environments where dirt, dust, oil and water may be present.
- Ideal for use with suspension systems.
- Multiple mounting provisions and full front mounting space provide for ideal operator interface.
- Smooth flush surfaces and attractive finishes compliment high tech equipment.

Part No.	Enclosure			Optional Panel
	H	W	D	Part No.
ECP12126	12.00	12.00	6.00	ECPP1212
ECP12168	12.00	16.00	8.00	ECPP1216
ECP161610	16.00	16.00	10.00	ECPP1616
ECP162010	16.00	20.00	10.00	ECPP1620
ECP20246	20.00	24.00	6.00	ECPP2024
ECP202412	20.00	24.00	12.00	ECPP2024

Standards

- UL 508A Type 12
- CSA Type 12
- Complies with
 - NEMA Type 12 and 13
 - IEC 60529, IP54

Construction

- Formed from 16 gauge steel.
- Smooth, continuously welded seams ground smooth.
- Door stiffeners are designed to also permit additional mounting options.
- Formed lip on enclosure to exclude flowing liquids and contaminants.
- Reversible rear door is secured with slotted quarter turn fasteners.
- Door frames have zinc die-cast corners with extrusion pressed aluminum profiles.
- Door front panels are 3mm aluminum.
- Oil resistant gaskets are permanently secured.
- Bonding stud provided on door and grounding stud installed in enclosure.
- Quarter turn latches formed from mild steel.
- Formed steel hinge with stainless steel hinge pins.
- Fastening is recommended with optional Tara Plus or 50/80 suspension systems.
- Optional red handle easily mounts horizontally to bottom of enclosure front frame. Order separately.
- Heavy duty re-inforcing plate included.

Finish

- Finished in RAL 7040 gray powder coating.
- Door panel is natural aluminum.

Eclipse Command System Handle



- Easily mounts horizontally to bottom of enclosure front frame.
- Finished in red.

Part No.	Fits Enclosure
ECPH12	ECP12126
ECPH16	ECP12168, ECP161610
ECPH20	ECP1620
ECPH24	ECP202412, ECP20246

Eclipse Command System Inner Panel



- Panel mounts on the rear door of command enclosures.
- Unfinished aluminum is 0.08" thick.

Part No.	H	W
ECPP1212	10.00	8.25
ECPP1216	10.00	12.25
ECPP1616	14.00	12.25
ECPP1620	14.00	16.25
ECPP2024	18.00	20.25

Technical references and CAD downloads available at www.hammondmfg.com

All dimensions in inches unless specified otherwise

Quality Products. Service Excellence.

Tara Plus Suspension System *TPSS Series*

NEMA 12, 13



Application

- Taraplus enclosure suspension systems are designed for light and medium loads.
- The strength of tube and cast fittings provide a highly flexible robust system.

Standards

- Complies with
 - IEC 60529 IP54

Construction

- Enclosure coupling and elbow coupling fittings are die-cast from G AL SI 12 aluminum.
- Suspension tubing is steel.

Finish

- Fittings are finished in RAL 7040 window gray.
- Suspension tubing is RAL 7035 light gray.

Quick Link: hammfg.com/TPSS

Tara Plus Suspension Tube

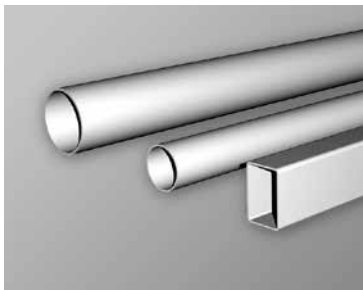

Part No.	Outside	Inside	Tolerance	Length	
	mm	mm		Metres	Feet
Round Tubes					
R144-301-000	48	42	±0.25	1	3.28
R144-321-000	70	62	±0.25	1	3.28
R144-321-500	70	62	±0.25	1.5	4.92
Rectangular Tubes					
R144-311-000	60 x 40	54 x 34	±0.50	1	3.28
R144-311-500	60 x 40	54 x 34	±0.50	1.5	4.92

Tara Plus Coupling



- Attaches to enclosure.
- Accepts 48mm round tube, perpendicular to enclosure top/bottom.
- Die-cast Aluminum G Al Si 12.
- Adjustable torque resistance.
- Rotates 300°.

Part No.	Mounting Position
R149-025-500	Top
R149-025-501	Bottom

Tara Plus Tilt Coupling



- Attaches to enclosure.
- Accepts 48mm round tube perpendicular to enclosure top/bottom.
- Die-cast Aluminum G Al Si 12.
- Rotates 300°.
- Features an adjustable tilt mechanism up to 35°.

Part No.	R149-025-001

Technical references and CAD downloads available at www.hammondmfg.com

All dimensions in inches unless specified otherwise

Tara Plus Elbow Coupling

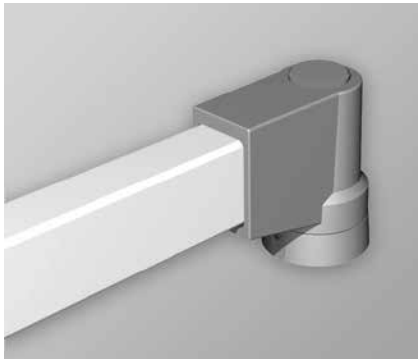

- Attaches to enclosure.
- Accepts 60x40mm rectangular tube parallel to enclosure top/bottom.
- Die-cast Aluminum G Al Si 12.
- Adjustable torque resistance.
- Rotates 300°.
- Accessible from the top.

Part No. R149-035-000

Tara Plus Tilt Elbow Coupling

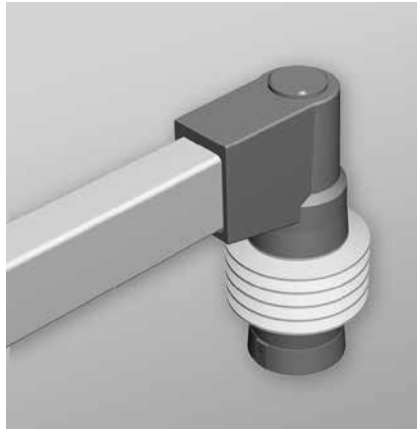

- Attaches to enclosure.
- Accepts 60x40mm rectangular tube parallel to enclosure top/bottom.
- Die-cast Aluminum G Al Si 12.
- Rotates 300°.
- Features an adjustable tilt mechanism up to 35°.

Part No. R149-035-001

Tara Plus Fixed Elbow 48



- For use with 48mm round tube and 60x40mm rectangular tube.
- Vertical 48mm tube connection for use with Couplings only (not Base 48).
- Die-cast Aluminum G Al Si 12.
- Large cover opening for easier cable pull through.
- No rotation.
- Accessible from the top.

Part No. R149-020-000

Tara Plus Fixed Elbow 70



- For use with 70mm round tube and 60x40mm rectangular tube.
- Die-cast Aluminum G Al Si 12.
- No rotation.
- Accessible from the top.

Part No. R149-020-001

Tara Plus Rotating Elbow



- For use with 70mm round tube and 60x40mm rectangular tube.
- Die-cast Aluminum G Al Si 12.
- Rotates 300°.
- Accessible from the top.

Part No. R149-040-000

Tara Plus Base 48



- For use with 48mm round tube.
- Not for use with any horizontal configurations.
- Compatible with tube up or tube down configurations.
- Die-cast Aluminum G Al Si 12.
- No rotation.

Part No. R149-030-000

Tara Plus Base 70



- For use with 70 mm tube.
- Compatible with all vertical and horizontal configurations.
- Compatible with tube up or tube down configurations.
- Die-cast Aluminum G Al Si 12.
- No rotation.

Part No. R149-030-001

Tara Plus Rotating Base 70

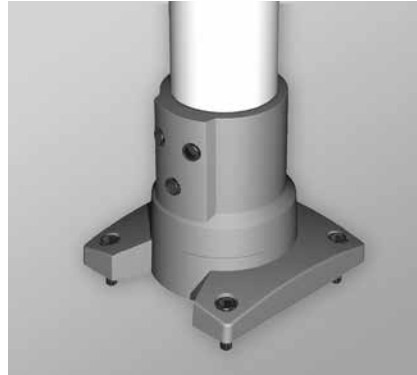

- For use with 70 mm tube.
- Compatible with all vertical and horizontal configurations.
- Compatible with tube up or tube down configurations.
- Die-cast Aluminum G Al Si 12.
- Rotates 300°.
- Integrated movement stop.
- Service free bearings.

Part No. R149-005-001

Tara Plus Socket Joint

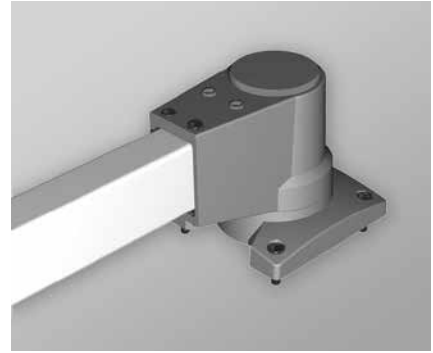

- Accepts 60x40mm rectangular tube parallel to its mounting surface.
- Die-cast Aluminum G Al Si 12.
- Integrated movement stop.
- Service free bearings.
- Rotates 300°.
- Adjustment screws (red screws).
- Accessible from the top.

Part No. R149-005-000

Tara Plus Wall Joint



- Accepts 60x40mm rectangular tube perpendicular to its mounting surface.
- Die-cast Aluminum G Al Si 12.
- Rotates 186°.
- Accessible from the top.

Part No. R149-010-000

Tara Plus Vertical Wall Joint



- Accepts 70mm tube parallel to its mounting surface.
- Die-cast Aluminum G Al Si 12.
- Rotates 316°.

Part No. R149-010-001

Tara Plus Intermediate Joint

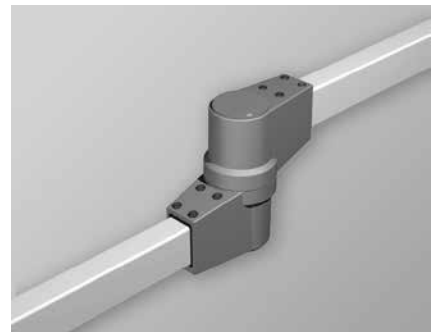

- Accepts 60x40mm rectangular tube.
- Die-cast Aluminum G Al Si 12.
- Integrated movement stop.
- One piece bellow.
- Rotates 300°.

Part No. R149-015-000

Heavy Duty 50/80 mm Suspension Systems *HDSS Series*

NEMA 12, 13

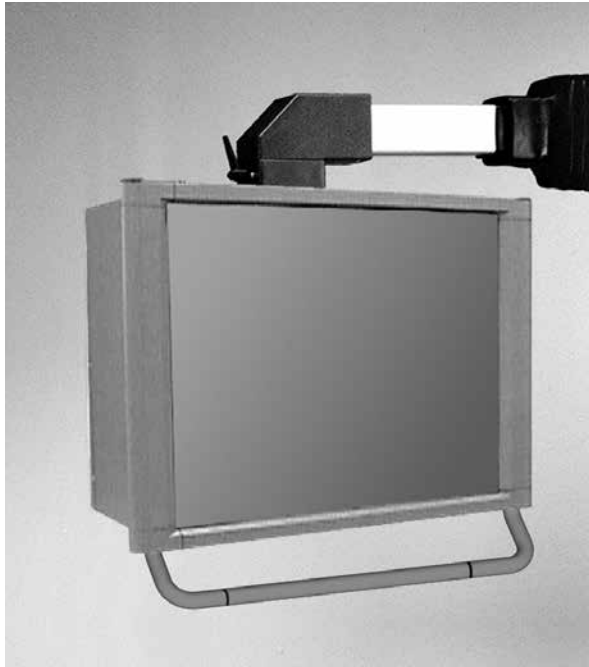

Application

- Command 50mm and 80mm enclosure suspension systems are designed for medium and heavy loads.
- The strength of square tube and cast fittings provide a highly flexible, robust system.

Standards

- Complies with
 - IEC 60529 IP54

Construction

- Enclosure coupling and elbow coupling fittings are die-cast from G Al Si 12 aluminum.
- All other fittings are die-cast 4G-s.g. iron.
- Suspension tubing is steel.

Finish

- Fittings are finished in RAL 7040 window gray powder coating.
- Suspension tubing is RAL 7035 light gray powder coating.

Quick Link: hammfg.com/HDSS

Heavy Duty Suspension Tube



Part No.	Outside	Inside	Tolerance	Length	
	mm	mm		Metres	Feet
R144-021-000R	50	40	±0.5	1	3
R144-022-000R	Square			2	7
R144-041-000R	80	70	±0.6	1	3
R144-042-000R	Square			2	7

Note: Table dimensions in mm.

Heavy Duty Enclosure Coupling



- Cast aluminum.
- Large thrust flange.
- Fastens with 4 hex socket screws.
- Adjustable torque resistance.
- Features a rotation range of 300°.

Part No.	System
R147-025-000R	50
R147-025-200R	80

Note: Table dimensions in mm.

Technical references and CAD downloads available at www.hammondmfg.com

All dimensions in inches unless specified otherwise

Quality Products. Service Excellence.

Heavy Duty Elbow Coupling



- Cast Aluminum
- Large thrust flange.
- Fastens with 4 hex socket screws.
- Adjustable torque resistance.
- Features a rotation range of 300°.

Part No.	System
R147-035-000R	50
R147-035-200R	80

Note: Table dimensions in mm.

Heavy Duty Elbow



- Cast Aluminum
- Large cover opening for easier cable pull through.

Part No.	System
R147-020-000R	50
R147-020-200R	80

Note: Table dimensions in mm.

Heavy Duty Intermediate Joint



- 4G-s.g. cast iron.
- Integrated movement stop.
- One piece bellow.
- Two sleeves.
- Features a rotation range of 170°.

Part No.	System
R147-015-000R	50
R147-015-200R	80

Note: Table dimensions in mm.

Heavy Duty Wall Joint



- 4G-s.g. cast iron.
- Integrated movement stop.
- One piece bellow.
- Two sleeves.
- Features a rotation range of 170°.

Part No.	System
R147-010-000R	50
R147-010-200R	80

Note: Table dimensions in mm.

Heavy Duty Socket Joint



- Cast Aluminum.
- Integrated movement stop.
- Service free bearings.
- Features a rotation range of 300°.
- Can mount on top of machine or inverted.

Part No.	System
R147-005-000R	50
R147-005-200R	80

Note: Table dimensions in mm.

Heavy Duty Cast Iron Base



- 4G-s.g. cast iron.
- Gasket included.
- Does not rotate.

Part No.	System
R147-030-000R	50
R147-030-200R	80

Note: Table dimensions in mm.

Heavy Duty Slope Adaptor



- Provides 30° or 60° incline by mounting to rear of enclosure.
- Cast aluminum.

Part No.	System
R140-045-000R	

Type 12 Mild Steel Miniature Pushbutton Enclosures *MPB Series*

Operator Interface Enclosures

Pushbutton Enclosures



Quick Link: hammfg.com/MPB

Application

- Designed to accept 22mm miniature oil tight pushbuttons, switches and pilot lights.
- Provides protection from dirt, dust, oil and water.

Standards

- UL 508A Type 12 and 13
- CSA Type 12 and 13
- Complies with
 - NEMA Type 12 and 13
 - IEC 60529, IP54
- Appropriate components are required to maintain these standards.

Construction

- Formed 14 gauge steel except the MPB1 which is 16 gauge.
- Smooth continuously welded seams.
- Welded brackets provide for enclosure mounting.
- Captive cover screws thread into sealed wells.
- Larger enclosures provide internally hinged removable covers, designed to hold the cover open during wiring (see table).
- Oil resistant gasket and adhesive.
- A bonding stud is provided on the door and a grounding stud is provided on the enclosure.

Finish

- Cover and enclosure are phosphatized and finished in ANSI 61 gray powder coating.

Accessories

- Hole Plugs...*See Page 274*
- Pedestal and Base...*See Page 303*
- General Accessories...*See Page 268*

22.5mm PB Part No.	No. of Holes	Enclosure		
		H	W	D
MPB1 ¹	1	3.25	2.75	3.50
MPB2 ¹	2	5.13	2.75	3.50
MPB3 ¹	3	7.00	2.75	3.50
MPB4 ¹	4	8.88	2.75	3.50
MPB6	6	8.50	5.00	4.25
MPB9	9	8.50	6.50	4.25
MPB12	12	10.38	6.50	4.25

¹ Not hinged

Type 12 Mild Steel Pushbutton Enclosures *1435 Series*



Quick Link: hammfg.com/1435

Application

- Designed to accept standard heavy duty oil tight pushbuttons, switches and pilot lights.
- Provides protection from dirt, dust, oil and water.

Standards

- UL 508A Type 12 and 13
- CSA Type 12 and 13
- Complies with
 - NEMA Type 12 and 13
 - IEC 60529, IP54
- Appropriate components are required to maintain these standards.

Construction

- Formed 14 gauge steel except
- A and B which are 16 gauge.
- Smooth continuously welded seams.
- Welded brackets provide for enclosure mounting.
- Captive cover screws thread into sealed wells.
- Larger enclosures provide internally hinged removable covers, designed to hold the cover open during wiring (see table).
- Oil resistant gasket and adhesive.
- A bonding stud is provided on the door and a grounding stud is provided on the enclosure.

Finish

- Cover and enclosure are phosphatized and finished in ANSI 61 gray powder coating.

Accessories

- Hole Plugs...*See Page 274*
- Pedestal and Base...*See Page 303*
- General Accessories...*See Page 268*

30.5mm PB Part No.	22.5mm PB Part No.	No. of Holes	Enclosure		
			H	W	D
1435A ¹	1435MA ¹	1	3.50	3.25	2.75
1435B ¹	1435MB ¹	2	5.75	3.25	2.75
1435C ¹	1435MC ¹	3	8.00	3.25	2.75
1435D ¹	1435MD ¹	4	10.25	3.25	2.75
1435F	1435MF	4	7.25	6.25	3.00
1435H	1435MH	6	9.50	6.25	3.00
1435K	1435MK	9	9.50	8.50	3.00
1435O	1435MO	12	11.75	8.50	3.00
1435S	1435MS	16	11.75	10.75	3.00

¹ Not hinged

Type 4, 4X Stainless Steel Pushbutton Enclosures *1435SS Series*

Operator Interface Enclosures **Pushbutton Enclosures**

Quick Link: hammfg.com/1435SS

Application

- Designed to accept standard heavy duty oil tight pushbuttons, switches and pilot lights.
- Provides protection from dirt, dust, oil and large amounts of water from any angle, or where highly corrosive conditions exist.

Standards

- UL 508A Type 4 and 4X
- CSA Type 4 and 4X
- Complies with
 - NEMA Type 3R, 4 and 4X
 - IEC 60529, IP66
- Appropriate components are required to maintain these standards.

Construction

- Formed 14 gauge stainless steel except A and B which are 16 gauge. 304 or 316 SS.
- Smooth continuously welded seams.
- Welded brackets provide for enclosure mounting.
- Captive stainless steel cover screws thread into sealed wells.
- Larger enclosures provide internally hinged removable covers, designed to hold the cover open during wiring.
- Oil resistant gasket and adhesive.
- A bonding stud is provided on the door and a grounding stud is provided on the enclosure.

Finish

- Natural stainless steel with a smooth brushed finish.

Accessories

- Hole Plugs...*See Page 275*
- General Accessories...*See Page 268*

304 S.S. 22.5mm PB Part No.	304 S.S. 30.5mm PB Part No.	316 S.S. 22.5mm PB Part No.	316 S.S. 30.5mm PB Part No.	No. Of Holes	Enclosure		
				H	W	D	
1435MSSA ¹	1435SSA ¹	1435MS16A ¹	1435S16A ¹	1	3.50	3.25	2.75
1435MSSB ¹	1435SSB ¹	1435MS16B ¹	1435S16B ¹	2	5.75	3.25	2.75
1435MSSC ¹	1435SSC ¹	1435MS16C ¹	1435S16C ¹	3	8.00	3.25	2.75
1435MSSD ¹	1435SSD ¹	1435MS16D ¹	1435S16D ¹	4	10.25	3.25	2.75
1435MSSH	1435SSH	1435MS16H	1435S16H	6	9.50	6.25	3.00
1435MSSK	1435SSK	1435MS16K	1435S16K	9	9.50	8.50	3.00
1435MSSO	1435SSO	1435MS16O	1435S16O	12	11.75	8.50	3.00

¹ Not hinged

Technical references and CAD downloads available at www.hammondmfg.com

All dimensions in inches unless specified otherwise

Type 12 Mild Steel Pushbutton Enclosures *1437 Series*

Extra Deep



Quick Link: hammfg.com/1437

Application

- Designed to accept standard heavy duty oil tight pushbuttons, switches and pilot lights.
- Provides protection from dirt, dust, oil and water.

Standards

- UL 508A Type 12 and 13
- CSA Enclosure 12 and 13
- Complies with
 - NEMA Type 12 and 13
 - IEC 60529, IP54
- Appropriate components are required to maintain these standards.

Construction

- Formed from 14 gauge steel except A which is 16 gauge.
- Smooth continuously welded seams.
- Welded brackets provide for enclosure mounting.
- Captive cover screws fasten into threaded, sealed wells.
- Larger enclosures provide internally hinged removable covers, designed to hold the cover open during wiring (see drawings).
- Oil resistant gasket and adhesive.
- A bonding stud is provided on the door and a grounding stud is provided on the enclosure.

Finish

- Cover and enclosure are phosphatized and finished in ANSI 61 gray powder coating.

Accessories

- Hole Plugs...*See Page 275*
- General Accessories...*See Page 268*

30.5mm PB Part No.	22.5mm PB Part No.	No. of Holes	Enclosure		
			H	W	D
1437A ¹	1437MA ¹	1	4.00	4.00	4.75
1437B	1437MB	2	6.00	4.00	4.75
1437C	1437MC	3	8.00	4.00	4.75
1437D	1437MD	4	10.00	4.00	4.75
1437F	1437MF	4	7.25	6.25	4.75
1437H	1437MH	6	9.50	6.25	4.75
1437K	1437MK	9	9.50	8.50	4.75
1437O	1437MO	12	11.75	8.50	4.75
1437S	1437MS	16	11.75	10.75	4.75
1437V	1437MV	20	14.00	10.75	4.75
1437X	1437MX	25	14.00	13.00	4.75

¹ Not hinged

Type 4, 4X Stainless Steel Pushbutton Enclosures *1437SS Series*

Extra Deep

Operator Interface Enclosures Pushbutton Enclosures



Quick Link: hammfg.com/1437SS

Application

- Designed to accept standard heavy duty oil tight pushbuttons, switches and pilot lights.
- Provides protection from dirt, dust, oil and water.

Standards

- UL 508A Type 4 and 4X
- CSA Enclosure 4 and 4X
- Complies with
 - NEMA Type 4 and 4X
 - IEC 60529, IP66
- Appropriate components are required to maintain these standards.

Construction

- Formed from 14 gauge steel except A which is 16 gauge.
- Smooth continuously welded seams.
- Welded brackets provide for enclosure mounting.
- Captive cover screws fasten into threaded, sealed wells.
- Larger enclosures provide internally hinged removable covers, designed to hold the cover open during wiring (see drawings).
- Oil resistant gasket and adhesive.
- A bonding stud is provided on the door and a grounding stud is provided on the enclosure.

Finish

- Natural stainless steel with a smooth brushed finish.

Accessories

- Hole Plugs...*See Page 274*
- Ground Wire Kits...*See Page 272*

304 S.S. 22.5mm PB Part No.	304 S.S. 30.5mm PB Part No.	316 S.S. 22.5mm PB Part No.	316 S.S. 30.5mm PB Part No.	No. Of Holes	H	W	Enclosure D
1437MSSA ¹	1437SSA ¹	1437MS16A ¹	1437S16A ¹	1	4.00	4.00	4.75
1437MSSB	1437SSB	1437MS16B	1437S16B	2	6.00	4.00	4.75
1437MSSC	1437SSC	1437MS16C	1437S16C	3	8.00	4.00	4.75
1437MSSD	1437SSD	1437MS16D	1437S16D	4	10.00	4.00	4.75
-	1437SSS	-	1437S16S	16	11.75	10.75	4.75

¹ Not hinged

Technical references and CAD downloads available at www.hammondmfg.com

All dimensions in inches unless specified otherwise

Type 12 Mild Steel Pushbutton Enclosures *1489 Series*

Hinged Cover

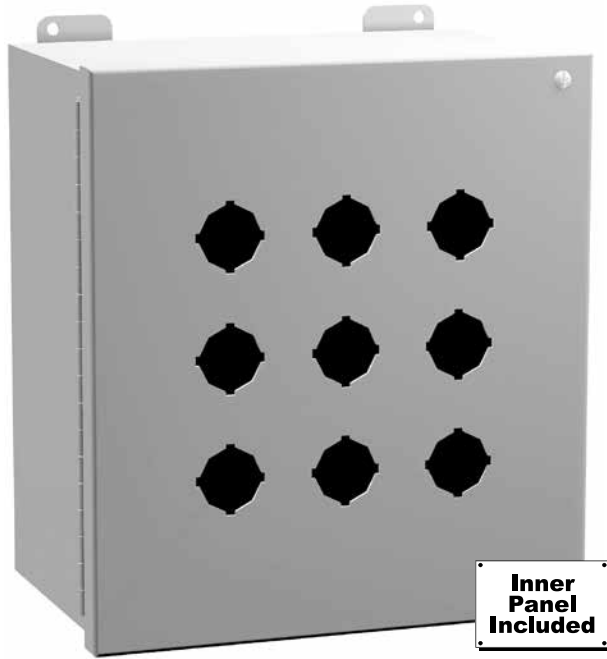

Construction

- Formed 14 gauge steel.
- Smooth continuously welded seams.
- Welded brackets provide for enclosure mounting.
- Continuously hinged cover is secured with captive, plated steel screws which fasten into threaded sealed wells.
- Oil resistant gasket and adhesive.
- Weldnuts are provided for mounting inner panels.
- A removable 14 gauge inner panel is included.
- A bonding stud is provided on the door and a grounding stud is provided in the enclosure.

Finish

- Cover and enclosure are phosphatized and finished in ANSI 61 gray powder coating.
- Removable inner panel is finished in white powder coating.

Accessories

- Hole Plugs...*See Page 274*
- Pedestal and Base...*See Page 303*
- General Accessories...*See Page 268*

Quick Link: hammfg.com/1489

Application

- Designed to accept standard heavy duty oil tight pushbuttons, switches and pilot lights.
- Provides protection from dirt, dust, oil and water.

Standards

- UL 508A Type 12
- CSA Type 12
- Complies with
 - NEMA Type 12
 - IEC 60529, IP54
- Appropriate components are required to maintain these standards.

30.5mm PB		22.5mm PB		No. Of Holes	Enclosure			Panel	
Part No.	Part No.	H	W		D	H	W		
1489P4	1489MP4	4	8.25	7.25	6.00	6.25	5.25		
1489P6	1489MP6	6	10.50	7.25	6.00	8.50	5.25		
1489P9	1489MP9	9	10.50	9.50	6.00	8.50	7.50		
1489P12	1489MP12	12	12.75	9.50	6.00	10.75	7.50		
1489P16	1489MP16	16	12.75	11.75	6.00	10.75	9.75		
1489P20	1489MP20	20	15.00	11.75	6.00	13.00	9.75		
1489P25	1489MP25	25	15.00	14.00	6.00	13.00	12.00		
1489P30	1489MP30	30	17.25	14.00	6.00	15.25	12.00		
1489P36	1489MP36	36	17.25	16.25	6.00	15.25	14.25		
1489P42	1489MP42	42	19.50	16.25	6.00	17.50	14.25		

Technical references and CAD downloads available at www.hammondmfg.com

All dimensions in inches unless specified otherwise

Quality Products. Service Excellence.

Type 12 Mild Steel Pushbutton Enclosures *1490 Series*

Sloped Console

Operator Interface Enclosures Pushbutton Enclosures

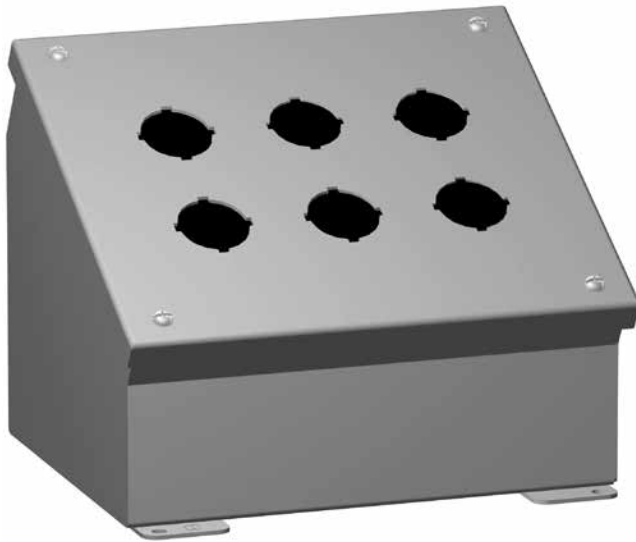

Quick Link: hammfg.com/1490

Application

- Designed to accept standard heavy duty oil tight pushbuttons, switches and pilot lights.
- Ideal for wall or surface mounting to provide the necessary control slope.
- Provides protection from dirt, dust, oil and water.

Standards

- UL 508A Type 12 and 13
- CSA Type 12 and 13
- Complies with
 - NEMA Type 12 and 13
 - IEC 60529, IP54
- Appropriate components are required to maintain these standards.

Construction

- Formed 14 gauge steel.
- Smooth continuously welded seams.
- Construction provides either a 30° or 60° slope on front cover depending on mounting position.
- Welded brackets provide for enclosure mounting.
- Captive cover screws thread into sealed wells.
- Larger enclosures provide internally hinged removable covers designed to hold the cover open during wiring (as noted in table).
- Oil resistant gasket and adhesive.
- A bonding stud is provided on the door and a grounding stud is provided on the enclosure.

Finish

- Cover and enclosure are phosphatized and finished in ANSI 61 gray powder coating.

Accessories

- Hole Plugs...*See Page 274*
- Pedestal and Base...*See Page 303*
- General Accessories...*See Page 268*

30.5mm PB Part No.	22.5mm PB Part No.	No. Of Holes	Enclosure		
			H	W	D
1490D1 ¹	1490MD1 ¹	1	3.50	3.25	4.88
1490D2 ¹	1490MD2 ¹	2	3.50	5.50	4.88
1490D3 ¹	1490MD3 ¹	3	3.50	7.75	4.88
1490D4 ¹	1490MD4 ¹	4	3.50	10.00	4.88
1490G4	1490MG4	4	7.25	6.25	6.75
1490G6	1490MG6	6	7.25	8.50	6.75
1490G8	1490MG8	8	7.25	10.75	6.75
1490H9	1490MH9	9	9.50	8.50	7.88
1490G10	1490MG10	10	7.25	13.00	6.75
1490G12	1490MG12	12	7.25	15.25	6.75
1490J12	1490MJ12	12	11.75	8.50	9.00
1490G16	1490MG16	16	7.25	19.75	6.75
1490J16	1490MJ16	16	11.75	10.75	9.00
1490J20	1490MJ20	20	11.75	13.00	9.00
1490K25	1490MK25	25	14.00	13.00	10.13
1490K30	1490MK30	30	14.00	15.25	10.13

¹ Not hinged

Technical references and CAD downloads available at www.hammondmfg.com

All dimensions in inches unless specified otherwise

Type 4, 4X Polycarbonate Pushbutton Enclosure *1554 PB Series*

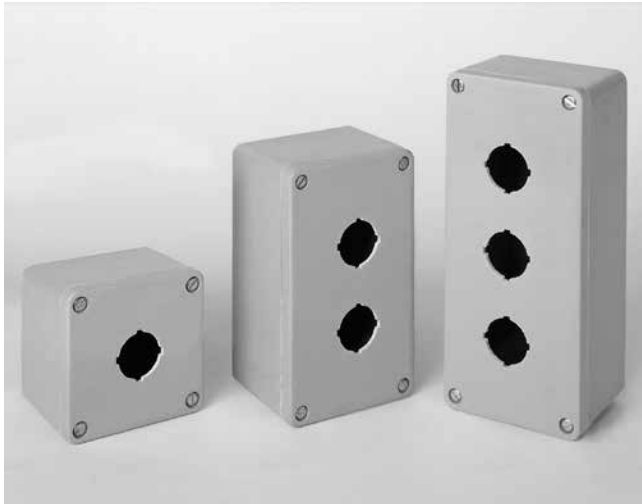

Quick Link: hammfg.com/1554PB

Standards

- IP66
- NEMA 4, 4X, 6, 6P, 12 & 13
- UL94 5V

Construction

- Electronic instrument enclosures, designed for mounting printed circuit boards or DIN rail mounted components.
- The polycarbonate material carries a UL flammability rating of UL94 5V and is suitable for outdoor use.
- Lid and mounting holes are located outside of the gasket seal.
- Lid is secured with self capturing M4 stainless steel machine screws (included), threaded into integral stainless steel bushings (for repetitive assembly & disassembly).
- Heavy duty 16 gauge galvanized steel panels available (see chart)
- All stainless steel hardware to avoid corrosion caused by dissimilar metals.
- Gasket is a preformed, high temperature U.L. listed silicone rubber. Gasket is replaceable.
- Gasketed lid with two piece "tongue & groove" construction provides protection against access of oil, dust and water.
- Internal DIN rail mounting tabs.
- Threaded (M3) integral brass inserts & standoffs designed for M3.5 or #6 self tapping screws for P.C. board or inner panel mounting in all but the smallest size.
- Vertical P.C. card guides (for 1.5 mm thick P.C. boards) are molded in all but the smallest size

Finish

- Color is light gray (RAL 7035)

Accessories

- Optional Inner Panel
 - Heavy duty panels for mounting components
 - Galvanized 16 ga. steel.
 - Includes mounting hardware.
- Optional Mounting Feet
 - Part No. 1554FT

22 mm Hole Part No.	30.5 mm Hole Part No.	# of Holes	Enclosure			Optional Inner Panel		
			H	W	D (w/lid)	Part No.	H	W
1554MPB1	1554PB1	1	3.54	3.54	2.36	1554EPL	3.10	3.10
1554MPB1A	1554PB1A	1	3.54	3.54	3.54	1554EPL	3.10	3.10
1554MPB2	1554PB2	2	6.30	3.54	2.38	1554JPL	5.80	3.00
1554MPB2D	1554PB2D	2	6.30	3.54	3.56	1554JPL	5.80	3.00
1554MPB3	1554PB3	3	7.87	4.72	3.56	1554UPL	7.60	4.20
1554MPB4	1554PB4	4	7.87	4.72	3.56	1554UPL	7.60	4.20
1554MPB6	1554PB6	6	9.45	6.30	3.54	1554VPL	9.10	5.70
1554MPB6A	1554PB6A	6	9.45	6.30	3.54	1554VAPL	8.93	5.73
1554MPB6B	1554PB6B	6	9.45	6.30	4.72	1554VAPL	8.93	5.73

Technical references and CAD downloads available at www.hammondmfg.com

All dimensions in inches unless specified otherwise

Quality Products. Service Excellence.

Type 4, 4X Polyester Pushbutton Enclosure *PJPB Series*

Operator Interface Enclosures Pushbutton Enclosures

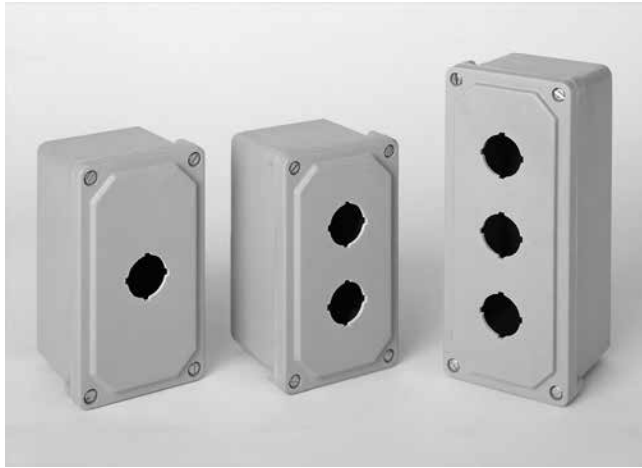

Quick Link: hammfg.com/PJPB

Application

- Designed for use as pushbutton enclosures for 22.5mm or 30.5mm devices.
- Provides outstanding insulation and protection where equipment may be hosed down or be very wet.
- Ideal in applications with high temperatures or highly corrosive environments.

Standards

- UL 508A Type 1, 2, 3, 4, 4X, 12 and 13
- CSA Type 1, 2, 3, 4, 4X, 12 and 13
- Complies with
 - NEMA Type 1, 2, 3, 4, 4X, 12 and 13
 - IEC 60529, IP66

Construction

- Molded fiberglass polyester enclosure with matching cover is easily punched, cut, or drilled.
- Threaded brass inserts are provided for optional inner panel.
- Cover is fastened with captive stainless steel screws in threaded brass inserts.
- Captive oil resistant gasket provides a positive seal.
- Mounting through rear holes on enclosure. Use #8 x 1 inch screw (not included).
- Enhanced UV inhibitors protect against outdoor weathering.
- Operating temperatures between 130°C and -40°C (266°F to -40°F).
- Impact index of 6.78J (5 ft/lb).
- For corrosion resistance information, please refer to table in Technical Information.

Finish

- Fiberglass polyester material has a gray finish.
- Optional aluminum inner panel natural finish.

Accessories

- Hole Plugs...*See Page 275*

30.5mm PB Part No.	22.5mm PB Part No.	# of Holes	Enclosure		
			H	W	D
PJ744P1	PJ744P221	1	6.74	3.93	3.88
PJ744P2	PJ744P222	2	6.74	3.93	3.88
PJ944P3	PJ944P223	3	8.99	3.93	3.88

Type 4, 4X Polyester Pushbutton Enclosure *PJPBLC Series*

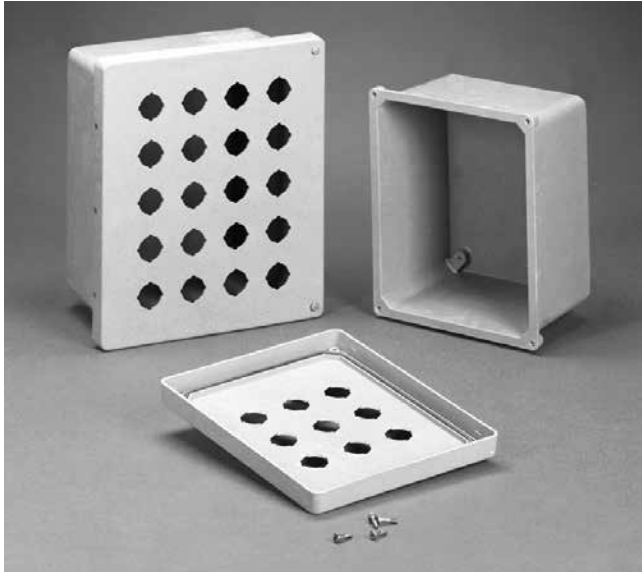

Quick Link: hammfg.com/PJPBLC

Application

- Designed for use as pushbutton enclosures for 30.5mm devices.
- Provides outstanding insulation and protection where equipment may be hosed down or be very wet.
- Ideal in applications with high temperatures or highly corrosive environments.

Standards

- UL 508A Type 1, 2, 3, 4, 4X, 12 and 13
- CSA Type 1, 2, 3, 4, 4X, 12 and 13
- Complies with
 - NEMA Type 1, 2, 3, 4, 4X, 12 and 13
 - IEC 60529, IP66

Construction

- Molded fiberglass polyester enclosure with matching cover is easily punched, cut, or drilled.
- Standard JIC sizes under 18" x 16".
- Threaded brass inserts are provided for optional inner panel or terminal kit mounting.
- Cover is fastened with captive stainless steel screws in threaded brass inserts.
- Captive oil resistant gasket provides a positive seal.
- Threaded brass inserts are provided for mounting feet to the rear of the enclosure.
- Stainless steel mounting brackets and hardware are provided for mounting to the rear of the enclosure.
- Enhanced UV inhibitors protect against outdoor weathering.
- Operating temperatures between 130°C and -40°C (266°F to -40°F).
- Impact index of 6.78J (5 ft/lb).
- For corrosion resistance information, please refer to table in Technical Information.

Finish

- Fiberglass polyester material has a gray finish.
- Optional inner panels are available in white powder coated finished steel or unfinished aluminum.

Accessories

- Additional Inner Panels...*See Page 280*
- Terminal Kit Assemblies...*See Page 288*
- Stainless Replacement Mounting Feet...*See Page 278*
- Hole Plugs...*See Page 275*

Lift Off Cover	Hinged Cover	No.	Enclosure			Optional Inner Panel		
30.5mm PB Part No.	30.5mm PB Part No.	Holes	H	W	D	Part No.	H	W
PJ664P4	PJ664HP4	4	6.10	6.10	4.18	14R0505	4.88	4.88
PJ864P6	PJ864HP6	6	8.00	6.12	4.13	14R0705	6.75	4.88
PJ1084P9	PJ1084HP9	9	10.13	8.26	4.13	14R0907	8.75	6.88
PJ1086P9	PJ1086HP9	9	10.13	8.26	6.13	14R0907	8.75	6.88
PJ1086P12	PJ1086HP12	12	10.13	8.26	6.13	14R0907	8.75	6.88
PJ12106P16	PJ12106HP16	16	12.13	10.26	6.13	14R1109	10.75	8.88
PJ12106P20	PJ12106HP20	20	12.13	10.26	6.13	14R1109	10.75	8.88
PJ14126P25	PJ14126HP25	25	14.13	12.26	6.13	14R1311	12.75	10.88
PJ16148P30	PJ16148HP30	30	16.27	14.40	8.13	14R1513	14.75	12.88
PJ18168P42	PJ18168HP42	42	18.40	16.40	8.13	P1868	16.88	14.88

Alternative inner panel options available.