

Series 2230 Triple-Channel Power Supplies

User's Manual

2230-900-01 Rev. B April 2022



2230-900-01B

Series 2230
Triple-Channel Power Supplies
User's Manual

© 2022, Keithley Instruments, LLC

Cleveland, Ohio, U.S.A.

All rights reserved.

Any unauthorized reproduction, photocopy, or use of the information herein, in whole or in part, without the prior written approval of Keithley Instruments, LLC, is strictly prohibited.

These are the original instructions in English.

All Keithley Instruments product names are trademarks or registered trademarks of Keithley Instruments, LLC. Other brand names are trademarks or registered trademarks of their respective holders.

The Lua 5.0 software and associated documentation files are copyright © 1994 - 2015, Lua.org, PUC-Rio. You can access terms of license for the Lua software and associated documentation at the Lua licensing site (<https://www.lua.org/license.html>).

Microsoft, Visual C++, Excel, and Windows are either registered trademarks or trademarks of Microsoft Corporation in the United States and/or other countries.

Document number: 2230-900-01 Rev. B April 2022

The following safety precautions should be observed before using this product and any associated instrumentation. Although some instruments and accessories would normally be used with nonhazardous voltages, there are situations where hazardous conditions may be present.

This product is intended for use by personnel who recognize shock hazards and are familiar with the safety precautions required to avoid possible injury. Read and follow all installation, operation, and maintenance information carefully before using the product. Refer to the user documentation for complete product specifications.

If the product is used in a manner not specified, the protection provided by the product warranty may be impaired.

The types of product users are:

Responsible body is the individual or group responsible for the use and maintenance of equipment, for ensuring that the equipment is operated within its specifications and operating limits, and for ensuring that operators are adequately trained.

Operators use the product for its intended function. They must be trained in electrical safety procedures and proper use of the instrument. They must be protected from electric shock and contact with hazardous live circuits.

Maintenance personnel perform routine procedures on the product to keep it operating properly, for example, setting the line voltage or replacing consumable materials. Maintenance procedures are described in the user documentation. The procedures explicitly state if the operator may perform them. Otherwise, they should be performed only by service personnel.

Service personnel are trained to work on live circuits, perform safe installations, and repair products. Only properly trained service personnel may perform installation and service procedures.

Keithley products are designed for use with electrical signals that are measurement, control, and data I/O connections, with low transient overvoltages, and must not be directly connected to mains voltage or to voltage sources with high transient overvoltages. Measurement Category II (as referenced in IEC 60664) connections require protection for high transient overvoltages often associated with local AC mains connections. Certain Keithley measuring instruments may be connected to mains. These instruments will be marked as category II or higher.

Unless explicitly allowed in the specifications, operating manual, and instrument labels, do not connect any instrument to mains.

Exercise extreme caution when a shock hazard is present. Lethal voltage may be present on cable connector jacks or test fixtures. The American National Standards Institute (ANSI) states that a shock hazard exists when voltage levels greater than 30 V RMS, 42.4 V peak, or 60 VDC are present. A good safety practice is to expect that hazardous voltage is present in any unknown circuit before measuring.

Operators of this product must be protected from electric shock at all times. The responsible body must ensure that operators are prevented access and/or insulated from every connection point. In some cases, connections must be exposed to potential human contact. Product operators in these circumstances must be trained to protect themselves from the risk of electric shock. If the circuit is capable of operating at or above 1000 V, no conductive part of the circuit may be exposed.

Do not connect switching cards directly to unlimited power circuits. They are intended to be used with impedance-limited sources. NEVER connect switching cards directly to AC mains. When connecting sources to switching cards, install protective devices to limit fault current and voltage to the card.

Before operating an instrument, ensure that the line cord is connected to a properly-grounded power receptacle. Inspect the connecting cables, test leads, and jumpers for possible wear, cracks, or breaks before each use.

When installing equipment where access to the main power cord is restricted, such as rack mounting, a separate main input power disconnect device must be provided in close proximity to the equipment and within easy reach of the operator.

For maximum safety, do not touch the product, test cables, or any other instruments while power is applied to the circuit under test. ALWAYS remove power from the entire test system and discharge any capacitors before: connecting or disconnecting cables or jumpers, installing or removing switching cards, or making internal changes, such as installing or removing jumpers.

Do not touch any object that could provide a current path to the common side of the circuit under test or power line (earth) ground. Always make measurements with dry hands while standing on a dry, insulated surface capable of withstanding the voltage being measured.

For safety, instruments and accessories must be used in accordance with the operating instructions. If the instruments or accessories are used in a manner not specified in the operating instructions, the protection provided by the equipment may be impaired.

Do not exceed the maximum signal levels of the instruments and accessories. Maximum signal levels are defined in the specifications and operating information and shown on the instrument panels, test fixture panels, and switching cards.

When fuses are used in a product, replace with the same type and rating for continued protection against fire hazard.

Chassis connections must only be used as shield connections for measuring circuits, NOT as protective earth (safety ground) connections.

If you are using a test fixture, keep the lid closed while power is applied to the device under test. Safe operation requires the use of a lid interlock.

If a  screw is present, connect it to protective earth (safety ground) using the wire recommended in the user documentation.

The  symbol on an instrument means caution, risk of hazard. The user must refer to the operating instructions located in the user documentation in all cases where the symbol is marked on the instrument.

The  symbol on an instrument means warning, risk of electric shock. Use standard safety precautions to avoid personal contact with these voltages.

The  symbol on an instrument shows that the surface may be hot. Avoid personal contact to prevent burns.

The  symbol indicates a connection terminal to the equipment frame.

If this  symbol is on a product, it indicates that mercury is present in the display lamp. Please note that the lamp must be properly disposed of according to federal, state, and local laws.

The **WARNING** heading in the user documentation explains hazards that might result in personal injury or death. Always read the associated information very carefully before performing the indicated procedure.

The **CAUTION** heading in the user documentation explains hazards that could damage the instrument. Such damage may invalidate the warranty.

The **CAUTION** heading with the  symbol in the user documentation explains hazards that could result in moderate or minor injury or damage the instrument. Always read the associated information very carefully before performing the indicated procedure. Damage to the instrument may invalidate the warranty.

Instrumentation and accessories shall not be connected to humans.

Before performing any maintenance, disconnect the line cord and all test cables.

To maintain protection from electric shock and fire, replacement components in mains circuits — including the power transformer, test leads, and input jacks — must be purchased from Keithley. Standard fuses with applicable national safety approvals may be used if the rating and type are the same. The detachable mains power cord provided with the instrument may only be replaced with a similarly rated power cord. Other components that are not safety-related may be purchased from other suppliers as long as they are equivalent to the original component (note that selected parts should be purchased only through Keithley to maintain accuracy and functionality of the product). If you are unsure about the applicability of a replacement component, call a Keithley office for information.

Unless otherwise noted in product-specific literature, Keithley instruments are designed to operate indoors only, in the following environment: Altitude at or below 2,000 m (6,562 ft); temperature 0 °C to 50 °C (32 °F to 122 °F); and pollution degree 1 or 2.

To clean an instrument, use a cloth dampened with deionized water or mild, water-based cleaner. Clean the exterior of the instrument only. Do not apply cleaner directly to the instrument or allow liquids to enter or spill on the instrument. Products that consist of a circuit board with no case or chassis (e.g., a data acquisition board for installation into a computer) should never require cleaning if handled according to instructions. If the board becomes contaminated and operation is affected, the board should be returned to the factory for proper cleaning/servicing.

Safety precaution revision as of June 2018.

Table of contents

Introduction.....	1-1
Welcome	1-1
Products	1-1
Extended warranty	1-2
Contact information	1-2
Key features	1-2
Accessories	1-4
Available services	1-5
General ratings.....	1-6
Wire specifications	1-6
Quick reference.....	2-1
Front-panel overview.....	2-1
Rear-panel overview	2-2
Install the system	2-3
Dimensions	2-3
Select the proper line voltage	2-5
Connect the 2230-30-3 power cord	2-6
Connect the 2230-30-6/2230-60-3 power cord	2-6
Turn the power supply on and off	2-7
If the power supply does not turn on.....	2-8
Self-test procedure	2-9
Self-test error messages	2-9
Remote communications interfaces.....	2-9
USB interface	2-10
RS-232 interface	2-11
Function and features	3-1
Introduction	3-1
Front-panel operation.....	3-1
Front-panel keypad	3-2
Turn the 2230 output on.....	3-3
Turn the 2230 output off.....	3-3
Navigation wheel.....	3-4
Display indicators	3-4
Menu description.....	3-5
Basic settings	3-6
Set the voltage output or voltage limit for a specific channel.....	3-6
Set the current output or current limit for a specific channel	3-6
Save and recall setups.....	3-7

Restore default settings	3-8
Enable or disable channels	3-9
Set the maximum voltage.....	3-9
Set the output timers	3-10
Set the key lock status	3-10
Track	3-11
Combine	3-13
V1+V2 combination for series connections	3-14
I1+I2 parallel	3-15
I2+I3 parallel	3-16
I1+I2+I3 parallel	3-17
Turn off channel combination.....	3-18
User settings	3-19
Restore last output state on power up.....	3-19
Save last	3-19
Key beep	3-20
Navigation wheel lock	3-20
Communication port.....	3-21
System information	3-21
Check the error log.....	3-21
Check the firmware version.....	3-22
Check the serial number	3-22
Overtemperature protection	3-22
Use the rear-panel terminals.....	3-23
Remote sense connections	3-24
Local sense connections.....	3-25
Introduction to SCPI	4-1
Standard Commands for Programmable Instruments	4-1
Conventions	4-2
Commands to use with the Series 2230	4-2
Types of SCPI messages.....	4-3
Command execution rules	4-4
Case sensitivity	4-4
Long-form and short-form versions.....	4-4
The message unit.....	4-5
Headers	4-5
Queries	4-5
Message unit separator.....	4-6
Root specifier	4-6
Message terminator	4-7
Multiple commands in a message.....	4-8
Movement in the subsystem.....	4-8
Including common commands	4-9

SCPI data formats	4-9
Talking and listening data formats	4-9
Suffixes and multipliers	4-10
Response messages	4-10
Response data types	4-10
Getting a response message	4-10
Multiple response messages	4-11
Response message terminator (RMT)	4-11
Message exchange protocol	4-11
SCPI command completion	4-12
Using device clear	4-12
Default setup	4-13

SCPI command reference..... 5-1

Series 2230 commands	5-1
Common commands	5-1
*CLS (no query form)	5-3
*ESE	5-4
*ESR? (query only)	5-5
*IDN? (query only)	5-6
*OPC	5-7
*PSC	5-8
*RCL (no query form)	5-9
*RST (no query form)	5-10
*SAV (no query form)	5-10
*SRE	5-11
*STB? (query only)	5-12
*TST? (query only)	5-12
*WAI	5-13
CALibration subsystem	5-14
CALibrate:CLEar	5-14
CALibrate:CURRent[:DATA]	5-14
CALibrate:CURRent:LEVel	5-15
CALibrate:INITial	5-16
CALibrate:SAVe	5-16
CALibrate:SECure[:STATe]	5-17
CALibrate:STRing	5-18
CALibrate:VOLTage[:DATA]	5-18
CALibrate:VOLTage:LEVel	5-19
INSTrument subsystem	5-20
INSTrument:COMBine?	5-20
INSTrument:COMBine:OFF	5-21
INSTrument:COMBine:PARallel	5-22
INSTrument:COMBine:SERies	5-23
INSTrument:COMBine:TRACk	5-23
INSTrument:NSElect	5-24
INSTrument[:SElect]	5-25
MEASurement subsystem	5-26
FETCh[:SCALar]:CURRent[:DC]?	5-26
FETCh[:SCALar]:POWer[:DC]?	5-27
FETCh[:SCALar][:VOLTage][:DC]?	5-28
MEASure[:SCALar]:CURRent[:DC]?	5-29

MEASure[:SCALar]:POWer[:DC]? 5-30
 MEASure[:SCALar][:VOLTage][:DC]? 5-31

SOURce subsystem 5-32

[SOURce:]APPLy 5-32
 [SOURce:]CHANnel:OUTPut[:STATe] 5-33
 [SOURce:]CURRent[:LEVel]:DOWN[:IMMediate][:AMPLitude] 5-34
 [SOURce:]CURRent[:LEVel][:IMMediate][:AMPLitude] 5-35
 [SOURce:]CURRent[:LEVel][:IMMediate]:STEP[:INCRement] 5-36
 [SOURce:]CURRent[:LEVel]:UP[:IMMediate][:AMPLitude] 5-37
 [SOURce:]OUTPut:ENABle 5-38
 [SOURce:]OUTPut:PARAllel[:STATe] 5-39
 [SOURce:]OUTPut:PROTEction:CLEar 5-40
 [SOURce:]OUTPut:SERies[:STATe] 5-41
 [SOURce:]OUTPut[:STATe][:ALL] 5-42
 [SOURce:]OUTPut:TIMer:DELAy 5-43
 [SOURce:]OUTPut:TIMer[:STATe] 5-44
 [SOURce:]VOLTage[:LEVel]:DOWN[:IMMediate][:AMPLitude] 5-45
 [SOURce:]VOLTage[:LEVel][:IMMediate][:AMPLitude] 5-46
 [SOURce:]VOLTage[:LEVel][:IMMediate]:STEP[:INCRement] 5-47
 [SOURce:]VOLTage[:LEVel]:UP[:IMMediate][:AMPLitude] 5-48
 [SOURce:]VOLTage:LIMit[:LEVel] 5-49
 [SOURce:]VOLTage:LIMit[:STATe] 5-50

STATus subsystem 5-51

STATus:OPERation:CONDition? 5-51
 STATus:OPERation:ENABle 5-52
 STATus:OPERation[:EVENT]? 5-53
 STATus:OPERation:INSTRument:ENABle 5-54
 STATus:OPERation:INSTRument[:EVENT]? 5-55
 STATus:OPERation:INSTRument:ISUMmary<X>:CONDition? 5-56
 STATus:OPERation:INSTRument:ISUMmary<X>:ENABle 5-57
 STATus:OPERation:INSTRument:ISUMmary<X>[:EVENT]? 5-58
 STATus:PRESet 5-59
 STATus:QUEStionable:CONDition? 5-60
 STATus:QUEStionable:ENABle 5-61
 STATus:QUEStionable[:EVENT]? 5-62
 STATus:QUEStionable:INSTRument:ENABle 5-63
 STATus:QUEStionable:INSTRument[:EVENT]? 5-64
 STATus:QUEStionable:INSTRument:ISUMmary<X>:CONDition? 5-65
 STATus:QUEStionable:INSTRument:ISUMmary<X>:ENABle 5-66
 STATus:QUEStionable:INSTRument:ISUMmary<X>[:EVENT]? 5-67

SYSTem subsystem 5-68

SYSTem:BEEPer 5-68
 SYSTem:ERRor? 5-69
 SYSTem:LOCAl 5-70
 SYSTem:REMote 5-71
 SYSTem:RWLock[:STATe] 5-72
 SYSTem:VERSion? 5-73

Status register 6-1

Status register overview 6-1

Error descriptions 7-1

Error information 7-1

Introduction

In this section:

Welcome	1-1
Products	1-1
Extended warranty	1-2
Contact information	1-2
Key features	1-2
Accessories	1-4
Available services	1-5
General ratings	1-6
Wire specifications	1-6

Welcome

Thank you for choosing a Keithley Instruments product. The Series 2230 Triple-Channel Power Supplies (Models 2230-30-3, 2230-30-6, and 2230-60-3) provide output power up to 195 W and 375 W. Each power supply has three isolated power channels, allowing you to power circuits with different references or polarities.

The Series 2230 supports remote sensing and has rear-panel connections to make automated test more convenient. Built-in RS-232 and USB interfaces allow multiple communication methods. The Series 2230 power supplies cover a wide range of applications in a space-saving 2U half-rack size.

Products

This manual contains information about the models listed in the following table.

Model	Description
2230-30-3	Triple-Channel Power Supplies, 2 channels: 30 V, 3 A, 1 channel: 5 V, 3 A, 195 W
2230-30-6	Triple-Channel Power Supplies, 2 channels: 30 V, 6 A, 1 channel: 5 V, 3 A, 375 W
2230-60-3	Triple-Channel Power Supplies, 2 channels: 60 V, 3 A, 1 channel: 5 V, 3 A, 375 W

Extended warranty

Additional years of warranty coverage are available on many products. These valuable contracts protect you from unbudgeted service expenses and provide additional years of protection at a fraction of the price of a repair. Extended warranties are available on new and existing products. Contact your local Keithley Instruments office, sales partner, or distributor for details.

Contact information

If you have any questions after you review the information in this documentation, please contact your local Keithley Instruments office, sales partner, or distributor. You can also call the Tektronix corporate headquarters (toll-free inside the U.S. and Canada only) at 1-800-833-9200. For worldwide contact numbers, visit tek.com/contact (tek.com/en/contact-tek).

Key features

The Series 2230 has the following features:

- Power output up to 195 W or 375 W in a space-saving 2U high, half-rack wide enclosure
- Three programmable isolated channels
- Remote sensing for maximum output accuracy in automated test
- Rear-panel connectors for convenient wiring of a test system in a rack
- Built-in RS-232 and USB communication interfaces
- 0.03 percent basic voltage accuracy
- 0.1 percent basic current accuracy
- Less than 4 mV peak-to-peak ripple and noise

Model	Channel	Voltage	Current
2230-30-3	CH1	30 V	3 A
	CH2	30 V	3 A
	CH3	5 V	3 A
2230-30-6	CH1	30 V	6 A
	CH2	30 V	6 A
	CH3	5 V	3 A
2230-60-3	CH1	60 V	3 A
	CH2	60 V	3 A
	CH3	5 V	3 A

Accessories

The following items are standard accessories that are included with your Series 2230-30-6 or 2230-60-3 order.

Accessory	Part number
Calibration report	0011655XX
USB cable	1746841XX
Line cord	1747172XX
2230G-HRM Harmonic Reduction Module	0162140XX
15-terminal mating connector with three sense-source connectors	1161283XX

The following items are standard accessories that are included with your Series 2230-30-3 order.

Accessory	Part number
Calibration report	0011655XX
USB cable	1746841XX

The following items are optional accessories that may be included with your Series 2230 order.

Accessory	Part number
15-terminal mating connector with three sense-source connectors	1161283XX
Universal rack mount kit	4299-7

You will also get one of the following power cords.

Option	Description
Option A0	North America and South America. The factory sets the line-voltage selector switch to 110 V.
Option A1	Universal Euro. The factory sets the line-voltage selector switch to 220 V.
Option A2	United Kingdom. The factory sets the line-voltage selector switch to 220 V.
Option A3	Australia. The factory sets the line-voltage selector switch to 220 V.
Option A4	Chile, Italy. The factory sets the line-voltage selector switch to 220 V.
Option A5	Switzerland. The factory sets the line-voltage selector switch to 220 V.
Option A7	Denmark. The factory sets the line-voltage selector switch to 220 V.
Option A8	Israel. The factory sets the line-voltage selector switch to 220 V.
Option A9	Argentina. The factory sets the line-voltage selector switch to 220 V.
Option A10	China. The factory sets the line-voltage selector switch to 220 V.
Option A11	India. The factory sets the line-voltage selector switch to 220 V.
Option A13	Macao, Pakistan, Africa. The factory sets the line-voltage selector switch to 220 V.
Option E1	Europe bundle: United Kingdom, mainland Europe, and Switzerland. The factory sets the line-voltage selector switch to 220 V.

Available services

For the most recent list of available services and accessories, upgrades, and options for your instrument, visit tek.com/keithley (tek.com/en/products/keithley).

General ratings

The Series 2230 general ratings and connections are listed in the following table.

Category	Specification
Power supply	2230-30-3 AC power input level: <ul style="list-style-type: none"> ■ 110 to 120 V ac: 99 V ac to 132 V ac ■ 220 to 240 V ac: 198 V ac to 264 V ac ■ 50 Hz or 60 Hz 2230G-30-6/2230G-60-3 AC power input level: <ul style="list-style-type: none"> ■ 120 VAC: 108 V ac to 132 V ac ■ 220 to 240 V ac: 198 V ac to 264 V ac ■ 50 Hz or 60 Hz Maximum power consumption: <ul style="list-style-type: none"> ■ 2230-30-3: 700 VA ■ 2230-30-6, 2230-60-3: 1000 VA Maximum current: 10 A
Floating voltage	Up to 400 V (DC + peak AC) between protective earth (safety ground) and any output terminal
Operating altitude	Maximum 2000 m (6562 ft) above sea level
Environmental conditions	For indoor use only Operating: 0 °C to 40 °C, full accuracy with maximum 80% relative humidity at up to 40 °C, noncondensing Storage: –20 °C to 70 °C, 10% to 85% relative humidity at up to 40 °C and 5% to 60% relative humidity above 40 °C up to 70 °C Pollution degree: 2 Installation category: II

Wire specifications

Refer to the table below for the maximum current allowed for the various gauges of copper wire.

AWG wire gauge	10	12	14	16	18	20	22	24	26	28
Maximum current (A)	40	25	20	13	10	7	5	3.5	2.5	1.7

NOTE

The table above lists current carrying capacity of a single wire at working temperature of 30 °C. The values in this table conform with the American Wire Gauge (AWG) standard and are provided for reference only.

Quick reference

In this section:

Front-panel overview	2-1
Rear-panel overview	2-2
Install the system	2-3
Select the proper line voltage.....	2-5
Connect the 2230-30-3 power cord.....	2-6
Connect the 2230-30-6/2230-60-3 power cord	2-6
Turn the power supply on and off.....	2-7
If the power supply does not turn on	2-8
Self-test procedure.....	2-9
Remote communications interfaces	2-9

Front-panel overview

All of the Series 2230 power supplies have the same front panel. The Model 2230-30-6 is shown in the figure below; descriptions of the numbered items follow the figure.

Figure 1: Series 2230 front panel

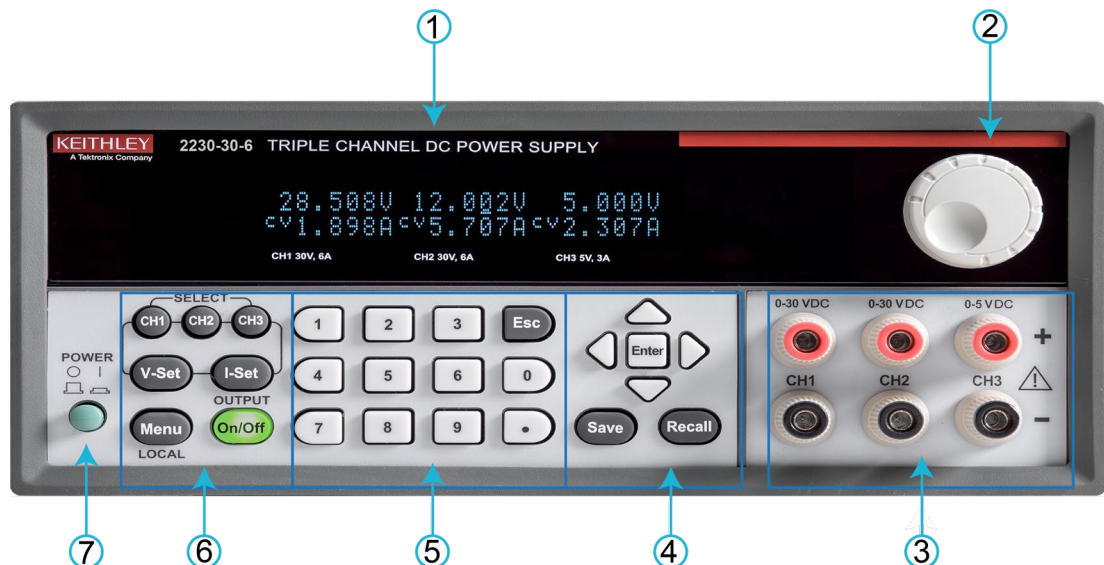

Number	Description
1	Vacuum fluorescent display (VFD)
2	Navigation wheel
3	Output terminals
4	Up, down, left, and right arrow keys; Enter, Save, and Recall function keys
5	Numeric keypad and Esc key
6	Function keys: Channel SELECT (CH1, CH2, CH3), voltage setting (V-Set), current setting (I-Set), Menu, and OUTPUT On/Off keys
7	Power On/Off switch

Rear-panel overview

All of the Series 2230 power supplies have the same rear panel. The rear panel is shown in the figure below; descriptions of the numbered items follow the figure.

Figure 2: Series 2230 rear panel

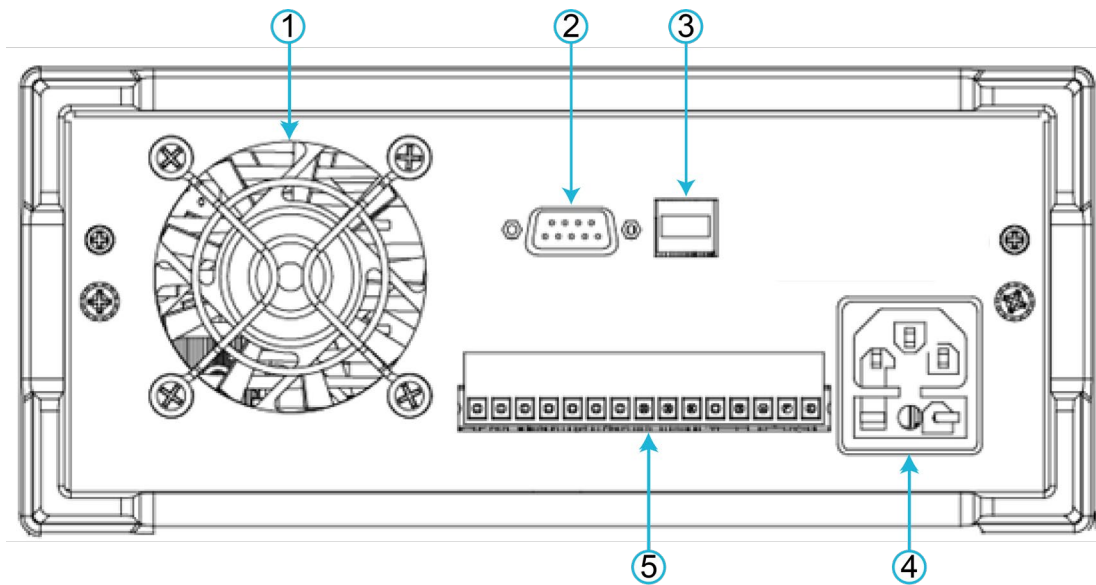

Number	Description
1	Vent
2	RS-232 communication interface
3	USB communication interface
4	AC power input socket (including fuse)
5	Remote sense terminals and the output terminals

Install the system

When you receive your Series 2230 instrument, verify that you have received all of the items listed in [Standard accessories](#) (on page 1-4) and any other accessories that you ordered.

CAUTION

Do not lift or hold the instrument by the front bezel or any other protruding parts. If you do, you may damage the instrument.

Dimensions

The dimensions of a Series 2230 power supply with no bumpers are:

- Width: 214.50 mm (8.44 in.)
- Height: 88.20 mm (3.47 in.)
- Depth: 456.60 mm (17.98 in.)

The following figure shows more detailed measurements for the Series 2230.

Figure 3: Series 2230 dimensions

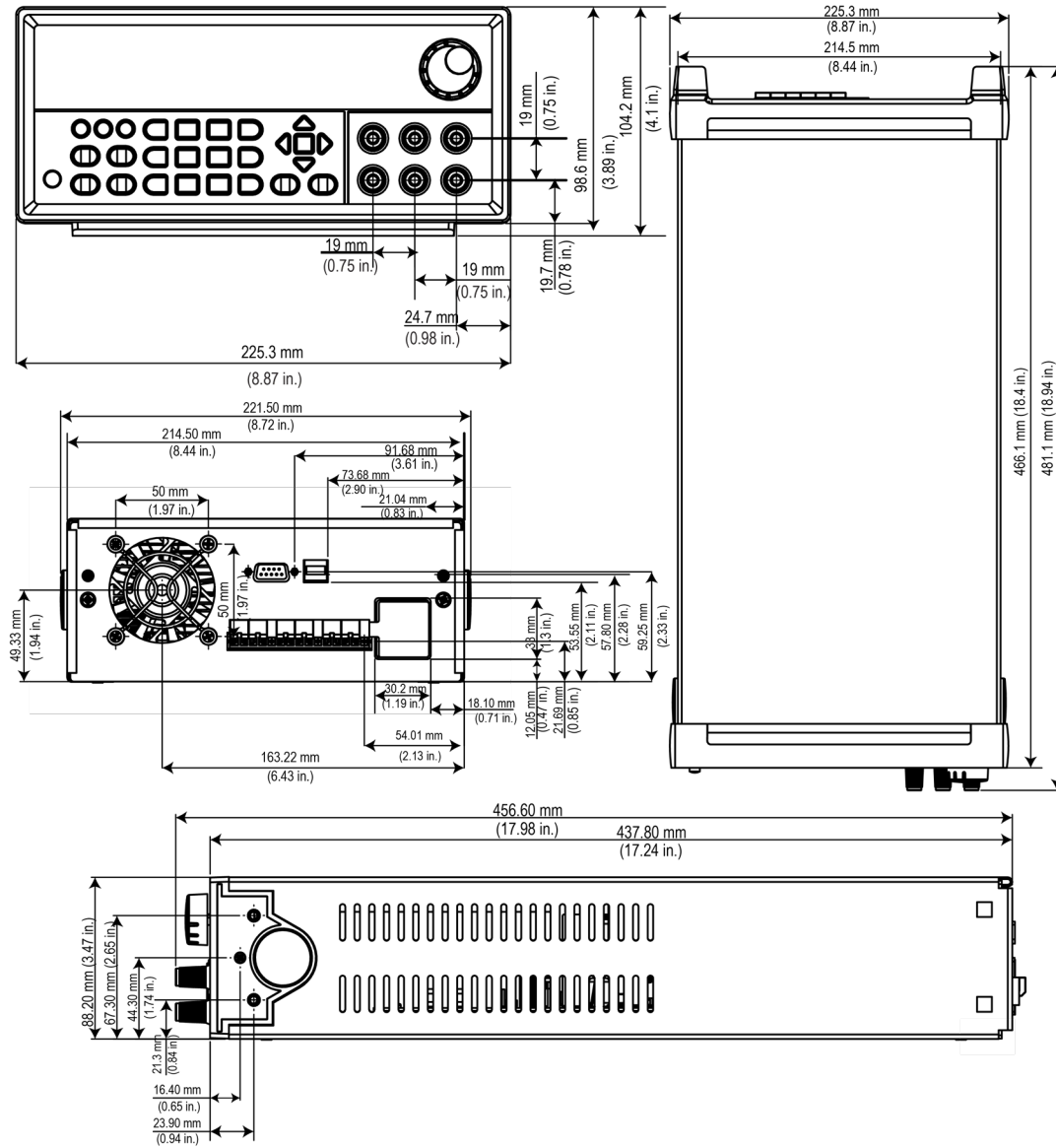

Select the proper line voltage

Series 2230 power supplies have two line voltage ratings:

- 110 V to 120 V for 2230-30-3 or 120 V for 2230-30-6 and 2230-60-3
- 220 V to 240 V

Select a proper line voltage according to the voltage of your facility. You can use the line selector switch on the bottom of the instrument to select the right voltage.

The voltage ranges of the two line voltage ratings are:

- **110 V ac to 120 V ac:** 99 VAC to 132 VAC (2230-30-3) or **120 VAC:** 108 VAC to 132 VAC (2230-30-6 or 2230-60-3)
- **220 V ac to 240 V ac:** 198 VAC to 264 VAC

WARNING

The power cord supplied with the Series 2230 power supply contains a separate protective earth (safety ground) wire for use with grounded outlets. When proper connections are made, the instrument chassis is connected to ground through the ground wire.

In addition, there is a ground terminal for each channel on the rear panel. When a channel is enabled, its ground terminal should be connected to a protective earth. In the event of a failure, not using a properly grounded protective earth and grounded outlet may result in personal injury or death due to electric shock.

Do not replace detachable mains supply cords with inadequately rated cords. Failure to use properly rated cords may result in personal injury or death due to electric shock.

NOTE

When using the model 2230-30-6 or 2230-60-3 in a country that is a member of the European Union, you need to use the 2230-HRM inductor box in-line with the mains power cord to comply with European Union regulations. If you use the inductor, the functions of the instrument are not affected.

Connect the 2230-30-3 power cord

To connect the power cord:

1. Make sure that the front-panel power switch is in the OFF position.
2. Properly set the 110 V/220 V selector switch located on the bottom of the instrument.
3. Connect the female end of the supplied power cord to the AC receptacle on the rear panel.
4. Connect the plug of the power cord to a grounded AC outlet.

Connect the 2230-30-6/2230-60-3 power cord

When using the 2230-30-6 or 2230-60-3 in a country that is a member of the European Union, you must use the 2220G-HRM inductor box in-line with the mains power cord to comply with European Union regulations, as shown in the following diagram.

Figure 4: Connecting the power cord for 2230-30-6 or 2230-60-3

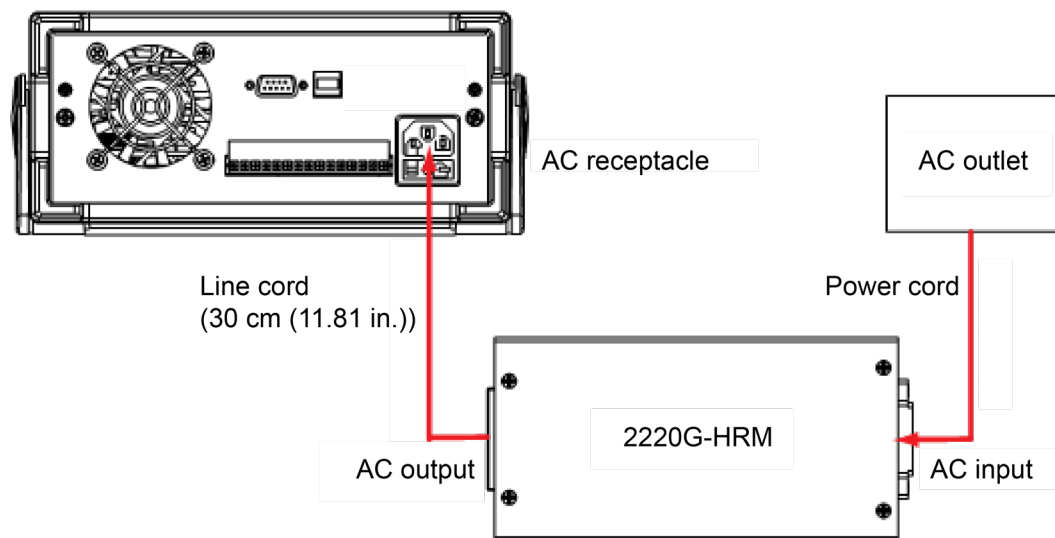

To connect the power cord:

1. Make sure that the front-panel power switch is in the OFF position.
2. Properly set the 110 V/220 V selector switch located on the bottom of the instrument.
3. Connect the female end of the supplied line cord (30 cm (11.81 in.)) to the AC receptacle on the rear panel.
4. Connect the other end of the supplied line cord to the AC output of the 2230G-HRM inductor.
5. Connect the female end of the supplied power cord to the AC input of the 2230G-HRM inductor.
6. Connect the plug of the power cord to a grounded AC outlet.

Turn the power supply on and off

To turn the power supply on and off

1. Disconnect any devices under test (DUTs) from the Series 2230 before turning the instrument on.
2. To turn your instrument on, press the front-panel power switch to put it in the ON position. The display screen illuminates.
3. To turn your instrument off, press the front-panel power switch to put it in the OFF position.

 WARNING

To avoid fire or electric shock, ensure that the AC input voltage fluctuation does not exceed the range of the selected AC line voltage rating.

Make sure that wire sizes are sufficient to ensure safety in the case of short circuit and full load test. See Wire specifications (on page 1-6) for wire size guidelines.

If the power supply does not turn on

To troubleshoot a power-on failure:

1. Verify that the AC power cord is firmly plugged into the power connector on the rear-panel of the Series 2230.
2. Make sure that the AC power source you plugged the power supply into is energized, and then turn the Series 2230 on.
3. Make sure the voltage selector switch is set according to the local voltage (110 VAC or 220 VAC). Change the voltage setting if it is incorrect.
4. Verify that the correct power-line fuse is installed and functioning. If the fuse is damaged, replace it with a fuse appropriate for your model of power supply (see the following table and graphic).

Model number	Fuse specification	Fuse specification
2380-500-15	1.25 AT (115 V ac)	0.5 AT (230 V ac)
2380J-500-15	1.25 AT (100 V ac)	0.5 AT (220 V ac)
2380-120-60	1.25 AT (115 V ac)	0.5 AT (230 V ac)
2380J-120-60	1.25 AT (100 V ac)	0.5 AT (220 V ac)

Figure 5: Model 2380 fuse compartment

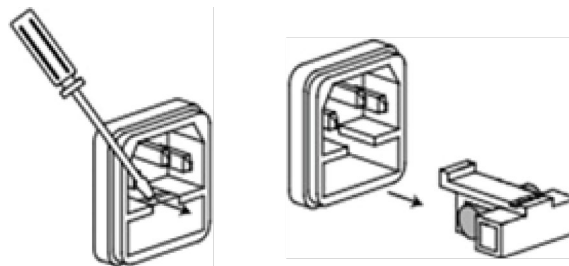

Self-test procedure

The Series 2230 runs a self-test automatically when it is turned on.

When the Series 2230 is turned on, the display shows the software version number (for example, BOIS Ver. 1.XX). After approximately one second, the system starts the self-test and the display shows `Initializing...`

If the self-test finishes with no errors, the display shows the set voltage value of all three channels on the first line and the set current value of all three channels on the second line, in the format shown below.

```
0.000V  0.000V  0.000V
SV0.000A  SV0.000A  SV0.000A
```

Self-test error messages

If an error occurs during the self-test, an error message is displayed. The following table lists the error messages you might see.

Error message	Meaning
EEPROM Test Failure	The EEPROM is damaged.
User Data Lost	The latest operation state of the power supply is lost.
Channel Initialization Failed	A channel failed to respond to inbound data.
Calibration Data Lost	Calibration data cannot be read.
Factory Calibration Data Lost	The factory calibration data in EEPROM is lost.

Remote communications interfaces

The Series 2230 power supplies have two communication interfaces: Universal serial bus (USB) and RS-232 interface.

USB interface

All power supply functions are programmable over the Series 2230G USB interface. The interface is USB 2.0 and USBTMC-compliant.

The interface accepts `REN_CONTROL`, `GO_TO_LOCAL`, and `LOCAL_LOCKOUT` requests. It also accepts the `MsgID = TRIGGER USBTMC` command and forwards `TRIGGER` requests to the function layer.

The USB interface of the Series 2230G:

- Understands all mandatory SCPI commands
- Is SR1, RL1, and DT1 capable.

To use the USB interface:

1. Press the **Menu** key.
2. Use the arrow keys to select **User settings**.
3. Press **Enter**. The screen displays **Output Recall**.
4. Press the down arrow keys to select **Communication Port**.
5. Press **Enter**.
6. Use the arrow keys to select **USB** (default).
7. Press **Enter**.
8. Press **Esc** to exit the menu.

NOTE

If you switch to the front-panel control, all remote commands sent through the USB interface will be invalid. If you want to continue to use the remote commands, you need to send the `SYSTem:REMOte` command or restart the USB interface using the VISA software.

RS-232 interface

You can connect a computer to your Series 2230 RS-232 port using a cable with two COM connectors.

Please ensure the computer and power supply have the same configuration for the following items:

- Baud rate: 4800, 9600, 19200, 38400, 57600, or 115200. You can enter the system menu to set the baud rate.
- Data bit: 8
- Stop bit: 1
- Parity bit: (none, even, odd)
 - none: 8 data bits that have no parity
 - even: 8 data bits that have even parity
 - odd: 8 data bits that have odd parity

For example:

Parity = None	Start bit	8 data bits	Stop bit
---------------	-----------	-------------	----------

To use the RS-232 interface:

1. Make sure the connection from the Series 2230 to the computer is firmly inserted in the port.
2. Press the **Menu** key.
3. Use the arrow keys to select **User settings**.
4. Press **Enter**. The screen displays **Output Recall**.
5. Press the down arrow keys to select **Communication Port**.
6. Press **Enter**.
7. Use the arrow keys to select **RS232**.
8. Select the baud rate from the following options:
 - 4800
 - 9600
 - 19200
 - 38400
 - 57600
 - 115200
9. Select the parity from the following the options:
 - None
 - Even
 - Odd
10. Press **Enter** to confirm your selection.

Function and features

In this section:

Introduction	3-1
Front-panel operation.....	Error! Bookmark not defined.
Menu description.....	3-5
Basic settings.....	3-6
Restore default settings	3-8
Enable or disable channels.....	3-9
Set the maximum voltage.....	3-9
Set the output timers.....	3-10
Set the key lock status	3-10
Track.....	3-11
Combine.....	3-13
User settings	3-19
System information	3-21
Overtemperature protection	3-22
Use the rear-panel terminals.....	3-23

Introduction

This section contains detailed descriptions of the functions and features of the Series 2230 power supply.

Front-panel operation

After the power supply is powered on, the display shows the voltage and current settings of each channel. When these settings are displayed, you can connect the DUT to the power supply and set the parameters. Ensure that **OUTPUT On/Off** key is set to the **Off** state before connecting the DUT and setting the parameters. After finishing the setup, set **OUTPUT On/Off** key to the **On** state and start the measurement.

You can use the navigation wheel to increase or decrease a value or to scroll through the menus after pressing the Menu key.

The display shows the operating status of each channel. When a channel operates in constant voltage mode, the **CV** indicator is displayed. When it operates in the constant current mode, the **CC** indicator is displayed.

Front-panel keypad

You can use the front-panel keys to control the Series 2230. Descriptions of what the keys do follow the figure below.

Figure 6: Front-panel keypad



Key	Description
	Select channel 1.
	Select channel 2.
	Select channel 3.
	Set the voltage limit.
	Set the current limit.
	Open the menu to access various Series 2230 settings.
	Turn the output of all enabled channels on or off. When you turn on the output, the CC or CV indicator is visible on the display.
	Enter numbers for settings values.
	Return to the previous menu level.
	Use left and right arrow keys to move the cursor.
	Use up and down arrow keys to adjust the parameters or select the menu operation.
	Select the menu item or confirm an operation.
	Save the present settings as a saved setup. The Series 2230 supports up to 36 saved setups.
	Return the instrument to the specified setup.

Turn the 2230 output on

You can turn the 2230 output on from the front panel or by sending remote commands.

To turn the output on using the front panel, press the OUTPUT **On/Off** button. The instrument is in the output-on state when the switch is illuminated.

To turn the output on using SCPI commands, send the command:

```
:OUTPut:STATe ON
```

NOTE

When you are using a remote interface to control the instrument and the output is turned off, pressing the OUTPUT **On/Off** button will not turn the output on. However, if the output is turned on, you can press the OUTPUT **On/Off** button to turn the output off.

Turn the 2230 output off

WARNING

Turning the 2230G output off does not place the instrument in a safe state. Hazardous voltages may be present on all output and guard terminals. To prevent electrical shock that could cause injury or death, never make or break connections to the 2230G while the instrument is powered on. Turn off the equipment from the front panel or disconnect the main power cord from the rear of the 2230G before handling cables. Putting the equipment into an output-off state does not guarantee that the outputs are powered off if a hardware or software fault occurs.

To turn the output off using the front panel, press the OUTPUT **On/Off** button. The instrument is in the output-off state when the button is not illuminated.

To turn the output off using SCPI commands, send the command:

```
:OUTPut[:STATe] OFF
```

Navigation wheel

You can use the navigation wheel to adjust voltage and current values or select the menu operation.

The navigation wheel is identified in the Front-panel overview.

Rotate the navigation wheel (shown circled in the following figure) clockwise to increase the value and counterclockwise to decrease the value.

Figure 7: Navigation wheel



Turn the navigation wheel to scroll through the menus after pressing the **Menu** key. When you have selected the menu item or value you want, press the **Enter** key to save your setting.

Display indicators

Indicators on the front panel of the Series 2230 indicate the present state of the instrument. The following table describes these indicators.

Indicator	Meaning
CC	Constant current mode
CV	Constant voltage mode
SV	Setting mode, programmed voltage and current settings are displayed
Y	The power supply is in remote control mode
Series	The outputs of channel 1 and channel 2 are wired in series
Para	The outputs of channel 1 and channel 2 are wired in parallel
T	Tracking mode is enabled

Menu description

You can use the front-panel Menu key to access many of the Series 2230 settings. The following table describes the settings available from the menu. Additional details about each setting are available later in this section.

Menu items		Description
Default Set		Restores the factory default settings.
Enable Channels		
	Enable/Disable CH1	Enables or disables channel 1.
	Enable/Disable CH2	Enables or disables channel 2.
	Enable/Disable CH3	Enables or disables channel 3.
Protection Settings		
	Max Volt Set	Sets the maximum voltage for each channel. This setting affects the voltage range setting.
	Output Timers	Sets the output timers for each channel. Once the timer expires, the output of the specified channel is turned off.
	Key Lock	Locks the keyboard (except the output On/Off key, left and right arrow keys, Channel SELECT (CH1, CH2, CH3), V-Set, I-Set and POWER keys function) with a password to avoid improper operation. Key Lock prevents any adjustments to channel output parameters.
Track		
	Track Off (default)	Disables the tracking mode.
	Track CH1/CH2	Sets CH1 and CH2 to tracking mode.
	Track CH2/CH3	Sets CH2 and CH3 to tracking mode.
	Track ALL	Sets CH1, CH2, and CH3 to tracking mode.

Menu items		Description
Combine		
	Combine Off (default)	Disables the series or parallel operation mode.
	V1+V2 Series	Sets CH1 and CH2 to series operation mode.
	I1+I2 Parallel	Sets CH1 and CH2 to parallel operation mode.
	I2+I3 Parallel	Sets CH2 and CH3 to parallel operation mode.
	ALL Parallel	Sets CH1, CH2, and CH3 to parallel operation mode.
User Settings		
	Output Recall	Sets the output state after the Series 2230 is turned on.
	Save Last	Sets the voltage, current, and maximum voltage values after the Series 2230 is turned on.
	Key Beep	Turns the key beeper on or off.
	Knob Lock	Locks the navigation wheel (knob).
	Communication Port	RS-232: Sets the communication interface to RS-232. You can select the baud rate (4800, 9600, 19200, 38400, 57600, or 115200) and parity (None, Even parity, or Odd parity).
		USB (default): Sets the communication interface to USB.

Menu items		Description
System Info		
	Error Log	Lists all errors that occurred.
	Main:0.01/Aux:1.06	Displays the firmware version.
	0123456789AF	Displays the serial number.

Basic settings

The following topics describe how to set up and use the Series 2230.

Set the voltage output or voltage limit for a specific channel

You can set the voltage limit from 0 V to the maximum voltage specified for your Series 2230.

To set the voltage limit:

1. Select the channel by pressing the **CH1**, **CH2**, or **CH3** key.
2. Press the **V-Set** key.
3. Use the numeric keys, the navigation wheel, or the up, down, right, and left arrow keys to set the voltage limit.
4. Press the **Enter** key to confirm the setting.

Set the current output or current limit for a specific channel

You can set the current limit from 0 A to the maximum current specified for your Series 2230.

To set the current limit:

1. Select the channel by pressing the **CH1**, **CH2**, or **CH3** key.
2. Press the **I-Set** key.
3. Use the numeric keys, the navigation wheel, or the up, down, right, and left arrow keys to set the current limit.
4. Press **Enter** to confirm the setting.

Save and recall setups

You can store up to 36 different setups in Series 2230 memory. Each setup includes a voltage limit, current limit, and maximum output voltage for each channel.

To save the setups:

1. After you set up the Series 2230, press the **Save** key.
2. Use the number keys, the navigation wheel, or the arrow keys to select the setup memory (1 to 36) that you want to store the values in.
3. Press **Enter** to confirm your setting.

To recall the setups:

1. Press the **Recall** key.
2. Use the number keys, the navigation wheel, or the arrow keys to select the setup that you want to recall.
3. Press **Enter**.

You can also use the following SCPI commands to save or recall the setup:

*SAV

*RCL

NOTE

The Series 2230 does not support the save and recall functions when the channels are in tracking mode or when they are wired in series or parallel.

Restore default settings

To restore the factory default settings:

1. Remove all of the leads from the output terminals.
2. Press the **Power** key to turn on the power supply.
3. Press **Menu**.
4. Press **Enter** to select **Default Set**.
5. Press the down arrow key to select **Yes**.
6. Press **Enter**. The display shows `Defaults Restored!`. The default settings for the menu selections are shown in the following table.

Menu selection	Default setting
Enable Channels	Enable CH1
	Enable CH2
	Enable CH3
Max V CH1	Off
Max V CH2	Off
Max V CH3	Off
Timer CH1	Off
Timer CH2	Off
Timer CH3	Off
Track	Track off
Combine	Combine off
Output Recall	Off
Save Last	On
Key beep	Off
Knob Lock	Off
Communication Port	USB

Enable or disable channels

You can enable or disable each output channel using the menu settings. If a channel is disabled, it remains off when the OUTPUT On/Off key is pressed. The default setting has all the channels enabled.

To enable or disable a channel:

1. Press the **Menu** key.
2. Press the down arrow key to select **Enable Channels**.
3. Press **Enter** to confirm the setting.
4. Press the down arrow key to select **Channel** and press **Enter**.
5. Press the down arrow key to select **Disable CH1** or **Enable CH1 (default)**.
6. Press **Enter**.

Set the maximum voltage

You can set the maximum voltage for each channel to avoid accidental overvoltage output and protect sensitive loads from damage.

To set the maximum voltage:

1. Press the **Menu** key.
2. Press the down arrow key to select **Protection Settings**.
3. Press **Enter**. The `Max Volt Set` indicator is displayed.
4. Press **Enter**. A list of maximum voltage settings for each channel is displayed.
5. Use the up and down arrow keys to select the correct channel and press **Enter** to confirm.
6. Press the down arrow key to select **On**.
7. Use the numeric keys, the up and down arrow keys, or the navigation wheel to adjust the voltage value. The value must be less than the rated voltage of the power supply.
8. Press **Enter**.
9. Press the **Esc** key to exit the menu.

Set the output timers

You can set the amount of time that the output stays on for each channel. When the OUTPUT On/Off key is pressed, the timers start and the output is turned on. When each active timer expires, its corresponding channel output turns off. The timer range is from 0.1 seconds to 99999.9 seconds.

To set the output timers:

1. Press the **Menu** key.
2. Press the down arrow key to select **Protection Settings** and press **Enter**.
3. Press the down arrow key to select **Output Timers** and press **Enter**.
4. Use the up and down arrow keys to select the correct channel and press **Enter** to confirm.
5. Press the down arrow key to select **On** and press **Enter**.
6. Use the numeric keys, the up and down arrow keys, or the navigation wheel to adjust the timer.
7. Press **Enter**.
8. Press the **Esc** key to exit the menu.

Set the key lock status

You can set the key lock status for each channel in the Protection Settings menu. This function prevents any adjustments from being made to the instrument. Once the lock is activated, a four-digit, user-specified password must be entered to change any instrument settings. After the front panel is locked, only the OUTPUT On/Off key, left and right arrow keys, Channel SELECT (CH1, CH2, CH3), V-Set, I-Set, and POWER keys function. However, changes to settings cannot be made unless the password is entered. Turning the power off deactivates the lock and resets the password.

To set the key lock status:

1. Press the **Menu** key.
2. Press the down arrow key to select **Protection Settings**.
3. Press **Enter**.
4. Press the down arrow key to select **Key Lock** and press **Enter**.
5. Use numeric keys to input a four-digit password and press **Enter**.

Track

You can set channel 1 (CH1) and channel 2 (CH2), CH2 and channel 3 (CH3), and all three channels to tracking mode. When CH1/CH2 tracking is on, channel 1 and channel 2 respond relative to one another when adjustments in voltage are made. A constant ratio is maintained between the voltage settings on the two channels.

The voltage ratio is set between channel 1 and channel 2 when CH1/CH2 tracking is turned on. For example, if channel 1 and channel 2 are both set to 1 V when tracking is turned on, a one-to-one ratio is maintained and any voltage change on channel 1 results in a corresponding change on channel 2. If channel 1 is set to 10 V and channel 2 is set to 5 V when tracking is turned on, a two to one ratio is maintained and any voltage change on channel 1 results in a voltage change of half the size of channel 2.

To set up CH1/CH2 tracking mode:

1. Press the **CH1** key.
2. Press the **V-Set** key and enter the voltage value for channel 1. For example, set the voltage of channel 1 to 3 V.
3. Press the **Enter** key.
4. Press the **CH2** key.
5. Press the **V-Set** key and enter a voltage in the ratio you want for channel 2. For example, set the voltage of channel 2 to 6 V. The ratio is 2.
6. Press the **Enter** key.
7. Press the **Menu** key, and using the down arrow key, navigate to **Track**, and then press the **Enter** key.
8. Press the down arrow key to select **Track CH1/CH2** and then press the **Enter** key to turn on tracking.
9. Verify that T is displayed between the voltage readings of channel 1 and channel 2 on the display. This indicates that the power supply is in tracking mode.

To set up CH2/CH3 tracking mode:

1. Press the **CH2** key.
2. Press the **V-Set** key and enter the voltage value for channel 2. For example, set the voltage of channel 2 to 3 V.
3. Press the **Enter** key.
4. Press the **CH3** key.
5. Press the **V-Set** key and enter a voltage in the ratio you want for channel 3. For example, set the voltage of channel 3 to 6 V. The ratio is 2.
6. Press the **Enter** key.
7. Press the **Menu** key, and using the down arrow key, navigate to **Track**, and then press the **Enter** key.
8. Press the down arrow key to select **Track CH2/CH3** and then press the **Enter** key to turn on tracking.
9. Verify that Γ is displayed between the voltage readings of channel 2 and channel 3 on the display. This indicates that the power supply is in tracking mode.

To set up CH1/CH2/CH3 tracking mode:

1. Press the **CH1** key.
2. Press the **V-Set** key and enter the voltage value for channel 1. For example, set the voltage of channel 1 to 1 V.
3. Press the **CH2** key.
4. Press the **V-Set** key and enter the voltage value for channel 2. For example, set the voltage of channel 2 to 1 V. The ratio between channel 1 and channel 2 is 1.
5. Press the **Enter** key.
6. Press the **CH3** key.
7. Press the **V-Set** key and enter a voltage in the ratio you want for channel 3. For example, set the voltage of channel 3 to 2 V. The ratio between channel 1 and channel 3 is 2, and the ratio between channel 2 and channel 3 is 2.
8. Press the **Enter** key.
9. Press the **Menu** key, and using the down arrow key, navigate to **Track**, and then press the **Enter** key.
10. Press the down arrow key to select **Track ALL** and then press the **Enter** key to turn on tracking.
11. Verify that Γ is displayed among the voltage readings of channel 1, channel 2, and channel 3 on the display. This indicates that the power supply is in tracking mode.

To disable tracking mode:

1. Press the **Menu** key.
2. Use the arrow keys to select **Track**.
3. Press the **Enter** key.
4. Use the arrow keys to select **Track Off** (default).
5. Press **Enter**.

NOTE

If the voltage or current is set to 0, the tracking setting is ignored.

If tracking is enabled and channel 1 (CH1) and channel 2 (CH2) timers are set, the timer uses the smaller set value.

Combine

You can combine the outputs of the channels. You can only set CH1 and CH2 of model 2230-30-3 and 2230-30-6 to series operation mode. You can set CH1 and CH2, CH2 and CH3, or all three channels of 2230 to parallel operation mode. The following procedures show you how to combine channels when outputs are wired in series or in parallel.

WARNING

Do not set CH1 and CH2 of the 2230-60-3 to series operation mode. This will cause the 2230-60-3 to output the voltages of V1 and V2 combined, which exceeds the safe voltage of 60 V dc. Setting CH1 and CH2 to series operation may expose you to hazardous voltages that, if contacted, could cause personal injury or death.

V1+V2 combination for series connections

You can connect two Series 2230-30 terminals in series and display the combined output voltage value on channel 1. You cannot safely connect all three channels in series.

⚠ WARNING

Model 2230G-30-3 and 2230G-30-6 only support combining CH1 and CH2 in series mode. Do not combine CH1, CH2, and CH3. This will cause the instrument to output the voltages of V1, V2, and V3 combined, which exceeds the safe voltage of 60 VDC. Setting CH1, CH2, and CH3 to series operation may expose you to hazardous voltages, that if contacted, could cause personal injury or death.

NOTE

The wiring between the power supply output terminals affects the accuracy of measurements in this mode. Make sure that wire sizes are sufficient, wires are short, and connections are tightened to ensure maximum accuracy. See [Wire specifications](#) (on page 1-6) for wire size guidelines.

To combine channel 1 and channel 2 when the outputs are connected in series:

1. Connect the outputs in series, as shown in the following figure.

Figure 8: Outputs wired in series

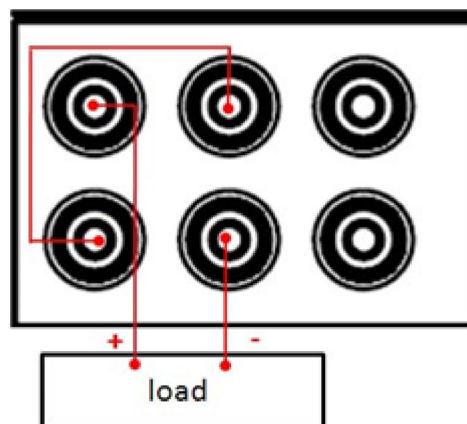

2. Press the **Menu** key.
3. Use the arrow keys to select **Combine**.
4. Press the **Enter** key.
5. Press the down arrow key to select **V1+V2 Series**.
6. Press the **Enter** key. The screen returns to meter mode. Verify that the `Series` indicator is displayed, replacing the channel 2 voltage and current readings. This indicates that the power supply is in the V1+V2 series state. The total output voltage is displayed on channel 1.

```
1.000V  Series  1.000V
SV0.000A      SV0.000A
```

7. Set the channel 1 voltage to the voltage value you want.

I1+I2 parallel

You can connect two Series 2230 output terminals in parallel and display the combined output current value on channel 1.

NOTE

The wiring between the power supply output terminals affects the accuracy of measurements in this mode. Make sure that wire sizes are sufficient, wires are short, and connections are tightened to ensure maximum accuracy. See [Wire specifications](#) (on page 1-6) for wire size guidelines.

To combine channel 1 and channel 2 when the outputs are connected in parallel:

1. Connect the outputs in parallel, as shown in the following figure.

Figure 9: CH1 and CH2 outputs connected in parallel

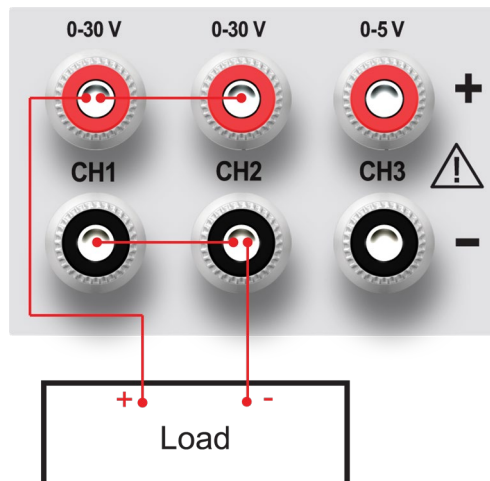

2. Press the **Menu** key.
3. Use the arrow keys to select **Combine**.
4. Press the **Enter** key.
5. Press the down arrow key to select **I1+I2 Parallel**.
6. Press the **Enter** key. The screen returns to meter mode. Verify that the `Para` indicator is displayed, replacing the channel 2 voltage and current readings. This indicates that the power supply is in the I1+I2 parallel state. The total output current is displayed on channel 1.

```
1.000V  Para  1.000V
SV0.000A      SV0.000A
```

7. Set channel 1 current to the current value you want.

I2+I3 parallel

NOTE

The wiring between the power supply output terminals affects the accuracy of measurements in this mode. Make sure that wire sizes are sufficient, wires are short, and connections are tightened to ensure maximum accuracy. See [Wire specifications](#) (on page 1-6) for wire size guidelines.

When I2+I3 Parallel mode is enabled, the voltage range of CH2 is changed to the smaller one of CH2 and CH3. The maximum output voltage is 5 V.

To combine channel 2 and channel 3 when the outputs are connected in parallel:

1. Connect the outputs in parallel, as shown in the following figure.

Figure 10: CH2 and CH3 outputs connected in parallel

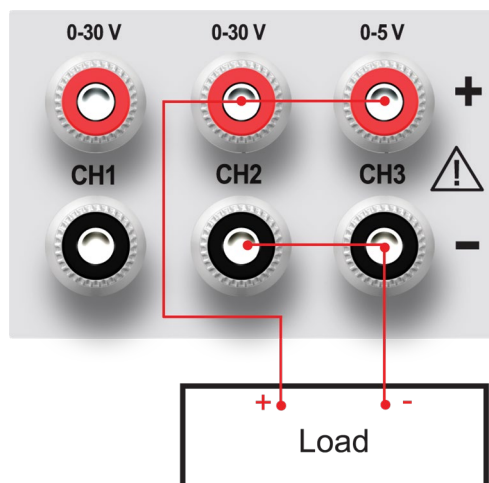

2. Press the **Menu** key.
3. Use the arrow keys to select **Combine**.
4. Press the **Enter** key.
5. Press the down arrow key to select **I2+I3 Parallel**.
6. Press the **Enter** key. The screen returns to meter mode. Verify that the `Para` indicator is displayed, replacing the channel 3 voltage and current readings. This indicates that the power supply is in the I2+I3 parallel state. The total output current is displayed on channel 2.

```
1.000V    1.000V    Para
SV0.000A  SV0.000A
```

7. Set channel 2 current to the current value you want.

I1+I2+I3 parallel

You can connect two Series 2230 output terminals in parallel and display the combined output current value on channel 1.

NOTE

The wiring between the power supply output terminals affects the accuracy of measurements in this mode. Make sure that wire sizes are sufficient, wires are short, and connections are tightened to ensure maximum accuracy. See [Wire specifications](#) (on page 1-6) for wire size guidelines.

When ALL Parallel mode is enabled, the voltage range of CH1 and CH2 are changed to the smaller one of CH1, CH2, and CH3. The maximum output voltage is 5 V.

To combine channel1, channel 2, and channel 3 when the outputs are connected in parallel:

1. Connect the outputs in parallel, as shown in the following figure.

Figure 11: CH1, CH2, and CH3 outputs connected in parallel

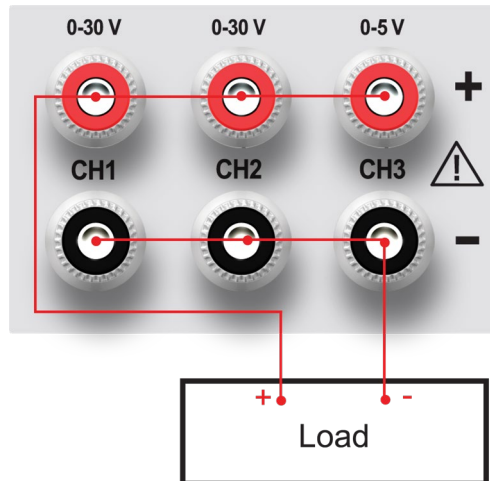

2. Press the **Menu** key.
3. Use the arrow keys to select **Combine**.
4. Press the **Enter** key.
5. Press the down arrow key to select **ALL Parallel**.
6. Press the **Enter** key. The screen returns to meter mode. Verify that the `Para` indicator is displayed, replacing the channel 2 and channel 3 voltage and current readings. This indicates that the power supply is in the I1+I2+I3 parallel state. The total output current is displayed on channel 1.

```
1.000V   Para   Para
SV0.000A
```

7. Set channel 1 current to the current value you want.

Turn off channel combination

To turn off the combination of the channels:

1. Remove all connections to the output terminals.
2. Press the **Menu** key.
3. Use the arrow keys to select **Combine**.
4. Press the **Enter** key.
5. Press the down arrow key to select **Combine Off** (default).
6. Press the **Enter** key.

User settings

You can adjust the output state and settings when the power supply is on. You can also set the beeper, navigation wheel (knob) state, and communication port in this menu.

Restore last output state on power up

This setting specifies whether the Series 2230 returns to the output state it was in before the power was last turned off. If you select **On** for the output recall function, the Series 2230 restores the output to the last state it was in before the power was turned off.

For example, if the output is turned on when the power supply is turned off or loses power, the output returns to the **On** state when the power supply is turned back on or power is restored. If you select **Off**, the output channel is always set to off after power is restored.

To enable or disable this function:

1. Press the **Menu** key.
2. Use the arrow keys to select **User settings**.
3. Press the **Enter** key.
4. Select **Output Recall**.
5. Press the **Enter** key.
6. Use the arrow keys to select **On** or **Off**.
7. Press the **Enter** key.
8. Press the **Esc** key to exit the menu.

Save last

This setting specifies whether the power supply saves its most recent settings (for example, voltage and current) and restores these settings when turned on again. If you select **On**, the power supply restores the instrument to the state that it was in before the power was last turned off. If you select **Off**, the factory default settings are applied (1 V and 0 A for each channel).

To enable or disable this function:

1. Press the **Menu** key.
2. Use the arrow keys to select **User settings**.
3. Press the **Enter** key. `Output Recall` is displayed.

4. Use the arrow keys to select **Save Last**.
5. Press the **Enter** key.
6. Use the arrow keys to select **On** or **Off**.
7. Press the **Enter** key.
8. Press the **Esc** key to exit the menu.

Key beep

You can turn the instrument key-clicking sound on or off from this menu.

To enable or disable this function:

1. Press the **Menu** key.
2. Use the arrow keys to select **User settings**.
3. Press the **Enter** key. `Output Recall` is displayed.
4. Press the down arrow keys to select **Key Beep**.
5. Press the **Enter** key.
6. Use the arrow keys to select **On** or **Off**.
7. Press the **Enter** key.
8. Press the **Esc** key to exit the menu.

Navigation wheel lock

Using the Knob Lock function, you can lock the navigation wheel (knob) so it cannot be used to change settings or to select menu items.

To enable or disable this function:

1. Press the **Menu** key.
2. Use the arrow keys to select **User settings**.
3. Press the **Enter** key. `Output Recall` is displayed.
4. Press the down arrow keys to select **Knob Lock**.
5. Press the **Enter** key.
6. Use the arrow keys to select **On** or **Off**.
7. Press the **Enter** key.
8. Press the **Esc** key to exit the menu.

Communication port

The Series 2230 power supply has two communication interfaces: RS-232 and USB.

To set the communication port:

1. Press the **Menu** key.
2. Use the arrow keys to select **User settings**.
3. Press the **Enter** key. `Output Recall` is displayed.
4. Press the down arrow keys to select **Communication Port**.
5. Press the **Enter** key.
6. Use the arrow keys to select **RS232** or **USB** (default).
If you select the RS-232 communication interface, you must set the baud rate and parity.
7. Press the **Enter** key.
8. Press the **Esc** key to exit the menu.

System information

You can look up system information such as the error log, firmware version, serial number, and calibration date in the System Info menu.

Check the error log

You can check the error log to see what errors have occurred.

To check the error log:

1. Press the **Menu** key.
2. Use the arrow keys to select **System Info**.
3. Press the **Enter** key.
4. Use the arrow keys to select **Error Log**.
5. Press the **Enter** key. A list of errors that occurred is displayed.
6. Press the **Esc** key to exit the menu.

Check the firmware version

You can see what firmware version is installed on your Series 2230 by following the procedure below.

To view the firmware version:

1. Press the **Menu** key.
2. Use the arrow keys to select **System Info**.
3. Press the **Enter** key.
4. Use the arrow keys to select **Main**. The numbers you see after `Main` and `Aux` are the main firmware version and auxiliary firmware version, respectively.
5. Press the **Esc** key to exit the menu.

Check the serial number

You can view the serial number of your Series 2230 by following the procedure below.

To view the serial number:

1. Press the **Menu** key.
2. Use the arrow keys to select **System Info**.
3. Press the **Enter** key.
4. Use the arrow keys to select **0123456789AF**. The numbers you see are the serial number of the instrument.
5. Press the **Esc** key to exit the menu.

Overtemperature protection

If the internal temperature of the power supply exceeds 85 °C (185 °F), the instrument beeps and displays `Over temperature`, and then the instrument power turns off automatically.

Use the rear-panel terminals

When the input current of a DUT is high, there is a voltage drop on the wires between the DUT and output terminal of the power supply. You can use remote sense wire connections to compensate for the voltage drop and maximize measurement accuracy.

The rear-panel terminals are shown in the following figure.

Figure 12: Remote sense connections

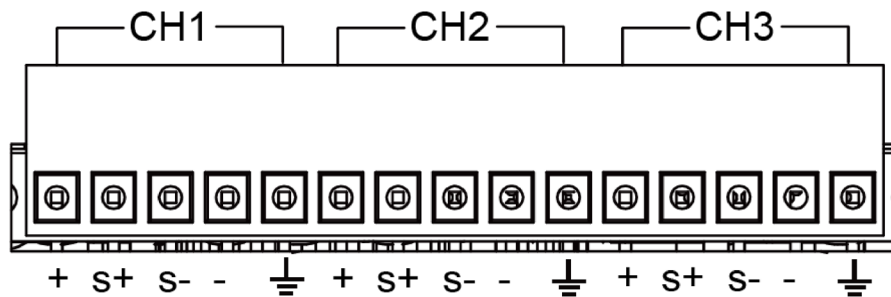

The terminals labeled + and - are the positive and negative output terminals.

The terminals labeled S+ and S- are the positive and negative remote sense terminals.

There is a ground terminal for each channel on the rear panel. When a channel is enabled, its ground terminal should be connected to a protective earth.

Remote sense connections

To use the remote sense terminals:

1. On the Series 2230, remove the connections between the positive (+) and sense positive (S+) terminals.
2. Remove the connection between the negative (-) and sense negative (S-) terminals.
3. Connect the S+ terminal to the positive terminal of the instrument under test.
4. Connect the S- terminal to the negative terminal of the instrument under test.

Figure 13: Remote sense connections to an instrument under test

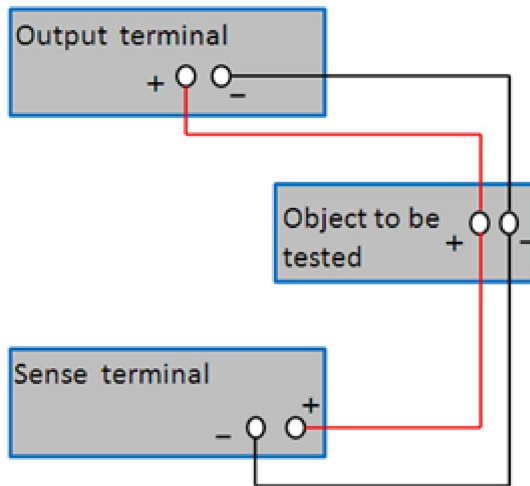

NOTE

To ensure the stability of the system, use armored twisted-pair cable between the remote sense terminals and the instrument under test.

CAUTION

To avoid damage to the Series 2230, ensure that the polarity of the connections is correct.

Local sense connections

Local sense (2-wire) connections do not compensate for the voltage drop in the connections to the instrument under test.

NOTE

When using local sense, the remote sense terminals cannot be disconnected.

To use the local sense terminals:

1. Connect the positive (+) terminals to the sense positive (S+) terminals, as shown in the following figure.

Figure 14: Local sense connections

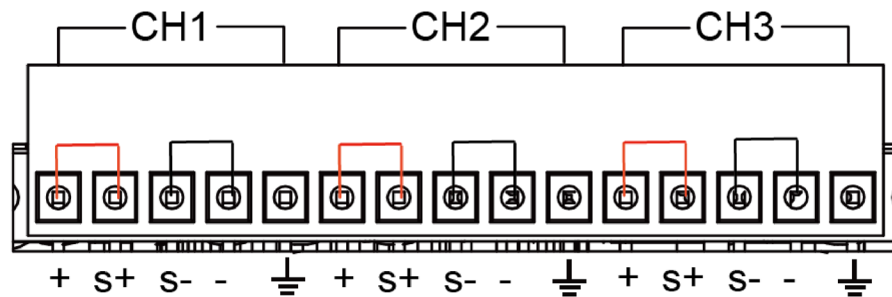

2. Connect the negative (-) terminals to the sense negative (S-) terminals to create a short circuit using short clips or electric wire.
3. Connect the Series 2230 front-panel positive and negative terminals to the instrument under test.

CAUTION

Do not disconnect the remote sense wires, even when remote sense is not used. Doing so will cause erratic behavior and may damage the power supply.

Introduction to SCPI

In this section:

Standard Commands for Programmable Instruments.....	4-1
Conventions	4-2
Commands to use with the Series 2230	4-2
Types of SCPI messages.....	4-3
Command execution rules	4-4
Case sensitivity	4-4
Long-form and short-form versions	4-4
The message unit	4-5
Multiple commands in a message.....	4-8
Including common commands	4-9
SCPI data formats.....	4-9
Response messages	4-10
SCPI command completion.....	4-12
Using device clear.....	4-12
Default setup.....	4-13

Standard Commands for Programmable Instruments

Standard Commands for Programmable Instruments (SCPI) is a standard programming language for controlling instrument functions over USB connections. SCPI programming language acts as an interface for the hardware-portion of the IEEE 488-2 standard. The SCPI commands and parameters can be used to control different classes of instruments using the same code.

This section is an overview of how SCPI commands are constructed and how they are used with the Series 2230.

Detailed command descriptions are available in the [SCPI command reference](#) (on page 5-1).

Conventions

The following table describes the typographical conventions used in this section of the manual.

Symbol	Name	Usage
< >	Angle brackets	The italicized text within angle brackets is a placeholder for parameters that you enter. For example, <NR1> indicates a specific form of numerical data.
	Vertical line	The vertical line separates optional parameters. For example, NORM TEXT indicates that either NORM or TEXT can be used as a parameter.
[]	Square brackets	The parameter within square brackets is optional and can be omitted. For example, [SOURce:]VOLTage indicates that SOURce: can be omitted.
{ }	Curly braces	The parameter within curly braces can be omitted or entered one or more times. It is used mostly for representing arrays. The notation <A>{<,B>} means that parameter A must be entered, but parameter B may be omitted or may be used one or more times.

Commands to use with the Series 2230

There are two types of commands you can use when communicating remotely with the Series 2230: Common commands and Standard Commands for Programmable Instruments (SCPI) subsystem commands.

- Common commands:** These commands are not usually related to specific operation, but to controlling the instrument overall. Example functions are instrument reset, status, and synchronization.

All common commands consist of a three-letter mnemonic preceded by an asterisk:

```
*RST *IDN? *SRE 8.
```

- Subsystem commands:** These commands perform specific power supply functions. They are organized in an inverted tree structure with the root at the top. The following figure shows a portion of a subsystem command tree from which you access the commands located along the various paths.

Figure 15: Example SCPI command tree

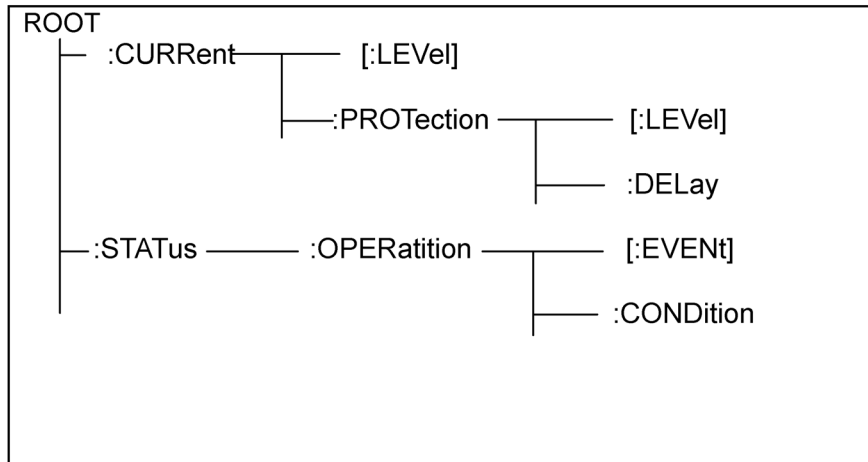

Types of SCPI messages

There are two types of SCPI messages:

- **Program messages:** A program message consists of one or more properly formatted SCPI commands sent from the controller to the power supply. The message, which may be sent at any time, instructs the power supply to perform some action.
- **Response message:** A response message consists of data in a specific SCPI format sent from the power supply to the controller. The power supply sends the message only when commanded by a program message called a "query."

The following figure illustrates SCPI message structure.

Figure 16: SCPI message structure

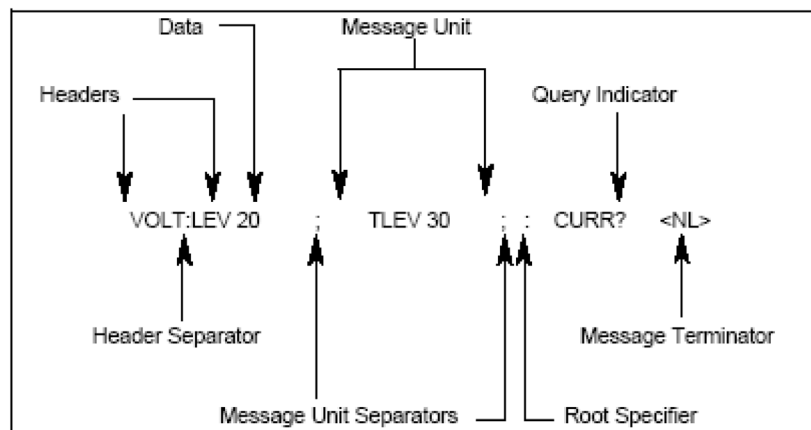

Command execution rules

The following are a few basic rules of SCPI command execution:

- Commands execute in the order that they are presented in the command message.
- An invalid command generates an error message and is not executed.
- Valid commands that precede an invalid command in a multiple command message are executed.
- Valid commands that follow an invalid command in a multiple command message are ignored.

Case sensitivity

Common commands and SCPI commands are not case sensitive. You can use uppercase or lowercase characters, as shown in the following examples:

```
*RST = *rst
:DATA? = :data?
:SYSTem:PRESet = :system:preset
```

Long-form and short-form versions

A SCPI command word can be sent in its long-form or short-form version. The command subsystem tables in the [SCPI command reference](#) (on page 5-1) provide the long-form version. However, the short-form version is indicated by upper case characters. The following are some examples:

:SYSTem:PRESet	Long-form
:SYST:PRES	Short-form
:SYSTem:PRES	Combination of long-form and short-form

NOTE

Each command word must be in long-form or short-form, and not something in between. For example, :SYSTe:PRESe is illegal and will generate an error. The command will not be executed.

The message unit

The simplest SCPI command is a single message unit consisting of a command header (or keywords) followed by a message terminator. The message unit may include a parameter after the header. The parameter can be numeric or a string. For example:

```
VOLTage 20<NL>
```

The following topics describe the parts of a SCPI command message in more detail.

Headers

Headers, also referred to as keywords, are instructions recognized by the power supply. Headers may be either in the long form or the short form.

In the long form, the header is completely spelled out, such as `VOLTage`, `STATus`, and `DELay`.

In the short form, the header has only the first three or four letters. Examples of four-letter short form commands are `VOLT` and `STAT`. If the fourth letter of the long form is a vowel (for example, `DELete`), the short form only contains three letters (`DEL`).

Queries

You can use a query to determine the present value of the parameters of the command or to get information from the instrument. Following a header with a question mark turns it into a query, for example:

```
VOLTage?
```

```
VOLTage:PROTection?
```

If a query contains a parameter, place the query indicator at the end of the last header, for example:

```
VOLTage:PROTection? MAX
```

Observe the following precautions with queries:

- Set up the proper number of variables for the returned data. For example, if you are reading back a measurement array, you must dimension the array according to the number of measurements that you have placed in the measurement buffer.
- Read back all the results of a query before sending another command to the power supply. If you send another command before the results of a query have been returned, an error message, `Query Interrupted` is generated and the unreturned data is lost.

Message unit separator

When two or more message units are combined into a compound message, separate the units with a semicolon (;), for example:

```
STATus:OPERation?; QUESTionable?
```

Root specifier

When it precedes the first header of a message unit, the colon becomes the root specifier, as shown in the following figure. It tells the command parser that this is the root or the top node of the command tree.

Figure 17: SCPI message structure

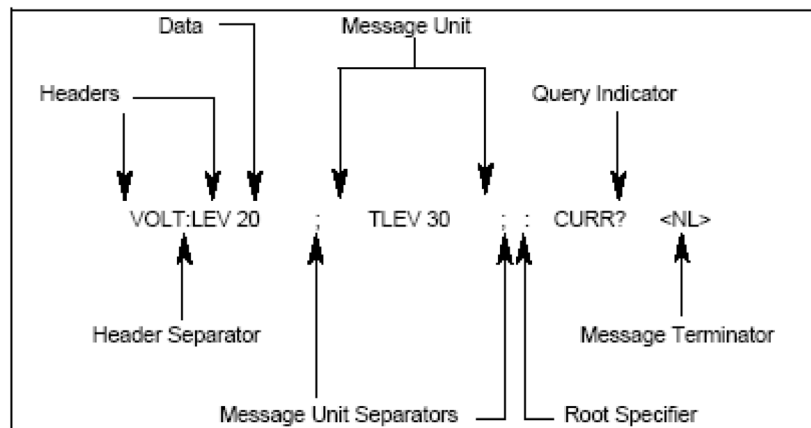

Message terminator

A terminator informs the instrument that it has reached the end of a SCPI message. The following message terminators are permitted.

Terminator	Description
<NL>	New line: <ul style="list-style-type: none">▪ Decimal 10 or hexadecimal▪ 0X0A in ASCII
<END>	End or identify
<NL><END>	New line and end or identify

NOTE

In the examples in this manual, there is an assumed message terminator at the end of each message.

Multiple commands in a message

You can group multiple SCPI command messages and send them as a single message with one message terminator. There are two important considerations when sending several commands in a single message.

- Separate each command with a semicolon (;)
- Header paths influence how the instrument interprets commands

The header path is a string that is inserted in front of every command in a message. The header path in the first command message is a null string. For each subsequent command with the same header path, the header is implied. For example:

```
CURR:LEV 3; PROT:STAT OFF
```

In the example above, the header path is `CURR`. Because the two commands are separated with a semicolon (;) and the commands are in the same header path, the header path `CURR` is not needed for the second command. The instrument automatically interprets the command following the semicolon as:

```
CURR:PROT:STAT OFF
```

If `CURR` is explicitly included in the second command in the first example above, it is semantically wrong. The instrument will interpret the second command as `CURR:CURR:PROT:STAT OFF`, and an error will occur.

Movement in the subsystem

To combine commands from different subsystems, you must reset the header path to a null string. To do this, begin the command with a colon (:). This discards any previous header path. For example, to clear the output protection and check the status of the Operation Condition Register in a single message, use a root specifier as follows:

```
PROTection:CLEAr;:STATus:OPERation:CONDition?
```

The following example message shows how to combine commands from different subsystems and within the same subsystem:

```
POWer:LEVel 200; PROTection 28; :CURRent:LEVel 3; PROTection:STATe ON
```

Note the use of the optional `LEVel` header to maintain the correct path within the voltage and current subsystems, and the use of the root specifier to move between subsystems.

Including common commands

You can combine common commands with subsystem commands in the same message. Treat the common command as a message unit by separating it with a semicolon (the message unit separator). Common commands do not affect the header path; you may insert them anywhere in the message.

Examples:

```
VOLT 5.0; :*OPC?;OUTP ON
```

SCPI data formats

All data programmed to or returned from the power supply is ASCII. The data may be numerical or it can be a character string. The following topics provide more details about SCPI data formats.

Talking and listening data formats

There are talking data formats and listening data formats. The following tables define the differences.

Talking formats

Symbol	Description
<NR1>	Digits with an implied decimal point assumed after the least-significant digit Example: 273
<NR2>	Digits with an explicit decimal point Example: .0273
<NR3>	Digits with an explicit decimal point and an exponent Example: 2.73e+2

Listening formats

Symbol	Description
<Nrf>	Extended format that includes <NR1>, <NR2>, and <NR3> formats. Example: 273 273. 2.73e2
<Nrf+>	Extended decimal format that includes <Nrf> and MIN MAX DEF Example: 273 273. 2.73e2.MAX MIN and MAX are the minimum and maximum values; within the scope of the parameter definitions, DEF is the default value
<Bool>	Boolean data Example: 0 1 or ON OFF

Suffixes and multipliers

The following table describes the SCPI command format for suffixes and multipliers.

Class	Suffix	Unit	Unit with multiplier
Voltage	V	volts	mV (millivolt)
Current	A	amperes	mA (milliampere)
Power	W	watts	mW (milliwatt)
Resistance	OHM	Ohms	MOHM (megohm)
	Ω	Ohms	MΩ (megohm)
Time	s	seconds	mS (millisecond)
Common multipliers	1e3	K	kilo
	1e-3	m	milli
	1e-6	μ	micro

Response messages

A response message is the message sent by the instrument to the computer in response to a query command.

Response data types

Character strings returned by query statements may take any of the following formats, depending on the length of the returned string.

Symbol	Description
<CRD>	Character response data; permits the return of character strings
<AARD>	Arbitrary ASCII response data; permits the return of un delimited 7-bit ASCII This data type has an implied message terminator
<SRD>	String response data; returns string parameters enclosed in double quotes

Getting a response message

After sending a query command, the response message is placed in the output queue. When the Series 2230 is then addressed to talk, the response message is sent from the output queue to the computer.

Multiple response messages

If you send more than one query command in the same program message (see [Multiple commands in a message](#) (on page 4-8)), multiple response messages are sent to the computer when the Series 2230 is addressed to talk. The responses are separated with semicolons (;) and are sent in the order that the query commands were sent. Items within the same query are separated by commas (,).

The following example shows the response message for a program message that contains four single-item query commands:

```
0; 1; 1; 0
```

Response message terminator (RMT)

Each response is terminated with an LF (line feed) and EOI (end or identify). The following example shows how a multiple response message is terminated:

```
0; 1; 1; 0; <RMT>
```

Message exchange protocol

The following items summarize the message exchange protocol:

- You must always tell the Series 2230 what to send to the computer.
The following steps must always be performed to send information from the instrument to a computer:
 1. Send the appropriate query commands in a program message.
 2. Address the Series 2230 to talk.
- The complete response message must be received by the computer before another program message can be sent to the Series 2230.

SCPI command completion

SCPI commands sent to the power supply are processed either sequentially or in parallel. Sequential commands finish execution before a subsequent command begins. Parallel commands allow other commands to begin executing while the parallel command is still executing. Commands that affect trigger actions are among the parallel commands.

The `*WAI`, `*OPC?`, and `*OPC` common commands provide different ways of indicating when all transmitted commands, including any parallel ones, have completed their operations. Some practical considerations for using these commands are:

- `*WAI`: This command prevents the power supply from processing subsequent commands until all pending operations are completed.
- `*OPC?`: This command places a 1 in the output queue when all pending operations have completed. Because it requires your program to read the returned value before executing the next program statement, the `*OPC?` command can be used to cause the controller to wait for commands to complete before proceeding with its program.
- `*OPC`: This sets the operation complete (OPC) status bit when all pending operations have completed. Since your program can read this status bit on an interrupt basis, the `*OPC` command allows subsequent commands to be executed.

NOTE

The trigger system must be in the idle state for the status OPC bit to be true; OPC is false whenever the trigger system is in the initiated state.

Using device clear

You can send a device clear command at any time to abort a SCPI command. The status registers, error queue, and all configuration states are left unchanged when a device clear message is received. Device clear performs the following actions:

- Clears the input and output buffers of the power supply.
- Prepares the power supply to accept a new command string.

Default setup

The following table lists the settings that are restored when you return the Series 2230 to default settings.

Menu item	Description
Enable Channels	Enable CH1
	Enable CH2
	Enable CH3
Max V CH1	Off
Max V CH2	Off
Max V CH3	Off
Timer CH1	Off
Timer CH2	Off
Timer CH3	Off
Track	Track Off
Combine	Combine Off
Output Recall	Off
Save Last	On
Key beep	Off
Knob Lock	Off
Communication Port	USB

The default value of `VOLTage : RANGE` depends on the actual voltage of the instrument input terminal.

SCPI command reference

In this section:

Series 2230 commands	5-1
Common commands	5-2
CALibration subsystem	5-14
INSTrument subsystem	5-20
MEASurement subsystem.....	5-26
SOURce subsystem.....	5-32
STATus subsystem.....	5-51
SYSTem subsystem	5-68

Series 2230 commands

This section contains detailed descriptions of the commands that can be used with the Series 2230 Triple-Channel Power Supplies. The commands are listed in alphabetical order under their applicable subsystems.

NOTE

You must use the `SYSTem:REMOte` command to enter remote control mode before using any programming commands.

Common commands

Common commands begin with an asterisk (*) and consist of three letters (command form) or three letters and a question mark (?) (query form). They are defined by the IEEE 488.2 standard to perform common interface functions.

The Series 2230 responds to the required common commands that control status reporting, synchronization, and internal operations. The Series 2230 also responds to optional common commands that control triggers, power-on conditions, and stored operating parameters.

If a command has a corresponding query that returns the data or status specified by the command, both command and query formats are included under the explanation for the command.

If a query does not have a corresponding command or is functionally different from the command, the query is listed separately. The description for each common command or query specifies any status registers affected.

The following table is an overview of the common commands.

Mnemonic	Name	Description
*CLS	Clear status	Clear all the event registers and error queue.
*ESE <NRf>	Event enable command	Edit the Standard Event Enable Register.
*ESE?	Event enable query	Read the Standard Event Enable Register.
*ESR?	Event status query	Read the Standard Event Status Register and clear it.
*IDN?	Identification query	Return the instrument manufacturer, model, serial number, and firmware revision level.
*OPC	Operation complete command	Set the Operation Complete bit in the Standard Event Status Register after all pending commands have been executed.
*OPC?	Operation complete query	Place an ASCII 1 into the output queue when all pending selected device operations have been completed.
*RCL <NR1>	Recall command	Return the power supply setup configuration stored in the specified memory location.
*RST	Reset command	Returned the power supply to the *RST default conditions.
*SAV <NR1>	Save command	Save the present setup to the specified memory location.
*SRE <NR1>	Service request enable command	Program the Service Request Enable Register.
*SRE?	Service request enable query	Read the Service Request Enable Register.
*STB?	Read status byte query	Read the Status Byte Register.
*TST?	Self-test query	Execute self-test and return a result.
*WAI	Wait to continue command	Wait until all previous commands are executed.

***CLS (no query form)**

This command clears the bits of the Standard Event Register, Operation Event Register, and Questionable Event Register and clears the error queue.

Group

Status

Syntax

*CLS

Arguments

None

Returns

Not applicable

Example

*CLS

Clears the event registers and error queue.

See also

[*ESR?](#) (on page 5-5)

[*STB?](#) (on page 5-12)

*ESE

This command sets or queries the bits in the Event Status Enable Register (ESER). The ESER is an eight-bit register that determines which bits in the Standard Event Status Register (SESR) will set the Event Summary Bit (ESB) in the Status Byte Register (SBR).

Group

Status

Syntax

```
*ESE <NR1>  
*ESE?
```

Arguments

<NR1> A value from 0 through 255. The binary bits of the ESER are set according to this value.

The power-on default for the ESER is 0 if the *PSC command is set to 1. If the *PSC command is set to 0, the ESER maintains its value through a power cycle.

Returns

The query form of this command returns a string that represents a binary value ESER. For example, the *ESE? command might return the string 186, indicating that the ESER contains the binary value 10111010.

Example

```
*ESE 145
```

Sets the ESER to binary 10010001, which enables the PON, EXE, and OPC bits.

See also

[*CLS](#) (on page 5-3)

[*ESR?](#) (on page 5-5)

*ESR? (query only)

This command reads the value of Standard Event Status Register (SESR). Once this command executes, the SESR is reset. The bit definition for the SESR is the same as the Standard Event Status Enable Register.

Group

Status

Syntax

*ESR?

Arguments

None

Returns

<NR1> A decimal representation of the contents of the SESR. For example, the *ESR? command might return the value 149, indicating that the SESR contains binary 10010101.

Example

*ESR?

Reads the value of the SESR.

See also

[*CLS](#) (on page 5-3)

[*OPC](#) (on page 5-7)

[*SRE](#) (on page 5-11)

*IDN? (query only)

This command reads information that identifies the power supply. It returns a parameter that contains four segments divided by a comma. Example: Keithley instruments, 2230G-60-3, 0123456789AF, 1.02-1.06.

Group

Status

Syntax

*IDN?

Arguments

None

Returns

A string with the following segments separated by commas: <manufacturer>, <model>, <serial number>, and <firmware_version>, in the format shown in the following table.

<manufacturer>	<model>	<serial number>	<firmware_version>
Keithley	2230G-XXX-XX	XXX...XX	X.XX-X.XX

For example, this command might return the following response for a Model 2230G-60-30 instrument:

Keithley instruments, 2230G-60-3, 0123456789AF, 1.02-1.06

Example

*IDN?

Reads the identifying information for the power supply.

See also

None

*OPC

This command sets the Operation Complete (OPC) bit in the Standard Event Status Register to 1 when all other commands are complete.

Group

Synchronization

Syntax

*OPC
*OPC?

Arguments

None

Returns

The *OPC? query might return 1 to indicate that all pending OPC operations are finished.

Example

```
VOLT 2.0  
*OPC?
```

Tells the instrument to return a 1 to the output queue when all pending operations are finished.

See also

[*WAI](#) (on page 5-13)

*PSC

This command specifies whether the Service Request Enable Register (SRER) and the Event State Enable Register (ESER) are cleared when the instrument is powered on. The query form of this command gets the state of the power-on status clear function.

Group

Source

Syntax

*PSC <NR1>
*PSC?

Arguments

<NR1> = 0

Sets the power-on status clear flag to false, disables the power-on clear, and allows the power supply to assert service requests (SRQ) after power on.

<NR1> = 1

Sets the power-on status clear flag to true. Sending *PSC 1 enables the power-on status clear and prevents any SRQ assertion after power-on.

Returns

0 | 1

Example

*PSC 0

Sets the power-on status clear flag to false.

*PSC?

Requests the state of the power-on status clear flag.

See also

[*OPC](#) (on page 5-7)

[*RST](#) (on page 5-9)

*RCL (no query form)

This command recalls the setups you saved in the specified memory location.

Group

Save and recall

Syntax

```
*RCL <NR1>
```

Arguments

<NR1> An integer value from 1 to 36 that specifies the location of setup memory.

Returns

Not applicable

Example

```
*RCL 3
```

Sets the power supply to settings stored in memory location 3.

See also

[*SAV](#) (on page 5-10)

***RST (no query form)**

This command resets the power supply to default settings.

Group

Status

Syntax

*RST

Arguments

None

Returns

Not applicable

Example

*RST

Resets the power supply to default settings.

See also

None

***SAV (no query form)**

This command saves the present current, voltage, and maximum voltage settings of the power supply into specified memory.

Group

Status

Syntax

*SAV <NR1>

Arguments

<NR1> An integer value from 1 to 36.

Returns

Not applicable

Example

```
*SAV 2
```

Saves the settings in memory location 2.

See also

[*RCL](#) (on page 5-9)

*SRE

This command sets or queries the bits in the Status Byte Enable Register. Setting this parameter can determine which byte of the Status Byte Register has a value of 1. The byte sets the RQS bit of the Status Byte Register to 1. The bit definition of the Status Byte Enable Register is as the same as the Status Byte Register.

Group

Status

Syntax

```
*SRE <NR1>
```

```
*SRE?
```

Arguments

<NR1> An integer value 0 to 255. The binary bits of the Status Request Enable Register (SRER) are set according to this value. Using an out-of-range value causes an execution error.

Default value

The power-on default for the SRER is 0 if the *PSC command is set to 1. If the *PSC command is set to 0, the SRER maintains its value through a power cycle.

Returns

An integer value from 0 to 255.

Example

```
*SRE 48
```

Sets the bits in the SRER to a binary value of 00110000.

```
*SRE?
```

Might return a value of 32, which means the bits in the SRER have the binary value 00100000.

See also

[*CLS](#) (on page 5-3)

[*ESR?](#) (on page 5-5)

[*PSC](#) (on page 5-7)

*STB? (query only)

This command reads the data in the Status Byte Register (SBR).

Group

Status

Syntax

*STB?

Arguments

None

Returns

<NR1> A register value.

Example

*STB?

Queries the status byte.

See also

[*CLS](#) (on page 5-3)

[*ESE](#) (on page 5-4)

[*ESR?](#) (on page 5-5)

*TST? (query only)

This command initiates a self-test and reports any errors.

Group

Diagnostic

Syntax

*TST?

Arguments

None

Returns

<NR1>

0 indicates the power supply passed the self-test.

≠0 represents an error code and indicates the power supply failed the self-test.

Example

*TST

Initiates the self-test.

See also

[Error descriptions](#) (on page 7-1)

***WAI**

This command prevents the instrument from executing further commands or queries until all pending commands are complete.

Group

Synchronization

Syntax

*WAI

Arguments

None

Returns

Not applicable

Example

*WAI

Tells the instrument to postpone execution of subsequent commands until all pending commands are complete.

See also

[*OPC](#) (on page 5-7)

CALibration subsystem

The commands in the CALibration subsystem configure and control calibration operations.

CALibrate:CLEar

This command clears the calibration information on the instrument.

Group

Calibration

Syntax

```
CALibrate:CLEar
```

Arguments

None

Default value

Not applicable

Returns

Not applicable

Example

```
CAL:CLE
```

Clears the calibration information on the instrument.

See also

None

CALibrate:CURRENT[:DATA]

This command sets the actual output current value of the calibration point.

Group

Calibration

Syntax

```
CALibrate:CURRENT[:DATA] <NR2>
```

Arguments

<NR2> Current value of the calibration point.

Default value

Not applicable

Returns

Not applicable

Example

```
CAL:CURR 3.002A
```

Sets the actual output current value of the calibration point to 3.002 A.

See also

None

CALibrate:CURRent:LEVel

This command sets the current calibration points.

Group

Calibration

Syntax

```
CALibrate:CURRent:LEVel <point>
```

Arguments

<point> = P1 | P2 Point 1 or point 2

Points P1 and P2 must be calibrated in numeric order.

Default value

Not applicable

Returns

Not applicable

Example

```
CAL:CURR:LEV P1
```

Sets the current calibration point to point 1.

See also

None

CALibrate:INITial

This command sets the current calibration coefficient as the default value.

Group

Calibration

Syntax

```
CALibrate:INITial
```

Arguments

None

Default value

Not applicable

Returns

Not applicable

Example

```
CAL:INIT
```

Sets the current calibration coefficient as the default value.

See also

None

CALibrate:SAVe

This command saves the calibration coefficient into nonvolatile memory.

Group

Calibration

Syntax

```
CALibrate:SAVe
```

Arguments

None

Default value

Not applicable

Returns

Not applicable

Example

```
CAL:SAV
```

See also

None

CALibrate:SECure[:STATe]

This command enables or disables calibration mode.

Group

Calibration

Syntax

```
CALibrate:SECure[:STATe] <bool> [,<SRD>]  
CALibrate:SECure[:STATe]?
```

Arguments

<state> = <0|1> 0 enables the calibration mode, 1 disables calibration mode.

<password> = "2230" The password is the model number of the power supply.

Default value

1

Returns

Not applicable

Example

```
CAL:SEC 0, "2230"
```

The calibration mode is enabled, and the password is 2230.

See also

None

CALibrate:STRing

This command writes or queries the calibration information of the instrument. The query version of this command returns the saved calibration information for the instrument.

Group

Calibration

Syntax

```
CALibrate:STRing <string>  
CALibrate:STRing?
```

Arguments

<string> The maximum length of the string is 22 bytes.

Default value

Not applicable

Returns

A string with a length of up to 22 bytes.

Example

```
CAL:STR "2017-03-28"
```

Sets the calibration information of the instrument to 2017-03-28.

See also

None

CALibrate:VOLTage[:DATA]

This command sets the actual output voltage value of the calibration point.

Group

Calibration

Syntax

```
CALibrate:VOLTage[:DATA] <NR2>
```

Arguments

<NR2> The voltage value of the calibration point.

Default value

Not applicable

Returns

Not applicable

Example

```
CAL:VOLT 30.002V
```

Sets the voltage value of the calibration point to 30.002 V.

See also

None

CALibrate:VOLTage:LEVel

This command sets the voltage calibration points.

Group

Calibration

Syntax

```
CALibrate:VOLTage:LEVel <point>
```

Arguments

<point> = P1|P2|P3|P4 Calibration point 1, 2, 3, or 4.

Points P1, P2, P3, and P4 must be calibrated in numeric order.

Default value

Not applicable

Returns

Not applicable

Example

```
CAL:VOLT:LEV P1
```

Sets the voltage calibration point to point 1.

See also

None

INSTrument subsystem

The commands in the INSTrument subsystem are used to configure and control the channel selection operations.

INSTrument:COMBine?

This command queries the connection state of the channels.

Group

Channel

Syntax

```
INSTrument:COMBine?
```

Arguments

None

Default value

Not applicable

Returns

```
NONE  
Track CH1CH2  
Track CH2CH3  
Track CH1CH2CH3  
Parallel CH1CH2  
Parallel CH2CH3  
Parallel CH1CH2CH3  
Series CH1CH2
```

Example

```
INST:COMB?
```

Queries the connection state of the channels.

See also

None

INSTrument:COMBine:OFF

This command turns off the connection of channels.

Group

Channel

Syntax

```
INSTrument:COMBine:OFF
```

Arguments

None

Default value

Not applicable

Returns

Not applicable

Example

```
INST:COMB:OFF
```

Turns off the connection of channels.

See also

[INSTrument:COMBine:PARAllel](#) (on page 5-21)

[INSTrument:COMBine:SERies](#) (on page 5-23)

INSTrument:COMBine:PARAllel

This command specifies that the instrument combines the present readings of channels when they are connected in parallel.

Group

Channel

Syntax

```
INSTrument:COMBine:PARAllel <level>
```

Arguments

<level> CH1CH2|CH2CH3|CH1CH2CH3 Channels to be combined in parallel.

Default value

NONE

Returns

Not applicable

Example

```
INST:COMB:PAR CH1CH2
```

Specifies that the instrument combine the present readings on channel 1 and channel 2 when they are in parallel operation mode.

See also

[INSTrument:COMBine:OFF](#) (on page 5-21)

INSTrument:COMBine:SERies

This command combines the present voltage readings on channel 1 (CH1) and channel 2 (CH2) when they are connected in series.

Group

Channel

Syntax

```
INSTrument:COMBine:SERies
```

Arguments

None

Default value

Not applicable

Returns

Not applicable

Example

```
INST:COMB:SER
```

Specifies that the instrument combine the voltage readings of channel 1 and channel 2 when connected in series.

See also

[INSTrument:COMBine:OFF](#) (on page 5-21)

INSTrument:COMBine:TRACk

This command sets channels to tracking mode.

Group

Channel

Syntax

```
INSTrument:COMBine:TRACk {CH1CH2|CH2CH3|CH1CH2CH3}
```

Arguments

CH1CH2 | CH2CH3 | CH1CH2CH3

Default value

NONE

Returns

Not applicable

Example

```
INST:COMB:TRAC CH1CH2
```

Sets channel 1 and channel 2 to tracking mode.

See also

None

INSTrument:NSElect

This command selects the channel number.

Group

Channel

Syntax

```
INSTrument:NSElect <NR1>  
INSTrument:NSElect?
```

Arguments

<NR1> = 1|2|3 The channel number.

Default value

1

Returns

1|2|3

Example

```
INST:NSEL 1
```

Selects channel number 1 (CH1).

See also

None

INSTRument[:SElect]

This command selects the channel. The query command returns the selected channel.

Group

Channel

Syntax

```
INSTRument[:SElect] {CH1|CH2|CH3}  
INSTRument[:SElect]?
```

Arguments

CH1 | CH2 | CH3 The channel.

Default value

CH1

Returns

CH1 | CH2 | CH3

Example

```
INST CH1
```

Selects channel 1.

```
INST?
```

Queries the selected channel.

See also

None

MEASurement subsystem

The commands in the MEASurement subsystem are used to make measurements.

FETCh[:SCALar]:CURRent[:DC]?

This command queries the current reading on the specified channel.

Group

Measurement

Syntax

```
FETCh[:SCALar]:CURRent[:DC]? {CH1|CH2|CH3|ALL}
```

Arguments

CH1|CH2|CH3|ALL The selected channel or channels with the current readings to return.

Default value

Not applicable

Returns

<NR2> The newly current reading with the unit of measure A.

Example

```
FETC:CURR? ALL
```

Queries the current readings on all channels.

See also

[MEASure\[:SCALar\]:CURRent\[:DC\]?](#) (on page 5-28)

FETCh[:SCALar]:POWer[:DC]?

This command queries the present power measurement on a specified channel or channels.

Group

Measurement

Syntax

```
FETCh[:SCALar]:POWer[:DC]? {CH1|CH2|CH3|ALL}
```

Arguments

CH1|CH2|CH3|ALL The channel or channels with the measurement to return.

Default value

Not applicable

Returns

<NR2> The newly measured power with the unit of measure W.

Example

```
FETC:POW? ALL
```

Returns the new power measurements on all channels.

See also

[MEASure\[:SCALar\]:POWer\[:DC\]?](#) (on page 5-29)

FETCh[:SCALar][:VOLTage][:DC]?

This command queries the new current voltage on a specified channel or channels.

Group

Measurement

Syntax

```
FETCh[:SCALar][:VOLTage][:DC]? {CH1|CH2|CH3|ALL}
```

Arguments

CH1|CH2|CH3|ALL The channel or channels with the measurement to return.

Default value

Not applicable

Returns

<NR2> The newly measured voltage with the unit of measure V.

Example

```
FETC:VOLT? ALL
```

Returns the new voltage measurements on all channels.

See also

[MEASure\[:SCALar\]\[:VOLTage\]\[:DC\]?](#) (on page 5-30)

MEASure[:SCALar]:CURRent[:DC]?

This command initiates and executes a new current measurement or queries the new measured current on a specified channel or channels.

Group

Measurement

Syntax

```
MEASure[:SCALar]:CURRent[:DC]? {CH1|CH2|CH3|ALL}
```

Arguments

CH1|CH2|CH3|ALL The channel or channels on which to make a new current measurement.

Default value

Not applicable

Returns

<NR2> The newly measured current with the unit of measure A.

Example

```
MEAS:CURR? ALL
```

Makes a new current measurement on all channels.

See also

[FETCH\[:SCALar\]:CURRent\[:DC\]?](#) (on page 5-26)

MEASure[:SCALar]:POWer[:DC]?

This command initiates and executes a new power measurement or queries the new measured power.

Group

Measurement

Syntax

```
MEASure[:SCALar]:POWer[:DC]? {CH1|CH2|CH3|ALL}
```

Arguments

CH1|CH2|CH3|ALL The channel or channels on which to make a new power measurement.

Default value

Not applicable

Returns

<NR2> The newly measured power with the unit of measure W.

Example

```
MEAS:POW? ALL
```

Makes a new power measurement on all channels.

See also

[FETCh\[:SCALar\]:POWer\[:DC\]?](#) (on page 5-27)

MEASure[:SCALar][:VOLTage][:DC]?

This command initiates and executes a new voltage measurement or queries the new measured voltage.

Group

Measurement

Syntax

```
MEASure[:SCALar][:VOLTage][:DC]? {CH1|CH2|CH3|ALL}
```

Arguments

CH1|CH2|CH3|ALL The channel or channels on which to make a new voltage measurement.

Default value

Not applicable

Returns

<NR2> The newly measured voltage with the unit of measure V.

Example

```
MEAS:VOLT? ALL
```

Makes a new voltage measurement on all channels.

See also

[FETCh\[:SCALar\]\[:VOLTage\]\[:DC\]?](#) (on page 5-27)

SOURce subsystem

The commands in the SOURce subsystem are used to control the output of the power supply.

[SOURce:]APPLY

This command sets voltage and current levels on a specified channel with a single command message.

Group

Source

Syntax

```
[SOURce:]APPLY {CH1|CH2|CH3}, <NRf+>, <NRf+>
```

Arguments

CH1|CH2|CH3 The channel to which the settings are applied.

<NRf+> The voltage value to apply; valid values are MAX|MIN|DEF|UP|DOWN.

<NRf+> The current value to apply; valid values are MAX|MIN|DEF|UP|DOWN.

Default value

CH1, 1 V, 0.1 A

Returns

Not applicable

Example

```
APPL CH1, 15.0, 1.0
```

Sets the voltage and current levels on channel 1.

See also

[INSTrument:NSElect](#) (on page 5-24)

[INSTrument\[:SElect\]](#) (on page 5-24)

[\[SOURce:\]CURRent\[:LEVel\]\[:IMMediate\]\[:AMPLitude\]](#) (on page 5-35)

[\[SOURce:\]VOLTagE\[:LEVel\]\[:IMMediate\]\[:AMPLitude\]](#) (on page 5-46)

[SOURce:]CHANnel:OUTPut[:STATe]

This command sets the output state of the presently selected channel. The query form of this command returns the output state of the presently selected channel.

Group

Source

Syntax

```
[SOURce:]CHANnel:OUTPut[:STATe] <BOOL>  
[SOURce:]CHANnel:OUTPut[:STATe]?
```

Arguments

<BOOL> ON|OFF|0|1 The output state.

Default value

OFF

Returns

0|1

Example

```
CHAN:OUTP ON
```

Set the output state of the presently selected channel to ON.

See also

None

[SOURce:]CURRent[:LEVel]:DOWN[:IMMediate][:AMPLitude]

This command decreases the current value of the present channel by one step, as specified by the [SOURce:]CURRent[:LEVel][:IMMediate]:STEP[:INCRement] command.

Group

Source

Syntax

```
[SOURce:]CURRent[:LEVel]:DOWN[:IMMediate][:AMPLitude]
```

Arguments

None

Default value

Not applicable

Returns

Not applicable

Example

```
CURR:DOWN
```

Decreases the current value of the present channel by one step.

See also

None

[SOURce:]CURRent[:LEVel][:IMMediate][:AMPLitude]

This command sets the current value of the power supply. The query form of this command gets the set current value of the power supply.

Group

Source

Syntax

```
[SOURce:]CURRent[:LEVel][:IMMediate][:AMPLitude] <NRf>  
[SOURce:]CURRent[:LEVel][:IMMediate][:AMPLitude]?
```

Arguments

<NRf> MIN TO MAX|MIN|MAX|UP|DOWN|DEF The current value.

A|MA Unit of measure (amperes).

Default value

0.1 A

Returns

The current value.

Example

```
CURR 1.0
```

Sets the current to 1 A.

See also

None

[SOURce:]CURRent[:LEVel][:IMMediate]:STEP[:INCRement]

This command sets the amount to increase current level. The query version of this command returns the set step value.

Group

Source

Syntax

```
[SOURce:]CURRent[:LEVel][:IMMediate]:STEP[:INCRement] <NRf>  
[SOURce:]CURRent[:LEVel][:IMMediate]:STEP[:INCRement]?
```

Arguments

<NRf> The amount to increase the current.

A|mA Unit of measure for the specified current value.

Default Value

0.001 A

Returns

The set step value.

Example

```
CURR:STEP 0.001A  
Increase the current by 1 mA.
```

See also

None

[SOURce:]CURRent[:LEVel]:UP[:IMMediate][:AMPLitude]

This command increases the current value of the present channel by one step, as specified by the [SOURce:]CURRent[:LEVel][:IMMediate]:STEP[:INCRement] command.

Group

Source

Syntax

```
[SOURce:]CURRent[:LEVel]:UP[:IMMediate][:AMPLitude]
```

Arguments

None

Default value

Not applicable

Returns

Not applicable

Example

```
CURR:UP
```

Increases the current value by one step.

See also

[\[SOURce:\]CURRent\[:LEVel\]\[:IMMediate\]:STEP\[:INCRement\]](#) (on page 5-36)

[SOURce:]OUTPut:ENABle

This command sets the output state of the power supply.

Group

Source

Syntax

```
[SOURce:]OUTPut:ENABle <bool>
```

Arguments

<bool> The output state of the power supply.

ON|OFF|0|1 1 means enable and 0 means disable.

Default value

1

Returns

Not applicable

Example

```
OUTP:ENAB 0
```

Disable the output of the power supply.

```
OUTP:ENAB 1
```

Enable the output of the power supply.

See also

None

[SOURce:]OUTPut:PARAllel[:STATe]

This command sets the parallel synchronization state of the three channels. The query version of this command gets the parallel synchronization state of the three channels.

Group

Source

Syntax

```
[SOURce:]OUTPut:PARAllel[:STATe] CH1CH2|CH2CH3|CH1CH2CH3  
[SOURce:]OUTPut:PARAllel[:STATe]?
```

Arguments

CH1CH2 | CH2CH3 | CH1CH2CH3 The channel that the parallel synchronization state is applied to.

Default value

NONE

Returns

CH1CH2 | CH2CH3 | CH1CH2CH3

Example

```
OUTP:PAR CH1CH2
```

Sets CH1 and CH2 to the parallel synchronization state.

See also

None

[SOURce:]OUTPut:PROTection:CLEar

This command clears the protection state of the power supply.

Group

Source

Syntax

```
[SOURce:]OUTPut:PROTection:CLEar
```

Arguments

None

Default value

Not applicable

Returns

Not applicable

Example

```
OUTP:PROT:CLE
```

Clears the set protection state of the power supply.

See also

None

[SOURce:]OUTPut:SERies[:STATe]

This command sets the series synchronization state of channel 1 (CH1) and channel 2 (CH2). If channel 3 (CH3) and CH1 or CH3 and CH2 are in parallel synchronization states, an error is generated after the command is executed. The query version of this command gets the synchronization state of CH1 and CH2.

Group

Source

Syntax

```
[SOURce:]OUTPut:SERies[:STATe] <BOOL>
[SOURce:]OUTPut:SERies[:STATe]?
```

Arguments

<BOOL> ON|OFF|0|1 The series synchronization state.

Default value

OFF

Returns

0|1

1 means enable and 0 means disable.

Example

```
OUTP:SER ON
```

Sets the series synchronization state to ON.

See also

None

[SOURce:]OUTPut[:STATe][:ALL]

This command sets the output state of all three channels. The query version of this command returns the output state of all three channels.

Group

Source

Syntax

```
[SOURce:]OUTPut[:STATe][:ALL] <BOOL>  
[SOURce:]OUTPut[:STATe][:ALL]?
```

Arguments

<BOOL> ON|OFF|0|1 The output state.

Default value

OFF

Returns

0|1

0 Turns the output state of all channels to OFF.

1 Turns the output state of all channels to ON.

Example

```
OUTP ON
```

Turns the output state of all channels to ON.

See also

None

[SOURce:]OUTPut:TIMer:DELay

This command sets the delay time for the output timer function. The query version of this command returns the delay time for the timer output function.

Group

Source

Syntax

```
[SOURce:]OUTPut:TIMer:DELay <NR2>  
[SOURce:]OUTPut:TIMer:DELay?
```

Arguments

<NR2> 0.1 to 99999.9 The delay time.

S|mS Unit of measure for the delay time.

Default value

0.1

Returns

0.1 to 99999.9

Example

```
OUTP:TIM:DEL 10
```

You can use `*RST` to reset the timer to 0.1 s.

See also

[*RST](#) (on page 5-9)

[SOURce:]OUTPut:TIMer[:STATe]

This command sets the output timer state for the presently selected channel. The query version of this command returns the output timer state for the presently selected channel.

Group

Source

Syntax

```
[SOURce:]OUTPut:TIMer[:STATe] <BOOL>
[SOURce:]OUTPut:TIMer[:STATe]?
```

Arguments

<BOOL> ON|OFF|0|1 The output timer state.

Default value

OFF

Returns

0|1

0 Turns the output timer state to OFF.

1 Turns the output timer state to ON.

Example

```
OUTP:TIM ON
```

Sets the output timer state to ON.

See also

None

[SOURce:]VOLTage[:LEVel]:DOWN[:IMMediate][:AMPLitude]

This command decreases the voltage value of the present channel by one step, as specified by the [SOURce:]VOLTage[:LEVel][:IMMediate]:STEP[:INCRement] command.

Group

Source

Syntax

```
[SOURce:]VOLTage[:LEVel]:DOWN[:IMMediate][:AMPLitude]
```

Arguments

None

Default value

Not applicable

Returns

Not applicable

Example

```
VOLT:DOWN
```

Decreases the voltage value of the present channel by one step.

See also

[\[SOURce:\]VOLTage\[:LEVel\]\[:IMMediate\]:STEP\[:INCRement\]](#) (on page 5-47)

[SOURce:]VOLTage[:LEVel][:IMMediate][:AMPLitude]

This command sets the voltage value of the power supply. The query version of this command gets the set value of the power supply.

Group

Source

Syntax

```
[SOURce:]VOLTage[:LEVel][:IMMediate][:AMPLitude] <NRf>  
[SOURce:]VOLTage [:LEVel][:IMMediate][:AMPLitude]?
```

Arguments

MIN to MAX|MIN| |MAX|UP|DOWN|DEF The voltage value.

kV|V|mV Unit of measure for the voltage value.

Default value

1 V

Returns

Voltage value

Example

```
VOLT 1.0
```

Sets the voltage value to 1 V.

See also

None

[SOURce:]VOLTage[:LEVel][:IMMediate]:STEP[:INCRement]

This command sets the value of the voltage step. The query version of this command returns the value of the voltage step.

Group

Source

Syntax

```
[SOURce:]VOLTage[:LEVel][:IMMediate]:STEP[:INCRement] <NR2>  
[SOURce:]VOLTage[:LEVel][:IMMediate]:STEP[:INCRement]?
```

Arguments

<NR2> The value of the voltage step.

kV|V|mV Unit of measure for the voltage step.

Default value

0.001

Returns

None

Example

```
VOLT:STEP 0.001
```

Sets the value of the voltage step to 1 mV.

See also

None

[SOURce:]VOLTage[:LEVel]:UP[:IMMediate][:AMPLitude]

This command increases the voltage value of the present channel by one step, as specified by the [SOURce:]VOLTage[:LEVel][:IMMediate]:STEP[:INCRement] command.

Group

Source

Syntax

```
[SOURce:]VOLTage[:LEVel]:UP[:IMMediate][:AMPLitude]
```

Arguments

None

Default value

None

Returns

Not applicable

Example

```
VOLT:UP
```

Increases the voltage value of the present channel by one step.

See also

[\[SOURce:\]VOLTage\[:LEVel\]\[:IMMediate\]:STEP\[:INCRement\]](#) (on page 5-47)

[SOURce:]VOLTage:LIMit[:LEVel]

This command sets the voltage limit for the present channel. The query version of this command returns the voltage limit for the present channel.

Group

Source

Syntax

```
[SOURce:]VOLTage:LIMit[:LEVel] <NRf>
[SOURce:]VOLTage:LIMit[:LEVel] ?
```

Arguments

<NRf> MIN|Max|DEF The voltage limit, 0 to the maximum rated voltage.

Default value

The maximum rated voltage

Returns

Not applicable

Example

```
VOLT:LIM 30.0
```

Sets the voltage limit to 30 V.

See also

None

[SOURce:]VOLTage:LIMit:STATe

This command enables or disables the voltage limit function. The query version of this command returns the state of the voltage limit function.

Group

Source

Syntax

```
[SOURce:]VOLTage:LIMit:STATe <bool>  
[SOURce:]VOLTage:LIMit:STATe?
```

Arguments

0|1|ON|OFF The state of the voltage limit function.

Default value

OFF

Returns

0|1

1 means enable and 0 means disable.

Example

```
VOLT:LIM:STATe ON
```

Enables the voltage limit function.

See also

None

STATus subsystem

The STATus subsystem controls the status registers of the power supply.

STATus:OPERation:CONDition?

This command reads the Operation Condition Register of the status model.

Group

Status

Syntax

```
STATus:OPERation:CONDition?
```

Arguments

None

Default value

0

Returns

<NR1> Range: 0 to 255

Example

```
STAT:OPER:COND?
```

Returns the contents of the Operation Condition Register.

See also

None

STATus:OPERation:ENABLE

This command sets or reads the Operation Event Enable Register of the status model.

Group

Status

Syntax

```
STATus:OPERation:ENABLE <NR1>  
STATus:OPERation:ENABLE?
```

Arguments

<NR1> Range: 0 to 255

Default value

0

Returns

<NR1> Range: 0 to 255 (query form)

Example

```
STAT:OPER:ENAB 128
```

Sets the eighth bit of the Operation Event Enable Register to 1, and all other bits to 0.

See also

[*PSC](#) (on page 5-7)

STATus:OPERation[:EVENT]?

This command reads and then clears the Operation Event Register of the status model.

Group

Status

Syntax

```
STATus:OPERation[:EVENT]?
```

Arguments

None

Default value

0

Returns

<NR1> Range: 0 to 255

Example

```
STAT:OPER?
```

Reads the Operation Event Register and then resets it.

See also

[STATus:OPERation:ENABLE](#) (on page 5-52)

STATus:OPERation:INSTrument:ENABLE

This command sets or reads the Operation Enable Register of the status model.

Group

Status

Syntax

```
STATus:OPERation:INSTrument:ENABLE <NR1>  
STATus:OPERation:INSTrument:ENABLE?
```

Arguments

<NR1> Range: 0 to 255.

Default value

0

Returns

<NR1> Range: 0 to 255 (query form)

Example

```
STAT:OPER:INST:ENAB 128
```

Sets the eighth bit of the Operation Enable Register to 1, and all other bits to 0.

See also

None

STATus:OPERation:INSTrument[:EVENT]?

This command reads and then clears the Operation Instrument Event Register of the status model.

Group

Status

Syntax

```
STATus:OPERation:INSTrument[:EVENT]?
```

Arguments

None

Default value

0

Returns

<NR1> Range: 0 to 255

Example

```
STAT:OPER:INST?
```

Queries the Operation Instrument Event Register and then resets it.

See also

None

STATus:OPERation:INSTrument:ISUMmary<X>:CONDition?

This command queries the Operation Instrument Summary Condition Register of the status model for the specified channel.

Group

Status

Syntax

```
STATus:OPERation:INSTrument:ISUMmary<X>:CONDition?
```

Arguments

<X> Channel number (1, 2, or 3)

Default value

0

Returns

<NR1> Range: 0 to 255

Example

```
STAT:OPER:INST:ISUM1:COND?
```

Queries the Operation Instrument Summary Condition Register of channel 1.

See also

None

STATus:OPERation:INSTrument:ISUMmary<X>:ENABLE

This command sets or queries the Operation Instrument Summary Enable Register of the status model for the specified channel.

Group

Status

Syntax

```
STATus:OPERation:INSTrument:ISUMmary<X>:ENABLE <NR1>  
STATus:OPERation:INSTrument:ISUMmary<X>:ENABLE?
```

Arguments

<X> Channel number (1, 2, or 3)

<NR1> Range: 0 to 255

Default value

0

Returns

<NR1> Range: 0 to 255 (query form)

Example

```
STAT:OPER:INST:ISUM3:ENAB 20
```

Sets the third bit and fifth bit of the Operation Instrument Summary Enable Register of channel 3 to 1, and all other bits to 0.

```
STAT:OPER:INST:ISUM3:ENAB?
```

Queries the Operation Instrument Summary Enable Register of channel 3.

See also

None

STATus:OPERation:INSTrument:ISUMmary<X>[:EVENT]?

This command reads the Operation Instrument Summary Event Register of the status model for the specified channel.

Group

Status

Syntax

```
STATus:OPERation:INSTrument:ISUMmary<X>[:EVENT]?
```

Arguments

<X> Channel number (1, 2, or 3)

Default value

0

Returns

<NR1> Range: 0 to 255

Example

```
STAT:OPER:INST:ISUM2?
```

Queries the Operation Instrument Summary Event Register of channel 2.

See also

None

STATus:PRESet

This command resets all bits in the status model.

Group

Status

Syntax

```
STATus:PRESet
```

Arguments

None

Default value

Not applicable

Returns

Not applicable

Example

```
STAT:PRESet
```

Resets all the bits in the status model.

See also

None

STATus:QUEStionable:CONDition?

This command queries the Questionable Condition Register of the status model. If the value of the bit in the questionable condition register changes, it will cause the corresponding bit in the Questionable Event Register to be 1.

Group

Status

Syntax

```
STATus:QUEStionable:CONDition?
```

Arguments

None

Default value

0

Returns

<NR1> The content of the Questionable Condition Register.

Example

```
STAT:QUES:COND?
```

Queries the Questionable Condition Register.

See also

None

STATus:QUEStionable:ENABLE

This command sets or queries the Questionable Event Enable Register (QENR) of the status model. The QENR is an eight-bit mask register that determines which bits in the Questionable Event Register should affect the state of the QUES bit in the status byte register.

Group

Status

Syntax

```
STATus:QUEStionable:ENABle <NR1>  
STATus:QUEStionable:ENABle?
```

Arguments

<NR1> Range: 0 to 255

Default value

0

Returns

<NR1> Range: 0 to 255 (query form)

Example

```
STAT:QUES:ENAB 128
```

Sets the eighth bit of the Questionable Event Enable Register to 1, and all other bits to 0.

See also

[*PSC](#) (on page 5-7)

STATus:QUEStionable[:EVENT]?

This command queries and resets the Questionable Event Register of the status model.

Group

Status

Syntax

```
STATus:QUEStionable[:EVENT]?
```

Arguments

None

Default value

0

Returns

<NR1> The contents of the Questionable Event Register.

Example

```
STAT:QUES?
```

Queries and resets the Questionable Event Register.

See also

[STATus:QUEStionable:ENABLE](#) (on page 5-61)

STATus:QUEStionable:INSTrument:ENABle

This command sets or queries the Questionable Instrument Enable Register of the status model.

Group

Status

Syntax

```
STATus:QUEStionable:INSTrument:ENABle  
STATus:QUEStionable:INSTrument:ENABle?
```

Arguments

0 to 65535

Default value

0

Returns

<NR1> Range: 0 to 255 (query form)

Example

```
STAT:QUES:INST:ENAB 20
```

Sets the third bit and fifth bit of the query enable register to 1, and all other bits to 0.

See also

None

STATus:QUESTIONable:INSTRument[:EVENT]?

This command reads and clears the Questionable Instrument Event Register of the status model.

Group

Status

Syntax

```
STATus:QUESTIONable:INSTRument[:EVENT]?
```

Arguments

None

Default value

Not applicable

Returns

Not applicable

Example

```
STAT:QUES:INST?
```

Reads and clears the Questionable Instrument Event Register.

See also

None

STATus:QUEStionable:INSTrument:ISUMmary<X>:CONDition?

This command reads the Questionable Instrument Summary Condition Register of the status model for the specified channel.

Group

Status

Syntax

```
STATus:QUEStionable:INSTrument:ISUMmary<X>:CONDition?
```

Arguments

<X> Channel number (1, 2, or 3)

Default value

0

Returns

<NR1> Range: 0 to 255

Example

```
STAT:QUES:INST:ISUM2:COND?
```

Queries the Questionable Instrument Summary Condition Register of channel 2.

See also

None

STATus:QUESTionable:INSTrument:ISUMmary<X>:ENABle

This command sets or reads the contents of the Questionable Instrument Summary Event Enable Register of the status model for the specified channel.

Group

Status

Syntax

```
STATus:QUESTionable:INSTrument:ISUMmary<X>:ENABle <NR1>  
STATus:QUESTionable:INSTrument:ISUMmary<X>:ENABle?
```

Arguments

<X> Channel number (1, 2, or 3)

<NR1> Range 0 to 65535

Default value

0

Returns

<NR1> Range: 0 to 65535 (query form)

Example

```
STAT:QUES:INST:ISUM2:ENAB 12
```

Sets the third bit and fourth bit of the Questionable Instrument Summary Enable Register of channel 2 to 1, and sets all other bits to 0.

See also

None

STATus:QUEStionable:INSTrument:ISUMmary<X>[:EVENT]?

This command queries the Operation Instrument Summary Event Register of the status model for the specified channel.

Group

Status

Syntax

```
STATus:QUEStionable:INSTrument:ISUMmary<X>[:EVENT]?
```

Arguments

<X> Channel number (1, 2, or 3)

Default value

0

Returns

<NR1> Range: 0 to 65535

Example

```
STAT:QUES:INST:ISUM1?
```

Queries the Questionable Instrument Summary Event Register of channel 1.

See also

None

SYSTEM subsystem

This subsystem contains commands that affect the overall operation of the instrument, such as autozero, beeper, communications, event logs, and time.

SYSTEM:BEEPer

This command tests the beeper function of the power supply. If it passes the test, a beep is issued.

Group

System

Syntax

SYSTEM:BEEPer

Arguments

None

Default value

Not applicable

Returns

Not applicable

Example

```
SYST:BEEP
```

Tests the beeper function of the power supply.

See also

None

SYSTem:ERRor?

This command takes the instrument out of remote operation and restores the operation of front-panel controls.

Group

System

Syntax

```
SYSTem:ERRor?
```

Arguments

None

Default value

0, "No Error"

Returns

Both the error code and the error information.

Example

```
SYST:ERR?
```

Reads the error code and error information.

See also

None

SYSTem:LOCa1

This command is to switch the power supply into control from the front panel.

Group

System

Syntax

```
SYSTem:LOCa1
```

Arguments

None

Default value

Not applicable

Returns

Not applicable

Example

```
SYST:LOC
```

Switches the power supply to front-panel control.

See also

None

SYSTem:REMOte

This command takes the instrument out of front-panel control mode and switches it to remote control mode.

Group

System

Syntax

```
SYSTem:REMOte
```

Arguments

None

Default value

Not applicable

Returns

Not applicable

Example

```
SYST:REM
```

Switches the power supply into remote control mode.

See also

None

SYSTem:RWLock[:STATe]

This command locks the power supply in remote control mode. When this command is executed, pressing the **LOCAL** button does not switch the instrument to local control mode.

Group

System

Syntax

```
SYSTem:RWLock[:STATe]
```

Arguments

None

Default value

Not applicable

Returns

Not applicable

Example

```
SYST:RWL
```

Locks the **LOCAL** button and switches the power supply into remote control mode.

See also

None

SYSTem:VERSion?

This command queries the SCPI version of the instrument.

Group

System

Syntax

```
SYSTem:VERSion?
```

Arguments

None

Default value

1991.1

Returns

<string> The SCPI version of the power supply.

Example

```
SYST:VERS?
```

Queries the SCPI version of the instrument.

See also

None

Status register

In this section:

[Status register overview.....6-1](#)

Status register overview

You can use status register programming to determine the operating condition of the power supply at any time. For example, you can program the power supply to generate an interrupt when an event such as overtemperature protection occurs.

The following table describes the status signals.

Status signals

Bit	Signal	Description
Operation Instrument Summary Register		
0	CV	Constant voltage
1	CC	Constant current
2	CAL	The power supply is calculating the new calibration parameter
3	ON/OFF	The output of the power supply is ON or OFF
Operation Instrument Status Register		
1	INST1	STATus:OPERation:INSTrument:ISUMmary1 is reported to INST1
2	INST2	STATus:OPERation:INSTrument:ISUMmary2 is reported to INST2
3	INST3	STATus:OPERation:INSTrument:ISUMmary3 is reported to INST3
Operation Status Register		
1	ISUM	Summary of STAT:OPER:INST
Questionable Instrument Summary Register		
0	CV	Constant voltage
1	CC	Constant current
Questionable Instrument Status Register		
1	INST1	STATus:QUEStionable:INSTrument:ISUMmary1 is reported to INST1
2	INST2	STATus:QUEStionable:INSTrument:ISUMmary2 is reported to INST2
3	INST3	STATus:QUEStionable:INSTrument:ISUMmary3 is reported to INST3

Status signals continued

Bit	Signal	Description
Questionable Status Register		
4	OTP	Overtemperature protection
13	ISUM	Summary of STAT:QUES:INST
Standard Event Register		
0	OPC	Operation complete
2	QYE	Query error, data for output array is missing
3	DDE	Device-dependent error; data stored in the register is missing or the error occurs in preliminary test
4	EXE	Execution error; the command parameter overflows or the condition is not right
5	CME	Command error; syntax or semantic error occurs when receiving information
7	PON	Power on; the value is 1 when the power supply is reset
Status Byte Register		
2	EAV	Error buffer is available
3	QUES	If the Questionable Status Register changes, QUES is 1
4	MAV	Output buffer is available
5	ESB	If the Standard Event Enable Register changes, ESB is 1
6	RQS	Request service; during a serial poll, RQS is returned and cleared
7	OPER	If the Operation Status Register changes, OPER is 1

The following figure shows the status register structure of the Series 2230 power supply.

Figure 18: Status register structure

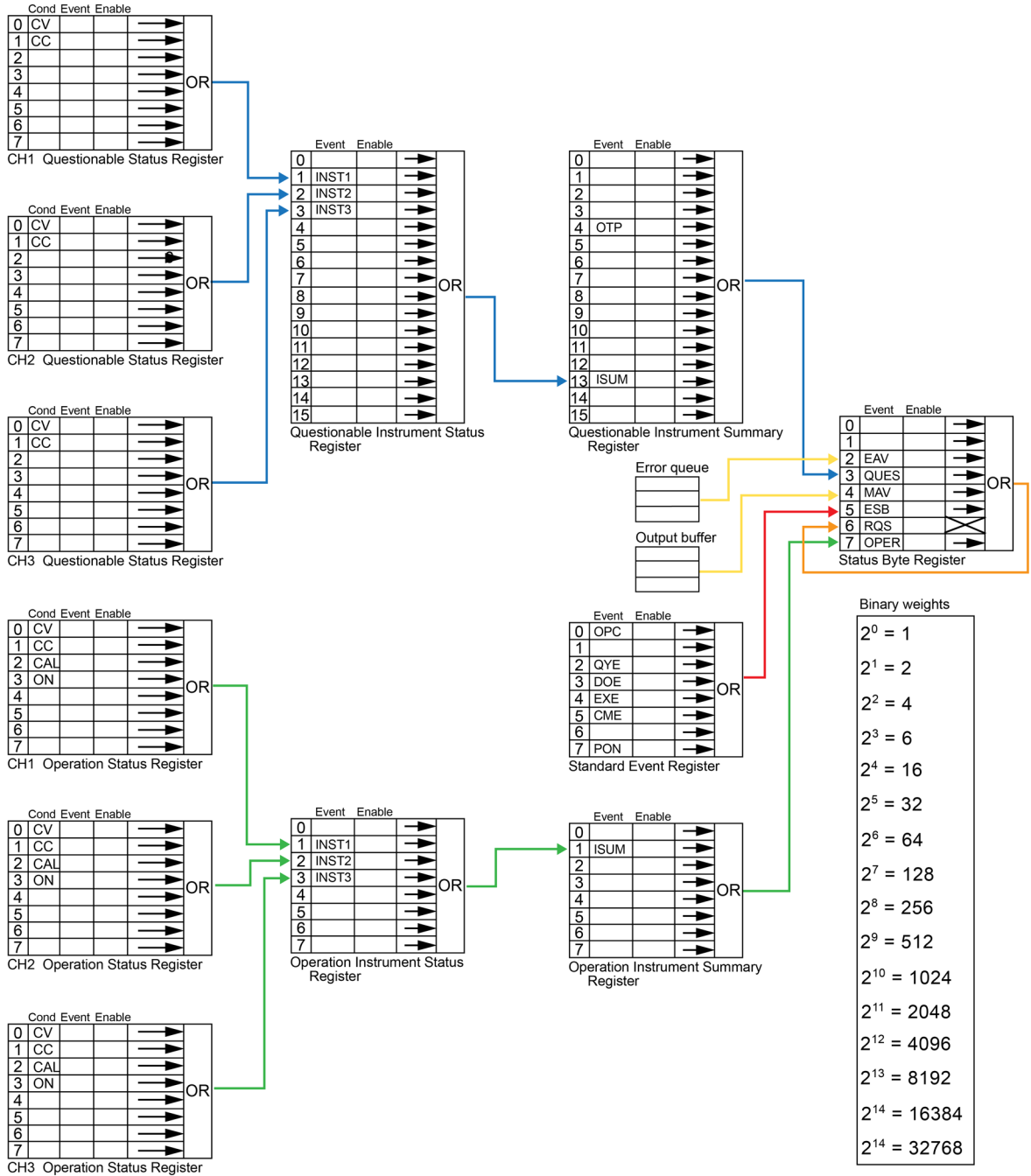

Error descriptions

In this section:

Error information7-1

Error information

The following table lists error codes that are returned and their definitions.

Code	Definition
0	No error
1	Module initialization lost
2	Initialization lost
3	Module calibration lost
4	EEPROM failure
101	Too many numeric suffixes
110	No input command
114	Invalid numeric suffix
116	Invalid value
117	Invalid dimensions
120	Parameter overflowed
130	Wrong units for parameter
140	Wrong type of parameter
150	Wrong number of parameter
160	Unmatched quotation mark (single/double) in parameters
165	Unmatched bracket
170	Command keywords were not recognized
180	No entry in list to retrieve (number list or channel list)
190	Too many dimensions
191	Too many characters
223	Front-panel buffer overrun
224	Front-panel timeout
225	Front Crc check error
401	CAL switch prevents calibration

Code	Definition
402	CAL password is incorrect
403	CAL not enabled
404	Readback CAL is incorrect
405	Programming CAL is incorrect
-200	Execution error
-221	Settings conflict
-222	Data out of range
-223	Too much data (out of memory; block, string, or expression too long)
-224	Illegal parameter value (device-specific)
-225	Out of memory
-230	Data corrupt or stale
-310	System error (generic)
-350	Too many errors
-400	Query error
-410	Query interrupted
-420	Query unterminated
-430	Query deadlocked

Specifications are subject to change without notice.
All Keithley trademarks and trade names are the property of Keithley Instruments.
All other trademarks and trade names are the property of their respective companies.

Keithley Instruments

Corporate Headquarters • 28775 Aurora Road • Cleveland, Ohio 44139 • 440-248-0400 • 1-800-833-9200 • tek.com/keithley

