

Series 2230 Triple-Channel DC Power Supply Quick Start Guide

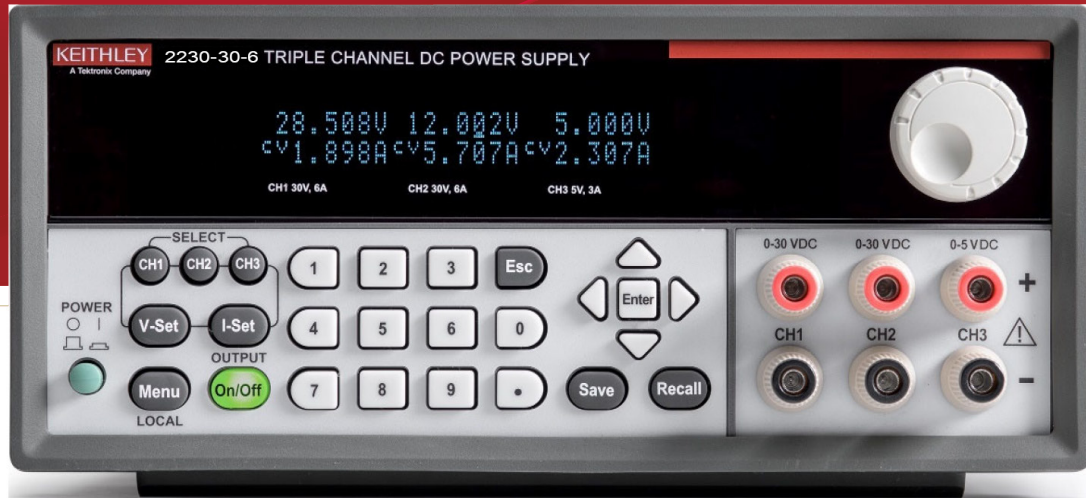

Safety precautions

The following safety precautions should be observed before using this product and any associated instrumentation. Although some instruments and accessories would normally be used with nonhazardous voltages, there are situations where hazardous conditions may be present.

This product is intended for use by personnel who recognize shock hazards and are familiar with the safety precautions required to avoid possible injury. Read and follow all installation, operation, and maintenance information carefully before using the product. Refer to the user documentation for complete product specifications.

If the product is used in a manner not specified, the protection provided by the product warranty may be impaired.

The types of product users are:

Responsible body is the individual or group responsible for the use and maintenance of equipment, for ensuring that the equipment is operated within its specifications and operating limits, and for ensuring that operators are adequately trained.

Operators use the product for its intended function. They must be trained in electrical safety procedures and proper use of the instrument. They must be protected from electric shock and contact with hazardous live circuits.

Maintenance personnel perform routine procedures on the product to keep it operating properly, for example, setting the line voltage or replacing consumable materials. Maintenance procedures are described in the user documentation. The procedures explicitly state if the operator may perform them. Otherwise, they should be performed only by service personnel.

Service personnel are trained to work on live circuits, perform safe installations, and repair products. Only properly trained service personnel may perform installation and service procedures.

Keithley products are designed for use with electrical signals that are measurement, control, and data I/O connections, with low transient overvoltages, and must not be directly connected to mains voltage or to voltage sources with high transient overvoltages. Measurement Category II (as referenced in IEC 60664) connections require protection for high transient

overvoltages often associated with local AC mains connections. Certain Keithley measuring instruments may be connected to mains. These instruments will be marked as category II or higher.

Unless explicitly allowed in the specifications, operating manual, and instrument labels, do not connect any instrument to mains.

Exercise extreme caution when a shock hazard is present. Lethal voltage may be present on cable connector jacks or test fixtures. The American National Standards Institute (ANSI) states that a shock hazard exists when voltage levels greater than 30 V RMS, 42.4 V peak, or 60 VDC are present. A good safety practice is to expect that hazardous voltage is present in any unknown circuit before measuring.

Operators of this product must be protected from electric shock at all times. The responsible body must ensure that operators are prevented access and/or insulated from every connection point. In some cases, connections must be exposed to potential human contact. Product operators in these circumstances must be trained to protect themselves from the risk of electric shock. If the circuit is capable of operating at or above 1000 V, no conductive part of the circuit may be exposed.

Do not connect switching cards directly to unlimited power circuits. They are intended to be used with impedance-limited sources. NEVER connect switching cards directly to AC mains. When connecting sources to switching cards, install protective devices to limit fault current and voltage to the card.

Before operating an instrument, ensure that the line cord is connected to a properly-grounded power receptacle. Inspect the connecting cables, test leads, and jumpers for possible wear, cracks, or breaks before each use.

When installing equipment where access to the main power cord is restricted, such as rack mounting, a separate main input power disconnect device must be provided in close proximity to the equipment and within easy reach of the operator.

For maximum safety, do not touch the product, test cables, or any other instruments while power is applied to the circuit under test. ALWAYS remove power from the entire test system and discharge any capacitors before: connecting or disconnecting cables or jumpers, installing or removing switching cards, or making internal changes, such as installing or removing jumpers.

Do not touch any object that could provide a current path to the common side of the circuit under test or power line (earth) ground. Always make measurements with dry hands while standing on a dry, insulated surface capable of withstanding the voltage being measured.

For safety, instruments and accessories must be used in accordance with the operating instructions. If the instruments or accessories are used in a manner not specified in the operating instructions, the protection provided by the equipment may be impaired.

Do not exceed the maximum signal levels of the instruments and accessories. Maximum signal levels are defined in the specifications and operating information and shown on the instrument panels, test fixture panels, and switching cards.

When fuses are used in a product, replace with the same type and rating for continued protection against fire hazard.

Chassis connections must only be used as shield connections for measuring circuits, NOT as protective earth (safety ground) connections.

If you are using a test fixture, keep the lid closed while power is applied to the device under test. Safe operation requires the use of a lid interlock.

If a  screw is present, connect it to protective earth (safety ground) using the wire recommended in the user documentation.

The  symbol on an instrument means caution, risk of hazard. The user must refer to the operating instructions located in the user documentation in all cases where the symbol is marked on the instrument.

The  symbol on an instrument means warning, risk of electric shock. Use standard safety precautions to avoid personal contact with these voltages.

The  symbol on an instrument shows that the surface may be hot. Avoid personal contact to prevent burns.

The  symbol indicates a connection terminal to the equipment frame.

If this  symbol is on a product, it indicates that mercury is present in the display lamp. Please note that the lamp must be properly disposed of according to federal, state, and local laws.

The **WARNING** heading in the user documentation explains hazards that might result in personal injury or death. Always read the associated information very carefully before performing the indicated procedure.

The **CAUTION** heading in the user documentation explains hazards that could damage the instrument. Such damage may invalidate the warranty.

The **CAUTION** heading with the  symbol in the user documentation explains hazards that could result in moderate or minor injury or damage the instrument. Always read the associated information very carefully before performing the indicated procedure. Damage to the instrument may invalidate the warranty.

Instrumentation and accessories shall not be connected to humans.

Before performing any maintenance, disconnect the line cord and all test cables.

To maintain protection from electric shock and fire, replacement components in mains circuits — including the power transformer, test leads, and input jacks — must be purchased from Keithley. Standard fuses with applicable national safety approvals may be used if the rating and type are the same. The detachable mains power cord provided with the instrument may only be replaced with a similarly rated power cord. Other components that are not safety-related may be purchased from other suppliers as long as they are equivalent to the original component (note that selected parts should be purchased only through Keithley to maintain accuracy and functionality of the product). If you are unsure about the applicability of a replacement component, call a Keithley office for information.

Unless otherwise noted in product-specific literature, Keithley instruments are designed to operate indoors only, in the following environment: Altitude at or below 2,000 m (6,562 ft); temperature 0 °C to 50 °C (32 °F to 122 °F); and pollution degree 1 or 2.

To clean an instrument, use a cloth dampened with deionized water or mild, water-based cleaner. Clean the exterior of the instrument only. Do not apply cleaner directly to the instrument or allow liquids to enter or spill on the instrument. Products that consist of a circuit board with no case or chassis (e.g., a data acquisition board for installation into a computer) should never require cleaning if handled according to instructions. If the board becomes contaminated and operation is affected, the board should be returned to the factory for proper cleaning/servicing. Safety precaution revision as of June 2017.

Power and environmental ratings

For indoor use only.

Power supply	2230-30-3 AC power input level: 110 V setting: 99 V AC to 132 V AC; 220 V setting: 198 V AC to 264 V AC; 50 Hz or 60 Hz 2230-30-6 and 2230-60-3 AC power input level: 120 V AC: 108 V AC to 132 V AC 220 V to 240 V: 198 V AC to 264 V AC; 50 Hz or 60 Hz Maximum power consumption: 2230-30-3: 700 VA; 2230-30-6, 2230-60-3: 1000 VA Maximum current: 10 A
Operating altitude	Maximum 2000 m (6562 ft) above sea level

Operating temperature	0 °C to 40 °C, full accuracy with maximum 80% relative humidity at up to 40 °C, noncondensing
Storage temperature	- 20 °C to 70 °C, 10% to 85% relative hu- midity at up to 40 °C and 5% to 60% relative humidity above 40 °C up to 70 °C
Pollution degree	2
Installation category	II

CAUTION

Carefully consider and configure the appropriate output-off state, source levels, and compliance levels before connecting the instrument to a device that can deliver energy. Failure to consider the output-off state, source levels, and compliance levels may result in damage to the instrument or to the device under test.

Introduction

The Models 2230-30-3, 2230-30-6, and 2230-60-3 Triple-Channel Programmable DC Power Supplies provide you with high resolution, high accuracy, and high stability. They provide resolution up to 1 mV and 1 mA to meet the needs of a variety of applications. They support over-temperature protection. They also provide a series mode and a parallel mode to extend the voltage or current output capacity. The output voltage or current of each channel can be set from 0 to the maximum value. You can set and display the voltage and current of three channels at one time without switching, greatly simplifying the operation of a three-channel power supply.

The Series 2230 models are listed in the following table.

Model number	Description
2230-30-3	Triple-Channel Programmable DC Power Supply, 2 channels: 30 V, 3 A; 1 channel: 5 V, 3 A, 195 W
2230-30-6	Triple-Channel Programmable DC Power Supply, 2 channels: 30 V, 6 A; 1 channel: 5 V, 3 A, 375 W
2230-60-3	Triple-Channel Programmable DC Power Supply, 2 channels: 60 V, 3 A; 1 channel: 5 V, 3 A, 375 W

Unpack and inspect the instrument

To unpack and inspect the instrument:

1. Inspect the box for damage.
2. Open the top of the box.
3. Remove the bag that contains the documentation and standard accessories.
4. Remove the packaging filling.
5. Remove the Triple-Channel DC Power Supply from the box.
6. Inspect the instrument for any obvious signs of physical damage. Report any damage to the shipping agent immediately.

You should have received your 2230-30-3, 2230-30-6, or 2230-60-3 power supply with the following accessories:

- Calibration certificate, part number 001165500
- USB cable, part number 174684100
- Power cord appropriate for your location
- 2230G Harmonic Reduction Module (HRM), part number 016214000 (only for 2230-30-6 and 2230-60-3)
- 2230 to 2230G HRM line cord (30 cm), part number 161042300 (only for 2230-30-6 and 2230-60-3)

Refer to the packing list for additional items that might be shipped with your instrument.

Front-panel overview

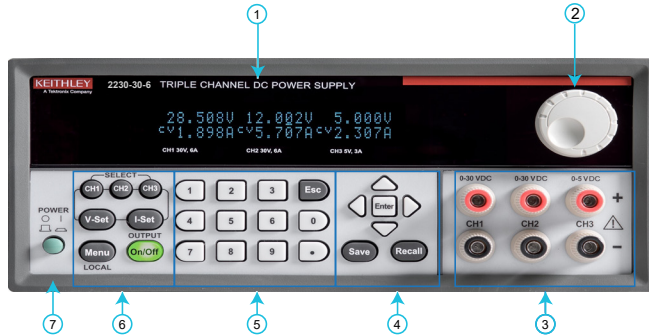







Number	Description
1	Vacuum fluorescent display (VFD)
2	Navigation wheel: Turn the navigation wheel to increase or decrease a value or to scroll through the menus after pressing the Menu key. When you have selected the menu item or value you want, press the Enter key to save your setting
3	Output terminals
4	Up, down, left, and right arrow keys, Enter, Save, and Recall function keys
5	Numeric keypad and Esc key
6	Function keys: SELECT (CH1, CH2, CH3), V-Set (voltage setting), I-Set (current setting), Menu, and OUTPUT On/Off
7	Power on or off switch









Keyboard overview

The keyboard of the Series 2230 power supply is shown in the following figure.



Key descriptions:

-  Select channel 1.
-  Select channel 2.
-  Select channel 3.
-  Set the voltage limit for the selected channel.
-  Set the current limit for the selected channel.
-  Open the menu to access Series 2230 settings.

-  Turn the output of all enabled channels on or off. When you turn on the output, the CC or CV indicators are visible on the display. When you turn off the output, the SV indicators are visible on the display. SV indicates that the display is showing each channel's programmed settings.
-  through  numeric keys. Enter numbers to set values.
-  Return to the previous menu level.
-  Use left and right arrow keys to move the cursor.
-  Use up and down arrow keys to adjust the parameters or select an item in the menu.
-  Save the present settings as a saved setup. The Series 2230 supports up to 36 saved setups.
-  Return the instrument to a specified setup.
-  Select a menu item or confirm an operation.

Rear-panel overview

All 2230 power supply models have the same rear panel. The rear panel is shown in the figure below. Descriptions of the numbered items follow the figure.

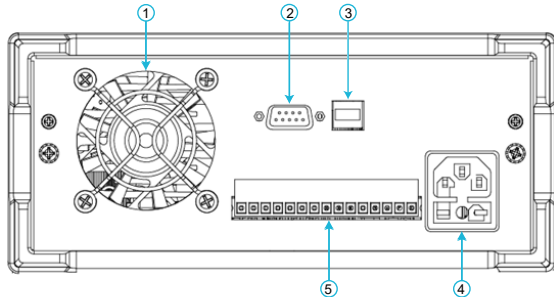

Number	Description
1	Vent and fan
2	RS-232 communication interface connector
3	USB communication interface connector
4	AC power input socket (including fuse)
5	Remote sense and output terminals

Front-panel user interface overview

The front-panel user interface gives you quick access to measurement settings, system configuration, instrument status, and other functions.

Home-screen overview

The Series 2230 runs a self-test automatically when it is turned on. If the self-test finishes with no errors, the home screen is displayed.

0.000V	0.000V	0.000V
SV0.000A	SV0.000A	SV0.000A

The first line on the home screen displays the voltage settings of all three channels.

The second line on the home screen displays the current settings of all three channels. The SV indicator indicates that the display is showing programmed settings.

Menu screen overview

When you press the  key on the front panel, the system menu screen is displayed.

The following options are displayed:

- Default Set
- Enable Channels
- Protection Settings
- Track
- Combine
- User Settings
- System Info

Select an item by pressing the  key.

Connect the instrument

Important test system safety information

This product is sold as a stand-alone instrument that may become part of a system that could contain hazardous voltages and energy sources. It is the responsibility of the test system designer, integrator, installer, maintenance personnel, and service personnel to make sure the system is safe during use and is operating properly.

You must also realize that in many test systems a single fault, such as a software error, may output hazardous signal levels even when the system indicates that there is no hazard present.

It is important that you consider the following factors in your system design and use:

- The international safety standard IEC 61010-1 defines voltages as hazardous if they exceed $30 V_{RMS}$ and $42.4 V_{PEAK}$ or 60 V dc for equipment rated for dry locations. Keithley Instruments products are only rated for dry locations.
- Read and comply with the specifications of all instruments in the system. The overall allowed signal levels may be constrained by the lowest rated instrument in the system. For example, if you are using a 500 V power supply with a 300 V dc rated switch, the maximum allowed voltage in the system is 300 V dc.
- Cover the device under test (DUT) to protect the operator from flying debris in the event of a system or DUT failure.
- Make sure any test fixture connected to the system protects the operator from contact with hazardous voltages, hot surfaces, and sharp objects. Use shields, barriers, insulation, and safety interlocks to accomplish this.
- Double-insulate all electrical connections that an operator can touch. Double insulation ensures the operator is still protected even if one insulation layer fails. Refer to IEC 61010-1 for specific requirements.
- Make sure all connections are behind a locked cabinet door or other barrier. This protects the system operator from accidentally removing a connection by hand and exposing hazardous voltages. Use high-reliability fail-safe interlock switches to disconnect power sources when a test fixture cover is opened.
- Where possible, use automatic handlers so that operators are not required to access the DUT or other potentially hazardous areas.
- Provide training to all users of the system so that they understand all potential hazards and know how to protect themselves from injury.
- In many systems, during power up, the outputs may be in an unknown state until they are properly initialized. Make sure the design can tolerate this situation without causing operator injury or hardware damage.

NOTE

To keep users safe, always read and follow all safety warnings provided with each of the instruments in your system.

Install the instrument

You can use the 2230 on a bench or in a rack. See the instructions that came with your rack-mount kit if you are installing the Triple-Channel DC Power Supply in a rack.

To prevent damaging heat build-up and ensure specified performance, make sure there is adequate ventilation and airflow around the instrument to ensure proper cooling. Do not cover the ventilation holes on the top, sides, or bottom of the instrument.

Position the instrument so that it is easy to reach any disconnecting devices, such as the power cord and the power switch.

Connect line power

Series 2230 power supplies operate at 110 V to 120 V or 220 V to 240 V with a frequency of 50 Hz or 60 Hz. Make sure that the ac line-voltage indicator on the bottom of the instrument matches the ac line voltage in your facility.

WARNING

The power cord supplied with the 2230 contains a separate protective earth (safety ground) wire for use with grounded outlets. When proper connections are made, the instrument chassis is connected to power-line ground through the ground wire in the power cord. In the event of a failure, not using a properly grounded protective earth and grounded outlet may result in personal injury or death due to electric shock.

! WARNING

Do not replace detachable mains supply cords with inadequately rated cords. Failure to use properly rated cords may result in personal injury or death due to electric shock.

NOTE

When using the model 2230-30-6 or 2230-60-3 in a country that is a member of the European Union, you need to use the 2230G-HRM Harmon Reduction Module in line with the mains power cord to comply with European Union Regulations. The 2230G-HRM does not affect the functions of the instrument.

To power on the 2230-30-3:

1. Make sure the front-panel power switch is in the off (O) position.
2. Properly set the 110 V/220 V selector switch on the bottom of the instrument.
3. Connect the socket of the supplied power cord to the power module on the rear panel.

CAUTION

Operating the instrument on an incorrect line voltage may cause damage to the instrument, possibly voiding the warranty.

4. Connect the plug of the power cord to a grounded ac outlet.

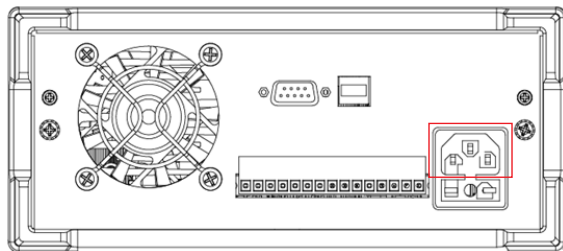

5. Disconnect any devices under test (DUTs) from the instrument before turning the instrument on.
6. Turn on the instrument by pressing the **POWER** switch on the front panel to the on (I) position.

To power on the 2230-30-6 or 2230-60-3 instrument in the European Union:

When using the Model 2230-30-6 or 2230-60-3 in a country that is a member of the European Union, you need to use the 2230G-HRM in line with the mains power cord to comply with European Union regulations, as shown in the following diagram.

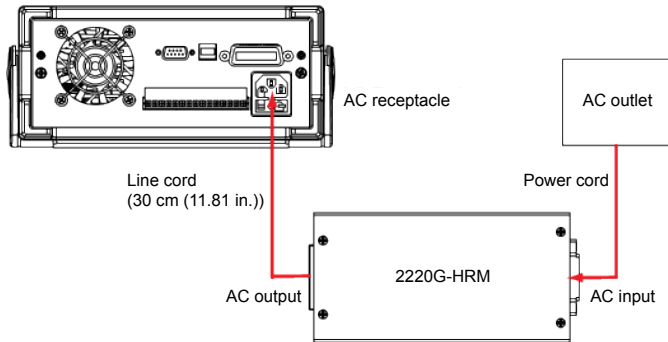

1. Make sure the front-panel power switch is in the (0) position.
2. Properly set the 110 V/220 V selector switch on the bottom of the instrument.
3. Connect the female end of the supplied line cord to the ac receptacle on the rear panel.
4. Connect the plug of the supplied line cord to the ac output of the 2230G-HRM inductor.
5. Connect the female end of the supplied power cord to the ac input of the 2230G-HRM inductor.
6. Connect the plug of the power cord to a grounded ac outlet.
7. Disconnect any devices under test (DUTs) from the instrument before turning the instrument on.
8. Turn on the instrument by pressing the **POWER** switch on the front panel to the on (I) position.

Connections for testing

Before making the connections, prepare the wires as described in the following table.

Connection	Specification
Front-panel output terminals	AWG 22 to AWG 14
Sense terminals	AWG 22 to AWG 14

CAUTION

The wire must be heavy enough that it does not overheat while carrying the short-circuit current. You must meet the wiring requirements described above.

Local sense connection

The local sense connection is used for basic operations when maximum precision is not required. Keep the wire as short as possible to reduce wire resistance. If you want higher measurement precision, use a remote sense connection.

To connect the DUT to the power supply using local sense:

1. Connect the positive (+) terminals to the sense positive (S+) terminals, and connect the negative (-) terminals to the sense negative (S-) terminals to create a short circuit using short clips or electric wire, as shown in the following figure.

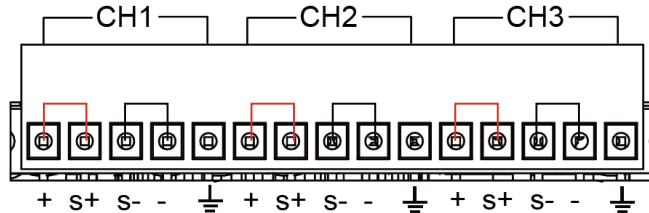

2. Connect the positive and negative terminals of the intended channel on the front panel to the DUT, as shown in the figure.

CAUTION

Leave remote sense wires connected, even when remote sense is not used. Disconnecting the remote sense wires will cause erratic behavior and may damage the power supply.

Remote sense connection

You can use the remote sense connection for better measurement precision.

To connect the DUT to the power supply using remote sense:

1. Disconnect the wires or short clips from + to S+, and - to S-.
2. Connect the S+ to the positive (+) terminal of the DUT, and connect the S- to the negative (-) terminal of the DUT, as shown in the following wiring diagram.

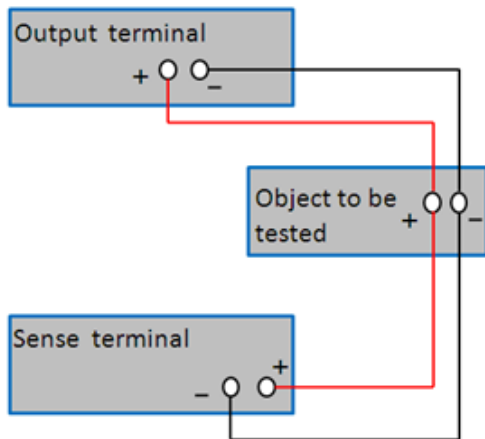

CAUTION

To ensure the stability of the system, use shielded twisted pair cable between the remote sense terminals and the instrument under test.

To avoid damage to the Series 2230 instrument, ensure that the polarity of the connections is correct.

Basic settings

Set the voltage output or voltage limit for a specific channel

You can set the voltage limit from 0 V to the specified maximum voltage.

To set the voltage limit:

1. Select the channel by pressing the **CH1**, **CH2**, or **CH3** key.
2. Press the **V-Set** key.
3. Use the numeric keys, the navigation wheel, and the up, down, right, and left arrow keys to set the voltage limit.
4. Press the **Enter** key to confirm the setting.

Set the current output or current limit for a specific channel

You can set the current limit from 0 A to the specified maximum current.

To set the current limit:

1. Select the channel by pressing the **CH1**, **CH2**, or **CH3** key.
2. Press the **I-Set** key.

3. Use the numeric keys, the navigation wheel and the up, down, right, and left arrow keys to set the current limit.
4. Press the **Enter** to confirm the setting.

Save the setups

You can store up to 36 different setups in memory. Each setup includes a voltage limit, current limit, and maximum output voltage for each channel.

To save the setups:

1. After you set up the power supply, press the **Save** key.
2. Use the numeric keys, the navigation wheel, or the arrow keys to select the setup memory (1 to 36) in which you want to store the values.
3. Press **Enter** to confirm your setting.

Recall the setups

To recall the setups:

1. Press the **Recall** key.
2. Use the numeric keys or the arrow keys to select the setup that you want to recall.
3. Press the **Enter** key.

Channel settings

Enable channels

You can enable or disable each channel using the menu. If a channel is disabled, it remains off when the output is turned on.

To enable or disable a channel:

1. Press the **Menu** key.
2. Press the down arrow key to select **Enable Channels**.
3. Press the **Enter** key to confirm the setting.
4. Press the down arrow key to select **Channel** and press the **Enter** key.
5. Press the down arrow key to select **Disable CH1** or **Enable CH1 (default)**.
6. Press **Enter**.

Track

You can set channel 1 (CH1) and channel 2 (CH2), channel 2, and channel 3 (CH3), and all three channels combined to tracking mode. When CH1 and CH2 tracking is on, channel 1 and channel 2 respond relative to one another when adjustments in voltage are made. A constant ratio is maintained between the voltage settings on the two channels.

For example, if channel 1 and channel 2 are both set to 1 V when tracking is turned on, a one-to-one ratio is maintained and any voltage change on channel 1 results in a corresponding change on channel 2. If channel 1 is set to 10 V and channel 2 is set to 5 V when tracking is turned on, a two-to-one ratio is maintained and any voltage change on channel 1 results in a voltage change of half the size on channel 2.

Example of setting up CH1/CH2 tracking mode:

1. Press the **CH1** key.
2. Press the **V-Set** key and enter the voltage value for channel 1. For example, set the voltage of channel 1 to 3 V.
3. Press the **Enter** key.
4. Press the **CH2** key.
5. Press the **V-Set** key and enter the voltage that sets the ratio you want maintain for channel 2. For example, set the voltage of channel 2 to 6 V. The ratio is 2.
6. Press the **Enter** key.
7. Press the **Menu** key.
8. Use the down arrow key to go to **Track**, and then press the **Enter** key.
9. Press the down arrow key to select **Track CH1/CH2** and then press the **Enter** key to turn on tracking.
10. Verify that Γ is displayed between the voltage readings of channel 1 and channel 2 on the display. This indicates that the power supply is in tracking mode.

To disable the tracking function:

1. Press the **Menu** key.
2. Use the arrow keys to select **Track**.
3. Press the **Enter** key.
4. Use the arrow keys to select **Track Off (default)**.
5. Press the **Enter** key.

NOTE

If the voltage or current is set to 0, voltage or current tracking is ignored.

If tracking is enabled and CH1 and CH2 timers are both set, the timer uses the smaller set value.

NOTE

The wiring between the power supplies drives the accuracy of measurements in series operation. Ensure that wire sizes are sufficient, wires are short, and connections are tightened to maximize accuracy.

Combine

You can combine the outputs of the channels in series or in parallel. Series operation mode is only available for CH1 and CH2 of the 2230-30-3 and 2230-30-6. Parallel operation mode is available for CH1 and CH2, CH2 and CH3, or all three channels.

Example: Combine V1 and V2 in series

To combine channel 1 and channel 2 when the outputs are wired in series:

1. Connect the outputs in series, as shown in the figure.
2. Press the **Menu** key.
3. Use the arrow keys to select **Combine**.
4. Press the **Enter** key.
5. Press the down arrow key to select **V1+V2 Series**.
6. Press the **Enter** key. The screen returns to meter mode. Verify that the Series indicator is displayed, replacing the channel 2 voltage and current readings. This indicates that the power supply is in the V1+V2 series state. The total output voltage is displayed on Channel 1.
7. Set the channel 1 voltage to the value you want.

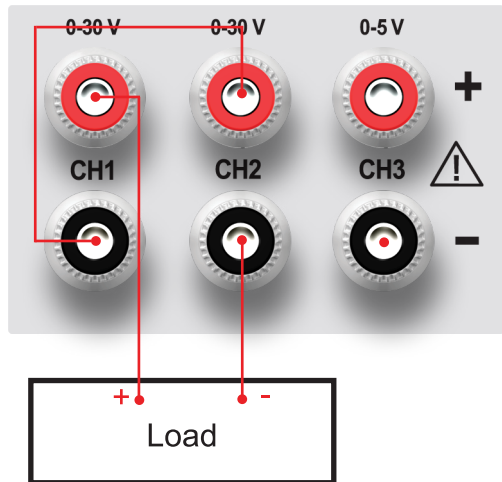

Example: Combine I1+I2 in parallel

To combine channel 1 and channel 2 when the outputs are wired in parallel:

1. Connect the outputs in parallel as shown.

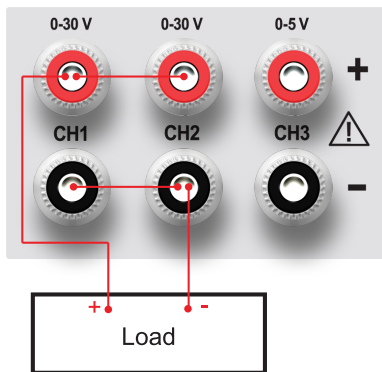

2. Press the **Menu** key.
3. Use the arrow keys to select **Combine**.
4. Press the **Enter** key.
5. Press the down arrow key to select **I1+I2 Parallel**.
6. Press the **Enter** key. The screen returns to meter mode. Verify that the Para indicator is displayed, replacing the channel 2 voltage and current readings. This indicates that the power supply is in the I1+I2 parallel state. The total output current is displayed on channel 1.
7. Set channel 1 to the current value you want.

Turn off combine

To turn off the combine function:

1. Remove all connections to the output terminals.
2. Press the **Menu** key.
3. Use the arrow keys to select **Combine**.
4. Press the **Enter** key.
5. Press the down arrow key to select **Combine Off (default)**.
6. Press the **Enter** key.

FAQs

What should I do if the supply will not power on?

- Make sure that the power cord is fully inserted into the ac power input socket.
- Ensure that the power supply is connected to a line voltage circuit that is on.
- Make sure the ac line voltage indicator on the bottom of the instrument is set for the ac line voltage in your facility.
- Check the fuse on the rear-panel ac power input socket to determine if it is damaged.

What should I do if the power supply does not read the voltage or voltages I have set?

- Make sure that the rear-panel mating connector with the shorting jumpers is inserted into the rear panel when using the front-panel connectors and using local sensing.
- Ensure that the current limit is not set too low for the load resistance so the channel is not in the constant current mode.

Can I still use the front-panel terminals if I want to use remote sensing?

Yes, you can use the front-panel terminals to supply power to the DUT. Remove the shorting jumpers on the rear-panel mating connector and connect the sense terminals to the same location on the DUT that the front-panel terminals are connected to.

Next steps

For more information, refer to the *Series 2230 User's Manual*. It provides detailed information about all features of the instrument.

You can also visit the Keithley Instruments website, [tek.com/keithley](https://www.tek.com/keithley), for support and additional information about the instrument.

Contact information: 1-800-833-9200

For additional contacts, see [tek.com/contact](https://www.tek.com/contact)

Find more valuable resources at [TEK.COM](https://www.tek.com).
Copyright © 2022, Tektronix. All rights reserved.
Tektronix products are covered by U.S. and foreign patents, issued and pending. Information in this publication supersedes that in all previously published material. Specification and price change privileges reserved. TEKTRONIX and TEK are registered trademarks of Tektronix, Inc. All other trade names referenced are the service marks, trademarks, or registered trademarks of their respective companies.

KEITHLEY
A Tektronix Company



2230-903-01 Rev. B April 2022

