

...setting the standard again and again®

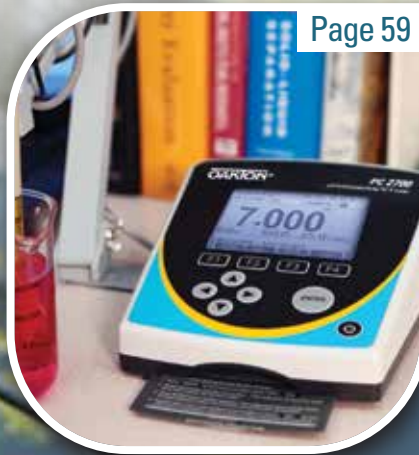

Page 59



Page 9

2014/15 Catalog



Page 53

- pH/Ion
- Conductivity/TDS
- Dissolved Oxygen
- Multiparameter
- Turbidity
- Colorimetry

OAKTON®

2014/15 Catalog

Table of Contents

pH/Ion

Testers

Selection guide.....	2
EcoTestr™ pH 2.....	3
pHTestrs® 10, 20, 30.....	5
pH Spear.....	6
pHTestr® 10 BNC.....	7
ORPTestr® 10 and 10 BNC.....	8
Multiparameter 35-Series Testrs™.....	9

Handheld Meters

Selection guide.....	10
pH 5+ and 6+.....	11
Ion 6+.....	12
New pH 150.....	13
New pH 450.....	14
pH 600 and 610.....	15
pH 620.....	16

Benchtop Meters

Selection guide.....	17
pH 700.....	18
Ion 700.....	19
pH 2700.....	20
Ion 2700.....	21

Electrodes and Accessories

Solutions and accessories.....	22
Selection guide.....	23
Laboratory and field.....	24–27
Ion-selective.....	28–29

Conductivity

Testers

Selection guide.....	30
EcoTestr™ TDS, EC, and Salt.....	31
TDSTestr® 11 and 11+.....	32
ECTestr® 11 and 11+.....	33
SaltTestr™ 11.....	34

Handheld Meters

Selection guide.....	35
CON 6+.....	36
TDS 6+ and SALT 6+.....	37
New CON 150.....	38
New CON 450.....	39
CON 600 and 610.....	40

Benchtop Meters

CON 700.....	41
CON 2700.....	42
Probes and solutions.....	43

Dissolved Oxygen

Handheld Meters

Selection guide.....	44
DO 6+.....	45
New RDO 450.....	46
DO 600.....	47

Benchtop Meters

DO 700.....	48
DO 2700.....	49
Probes, solutions, and accessories.....	50

Multiparameter

Handheld Meters

Selection guide.....	51
New pH/CON 450.....	52
New pH/RDO 450.....	53
PC 650.....	54
PD 650.....	55
CD 650.....	56
PCD 650.....	57

Benchtop Meters

PC 700.....	58
PC 2700.....	59

Optical

Introduction/Reagents and accessories.....	60
Turbidimeter.....	61
Colorimeters.....	62

Calibration

.....	63
-------	----

Index

.....	64–65
-------	-------

Visit us online at

www.4oakton.com

*for product pricing, technical data,
and customer assistance:*

- **Access** detailed information on new Oakton products as soon as they become available
- **Download** operating manuals and product specifications for every Oakton instrument
- **Search** our technical library for application tips based on our most frequently asked questions
- **Navigate** quickly to the information you need with our enhanced Search function
- **Find e-mail links** to the Oakton team for fast technical assistance
- **MSDS sheets** for Oakton solutions

OAKTON® INSTRUMENTS

pH | Ion | Conductivity | Dissolved Oxygen

Value.

Features you want at
an affordable price

Quality.

Accurate, reliable
results in a durable,
easy-to-use design

Selection.

Choose from meters that
take you from the lab to the
field, including handheld
and benchtop models.

We've got the **right meter**
for your **application!**

www.4oakton.com



See page 3



See page 39



See page 18

pH Measurement

What is pH Measurement?

The most commonly measured chemical parameter in aqueous solutions, pH is a measure of a liquid's acidity and alkalinity. It is a critical parameter in water and wastewater treatment in municipal and industrial applications, chemical production, agriculture research, and production. It is also critical in environmental monitoring, chemical and life sciences research, biochemical and pharmaceutical research, electronics production, and many more applications.

Meter Selection

Oakton offers a large selection of pH measurement instruments and kits. From pocket-sized pHTesters®, to rugged handheld portable meters, to laboratory benchtop meters, Oakton has an instrument for practically any pH application.

Electrodes

Proper pH electrode selection is important to maximize electrode life and ensure the best possible accuracy for your application. Oakton offers a complete selection guide with applications and specifications for pH range, temperature, and diameter for each electrode (see pages 23–29).

Calibration Buffers

All pH measurement requires calibration solutions to ensure that the readings are traceable to a standard. Oakton calibration buffers do this—and more—since they are standardized against NIST-traceable references. Always choose a pH 7 buffer plus at least one other pH value close to your expected measurement range. Storage and cleaning solutions should also be used to ensure fast, reliable results from your electrodes.

Expert Advice to Ensure the Best Results

Feel free to contact your Oakton distributor to help you choose your Oakton pH measurement products. Oakton distributors are dedicated to helping you purchase the Oakton instrument that will give you the best results.



Waterproof Testers™ Selection Guide

Use this chart to find the best Testr for your application

Meter	EcoTestr™ pH 2	pHTesters® 10, 20, 30	pHTestr® 10 BNC	pH Spear	ORPTestr® 10 and 10 BNC	Multiparameter 35-Series Testers™
See page	3	5	7	6	8	9
Parameters	pH	pH and temperature	pH	pH	ORP	pH, conductivity, TDS, salt
Electrode	Permanently fixed, single junction	Replaceable double-junction module	Not included—use any electrode with BNC connector	Replaceable double-junction spear tip probe	Choose from replaceable module or BNC model	Combined replaceable pH and conductivity module
Resolution	0.1	Up to 0.01	Up to 0.01	Up to 0.01	1 mV	Up to 0.01 pH
Accuracy	±0.1	Up to ±0.01	Up to ±0.01	Up to ±0.01	±2 mV	Up to ±0.01 pH
Display	One-line LCD	Two-line LCD	Two-line LCD	Two-line LCD	Two-line LCD	Two-line LCD
Calibration	3 points; US buffers	3 points; US or NIST buffers	3 points; US or NIST buffers	3 points; US or NIST buffers	±150 mV offset	Up to 5 points pH; up to 3 points EC/TDS

EcoTestr™ pH 2

Just dip and read

Simple single-line display – Large upright display is easy to read

±0.1% pH full-scale accuracy – Suitable for many applications

Transparent protective cap – Doubles up as a container for sensor conditioning or on-site calibration

Waterproof, dustproof housing – Meets IP67 rating, plus it floats!

Long-lasting sensor with PVDF reference junction – Large volume of polymer gel reference gives long, clog-free, sensor lifespan

Click-lock battery compartment – Simply lift and remove cover to replace batteries; no additional tools required

Push-button calibration – Calibrate more precisely than trimpot adjustment; no screwdrivers necessary

Automatic temperature compensation (ATC) – Gives you accurate readings even with fluctuating temperatures

Hold function – Freezes reading until you can record it

Auto shutoff – Extends the life of the batteries



35423-10
EcoTestr pH 2



Transparent protective cap keeps sensor moist when stored upright.



Convenient pocket/belt clip

Specifications

ISO9001:2008
CERTIFIED SUPPLIER

1 year
warranty
meter only

Model	EcoTestr pH 2
Range	0.0 to 14.0 pH
Resolution	0.1 pH
Accuracy	±0.1 pH
Calibration	Three-point, automatic (4.0, 7.0, or 10.0)

Temperature compensation: automatic (ATC), from 0 to 50°C (32 to 122°F)
Operating temperature: 0 to 50°C (32 to 122°F)
Power: four 1.5 V alkaline batteries (included), 250 hrs continuous use: Eveready® A76 or LR44 equivalent replacement

Dimensions
Unit only: 1¼" x 1½" x 6½" (3.2 x 3.8 x 16.8 cm)
Boxed: 1½" x 5¼" x 9¾" (3.8 x 13.6 x 24.8 cm)
Weight
Unit only: 3.25 oz (90 g); **Boxed:** 6 oz (170 g)

Ordering Information

Catalog number	Description	Included
WD-35423-10	EcoTestr pH 2	Tester, integral sensor, and batteries

Accessories

WD-35624-70 Calibration kit includes calibration buffer pouches (two each of pH 4.01, 7.00, 10.00, and rinse water), sample jar, and hard carrying case. (Tester not included)

WD-09377-16 Replacement batteries, 1.5 V. Pack of 6

This is what makes our pocket meters better

Main Features

- User-replaceable sensor
- Valox® durable plastic casing
- IP67 waterproof
- Easy to use
- Quick, stable, and accurate results
- 1-year meter warranty;
6-month electrode warranty



Battery Compartment

- Waterproof by silicone O-ring
- Uses common button cells
- Encloses calibration buttons (for EC/TDS models)



Customized LCD

- Large and easy to read
- Clear display with unit of measurement
- Self-diagnostic messages
- Temperature readout (select models)



Waterproof to IP67 Rating

- Rugged, waterproof, and so light, it floats!
- Unique antiroll ribbed design ensures firm grip



User-Replaceable Sensor Module

- Use tester body over and over again
- Easy plug-in/plug-out connection
- Electrode modules for pH, EC/TDS, ORP, and pH/EC/TDS



pH/ORP Sensor Module

- Glass bulb of special material; tough with fast response
- PVDF reference junction minimizes contamination
- Double-junction design prolongs sensor life
- Valox® plastic for improved chemical and physical durability



EC/TDS Sensor Module

- Two-pin stainless steel
- Minimal bubble entrapment
- Easy to clean



EC/TDS+ Series Sensor Module

- Cup-type design for scooping samples
- Requires minimal sample volume



pH/EC/TDS Sensor Module

- Combines pH and conductivity
- For Multiparameter 35-Series Testers™



Top Battery Cover

- Easy to remove (no wires attached)
- Eyelet for lanyard attachment

Strong Plastic Housing

- Chemical resistant
- Physical durability

ASIC Microprocessor

- Precise and accurate calibrations
- Fast and reliable readings
- Sophisticated features

Push-Button Operation

- Simple, quick, and accurate
- Hassle-free calibration procedures

Double Silicone O-Ring

- Waterproof by silicone O-ring
- Allows easy replacement of electrode module

Protective Cap

- Reduces contamination
- Protects sensor

pHTestrs® 10, 20, and 30

Easier measurements with more information from a larger display

Unique double-junction electrode design

— Longer electrode life, especially in harsh applications like wastewater, plating baths, life science, and food

Waterproof, dustproof housing — IP67 rated, maintains the integrity of your tester even in dirty or damp field conditions. Plus, it floats!

Replaceable electrode module — Reuse the same meter body for cost savings

Push-button calibration with auto-buffer recognition

Automatic temperature compensation (ATC)

— Accurate readings even with fluctuating temperatures

Hold function — Freezes reading so that you can record it

Self-diagnostic error messages — Make troubleshooting easier

Auto shutoff — Extends the life of the batteries

pHTestr 10 features — Three-point calibration, ±0.1 pH accuracy

pHTestr 20 features — Three-point calibration, ±0.01 pH accuracy

pHTestr 30 features — Three-point calibration, ±0.01 pH accuracy, and simultaneous temperature display



35634-30
Waterproof
double-junction
pHTestr 30

ISO9001:2008
CERTIFIED SUPPLIER



1 year
warranty
meter only

Specifications

Model	pHTestr 10	pHTestr 20	pHTestr 30
Range	-1.0 to 15.0 pH	-1.00 to 15.00 pH	-1.00 to 15.00 pH
Resolution	0.1 pH	0.01 pH	0.01 pH
Accuracy	±0.1 pH	±0.01 pH	±0.01 pH
Temperature display	—	—	0 to 50°C (32 to 122°F)
Calibration	Three point at either pH 4.0, 6.86/7.0, or 9.18/10.0		

Temperature compensation: automatic (ATC), from 0 to 50°C (32 to 122°F)

Operating temperature: 0 to 50°C (32 to 122°F)

Special functions: On/Off or Auto-Off after 8.5 minutes; Hold; Calibrate and Confirm

Power: four 1.5 V alkaline batteries (included), >500 hours continuous use; Eveready® A76 or LR44 equivalent replacement

Dimensions

Unit only: 6½" x 1½" dia (16.5 x 3.8 cm)

Boxed: 7¼" x 2½" x 2" (18.4 x 6.4 x 5.0 cm)

Weight

Unit only: 3.25 oz (90 g); **Boxed:** 4.5 oz (125 g)

Ordering Information

Catalog number	Description	Included
WD-35634-10	pHTestr 10	Tester, detachable electrode sensor, and batteries
WD-35634-20	pHTestr 20	Tester, detachable electrode sensor, and batteries
WD-35634-30	pHTestr 30	Tester, electrode, detachable electrode sensor, calibration buffer pouches, and batteries

Accessories

WD-35624-38 Replacement electrode sensor for pHTestr 10, 20, and 30

WD-35634-70 pHTestr 10 calibration kit includes Testr, calibration buffer pouches (two each of pH 4.01, 7.00, 10.00 and rinse water), sample jar, and sturdy carrying case

WD-35634-80 pHTestr 20 calibration kit includes Testr, calibration buffer pouches (two each of pH 4.01, 7.00, 10.00 and rinse water), sample jar, and sturdy carrying case

WD-35634-90 pHTestr 30 calibration kit includes Testr, calibration buffer pouches (two each of pH 4.01, 7.00, 10.00 and rinse water), sample jar, and sturdy carrying case



All Oakton® waterproof pHTestrs float!



Large LCD

pH Spear

Narrow spear tip for versatile applications

Rugged spear tip electrode – Easily penetrates soft solids and semisolids

Slender housing and electrode fit into test tubes and microtubes – Less expensive than a micro pH electrode

Unique open-pore double junction electrode design – Resists clogging and contamination

±0.01 pH accuracy with push-button three-point calibration – Calibrate at 4.01, 7.00, and 10.00. Tester automatically provides offset and two slope adjustments

Waterproof, dustproof housing – IP67 rated, so there's no need to worry if you drop your tester into water—it even floats!

Replaceable electrode module – Reuse the same meter body

Error messages, Hold function, Auto-off



35634-40
Waterproof
pH Spear

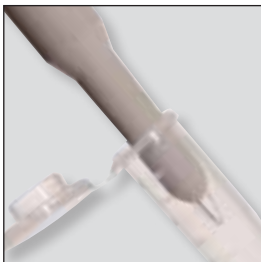

Fits into microtubes and test tubes.



Spear tip for easy penetration

Specifications

ISO9001:2008
CERTIFIED SUPPLIER

CE 1 year
warranty
meter only

Model	pH Spear
Range	-1.00 to 15.00 pH
Resolution	0.01 pH
Accuracy	±0.01 pH at normal room temperature; ±0.05 pH at extremes in temperature range
Calibration	Select up to three points (USA: 4.01; 7.00; 10.00 or NIST: 4.01; 6.86; 9.18)

Temperature compensation: fixed at 25°C or manual

Operating temperature: 0 to 50°C (32 to 122°F)

Special functions: On/Off or Auto-Off after 8.5 minutes; Hold; Calibrate and Confirm

Power: four 1.5 V alkaline batteries (included), approximately 500 hours use; Eveready® A76 or LR44 equivalent replacement

Dimensions

Unit only: 6½" x 1½" dia (16.5 x 3.8 cm)

Boxed: 7¼" x 2¼" x 1⅞" (18.4 x 7 x 4.8 cm)

Weight

Unit only: 3.25 oz (90 g); **Boxed:** 6 oz (170 g)

Ordering Information

Catalog number	Description	Included
WD-35634-40	pH Spear	Tester, spear tip electrode, and batteries

Accessories

WD-35634-50 Replacement electrode for pH Spear

WD-35624-70 Calibration kit includes calibration buffer pouches (two each of pH 4.01, 7.00, 10.00, and rinse water), sample jar, and hard carrying case. (Tester not included)

WD-09377-16 Replacement batteries, 1.5 V. Pack of 6

...setting the standard
again and again®

Testers — pH/Ion

pH/Ion

pHTestr® 10 BNC

Waterproof, dustproof tester connects to any pH electrode with BNC connector

- Connects to any electrode with BNC connector** – Use tester in virtually any application, even highly specialized ones
- ±0.01 pH accuracy** – Performs like an advanced handheld meter with pocket-sized convenience
- Microprocessor-based functions** – Provides fast, stable readings
- Push-button calibration with auto-buffer recognition; three-point calibration** – pH 4.01, 7.00, and 10.00
- Waterproof, dustproof housing** – IP67-rated housing, maintains the integrity of your tester even in harsh field conditions. Plus, it floats, so you won't lose your tester by dropping it into a tank or pond.
- Hold function** – Freezes reading so that you can record it
- Self-diagnostic error messages** – Make troubleshooting easier
- Auto shutoff** – Extends the life of the batteries



Use with direct connect or cabled electrodes.



35634-14
pHTestr 10 BNC

BNC connection lets you connect a wide variety of electrodes.

ISO9001:2008
CERTIFIED SUPPLIER

CE 1 year warranty meter only

Specifications

Model	pHTestr 10 BNC
Range	-1.00 to 15.00 pH
Resolution	0.01 pH
Accuracy	±0.01 pH (meter only, or when calibration and tests are at room temperature [16 to 27°C])
Calibration	Select up to three points (USA: 4.01; 7.00; 10.00 or NIST: 4.01; 6.86; 9.18)

Temperature compensation: fixed at 25°C or manual

Operating temperature: 0 to 50°C (32 to 122°F)

Special functions: On/Off or Auto-Off after 8.5 minutes; Hold; Calibrate and Confirm

Power: four 1.5 V alkaline batteries (included), approximately 250 hours continuous use; Eveready® A76 or LR44 equivalent replacement

Dimensions

Unit: 5 7/8" L x 1 1/2" W x 3/4" H (15 x 4 x 2.5 cm)

Boxed: 7 3/4" L x 2 3/4" W x 1 7/8" H (18.4 x 7 x 4.8 cm)

Weight

Unit: 3.25 oz (90 g); **Boxed:** 6 oz (170 g)

Ordering Information

Catalog number	Description	Included
WD-35634-14	pHTestr 10 BNC	Tester and batteries (Order BNC electrode separately below)

WD-35624-70 Calibration kit includes calibration buffer pouches (two each of pH 4.01, 7.00, 10.00, and rinse water), sample jar, and hard carrying case. (Tester not included)

WD-09377-16 Replacement batteries, 1.5 V. Pack of 6

pH Electrodes

These cable-free electrodes plug directly into tester for easy one-handed operation. Use single-junction electrodes for clean water applications. Use double-junction electrodes for solutions with organics, sulfides, heavy metals, Tris buffers, or high pH. All electrodes feature sealed, epoxy-body construction and BNC connector.

Catalog number	Description	pH range	Junction	Applications
WD-35804-00	12 mm dia	0 to 12	Single	Clean water, low ionic strength solutions.
WD-35804-10	Flat surface; 12 mm dia	0 to 12	Single	For surface testing such as gels, food, skin, floors, concrete. For small-liquid volumes.
WD-35804-08	12 mm dia	0 to 14	Double	Dirty water, high-strength solutions, has low-sodium error above pH 12.
WD-35804-02	12 mm dia	0 to 12	Double	Dirty water, high-strength solutions, life sciences, Tris buffers.
WD-35804-03	9 mm dia	0 to 12	Double	Small diameter fits test tubes. Dirty water, high-strength solutions.



IP67-rated waterproof, dustproof housing floats. Shown with electrode.

ORPTestr® 10 and ORPTestr 10 BNC

Waterproof, dustproof tester for convenient testing of oxidation-reduction (REDOX) potential

Double-junction electrode design –

Significantly longer electrode life, especially in applications with harsh chemicals (ORPTestr 10 only)

Wide mV range – Measures from –999 to +1000 mV for an array of common applications

Offset of ±150 mV – Keypad adjustment to calibration solution or to an established work standard

Microprocessor-based functions – Provides fast, stable readings

Replaceable electrode module – Reuse the same tester body over and over

Waterproof, dustproof housing – IP67-rated housing protects your tester even in harsh field or plant conditions. And it floats, so you won't lose your tester by dropping it into a tank or pond!

Hold function – Freezes reading so that you can record it

Self-diagnostic error messages – Make troubleshooting easier

Auto shutoff – Extends the life of the batteries



IP67-rated waterproof, dustproof housing floats!



35650-14



35650-10

Double-junction electrode allows for long electrode life, even in harsh applications.

BNC connection lets you connect a wide variety of electrodes.



Electrode sensors are easily replaceable without affecting waterproof rating.

Specifications

ISO9001:2008
CERTIFIED SUPPLIER



1 year
warranty
meter only

Model	ORPTestr 10
Range	–999 to +1000 mV
Resolution	1 mV
Accuracy	±2 mV
Calibration	Offset adjustment ±150 mV; brings ORPTestr into agreement with your work standard

Operating temperature: 0 to 50°C (32 to 122°F)

Special functions: On/Off or Auto-Off after 8.5 minutes; Hold; Calibrate and Confirm

Power: four 1.5 V alkaline batteries (included). Eveready® A76 or LR44 equivalent replacement

Dimensions

Meter: 6½"L x 1½" dia (16.5 x 3.8 cm)

Boxed: 7¼"L x 2¼"W x 1⅞"H (18.4 x 7 x 4.8 cm)

Weight

Meter: 3.25 oz (90 g); **Boxed:** 6 oz (170 g)

Ordering Information

Catalog number	Description	Included
WD-35650-10	ORPTestr 10	Tester, replaceable double-junction electrode sensor, and batteries
WD-35650-14	ORPTestr 10 BNC	Tester with BNC connection and batteries (electrode not included)

Accessories

WD-35650-09 Replacement electrode sensor for ORPTestr 10

WD-35805-13 ORP electrode; single junction, epoxy-body, gel-filled electrode with 3-ft (1-m) cable. For use with ORPTestr 10 BNC

WD-09377-16 Replacement batteries, 1.5 V. Pack of 6

...setting the standard again and again®

Testers — pH/Ion

pH/Ion

Multiparameter 35-Series Testrs™

Our most versatile testers combine up to five measurements in one pocket-sized meter

Determine pH, conductivity, TDS, salinity, and temperature – Great for water, wastewater, laboratory, or plant use

Accuracy up to ±0.01 for pH; ±1% full-scale for EC/TDS/salt – Ideal for a wide variety of applications

Long-lasting pH sensor with PVDF reference junction – Large volume of polymer gel reference gives long, clog-free sensor lifespan

Stainless steel pin-style conductivity sensors – Durable and compatible with a wide range of samples

Adjustable TDS factor, temperature coefficient, and salinity factor – Provide accurate readings under changing conditions

Push-button calibration – Calibrate more precisely than trimpot adjustment; no screwdrivers necessary

Automatic temperature compensation (ATC) – Gives you accurate readings even with fluctuating temperatures

Waterproof, dustproof housing – Meets IP67 rating, plus it floats!

Hold function – Freezes reading until you can record it

Auto shutoff – Extends the life of batteries



Sensor includes both pH and conductivity/TDS/salt probes.

Ordering Information

Catalog number	Description
WD-35425-00	PCTestr 35 (pH/conductivity)
WD-35425-05	PTTestr 35 (pH/TDS)
WD-35425-10	PCSTestr 35 (pH/conductivity/TDS/salt)

Accessories

WD-35425-50 Replacement pH/conductivity/TDS/salinity sensor module for all 35-series Testrs
WD-09377-16 Replacement batteries, 1.5 V.
 Pack of 6

Specifications

ISO9001:2008
CERTIFIED SUPPLIER



1 year
warranty
meter only

	Model	PCTestr 35	PTTestr 35	PCSTestr 35
Range	pH	0.0 to 14.0 pH	0.0 to 14.0 pH	0.00 to 14.00 pH
	Conductivity	0 to 2000 µS; 2.00 to 20.00 mS	—	0 to 200 µS, 201 to 2000 µS; 2.01 to 20.00 mS
	TDS	—	0 to 1000 ppm; 1.00 to 10.00 ppt	0.0 to 99.9 ppm, 100 to 999 ppm; 1.00 to 10.0 ppt
	Salinity	—	—	0 to 10.0 ppt
	Temperature	0 to 50°C (32 to 122°F)	0 to 50°C (32 to 122°F)	0 to 50°C (32 to 122°F)
Resolution	pH	0.1 pH	0.1 pH	0.01 pH
	Conductivity	10 µS; 0.1 mS	—	0.1 µS, 1 µS; 0.1 mS
	TDS	—	1 ppm; 0.01 ppt	0.1 ppm, 1 ppm; 0.1 ppt
	Salinity	—	—	0.1 ppm, 1 ppm; 0.1 ppt; 0.10 to 1.00%
	Temperature	0.1°	0.1°	0.1°
Accuracy	pH	±0.1 pH	±0.1 pH	±0.01 pH
	Conductivity	±1% full-scale	—	±1% full-scale
	TDS	—	±1% full-scale	±1% full-scale
	Salinity	—	—	±1% full-scale
	Temperature	±0.5°C (±0.9°F)	±0.5°C (±0.9°F)	±0.5°C (±0.9°F)
Calibration	pH	3 points	3 points	5 points
	Conductivity	2 points	—	3 points
	TDS	—	2 points	3 points
	Salinity	—	—	1 point
	Temperature	1 point	1 point	1 point

Temperature compensation: automatic (ATC), from 0 to 50°C (32 to 122°F) or manual

Operating temperature: 0 to 50°C (32 to 122°F)

Power: four 1.5 V alkaline batteries (included), approximately 250 hours continuous use; Eveready® A76 or LR44 equivalent replacement

Dimensions

Unit only: 6½" x 1½" dia (16.5 x 3.8 cm)

Boxed: 7¼" x 2½" x 2" (18.4 x 6.4 x 5.0 cm)

Weight

Unit only: 3.25 oz (90 g); **Boxed:** 6 oz (170 g)

Handheld pH/Ion Meter Selection Guide

Get Better Accuracy!

Oakton pH meters offer up to 6-point calibrations with auto-buffer recognition function and a wide selection of buffer sets— quick, easy calibrations with flexibility to meet your applications.

Kits include quality “All-in-One” pH and temperature probes, or separate pH electrode with ATC temperature probe to ensure temperature compensation. For special application requirements, Oakton meters are compatible with most electrodes with a BNC connector (see pages 23 to 29 for selection). Don’t forget the Oakton NIST-traceable calibration buffers (see page 22)— fresh buffer is a great way to ensure accuracy.

Get Dependability!

Oakton handheld meters are built for field duty with rugged case designs and protective rubber boots. Our meters are built to last and include a three-year warranty. ISO 9001:2008 certified company with CE mark product to ensure product excellence.



5+/6+ series

Waterproof 150 series

Waterproof 450 series

Waterproof 600 series

Use this chart to find the best handheld pH or ion meter for your application

Meter	5+/6+ series	Waterproof 150 series	Waterproof 450 series	Waterproof 600 series
See pages	11–12	13	14	15–16
Description	Low cost, rugged, compact	Economical, dual display	Best value, advanced features	Rugged field/environmental meter
Display	Single-line LCD	Three-line LCD	Three-line LCD with backlight	Multiline dot matrix with backlight
IP67-rated housing	—	Yes	Yes	Yes
Memory	—	Up to 200 data sets	Up to 500 data sets	Up to 500 data sets
Communication	—	—	USB or RS-232	IrDA
Password protection	—	—	Yes	Yes
Real-time clock	—	Yes	Yes	Yes
pH calibration points	Up to 5	Up to 6	Up to 6	Up to 6
Auto buffer recognition	Yes	Yes	Yes	Yes
Buffer sets	US, NIST	US, NIST, DIN	US, NIST, DIN, PWB, custom	US, NIST, DIN
Automatic end-point	—	—	Yes	Yes
Automatic shut-off	After 17 minutes	After 20 minutes	Yes, adjustable	Yes, adjustable
Hold function	Yes	Yes	Yes	Yes
Ready/stability indicator	—	Yes	Yes	Yes
Error messages	Yes	Yes	Yes	Yes
Built-in stand	Yes (in boot)	Yes	Yes	Yes
Protective rubber boot	Included	—	—	Optional
Optional AC power adapter	—	Yes	Yes	Yes

Guarantee measurement accuracy—look for the precalibrated items throughout this section and save!

pH 5+ and 6+ Meters

Rugged, compact meters offer high accuracy at an extremely affordable price!

Simple push-button operation – So fast and easy, anyone can use it

Toggle between pH and temperature in °C with a press of a button

Five-point pH calibration – Choose from standard US, NIST, and pure water; gives you high ±0.01 pH accuracy

Auto buffer recognition – Automatically identifies the correct pH buffer for rapid calibration

Calibration instructions are printed on back of meter – For quick reference and added convenience

Automatic temperature compensation (ATC) – For the highest accuracy in changing temperature conditions

Hold and Auto-off functions

Built-in stand for benchtop or long-term use

Protective boot – Helps shield your meter from drops and dings

Meter kits available – Contain everything you need for calibration and measurement packaged in a hard carrying case – the best option.

pH 6+ also features

Measurements in pH, mV, and °C – Use for ORP (Redox) measurements



35613-52

ISO9001:2008
CERTIFIED SUPPLIER

3 year
warranty
meter only

Specifications

Model	pH 5+ and pH 6+ meters	pH 6+ meter only
Mode	pH	Temperature
Range	0.00 to 14.00 pH	0.0 to 100.0°C
Resolution	0.01 pH	0.1°C
Accuracy	±0.01 pH	±0.5°C
Calibration	Up to 5 buffer values: choose from standard US, NIST, and pure water buffer values	Offset 0.1°C increments
		±20 mV

Temperature compensation:
automatic from 0.0 to 100.0°C
Operating temperature: 0 to 50°C (32 to 122°F)
Power: four 1.5 V AAA batteries (included),
>200 hours continuous use

Dimensions
Meter: 5½"L x 2¾"W x 1¾"H (14 x 7 x 3.5 cm)
Boxed: 9¼"L x 6½"W x 3"H (23.5 x 16.5 x 7.5 cm)
Weight
Meter: 0.9 lb (0.4 kg); **Boxed:** 1 lb (0.5 kg)

Ordering Information

Catalog number	Precalibrated catalog number	Description	Included
WD-35613-50	WD-35613-51	pH 5+ meter only	Meter, ATC probe, protective rubber boot, and batteries
WD-35613-20	WD-35613-41	pH 6+ meter only	Meter, ATC probe, protective rubber boot, and batteries
WD-35613-52	WD-35613-53	pH 5+ meter with probes	Meter; single-junction, epoxy-body pH electrode; ATC probe; protective rubber boot; and batteries
WD-35613-22	WD-35613-42	pH 6+ meter with probes	Meter; single-junction, epoxy-body pH electrode; ATC probe; protective rubber boot; and batteries
WD-35613-54	WD-35613-55	pH 5+ meter kit	Meter; "All-in-One" single-junction, epoxy-sealed pH electrode; pH buffer pouches (pH 4.01, 7.00, 10.00, and rinse water); sample bottles; protective rubber boot; batteries; and hard carrying case
WD-35613-24	WD-35613-44	pH 6+ meter kit	Meter; "All-in-One" single-junction, epoxy-sealed pH electrode; pH buffer pouches (pH 4.01, 7.00, 10.00, and rinse water); sample bottles; protective rubber boot; batteries; and hard carrying case

Accessories

WD-35804-00 Replacement pH electrode
WD-35811-71 Replacement "All-in-One" single-junction, epoxy-sealed pH electrode
WD-35613-05 Replacement ATC probe



Meters include protective rubber boot and a built-in stand.

Ion 6+ Meter

Direct readout of ion concentration at an affordable price!

Use with pH or most ISE electrodes with BNC connectors – The ± 500 mV range covers the vast majority of ISEs

mV measurement mode – Allows you to check performance and calibration of your ion-selective electrode

Simple to use – Preprogrammed calibration points allow even beginners to take readings in minutes!

pH and temperature ($^{\circ}$ C) readout – With high ± 0.01 pH/ $\pm 0.5^{\circ}$ C accuracy

Automatic temperature compensation (ATC) for pH – For the highest accuracy in changing temperature conditions

Compact size – Take your Ion 6+ meter anywhere!

All push-button operation – For fast, easy use

Hold and Auto-off functions

Built-in stand for benchtop or long-term use

Protective boot – Helps shield your meter from drops and dings



35613-82



Meter includes protective rubber boot and a built-in stand.

See pages 28–29 for ion-selective electrodes

Specifications

ISO9001:2008
CERTIFIED SUPPLIER

CE

3 year
warranty
meter only

Mode	Ion	mV	pH	Temperature
Range	0.01 to 1999 units	-500 to +500 mV	0.00 to 14.00 pH	0.0 to 100.0 $^{\circ}$ C
Resolution	0.01 unit (0.01 to 0.99 units), 0.1 unit (0.1 to 199.9 units), 1 unit (200 to 1999 units)	0.1 mV within ± 199.9 mV, 1 mV beyond ± 200 mV	0.01 pH	0.1 $^{\circ}$ C
Accuracy	$\pm 1\%$ full-scale	± 0.2 mV within ± 199.9 mV, ± 2 mV beyond ± 200 mV	± 0.01 pH	$\pm 0.5^{\circ}$ C
Calibration	2 or 3 points; 0.1, 1, 10, 100 ppm (minimum 2 points)	Not available	Up to 5 buffer values From standard USA or NIST buffer sets, auto-buffer recognition	Offset 0.1 $^{\circ}$ C increments

Minimum slope during ion calibration: 40 mV/decade for monovalent ions; 20 mV/decade for divalent ions

pH slope range: 80 to 120%

Temperature compensation: manual or automatic from 0.0 to 100.0 $^{\circ}$ C

Operating temperature: 0 to 50 $^{\circ}$ C (32 to 122 $^{\circ}$ F)

Power: four 1.5 V AAA batteries (included), >200 hours continuous use

Dimensions

Meter: 5 $\frac{1}{2}$ " x 2 $\frac{3}{4}$ " x 1 $\frac{1}{8}$ " (14 x 7 x 3.5 cm)

Boxed: 9 $\frac{1}{4}$ " x 6 $\frac{1}{2}$ " x 3" (23.5 x 16.5 x 7.5 cm)

Weight

Meter only: 0.9 lb (0.4 kg); **Boxed:** 1 lb (0.5 kg)

Ordering Information

Catalog number	Precalibrated catalog number	Description	Included
WD-35613-80	WD-35613-81	Ion 6+ meter only	Meter, protective rubber boot, and batteries
WD-35613-82	WD-35613-83	Ion 6+ meter kit	Meter; single-junction, epoxy-body pH electrode; ATC probe; sample bottles; calibration buffer pouches; carrying case; protective rubber boot; and batteries

Accessories

WD-35811-71 "All-in-One" single-junction, epoxy-sealed pH electrode

WD-35613-05 Replacement ATC probe

pH 150 Meter

Best value for an IP67-rated waterproof meter!

Large, three-line LCD – Lets you view pH or mV measurement with temperature and calibration data with % slope

Built-in memory function – Stores up to 150 measurements along with temperature

Six-point pH calibration – Choose from USA, NIST, or DIN buffer sets

Auto buffer recognition – Automatically identifies the correct pH buffer for rapid calibration

Calibration alarm – A visible reminder when it is time to recalibrate the meter

Selectable manual or automatic temperature compensation (ATC) – For the highest accuracy in any situation

Selectable °C/°F – Choose units to best fit your application

Features mV offset – For calibration to ORP standards, zeroing mV value, and pH diagnostics

Hold function, ready indicator, automatic shut-off, and battery life indicator

Intuitive, user-friendly icons – Electrode status displays pH slope, not a confusing icon

Built-in stand – Ideal for easy benchtop or long-term use

Wall-mount option – Ideal to save on bench space

Grip-Clip™ holder – Quickly and easily secures the electrode to your beaker or container

Compatible with pH electrodes having a BNC connector

Power with batteries for 700 hours continuous in the field – Optional AC adapter for benchtop measurements

New



Wall-mount option to save space.



Meter includes built-in stand.



35614-30

ISO9001:2008
CERTIFIED SUPPLIER

TUV
PROBATE
SERVICES

CE 3 year
warranty

Specifications

Mode	pH	mV	Temperature
Range	-2.00 to 16.00	±2000 mV	-10.0 to 110.0°C (-17.0 to 230.0°F)
Resolution	0.01	0.1 mV ±999.9 mV; 1 mV beyond	0.1°C/°F
Accuracy	±0.01	±0.2 mV ±2 LSD or ±0.5% of reading; whichever is greater	±0.5°C; ±0.9°F
Calibration	Up to 6 points; USA, NIST, DIN	± 200 mV	Offset 0.1 increments

Display: 3-line custom LCD

Temperature compensation: automatic or manual from -10 to 110°C

Memory: stores up to 150 data sets

Power: two AA batteries (included), >700 hours continuous use; AC adapter (optional)

Dimensions (L x W x H)

Meter: 7 7/8" x 3 1/8" x 2 1/4" (20 x 8.3 x 5.7 cm)

Boxed: 9 1/8" x 9 1/8" x 2 3/4" (23 x 23 x 7 cm)

Weight:

Meter only: 1 lb (0.5 kg)

Boxed: 1.4 lb (0.7 kg)

Ordering Information

Catalog number	Pre-calibrated catalog number	Description	Included
WD-35614-32	WD-35614-34	pH 150 meter only	Meter, Grip-Clip electrode holder, and two AA batteries
WD-35614-30	WD-35614-33	pH 150 meter with probe	Meter, "All-in-One" pH electrode 35808-71, Grip-Clip electrode holder, and two AA batteries
WD-35614-90	WD-35614-91	pH 150 meter kit	Meter, "All-in-One" pH electrode 35808-71, pH buffers, storage solution, rinse solution, Grip-Clip electrode holder, two AA batteries, and hard carrying case

WD-35808-71 Replacement "All-in-One" pH electrode with built-in ATC. Single-junction, epoxy body, BNC connector

WD-35808-72 "All-in-One" pH electrode with built-in ATC. Double-junction, epoxy body, BNC connector

WD-35618-05 ATC probe. Use with any standard pH electrode for temperature compensation

WD-35614-50 Replacement Grip-Clip holder attaches probe to side of container for measurement

WD-35614-51 Hard carrying case, fits all 150/450 meter configurations

WD-35420-72 Optional adapter, 110/220 VAC

WD-09376-01 Replacement batteries, AA. Pack of 4

pH 450 Meter

Backlit, rugged waterproof meter is ideal for any environment!

Durable waterproof and dustproof design with IP67 rating

Large, backlit custom display – Lets you view measurement with temperature and calibration data with % slope

Measurements in pH, ISE, and mV – With automatic or manual temperature compensation

Six-point calibration – Choose USA, NIST, DIN, PWB, or custom buffers

Auto buffer recognition – Automatically identifies the correct pH buffer for rapid calibration

Calibration alarm – A visible reminder that it is time to recalibrate the meter

Hold, Ready, and automatic shutoff functions

Selectable °C/°F – Choose units to best fit your application

Intuitive, user-friendly icons – Electrode status displays pH slope

Store up to 500 data sets – Easy USB or RS-232 output with optional data cables

Built-in real-time clock stamps stored data and calibration data with time and date – Meets standards for GLP (Good Laboratory Practices)

Grip-Clip™ holder – Quickly and easily secures the pH electrode to your beaker or container

Built-in stand with wall mount option – Allows for easy benchtop measurement or storage

Extended battery life from two AA batteries or use optional universal power adapter

Compatible with pH/ISE electrodes having a BNC connector

New



35618-30

Specifications

ISO9001:2008
CERTIFIED SUPPLIER

TUV
RHS
SERVICE

CE 3 year
warranty

Mode	pH	mV	Ion	Temperature
Range	-2.00 to 16.00 pH	±2000 mV	0.0 to 19999	-10.0 to 110.0°C (-17.0 to 230.0°F)
Resolution	0.01 pH	0.1 mV ±999.9 mV; 1 mV beyond	0.01	0.1°C
Accuracy	±0.01 pH	±0.2 mV +2 LSD or ±5% of reading; whichever is greater	±0.5% full-scale (monovalent); ±1% full-scale (divalent)	±0.1°C/°F
Calibration	Up to six points; USA, NIST, DIN, PWB, custom	± 200 mV	Up to six points	±5.0° offset

Display: custom LCD with backlight

Memory: stores up to 500 data sets

Output: USB or RS-232

Real-time clock: time-and-date stamp on calibration and stored data

Temperature compensation: automatic or manual from -10 to 110°C

Power: two AA batteries (included), 500 hours (without backlight);
AC adapter (optional)

Dimensions (L x W x H)

Meter: 7⁷/₈" x 3¹/₈" x 2¹/₄" (20 x 8.3 x 5.7 cm)

Boxed: 9¹/₈" x 9¹/₈" x 2³/₄" (23 x 23 x 7 cm)

Weight:

Meter only: 1 lb (0.5 kg)

Boxed: 1.4 lb (0.7 kg)

Ordering Information

Catalog number	Pre-calibrated catalog number	Description	Included
WD-35618-32	WD-35618-34	pH 450 meter only	Meter, Grip-Clip holder, and two AA batteries
WD-35618-30	WD-35618-33	pH 450 meter with probe	Meter, "All-in-One" pH electrode (35808-71), Grip-Clip holder, and two AA batteries
WD-35618-90	WD-35618-91	pH 450 meter kit	Meter, "All-in-One" pH electrode (35808-71), Grip-Clip holder, pH buffers, storage solution, rinse solution, two AA batteries, and hard carrying case

WD-35808-71 Replacement "All-in-One" pH electrode with built-in ATC. Single-junction; epoxy body; BNC connector

WD-35808-72 "All-in-One" pH electrode with built-in ATC. Double-junction; epoxy body; BNC connector

WD-35618-05 ATC probe. Use with any standard pH electrode with BNC for temperature compensation

WD-35802-00 Ammonia electrode, gas sensing; epoxy body, single junction

WD-35802-18 Fluoride electrode, solid state; epoxy body, single junction

WD-35802-12 Chloride electrode, solid state; epoxy body, single junction

WD-35614-50 Replacement Grip-Clip electrode holder

WD-35614-51 Hard carrying case, fits all 150/450 meter configurations

WD-35630-53 Data cable for USB connectivity

WD-35420-01 Data cable for RS-232 connectivity

WD-35420-72 Optional adapter, 110/220 VAC

WD-09376-01 Replacement batteries, AA. Pack of 4

...setting the standard again and again®

Handheld Meters — pH/Ion

pH/Ion

pH 600 and pH 610 Meters

Expanded range, resolution, and accuracy—plus increased memory and advanced communications!

Durable waterproof and dustproof design with IP67 rating – Even with no probes attached

Push-button pH calibration at up to six points – Up to 15 buffer options with auto-buffer recognition of USA, NIST, DIN, and PWB standards

Large backlit graphic display – Multi-line display with electrode status indicator, calibration data, and more

User-settable “calibration due” alarm – Out-of-date or unperformed calibrations are now things of the past!

Built-in real-time clock – Time-and-date stamping meets Good Laboratory Practice (GLP) standards

Store up to 500 data sets – Infrared IrDA wireless technology makes PC downloading convenient and easy

Set point alarms – Audible warning when readings are outside set points limit

Research-grade accuracy – Resolution to 0.001 pH and accuracy to ±0.002 pH on pH 610 model

Electrode status indicator – Calibration data provides electrode diagnostic tool

Password protection – Security for calibration and setup menus

Complete kits are available – Include meter, probe, solutions, and carrying case



35418-12

ISO9001:2008
CERTIFIED SUPPLIER



3 year
warranty
meter only

Specifications

Model	pH 600 meter	pH 610 meter
Range	pH	-2.00 to 19.99
	mV	±2000 mV
	Temperature	-10.0 to 110.0°C (14.0 to 230.0°F), selectable
Resolution	pH	0.1/0.01 pH
	mV	0.1 mV
	Temperature	0.1°C (0.1°F)
Accuracy	pH	±0.01 pH
	mV	±0.2 mV
	Temperature	±0.5°C (±0.9°F)
Calibration	pH	Up to 6 buffer values (select from 4 sets): USA 1.68, 4.01, 7.01, 10.01, 12.45; NIST: 1.68, 4.01, 6.86, 9.18, 12.45; DIN: 1.09, 2.06, 4.65, 6.79, 9.23, 12.75, or custom buffers
	mV	Offset up to ±150 mV
	Temperature	Offset 0.1°C (0.1°F) increments

Memory: up to 500 sets with GLP date and time

Output: infrared, IrDA

Real-time clock: time-and-date stamp on calibration and stored data

Temperature compensation: automatic or manual (selectable) from 0 to 100°C

Ambient operating temperature: 0 to 50°C (32 to 122°F)

Power: four 1.5 V AA batteries (included) or optional universal AC adapter, up to 500 hours continuous use

Dimensions

Meter: 7¼" L x 3¼" W x 2¼" H (18.4 x 8.3 x 5.7 cm)

Boxed: 9½" L x 9½" W x 2¾" H (23 x 23 x 7 cm)

Weight

Meter: 1 lb (0.5 kg); **Boxed:** 2 lb (0.9 kg)

Ordering Information

Catalog number	Precalibrated catalog number	Description	Included
WD-35418-02	WD-35418-03	pH 600 meter only	Meter and batteries
WD-35418-12	WD-35418-13	pH 610 meter only	Meter and batteries
WD-35418-00	WD-35418-01	pH 600 meter with probe	Meter, "All-in-One" probe 35816-71, and batteries
WD-35418-10	WD-35418-11	pH 610 meter with probe	Meter, "All-in-One" probe 35816-71, and batteries
WD-35418-70	WD-35418-71	pH 600 meter kit	Meter, "All-in-One" probe 35816-71, pH buffers (60 mL each of 4.01, 7.00, electrode storage solution, and rinse water), two electrode holders, rubber boot, batteries, and hard carrying case
WD-35418-80	WD-35418-81	pH 610 meter kit	Meter, "All-in-One" probe 35816-71, pH buffers (60 mL each of 4.01, 7.00, electrode storage solution, and rinse water), two electrode holders, rubber boot, batteries, and hard carrying case

WD-35816-71 Replacement "All-in-One" pH/temperature probe, single-junction, epoxy body

WD-35816-72 "All-in-One" pH/temperature probe, double-junction, epoxy body

WD-35418-05 ATC probe. Use for temperature compensation with any pH electrode without built-in ATC

WD-35418-83 Optional adapter, 110/220 VAC

WD-35418-86 Rubber boot for all 600-series meters



Ideal for laboratory testing.

Multiparameter models available. See pages 51–57.

pH 620 Meter

Research-grade ion-selective performance in a waterproof portable unit

Durable waterproof and dustproof design with IP67 rating – Even with no probes attached

Push-button pH calibration at up to six points – Up to 15 buffer options with auto-buffer recognition of USA, NIST, DIN, and PWB standards

Large backlit graphic display – Multi-line display with electrode status indicator, calibration data, and more

User-settable “calibration due” alarm – Out-of-date or unperformed calibrations are now things of the past!

Built-in real-time clock – Time-and-date stamping meets Good Laboratory Practice (GLP) standards

Store up to 500 data sets – Infrared IrDA wireless technology makes PC downloading convenient and easy

Set point alarms – Audible warning when readings are outside set points limit

Research-grade accuracy – Resolution to 0.001 pH and accuracy to ± 0.002 pH

Electrode status indicator – Calibration data provides electrode diagnostic tool

Password protection – Security for calibration and setup menus



pH 620 meter shown with rubber boot from 35418-90 kit.

ISO 9001:2008
CERTIFIED SUPPLIER

3 year
warranty
meter only

Specifications

	Model	pH 620 meter
Range	pH	-2.000 to 19.999 pH
	Ion	0.001 to 19,900 ppm, molar, or mg/L
	mV	± 2000 mV
	Temperature	-10.0 to 110.0°C (14.0 to 230.0°F), selectable
Resolution	pH	0.1/0.01/0.001 pH
	Ion	2 or 3 digits
	mV	0.1 mV
	Temperature	0.1°C (0.1°F)
Accuracy	pH	± 0.002 pH
	Ion	$\pm 0.5\%$ full-scale (monovalent); $\pm 1\%$ full-scale (divalent)
	mV	± 0.2 mV
	Temperature	$\pm 0.5^\circ\text{C}$ ($\pm 0.9^\circ\text{F}$)
Calibration	pH	Up to 6 buffer values (select from 4 sets): USA 1.68, 4.01, 7.01, 10.01, 12.45 NIST: 1.68, 4.01, 6.86, 9.18, 12.45 DIN: 1.09, 2.06, 4.65, 6.79, 9.23, 12.75, or custom buffers
	Ion	Up to 6 points
	mV	Offset up to ± 150 mV
	Temperature	Offset 0.1°C or 0.1°F increments

Memory: up to 500 sets with GLP date and time

Output: infrared, IrDA

Real-time clock: time-and-date stamp on calibration and stored data

Temperature compensation: automatic or manual (selectable) from 0 to 100°C

Ambient operating temperature: 0 to 50°C (32 to 122°F)

Power: four 1.5 V AA batteries (included) or optional universal AC adapter, up to 500 hours continuous use

Dimensions

Meter: 7¼" L x 3¼" W x 2¼" H (18.4 x 8.3 x 5.7 cm)

Boxed: 9½" L x 9½" W x 2¼" H (23 x 23 x 7 cm)

Weight

Meter: 1 lb (0.5 kg); **Boxed:** 2 lb (0.9 kg)



IrDA data connectivity



Large, detailed display

Ordering Information

Catalog number	Precalibrated catalog number	Description	Included
WD-35418-22	WD-35418-23	pH 620 meter only	Meter and batteries
WD-35418-20	WD-35418-21	pH 620 meter with probe	Meter, "All-in-One" probe 35816-71, and batteries
WD-35418-90	WD-35418-91	pH 620 meter kit	Meter, "All-in-One" probe 35816-71, pH buffers (60 mL each of 4.01, 7.00, electrode storage solution, and rinse water), two electrode holders, rubber boot, batteries, and hard carrying case

WD-35816-71 Replacement "All-in-One" pH/temperature probe, single-junction, epoxy body

WD-35816-72 "All-in-One" pH/temperature probe, double-junction, epoxy body

WD-35418-05 ATC probe. Use for temperature compensation with any pH electrode without built-in ATC

WD-35418-83 Optional adapter, 110/220 VAC

Benchtop pH/Ion Selection Guide

Benchtop meters are designed for today's crowded and very demanding laboratories



Electrode holder can be mounted to either side



Nonskid footpads



700-series meters offer...

- Space-saving footprint
- Oversized liquid crystal display
- Electrode holder can be mounted to either side
- Splashproof, easy-to-operate keypad
- Nonskid footpads
- Automatic temperature compensation
- Auto buffer recognition
- Electrode diagnostics
- Convenient pull-out quick-reference card



Splashproof keypad



Quick-reference card

2700-series meters also feature...

- Oversized graphic display with bright backlight
- Dynamic stability indication tells you when your reading is stable
- 500 data set memory with time/date stamping, RS-232 output, and software
- Up to 6-point calibrations with USA, NIST, DIN, and custom buffer sets
- Calibration reporting and calibration due alarm
- Out-of-range alarms
- Password protection



Unstable

Stable



Calibration reporting



Software



Both series are available in models to measure pH, mV, ion, conductivity, TDS, dissolved oxygen, and multi-parameters.

pH 700 Meter

Our most economical benchtop meter—with a space-saving footprint and easy-to-read display!

Low cost plus high performance – This meter offers laboratory-quality readings for a very economical cost

Compact design uses less benchspace – Meter is 40% smaller to fit into today's crowded laboratories

Oversized display – Dual display shows both pH (or mV) and temperature

Up to five-point pH calibration with auto buffer recognition – Calibrate at 1.68, 4.01, 7.00, 10.01, and 12.45 for high accuracy across the entire measuring range

Selectable buffer sets – Choose from USA or NIST buffer sets

Switch from pH to mV readings with a button press

Features 0.1 mV resolution for ORP measurements

Available with removable electrode holder – Holds electrode firmly in place

Selectable manual or automatic temperature compensation – For high accuracy with or without a temperature sensor

Built-in memory function – Stores up to 100 pH, mV, or relative mV readings with corresponding temperature

Hold function, "Ready" indicator, diagnostic error messages

Slide-out instruction card for quick reference

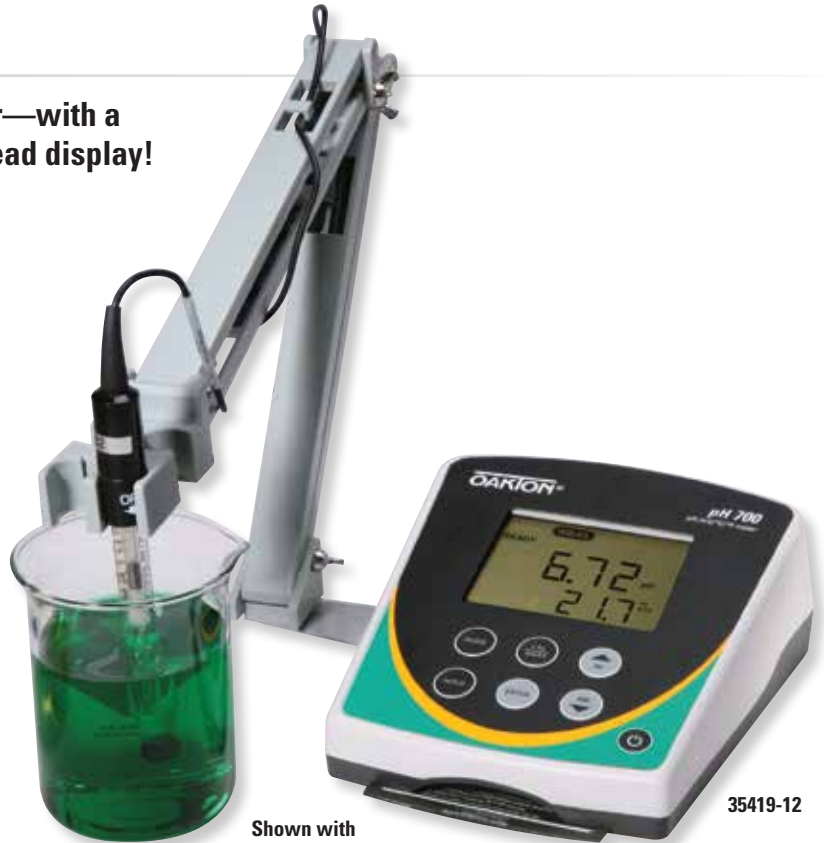

Shown with electrode holder.

35419-12

ISO9001:2008
CERTIFIED SUPPLIER

CE
3 year warranty
meter only

Specifications

Mode	pH	mV	Temperature
Range	-2.00 to 16.00 pH	±2000 mV	0 to 100.0°C (32 to 212°F)
Resolution	0.01 pH	0.1 mV from ±199.9 mV, 1 mV beyond ±199.9 mV	0.1°C or 0.1°F
Accuracy	±0.01 pH	±0.2 mV from ±199.9 mV, ±2 mV beyond ±199.9 mV	±0.3°C (±0.5°F)
Calibration	Up to 5 points (USA: 4.01; 7.00; 10.01, 12.45 or NIST: 1.68, 4.01, 6.86; 9.18, 12.45); auto-buffer recognition	Offset up to ±150 mV	Offset 0.1°C increments up to ±5°C

Temperature compensation: selectable manual or automatic from 0 to 100°C (32 to 212°F)

Memory: up to 100 sets, pH and temperature

Output: none

Display: 3¼" x 2⅝" (8.3 x 6.2 cm) dual LCD with temperature and mode annunciators

Error messages: diagnose operator error, electrode error, and meter error. Pull-out instruction card decodes message

Operating temperature: 5 to 45°C (41 to 113°F), noncondensing humidity

Power: 100/240 VAC, 50/60 Hz using AC adapters (included). AC adapters are UL and CSA listed.

Dimensions

Meter: 6⅞" x 6⅞" x 2¾" (15.5 x 17.5 x 6.9 cm)

Boxed: 9" x 12¾" x 5" (23 x 35 x 12.5 cm)

Weight

Meter only: 1.4 lb (0.6 kg); Boxed: 4 lb (1.8 kg)

Ordering Information

Catalog number	Pre-calibrated catalog number	Description	Included
WD-35419-00	WD-35419-01	pH 700 meter	Meter and AC adapter
WD-35419-03	WD-35419-05	pH 700 meter with electrode	Meter, single-junction "All-in-One" temperature pH electrode 35811-71, and AC adapter
WD-35419-12	WD-35419-15	pH 700 meter with electrode holder	Meter, electrode holder, and AC adapter
WD-35419-10	WD-35419-11	pH 700 meter kit	Meter, double-junction pH electrode 35805-04, temperature probe 35613-13, electrode holder, and AC adapter

WD-35420-54 Replacement electrode holder

WD-35420-72 Replacement power adapter, 110/220 VAC



Ion 700 Meter

Measure pH, mV, and direct ion concentration without sacrificing your budget, quality or performance!

Small footprint saves bench space – Gives you more working room in the lab

Direct readout of ion concentration in ppm – Resolution to 0.01 ppm

Oversized dual display for easier viewing – LCD shows measured parameter and temperature in pH/mV modes; ion concentration and mV (electrode output) in ion mode

Features 0.1 mV resolution for ORP measurements

Simultaneous display of ppm and mV electrode output in the ion mode – Verify electrode operation while taking measurements

Selectable buffer sets and five-point pH calibration with auto buffer recognition – Choose from USA or NIST buffer sets

Works with many ion-selective electrodes – The ±1999 mV range covers most ISEs

Built-in electrode stand – Holds electrode firmly in place

Selectable manual or automatic temperature compensation – For highest accuracy in any situation

Built-in memory function – Stores up to 100 ion, mV, or pH readings

Hold function, "Ready" indicator, diagnostic messages

Slide-out instruction card for quick reference

The Ion 700 meter includes a removable electrode holder and handy slide-out instruction card.

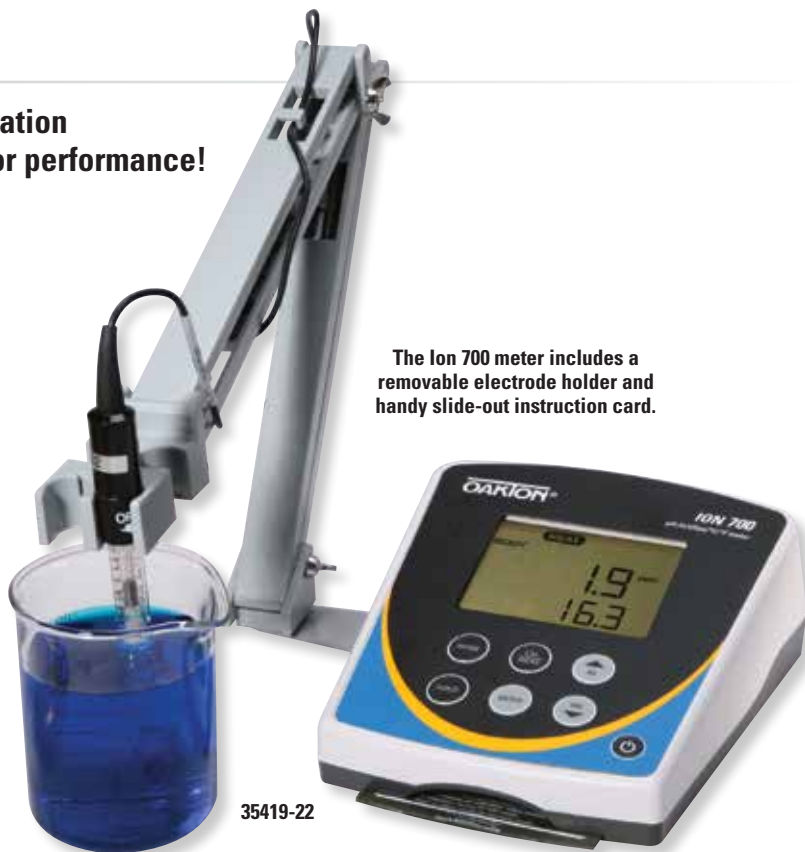

35419-22

ISO9001:2008
CERTIFIED SUPPLIER

3 year
warranty
meter only

Specifications

Mode	pH	mV	Ion	Temperature
Range	-2.00 to 16.00 pH	±2000 mV	0.01 to 2000 ppm	0.0 to 100.0°C (32 to 212°F)
Resolution	0.01 pH	0.1 mV from ±199.9 mV, 1 mV beyond ±199.9 mV	0.01 ppm from 0.01 to 0.99 ppm, 0.1 ppm from 1.0 to 199.9 ppm, 1 ppm from 200 to 1999 ppm	0.1°C or 0.1°F
Accuracy	±0.01 pH	±0.2 mV from ±199.9 mV, ±2 mV beyond ±199.9 mV	±0.5% of reading (monovalent) ±1.0% of reading (divalent)	±0.3°C (±0.5°F)
Calibration	Up to 5 points (USA: 1.68, 4.01; 7.00; 10.01; 12.45 or NIST: 1.68, 4.01, 6.86; 9.18, 12.45); auto-buffer recognition	Offset up to ±150 mV	From 2 to 5 points, 0.1; 1; 10; 100 ppm, 1 or 1000	Offset 0.1°C increments

Temperature compensation: selectable manual or automatic from 32 to 212°F (0 to 100°C)

Memory: up to 100 sets

Output: None

Display: 3¼" x 2⅝" (7.3 x 6.2 cm) dual LCD with temperature and mode annunciators

Error messages: diagnose operator error, electrode error, and meter error. Pull-out instruction card decodes message

Operating temperature: 5 to 45°C (41 to 113°F), noncondensing humidity

Power: 100/240 VAC, 50/60 Hz using AC adapters (included). AC adapters are UL and CSA listed.

Dimensions

Meter: 6⅞" x 6⅞" x 2¾" (15.5 x 17.5 x 6.9 cm)

Boxed: 9" x 12¾" x 5" (23 x 35 x 12.5 cm)

Weight

Meter only: 1.4 lb (0.6 kg); **Boxed:** 4 lb (1.8 kg)

Ordering Information

Catalog number	Precalibrated catalog number	Description	Included
WD-35419-22	WD-35419-26	Ion 700 meter with electrode holder	Meter, removable electrode holder, and AC adapter
WD-35419-20	WD-35419-24	Ion 700 meter with probes	Meter, double-junction pH electrode 35805-04, temperature probe 35613-13, electrode holder, and AC adapter
WD-35419-23	WD-35419-27	Ion 700 meter with pH/ATC probe	Meter, "All-in-One" single-junction pH electrode 35811-71, electrode holder, and AC adapter

WD-35420-54 Replacement electrode holder

WD-35420-72 Replacement power adapter, 110/220 VAC



Ion-selective and pH electrodes are available on pages 23–29.

pH 2700 Meter

Advanced meters that meet GLP requirements

Takes up less bench space – Overall footprint is nearly 40% smaller than other benchtop meters

Oversized liquid crystal display with bright backlighting – Easier viewing under all lighting conditions

Dynamic reading stability indication shows when you when your measurement is stable – Eliminates guesswork from unstable readings

Auto pH buffer recognition for up to 6-point calibrations – Choose USA, NIST, DIN or custom buffer sets

Up to 500 point nonvolatile memory with time-and-date stamp – Meets Good Laboratory Practice (GLP) requirements

Bidirectional RS-232 – For easy data transfer to your computer

Calibration documentation – Allows you to display, download, or print out calibration details like date and time, buffer values, offset, and slope

Cal-due alarms – Visual and audible reminders when recalibration is needed

Audible out-of-range alarms – Indicate when a reading is above or below a user-settable range

Electrode status – Provides the diagnostics needed to determine when electrode service or replacement is needed

Password protection – Prevents unauthorized setup and calibration



Software included



35420-20

ISO9001:2008
CERTIFIED SUPPLIER

CE 3 year
warranty
meter only

Specifications

Mode	pH	mV	Temperature
Range	-2.000 to 20.000 pH	±2000.0 mV	0.0 to 100.0°C (32.0 to 212°F)
Resolution	0.001, 0.01, 0.1 pH	0.1 mV	0.1°C or °F
Accuracy	±0.002 + 1 LSD	±0.2 mV	±0.3°C (±0.5°F)
Calibration	Up to 6 (USA, NIST, DIN, or custom buffer sets)	Offset up to +150 mV	—
Connectors	BNC	BNC	2.5 mm phono

Temperature compensation: manual or automatic from 0 to 100°C (32 to 212°F)

Memory: up to 500 data sets with time/date stamp

Output: RS-232, 9-pin female

Display: 3/4" x 2 1/8" (8.3 x 6.2 cm) graphic LCD with backlight

Operating temperature: 0 to 50°C (32 to 122°F), noncondensing humidity

Power: universal 110/240 VAC, 50/60 Hz with adapter; UL/CSA listed

Dimensions

Meter: 6 1/8" x 6 7/8" x 2 3/4" (15.5 x 17.5 x 6.9 cm)

Boxed: 12" x 9" x 5" (30.8 x 15.5 x 12.4 cm)

Weight

Meter only: 1.4 lb (0.6 kg); **Boxed:** 4 lb (1.8 kg)

Ordering Information

Catalog number	Pre-calibrated catalog number	Description	Included
WD-35420-22	WD-35420-23	pH 2700 meter	Meter, electrode holder, and AC adapter
WD-35420-20	WD-35420-21	pH 2700 meter kit	Meter, pH electrode 35805-04, ATC temperature probe 35613-13, 60-mL of electrode fill solution, electrode holder, and AC adapter

Accessories

WD-35805-04 Replacement combination pH electrode, double-junction, glass body, refillable

WD-35420-01 RS-232 data cable

WD-35630-53 USB data cable

WD-35420-50 Portable printer



Unstable reading is faded.



Reading turns solid when stable.



Calibration documentation can be printed as needed.

Ion 2700 Meter

Measures pH, mV, and ion concentration—well-suited for environmental, water, and food analysis

Takes up less bench space – Overall footprint is nearly 40% smaller than other benchtop meters

Oversized liquid crystal display with bright backlighting – Easier viewing under all lighting conditions

Dynamic reading stability indication shows when you when your measurement is stable – Eliminates guesswork from unstable readings

Up to 500 point nonvolatile memory with time-and-date stamp – Meets GLP requirements

Bidirectional RS-232 – For easy data transfer to your computer

Calibration documentation – Allows you to display, download, or print out calibration details like date and time, buffer values, offset, and slope

Cal-due alarms – Visual and audible reminders when recalibration is needed

Audible out-of-range alarms – Indicate when a reading is above or below a user-settable range

Electrode status – Provides the diagnostics needed to determine when electrode service or replacement is needed

Password protection – Prevents unauthorized setup and calibration



Software included

ISO9001:2008
CERTIFIED SUPPLIER

CE 3 year warranty
meter only

Specifications

Mode	pH	mV	ISE	Temperature
Range	-2.000 to 20.000 pH	±2000.0 mV	0.001 to 19,999 ppm	0.0 to 100.0°C (32.0 to 212°F)
Resolution	0.001, 0.01, 0.1 pH	0.1 mV	2 or 3 digits	0.1°C or °F
Accuracy	±0.002 pH	±0.2 mV	±0.5% full scale (monovalent), ±1% full scale (divalent)	±0.3°C (±0.5°F)
Calibration	Up to 6 (USA, NIST, DIN, or custom buffer sets)	Offset up to +150 mV	Up to 8 points	—
Connectors	BNC	BNC	BNC	2.5 mm phono

Temperature compensation: manual or automatic from 0 to 100°C (32 to 212°F)

Memory: up to 500 data sets

Output: RS-232, 9-pin female

Display: 3¼" x 2⅞" (8.3 x 6.2 cm) graphic LCD with backlight

Operating temperature: 0 to 50°C (32 to 122°F), noncondensing probe

Power: universal 110/240 VAC, 50/60 Hz with adapter; UL/CSA listed

Dimensions

Meter: 6⅞" x 6⅞" x 2¼" (15.5 x 17.5 x 6.9 cm)

Boxed: 12" x 9" x 5" (30.8 x 15.5 x 12.4 cm)

Weight

Meter only: 1.4 lb (0.6 kg); **Boxed:** 4 lb (1.8 kg)

Ordering Information

Catalog number	Precalibrated catalog number	Description	Included
WD-35421-02	WD-35421-03	Ion 2700 meter	Meter, electrode holder, and AC adapter
WD-35421-00	WD-35421-01	Ion 2700 meter kit	Meter, pH electrode 35805-04, ATC temperature probe 35613-13, 60-mL of electrode fill solution, electrode holder, and AC adapter

Accessories

WD-35805-04 Replacement combination pH electrode, double-junction, glass body, refillable

WD-35420-01 RS-232 data cable

WD-35630-53 USB data cable

WD-35420-50 Portable printer



Unstable reading is faded.



Reading turns solid when stable.



Calibration documentation can be printed as needed.

pH Buffer Solutions

Labeled with pH vs temperature tables for accurate calibration reference

Economical one-pint buffer solution bottles are freshness dated, and standardized against NIST-traceable references to ensure quality. The high-accuracy solutions are ideal for pH meters with 0.001 resolution. Sold in 500-mL bottles.



00654-00

00654-04

00654-08

Ordering Information

Catalog number	Description	Accuracy at 25°C
WD-00654-01	Buffer solution, pH 1.68	±0.01 pH
WD-00654-00	Buffer solution, pH 4.01	±0.01 pH
WD-00654-04	Buffer solution, pH 7.00	±0.01 pH
WD-00654-08	Buffer solution, pH 10.01	±0.01 pH
WD-00654-12	Buffer solution, pH 12.45	±0.01 pH
WD-05942-29	High-accuracy solution, pH 4.000	±0.002 pH
WD-05942-49	High-accuracy solution, pH 7.000	±0.002 pH
WD-05942-69	High-accuracy solution, pH 10.000	±0.005 pH
WD-05942-10	Buffer pack, one each of pH 4.01, 7.00, and 10.01	±0.01 pH

pH Buffer Pouches

Convenient and accurate

Single-use, air-tight pouches with high-precision calibration standards. All are freshness dated, and standardized against NIST-traceable references to ensure quality. Each box contains twenty 20-mL pouches.



Ordering Information

Catalog number	Description
WD-35653-01	pH 4.01
WD-35653-02	pH 7.00
WD-35653-03	pH 10.00
WD-35653-00	Deionized rinse water pouches
WD-35653-04	Assortment; five each of pH 4.01, 7.00, 10.00, and rinse water

Grip-Clip™ Holder

Simply clip holder to side of beaker or container for easy measurement

Convenient for portable meter measurements with pH and conductivity probes. Clip holder on side of beaker or container to support an ATC probe and a 11-/12-mm or 16-mm probe. Allows for easy, hand-free measurement.



Ordering Information

Catalog number	Description
WD-35614-50	Grip-clip holder

pH Electrode Care Solutions

Extend the life of your electrode!

Use these solutions to extend the life of your electrode, increase speed of response, and get accurate readings. Always keep your electrode moist by storing it in a solution when not in use. When adding fill solution, fill up to, but not past, the refill hole.



00653-04

00653-06

Ordering Information

Catalog number	Description
WD-00653-06	pH/ORP electrode cleaning solution, one pint. Removes buildup from electrodes to maintain bulb sensitivity.
WD-00653-04	pH electrode storage solution, one pint. Use with storage bottle (sold separately below table); keep bulb moist for quicker, more accurate pH readings.
WD-35803-73	Reference fill solution for single-junction pH electrodes. 4M KCl saturated with AgCl, 125 mL
WD-35803-74	Reference fill solution for double-junction or calomel reference refillable pH electrodes. 4M KCl, 125 mL
WD-35803-83	Reference fill solution, Lithium chloride (LiCl)/methanol, for double-junction refillable pH electrodes. Use where organics are present. 125 mL
WD-35803-84	Reference fill solution, KCl with glycerol, for double-junction refillable pH electrodes. Use for low-temperature samples. 125 mL

WD-35805-50 Electrode storage bottle accepts one electrode up to 12-mm dia

Portable Printer

Use with meters with RS-232 output

Create permanent records of your data from Oakton® meters with RS-232 output! Printer accepts standard-sized adding machine rolls and printer ribbons; order separately below table.



35420-50

Ordering Information

Catalog number	Description	Power
WD-35420-50	Portable printer	110/220 VAC

WD-35622-59 Printer cable, connects printer to meters with RS-232 output
WD-35420-51 Replacement paper roll

Electrode Selection Guide

The right electrode

While the basic principles of pH measurement are simple, getting an accurate measurement can often be challenging. There are hundreds of applications for pH measurement and each presents different problems. Selecting the right electrode can make the most difficult samples easy to accurately measure.

Gel-filled vs refillable electrodes

Gel-filled electrodes are convenient and easier to maintain than refillable liquid-filled electrodes. However the liquid-filled electrode will provide a faster response. In addition the user can adjust the fill solution to optimize performance, for example adding glycol for better performance at low temperatures.

Glass vs epoxy body electrodes

Glass body electrodes will typically be able to withstand higher temperatures (100°C as opposed to 80°C for epoxy). In addition, the glass design offers better sealing, fusing glass to glass instead of relying on adhesives. The epoxy body however is less susceptible to breakage.

Note: Even though the body of an epoxy electrode is plastic, the measuring bulb will still be glass.

Body design

Oakton offers electrodes in a variety of lengths and diameters. Small diameter probes are ideal for measuring samples in test tubes. Electrodes with wider barrels, greater weight, and longer cable lengths are available for measurements in streams, lakes, or ponds.

Bulb design

Oakton pH electrodes are handblown by experienced craftsmen. The bulb shape can be modified to provide a semi-dome for increased ruggedness, a spear tip for soft penetration applications, or even a flat surface. In addition, the glass formulation can provide increased range.

Reference design

To achieve accurate results, the reference electrode must allow electrolyte solution (or ions, in the case of a gel-filled electrode) to flow into the sample. Depending on the size and material of the junction, this flow rate can be increased or kept to a minimum. Faster flow produces stable readings faster but results in greater service requirements or premature electrode failure.

Reference chemistry

The leading cause of electrode failure is reference contamination. The most popular electrodes use a silver chloride (AgCl) reference solution that can react with heavy metals, sulfides, and organics. If your application has any of these contaminants present, be sure to select a double-junction electrode. The double-junction electrode uses a second internal reference junction, restricting the AgCl solution to the upper chamber where it is isolated from the sample.



Double-junction, glass-body, refillable pH electrode 35805-04



Single-junction, epoxy-body, gel-filled pH electrode 35808-71



Submersible pH electrode 35805-24

pH Electrode Anatomy

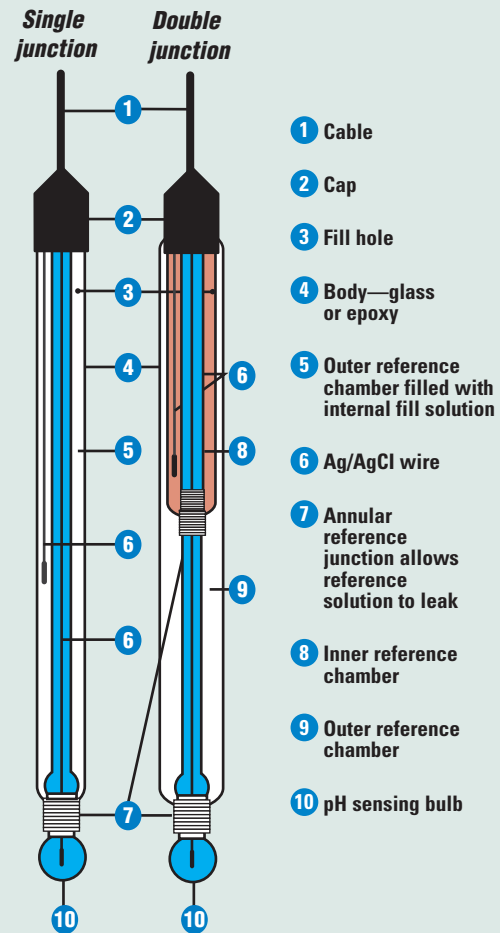

Electrodes for Laboratory and Field Applications

The Application Guide only offers suggestions—contact your Oakton Technical Product Specialist for more specific recommendations or clarification. Shipping dimensions for all electrodes are 10½" x 2½" x 4" (26.7 x 5.3 x 10.2 cm). Shipping weight 0.5 lb (0.2 kg) each.



Application Guide

Application	Suggested electrode
Drinking water	Standard Ag/AgCl with single junction
Wastewater, solutions with heavy metals	Double junction solutions
Biological samples, proteins, and Tris buffers	Double junction
Pharmaceuticals	
Low ionic strength samples	Flushable or sleeve-type refillable electrode
Boiler feed water and distilled water	
Soil samples	Soil electrode, double junction
Moist flat surfaces, concrete, cheese, agar, paper, and skin	Flat-surface
Semisolid samples, food, fruits, cheese, and meat	Spear tip
Nonaqueous samples, solvents, alcohols, viscous samples, slurries, suspended solids, sludges, emulsions and oils, paints, and inks	Sleeve-type, flushable, or double junction electrode and fill with electrolyte containing methanol
Environmental, surface water, neutralization tanks	Double junction submersible

Use and Care of Electrodes

Handling – Electrodes should be rinsed between samples with distilled or deionized water. Never wipe an electrode—wiping can cause erroneous readings due to static charges. Gently blot the end of the electrode with lint-free paper to remove excess water.

Refillable Electrodes – See page 22 for reference solutions.

The filling solution in refillable electrodes should be filled up to, but not past, the refill hole. Make sure the refill hole is left open when measuring to ensure that the fill solution flows properly through the reference junction.

Storage – See page 22 for storage products.

Always keep your pH electrode moist. We recommend that you store your electrode in an electrode storage solution of 4 M KCl (see page 22). If 4 M KCl is not available, use a pH 4 or 7 buffer solution. **DO NOT** store electrode in distilled or deionized water—this will cause ions to leach out of the glass bulb and reference electrolyte, rendering your electrode useless.

Oakton electrodes are shipped with a protective electrode storage bottle to help prevent cracking or scratching, and to keep the bulb moist. Remove the electrode storage bottle before using your electrode. Keep your electrode in the bottle for long-term storage—just fill the bottle with enough 4 M KCl solution to cover the glass bulb and replenish as needed.

Electrode Types

Built-in temp sensor	Use electrode with the following meters
Standard: Most economical electrode; includes BNC connector and cable.	
No	pHTestr BNC, pH 5/6, Ion 6, pH 5+/6+, Ion 6+, pH 10/11/100/110, pH 300/310, pH 500/510, Ion 510, pH 1000/1100/2100/2500, pH 700/2700, Ion 700/2700, PC 700/2700, pH/DO 300, pH/CON 300, pH/CON 510, pH 600/610/620, PC600, PD600, PDC650, and non-Oakton meters with BNC pH electrodes
All-in-One: Combination pH electrode/temperature sensor; includes BNC connector, meter-specific temperature connector, and cable. (See key images below to match your Oakton meter with the correct All-in-One electrode.)	
Yes	A Original: pH 10/100, pH 500, pH 1000/2500
	B Phono: pH 5/6, pH 5+/6+, Ion 6, Ion 6+, pH 11/110, pH 510, Ion 510, pH 1100/2100, pH 700/2700, Ion 700/2700, PC 700/2700
	C Waterproof: pH 300/310, pH/CON 300, pH/CON 510
	D WP600: pH 600/610/620, PC600, PD600, PCD650
Direct connect: Electrode connects directly to meter; BNC connector and no cable.	
No	pHTestr BNC
ORP: Takes mV readings; includes BNC connector and cable.	
No	pH 5+/6+, pH 6, Ion 5/6, Ion 6+, pH 10/100, pH 300/310, pH 500, pH 510, Ion 510, pH 1000/2100/2500, pH/CON 510, pH 700/2700, Ion 700/2700, PC 700/2700
ISE: Takes ion-selective readings; includes BNC connector and cable. See pages 28-29 for ISEs	
No	Ion 5/6, pH 10/100, pH 300/310, pH 500, pH/CON 510, pH 510, Ion 510, pH 1000/1100/2100/2500, Ion 700/2700, PC 2700

Connector Types



...setting the standard again and again®

Electrodes — pH/Ion

pH/Ion

Connector Types

Temperature probes

Order a temperature probe if you have an electrode without a built-in temperature sensor and you want to take readings with Automatic Temperature Compensation (ATC). Separate temperature probes offer faster temperature response and lower pH electrode replacement cost. See Connector Types key at right.

Catalog number	Key	Connector type	Use with the following meters
WD-35613-05	B	Phono	pH 5, pH 6, pH 5+, pH 6+, Ion 6, pH 11, pH 110, pH 510, Ion 510, pH 1100, pH 2100
WD-35613-13	B	Phono	pH 700/2700, Ion 700/2700, PC 2700
WD-35618-05	C	Waterproof	pH 150, pH 300, pH 310, pH 450, pH/CON 300, pH/CON 510,
WD-35418-05	D	WP600	pH 600/610/620, PC600, PC700, PD600, PCD650



Single-junction, epoxy-body, gel-filled pH electrodes

- Our most economical electrodes!
- 0 to 14 pH models available—use for high sodium/high pH solutions

These economical electrodes are ideal for field, clean water, and general-purpose applications. They feature a rugged epoxy housing. Pin-type junction provides low electrolyte flow for long life.

Specifications & Ordering Information

Max temperature: 80°C (except 35801-00: 70°C)
Diameter: 12 mm (except 35804-50: 12.5 mm)

Catalog number	Type*	Cable length
Standard range of 0 to 12 pH		
WD-35801-00	Standard	3 ft (1 m)
WD-35801-71	All-in-One Original A	30" (76.2 cm)
WD-35811-71	All-in-One Phono B	30" (76.2 cm)
WD-35808-71	All-in-One Waterproof C	30" (76.2 cm)
WD-35816-71	All-in-One WP600 D	30" (76.2 cm)
WD-35804-00	Direct connect	No cable
High range of 0 to 14 pH		
WD-35805-05	Standard	3 ft (1 m)
WD-35801-76	All in One	30" (76.2 cm)



Double-junction, epoxy-body, gel-filled pH electrodes

- Use to test dirty water and for other rugged field applications
 - 0 to 14 pH models available—use for high sodium/high pH solutions
- Ideal for most applications, including dirty field water and solutions with heavy metals or organics. Pin-type junction provides low electrolyte flow for long life.

Specifications & Ordering Information

Range: 0 to 12 pH Max temperature: 80°C Diameter: 12 mm

Catalog number	Type*	Cable length
WD-35805-09	Standard	3 ft (1 m)



Double-junction, epoxy-body, gel-filled pH electrodes

- Use for high-grade laboratory applications
- These laboratory-grade electrodes are ideal for testing dirty water and solutions with heavy metals or organics. Annular-type junction provides faster electrode response. Order replacement electrode fill solution on page 27.

Specifications & Ordering Information

Max temperature: 80°C Diameter: 12 mm

Catalog number	Type*	Cable length
Standard range of 0 to 12 pH		
WD-35805-01	Standard	3 ft (1 m)
WD-35641-51	Standard, poly-gel	3 ft (1 m)
WD-35801-72	All-in-One Original A	30" (76.2 cm)
WD-35811-72	All-in-One Phono B	30" (76.2 cm)
WD-35808-72	All-in-One Waterproof C	30" (76.2 cm)
WD-35816-72	All-in-One WP600 D	30" (76.2 cm)
WD-35804-02	Direct connect	No cable
High range of 0 to 14 pH		
WD-35805-06	Standard	3 ft (1 m)



Double-junction, glass-body, refillable pH electrodes

- Features flushable PTFE junction—use with substances that ordinarily clog standard electrodes
- Ideal for testing dirty water, slurries, oils, paints, pastes, low ionic strength solutions, and solutions with heavy metals or organics. Flushable annular junction lets you refresh junction by pressing electrode cap—cleans clogs instantly.

Specifications & Ordering Information

Max temperature: 100°C Diameter: 12 mm

Catalog number	Type*	Cable length
Standard range of 0 to 12 pH		
WD-35805-04	Standard	3 ft (1 m)
High range of 0 to 14 pH		
WD-35805-08	Standard	3 ft (1 m)
WD-35801-79	All-in-One, high Na+ A	3 ft (1 m)
WD-35811-74	All-in-One Phono B	3 ft (1 m)

*See "Electrode Types" on page 24.

Electrodes for Laboratory and Field Applications

Electrode Types

Built-in temp sensor	Use electrode with the following meters
Standard: Most economical electrode; includes BNC connector and cable.	
No	pH 5+/6+, pHTestr BNC, pH 5/6, Ion 6, Ion 6+, pH 10/11/100/110, pH 300/310, pH 500/510, Ion 510, pH 1000/1100/2100/2500, pH 700/2700, Ion 700/2700, PC 700/2700, pH/DO 300, pH/CON 300, pH/CON 510, pH 600/610/620, PC600, PD600, PDC650, and non-Oakton meters with BNC pH electrodes
All-in-One: Combination pH electrode/temperature sensor; includes BNC connector meter specific temperature connector, and cable. (See key image at right.)	
Yes	 Waterproof: pH 300/310, pH/CON 300, pH/CON 510
Direct connect: Electrode connects directly to meter; BNC connector and no cable.	
No	pHTestr BNC
ORP: Takes mV readings; includes BNC connector and cable.	
No	pH 5+/6+, pH 6, Ion 5/6, Ion 6+, pH 10/100, pH 300/310, pH 500, pH 510, Ion 510, pH 1000/2100/2500, pH/CON 510, pH 700/2700, Ion 700/2700, PC 700/2700



Glass-body, spear-tip pH electrodes

– Test gels, semisolids, and plant or animal materials

Spear tip feature is ideal for testing semisolids. Choose single or double junction electrodes; both have an annular-type junction for faster electrode response.

Specifications & Ordering Information

Range: 0 to 12 pH

Max temperature: 100°C

Diameter: 12 mm OD, 8 mm tip

Catalog number	Type*	Junction	Cable length
WD-35805-18	Standard	Double	3 ft (1 m)
WD-35804-06	Standard	Single	3 ft (1 m)



Submersible pH electrodes

– Completely submersible up to 9 feet

These ABS plastic electrodes are ideal for field applications. Use double junction for testing dirty water and solutions with heavy metals or organics. Completely submersible—including the extra-long 10-ft cable. Annular junction provides fast response and resists pressure effects of submersion.

Specifications & Ordering Information

Range: 0 to 12 pH

Max temperature: 80°C

Diameter: 25 mm

Catalog number	Type*	Junction	Cable length
WD-35805-24	Standard	Double	10 ft (3 m)
WD-35801-85	All-in-One Waterproof 	Double	10 ft (3 m)
WD-35805-23	Standard	Single	10 ft (3 m)
WD-35805-25	ORP	Single	10 ft (3 m)

Connector Type



Epoxy-body ORP electrodes

– Use to take mV readings

Choose a single-junction electrode for field, clean water, and general-purpose applications; choose a double junction electrode for most applications including field, dirty water, heavy metals, and organics. Both models have a pin-type junction that provides low electrolyte leakage. Use the gold disk sensor for ozone applications.

Specifications & Ordering Information

Range: ±2000 mV

Max temperature: 80°C (except 35805-13: 70°C)

Diameter: 12 mm

Catalog number	Type*	Junction	Cable length
Platinum band sensor			
WD-35805-13	Standard	Single	3 ft (1 m)
WD-35805-15	Standard	Double	3 ft (1 m)
Platinum pin			
WD-35420-71	Standard	Double	3 ft (1 m)
Gold disk sensor			
WD-35805-27	Standard	Double	3 ft (1 m)



Small-diameter pH electrodes

– Ideal for measurements in test tubes, NMR tubes, and other applications where space is limited

These electrodes feature a diameter from 6 to 9 mm—ideal for test tube applications. Replacement electrode fill solution for refillable electrodes is available on page 27.

Specifications & Ordering Information

Range: 0 to 12 pH

Max temperature: 80°C epoxy body or 100°C glass body

Catalog number	Type*	Junction	Dia x L	Cable length
Epoxy-body electrodes, sealed				
WD-35805-22	Standard	Single	6 x 220 mm	3 ft (1 m)
WD-35804-01	Direct connect	Single	9 x 100 mm	No cable
WD-35804-03	Direct connect	Double	9 x 100 mm	No cable
Epoxy-body electrode, refillable				
WD-35804-05	Direct connect	Double	9 x 100 mm	No cable
Glass-body electrode, refillable				
WD-35805-21	Standard	Double	8 x 325 mm	3 ft (1 m)

*See "Electrode Types" above.

...setting the standard again and again®

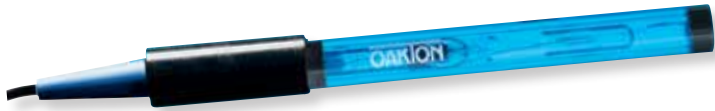

Flat surface pH electrodes

– Ideal for flat surface measurements such as paper or skin
 These electrodes are available with sealed epoxy body or refillable glass body. Replacement electrode fill solution for refillable electrode is available below.

Specifications & Ordering Information

Range: 0 to 12 pH
 Max temperature: 80°C epoxy body or 100°C glass body
 Diameter: 12 mm

Catalog number	Type*	Junction	Cable length
Epoxy-body electrodes, sealed			
WD-35805-19	Standard	Single	3 ft (1 m)
WD-35804-10	Direct connect	Single	No cable
WD-35805-72	All-in-One	Double	3 ft (1 m)
Glass-body electrode, refillable			
WD-35805-70	All-in-One	Double	3 ft (1 m)
WD-35805-20	Standard	Single	3 ft (1 m)



Sleeve-type, single-junction, refillable pH electrode

– Ideal for viscous liquids and low ionic strength samples
 Sleeve design gives high electrolyte flow. Unique reference design and fill solution minimize drift and give excellent performance at high temperatures.

Specifications & Ordering Information

Range: 0 to 12 pH
 Max temperature: 100°C
 Diameter: 12 mm

Catalog number	Type*	Cable length
WD-35805-26	Standard	3 ft (1 m)

*See "Electrode Types" on page 26.



Semi-dome, epoxy-body, gel-filled pH electrode

– Rugged semi-dome bulb design
 Special close-knit ceramic junction prevents back diffusion problems and resists clogging. Vortexing junction design enhances electrolyte flow and self-cleans in flowing applications. Epoxy body; polymer gel reference fill won't break down over time, enhancing electrode performance and longevity.

Specifications & Ordering Information

Range: 0 to 13 pH
 Max temperature: 100°C
 Diameter: 12 mm

Catalog number	Type*	Junction	Cable length
WD-35808-89	All-in-One Waterproof	Single	3 ft (1 m)



Polymer gel, single-junction pH electrode

– Polymer gel reference fill won't break down over time, enhancing electrode performance and longevity

Specifications & Ordering Information

Range: 0 to 13 pH
 Max temperature: 100°C
 Diameter: 12 mm

Catalog number	Type*	Cable length
WD-35808-90	All-in-One Waterproof	3 ft (1 m)



00653-04

00653-06

35805-50

Oakton® Electrode Care

- Extend the life of your electrode, increase speed of response, and get accurate readings
- Solutions to clean, store, and fill electrodes

WD-00653-04 pH electrode storage solution, one pint. Use with saver bottles; keep bulb moist for quicker, more accurate pH readings

WD-00653-06 pH/ORP electrode cleaning solution, one pint. Removes build-up from electrodes to maintain bulb sensitivity

WD-35805-50 Replacement pH electrode saver bottle. For pH electrodes up to 12 mm dia. 44.5 mm H x 25.4 mm dia

WD-35803-73 Reference fill solution for single junction pH electrodes. 4 M KCl saturated with AgCl, 125 mL

WD-35803-74 Reference fill solution for double junction or calomel reference refillable pH electrodes. 4 M KCl, 125 mL

WD-35803-83 Reference fill solution, lithium chloride (LiCl)/methanol, for double junction refillable pH electrodes. Use where organics are present. 125 mL

WD-35803-84 Reference fill solution, KCl with glycerol, for double junction refillable pH electrodes. Use for low-temperature samples. 125 mL

Accessories

WD-35820-64 In-line threaded housing. Use to install any 12-mm diameter electrode into pipe for in-line use or submersible monitoring; 3/4" NPT(M), nylon

WD-35420-54 Replacement electrode holder arm

Ion-Selective Electrodes and Solution Kits

Ion-Selective Electrodes

Oakton has a large selection of ion-selective electrodes (ISEs) to suit a wide variety of applications. Each electrode has a typical response time of 20 to 30 seconds but will vary with solution concentration. Oakton offers four electrode types: membrane, solid-state, gas sensing, and glass bulb. Gas sensing electrodes also include replacement membranes.

Electrodes are double junction except for ammonia, carbon dioxide, and nitrogen oxide which are single junction. All electrodes are refillable and include 15 mL of electrolyte and a filling pipette. Solid-state electrodes also include polishing strips.

Epoxy-body,
double-junction
fluoride electrode
35812-18



Use these
ion-selective
electrodes (ISEs)
with:

Ion 700 benchtop meter
(see page 19)

Ion 2700 benchtop
meter (see page 21)

PC 2700 benchtop
meter (see page 59)

pH 450 handheld
meter (see page 14)

Ion 6+ handheld
meter (see page 12)

Or use with any other ion
meter, or with any meter
with 0.1 mV resolution.

Specifications & Ordering Information

Ion	Electrodes		Solution Kits [†]		
	Epoxy body	Glass body	Solution kit	Replacement calibration standard	Replacement ISA
Ammonia NH₃ High-purity power station water, fish tanks, sea water, wastewater, plating baths, air/stack gases, and biological samples. Range: 17,000 to 0.01 ppm Type: gas sensing	WD-35802-00 [‡]	—	WD-35802-50*	WD-35803-01	—
Ammonium NH₄⁺ Boiler feed water, natural water and fertilizers. User must supply calibration standard. Range: 18,000 to 0.1 ppm Type: polymer membrane	WD-35812-02	WD-35802-03	WD-35802-53	—	WD-35803-53
Bromide Br⁻ Water, wine, soil, plant tissue, blood electrolytes, and clinical analysis. Range: 79,000 to 0.4 ppm Type: solid-state	WD-35812-04	WD-35802-05	WD-35802-55	WD-35803-03	WD-35803-51
Cadmium Cd⁺² Plating baths. User must supply calibration standard. Range: 11,200 to 0.01 ppm Type: solid-state	WD-35812-06	WD-35802-07	WD-35802-57	—	WD-35803-51
Calcium Ca⁺² Water softening systems, boiler feed water, drinking/mineral water, blood electrolytes, clinical analysis, and food applications. Range: 40,000 to 0.2 ppm Type: polymer membrane	WD-35812-08	WD-35802-09	WD-35802-59	WD-35803-05	WD-35803-52
Carbon Dioxide CO₂ and Carbonate CO₃⁻² Soft drinks/carbonated beverages, wine, beer, fermentation processes, bacterial cultures. Range: 440 to 4.4 ppm Type: gas sensing	WD-35802-10 [‡]	—	WD-35802-60	WD-35803-07	WD-35803-55
Chloride Cl⁻ River/tap water, plant tissue, soils, boiler feed water, blood electrolytes, clinical analysis, sweat, urine, cement, plating baths, and food samples. Range: 35,500 to 1.8 ppm Type: solid-state	WD-35812-12	—	WD-35802-63	WD-35803-09	WD-35803-51
Copper Cu⁺² Plating baths and water Range: 6350 to 6.4 x 10 ⁻⁴ ppm Type: solid-state	WD-35812-14	—	WD-35802-65	WD-35803-11	WD-35803-51
Cyanide CN⁻ Plating baths, wastewater and plant tissue. User must supply calibration standard. Range: 260 to 0.13 ppm Type: solid-state	WD-35812-16	WD-35802-17	—	—	WD-35803-50
Fluoride F⁻ Drinking/natural water, wastewater, air/stack gases, acids, sea water minerals, soils, food, biological fluids, toothpaste/mouthwash, coal, carbonated beverages, and bone. Range: saturated to 0.02 ppm Type: solid-state	WD-35812-18	WD-35802-19	WD-35802-69	WD-35803-13	WD-35803-58

*Ammonia solution kit does not include ISA. [†]Contact your authorized Oakton Distributor for replacement electrolyte solutions.

[‡]These electrodes are single junction.

Solution Kits

Be sure to select both the electrode and solution kit to complete your measurement system. Solution kits contain the solutions and accessories needed for calibration, sample preparation, and measurement of ion concentration and activity. All solutions are supplied with MSDS (Material Safety Data Sheet) and have a value of 1000 ppm. Solution kits include replacement reference electrolyte, ISA (ionic strength adjuster)*, calibration standard, and filling pipette. Kits for solid-state electrodes also include polishing strips. Kits for gas sensing electrodes also include replacement membranes.



Specifications & Ordering Information

Ion	Electrodes		Solution Kits [†]		
	Epoxy body	Glass body	Solution kit	Replacement calibration standard	Replacement ISA
Fluoroborate BF₄⁻ Plating baths (boron analysis) Range: 10,800 to 0.1 ppm Type: polymer membrane	—	—	WD-35802-71	WD-35803-15	WD-35803-60
Iodide I⁻ Milk, feeds, plants and pharmaceuticals. Range: 127,000 to 6 x 10 ⁻³ ppm Type: solid-state	WD-35812-22	WD-35802-23	WD-35802-73	WD-35803-17	WD-35803-51
Lead Pb⁺² Plating baths and organic compounds. Range: 20,700 to 0.2 ppm Type: solid-state	WD-35812-24	WD-35802-25	WD-35802-75	WD-35803-20	WD-35803-56
Nitrate NO₃⁻ Surface/drinking water, sewage effluent, soil extracts, fertilizers, plant tissue, meat, potatoes, spinach, beets, baby food. Range: 62,000 to 0.5 ppm Type: polymer membrane	WD-35812-30	WD-35802-31	WD-35802-79	WD-35803-24	WD-35803-60
Nitrogen Oxide NO_x Air and stack gases. Range: 220 to 0.2 ppm Type: gas sensing	WD-35802-32 [‡]	—	WD-35802-82	WD-35803-26	WD-35803-57
Perchlorate ClO₄⁻ Explosives and solid propellants. Range: 98,000 to 0.7 ppm Type: polymer membrane	WD-35812-34	WD-35802-35	WD-35802-85	WD-35803-28	WD-35803-60
Potassium K⁺ Wastewater, river/tap water, blood electrolytes, clinical analysis, saliva, serum, fertilizers, soils, and wines. Range: 39,000 to 0.04 ppm Type: polymer membrane	WD-35812-38	WD-35802-39	WD-35802-89	WD-35803-30	WD-35803-53
Silver/Sulfide Ag⁺/S⁻² Sewage effluent, soils, sediments, plating baths and photographic fixing solution. User must supply solutions for sulfide. Range: 107,900 to 0.01 ppm Type: solid-state	WD-35812-40	WD-35802-41	WD-35802-91	WD-35803-32	WD-35803-51
Sodium Na⁺ Steam condensates in power plants, blood electrolytes, clinical analysis, serum, foods, wine, glass, sea water, swimming pools, fish farms and aquariums. Range: 23,000 to 0.2 ppm Type: glass bulb	WD-35812-42	WD-35802-43	WD-35802-93	WD-35803-34	WD-35803-54
Surfactant X⁺, X⁻ Detergents, dishwashing liquids, cleaning supplies, and food products. For titration only. Range: 12,000 to 1.0 ppm Type: polymer membrane	WD-35812-44	WD-35802-45	WD-35802-95	WD-35803-35	WD-35803-59
Water hardness Ca⁺², Mg⁺² Water softening systems, boiler feed water, drinking/mineral water, blood electrolytes, clinical analysis, and food applications. Range: 40,000 to 0.4 ppm Type: polymer membrane	WD-35812-48	WD-35802-49	WD-35802-99	WD-35803-05	WD-35803-52

*Ammonia solution kit does not include ISA. [†]Contact your authorized Oakton Distributor for replacement electrolyte solutions.

[‡]These electrodes are single junction.

TDSTestr[®], ECTestr[®], and SaltTestr[®] Selection Guide

Better Accuracy

Oakton Instruments offers the only TDS and conductivity Testrs with $\pm 1\%$ full-scale accuracy. This is the best accuracy available on any pocket-sized total dissolved solids or conductivity meter. This can make a tangible difference for your application.

Great Value

You also want a good value when it comes to pocket-sized instruments. Our drive for quality and durability for our TDSTestrs and ECTestrs is what inspires us to do the extra things that may not even be readily apparent. From our use of custom thermoplastic housing materials that offer superior chemical and temperature durability, to our self-diagnostic error messages to help you immediately troubleshoot calibrations, batteries and sensors. Our application-specific microprocessors deliver superior instrument reliability. All of these attributes combine to give you a superior product that delivers long-term value.

More Options

Oakton Instruments also gives you options offered by no one else. We offer pocket-sized TDS and EC Testrs that measure across many ranges from the economical EcoTestrs to the versatile multiparameter 35-Series. We also offer a series of testers that include built-in sample cup sensors, and selectable °C/°F temperature readout, a specially designed tester for sodium chloride solutions, and a series of traditional “dip and read” meters.





Get More

Better accuracy and a higher-quality product featuring more options. You get it all with the Oakton TDSTestrs, ECTestrs, and SaltTestr.



Conductivity/TDS calibration pouches and solutions are available. See page 43 to order.

Find the right Testr for your application

Meter	EcoTestrs™	11 Series	11+ Series	Multiparameter 35-Series Testrs™
				
See pages	31	32–34	32–33	9
Parameters/models	Conductivity, TDS, salt	Conductivity, TDS, salt	Conductivity, TDS	pH, conductivity, TDS, salt
Electrode	Permanently fixed, stainless steel	Replaceable, stainless steel	Replaceable, stainless steel	Replaceable, combined pH and conductivity module
Accuracy	Up to $\pm 1\%$ full scale	Up to $\pm 1\%$ full scale	Up to $\pm 1\%$ full scale	Up to $\pm 1\%$ full scale
Display	One-line LCD	Two-line LCD	Two-line LCD	Two-line LCD
Calibration	1-point, manual	Up to 3-point manual or 2-point automatic	Up to 2-point manual or 3-point manual/automatic	Up to 5-point pH; 3-point EC/TDS

EcoTestr™ TDS, EC, and Salt

Simplicity with Oakton reliability

Simple single-line display – Large upright display is easy to read

1% full-scale accuracy – Suitable for many applications

Transparent protective cap – Doubles as a container for on-site calibration

Waterproof, dustproof housing – Meets IP67 rating, plus it floats!

Durable sensor – Two pin stainless steel with probe guard

Click-lock battery compartment – Simply lift and remove cover to replace batteries; no additional tools required

Push-button calibration – Calibrate more precisely than trimpot adjustment; no screwdrivers necessary

Hold function – Freezes reading until you can record it

Auto shut-off – Extends the life of batteries

Automatic temperature compensation (ATC) – Gives you accurate readings even with fluctuating temperatures



35462-10

35462-30

35462-50

Conductivity



Stainless steel sensor tip is both durable and chemical resistant.

Specifications

ISO9001:2008
CERTIFIED SUPPLIER

CE 1 year warranty

Model	EcoTestr TDS Low	EcoTestr TDS High	EcoTestr EC Low	EcoTestr EC High	EcoTestr Salt
Range	0 to 1990 ppm	0 to 10.1 ppt	0 to 1990 µS/cm	0 to 19.90 mS/cm	0 to 10.0 ppt
Resolution	10 ppm	0.1 ppt	10 µS	0.1 mS	0.1 ppt
Accuracy	±1% full scale	±1% full scale (±2% above 5 ppt)	±1% full scale	±1% full scale (±2% above 10 mS/cm)	±1% full scale (±2% above 5 ppt)
TDS factor	0.4 to 1.0 (adjustable)	0.4 to 1.0 (adjustable)	N/A	N/A	Fixed curve

Calibration: manual single-point

Operating temperature: 0 to 50°C (32 to 122°F)

Temperature compensation: automatic (ATC), from 0 to 50°C (32 to 122°F)

Power: four 1.5 V alkaline batteries (included), >500 hours continuous use; Eveready® A76 or LR44 equivalent replacement

Dimensions

Unit only: 1¼" x 1½" x 6½" (3.2 x 3.8 x 16.8 cm)

Boxed: 1½" x 5¼" x 9¾" (3.8 x 13.6 x 24.8 cm)

Weight

Unit only: 3.25 oz (90 g); **Boxed:** 6.0 oz (170 g)

Ordering Information

Catalog number	Description
WD-35462-10	EcoTestr TDS Low
WD-35462-15	EcoTestr TDS High
WD-35462-30	EcoTestr EC Low
WD-35462-35	EcoTestr EC High
WD-35462-50	EcoTestr Salt

Accessories

WD-09377-16 Replacement batteries, 1.5 V. Pack of 6

WD-35661-70 Deluxe calibration kit includes two each calibration pouches (447 µS, 1413 µS, 2764 µS, 15,000 µS, and rinse water), sample jar, and foam-lined hard plastic carrying case. (Tester not included)



TDSTestr® 11 Series

One meter can measure total dissolved solids from pure water to concentrated solutions

Large, easy-to-read display – Two-line display—units, measurement status, and battery life indicators

Replaceable electrodes – Reuse the meter body to save money

Temperature readout – Simultaneous display in °C or °F

Full reading displayed – No need to multiply the readout to obtain actual test values

Adjustable TDS factor – 0.4 to 1.0 gives better accuracy

Push-button calibration – Calibrate your tester more precisely than trimpot adjustment; no screwdrivers necessary

Hold function; Auto shutoff

Waterproof, dustproof housing – Meets IP67 ratings—plus, it floats!

Automatic temperature compensation (ATC) – Gives you accurate measurements even with fluctuating temperatures

TDSTestr 11+ features – Operate as either cup-style or dip-style tester for greater flexibility



Choose dip-style or cup-style electrodes

35662-10

35662-15

Conductivity



Calibration buttons tucked away in battery compartment to avoid accidental recalibration.



Plastic case protects Testr when not in use

Specifications

ISO9001:2008
CERTIFIED SUPPLIER

CE 1 year warranty

Model	TDSTestr 11 dual-range	TDSTestr 11+ multirange
Range	0 to 2000 ppm; 0 to 10.00 ppt	0 to 200 ppm, 0 to 2000 ppm; 0 to 10.00 ppt
Resolution	1 ppm; 0.01 ppt	0.1 ppm, 1 ppm; 0.01 ppt
Accuracy	±1% full-scale	±1% full-scale
Calibration standard range	300 to 1990 ppm; 3 to 10.00 ppt	20.0 to 199.9 ppm, 200 to 1999 ppm; 2.0 to 10.00 ppt
Calibration	2-point, manual	2-point, manual

Temperature display: 0 to 50°C (32 to 122°F), 0.1°C resolution, ±0.5°C accuracy
Operating temperature: 0 to 50°C (32 to 122°F)
Temperature compensation: automatic (ATC) from 0 to 50°C (32 to 122°F)
ATC coefficient: 2% per °C, 1.11% per °F, 25°C reference temperature
Wetted materials: 316 stainless steel (electrodes) and HDPE/Valox® housing

Power and battery life: four 1.5 V alkaline batteries Eveready A76BP (included), 100 hrs continuous use (approx 600 tests per battery pack). Alternate replacement model Eveready 357BP silver oxide, 140 hrs continuous use.

Dimensions
Unit only: 6½" L x 1½" dia (165 x 38 mm)
Boxed: 7¼" x 2¼" x 1½" (184 x 70 x 48 mm)

Weight
Unit only: 3.25 oz (90 g); **Boxed:** 6.0 oz (170 g)

Ordering Information

Catalog number	Description	Included
WD-35662-10	TDSTestr 11 dual-range	Tester, protective plastic storage case, lanyard, and batteries
WD-35662-15	TDSTestr 11+ multirange	

Accessories

WD-35661-17 Replacement electrode for TDSTestr 11

WD-35661-08 Replacement electrode for TDSTestr 11+

WD-35624-45 Vinyl carrying case with belt loop; holds one tester and solution pouches

WD-09377-16 Replacement batteries, 1.5 V. Pack of 6

WD-35661-70 Deluxe calibration kit includes two each calibration pouches (447 µS, 1413 µS, 2764 µS, 15,000 µS, and rinse water), sample jar, and foam-lined hard plastic carrying case. (Tester not included)

ECTestr® 11 Series

Auto-ranging for maximum resolution

Large, easy-to-read display – Two-line display—units, measurement status, and battery life indicators

±1% full-scale accuracy – The best in its class!

Waterproof, dustproof housing – Meets IP67 ratings, plus—it floats!

Replaceable electrode – Reuse same meter body over and over

Push-button calibration – Calibrate more precisely than trimpot adjustment—no screwdrivers needed

Hold function – Freezes reading until you can record it

Auto shutoff – Saves your batteries

Full reading displayed – No need to multiply the readout to obtain actual test values

Temperature readout – Dual display for readings at a glance; °C or °F selectable

Automatic temperature compensation (ATC) – Gives you accurate readings even with fluctuating temperatures

ECTester 11+ features – Operate as either cup-style or dip-style tester for greater flexibility



35662-30

Dip-style sensor—just immerse and read



35662-35

Cup-style sensor—draw or grab samples



Plastic case protects Testr when not in use.

Specifications



Model	ECTestr 11 dual-range	ECTestr 11+ multirange
Range	0 to 2000 µS; 0 to 20.00 mS	0 to 200.0 µS; 0 to 2000 µS; 0 to 20.00 mS
Resolution	10 µS; 0.10 mS	0.1 µS; 1 µS; 0.01 mS
Accuracy	±1% full-scale	±1% full-scale
Calibration standard range	300 to 1990 µS; 3 to 19.90 mS	20.0 to 199.9 µS; 200 to 199.9 µS; 2.0 to 19.99 mS
Calibration	2-point, manual or auto (1413 µS; 12.88 mS)	3-point, manual or auto (84 µS; 1413 µS; 12.88 mS)

Temperature display: 0 to 50°C (32 to 122°F), 0.1°C resolution, ±0.5°C accuracy

Operating temperature: 0 to 50°C (32 to 122°F)

Temperature compensation: automatic (ATC) from 0 to 50°C (32 to 122°F)

ATC coefficient temperature: 2% per °C, 25°C reference

Wetted materials: 316 stainless steel (electrodes) and Valox® housing

Power and battery life: four 1.5 V alkaline batteries Eveready A76 (included), 100 hrs continuous use (approx 600 tests per battery pack). Alternate replacement model LR44.

Dimensions

Unit only: 6½" L x 1½" dia (165 x 38 mm)

Boxed: 7¼" x 2¾" x 1¾" (184 x 70 x 48 mm)

Weight

Unit only: 3.25 oz (90 g); **Boxed:** 6.0 oz (170 g)

Ordering Information

Catalog number	Description	Included
WD-35662-30	ECTestr 11 dual-range	Tester, protective plastic storage case, lanyard, and batteries
WD-35662-35	ECTestr 11+ multirange	Tester, protective plastic storage case, lanyard, and batteries

Accessories

WD-35661-17 Replacement electrode for ECTestr 11

WD-35661-08 Replacement electrode for ECTestr 11+

WD-35624-45 Vinyl carrying case with belt loop; holds one tester and solution pouches

WD-09377-16 Replacement batteries, 1.5 V. Pack of 6

WD-35661-70 Deluxe calibration kit includes two each calibration pouches (447 µS, 1413 µS, 2764 µS, 15,000 µS, and rinse water), sample jar, and foam-lined hard plastic carrying case. (Tester not included)

SaltTestr® 11

Non-linear curve programmed for best results in testing NaCl in water applications

Factory calibrated against NaCl standards

– Ideal for testing salinity levels in pools

±1% full-scale accuracy – The best in its class!

Full reading displayed – No need to multiply the readout to obtain actual test values

Automatic temperature compensation (ATC)

– Gives you accurate measurements even in fluctuating temperatures

Waterproof, dustproof housing – Meets IP67 ratings, plus—it floats!

Replaceable electrode – Reuse same meter body over and over again

Push-button calibration – Calibrate more precisely than trimpot adjustment—no screwdrivers necessary

Hold function – Freezes reading until you can log it

Auto shutoff – Saves your batteries

Temperature display – Selectable for °C or °F

Conductivity



35662-52

ISO9001:2008
CERTIFIED SUPPLIER

CE 1 year warranty

Specifications

Model	SaltTestr 11
Range	0 to 10.00 ppt
Resolution	0.10 ppt
Accuracy	0.00 to 7.00 ppt: ±1% full-scale; above 7.00 ppt: ±3% full-scale
Calibration standard range	3 to 10.00 ppt*
Calibration	One point push-button calibration (using keys inside battery compartment)

*For best accuracy, calibrate to 4.4 ppt NaCl with standard 00653-89 (order on page 43).

Temperature display: 0 to 50°C (32 to 122°F), 0.1°C resolution, ±0.5°C accuracy

Operating temperature: 0 to 50°C; 32 to 122°F

Temperature compensation: automatic (ATC) from 0 to 50°C (32 to 122°F)

ATC coefficient: 2% per °C, 1.11% per °F, 25°C reference temperature

Wetted materials: 316 stainless steel (electrodes) and Valox® housing

Power and battery life: four 1.5 V alkaline batteries Eveready A76 (included), 150 hrs continuous use (approx 600 tests per battery pack). Alternate replacement model model LR44

Dimensions

Unit only: 6½" L x 1½" dia (165 x 38 mm)

Boxed: 7¼" x 2¾" x 1⅞" (184 x 70 x 48 mm)

Weight

Unit only: 3.25 oz (90 g); **Boxed:** 6.0 oz (170 g)



Calibration buttons tucked away in battery compartment to avoid accidental recalibration.



Plastic case protects Testr when not in use.

Ordering Information

Catalog number	Description	Included
WD-35662-52	SaltTestr 11	Tester, protective plastic storage case, lanyard, and batteries

Accessories

WD-35661-17 Replacement electrode for SaltTestr 11

WD-35624-45 Vinyl carrying case with belt loop; holds one tester and solution pouches

WD-35653-15 Salt standard pouches, 3000 ppm NaCl. Box of 20 pouches

WD-09377-16 Replacement batteries, 1.5 V. Pack of 6

WD-35661-70 Deluxe calibration kit includes two each calibration pouches (447 µS, 1413 µS, 2764 µS, 15,000 µS, and rinse water), sample jar, and foam-lined hard plastic carrying case. (Tester not included)

Conductivity/TDS Meter Selection Guide

Get Better Accuracy

Oakton conductivity/TDS meters offer accuracy up to ±1% full-scale. Autoranging function with one calibration point per range. Most meters feature adjustable temperature coefficients and TDS conversion factors to maximize measurement accuracy.

Offering selectable cell constant probes with temperature compensation (0.1 for pure water, 1.0 for general applications, and 10.0 for concentrated solutions) to meet application requirements (see page 43 for additional probe selection). Don't forget the Oakton NIST-traceable calibration solutions on page 43—calibration is a great way to ensure accuracy!

Get Dependability

Oakton conductivity/TDS meters are built to last and include a three-year warranty. The ASIC microprocessor technology offers trouble-free performance for years. ISO 9001:2008 certified company with CE mark products to ensure product excellence.

See page 43 to order conductivity/TDS cells and accessories.



Use this chart to find the best conductivity or TDS meter for your application

Meter	6+ series	Waterproof 150 series	Waterproof 450 series	Waterproof 600 series	Benchtop 700	Benchtop 2700
See pages	36 to 37	38	39	40	41	42
Description	Low cost, rugged, compact	Simple, rugged, and reliable	Best value, advanced features	Rugged field/ environmental meter	Basic features, benchtop	Advanced features, benchtop
Display	Single-line LCD	Three-line LCD	Three-line LCD with backlight	Multiline dot matrix with backlight	Large three-line LCD	Graphic display with backlight
IP67-rated housing	—	Yes	Yes	Yes	—	—
Memory	—	Up to 200 data sets	Up to 500 data sets	Up to 500 data sets	Up to 100 data sets	Up to 500 data sets
Communication	—	—	USB or RS-232	IrDA	—	RS-232
Real-time clock	—	Yes	Yes	Yes	Yes	Yes
Password protection	—	—	Yes	Yes	—	Yes
Calibration points	Up to 5; one per range	Up to 6; one per range	Up to 6; one per range	Up to 5; one per range	Up to 5; one per range	Up to 5; one per range
AutoCal with selectable points	Yes	Yes	Yes	Yes	Yes	Yes
Autorange	Yes	Yes	Yes	Yes	Yes	Yes
Automatic endpoint	—	—	Yes	Yes	Yes	Yes
Automatic shutoff	After 17 minutes	After 20 minutes	Yes, adjustable	Yes, adjustable	—	—
Hold function	Yes	Yes	Yes	Yes	Yes	Yes
Ready/stability indicator	—	Yes	Yes	Yes	Yes	Yes
Error messages	Yes	Yes	Yes	Yes	Yes	Yes
Built-in stand	Yes (in boot)	Yes	Yes	Yes	—	—
Protective rubber boot	Yes	—	—	Optional	—	—
AC power adapter	—	Optional	Optional	Optional	Yes	Yes

Conductivity

CON 6+ Meter

Variety of features at an economical price!

Wider measuring ranges – CON 6+ features five measuring ranges up to 200.0 mS

Automatic or manual ranging across five ranges – For a wide variety of applications from pure water to boiler blow-down water

Easy, push-button operation

Temperature readout and automatic temperature compensation (ATC) – For high accuracy in changing temperature conditions

Hold function; Auto-off function – Meters shut off after 20 minutes of nonuse

Automatic or manual calibration – For quick and easy calibrations, use automatic mode with preset calibration points at the most popular values. For more flexibility, calibrate in the manual mode and set your calibration point at any value. Five-point calibration.

Setup functions – Customize automatic temperature compensation and cell constant for better accuracy and precision

Includes fast-response probe – Easy to clean; 1.0 cell constant

Built-in stand for benchtop or long-term use

Protective rubber boot – Helps shield your meter from drops and dings



CON 6+

ISO9001:2008
REGISTERED QUALITY SYSTEM



3 year
warranty
meter only

Conductivity

Specifications

Model	CON 6+
Range (Resolution)	0 to 20.00 µS (0.01 µS), 0 to 200.0 µS (0.1 µS), 0 to 2000 µS (1 µS), 0 to 20.00 mS (0.01 mS), 0 to 200.0 mS (0.1 mS)
Accuracy	±1% full scale
Cell constant	0.1, 1, and 10 (selectable)
Calibration	Up to 5 points, one per band on conductivity range
Ranging	Automatic or manual (selectable)

Temperature range: -10.0 to 110.0°C
Temperature resolution/accuracy: 0.1°C/±0.5°C
Temperature compensation: automatic or manual from 0.0 to 50.0°C
Temperature coefficient: adjustable from 0 to 3% per °C
Normalization temperature: 20 or 25°C, selectable
Probe connection
 For conductivity: BNC
 For temperature: subminiature audio

Operating temperature: 0 to 50°C (32 to 122°F)
Power: four 1.5 V AAA batteries (included); approx 100 hours continuous use
Dimensions
Meter: 5½" x 2¾" x 1¼" (14 x 7 x 3.5 cm)
Probe: 5½" L x ¾" dia with 36" L cable (13 cm L x 1.6 cm dia with 91 cm L cable)
Boxed: 8¼" x 5½" x 3" (21 x 15 x 7.5 cm)
Weight
Meter: 0.9 lb (0.4 kg); **Boxed:** 1 lb (0.5 kg)



Meter includes built-in stand and protective rubber boot.

See page 43 to order conductivity solutions and accessories.

Ordering Information

Catalog number	Precalibrated catalog number	Description	Included
WD-35604-00	WD-35604-01	CON 6+ meter	Meter, conductivity probe (K = 1.0), protective rubber boot, and four AAA batteries
WD-35604-04	WD-35604-05	CON 6+ meter kit	Meter, conductivity probe (K = 1.0), calibration pouches, sample bottles, hard plastic carrying case, protective rubber boot, and four AAA batteries

WD-35606-53 Conductivity probe, K = 0.1
 WD-35606-55 Replacement conductivity probe, K = 1.0

WD-35606-57 Conductivity probe, K = 10
 WD-35632-97 Carrying case for 6+ meters. Includes rinse bottle and sample bottles

TDS 6+ and SALT 6+ Meters

Autoranging with temperature at economical price

Wider measuring ranges – TDS 6+ features five measuring ranges up to 200.0 ppt

Easy, push-button operation

Temperature readout and automatic temperature compensation (ATC) – For high accuracy in changing temperature conditions

Hold function; Auto-off function – Meters shut off after 20 minutes of nonuse

Automatic or manual calibration – For quick and easy calibrations, use automatic mode with preset calibration points at the most popular values. For more flexibility, calibrate in the manual mode and set your calibration point at any value.

Setup functions – Customize automatic temperature compensation, cell constant, and TDS conversion factor for better accuracy and faster use

Includes fast-response probe – Easy to clean; 1.0 cell constant

Built-in stand for benchtop or long-term use

Protective rubber boot – Helps shield your meter from drops and dings

TDS 6+ features

Automatic or manual ranging across five ranges – For a wide variety of applications from pure water to boiler blow down water

SALT 6+ features

Custom conductivity-to-TDS conversion curve – For the highest accuracy



Meters include built-in stand and protective rubber boot.

See page 43 to order conductivity solutions and accessories.



Conductivity

Specifications

ISO9001:2008 CERTIFIED SUPPLIER

CE 3 year warranty meter only

Model	TDS 6+	SALT 6+
Range/Resolution	0.00 to 10.00 ppm/0.01 ppm, 10.0 to 100.0 ppm/0.1 ppm, 100 to 1000 ppm/1 ppm, 1.00 to 10.00 ppt/0.01 ppt, 10.0 to 100.0 ppt/0.1 ppt, up to 200.0 ppt*	1 to 50.0 ppt/0.1 ppt, 0.1 to 5.00%/0.01%
Accuracy	±1% full-scale	±1% full-scale
Cell constant	0.1, 1, and 10 (selectable)	1.0
Conductivity-to-TDS/ Saline conversion factor	0.4 to 1.00 adjustable	Nonlinear compensation
Calibration	Up to 5 points, one per band on conductivity range	One point in 1 to 50 ppt range
Ranging	Automatic or manual (selectable)	—

*Depending on TDS factor setting.

Temperature range: -10.0 to 110.0°C

Temperature resolution/accuracy: 0.1°C/±0.5°C

Temperature compensation: automatic or manual from 0.0 to 50.0°C

Temperature coefficient: adjustable: 0 to 3% per °C

Normalization temperature: 20 or 25°C, selectable

Probe connection

For conductivity, TDS, and SALT: BNC
For temperature: subminiature audio

Operating temperature: 0 to 50°C (32 to 122°F)

Power: four 1.5 V AAA batteries (included), approx 100 hours continuous use

Dimensions

Meter: 5½" x 2¾" x 1¼" (14 x 7 x 3.5 cm)

Probe: 5½" L x 5/8" dia with 36" L cable (13 cm L x 1.6 cm dia with 91 cm L cable)

Boxed: 8¼" x 5½" x 3" (21 x 15 x 7.5 cm)

Weight

Meter: 0.9 lb (0.4 kg); **Boxed:** 1 lb (0.5 kg)

Ordering Information

Catalog number	Precalibrated catalog number	Description	Included
WD-35604-20	WD-35604-21	TDS 6+ meter	Meter, conductivity probe (cell constant K = 1.0), protective rubber boot, and batteries
WD-35604-24	WD-35604-25	TDS 6+ meter kit	Meter, conductivity probe (cell constant K = 1.0) calibration pouches, sample bottles, hard plastic carrying case, protective rubber boot, and four AAA batteries
WD-35604-40	WD-35604-41	SALT 6+ meter	Meter, conductivity probe (cell constant K = 1.0), protective rubber boot, and batteries
WD-35604-44	WD-35604-45	SALT 6+ meter kit	Meter, conductivity probe (cell constant K = 1.0) calibration pouches, sample bottles, hard plastic carrying case, protective rubber boot, and four AAA batteries

WD-35606-53 Conductivity probe, K = 0.1

WD-35606-55 Replacement conductivity probe, K = 1.0

WD-35606-57 Conductivity probe, K = 10

WD-35632-97 Carrying case for 6+ meters. Includes rinse bottle and sample bottles.

CON 150 Meter

Best value for an IP67-rated waterproof meter!

Large, three-line LCD – Lets you view conductivity or TDS measurement with temperature

Built-in memory function – Stores up to 150 measurements along with temperature

Autoranging across five ranges – For fast response and best resolution over a wide range

Auto-cal features one calibration point per each conductivity range – Provides ±1% full-scale accuracy

Calibration alarm – A visible reminder when it is time to recalibrate the meter

Select a probe with a 0.1, 1.0, or 10 cell constant

Adjustable conductivity-to-TDS conversion factor – Adjust from 0.4 to 1.0

Selectable manual or automatic temperature compensation (ATC) – For the highest accuracy in any situation

Selectable °C/°F – Choose units to best fit your application

Hold function, Ready indicator, automatic shut-off, and battery life indicator

Intuitive user-friendly icons – Probe status displays cell constant

Built-in stand – Ideal for easy benchtop or long-term use

Wall mount option – Ideal to save bench space

Grip-Clip™ holder quickly and easily secures the probe to your beaker or container

Power with batteries continuously for 700 hours in the field – Optional AC adapter for benchtop measurements

New



35607-32



Specifications

Mode	Conductivity	TDS	Temperature
Range	0 to 200 mS	0 to 200 ppt	-10.0 to 110.0°C (-17.0 to 230.0°F)
Resolution	0.01 uS to 0.1 mS	0.01 ppm to 0.1 ppt	0.1°C/°F
Accuracy	±1% full-scale	±1% full-scale	±0.5°C; ±0.9°F
Calibration	Auto/manual; 1 point/range	Auto/manual; 1 point/range	Offset 0.1 increments



Built-in meter stand

Display: 3-line custom LCD

Memory: stores up to 150 data sets

Temperature compensation: automatic or manual from -10 to 110°C

Temperature coefficient: 0.0 to 10.0%/°C

Power: two AA batteries (included), >700 hours continuous use; AC adapter (optional)

Dimensions (L x W x H)

Boxed: 9 1/8" x 9 1/8" x 2 3/4" (23 x 23 x 7 cm)

Meter: 7 1/2" x 3 1/8" x 2 1/4" (20 x 8.3 x 5.7 cm)

Weight:

Meter: 1 lb (0.5 kg)

Boxed: 1.4 lb (0.7 kg)

Ordering Information

Catalog number	Precalibrated catalog number	Description	Included
WD-35607-32	WD-35607-34	CON 150 meter with probe	Meter, conductivity cell 35608-50, Grip-Clip holder, and two AA batteries
WD-35607-90	WD-35607-91	CON 150 meter kit	Meter, conductivity cell 35608-50, Grip-Clip holder, calibration solution, two AA batteries, and hard carrying case

Accessories

WD-35608-55 Conductivity cell, K = 0.1

WD-35608-50 Replacement conductivity cell, K = 1.0

WD-35608-51 Conductivity cell, K = 10

WD-35614-50 Replacement Grip-Clip holder attaches probe to side of container for measurement

WD-35614-51 Hard carrying case, fits all 150/450 meter configurations

WD-35420-72 Optional adapter, 110/220 VAC

WD-09376-01 Replacement batteries, AA. Pack of 4

CON 450 Meter

Backlit, rugged waterproof meter is ideal for any environment!

Durable waterproof and dustproof design with IP67 rating

Large, backlit custom display—Lets you view measurement with temperature and calibration data with cell constant

Measurement in conductivity, TDS, and salinity—With automatic and manual temperature compensation

Autorange conductivity from 0 to 199.9 mS in five ranges—Automatic calibration up to five calibration points

Selectable cell constant—0.10, 1.00, or 10.0 from a two-cell probe

Selectable temperature coefficient—Adjustable from 0 to 10% per °C for accurate compensation of almost any solution

Adjustable conductivity-to-TDS factor— Adjust from 0.4 to 1.0

Selectable °C/°F—Choose units to best fit your application

Intuitive user-friendly icons—Probe status displays cell constant

Hold, Ready, and automatic shutoff functions

Store up to 500 data sets—Easy USB or RS-232 output with optional data cable

Built-in real-time clock stamps stored data and calibration data with time and date—Meets standards for GLP (Good Laboratory Practices)

Built-in stand with wall mount—Allows for easy benchtop measurement or storage

Grip-Clip™ holder—Quickly and easily secures the probe to your beaker or container

500 hours battery life or use optional universal power adapter

New



CON 450



Built-in meter stand for hands-free operation

Conductivity

Specifications

Mode	Conductivity	TDS	Salinity	Temperature
Range	0 to 200 mS	0 to 200 ppt	0 to 50 ppt	-10.0 to 110.0°C (-17.0 to 230.0°F)
Resolution	0.01 µS to 0.1 mS	0.01 ppm to 0.1 ppt	0.01	0.1°C/°F
Accuracy	±1% full-scale	±1% full-scale	±1% full-scale	±0.5°C; ±0.9°F
Calibration	Auto/manual; one point per range	Auto/manual; one point per range	Auto/manual; one point per range	±5.0° offset

Display: graphic LCD with backlight

Memory: stores up to 500 data sets

Output: USB or RS-232

Real-time clock: time-and-date stamp on calibration and stored data

Temperature compensation: automatic or manual from -10 to 110°C

Power: two AA batteries (included), 500 hours (without backlight); AC adapter (optional)

Dimensions (L x W x H)

Meter: 7¹/₈" x 3¹/₈" x 2¹/₄" (20 x 8.3 x 5.7 cm)

Boxed: 9¹/₈" x 9¹/₈" x 2³/₄" (23 x 23 x 7 cm)

Weight

Meter: 1 lb (0.5 kg);

Boxed: 1.4 lb (0.7 kg)



3 year warranty
meter only

Ordering Information

Catalog number	Pre-calibrated catalog number	Description	Included
WD-35608-32	WD-35608-34	CON 450 meter with probe	Meter, conductivity cell (K = 1.0) 35608-50, Grip-Clip holder, and two AA batteries
WD-35608-80	WD-35608-81	CON 450 meter kit	Meter, conductivity cell (K = 1.0) 35608-50, calibration solutions, Grip-Clip holder, two AA batteries, and hard carrying case

Accessories

WD-35608-55 Conductivity cell, K = 0.1

WD-35608-50 Replacement conductivity cell, K = 1.0

WD-35608-51 Conductivity cell, K = 10

WD-35614-50 Replacement Grip-Clip electrode holder

WD-35630-53 Data cable for USB connectivity

WD-35420-01 Data cable for RS-232 connectivity

WD-35614-51 Hard carrying case, fits all 150/450 meter configurations

WD-35420-72 Optional adapter, 110/220 VAC

WD-09376-01 Replacement batteries, AA. Pack of 4

CON 600 and CON 610 Meters

Conductivity, TDS, resistivity, salinity—
measure from pure water to seawater!

Conductivity

Durable waterproof and dustproof design with IP67 rating – Even with no probes attached

Single or multipoint calibration; auto or manual – Fast, trouble-free calibration for more accurate measurements

Large backlit graphic display – Multi-line display with electrode status indicator, calibration data, and more

User-settable “calibration due” alarm – Out-of-date or unperformed calibrations are now things of the past!

Built-in real-time clock – Time-and-date stamping meets Good Laboratory Practice (GLP) standards

Advanced data management – Store up to 500 data sets and download via Infrared IrDA wireless interface

Set point alarms – Audible warning when readings are outside set points limit

Accept 2-cell and 4-cell conductivity probes – Measure over a broad conductivity range up to 500 mS/cm

Password protection – Security for calibration and setup menus

Rugged rubber boot – Protects meter from bumps and dings (optional; included with kits)



Rubber boot protects meter in rugged environments



35408-12

ISO9001:2008

CE 3 year warranty meter only

Specifications

Model	CON 600 meter	CON 610 meter
Conductivity	0 to 200.0 mS	0 to 500.0 mS
TDS	0 to 200 ppt	0 to 500 ppt
Salinity	—	0 to 80 ppt
Resistivity	—	0 to 20.00 MΩ
Temperature	-10.0 to 110.0°C (14.0 to 230.0°F)	-10.0 to 110.0°C (14.0 to 230.0°F)
Resolution	0.05% full-scale; 0.1°C (0.1°F)	
Accuracy	±1% full-scale; ±0.5°C (±0.9°F)	
Calibration	Manual cal, up to 5 points (1 per range); automatic up to 4 points (84.0 μS/cm, 1413 μS/cm, 12.88 mS/cm, 111.8 mS/cm). Temperature offset 0.1°C (0.1°F) increments.	

TDS factor: 0.40 to 1.00

Cell constant: 0.010 to 10.000

Memory: up to 500 sets with GLP date and time

Output: infrared, IrDA

Real-time clock: time-and-date stamp on calibration and stored data

Temperature normalization: 15 or 30°C

Temperature coefficient: linear or pure (610 only)

Temperature compensation: automatic or manual (selectable) from 0 to 100°C

Ambient operating temperature: 0 to 50°C (32 to 122°F)

Power: four 1.5 V AA batteries (included) or optional universal AC adapter, up to 200 hours continuous use

Dimensions

Meter: 7¼" L x 3¼" W x 2¼" H (18.4 x 8.3 x 5.7 cm)

Boxed: 9½" L x 9¼" W x 2¾" H (23 x 23 x 7 cm)

Weight

Meter: 1 lb (0.5 kg);

Boxed: 2 lb (0.9 kg)



Meter kit saves you money!

Multiparameter 650-Series meters are available. See pages 54–57.

Ordering Information

Catalog number	Precalibrated catalog number	Description	Included
WD-35408-02	WD-35408-03	CON 600 meter only	Meter and batteries
WD-35408-12	WD-35408-13	CON 610 meter only	Meter and batteries
WD-35408-00	WD-35408-01	CON 600 meter	Meter, conductivity cell 35408-52, and batteries
WD-35408-10	WD-35408-11	CON 610 meter	Meter, conductivity cell 35408-52, and batteries
WD-35408-70	WD-35408-71	CON 600 meter kit	Meter, conductivity cell 35408-52, conductivity standards (60 mL each of four solutions; 1413 μS, 12.88 mS, 3000 ppm, and rinse water), rubber boot, electrode holder, batteries, and hard carrying case
WD-35408-80	WD-35408-81	CON 610 meter kit	Meter, conductivity cell 35408-52, conductivity standards (60 mL each of four solutions; 1413 μS, 12.88 mS, 3000 ppm, and rinse water), rubber boot, electrode holder, batteries, and hard carrying case

WD-35408-50 Conductivity cell, 2-electrode, K = 0.1

WD-35408-52 Conductivity cell, 2-electrode, K = 1

WD-35408-54 Conductivity cell, 2-electrode, K = 10

WD-35408-56 Conductivity cell, 4-electrode, K = 0.3

WD-35418-83 Optional adapter, 110/220 VAC

WD-35418-86 Protective rubber boot for all 600- and 610- series meters

CON 700 Meter

An affordable way to take consistent, accurate conductivity measurements in your laboratory!

Extra-large dual display shows both conductivity or TDS, and temperature in °C or °F – Plus mode indicators and annunciators to indicate meter status

Compact size saves bench space

Single- and multi-point automatic or manual calibration – Customize meter calibration for quick checks or for best meter accuracy

Auto ranging across five ranges – Offers the best resolution for your measurements

Advanced setup mode – Recalls previous calibration data, conductivity/TDS effective cell constants per range, and more

Built-in nonvolatile memory – Stores up to 100 conductivity or TDS readings with corresponding temperature

Automatic or manual temperature compensation

Selectable cell constant –

K = 0.1 for pure water;
K = 1.0 for most applications;
K = 10 for concentrated solutions

Adjustable conductivity-to-TDS conversion factor and temperature coefficient – Gives highest accuracy in any solution

Selectable normalization temperature – Choose between 15 to 30°C

Removable electrode holder arm; selectable "Ready" indicator; Hold function; diagnostic error messages

Includes conductivity cell – With cell constant of 1.0—ideal for most applications



CON 700 meter includes electrode holder and handy slide-out instruction card.

Conductivity

Specifications

ISO 9001:2008 CERTIFIED SUPPLIER

CE

3 year warranty meter only

Mode	Conductivity	TDS	Temperature
Ranges (Resolution)	0.00 to 20.00 μ S (0.01 μ S), 0.0 to 200.0 μ S (0.1 μ S), 0 to 2000 μ S (1 μ S), 0.00 to 20.00 mS (0.01 mS), 0.0 to 200.0 mS (0.1 mS)	0.00 to 10.00 ppm (0.01 ppm), 10.0 to 100.0 ppm (0.1 ppm), 100 to 1000 ppm (1 ppm), 1.00 to 10.00 ppt (0.01 ppt), 10.0 to 100.0 ppt (0.1 ppt), 100 to 200 ppt (1 ppt)*	0.0 to 100.0°C (0.1°C), 32.0 to 212.0°F (0.1°F)
Accuracy	±1% full-scale or ±1 digit		±0.5°C, ±0.9°F
Calibration	Automatic: single or multi-point up to 4 points (84 μ S, 1413 μ S, 12.88 mS, 111.8 mS); Manual: single or multi-point (up to 5 points per range for multi-point calibration)		Offset 0.1° increments up to ±5°

*200 ppt @ 1.0 factor

Cell constant (K): 0.1, 1.0, or 10 (selectable)

Temperature compensation: automatic or manual (selectable) from 32 to 212°F (0 to 100°C)

Temperature coefficient: adjustable from 0 to 10% per °C or °F

Conductivity-to-TDS factor: adjustable from 0.40 to 1.00

Normalization temperature: 15 to 30°C (adjustable)

Memory: 100 sets

Display: dual display of conductivity or TDS, with temperature (°C or °F)

Operating temperature: 0 to 50°C (32 to 122°F)

Power: 500 mA; 100/240 VAC, 50/60 Hz using AC adapter (included). AC adapter is UL and CSA listed.

Dimensions

Meter: 6 $\frac{1}{8}$ " x 6 $\frac{7}{8}$ " x 2 $\frac{3}{4}$ " (15.5 x 17.5 x 6.9 cm)

Boxed: 9" x 12 $\frac{3}{4}$ " x 5" (23 x 35 x 12.5 cm)

Weight

Meter only: 1.25 lb (0.6 kg); **Boxed:** 3 lb (1.4 kg)

Ordering Information

Catalog number	Pre-calibrated catalog number	Description	Included
WD-35411-00	WD-35411-01	CON 700 meter	Meter, conductivity cell with an Ultem® body/stainless steel sensor K = 1.0 (35608-74), electrode holder, and AC adapter

WD-35608-72 Conductivity cell, epoxy body, platinum sensor, built-in temperature sensor (K = 0.1). 3-ft (1-m) cable

WD-35608-74 Replacement conductivity cell, Ultem body, stainless steel sensor, built-in temperature sensor (K = 1.0). 3-ft (1-m) cable

WD-35608-76 Conductivity cell, epoxy body, platinum sensor, built-in temperature sensor (K = 1.0). 3-ft (1-m) cable

WD-35608-78 Conductivity cell, epoxy body, platinum sensor, built-in temperature sensor (K = 10). 3-ft (1-m) cable

WD-35420-54 Replacement electrode holder arm

WD-35420-72 Replacement universal adapter



A wide range of conductivity cells and calibration solutions are available. See page 43 to order.

Conductivity — Benchtop Meters

CON 2700 Meter

A great low price for a high performance meter that measures conductivity, total dissolved solids, resistivity, and salinity!

Conductivity

Takes up less bench space – Overall footprint is nearly 40% smaller than other benchtop meters

Oversized liquid crystal display with bright backlighting – Easier viewing under all lighting conditions

Dynamic reading stability indication shows when your measurement is stable – Eliminates guesswork from unstable readings

Up to 500 point nonvolatile memory with time-and-date stamp – Meets GLP requirements

Bidirectional RS-232 for easy data transfer to your computer

Includes a high-performance 4-cell conductivity probe! – Higher accuracy across a broader range of samples

Auto-calibration makes calibration easier – Meter automatically selects a conductivity calibration standard value based on the range and normalization temperature being used

Auto-standardization – detects the exact cell constant of your electrode

Probe status – Indicates when probe maintenance or replacement should be done

Cal-due alarm – no more out-of-date calibrations

User-settable limit alarms – alerts when reading falls out of range

Password protection – prevents unauthorized setup or calibration



Software included

See page 43 for conductivity probes and calibration standards.

ISO 9001:2008 CERTIFIED SUPPLIER CE 3 year warranty meter only

Specifications

Mode	Conductivity	TDS	Salinity	Resistivity	Temperature
Range	0.050 μ S/cm to 500.0 mS/cm (5-range autoranging)	0.050 to 500.0 ppt	0.0 to 80.0 ppt	2.000 Ω to 20.0 M Ω	0.0 to 100.0°C (32.0 to 212°F)
Resolution	0.01, 0.1 μ S/cm, 0.001, 0.01, 0.1 mS/cm	0.01, 0.1 ppm, 0.001, 0.01, 0.1 ppt	0.01, 0.1 ppm; 0.001, 0.01, 0.1 ppt	0.01/0.1 Ω , 0.01/0.1 k Ω , 0.01 M Ω	0.1°C or °F
Accuracy	± 1% full scale	± 1% full scale	± 1% full scale	± 1% full scale	±0.3°C (±0.5°F)
Calibration	5 points (one point per range)	5 points (one point per range)	5 points (one point per range)	5 points (one point per range)	Offset in 0.1 increments, ±5°C (±9°F)
Connectors	8-pin DIN	8-pin DIN	8-pin DIN	8-pin DIN	8-pin DIN

Temperature compensation: manual or automatic from -5°C to 105°C

Conductivity temp coefficient: adjustable from 0.0 to 10% per °C/°F

Conductivity cell constant: 0.01 to 10.000

Conductivity-to-TDS factor: adjustable from 0.4 to 1.0

Normalization temperature: adjustable from 15 to 30°C

Memory: up to 500 data sets

Output: RS-232, 9-pin female

Display: 3/4" x 2 7/16" (8.3 x 6.2 cm) graphic LCD with backlight

Operating temperature: 41 to 113°F, noncondensing

Power: universal 110/240 VAC with adapters; UL/CSA listed

Dimensions

Meter: 6 1/8" x 6 7/8" x 2 3/4" (15.5 x 17.5 x 6.9 cm)

Boxed: 12" x 9" x 5" (30.8 x 15.5 x 12.4 cm)

Weight

Meter only: 1.4 lbs (650 g); **Boxed:** 4 lbs (1800 g)



Unstable reading



Stable reading

Ordering Information

Catalog number	Precalibrated catalog number	Description	Included
WD-35412-00	WD-35412-01	CON 2700 meter	Meter, 4-cell conductivity/temperature probe 35412-10, electrode holder, and universal 110/240 VAC power supply

WD-35412-10 Replacement conductivity/temperature probe for 2700-series meter; 4-cell, K= 1.0 epoxy/graphite

WD-35420-01 RS-232 cable

WD-35630-53 Data cable for USB connectivity

Probes and Calibration Solutions

Conductivity/TDS Probes

Choose from three cell constants

All probes feature built-in temperature compensation. A 1.0 cell constant (K) is ideal for midrange conductivity measurements. For high conductivity measurements (near or above 20 mS), order a probe with K = 10.0; for low conductivity measurements (near or below 20 μ S), order a probe with K = 0.1.



A B C

Ordering Information

Catalog number	Body/sensor material	Cell constant (K)	Temperature range	Cable length	Probe style
Probes for use with CON 6/6+, TDS 6/6+, and SALT 6/6+					
WD-35606-53	Epoxy/platinum	0.1	0 to 80°C	3 ft (1 m)	A
WD-35606-55	Ultem/stainless steel	1.0	0 to 80°C	3 ft (1 m)	C
WD-35606-57	Epoxy/platinum	10	0 to 80°C	3 ft (1 m)	A
Probes for use with CON 11, CON 110, CON 150, pH/CON 300, CON 400, TDS 400, CON 410, CON 450, and pH/CON 510					
WD-35608-50	Ultem/stainless steel	1.0	0 to 80°C	3 ft (1 m)	C
WD-35608-57	Ultem/stainless steel	1.0	0 to 80°C	10 ft (3 m)	C
WD-35607-58	Epoxy/platinum	1.0	0 to 80°C	3 ft (1 m)	A
WD-35608-51	Epoxy/platinum	10	0 to 80°C	3 ft (1 m)	A
WD-35608-52	Glass/platinum	1.0	0 to 100°C	3 ft (1 m)	B
WD-35608-55	Epoxy/platinum	0.1	0 to 80°C	3 ft (1 m)	A
Probes for use with CON 600, CON 610, PC 650, CD 650, and PCD 650					
WD-35408-50	Epoxy/graphite	0.1	0 to 80°C	3 ft (1 m)	A
WD-35408-52	Ultem/stainless steel	1.0	0 to 80°C	3 ft (1 m)	C
WD-35408-57	Ultem/stainless steel	1.0	0 to 80°C	6 ft (2 m)	C
WD-35408-54	Epoxy/graphite	10	0 to 80°C	3 ft (1 m)	A
WD-35408-56	Epoxy, 4-cell/graphite	0.3	0 to 80°C	3 ft (1 m)	A
2-cell conductivity probes for use with CON 700/2700 and PC 700/2700					
WD-35608-72	Epoxy/platinum	0.1	0 to 80°C	3 ft (1 m)	A
WD-35608-74	Ultem/stainless steel	1.0	0 to 80°C	3 ft (1 m)	C
WD-35608-76	Epoxy/platinum	1.0	0 to 80°C	3 ft (1 m)	A
WD-35608-78	Epoxy/platinum	10	0 to 80°C	3 ft (1 m)	A
4-cell conductivity probes for use with CON 2700 and PC 2700					
WD-35608-90	Epoxy/platinum	0.1	0 to 80°C	3 ft (1 m)	A
WD-35412-10	Epoxy/graphite	0.5	0 to 100°C	3 ft (1 m)	A
WD-35608-92	Epoxy/platinum	1.0	0 to 80°C	3 ft (1 m)	A
WD-35608-94	Epoxy/platinum	10	0 to 80°C	3 ft (1 m)	A

Conductivity/TDS Calibration Pouches

Standardized against NIST-traceable reference for accuracy

Conductivity/TDS pouches are convenient, individually sealed pouches that contain high-precision calibration standards. Ideal for field calibration; just select the pouches you need and carry them to your test site for on-the-spot calibration and verification. Pouches are labeled with equivalent values for KCl, NaCl, and 442 and conductivity values. Each box contains twenty 20-mL pouches.



Ordering Information

Catalog number	Conductivity value	Conductivity-to-TDS calibration values		
		ppm KCl	ppm NaCl	ppm 442
WD-35653-09	10 μ S	4.7	4.8	7.0
WD-35653-10	447 μ S	225.6	215.5	300.0
WD-35653-11	1413 μ S	744.7	702.1	1000
WD-35653-12	2764 μ S	1382	1414.8	2062.7
WD-35653-13	15,000 μ S	8759	8532	13,455
WD-35653-15	5,650 μ S	3240	3000	—

WD-35653-00 Deionized rinse water pouches, 20 pouches/box

Conductivity/TDS Calibration Solutions

Standardized against NIST-traceable references to ensure quality

Conductivity/TDS calibration solutions are cross checked using different test methods, premixed, and ready to use.



Ordering Information

Catalog number	Conductivity value	Conductivity-to-TDS calibration values		
		ppm KCl	ppm NaCl	ppm 442
WD-00653-23	23 μ S	11.6	10.7	14.74
WD-00653-16	84 μ S	40.38	38.04	50.50
WD-00653-47	447 μ S	225.6	215.5	300.0
WD-00653-18	1413 μ S	744.7	702.1	1000
WD-00653-15	1500 μ S	757.1	737.1	1050
WD-00653-27	2070 μ S	1045	1041	1500
WD-00653-20	2764 μ S	1382	1414.8	2062.7
WD-00653-89	8974 μ S	5101	4487	7608
WD-00606-10	12,880 μ S	7447	7230	11,367
WD-00653-50	15,000 μ S	8759	8532	13,455
WD-00653-32	80 mS	52,168	48,384	79,688

Dissolved Oxygen Meter Selection Guide

Get Better Accuracy

Oakton dissolved oxygen meters offer accuracy up to $\pm 1.5\%$ full-scale. All meters feature temperature, pressure, and salinity correction for best measurement accuracy. Choose the probe technology best suited to your application.

- **Optical probe (RDO)** featured on the 450 series offers the advantages of galvanic probes, but requires no membrane or solution maintenance.
- **Galvanic probes** featured on the 6+, 600, and 700 series offer low drift for better accuracy while eliminating warm-up time.
- **Polarographic probe** featured on the 2700 series is ideal for benchtop BOD laboratory testing.

Get Dependability

Oakton dissolved oxygen meters are built to last and include a three-year warranty. The ASIC microprocessor technology offers trouble-free performance for years. ISO 9001:2008 certified company with CE mark product to ensure product excellence.

See page 50 to order replacement DO probes and accessories.



Dissolved Oxygen

Use this handy comparison chart to help select the dissolved oxygen meter right for your application.

Meter	6+ series	Waterproof 450 series	Waterproof 600 series	Benchtop 700	Benchtop 2700
See pages	45	46	47	48	49
Description	Low cost, rugged, compact	Best value, advanced features	Rugged field/ environmental meter	Basic DO benchtop meter	Advanced DO/BOD benchtop meter
Display	Single-line LCD	Three-line LCD with backlight	Multiline dot matrix with backlight	Large three-line LCD	Graphic display with backlight
IP67-rated housing	—	Yes	Yes	—	—
Memory	—	Up to 500 data sets	Up to 500 data sets	Up to 100 data sets	Up to 500 data sets
Communication	—	USB or RS-232	IrDA	—	RS-232
Password protection	—	Yes	Yes	—	Yes
Real-time clock	—	Yes	Yes	Yes	Yes
Probe technology	Galvanic	Optical DO	Galvanic	Galvanic	Polarographic
DO accuracy	$\pm 1.5\%$ full-scale	$\pm 1.5\%$ full-scale	$\pm 1.5\%$ full-scale	$\pm 0.5\%$ full-scale	$\pm 0.5\%$ full-scale
Pressure correction	Manual	Automatic	Automatic	Automatic	Automatic
Salinity correction	Manual	Manual	Manual	Manual	Manual
Automatic shutoff	After 17 minutes	Yes, adjustable	Yes, adjustable	—	—
Hold function	Yes	Yes	Yes	Yes	Yes
Ready/stability indicator	—	Yes	Yes	Yes	Yes
Built-in stand	Yes (in boot)	Yes	Yes	—	—
Protective rubber boot	Yes	—	Optional	—	—
AC power adapter	—	Optional	Optional	Yes	Yes

DO 6+ Meter

**Compact and economical—
rugged rubber boot protects meter**

No meter warm-up required – Galvanic probe design lets you take measurements immediately without the typical 15-minute wait!

Easy-to-service, low-maintenance probe – Replaceable membrane cap assembly makes probe maintenance hassle-free! Simply fill cap with electrolyte solution and screw on.

Key in salinity and pressure values manually – Meter then calculates the offset value for increased accuracy

Independent 100% and zero adjustment calibrations – Gives meter high accuracy across entire measuring range

Offset adjustment capabilities – Calibrate your meter to a known work standard or titrimetrically determined value

Displays electrode diagnostics – Gives slope, zero offset, and millivolt values to help determine when you need to service or replace electrode

Easily toggle from mg/L (ppm) or % saturation to temperature mode

Built-in stand for benchtop or long-term use

Protective rubber boot – Helps shield your meter from drops and dings



35643-12

ISO9001:2008
CERTIFIED SUPPLIER



3 year
warranty
meter only

Dissolved Oxygen

Specifications

Mode	mg/L (ppm)	% Saturation	Temperature
Range	0.00 to 20.00 mg/L (ppm)	0.0 to 200.0%	-5.0 to 105.0°C
Resolution	0.01 mg/L (ppm)	0.1%	0.1°C
Accuracy	±1.5% full-scale	±1.5% full-scale	±0.5°C

Temperature compensation: automatic from 0 to 50°C

Salinity correction

Range: 0.0 to 50.0 ppt
Resolution: 0.1 ppt
Method: key in manually for meter calculated correction

Barometric pressure correction

Range: 500 to 1499 mm Hg
Resolution: 1 mm Hg
Method: key in manually for meter calculated correction

Probe: galvanic

Memory: none

Operating temperature: 0 to 50°C (32 to 122°F)

Power: four 1.5 V AAA batteries (included), >700 hrs continuous use

Dimensions

Meter: 5½"L x 2¼"W x 1¼"H (14 x 7 x 3.5 cm)

Boxed: 8¼"L x 5¼"W x 3"H (21 x 15 x 7.5 cm)

Probe: 5"L x ½" dia (11.5 cm L x 1.2 cm dia)

Weight

Meter: 1 lb (0.5 kg); **Boxed:** 1.4 lb (0.6 kg)



Meter includes a protective rubber boot and a built-in stand.

See page 50 to order replacement DO probes and accessories.

Ordering Information

Catalog number	Precalibrated catalog number	Description	Included
WD-35643-10	WD-35643-11	DO 6+ meter only	Meter and batteries
WD-35643-12	WD-35643-13	DO 6+ meter	Meter, DO probe 35642-50 with 3-ft (1-m) cable, electrolyte solution, replacement membrane cap, and batteries
WD-35643-14	WD-35643-15	DO 6+ meter kit	Meter, DO probe 35642-50 with 3-ft (1-m) cable, electrolyte solution, two replacement membrane caps, sample bottles, hard carrying case with space for meter and probe, and batteries

Accessories

WD-35642-50 Replacement DO probe with 3-ft (0.9-m) cable

WD-35642-55 Maintenance kit includes replacement membrane cap and 10 mL of electrolyte solution

WD-35640-71 Replacement electrolyte, premixed 500-mL bottle

RDO 450 Meter

Affordable optical RDO technology reduces maintenance time and costs

New

Durable waterproof and dustproof design with IP67 rating
Large, backlit custom display provides measurement with temperature

Switch between mg/L (ppm) and % saturation dissolved oxygen with a press of a button

Eliminate costly, tiresome membranes and solution

Manual barometric pressure and salinity corrections

Automatic or manual temperature compensation –

For the highest accuracy in any situation

Selectable °C or °F –

Choose the unit to best fit your application

Hold, ready, low-battery indicator, and automatic shutoff functions

Store up to 500 data sets – Easy USB or RS-232 output with optional data cables

Built-in real-time clock stamps stored data and calibration data with time and date – Meets standards for GLP

(Good Laboratory Practices)

Built-in stand with wall mount – Allows for easy benchtop measurement and storage

500 hours battery life or use optional universal power adapter



35640-30

ISO9001:2008
CERTIFIED SUPPLIER

TUV GS

CE 3 year warranty
meter only

Dissolved Oxygen



Meter kit saves you money!

Specifications

Mode	mg/L (ppm)	% Saturation	Temperature
Range	0 to 20 mg/L (ppm)	0 to 200%	-10.0 to 110.0°C (-17.0 to 230.0°F)
Resolution	0.1 mg/L (ppm)	0.10%	0.1°C/°F
Accuracy	±2%	±2%	±0.5°C (±0.9°F)

Temperature compensation: automatic or manual from -10 to 110°C

Probe: optical RDO

Memory: up to 500 data sets

Output: USB or RS-232

Real-time clock: time-and-date stamp on calibration and stored data

Display: custom LCD with backlight

Power: two AA batteries (included), 500 hours (without backlight); AC adapter (optional)

Dimensions (L x W x H)

Meter: 7¹/₈" x 3¹/₈" x 2¹/₄" (20 x 8.3 x 5.7 cm)

Boxed: 9¹/₈" x 9¹/₈" x 2³/₄" (23 x 23 x 7 cm)

Weight:

Meter: 1 lb (0.5 kg)

Boxed: 1.4 lb (0.7 kg)

Ordering Information

Catalog number	Precalibrated catalog number	Description	Included
WD-35640-32	WD-35640-34	RDO 450 meter only	Meter and two AA batteries
WD-35640-30	WD-35640-31	RDO 450 meter with probe	Meter, RDO probe, sensor cap, and two AA batteries
WD-35640-90	WD-35640-91	RDO 450 meter kit	Meter, RDO probe, sensor cap, RDO weight, calibration tube, two AA batteries, and hard carrying case

Accessories

WD-35640-51 Replacement RDO sensor cap

WD-35640-53 Replacement RDO probe, 10-ft (3-m) cable

WD-35640-55 RDO probe, 20-ft (6-m) cable

WD-35640-57 RDO probe, 50-ft (15-m) cable

WD-35640-59 RDO weight, screw thread to attach to probe

WD-35640-58 RDO calibration chamber

WD-35630-53 Data cable from meter to USB port

WD-35420-01 Data cable from meter to RS-232 port

WD-35614-51 Hard carrying case, fits all 150/450 meter configurations

WD-35420-72 Optional adapter, 110/220 VAC

WD-09376-01 Replacement batteries, AA. Pack of 4

DO 600 Meter

Fast dissolved oxygen measurement with automatic pressure compensation

Durable waterproof and dustproof design with IP67 rating – Even with no probes attached

Single or multipoint calibration – Fast, trouble-free calibration in air

Large backlit graphic display – Multiline display with electrode status indicator, calibration data, and more

User-settable “calibration due” alarm – Out-of-date or unperformed calibrations are now a thing of the past!

Built-in real-time clock – Time-and-date stamping meets Good Laboratory Practice (GLP) standards

Advanced data management – Store up to 500 data sets and download via IrDA wireless interface

Set point alarms – Audible warning when readings are outside set points limit

No meter warm-up required – Galvanic probe design lets you take measurements immediately without the typical 15-minute wait!

Password protection – Security for calibration and setup menus

Rugged rubber boot – Protects meter when out in the field



35441-02

ISO9001:2008
CERTIFIED SUPPLIER



3 year
warranty
meter only

Specifications

Mode	mg/L (ppm)	% Saturation	Temperature
Range	0.00 to 90.00 mg/L (ppm)	0.0 to 600.0%	0.0 to 50.0°C (32.0 to 122.0°F)
Resolution	0.01 mg/L (ppm)	0.1%	0.1°C (0.1°F)
Accuracy	±0.2% mg/L (ppm)	±2% full-scale	±0.3°C (±0.3°F)

Temperature compensation: automatic or manual (selectable) from 0 to 50°C

Salinity correction

Range: 0.0 to 50.0 ppt
Resolution: 0.1 ppt
Method: key in manually for meter calculation correction

Barometric pressure correction

Range: 450 to 825 mm Hg, 59.9 to 109.9 kPa
Resolution: 1 mm Hg, 0.1 kPa
Method: automatic correction

Probe: galvanic

Memory: up to 500 sets with GLP date and time

Output: infrared, IrDA

Real-time clock: time-and-date stamp on calibration and stored data

Display: multiline LCD with backlighting

Ambient operating temperature: 0 to 50°C (32 to 122°F)

Power: four 1.5 V AA batteries (included) or optional universal AC adapter, up to 500 hours continuous use

Dimensions

Meter: 7¼" L x 3¼" W x 2¼" H (18.4 x 8.3 x 5.7 cm)
Boxed: 9½" L x 9½" W x 2¾" H (23 x 23 x 7 cm)

Weight

Meter: 1 lb (0.5 kg); **Boxed:** 2 lb (0.9 kg)



Complete kit available; includes meter, solutions, rubber boot, and carrying case.

DO probes available with up to 100-ft (30-m) cable. See page 50 to order.

Ordering Information

Catalog number	Precalibrated catalog number	Description	Included
WD-35441-02	WD-35441-03	DO 600 meter only	Meter and batteries
WD-35441-00	WD-35441-01	DO 600 meter	Meter, probe 35640-50 with 10-ft (3-m) cable, electrolyte solution, replacement membrane caps, and batteries
WD-35441-70	WD-35441-71	DO 600 meter kit	Meter, probe 35640-50 with 10-ft (3-m) cable, electrolyte solution, rubber boot, replacement membrane caps, hard carrying case, and batteries

WD-35640-50 Replacement dissolved oxygen probe, 10-ft (3-m) cable

WD-35418-83 Optional adapter, 110/220 VAC

WD-35418-86 Protective rubber boot for all 600- and 650-series meters

DO 700 Meter

Economical and user-friendly meter is perfect for water treatment facilities and schools

Takes up less bench space – Overall footprint is nearly 40% smaller than other benchtop meters

Oversized liquid crystal display – Easy to see from across the laboratory

Up to 100 point nonvolatile memory

Dissolved oxygen measurements in mg/L, ppm, or % saturation

Accurate readings under varying conditions – Corrections for temperature (automatic or manual), salinity (manual), and barometric pressure (manual)

Convenient pull-out reference guide



35415-00

Dissolved Oxygen



Splash-resistant keypad



Electrode holder can be mounted on either side of meter

See page 50 for probe maintenance and calibration supplies

Specifications

ISO9001:2008 CERTIFIED SUPPLIER



3 year warranty meter only

Mode	mg/L (ppm)	% Saturation	Temperature
Range	0 to 30 mg/L	0 to 300%	0.0 to 50.0°C (32.0 to 122°F)
Resolution	0.01	0.1%	0.1°C or °F
Accuracy	±0.5% full scale	±0.5% full scale	±0.5°C (±0.9°F)
Connectors	BNC	BNC	Phono

Temperature compensation: manual or automatic from 0 to 50°C (32 to 122°F)

Salinity compensation
Range: 0 to 50 ppt
Resolution: 0.1 ppt
Method: key in manually and meter automatically corrects

Barometric compensation
Range: 450 to 825 mm Hg
Resolution: 1 mm Hg
Method: key in manually and meter automatically corrects

Probe: galvanic with 3-ft (1-m) cable

Memory: up to 100 data sets

Output: none

Display: 3¼" x 2⅞" (8.3 x 6.2 cm) graphic LCD

Operating temperature: 5 to 45°C (41 to 113°F), noncondensing humidity

Power: universal 110/240 VAC with adapters; UL/CSA listed

Dimensions

Meter: 6⅞" x 6⅞" x 2¾" (15.5 x 17.5 x 6.9 cm)

Boxed: 12" x 9" x 5" (30.8 x 15.5 x 12.4 cm)

Weight

Meter only: 1.4 lb (0.6 kg); **Boxed:** 4 lb (1.8 kg)

Ordering Information

Catalog number	Pre-calibrated catalog number	Description	Included
WD-35415-00	WD-35415-01	DO 700 meter	Meter, dissolved oxygen probe 35642-50, electrode holder, and AC adapter

WD-35642-50 Replacement DO probe with 3-ft (1-m) cable

WD-35820-64 In-line fitting for DO probe 35642-50

WD-35420-54 Replacement electrode arm

WD-35420-72 Replacement universal power adapter

...setting the standard
again and again®

Benchtop Meters — Dissolved Oxygen

DO 2700 Meter

**Optimal performance and versatility
at a very affordable price!**

Takes up less bench space – Overall footprint is nearly 40% smaller than other benchtop meters

Oversized liquid crystal display – Easy to see readings from across the lab; viewing under all lighting conditions

Dynamic reading stability indication – Shows when your measurement is stable, eliminating guesswork from unstable readings

Up to 500 point nonvolatile memory with time-and-date stamp – Meets GLP requirements

Bidirectional RS-232 – Easy data transfer to your computer

Automatic calibration at 100% and independent 0% – Provides greater measurement sensitivity at low oxygen levels

Built-in barometer – Automatically adjusts for most accurate readings

Corrections for temperature and salinity variations – Automatic or manual temperature compensation and manual salinity correction

Calibration documentation – Details include date and time, calibration standard, offset, slope, and next cal date

User-settable alarms – Alert you when readings are out-of-range or calibration should be performed

Electrode diagnostics – Indicate when probe maintenance or replacement is due

Password protection – Prevents unauthorized use

Includes a self-stirring dissolved oxygen/BOD probe – Ideal for wastewater testing in the laboratory



See page 50
for probe
maintenance and
calibration supplies

35416-00

ISO9001:2008
CERTIFIED SUPPLIER

CE
3 year
warranty
meter only

Specifications

Mode	mg/L (ppm)	% Saturation	Temperature
Range	0 to 50 mg/L	0 to 600.0%	0.0 to 50.0°C (32.0 to 122°F)
Resolution	0.01, 0.1	0.1%	0.1°C or °F
Accuracy	±0.5% full scale	±0.5% full scale	±0.3°C (±0.5°F)
Connectors	BNC	BNC	Phono

Temperature compensation: manual or automatic from 0 to 50°C (32 to 122°F)

Salinity compensation
Range: 0 to 50 ppt
Resolution: 0.1 ppt
Method: key in manually and meter automatically corrects

Barometric compensation
Range: 450 to 825 mm Hg
Resolution: 1 mm Hg
Method: meter automatically corrects with built-in barometer

Probe: polarographic self-stirring BOD with 3-ft (1-m) cable

Memory: up to 500 data sets
Output: RS-232

Display: 3¼" x 2⅞" (8.3 x 6.2 cm) graphic LCD with backlight

Operating temperature: 5 to 45°C (41 to 113°F), noncondensing humidity

Power: universal 110/240 VAC with adapters; UL/CSA listed

Dimensions
Meter: 6⅞" x 6⅞" x 2¾" (15.5 x 17.5 x 6.9 cm)
Boxed: 12" x 9" x 5" (30.8 x 15.5 x 12.4 cm)

Weight
Meter only: 1.4 lb (0.6 kg); **Boxed:** 4 lb (1.8 kg)

Ordering Information

Catalog number	Precalibrated catalog number	Description	Included
WD-35416-00	WD-35416-01	DO 2700 meter	Meter, self-stirring dissolved oxygen/BOD probe 35420-82, six membrane caps, electrolyte solution, and AC adapter

Accessories

- WD-35420-82 Replacement self-stirring DO/BOD probe with 3-ft (1-m) cable
- WD-35420-01 RS-232 data cable
- WD-35630-53 USB data cable
- WD-35420-72 Replacement universal power adapter



Unstable reading



Stable reading

DO Probes and Accessories

Probes

Oakton® probes use galvanic technology to provide rapid results, without any warm-up requirements for field use or economical polarographic technology for BOD use.



Probes for DO 6, DO 6+, and DO 700 meters

Includes 50 mL of electrolyte solution and one replacement membrane cap. Probe dimensions: 5"L x 0.5" dia (11.5 cm L x 1.2 cm dia)

Catalog number	Description
WD-35642-50	Replacement DO probe with 3-ft (1-m) cable
WD-35642-52	DO probe with 10-ft (3-m) cable
WD-35642-54	DO probe with 30-ft (9-m) cable

Probes for DO 110, DO 300, and DO 600 meters

Includes 50 mL of electrolyte solution and two replacement membrane caps. Probe dimensions: 6.8"L x 1.3" dia (17.3 cm L x 3.2 cm dia)

Catalog number	Description
WD-35640-50	Replacement DO probe with 10-ft (3-m) cable
WD-35640-52	DO probe with 25-ft (7-m) cable
WD-35640-54	DO probe with 50-ft (15-m) cable
WD-35640-56	DO probe with 100-ft (30-m) cable

Probe for DO 2700 meter – BOD electrode with self-stirring mechanism

Includes 20 mL of electrolyte solution and six replacement membrane caps. Probe dimensions: 2.4"L x 0.5" dia (6.2 cm L x 1.2 cm dia)

Catalog number	Description
WD-35420-82	Replacement BOD probe with 3-ft (1-m) cable

Probe Maintenance

Catalog number	Description
Membrane assembly for DO 6, DO 6+, and DO 700 meters	
WD-35642-55	Replacement membrane assembly consists of a preassembled membrane and cap. Simply screw replacement membrane assembly onto the probe you already have. Includes 50 mL of electrolyte solution.
Membrane assembly for DO 110, DO 300, and DO 600 meters	
WD-35640-80	Maintenance kit. Includes two complete membrane cap assemblies and 50 mL of electrolyte solution.
WD-35640-72	Replacement membrane assembly consists of a preassembled membrane, membrane lock, O-ring, and cap. Simply screw replacement membrane assembly onto your probe.
WD-35640-79	Membrane installation tool lets you remove and replace membrane in the lab or field.
WD-35640-74	Replacement HDPE membranes. Pack of 5
WD-35640-75	Replacement HDPE membranes. Pack of 25
Membrane assembly for DO 2700 meter	
WD-53109-55	Maintenance kit. Includes six membrane caps and 20 mL of electrolyte solution.

Solutions

Ensure accurate readings by using Oakton solutions with your DO meter. Zero oxygen solution lets you calibrate for accurate low-end readings. Replacement electrolyte should be used whenever you replace the membrane or membrane cap.



00653-00

Catalog number	Description
WD-00653-00	Zero oxygen calibration solution, 500 mL
WD-35640-71	Replacement electrolyte solution, premixed 500 mL
WD-35640-70	Replacement electrolyte powder, 58.5 g. Mix your own electrolyte solution—makes 400 mL. Has longer shelf life in unmixed form.

RDO Accessories

For RDO 450 meter only



Catalog number	Description
WD-35640-51	Sensor cap, for annual sensor replacement
WD-35640-59	Stainless steel probe guard, screw thread to attach to probe
WD-35640-58	Calibration chamber, screw thread to attach to probe

Multiparameter Meter Selection Guide

Get Better Accuracy

Oakton multiparameter meters offer automatic calibration, buffer recognition, and ranging functions with a wide selection of calibration solutions— quick, easy calibrations with flexibility to meet your applications. Kits include probe options with ATC to ensure temperature compensation. For special application requirements, Oakton offers a range of probes for pH, conductivity, and dissolved oxygen.

Get Dependability

Oakton multiparameter meters are built to last and include a three-year warranty. The ASIC microprocessor technology offers trouble-free performance for years. ISO 9001:2008 certified company with CE mark products to ensure product excellence.



Waterproof 450 series



Waterproof 650 series



Benchtop series

Use this handy comparison chart to help select the multiparameter meter right for your application.

Meter	Waterproof 450 series	Waterproof 650 series	Benchtop 700	Benchtop 2700
See pages	52–53	54–57	58	59
Description	Best value, advanced features	Rugged field / environmental meter	Basic feature, benchtop	Advanced features, benchtop
Display	Three-line LCD with backlight	Multi-line dot matrix with backlight	Large three-line LCD	Graphic display with backlight
IP67-rated housing	Yes	Yes	—	—
Memory	Up to 500 data sets	Up to 500 data sets	Up to 100 data sets	Up to 500 data sets
Communication	USB or RS-232	IrDA	—	RS-232
Password protection	Yes	Yes	—	Yes
Real-time clock	Yes	Yes	—	Yes
pH calibration points	Up to 6	Up to 6	Up to 5	Up to 5
Auto buffer recognition	Yes	Yes	Yes	Yes
Buffer sets	US, NIST, DIN	US, NIST, DIN, custom	US, NIST, DIN	US, NIST, DIN, custom
Automatic end point	Yes	Yes	Yes	Yes
Automatic shut off	Yes, adjustable	Yes, adjustable	—	—
Hold function	Yes	Yes	Yes	Yes
Ready/stability indicator	Yes	Yes	Yes	Yes
Built-in stand	Yes	Yes	—	—
Protective rubber boot	—	Optional	—	—
AC power adapter	Optional	Optional	Yes	Yes

Guarantee measurement accuracy—look for the precalibrated items throughout this section and save!

pH/CON 450 Meter

Select meter with combination pH/CON probe or separate pH and conductivity probes

- Durable waterproof and dustproof design with IP67 rating**
- Switch between pH, mV, conductivity, TDS, and salinity with a press of a button**
- Large, backlit custom display** – Lets you view measurement with temperature
- Six-point calibration** – Choose USA, NIST, DIN, PWB, or custom buffer sets
- Auto buffer recognition** – Automatically identifies the correct pH buffer for rapid calibration
- Calibration alarm** – A visible reminder when it is time to recalibrate the meter
- Intuitive, user-friendly icons** – Electrode status displays pH slope or cell constant
- Auto-range conductivity from 0 to 199.9 mS in five ranges** – With up to five calibration points
- Selectable cell constant** – 0.10, 1.00, or 10.0 from two-cell probe
- Selectable temperature coefficient** – Adjustable from 0 to 10% per °C for accurate compensation of almost any solution
- Conductivity-to-TDS factor** – Adjustable from 0.4 to 1.0
- Automatic or manual temperature compensation** – For the highest accuracy in any situation
- Selectable °C/°F** – Choose units to best fit your application
- Hold, ready, low-battery indicator, and automatic shutoff functions**
- Store up to 500 data sets; easy USB or RS-232 output with optional data cables**
- Built-in real-time clock stamps stored data and calibration data with time and date** – Meets standards for GLP (Good Laboratory Practices)
- Grip-Clip™ holder** – Quickly and easily secures the probe to your beaker or container
- Built-in stand with wall mount** – Allows for easy benchtop measurement and storage
- 500 hours battery life or use optional universal power adapter**

New



35630-10

35636-12



Specifications

Mode	pH	mV	Conductivity	TDS	Salinity	Temperature
Range	-2.00 to 16.00 pH	±2000 mV	0 to 200 mS	0 to 200 ppt	0 to 50 ppt	-10 to 110.0°C (-17 to 230.0°F)
Resolution	0.01 pH	0.1 mV ±999.9 mV; 1 mV beyond	0.01 µS to 0.1 mS	0.01 ppm to 0.1 ppt	0.01	0.1°C/°F
Accuracy	±0.01 pH	±0.2 mV ±2 LSD or ±0.5% of reading; whichever is greater	±1% full-scale	±1% full-scale	±1% full-scale	±0.5°C (±0.9°F)
Calibration	Up to six points: USA, NIST, DIN, PWB, or custom	±200 mV	Auto/manual; one point per range	Auto/manual; one point per range	Auto/manual; one point per range	±5.0 offset

Display: custom LCD with backlight
Memory: up to 500 data sets
Output: USB or RS-232

Real-time clock: time-and-date stamp on calibration and stored data
Temperature compensation: automatic or manual from -10 to 110°C

Power: two AA batteries (included), 500 hours (without backlight); AC adapter (optional)
Dimensions (L x W x H):
Meter: 7 7/8" x 3 1/8" x 2 1/4" (20 x 8.3 x 5.7 cm)
Boxed: 9 1/8" x 9 1/8" x 2 3/4" (23 x 23 x 7 cm)

Weight:
Meter: 1 lb (0.5 kg);
Boxed: 1.4 lb (0.7 kg)

Ordering Information

Catalog number	Precalibrated catalog number	Description	Included
WD-35630-10	WD-35630-11	pH/CON 450 meter with combination probe	Meter, combination pH/CON probe 35630-51, and two AA batteries
WD-35630-12	WD-35630-13	pH/CON 450 meter with separate probes	Meter, "All-in-One" pH probe 35641-51, conductivity cell (K = 1.0) 35808-50, Grip-Clip holder, and two AA batteries
WD-35630-80	WD-35630-81	pH/CON 450 meter kit with combination probe	Meter, combination pH/CON probe 35630-51, calibration solutions, two AA batteries, and hard carrying case
WD-35630-90	WD-35630-91	pH/CON 450 meter kit with separate probes	Meter, "All-in-One" pH probe 35641-51, conductivity cell (K = 1.0) 35808-50, Grip-Clip holder, calibration solutions, two AA batteries, and hard carrying case

WD-35641-51 "All-in-One" pH electrode with built-in ATC. Double-junction; epoxy body; BNC connector

WD-35618-05 ATC probe. Use with any standard pH electrode for temperature compensation

WD-35630-51 Replacement combination pH/CON/ATC probe

WD-35608-55 Conductivity cell, K = 0.1

WD-35608-50 Replacement conductivity cell, K = 1.0

WD-35608-51 Conductivity cell, K = 10

WD-35614-50 Replacement Grip-Clip electrode holder

WD-35608-51 Hard carrying case, fits all 150/450 meter configurations

WD-35630-53 Data cable for USB connectivity

WD-35420-01 Data cable for RS-232 connectivity

WD-35420-72 Optional adapter, 110/220 VAC

WD-09376-01 Replacement batteries, AA. Pack of 4

pH/RDO 450 Meter

Affordable optical RDO technology reduces maintenance time and costs

- Durable waterproof and dustproof design with IP67 rating**
- Large, backlit graphic display provides measurement with temperature**
- Switch between pH, mV, % saturation, and mg/L (ppm) dissolved oxygen** – With the press of a button
- Eliminates costly, tiresome membranes and solutions**
- Automatic barometric pressure and manual salinity correction**
- Six-point calibration** – Choose USA, NIST, DIN, PWB, or custom buffer sets
- Auto buffer recognition** – Automatically identifies the correct pH buffer for rapid calibration
- Automatic or manual temperature compensation** – For the highest accuracy in any situation
- Calibration alarm** – A visible reminder that it is time to recalibrate the meter
- Selectable °C or °F** – Choose units to best fit your application
- Hold, ready, low-battery indicator, and automatic shutoff functions**
- Store up to 500 data sets** – Easy USB or RS-232 output with optional data cables
- Built-in real-time clock stamps stored data and calibration data with time and date** – Meets standards for GLP (Good Laboratory Practices)
- Built-in stand with wall mount** – Allows for easy benchtop measurement and storage
- 500 hours battery life or use optional universal power adapter**



Specifications

Mode	pH	mV	mg/L (ppm)	% Saturation	Temperature
Range	-2.00 to 16.00 pH	±2000 mV	0 to 20 mg/L (ppm)	0 to 200%	-10.0 to 110.0°C (-17.0 to 230.0°F)
Resolution	0.01 pH	0.1 mV ±999.9 mV; 1 mV beyond	0.1 mg/L	0.10%	0.1°C/°F
Accuracy	±0.01	±0.2 mV ±2 LSD or ±0.5% of reading; whichever is greater	±2%	±2%	±0.5°C (±0.9°F)
Calibration	Up to six points: USA, NIST, DIN, PWB, or custom	±200 mV	Zero and saturation	Zero and saturation	±5.0° offset

Display: custom LCD with backlight
Memory: up to 500 data sets
Output: USB or RS-232
Real-time clock: time-and-date stamp on calibration and stored data
Temperature compensation: automatic or manual from -10 to 110°C

Power: two AA batteries (included), 500 hours (without backlight); AC adapter (optional)
Dimensions (L x W x H)
Meter: 7 7/8" x 3 1/8" x 2 1/4" (20 x 8.3 x 5.7 cm)
Boxed: 9 1/8" x 9 1/8" x 2 3/4" (23 x 23 x 7 cm)
Weight:
Meter: 1 lb (0.5 kg); **Boxed:** 1.4 lb (0.7 kg)

Ordering Information

Catalog number	Pre-calibrated catalog number	Description	Included
WD-35632-32	WD-35632-34	pH/RDO 450 meter only	Meter and two AA batteries
WD-35632-30	WD-35632-31	pH/RDO 450 meter with probes	Meter, "All-in-One" pH probe 35808-71, RDO probe 35640-53, sensor cap, and two AA batteries
WD-35632-80	WD-35632-81	pH/RDO 450 meter kit	Meter, "All-in-One" pH probe 35808-71, RDO probe 35640-53, sensor cap, RDO weight, calibration tube, calibration solutions, two AA batteries, and hard carrying case

Accessories

WD-35805-23 Replacement "All-in-One" pH electrode with built-in ATC. Single-junction; epoxy body; 10 ft (3-m) BNC connector
WD-35618-05 ATC probe. Use with any standard pH electrode for temperature compensation
WD-35640-51 Replacement RDO sensor cap
WD-35640-53 Replacement RDO probe, 10-ft (3-m) cable
WD-35640-55 RDO probe, 20-ft (6-m) cable
WD-35640-57 RDO probe, 50-ft (15-m) cable

WD-35640-59 RDO weight, screw thread to attach to probe
WD-35608-51 Hard carrying case, fits all 150/450 meter configurations
WD-35640-58 RDO calibration chamber
WD-35630-53 Data cable for USB connectivity
WD-35420-01 Data cable for RS-232 connectivity
WD-35420-72 Optional adapter, 110/220 VAC
WD-09376-01 Replacement batteries, AA. Pack of 4

Multiparameter

PC 650 pH/Conductivity Meter

Two most common electrochemistry measurements in one convenient meter!

Durable waterproof and dustproof design with IP67 rating – Even with no probes attached

Push-button pH calibration at up to six points – Up to 15 buffer options with auto-buffer recognition of USA, NIST, DIN, and PWB standards

Large backlit graphic display – Multiline display with electrode status indicator, calibration data, and more

User-settable “calibration due” alarm – Out-of-date or unperformed calibrations are now things of the past!

Built-in real-time clock – Time-and-date stamping meets Good Laboratory Practice (GLP) standards

Store up to 500 data sets – Infrared IrDA wireless technology makes PC downloading convenient and easy

Set point alarms – Audible warning when readings are outside set points limit

Research-grade accuracy – Resolution to 0.001 pH and accuracy to ± 0.002 pH

Electrode status indicator – Calibration data provides electrode diagnostic tool

Password protection – Security for calibration and setup menus

Rugged rubber boot – Protects meter from impact (optional; included with kit)



ISO9001:2008
CERTIFIED SUPPLIER

CE
3 year
warranty
meter only

Specifications

Model	PC 650 meter		
Range	pH	-2.000 to 20.000 pH	
	Ion	0.001 to 19,900 ppm, molar, or mg/L	
	mV	± 2000 mV	
	Conductivity	0 to 500.0 mS	
	TDS	0 to 500 ppt	
	Salinity	0 to 80 ppt	
	Resistivity	0 to 20.00 M Ω	
Resolution	Temperature	-10.0 to 110.0°C (14.0 to 230.0°F), selectable	
	pH	0.1/0.01/0.001 pH	
	Ion	2 or 3 digits	
	mV	0.1 mV	
	Conductivity	0.05% full-scale	
	Temperature	0.1°C (0.1°F)	
	Accuracy	pH	± 0.002 pH
Ion		$\pm 0.5\%$ full-scale (monovalent); 1% full-scale (divalent)	
mV		± 0.2 mV	
Conductivity		1% full-scale	
Temperature		$\pm 0.5^\circ\text{C}$ ($\pm 0.9^\circ\text{F}$)	
Calibration		pH	Up to 6 buffer values (select from 4 sets): USA: 1.68, 4.01, 7.01, 10.01, 12.45; NIST: 1.68, 4.01, 6.86, 9.18, 12.45; DIN: 1.09, 2.06, 4.65, 6.79, 9.23, 12.75; or custom buffers
		Ion	Up to 6 points
	Conductivity	Manual up to 5 points (1 per range); automatic up to 4 points (84.0 $\mu\text{S}/\text{cm}$, 1413 $\mu\text{S}/\text{cm}$; 12.88 mS/cm, 111.8 mS/cm)	
	Temperature	Offset 0.1°C (0.1°F) increments	

Memory: up to 500 sets with GLP date and time

Output: infrared, IrDA

Real-time clock: time-and-date stamp on calibration and stored data

Temperature compensation: automatic or manual (selectable), from 0 to 100°C

Ambient operating temperature: 0 to 50°C (32 to 122°F)

Power: four 1.5 V AA batteries (included) or optional universal AC adapter, up to 200 hours continuous use

Dimensions

Meter: 7½"L x 3¾"W x 2¼"H (19 x 9.5 x 5.7 cm)

Boxed: 9½"L x 9¼"W x 2¾"H (23 x 23 x 7 cm)

Weight

Meter: 1 lb (0.5 kg); **Boxed:** 2 lb (0.9 kg)

Ordering Information

Catalog number	Precalibrated catalog number	Description	Included
WD-35431-02	WD-35431-03	PC 650 meter only	Meter and batteries
WD-35431-00	WD-35431-01	PC 650 meter	Meter, pH electrode 35816-77, conductivity cell 35408-57, and batteries
WD-35431-70	WD-35431-71	PC 650 meter kit	Meter, pH electrode 35816-77, conductivity cell 35408-57, calibration standards (60 mL each of pH 4.01, pH 7.00, 1413 $\mu\text{S}/\text{cm}$, 12.88 mS solution), two electrode holders, rubber boot, hard carrying case, and batteries

WD-35816-77 Replacement pH electrode; double junction, epoxy body, 10-ft (3-m) cable with BNC connector

WD-35418-05 ATC probe. Use for temperature compensation with any pH electrode without built-in ATC

WD-35408-57 Replacement conductivity cell, 2-electrode, K = 1

WD-35630-52 Down-well probe for PC 650, pH/conductivity/temperature; 10-ft (3-m) cable

WD-35434-85 Multiprobe holder. Holds one each pH, conductivity, DO, and temperature probes

WD-35418-83 Optional adapter, 110/220 VAC



Optional rubber boot (included with kit) provides added protection.

See pages 23–29 for more pH and ISE electrodes; page 43 for conductivity cells.

PD 650 pH/ Dissolved Oxygen Meter

Ideal for wastewater and aquaculture!

Durable waterproof and dustproof design with IP67 rating – Even with no probes attached

Push-button calibration for all parameters – 6 points each for pH and conductivity; 3 points for DO

Large backlit graphic display – Multiline display with electrode status indicator, calibration data, and more

User-settable “calibration due” alarm – Out-of-date or unperformed calibrations are now things of the past!

Built-in real-time clock – Time-and-date stamping meets Good Laboratory Practice (GLP) standards

Store up to 500 data sets – Infrared IrDA wireless technology makes PC downloading convenient and easy

Set point alarms – Audible warning when readings are outside set points limit

Research-grade accuracy – Resolution to 0.001 pH and accuracy to ±0.002 pH

Electrode status indicator – Calibration data provides electrode diagnostic tool

Password protection – Security for calibration and setup menus

Rugged rubber boot – Protects meter from impact (optional; included with kit)



ISO9001:2008
CERTIFIED SUPPLIER

CE
3 year warranty
meter only

Specifications

Model	PD 650 meter	
Range	pH	-2.000 to 20.000 pH
	Ion	0.001 to 19,900 ppm, molar, or mg/L
	mV	±2000 mV
	DO	0.00 to 90.00 mg/L (ppm), 0.0 to 600.0%
	Temperature	-10.0 to 110.0°C (14.0 to 230.0°F), selectable
Resolution	pH	0.1/0.01/0.001 pH
	Ion	2 or 3 digits
	mV	0.1 mV
	DO	0.01 mg/L (ppm), 0.1%
	Temperature	0.1°C (0.1°F)
Accuracy	pH	±0.002 pH
	Ion	±0.5% full-scale (monovalent); ±1% full-scale (divalent)
	mV	±0.2 mV
	DO	±0.2 mg/L; ±2.0%
	Temperature	±0.5°C (0.9°F)
Calibration	pH	Up to 6 buffer values (select from 4 sets): USA: 1.68, 4.01, 7.01, 10.01, 12.45; NIST: 1.68, 4.01, 6.86, 9.18, 12.45; DIN: 1.09, 2.06, 4.65, 6.79, 9.23, 12.75; or custom buffers
	Ion	Up to 6 points
	DO	Two points; 100% and 0%
	Temperature	Offset 0.1°C (0.1°F) increments

DO salinity correction

Range: 0.0 to 50.0 ppt;
Resolution: 0.1 ppt

DO pressure correction

Range: 500 to 1499 mm Hg, 66.6 to 199.9 kPa
Resolution: 1 mm Hg, 0.1 kPa

Memory: up to 500 sets with GLP date and time

Output: infrared, IrDA

Real-time clock: time-and-date stamp on calibration and stored data

Temperature compensation: automatic or manual (selectable), from 0 to 100°C

Ambient operating temperature: 0 to 50°C (32 to 122°F)

Power: four 1.5 V AA batteries (included) or optional universal AC adapter, up to 200 hours continuous use

Dimensions

Meter: 7½" L x 3¾" W x 2¼" H (19 x 9.5 x 5.7 cm)

Boxed: 9½" L x 9¾" W x 2¾" H (23 x 23 x 7 cm)

Weight

Meter: 1 lb (0.5 kg); **Boxed:** 2 lb (0.9 kg)



Optional rubber boot (included with kit) provides added protection.

See pages 23–29 for more pH electrodes; page 50 for DO probes.

Ordering Information

Catalog number	Precalibrated catalog number	Description	Included
WD-35432-02	WD-35432-03	PD 650 meter only	Meter and batteries
WD-35432-00	WD-35432-01	PD 650 meter	Meter, pH electrode 35816-77, DO probe 35640-50, and batteries
WD-35432-70	WD-35432-71	PD 650 meter kit	Meter, pH electrode 35816-77, DO probe 35640-50, calibration standards (60 mL each of pH 4.01, pH 7.00, electrode storage solution, and rinse water), rubber boot, multiprobe holder, batteries, and hard carrying case

WD-35816-77 pH electrode: double junction, epoxy body, 10-ft (3-m) cable with BNC connector

WD-35418-05 ATC probe. Use for temperature compensation with any pH electrode without built-in ATC

WD-35640-50 DO probe with 10-ft (3-m) cable

WD-35434-85 Multiprobe holder. Holds one each pH, conductivity, DO, and temperature probes

WD-35418-83 Optional adapter, 110/220 VAC

WD-35418-86 Protective rubber boot

CD 650 Conductivity/ Dissolved Oxygen Meter

Great for salt water testing!

Durable waterproof and dustproof design with IP67 rating – Even with no probes attached

Push-button calibration for all parameters – 5 points for conductivity; 3 points for DO

Large backlit graphic display – Multiline display with electrode status indicator, calibration data, and more

User-settable “calibration due” alarm – Out-of-date or unperformed calibrations are now things of the past!

Built-in real-time clock – Time-and-date stamping meets Good Laboratory Practice (GLP) standards

Store up to 500 data sets – Infrared IrDA wireless technology makes PC downloading convenient and easy

Set point alarms – Audible warning when readings are outside set points limit

Research-grade accuracy – Resolution to 0.001 pH and accuracy to ± 0.002 pH

Electrode status indicator – Calibration data provides electrode diagnostic tool

Password protection – Security for calibration and setup menus

Rugged rubber boot – Protects meter from impact (optional; included with kit)



ISO9001:2008
CERTIFIED SUPPLIER

CE **3** year
warranty
meter only

Specifications

Model	CD 650 meter	
Range	Conductivity	0 to 500.0 mS
	TDS	0 to 500 ppt
	Salinity	0 to 80 ppt
	Resistivity	0 to 20.00 M Ω
	DO	0.00 to 90.00 mg/L (ppm), 0.0 to 600.0%
	Temperature	-10.0 to 110.0°C (14.0 to 230.0°F), selectable
Resolution	Conductivity	0.05% full-scale
	TDS	0.05% full-scale
	DO	0.01 mg/L (ppm), 0.1%
	Temperature	0.1°C (0.1°F)
Accuracy	Conductivity	$\pm 1\%$ full-scale
	TDS	$\pm 1\%$ full-scale
	DO	± 0.2 mg/L; $\pm 2\%$
	Temperature	$\pm 0.5^\circ\text{C}$ ($\pm 0.9^\circ\text{F}$)
Calibration	Conductivity	Manual up to 5 points (1 per range); automatic up to 4 points (84.0 $\mu\text{S}/\text{cm}$, 1413 $\mu\text{S}/\text{cm}$, 12.88 mS/cm, 111.8 mS/cm)
	DO	Two points; 100% and 0%
	Temperature	Offset 0.1°C (0.1°F) increments

TDS factor: 0.40 to 1.00

Cell constant: 0.100 to 10.000

DO salinity correction

Range: 0.0 to 50.0 ppt

Resolution: 0.1 ppt

DO pressure correction

Range: 500 to 1499 mm Hg, 66.6 to 199.9 kPa

Resolution: 1 mm Hg, 0.1 kPa

Memory: up to 500 sets with GLP date and time

Output: infrared, IrDA

Real-time clock: time-and-date stamp on calibration and stored data

Temperature normalization: 15 or 30°C

Temperature coefficient: linear or pure

Temperature compensation: automatic or manual (selectable), from 0 to 100°C

Ambient operating temperature: 0 to 50°C (32 to 122°F)

Power: four 1.5 V AA batteries (included) or optional universal AC adapter, up to 200 hours continuous use

Dimensions

Meter: 7½" L x 3¼" W x 2¼" H (19 x 9.5 x 5.7 cm)

Boxed: 9½" L x 9¼" W x 2¼" H (23 x 23 x 7 cm)

Weight

Meter: 1 lb (0.5 kg); **Boxed:** 2 lb (0.9 kg)

Multiparameter



Optional rubber boot (included with kit) provides added protection.

See page 43 for more conductivity cells; page 50 for DO probes.

Ordering Information

Catalog number	Precalibrated catalog number	Description	Included
WD-35433-02	WD-35433-03	CD 650 meter only	Meter and batteries
WD-35433-00	WD-35433-01	CD 650 meter	Meter, conductivity cell 35408-57, DO probe 35640-50, and batteries
WD-35433-70	WD-35433-71	CD 650 meter kit	Meter, conductivity cell 35408-57, DO probe 35640-50, calibration standards (60 mL each of pH 4.01, pH 7.00, 1413 $\mu\text{S}/\text{cm}$, and 12.88 mS solution), rubber boot, multiprobe holder, batteries, and hard carrying case

WD-35408-57 Replacement conductivity cell, 2-electrode, K = 1

WD-35640-50 Replacement DO probe with 10-ft (3-m) cable

WD-35434-85 Multiprobe holder. Holds one each pH, conductivity, DO, and temperature probes

WD-35418-83 Optional adapter, 110/220 VAC

WD-35418-86 Protective rubber boot for all 600- and 650-series meters

PCD 650 pH/Conductivity/ Dissolved Oxygen Meter



ISO9001:2008
CERTIFIED SUPPLIER

3 year
warranty
meter only

All three parameters, plus temperature, measured and displayed simultaneously!

Durable waterproof and dustproof design with IP67 rating – Even with no probes attached

Push-button calibration for all parameters – 6 points each for pH and conductivity; 3 points for DO

Large back-light graphic display – Multiline display with electrode status indicator, calibration data, and more

User-settable “calibration due” alarm – Out-of-date or unperformed calibrations are now things of the past!

Built-in real-time clock – Time-and-date stamping meets Good Laboratory Practice (GLP) standards

Store up to 500 data sets – Infrared IrDA wireless technology makes PC downloading convenient and easy

Set point alarms – Audible warning when readings are outside set points limit

Research-grade accuracy – Resolution to 0.001 pH and accuracy to ±0.002 pH

Electrode status indicator – Calibration data provides electrode diagnostic tool

Password protection – Security for calibration and setup menus

Rugged rubber boot – Protects meter from impact (optional; included with kit)

Specifications

Model	PCD 650 meters	
Range	pH	-2.000 to 20.000 pH
	Ion	0.001 to 19,900 ppm, molar, or mg/L
	mV	±2000 mV
	Conductivity	0 to 500.0 mS
	TDS	0 to 500 ppt
	Salinity	0 to 80 ppt
	Resistivity	0 to 20.00 MΩ
Resolution	DO	0.00 to 90.00 mg/L (ppm), 0.0 to 600.0%
	Temperature	-10.0 to 110.0°C (14.0 to 230.0°F), selectable
	pH	0.1/0.01/0.001 pH
	Ion	2 or 3 digits
Accuracy	mV	0.1 mV
	Conductivity	±0.05 % full-scale
	DO	0.01 mg/L (ppm), 0.1%
	Temperature	0.1°C (0.1°F)
Calibration	pH	±0.002 pH
	Ion	±0.5% full-scale (monovalent); ±1% full scale (divalent)
	mV	±0.2 mV
	Conductivity	±1% full-scale
Calibration	DO	±0.2 mg/L; ±2%
	Temperature	±0.5°C (±0.9°F)
	pH	Up to 6 buffer values (select from 4 sets): USA 1.68, 4.01, 7.01, 10.01, 12.45; NIST: 1.68, 4.01, 6.86, 9.18, 12.45; DIN: 1.09, 2.06, 4.65, 6.79, 9.23, 12.75, or custom buffers
	Ion	Up to 6 points
Calibration	Conductivity	Manual up to 5 points (1 per range); automatic up to 4 points (84.0 μS/cm; 1413 μS/cm; 12.88 mS/cm, 111.8 mS/cm)
	DO	Two points; 100% and 0%
Calibration	Temperature	Offset 0.1°C (0.1°F) increments

TDS factor: 0.40 to 1.00

Cell constant: 0.100 to 10.000

DO salinity correction

Range: 0.0 to 50.0 ppt

Resolution: 0.1 ppt

DO pressure correction

Range: 500 to 1499 mm Hg, 66.6 to 199.9 kPa

Resolution: 1 mm Hg, 0.1 kPa

Memory: up to 500 sets with GLP date and time

Output: infrared, IrDA

Real-time clock: time-and-date stamp on calibration and stored data

Temperature normalization: 15 or 30°C

Temperature coefficient: linear or pure

Temperature compensation: automatic or manual (selectable) from 0 to 100°C

Ambient operating temperature: 0 to 50°C (32 to 122°F)

Power: four 1.5 V AA batteries (included) or optional universal AC adapter, up to 200 hours continuous use

Dimensions

Meter: 7¼" L x 3¼" W x 2¼" H (18.4 x 8.3 x 5.7 cm)

Boxed: 9¼" L x 9¼" W x 2¾" H (23 x 23 x 7 cm)

Weight

Meter: 1 lb (0.5 kg); Boxed: 2 lb (0.9 kg)

Ordering Information

Catalog number	Pre-calibrated catalog number	Description	Included
WD-35434-02	WD-35434-03	PCD 650 meter only	Meter and batteries
WD-35434-00	WD-35434-01	PCD 650 meter	Meter, pH electrode 35816-77, conductivity cell 35408-57, DO probe 35640-50, and batteries
WD-35434-70	WD-35434-71	PCD 650 meter kit	Meter, pH electrode 35816-77, conductivity cell 35408-57, DO probe 35640-50, calibration standards (60 mL each of pH 4.01, pH 7.00, 1413 μS/cm, and 12.88 mS solution), multiprobe holder, rubber boot, hard carrying case, and batteries

WD-35816-77 pH electrode: double junction, epoxy body, 10-ft (3-m) cable with BNC connector

WD-35418-05 ATC probe. Use for temperature compensation with any pH electrode without built-in ATC

WD-35408-57 Conductivity cell, 2-electrode, K = 1

WD-35640-50 DO probe with 10-ft (3-m) cable

WD-35434-85 Multiprobe holder. Holds one each pH, conductivity, DO, and temperature probes

WD-35434-90 Multiprobe flow block for groundwater sampling

WD-35418-83 Optional adapter, 110/220 VAC



Multiprobe holder makes it easy to manage probes simultaneously.



Use multiprobe flow block 35434-90 for groundwater sampling. Holds two 12-mm diameter pH, ORP, or ISE probes, one Oakton conductivity/TDS probe, and one Oakton dissolved oxygen probe.

PC 700 pH/Conductivity Meter

Measures pH, mV, conductivity, TDS, and temperature—ideal for water quality testing in the lab!

Easily toggle between pH, mV, conductivity, and TDS readings

Large, dual display shows both measured parameter and temperature (°C/°F) – Read two parameters from across the lab

New space-saving design uses less benchspace – Footprint is 40% smaller

Easy push-button calibration – Five-point calibration for pH and either conductivity or TDS; temperature offset calibration

Advanced setup mode – Recalls previous calibration points, pH electrode slope/offset, conductivity/TDS effective cell constants per range, and more

Removable electrode holder arm – Holds electrodes firmly in place

pH auto buffer recognition – For fast, easy pH calibration

Selectable auto or manual ranging for conductivity and TDS measurements

Adjustable conductivity-to-TDS conversion factor and temperature coefficient – Gives highest accuracy in any solution

Selectable manual or automatic temperature compensation

Selectable automatic endpoint – Automatically freezes reading when stable

Hold function, “Ready” indicator, diagnostic error messages

Slide-out instruction card for quick reference

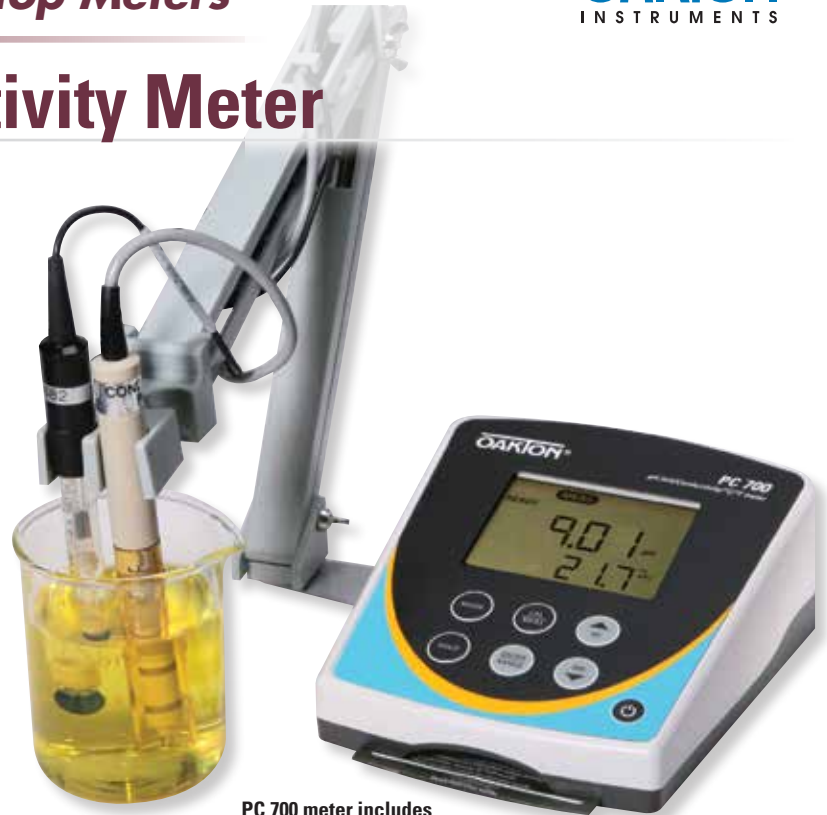

PC 700 meter includes electrode holder and handy slide-out instruction card.

ISO9001:2008
CERTIFIED SUPPLIER

3 year
warranty
meter only

Specifications

Mode	pH	mV/Rel mV	Conductivity	TDS	Temperature
Range	-2.00 to 16.00 pH	±2000 mV	0.00 to 19.99 µS, 0.0 to 199.9 µS, 0 to 1999 µS, 0 to 19.99 mS, 0.0 to 200 mS	0.00 to 9.99 ppm, 10.0 to 99.9 ppm, 100 to 999 ppm, 1.00 to 9.99 ppt, 10.0 to 99.9 ppt, 100 to 200 ppt*	0 to 100°C (32 to 212°F)
Resolution	0.01 pH	0.1 mV from ±199.9 mV, 1 mV beyond	0.01 µS, 0.1 µS, 1 µS, 0.01 mS, 0.1 mS	0.01 ppm, 0.1 ppm, 1 ppm, 0.01 ppt, 0.1 ppt	0.1°C/°F
Accuracy	±0.01 pH	±0.2 mV from ±199.9 mV, ±2 mV beyond	±1% full-scale	±1% full-scale	±0.5°C (±0.9°F)
Calibration	Up to five points (USA: 1.68, 4.01, 7.00, 10.00, 12.45; NIST: 1.68, 4.01, 6.86, 9.18, 12.45)	—	One point per range (up to 5)	One point per range (up to 5)	Offset up to ±5°C/°F

*200 ppt @ 1.0 factor

Input impedance: >1012 Ω

Temperature compensation: selectable manual or automatic from 0 to 100°C (32 to 212°F)

Conductivity cell constant (K): 0.1, 1.0, 10.0 (selectable)

Conductivity temperature coefficient: 0.0 to 10.0% per °C (adjustable)

Conductivity-to-TDS conversion factor: 0.4 to 1.0 (adjustable)

Normalization temperature: 15 to 30°C (adjustable)

Memory: up to 100 data sets

Display: 3¼" x 2½" (8.3 x 6.2 cm) dual LCD of pH, mV, conductivity, or TDS with temperature (in °C or °F)

Error messages: diagnose operator error, electrode error, and meter error; pull-out instruction card decodes message.

Operating temperature: 0 to 50°C (32 to 122°F), noncondensing humidity

Power: universal 100/240 VAC, with AC adapters is UL/CSA listed

Dimensions

Meter: 6½" x 6¾" x 2¾" (15.5 x 17.5 x 6.9 cm)

Boxed: 9" x 12¾" x 5" (23 x 35 x 12.5 cm)

Weight

Meter only: 1.25 lb (0.6 kg); Boxed: 3 lb (1.4 kg)

See page 43 for conductivity cells and calibration solutions.

Ordering Information

Catalog number	Pre-calibrated catalog number	Description	Included
WD-35413-20	WD-35413-21	PC 700 meter	Meter, electrode holder, and AC adapter
WD-35413-00	WD-35413-01	PC 700 meter with probes	Meter, double-junction pH electrode 35641-51, conductivity/temperature probe 35608-74, electrode holder, and AC adapter

PC 2700 Meter

Measures pH, mV, conductivity, TDS, and temperature—ideal for water quality testing in the lab!

Takes up less bench space – Overall footprint is nearly 40% smaller than other benchtop meters

Oversized liquid crystal display with bright backlighting – Easier viewing under all lighting conditions

Dynamic reading stability indication – shows when your measurement is stable; eliminates guesswork from unstable readings

Auto-standardization with cell constant recognition – Detect the exact cell constant value of your probe with the press of a button

Up to 500 point nonvolatile memory with time-and-date stamp – Meets GLP requirements

Bidirectional RS-232 for easy data transfer to your computer

Additional performance features include pH autobuffer recognition, conductivity standard auto-calibration, calibration documentation and cal-due alarms, audible out-of-range alarms, password protection, electrode status and diagnostics, and more!

Includes a high-performance 4-cell conductivity probe! – Higher accuracy across a broader range of samples



Unstable reading is faded



Reading turns solid when stable



ISO9001:2008
CERTIFIED SUPPLIER

CE
3 year warranty
meter only

Specifications

Mode	pH	mV	ISE	Conductivity	TDS	Salinity	Resistivity	Temperature
Range	-2.000 to 20.000 pH	±2000.0 mV	0.001 to 19,999 ppm	0.050 µS/cm to 500.0 mS/cm (5-range autoranging)	0.050 to 500.0 ppt	0.0 to 80.0 ppt	2.000 Ω to 20.0 MΩ	0.0 to 100.0°C (32.0 to 212°F)
Resolution	0.001, 0.01, 0.1 pH	0.1 mV	2 or 3 digits	0.01, 0.1 µS/cm, 0.001, 0.01, 0.1 mS/cm	0.01, 0.1 ppm, 0.001, 0.01, 0.1 ppt	0.1 ppt	0.01/0.1 Ω, 0.01/0.1 kΩ, 0.01 MΩ	0.1°C or °F
Accuracy	±0.002 pH	±0.2 mV	0.5% full scale (monovalent), 1% full scale (divalent)	± 1% full scale	± 1% full scale	± 1% full scale	± 1% full scale	±0.3°C (±0.5°F)
Calibration	Up to 6 (USA, NIST, DIN, or custom buffer sets)	Offset up to +150 mV	Up to 8 points	5 points (one point per range)	5 points (one point per range)	5 points (one point per range)	5 points (one point per range)	Offset in 0.1 increments; ±5°C (±9°F)
Connectors	BNC	BNC	BNC	8-pin DIN	8-pin DIN	8-pin DIN	8-pin DIN	8-pin DIN

Temperature compensation: manual or automatic from -5°C to 105°C

Conductivity temp coefficient: adjustable from 0.0 to 10% per °F/°C

Conductivity cell constant: 0.010 to 10.000

Conductivity-to-TDS factor: adjustable from 0.4 to 1.0

Normalization temperature: adjustable from 15 to 30°C

Memory: up to 500 data sets

Output: RS-232, 9-pin female

Display: 3¼" x 2⅛" (8.3 x 6.2 cm) graphic LCD with backlight

Operating temperature: 32 to 122°F, noncondensing probe

Power: universal 110/240 VAC with adapter; CSA/UL listed

Dimensions

Meter: 6⅞" x 6⅞" x 2¾" (15.5 x 17.5 x 6.9 cm)

Boxed: 12" x 9" x 5" (30.8 x 15.5 x 12.4 cm)

Weight: Meter only: 1.4 lb (650 g); Boxed: 4 lb (1800 g)

Ordering Information

Catalog number	Precalibrated catalog number	Description	Included
WD-35414-20	WD-35414-21	PC 2700 meter only	Meter, electrode holder and AC adapter
WD-35414-00	WD-35414-01	PC 2700 meter	Meter, pH electrode with double-junction, refillable, glass body; conductivity/temperature probe 35412-10, electrode holder, and AC adapter

Accessories

WD-35805-04 Replacement pH electrode; double-junction, glass body, refillable

WD-35412-10 Replacement conductivity/temperature probe for 2700-series meter; 4-cell, K= 1.0 epoxy/graphite

WD-35420-01 RS-232 data cable

WD-35630-53 USB data cable

Optical Measurement

Light

When light passes through a liquid, the amount of particles and color in solution will affect the light. Optical techniques measure solution characteristics by using a defined light source, passing the light through a sample, and then measuring the light that passes through the sample. Turbidimetric and colorimetric methods both involve measuring the resulting light intensity. They differ in that the light is attenuated by scattering in turbidimetry and by absorption in colorimetry.

Both determinations may use similar instrumentation. By employing different wavelengths of light and different optical configurations, we can optimize the system for determining the transmitted light of interest for a given analytical method.

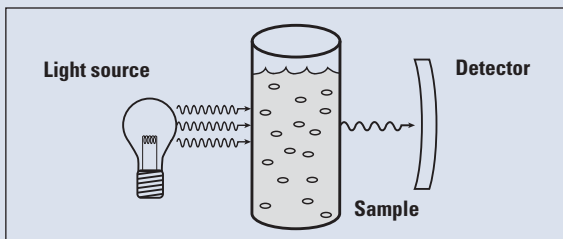

Turbidimetry

The cloudiness in a liquid caused by the presence of finely divided, suspended material is called “turbidity.” Turbidity meters provide a means of quantifying this “cloudiness” by determining the reduction of light passing through a turbid solution and then comparing the results against a standard. In some applications, the clarity of solution is critical. In other applications the appearance of particles indicates bacterial growth. In either case, the turbidimeter provides process numerical data on the sample solution.

Colorimetry

The colorimetric method of chemical analysis involves the measurement of light absorption by colored solutions. While the differences in color development are visible to the human eye, visual determination is subject to user interpretation. Colorimeters eliminate the differences encountered with color comparitors to produce an exact numerical value—with greater resolution than can be achieved through comparitors. Colorimeters use the well-understood principals of wet chemistry to provide precise, repeatable analysis methods. For example, the standard DPD method for determining free and total chlorine is well accepted and approved by the US EPA.

Reagents and Accessories

Reliable reagents and standards ensure accurate measurement for turbidimeters and colorimeters

Turbidity Calibration Set

For use with the T-100 turbidity meter sold on page 61. Stable standards ensure accurate turbidity measurements.



Catalog number	Description	Included
WD-35635-52	Calibration set	60 each of primary calibration standard 0.02, 20.0, 100, and 800 NTU

Secondary Chlorine Standards

Verify performance of your C201, C301; or C401 colorimeters (see page 61).



Catalog number	Description	Included
WD-35645-70	Secondary standards	Set of four vials

Colorimeter Reagents

The pH reagent features a dropper bottle making it easy to repetitively provide the correct amount of reagent. The convenient foil packs are ideal for use in the field or in the lab. DPD reagents follow US EPA method 330.5 for wastewater, and Standard Method 4500-Cl G for drinking water.



Catalog number	Description	Included
WD-35645-60	pH reagent	Dropper bottle, for 50 tests
WD-35645-62	Cyanuric acid reagent	100 foil packs
WD-35645-64	Free-chlorine reagent DPD	100 foil packs
WD-35645-66	Total-chlorine reagent DPD	100 foil packs

Cuvettes

For use with the T-100 turbidity meter on page 61 and all colorimeters on page 62. High-quality borosilicate glass ensures good light transmittance. Indexing mark on each cuvette makes it easy to get repeatable results.



Catalog number	Description	Included
WD-35653-55	Cuvettes	Pack of three

T-100 Turbidity Meter

Completely waterproof—even the sample chamber

Waterproof and dustproof housing – IP67-rated waterproof housing allows operation in wet conditions ensuring durability, easy cleaning, and maintenance—it even floats!

Auto-ranging from 0 to 1000 NTU – Meter determines the sample's turbidity level and automatically adjusts to the appropriate measurement range—eliminating any guesswork

Simple, display-prompted push-button calibration – Pressing the "CAL" button initiates the quick and simple calibration procedure. The instrument automatically prompts the user for the next calibration standard.

Large, easy-to read display – Large, custom LCD shows readings with units of measure and user-friendly message codes that guide meter operation

Advanced power supply management – Measures over 1200 samples with a single set of batteries, delivering quick, stable results in less than six seconds. Also features auto-off function.

Sturdy carrying case with accessories – Compact case contains all items necessary for turbidity measurements and protects the meter when not in use. Items include the T-100 meter, four primary calibration standards, three borosilicate sample cuvettes with light shield caps, collection bottle, lint-free cloth, silicone oil, and batteries.



Specifications

Model	T-100 Turbidity meter
Range	0.01 to 19.99 NTU, 20.0 to 99.9 NTU, 100 to 1000 NTU
Resolution	0.01 NTU, 0.1 NTU, 1 NTU
Measurement method	ISO 7027 (DIN EN 27027) compliant nephelometric method (90°)
Accuracy	±2% of measurement from 0 to 500 NTU, ±3% of measurement from 501 to 1000 NTU
Repeatability	±0.01 NTU or ±1% of measurement, whichever is greater
Response time	<6 seconds for full-step change
Calibration standards	0.02 NTU, 20.0 NTU, 100 NTU, 800 NTU

Standardization: EPA-approved polymer-based primary standards

Light source: infrared-emitting diode (850 nm wavelength)

Light source life: >1,000,000 measurements

Detector: Silicon photovoltaic

Stray light: <0.02 NTU

Display: 4-digit, 14-segment customized LCD

Sample vials: borosilicate glass with screw caps, fill line, and indexing mark. 2"H x 1" dia (51 x 25 mm)

Sample volume: 10 mL (0.33 oz) minimum

Operating temperature range: 0 to 50°C (32 to 122°F)

Operating humidity: 0 to 90% RH, noncondensing at 30°C (86°F) range

Power: four AAA alkaline batteries (included), >1200 measurements

Enclosure: ABS plastic/IP67 rated

Dimensions (W x L x H)

Meter: 2 3/4" x 6 1/8" x 1 1/8" (6.8 x 15.5 x 4.6 cm)

Meter with case: 6 1/2" x 14" x 4 1/4" (16.5 x 35.5 x 10.5 cm)

Weight

Meter: 7 oz (200 g); **Meter with case:** 2.75 lb (1.25 kg)



Index markings on the cuvettes make it easy to perform repeatable measurements.



Kit includes standards, sample vials, and a rugged carrying case.

Ordering Information

Catalog number	Description	Included
WD-35635-05	T-100 turbidity meter	Meter, three empty cuvettes with light shield caps, collection bottle, lint-free cloth, silicone oil, batteries, and hard carrying case
WD-35635-00	T-100 turbidity meter kit	Meter, four primary calibration standards (0.02, 20.0, 100, and 800 NTU), three empty cuvettes with light shield caps, collection bottle, lint-free cloth, silicone oil, batteries, and hard carrying case

Accessories

WD-35635-52 Replacement calibration set, includes 4 x 60 mL bottles of 0.02, 20.0, 100, and 800 NTU standards

WD-35653-55 Replacement cuvettes, borosilicate glass. Pack of three

C201 and C301 Multiparameter Colorimeters

Multiparameter measurement for convenient field testing

Convenient, foil pack reagents – Follows US EPA method 330.5 for wastewater, and Standard Method 4500-Cl G for drinking water

Simple to use – One-time blanking for multiple measurements

Waterproof and dustproof IP67 housing – Even the sample chamber is waterproof

Compact size – Take your Oakton colorimeter anywhere!

No detachable parts and no light shield required – Vial cap prevents stray light from affecting readings

Large, easy-to-read display – Large, custom LCD displays readings with units of measure and user-friendly message codes that guide meter operation

Advanced power-supply management – Measures over 1200 samples with a single set of batteries, delivering quick, stable results in less than six seconds. Also features auto-off function.

Sturdy carrying case with accessories – Compact carrying case includes all items necessary for colorimeter measurements and protects the meter when not in use



ISO 9001:2008
CERTIFIED SUPPLIER

CE 2 year warranty

Specifications

Model	C201 colorimeter	C301 colorimeter
Chlorine (free and total)		
Range	0 to 1.99 ppm; 2.0 to 6.0 ppm	0 to 1.99 ppm; 2.0 to 6.0 ppm
Resolution	0.01 ppm; 0.1 ppm	0.01 ppm; 0.1 ppm
Accuracy	±0.02 ppm, ±0.2 ppm	±0.02 ppm, ±0.2 ppm
pH		
Range	—	5.9 to 8.2 pH
Resolution	—	0.1 pH
Accuracy	—	±0.1 pH

Light source: light emitting diode (LED)
Wavelength: 525 nm
Detector: silicon photodiode
Absorbance range: 0 to 2.5 Abs
Photometric precision: ±0.0015 Abs
Calibration points: user-selectable, one point per colorimetric test
Sample volume required: 10 mL (0.33 oz)
Display: 4-digit, 14-segment, customized LCD with annunciators
Operating temperature range: 0 to 50°C (32 to 122°F)

Operating humidity range: 0 to 90% RH, noncondensing at 30°C (86°F)
Power supply: four AAA alkaline batteries (included)
Battery life: >3000 tests
Electromagnetic compliance: (EMC) EN 61326
Dimensions
Meter: 6 1/8" L x 2 3/8" W x 1 3/4" H (15.5 x 6.8 x 4.6 cm)
Meter with case: 13 3/4" x 6 1/4" x 4 3/4" (35 x 16 x 12 cm)
Weight
Meter: 7 oz (200 g); **Meter with case:** 2.75 lb (1.25 kg)



Colorimeters include case and reagents.

Ordering Information

Catalog number	Description	Included
WD-35645-20	C201 chlorine colorimeter kit	Meter, foil pack reagents (100 each for free chlorine and total chlorine), sample vials, batteries, and hard carrying case
WD-35645-30	C301 chlorine/pH colorimeter kit	Meter, foil pack reagents (100 each for free chlorine and total chlorine), pH dropper bottle reagent (50 tests), sample vials, batteries, and hard carrying case

Accessories

WD-35645-60 pH reagent includes dropper bottle with reagent for 50 tests
 WD-35645-64 Free chlorine reagent includes individual foil packs for 100 tests
 WD-35645-66 Total chlorine reagent includes individual foil packs for 100 tests
 WD-35645-70 Chlorine secondary standard, includes set of four vials

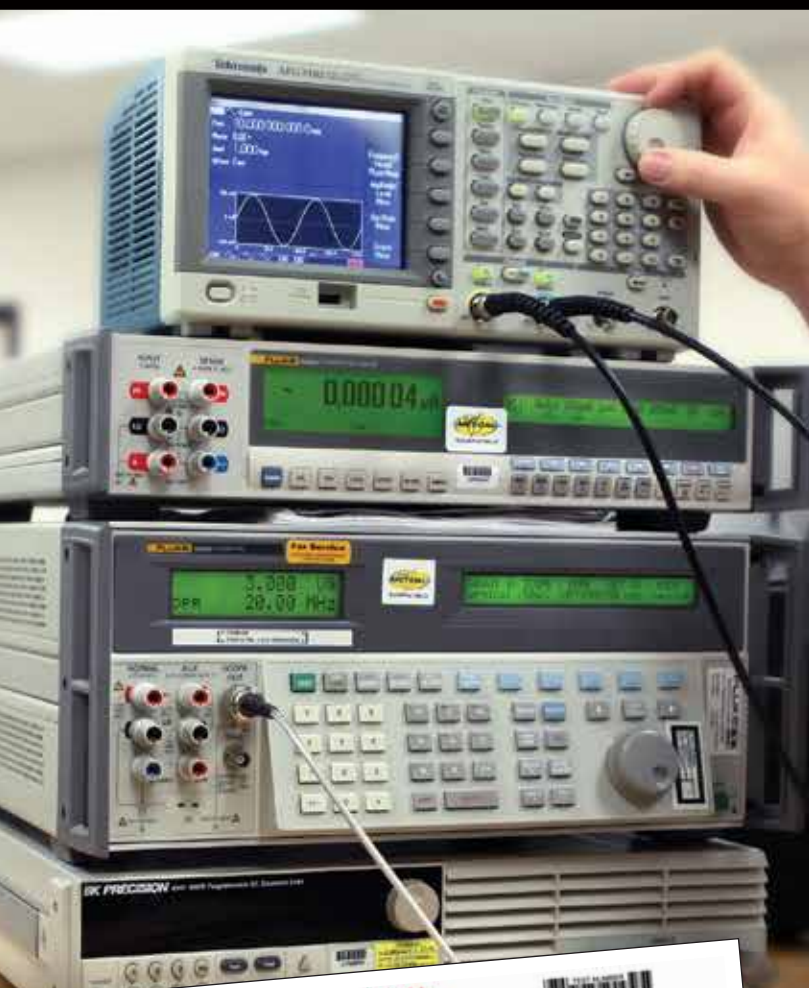

Precalibration

Calibrate your newly purchased item before it ships. Add calibration to your Oakton meter to ensure more accuracy.

Recalibration

Ship us your product. We clean, calibrate, and quickly return it to you with documentation. Convenient reminders alert you when it's time to recalibrate—making sure your product is always in compliance.

On-Site

We come to you. Contact us for pricing.

Trust InnoCal services to fulfill your calibration and equipment repair needs. Our commitment to quality is demonstrated by our utilization of highly trained, experienced metrologists with some of the most advanced methods and standards available. Our A2LA-accredited metrology laboratory has assisted thousands of customers meet ISO, FDA, USDA, EPA, GLPs/cGMPs, and other quality standards.

Calibration Traceable to NIST

Get your product calibrated with the documentation you require to meet your most stringent quality requirements. We will calibrate your new or existing instruments traceable to NIST standards and all reports are ISO 17025 compliant—at no additional charge.

See a sample calibration report and test data at InnoCalSolutions.com/Report

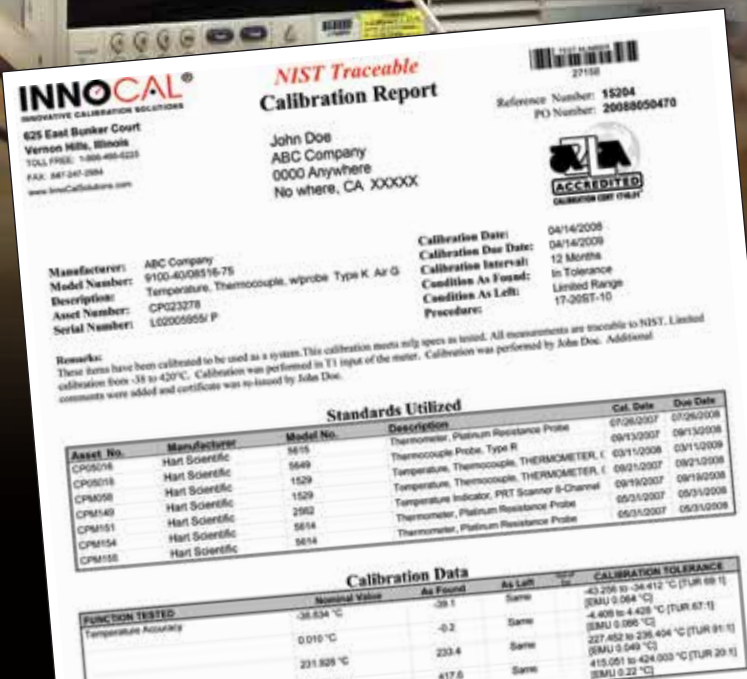

NIST-Traceable Reports

NIST-traceable report for:	Calibration test points	Catalog number
pH pocket meter (non-BNC)	Up to three points against NIST-traceable buffers	WD-17101-45
pH simulator	Up to five electrical test points	WD-17106-06
pH meter (BNC connection)	Five electrical pH and five mV test points	WD-17106-20
pH temperature probe	Three test points	WD-17106-21
Conductivity meter	Five electrical test points	WD-17090-30



Conformity*

ANSI/ISO/IEC 17025:2005 accredited
NIST Handbook 150, 2000 Edition
ANSI/NCSL Z540-2-1997
NIST Technical Note 1297 ISO 9000:2000

*Please check our scope of accreditation for any limitations.

Contact us for more information!
888-40AKTON
(888-462-5866)

00606-10.....43	35408-57.....54	35418-86.....56	35423-10.....3	35606-53.....43	35613-55.....11
00653-00.....50	35408-57.....56	35418-90.....16	35425-00.....9	35606-55.....36	35613-80.....12
00653-04.....22	35408-57.....57	35418-91.....16	35425-05.....9	35606-55.....37	35613-81.....12
00653-04.....27	35408-70.....40	35419-00.....18	35425-10.....9	35606-55.....43	35613-82.....12
00653-06.....22	35408-71.....40	35419-01.....18	35425-50.....9	35606-57.....36	35613-83.....12
00653-06.....27	35408-80.....40	35419-03.....18	35431-00.....54	35606-57.....37	35614-30.....13
00653-15.....43	35408-81.....40	35419-05.....18	35431-01.....54	35606-57.....43	35614-32.....13
00653-16.....43	35411-00.....41	35419-10.....18	35431-02.....53	35607-32.....38	35614-33.....13
00653-18.....43	35411-01.....41	35419-11.....18	35431-03.....54	35607-34.....38	35614-34.....13
00653-20.....43	35412-00.....42	35419-12.....18	35431-70.....54	35607-58.....43	35614-50.....13
00653-23.....43	35412-01.....42	35419-15.....18	35431-71.....54	35607-90.....38	35614-50.....14
00653-27.....43	35412-10.....41	35419-20.....19	35432-00.....55	35607-91.....38	35614-50.....22
00653-32.....43	35412-10.....43	35419-22.....19	35432-01.....55	35608-32.....39	35614-50.....38
00653-47.....43	35412-10.....59	35419-23.....19	35432-02.....55	35608-34.....39	35614-50.....39
00653-50.....43	35413-00.....58	35419-24.....19	35432-03.....55	35608-50.....38	35614-50.....52
00653-89.....43	35413-01.....58	35419-26.....19	35432-70.....55	35608-50.....39	35614-51.....13
00654-00.....22	35413-20.....57	35419-27.....19	35432-71.....55	35608-50.....43	35614-51.....14
00654-01.....22	35413-21.....58	35420-01.....14	35433-00.....56	35608-50.....52	35614-51.....38
00654-04.....22	35414-00.....59	35420-01.....20	35433-01.....56	35608-51.....38	35614-51.....39
00654-08.....22	35414-01.....59	35420-01.....21	35433-02.....55	35608-51.....39	35614-51.....46
00654-12.....22	35414-20.....59	35420-01.....39	35433-03.....56	35608-51.....43	35614-90.....13
05942-10.....22	35414-21.....59	35420-01.....42	35433-70.....56	35608-51.....52	35614-91.....13
05942-29.....22	35415-00.....48	35420-01.....46	35433-71.....56	35608-51.....52	35618-05.....14
05942-49.....22	35415-01.....48	35420-01.....49	35434-00.....57	35608-51.....53	35618-05.....25
05942-69.....22	35416-00.....49	35420-01.....52	35434-01.....57	35608-52.....43	35618-05.....52
09376-01.....13	35416-01.....49	35420-01.....53	35434-02.....56	35608-55.....38	35618-05.....53
09376-01.....14	35418-00.....15	35420-01.....59	35434-03.....57	35608-55.....39	35618-30.....14
09376-01.....38	35418-01.....15	35420-20.....20	35434-70.....57	35608-55.....43	35618-32.....14
09376-01.....39	35418-02.....15	35420-21.....20	35434-71.....57	35608-55.....52	35618-33.....14
09376-01.....46	35418-03.....15	35420-22.....20	35434-85.....54	35608-57.....43	35618-34.....14
09376-01.....52	35418-05.....15	35420-23.....20	35434-85.....55	35608-72.....41	35618-90.....14
09376-01.....53	35418-05.....16	35420-50.....20	35434-85.....56	35608-72.....43	35618-91.....14
09377-16.....3	35418-05.....25	35420-50.....21	35434-85.....57	35608-74.....41	35622-59.....22
09377-16.....6	35418-05.....54	35420-50.....22	35434-90.....57	35608-74.....43	35624-38.....5
09377-16.....7	35418-05.....55	35420-51.....22	35441-00.....47	35608-76.....41	35624-45.....32
09377-16.....8	35418-05.....57	35420-54.....18	35441-01.....47	35608-76.....43	35624-45.....33
09377-16.....9	35418-10.....15	35420-54.....19	35441-02.....47	35608-76.....62	35624-45.....34
09377-16.....31	35418-11.....15	35420-54.....27	35441-03.....47	35608-78.....41	35624-70.....3
09377-16.....32	35418-12.....15	35420-54.....41	35441-70.....47	35608-78.....43	35624-70.....6
09377-16.....33	35418-13.....15	35420-54.....48	35441-71.....47	35608-80.....39	35624-70.....7
09377-16.....34	35418-20.....16	35420-71.....26	35462-10.....31	35608-81.....39	35630-10.....52
34618-05.....13	35418-21.....16	35420-72.....13	35462-15.....31	35608-90.....43	35630-11.....52
35408-00.....40	35418-22.....16	35420-72.....14	35462-30.....31	35608-92.....43	35630-12.....52
35408-01.....40	35418-23.....16	35420-72.....18	35462-35.....31	35608-94.....43	35630-13.....52
35408-02.....40	35418-70.....15	35420-72.....19	35462-50.....31	35613-05.....11	35630-51.....52
35408-03.....40	35418-71.....15	35420-72.....38	35604-00.....36	35613-05.....12	35630-52.....54
35408-10.....40	35418-80.....15	35420-72.....39	35604-01.....36	35613-05.....25	35630-53.....14
35408-11.....40	35418-81.....15	35420-72.....41	35604-04.....36	35613-13.....25	35630-53.....20
35408-12.....40	35418-83.....15	35420-72.....46	35604-05.....36	35613-20.....11	35630-53.....21
35408-13.....40	35418-83.....16	35420-72.....48	35604-20.....37	35613-22.....11	35630-53.....39
35408-50.....40	35418-83.....40	35420-72.....49	35604-21.....37	35613-24.....11	35630-53.....42
35408-50.....43	35418-83.....47	35420-72.....52	35604-24.....37	35613-41.....11	35630-53.....46
35408-52.....40	35418-83.....54	35420-72.....53	35604-25.....37	35613-42.....11	35630-53.....49
35408-52.....43	35418-83.....55	35420-82.....48	35604-40.....37	35613-44.....11	35630-53.....52
35408-54.....40	35418-83.....56	35420-82.....50	35604-41.....37	35613-50.....11	35630-53.....53
35408-54.....43	35418-83.....57	35421-00.....21	35604-44.....37	35613-51.....11	35630-53.....59
35408-56.....40	35418-86.....40	35421-01.....21	35604-45.....37	35613-52.....11	35630-80.....52
35408-56.....43	35418-86.....47	35421-02.....21	35606-53.....36	35613-53.....11	35630-81.....52
35408-57.....43	35418-86.....55	35421-03.....21	35606-53.....37	35613-54.....11	35630-90.....52

35630-91 52	35641-51 25	35801-71 25	35803-28 29	35804-03 7	35808-89 27
35632-30 53	35641-51 50	35801-72 25	35803-30 29	35804-03 26	35808-90 27
35632-31 53	35642-50 45	35801-76 25	35803-32 29	35804-05 26	35811-71 11
35632-32 52	35642-50 47	35801-79 25	35803-34 29	35804-06 26	35811-71 12
35632-34 53	35642-50 50	35801-85 26	35803-35 29	35804-08 7	35811-71 25
35632-80 53	35642-52 50	35802-00 14	35803-50 28	35804-10 7	35811-72 25
35632-81 53	35642-54 50	35802-00 28	35803-51 28	35804-10 27	35811-74 25
35632-97 36	35642-55 45	35802-03 28	35803-51 28	35805-01 25	35812-02 28
35632-97 37	35642-55 50	35802-05 28	35803-51 28	35805-04 20	35812-04 28
35634-10 5	35643-10 43	35802-07 28	35803-51 29	35805-04 21	35812-06 28
35634-14 7	35643-11 45	35802-09 28	35803-51 29	35805-04 25	35812-08 28
35634-20 5	35643-12 45	35802-10 28	35803-51 29	35805-04 58	35812-12 28
35634-30 5	35643-13 45	35802-12 14	35803-52 28	35805-05 25	35812-14 28
35634-40 6	35643-14 45	35802-17 28	35803-52 29	35805-06 25	35812-16 28
35634-50 6	35643-15 45	35802-18 14	35803-53 28	35805-08 25	35812-18 28
35634-70 5	35645-20 62	35802-19 28	35803-53 29	35805-09 25	35812-22 29
35634-80 5	35645-30 62	35802-23 29	35803-54 29	35805-13 8	35812-24 29
35634-90 5	35645-60 60	35802-25 29	35803-55 28	35805-13 26	35812-30 29
35635-00 61	35645-60 61	35802-31 29	35803-56 29	35805-15 26	35812-34 29
35635-05 60	35645-62 60	35802-32 29	35803-57 29	35805-18 26	35812-38 29
35635-52 60	35645-64 60	35802-35 29	35803-58 28	35805-19 27	35812-40 29
35635-52 61	35645-64 62	35802-39 29	35803-59 29	35805-20 27	35812-42 29
35640-30 46	35645-66 60	35802-41 29	35803-60 29	35805-21 26	35812-44 29
35640-31 46	35645-66 62	35802-43 29	35803-60 29	35805-22 26	35812-48 29
35640-32 45	35645-70 60	35802-45 29	35803-60 29	35805-23 26	35816-71 15
35640-34 46	35645-70 62	35802-49 29	35803-73 22	35805-23 53	35816-71 16
35640-50 46	35650-09 8	35802-50 28	35803-73 27	35805-24 26	35816-71 25
35640-50 50	35650-10 8	35802-53 28	35803-74 22	35805-25 26	35816-72 15
35640-50 55	35650-14 8	35802-55 28	35803-74 27	35805-26 27	35816-72 16
35640-50 56	35653-00 22	35802-57 28	35803-83 22	35805-27 26	35816-72 25
35640-50 57	35653-00 43	35802-59 28	35803-83 27	35805-50 22	35816-77 54
35640-51 46	35653-01 22	35802-60 28	35803-84 22	35805-50 27	35816-77 54
35640-51 49	35653-02 22	35802-63 28	35803-84 27	35805-70 27	35816-77 57
35640-51 53	35653-03 22	35802-65 28	35804-00 7	35805-72 27	35820-64 27
35640-52 50	35653-04 22	35802-69 28	35804-00 11	35808-71 13	35820-64 48
35640-53 46	35653-09 42	35802-71 29	35804-00 25	35808-71 14	53109-55 50
35640-53 53	35653-10 43	35802-73 29	35804-01 26	35808-71 25	
35640-54 50	35653-11 43	35802-75 29	35804-02 7	35808-72 13	
35640-55 46	35653-12 43	35802-79 29	35804-02 25	35808-72 14	
35640-55 53	35653-13 43	35802-82 29		35808-72 25	
35640-56 50	35653-15 34	35802-85 29			
35640-57 46	35653-15 43	35802-89 29			
35640-57 53	35653-55 59	35802-91 29			
35640-58 46	35653-55 61	35802-93 29			
35640-58 50	35661-08 32	35802-95 29			
35640-58 53	35661-08 33	35802-99 29			
35640-59 46	35661-17 32	35803-01 28			
35640-59 50	35661-17 33	35803-03 28			
35640-59 53	35661-17 34	35803-05 28			
35640-70 50	35661-70 31	35803-05 29			
35640-71 45	35661-70 32	35803-07 28			
35640-71 50	35661-70 33	35803-09 28			
35640-72 50	35661-70 34	35803-11 28			
35640-74 50	35662-10 32	35803-13 28			
35640-75 50	35662-15 32	35803-15 29			
35640-79 50	35662-30 33	35803-17 29			
35640-80 50	35662-35 33	35803-20 29			
35640-90 46	35662-52 34	35803-24 29			
35640-91 46	35801-00 25	35803-26 29			

Visit us online at
Log on to www.4oakton.com
for product pricing,
technical data, and
customer assistance.



LOOK AT WHAT'S **New** FOR 2014!

Get MORE for your Money

150 Series Handheld Meters

Rugged, waterproof housing is ideal for any environment. Work hands-free with the built-in stand and wall-mount option, allowing you to handle other tasks simultaneously. Large, three-line LCD lets you read more data at a glance, while storing up to 150 measurements and temperature for later recall.

See pages 13 and 38.

Easier to Read

450 Series Handheld Meters

Large, backlit display features intuitive, user-friendly icons. Meet all of your GLP requirements with time-date stamp, while storing up to 500 data sets for easy download to your computer. Rugged design allows for use in any environment.

See pages 14, 39, 46, 52, and 53.

Eliminate Membranes and Solutions

Waterproof RDO Meter

Optical RDO technology provides fast response times, while minimizing maintenance costs and downtime. Store up to 500 data sets for easy download to your computer for further analysis. Rugged, IP67-rated housing is ideal for field applications.

See page 46.



ORDER FROM:

OAKTON[®]
INSTRUMENTS



99999-15

Oakton® 2014. Printed in the U.S.A. 07/14 Oakton TM Reg. #1,692,543. We reserve the right to make changes, improvements and modifications to products shown. Oakton Instruments are available only through authorized Oakton distributors.