

Keysight 1000B Series Oscilloscopes

Service
Guide

Notices

© Keysight Technologies, Inc. 2012-2013

No part of this manual may be reproduced in any form or by any means (including electronic storage and retrieval or translation into a foreign language) without prior agreement and written consent from Keysight Technologies, Inc. as governed by United States and international copyright laws.

Manual Part Number

54139-97015

Edition

Third Edition, April 2013

Printed in Available in electronic format only

Keysight Technologies, Inc.
1900 Garden of the Gods Road
Colorado Springs, CO 80907 USA

Warranty

The material contained in this document is provided “as is,” and is subject to being changed, without notice, in future editions. Further, to the maximum extent permitted by applicable law, Keysight disclaims all warranties, either express or implied, with regard to this manual and any information contained herein, including but not limited to the implied warranties of merchantability and fitness for a particular purpose. Keysight shall not be liable for errors or for incidental or consequential damages in connection with the furnishing, use, or performance of this document or of any information contained herein. Should Keysight and the user have a separate written agreement with warranty terms covering the material in this document that conflict with these terms, the warranty terms in the separate agreement shall control.

Technology Licenses

The hardware and/or software described in this document are furnished under a license and may be used or copied only in accordance with the terms of such license.

Restricted Rights Legend

If software is for use in the performance of a U.S. Government prime contract or subcontract, Software is delivered and licensed as “Commercial computer software” as defined in DFAR 252.227-7014 (June 1995), or as a “commercial item” as defined in FAR 2.101(a) or as “Restricted computer software” as defined in FAR 52.227-19 (June 1987) or any equivalent agency regulation or contract clause. Use, duplication or disclosure of Software is subject to Keysight Technologies’ standard commercial license terms, and non-DOD Departments and Agencies of the U.S. Government will receive no greater than Restricted Rights as defined in FAR 52.227-19(c)(1-2) (June 1987). U.S. Government users will receive no greater than Limited Rights as defined in FAR 52.227-14

(June 1987) or DFAR 252.227-7015 (b)(2) (November 1995), as applicable in any technical data.

Safety Notices

CAUTION

A **CAUTION** notice denotes a hazard. It calls attention to an operating procedure, practice, or the like that, if not correctly performed or adhered to, could result in damage to the product or loss of important data. Do not proceed beyond a **CAUTION** notice until the indicated conditions are fully understood and met.

WARNING

A **WARNING** notice denotes a hazard. It calls attention to an operating procedure, practice, or the like that, if not correctly performed or adhered to, could result in personal injury or death. Do not proceed beyond a **WARNING** notice until the indicated conditions are fully understood and met.

See also [Appendix A](#), “Safety Notices,” starting on page 41.

Keysight 1000B Series Oscilloscopes—At a Glance

The Keysight 1000B Series oscilloscopes are low-cost portable digital storage oscilloscopes (DSOs) that deliver these powerful features:

- Channel counts, input bandwidths, sample rates, and memory depths shown in the following table:

Table 1 Keysight 1000B Series Oscilloscope Models

Model	Channels	Input Band width	Sample Rate (2 channels on-1 channel on)	Memory (2 channels on-1 channel on)
DSO1052B	2	50 MHz	500 MSa/s-1 GSa/s	8-16 kpts
DSO1072B	2	70 MHz	500 MSa/s-1 GSa/s	8-16 kpts
DSO1102B	2	100 MHz	500 MSa/s-1 GSa/s	8-16 kpts
DSO1152B	2	150 MHz	500 MSa/s-1 GSa/s	8-16 kpts

- Bright 5.7 inch QVGA (320 x 240) TFT color LED display and small footprint (to save bench space).
- Up to 400 wfms/s refresh rate.
- Automatic voltage and time measurements (22) and cursor measurements.
- Powerful triggering (edge, pulse width, video, and alternate modes) with adjustable sensitivity (to filter noise and avoid false triggers).
- Math function waveforms: add, subtract, multiply, FFT.
- USB ports (host and device) for easy printing, saving, and sharing of waveforms, setups, screen BMP files, and CSV data files.
- Internal storage for 10 waveforms and 10 setups.
- Special digital filter and waveform recorder.
- Built-in 6-digit hardware frequency counter.
- Multi-language (11) user interface menus and built-in help.

In This Book

This guide contains service information for the Keysight 1000B Series oscilloscopes.

1 Service

Describes oscilloscope maintenance, performance testing, and what to do if your oscilloscope requires service.

Contents

	Keysight 1000B Series Oscilloscopes—At a Glance	3
	In This Book	4
	Figures	7
	Tables	9
1	Service	11
	Cleaning the Oscilloscope	12
	Testing Performance	13
	Before Testing Performance	14
	To test DC gain accuracy	16
	To test analog band width, maximum frequency	21
	To test time scale accuracy	29
	To test trigger sensitivity	32
	Performance Test Record	35
	Returning the Oscilloscope to Keysight for Service	38
	Contacting Keysight	39
A	Safety Notices	41
	Warnings	41
	Safety Symbols	42
	Index	43

Contents

Figures

Figure 1. Averages Menu Item	17
Figure 2. Connecting Equipment for DC Gain Accuracy Test	18
Figure 3. Vavg Menu Item	19
Figure 4. Connecting Equipment for Maximum Frequency Check Test	23
Figure 5. Channel 1 Vertical Scale Setting	24
Figure 6. Channel 1 Horizontal Scale Setting	24
Figure 7. Averages Menu Item	25
Figure 8. Signal Generator Waveform	26
Figure 9. Connecting Equipment for Time Scale Accuracy Test	30
Figure 10. Connecting Equipment for Trigger Sensitivity Test	33

Figures

Tables

Table 1. Keysight 1000B Series Oscilloscope Models	3
Table 2. Equipment Required to Perform All Tests	14
Table 3. DC Gain Accuracy Specification	16
Table 4. Equipment Required for DC Gain Accuracy Test	16
Table 5. Analog Bandwidth Specification	21
Table 6. Equipment Required for Analog Bandwidth Test	22
Table 7. Oscilloscope Models and Signal Generator Frequency	27
Table 8. Time Scale Accuracy Specification	29
Table 9. Equipment Required for Time Scale Accuracy Test	29
Table 10. Trigger Sensitivity Specification	32
Table 11. Equipment Required for Trigger Sensitivity Test	32
Table 12. Performance Test Information	35
Table 13. DC Gain Test	35
Table 14. Analog Bandwidth - Maximum Frequency Check	36
Table 15. Time Scale Accuracy	37
Table 16. Trigger Sensitivity	37

Tables

1 Service

Cleaning the Oscilloscope	12
Testing Performance	13
Performance Test Record	35
Returning the Oscilloscope to Keysight for Service	38
Contacting Keysight	39

This chapter describes oscilloscope maintenance, performance testing, and what to do if your oscilloscope requires service.

Cleaning the Oscilloscope

If the instrument requires cleaning:

- 1 Remove power from the instrument.
- 2 Clean the external surfaces of the instrument with a soft cloth dampened with a mixture of mild detergent and water.

CAUTION

Do not use too much liquid in cleaning the oscilloscope. Water can enter the oscilloscope's front panel, damaging sensitive electronic components.

- 3 Make sure that the instrument is completely dry before reconnecting it to a power source.

Testing Performance

This section documents performance test procedures. Performance verification for the products covered by this manual consists of three main steps:

- Performing the internal product self-tests to ensure that the measurement system is functioning properly.
- Calibrating the product.
- Testing the product to ensure that it is performing to specification.

Performance Test Interval The procedures in this section may be performed for incoming inspection and should be performed periodically to verify that the oscilloscope is operating within specification. The recommended test interval is once per year or after 2000 hours of operation. Performance should also be tested after repairs or major upgrades.

Performance Test Record A test record form is provided at the end of this section. This record lists performance tests, test limits and provides space to record test results.

Test Order The tests in this section may be performed in any order desired. However, it is recommended to conduct the tests in the order presented in this manual as this represents an incremental approach to performance verification. This may be useful if you are attempting to troubleshoot a suspected problem.

Test Equipment Lists of equipment needed to conduct each test are provided for each test procedure. The procedures are written to minimize the number and types of oscilloscopes and accessories required. The oscilloscopes in these lists are ones that are currently available for sale by Keysight at the time of writing this document. In some cases, the test procedures use features specific to the oscilloscopes in the recommended equipment list. However, with some modification to the test procedures, oscilloscopes, cables and accessories that satisfy the critical specifications in these lists may be substituted for the recommended models with some modification to the test procedures.

Contact Keysight Technologies (see [page 39](#)) for more information about the Keysight products in these lists.

1 Service

Before Testing Performance

Table 2 Equipment Required to Perform All Tests

Description	Required for Test	Critical Specifications	Recommended Model/Part Numbers
Digital Multimeter	DC Gain Accuracy	DC voltage measurement accuracy better than $\pm 0.1\%$ of reading	Keysight 34401A
Power Supply	DC Gain Accuracy	0 V to 35 V DC; 10 mV resolution	Keysight E3633A or Keysight E3634A
Signal Generator	Analog Band width Time Scale Accuracy Trigger Sensitivity	100 kHz to 1 GHz at 200 mVrms, 0.01 Hz frequency resolution, jitter: < 2 ps	Keysight 8648A, Keysight E4400B, or Keysight N5181A.
Power Meter	Analog Band width	Keysight E-series with power sensor compatibility	Keysight E4418B
Power Sensor	Analog Band width	100 kHz to 1 GHz $\pm 3\%$ accuracy	Keysight 8482A
Power Splitter	Analog Band width	Outputs differ by < 0.15 dB	Keysight 11667B
BNC Cable	DC Gain Accuracy (qty 2) Time Scale Accuracy Trigger Sensitivity	50 Ω characteristic impedance, BNC (m) connectors	Keysight 8120-1840, Keysight 10503A
BNC Tee Adapter	DC Gain Accuracy	BNC Tee (m)(f)(f)	Keysight 1250-0781
BNC to Dual Banana Adapter	DC Gain Accuracy (qty 2)	BNC (f) to dual banana	Keysight 1251-2277
SMA Cable	Analog Band width	SMA (m) to SMA (m) 24 inch	
50 Ω BNC Feed Through Adapter	Analog Band width Trigger Sensitivity	50 Ω BNC (f) to BNC (m) feed through terminator	Keysight 0960-0301
Type-N to SMA Adapter	Analog Band width	Type-N (m) to SMA (f)	Keysight 1250-1250
SMA to BNC Adapter	Analog Band width	SMA (m) to BNC (m)	Keysight 1250-0831
Type-N to BNC Adapter	Trigger Sensitivity	Type-N (m) to BNC (f)	Keysight 1250-0780

NOTE**Let the oscilloscope warm up before testing.**

The oscilloscope under test must be warmed up (with the oscilloscope application running) for at least 30 minutes prior to the start of any performance test.

Calibration

- 1 Push the **[Utility]** key on the front panel.
- 2 In the Utility menu, press **Self-Cal**.
- 3 Follow the on-screen instructions.

To test DC gain accuracy

CAUTION

Ensure that the input voltage to the oscilloscope never exceeds 300 Vrms.

Table 3 DC Gain Accuracy Specification

DC Gain Accuracy	2 mV/div to 5 mV/div: $\pm 4.0\%$ full scale 10 mV/div to 10 V/div: $\pm 3.0\%$ full scale
Full scale is defined as 8 vertical divisions. The major scale settings are 2 mV, 5 mV, 10 mV, 20 mV, 50 mV, 100 mV, 200 mV, 500 mV, 1 V, 2 V, 5 V, and 10 V.	

Table 4 Equipment Required for DC Gain Accuracy Test

Description	Critical Specifications	Recommended Model/Part Numbers
Power Supply	0 V to 35 V DC; 10 mV resolution	Keysight E3633A or Keysight E3634A
Digital Multimeter	DC voltage measurement accuracy better than $\pm 0.1\%$ of reading	Keysight 34401A
BNC Cable (qty 2)	50 Ω characteristic impedance, BNC (m) connectors	Keysight 8120-1840, Keysight 10503A
BNC Tee Adapter	BNC Tee (m)(f)(f)	Keysight 1250-0781
BNC to Dual Banana Adapter (qty 2)	BNC (f) to dual banana	Keysight 1251-2277

- 1 Disconnect all cables from the oscilloscope channel inputs.
- 2 Press the **[Default Setup]** front panel key.
- 3 Press the **[Acquire]** front panel key.
- 4 In the Acquire menu, press the **Acquisition** softkey until “Average” appears.
- 5 Press the **Averages** softkey and turn the  entry knob until “256” appears.

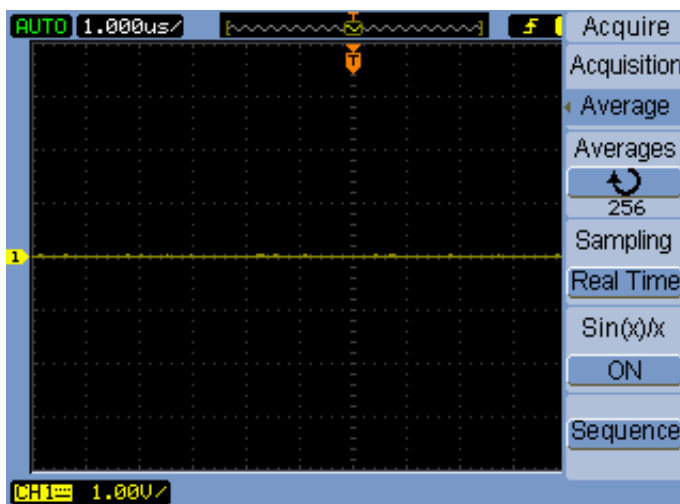

Figure 1 Averages Menu Item

- 6 Set the channel 1 probe attenuation to 1X.
- 7 Set the channel 1 vertical sensitivity value to 2 mV/div.
- 8 Set the power supply to +6 mV.
- 9 Connect the equipment as shown in [Figure 2](#).

1 Service

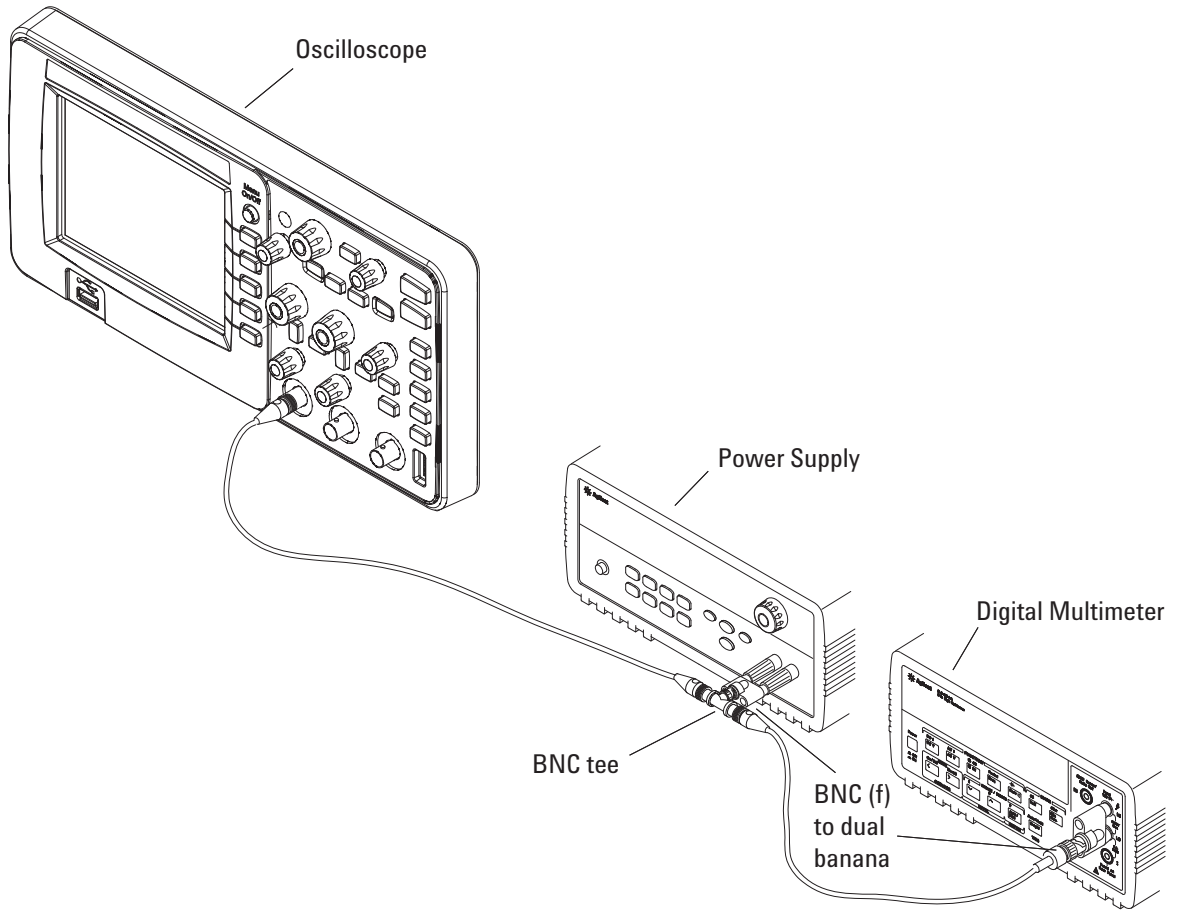



Figure 2 Connecting Equipment for DC Gain Accuracy Test

10 Press **[Measure]**.

11 Press the **Voltage** softkey.

12 Turn the  entry knob to select the **Vavg** measurement as shown below.

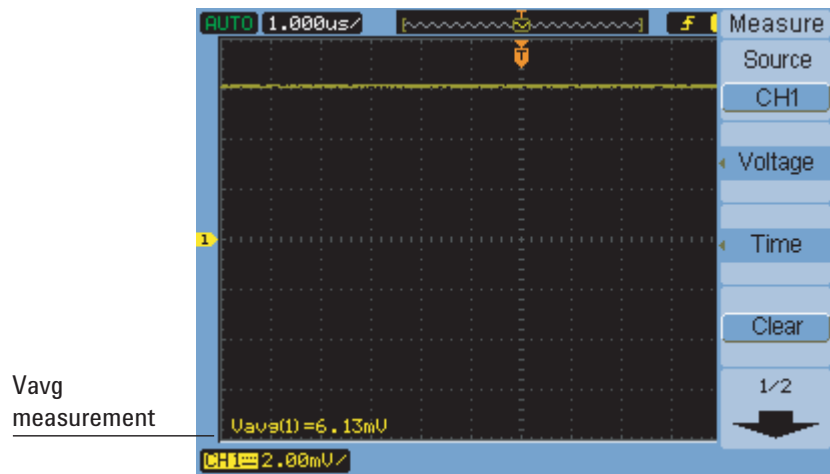



Figure 3 Vavg Menu Item

- 13** For each of channel 1's vertical sensitivities in the DC Gain Test section of the "Performance Test Record" on page 35:
- a** For the positive (+) power supply setting:
 - i** Record the DMM voltage reading as V_{DMM+} .
 - ii** Record the oscilloscope Vavg reading as V_{Scope+} .
 - b** For the negative (-) power supply setting:
 - i** Record the DMM voltage reading as V_{DMM-} .
 - ii** Record the oscilloscope Vavg reading as V_{Scope-} .
 - c** Calculate the DC Gain using the following expression and record this value in the DC Gain Test section of the Performance Test Record:

$$DCGain = \frac{\Delta V_{out}}{\Delta V_{in}} = \frac{V_{scope+} - V_{scope-}}{V_{DMM+} - V_{DMM-}}$$

- 14** Repeat **step 15** through **step 23** for channel 2.
- 15** Set the power supply voltage to +6 mV.
- 16** Move the BNC cable from the previously tested channel to the channel you are currently testing.

- 17 Press the **[Default Setup]** front panel key.
- 18 Set the channel's probe attenuation to 1X.
- 19 Set the channel's vertical sensitivity value to 2 mV/div.
- 20 Press **[Measure]**.
- 21 Press the **Voltage** softkey.
- 22 Turn the  entry knob to select the **Vavg** measurement.
- 23 For each of the channel's vertical sensitivities in the DC Gain Test section of the **"Performance Test Record"** on page 35:
 - a For the positive (+) power supply setting:
 - i Record the DMM voltage reading as VDMM+.
 - ii Record the oscilloscope Vavg reading as VScope+.
 - b For the negative (-) power supply setting:
 - i Record the DMM voltage reading as VDMM-.
 - ii Record the oscilloscope Vavg reading as VScope-.
 - c Calculate the DC Gain using the following expression and record this value in the DC Gain Test section of the Performance Test Record:

$$DCGain = \frac{\Delta V_{out}}{\Delta V_{in}} = \frac{V_{scope+} - V_{scope-}}{V_{DMM+} - V_{DMM-}}$$

To test analog bandwidth, maximum frequency

CAUTION

Ensure that the input voltage to the oscilloscope never exceeds 300 Vrms.

NOTE

This procedure is the only acceptable method for testing the bandwidth of a 1000B Series oscilloscope.

Table 5 Analog Bandwidth Specification

Analog Bandwidth (-3 dB)	
DS01152B	150 MHz
DS01102B	100 MHz
DS01072B	70 MHz
DS01052B	50 MHz

Table 6 Equipment Required for Analog Bandwidth Test

Description	Critical Specifications	Recommended Model/Part Numbers
Signal Generator	100 kHz to 1 GHz at 200 mVrms, 0.01 Hz frequency resolution, jitter: < 2 ps	Keysight 8648A, Keysight E4400B, or Keysight N5181A.
Power Meter	Keysight E-series with power sensor compatibility	Keysight E4418B
Power Sensor	100 kHz to 1 GHz $\pm 3\%$ accuracy	Keysight 8482A
Power Splitter	Outputs differ by < 0.15 dB	Keysight 11667B
SMA Cable	SMA (m) to SMA (m) 24 inch	
50 Ω BNC Feed Through Adapter	50 Ω BNC (f) to BNC (m) feed through terminator	Keysight 0960-0301
Type-N to SMA Adapter	Type-N (m) to SMA (f)	Keysight 1250-1250
SMA to BNC Adapter	SMA (m) to BNC (m)	Keysight 1250-0831

- 1 Connect the equipment as shown in **Figure 4**.

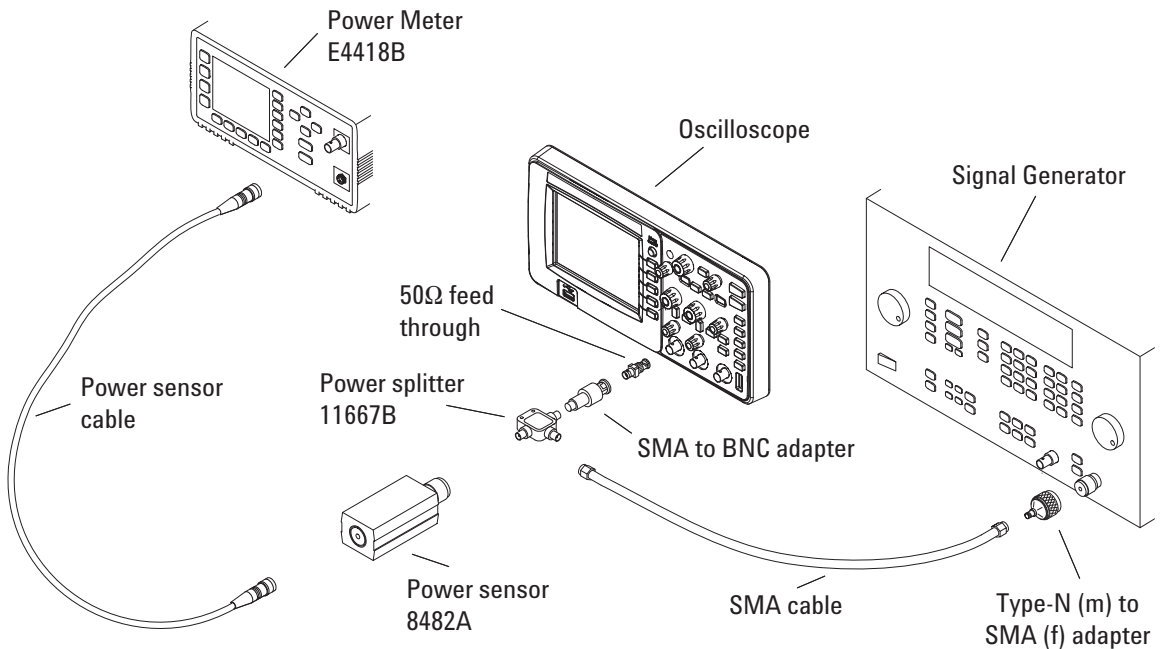

Figure 4 Connecting Equipment for Maximum Frequency Check Test

- 2 Preset and calibrate the power meter according to the instructions found in the power meter manual.
- 3 Set up the Power Meter to display measurements in units of Watts.
- 4 Press the **[Default Setup]** front panel key.
- 5 Press the **[Auto-Scale]** front panel key.
- 6 Set the channel 1 probe attenuation to 1X.
- 7 Set the channel 1 vertical scale to 200 mV/div.

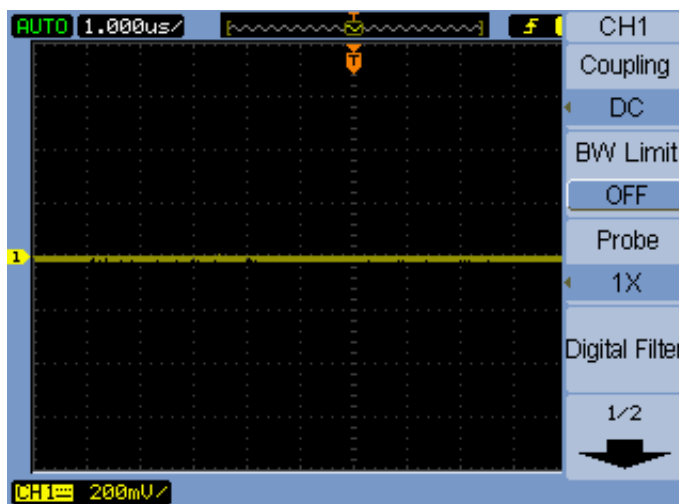

Figure 5 Channel 1 Vertical Scale Setting

8 Set the horizontal scale to 500 ns/div.

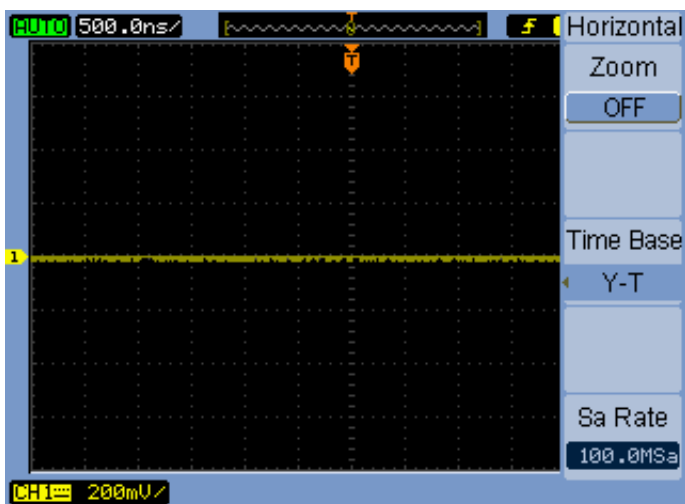

Figure 6 Channel 1 Horizontal Scale Setting



- 9 Press **[Acquire]**.
- 10 Press the **Acquisition** softkey until “Average” appears.
- 11 Press **Average** and turn the  entry knob until “8” appears.



Figure 7 Averages Menu Item

- 12 Press **[Measure]**.
- 13 Press the **Voltage** softkey.
- 14 Turn the  entry knob to select the **Vpp** menu item.
- 15 Set the signal generator to a 1 MHz sine wave with a peak-to-peak amplitude of about 6 divisions as it appears on the oscilloscope screen.

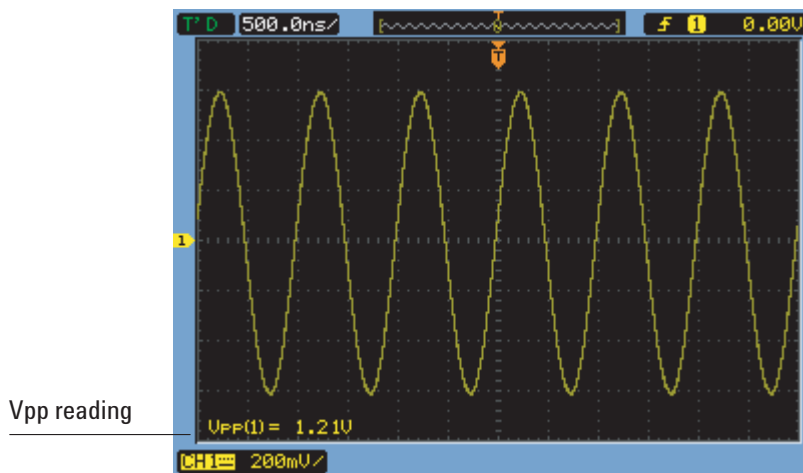

Figure 8 Signal Generator Waveform

- 16** Using the V_{pp} reading, calculate the V_{rms} value using the following expression and record it in the “Performance Test Record” on page 35:

$$V_{out_{1MHz}} = \frac{V_{PP_{1MHz}}}{2\sqrt{2}}$$

For example, if $V_{pp} = 1.20$ V:

$$V_{out_{1MHz}} = \frac{1.20}{2\sqrt{2}} = \frac{1.20}{2.828} = 424 \text{ mV}$$

- 17** Using the power meter reading, convert this measurement to Volts RMS using the expression and record it in the “Performance Test Record” on page 35:

$$V_{in_{1MHz}} = \sqrt{P_{meas} \times 50\Omega}$$

For example, if $P_{meas} = 3.65$ mW:

$$V_{in_{1MHz}} = \sqrt{3.65 \text{ mW} \times 50\Omega} = 427 \text{ mV}$$

18 Calculate the reference gain as follows:

$$Gain_{1MHz} = \frac{V_{out_{1MHz}}}{V_{in_{1MHz}}}$$

Record this value in the Calculated Gain @ 1 MHz column of the “Performance Test Record” on page 35.

19 Change the signal generator frequency to the value for the model being tested as shown in the table below.

Table 7 Oscilloscope Models and Signal Generator Frequency

Setting	Model			
	DS01152B	DS01102B	DS01072B	DS01052B
Frequency	150 MHz	100 MHz	70 MHz	50 MHz
Time Base	2 ns/div	5 ns/div	10 ns/div	10 ns/div

20 Change the oscilloscope time base to the value for the model being tests as shown in the table above.

21 Using the Vpp reading, calculate the Vrms value using the following expression and record it in the “Performance Test Record” on page 35:

$$V_{out_{max}} = \frac{V_{pp_{max}}}{2\sqrt{2}}$$

For example, if Vpp = 1.24 V:

$$V_{out_{max}} = \frac{1.05}{2\sqrt{2}} = \frac{1.05}{2.828} = 371 \text{ mV}$$

22 Using the power meter reading, convert this measurement to Volts RMS using the expression and record it in the “Performance Test Record” on page 35:

$$V_{in_{max}} = \sqrt{P_{meas} \times 50\Omega}$$

For example, if Pmeas = 3.65 mW:

$$V_{in_{max}} = \sqrt{3.65 \text{ mW} \times 50\Omega} = 427 \text{ mV}$$

1 Service

- 23** Calculate the gain at the maximum frequency using the expression and record it in the “Performance Test Record” on page 35:

$$Gain_{max} = 20 \log_{10} \left[\frac{(V_{out_{max}})/(V_{in_{max}})}{Gain_{1MHz}} \right]$$

For example, if (Vout @ Max Frequency) = 371 mV, (Vin @ Max Frequency) = 427 mV and Gain @ 1 MHz = 0.993, then:

$$Gain_{Max\ Freq} = 20 \log_{10} \left[\frac{371\text{ mV}/427\text{ mV}}{0.993} \right] = -1.16\text{ dB}$$

Record this value in the Calculated Gain @Max Freq column in the Analog Bandwidth - Maximum Frequency Check section of the “Performance Test Record” on page 35. To pass this test, this value must be greater than -3.0 dB.

- 24** For the remaining channels, move the power splitter to the channel and repeat steps 4 through 23.

To test time scale accuracy

In this test you measure the absolute error of the timebase oscillator and compare the results to the specification.

Time scale accuracy refers to the absolute accuracy of the oscilloscope's time scale. Because time scale accuracy depends directly on the specifications of a crystal oscillator, it is comprised of these components:

- An initial accuracy component – applies to the oscilloscope's accuracy on the date of its shipment to the customer.
- A temperature component – refers to the ambient temperature in which the oscilloscope operates.
- An aging component – scales linearly from the oscilloscope's manufacture date and adds to the initial accuracy and temperature components.

Table 8 Time Scale Accuracy Specification

Time Scale Accuracy	±50 ppm over 1 ms
---------------------	-------------------

Table 9 Equipment Required for Time Scale Accuracy Test

Description	Critical Specifications	Recommended Model/Part Numbers
Signal Generator	100 kHz - 1 GHz, 0.01 Hz frequency resolution, jitter: < 2 ps	Keysight N5181A, Keysight E4400B, or Keysight 8648A
BNC Cable	50Ω characteristic impedance, BNC (m) connectors	Keysight 8120-1840, Keysight 10503A
Type-N to BNC Adapter	Type-N (m) to BNC (f)	Keysight 1250-0780
50Ω BNC Feed Through Adapter	50Ω BNC (f) to BNC (m) feed through terminator	Keysight 0960-0301

- 1 Set up the signal generator:
 - a Set the output to 10 MHz, approximately 1 Vpp sine wave.
- 2 Connect the output of the signal generator to oscilloscope channel 1 using the BNC cable.

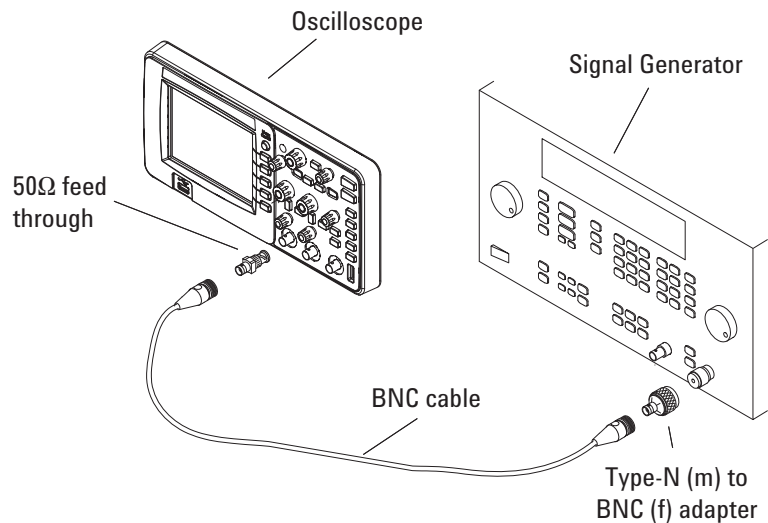

Figure 9 Connecting Equipment for Time Scale Accuracy Test

- 3** Set up the oscilloscope:
 - a** Press **[Auto-Scale]**.
 - b** Set the oscilloscope Channel 1 probe attenuation to 1X.
 - c** Set the oscilloscope Channel 1 vertical sensitivity to 200 mV/div.
 - d** Set the oscilloscope horizontal sweep speed control to 5 ns/div.
 - e** Adjust the intensity to get a sharp, clear trace.
 - f** Adjust the oscilloscope's trigger level so that the rising edge of the waveform at the center of the screen is located where the center horizontal and vertical grid lines cross (center screen).
 - g** Ensure the horizontal position control is set to 0.0 seconds.

- 4 Make the measurement.
 - a Set oscilloscope horizontal sweep speed control to 1 ms/div.
 - b Set horizontal position control to +1 ms (rotate control counter-clockwise).
 - c Set the oscilloscope horizontal sweep speed control to 10 ns/div.
 - d Turn on the zoomed time base by pressing the **[Menu/Zoom]** key followed by the **Zoom** softkey in the Horizontal menu.
 - e Record the number of nanoseconds from where the rising edge crosses the center horizontal grid line to the center vertical grid line. The number of nanoseconds is equivalent to the time scale error in ppm.
 - f Record the result and compare it to the limits in the **“Performance Test Record”** on page 35.

To test trigger sensitivity

This test verifies the trigger sensitivity. In this test, you apply a sine wave to the oscilloscope at the bandwidth limits. You then decrease the amplitude of the signal to the specified levels, and check to see if the oscilloscope is still triggered.

Table 10 Trigger Sensitivity Specification

Trigger sensitivity Ch 1, 2, 3, 4 (DC coupling):	≥ 5 mV/div: 1 div from DC to 10 MHz, 1.5 div from 10 MHz to full bandwidth < 5 mV/div: 1 div from DC to 10 MHz, 1.5 div from 10 MHz to 20 MHz
--------------------------------------------------	---------------------------------------------------------------------------------------------------------------------------------------------------------

Table 11 Equipment Required for Trigger Sensitivity Test

Description	Critical Specifications	Recommended Model/Part Numbers
Signal Generator	100 kHz to 1 GHz at 200 mVrms, 0.01 Hz frequency resolution, jitter: < 2 ps	Keysight 8648A, Keysight E4400B, or Keysight N5181A.
BNC Cable	50 Ω characteristic impedance, BNC (m) connectors	Keysight 8120-1840, Keysight 10503A
Type-N to BNC Adapter	Type-N (m) to BNC (f)	Keysight 1250-0780
50 Ω BNC Feed Through Adapter	50 Ω BNC (f) to BNC (m) feed through terminator	Keysight 0960-0301

- 1 Connect the equipment (see **Figure 10**).
 - a Connect the signal generator output to the oscilloscope channel 1 input.

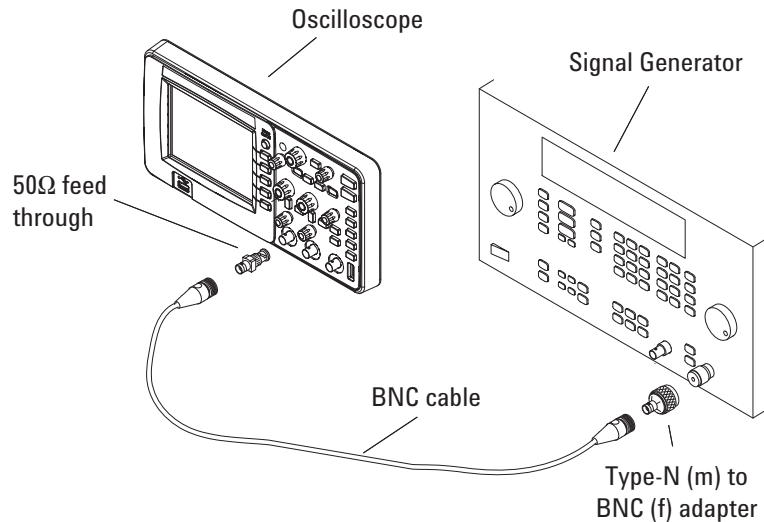

Figure 10 Connecting Equipment for Trigger Sensitivity Test

- 2 Verify the trigger sensitivity when the vertical scale is ≥ 5 mV/div.

For each of the bandwidth boundaries (maximum bandwidth and 10 MHz):

 - a Press the **[Default Setup]** key.
 - b Set the output frequency of the signal generator to the bandwidth boundary and set the amplitude to about 10 mVpp.
 - c Press the **[Auto-Scale]** key.
 - d Set the horizontal scale so that a few cycles of the waveform are displayed.
 - e Set the input channel's probe attenuation to 1X.
 - f Set the input channel's vertical scale to 5 mV/div.
 - g Decrease the amplitude from the signal generator to the specified vertical division (1.5 div at maximum bandwidth or 1 div at 10 MHz).

The trigger is stable when the displayed waveform is stable. If the trigger is not stable, try adjusting the trigger level. If adjusting the trigger level makes the trigger stable, the test still passes.

- h** Record the result as Pass or Fail in the **“Performance Test Record”** on page 35.

Repeat these steps for the remaining oscilloscope channels.

- 3** Verify the trigger sensitivity when the vertical scale is < 5 mV/div.

For each of the bandwidth boundaries (20 MHz and 10 MHz):

- a** Press the **[Default Setup]** key.
- b** Set the output frequency of the signal generator to the bandwidth boundary and set the amplitude to about 10 mVpp.
- c** Press the **[Auto-Scale]** key.
- d** Set the horizontal scale so that a few cycles of the waveform are displayed.
- e** Set the input channel's probe attenuation to 1X.
- f** Set the input channel's vertical scale to 2 mV/div.
- g** Decrease the amplitude from the signal generator to the specified vertical division (1.5 div at 20 MHz or 1 div at 10 MHz).

The trigger is stable when the displayed waveform is stable. If the trigger is not stable, try adjusting the trigger level. If adjusting the trigger level makes the trigger stable, the test still passes.

- h** Record the result as Pass or Fail in the **“Performance Test Record”** on page 35.

Repeat these steps for the remaining oscilloscope channels.

Performance Test Record

Table 12 Performance Test Information

Serial No. _____ Test by _____
 Test Interval _____ Work Order No. _____
 Recommended Next Testing _____ Temperature _____

Table 13 DC Gain Test

Vertical Sensitivity	Power Supply Setting	VDMM+	VDMM-	VScope+	VScope-	Calculated DC Gain	Offset Gain Test Limits
Channel 1							
2 mV/div	±6 mV						+0.96 to +1.04
5 mV/div	±15 mV						+0.96 to +1.04
10 mV/div	±30 mV						+0.97 to +1.03
20 mV/div	±60 mV						+0.97 to +1.03
50 mV/div	±150 mV						+0.97 to +1.03
100 mV/div	±300 mV						+0.97 to +1.03
200 mV/div	±600 mV						+0.97 to +1.03
500 mV/div	±1.5 V						+0.97 to +1.03
1 V/div	±3.0 V						+0.97 to +1.03
2 V/div	±6.0 V						+0.97 to +1.03
5 V/div	±15.0 V						+0.97 to +1.03
10 V/div	±30.0 V						+0.97 to +1.03

1 Service

Table 13 DC Gain Test (continued)

Vertical Sensitivity	Power Supply Setting	VDMM+	VDMM-	VScope+	VScope-	Calculated DC Gain	Offset Gain Test Limits
Channel 2							
2 mV/div	±6 mV						+0.96 to +1.04
5 mV/div	±15 mV						+0.96 to +1.04
10 mV/div	±30 mV						+0.97 to +1.03
20 mV/div	±60 mV						+0.97 to +1.03
50 mV/div	±150 mV						+0.97 to +1.03
100 mV/div	±300 mV						+0.97 to +1.03
200 mV/div	±600 mV						+0.97 to +1.03
500 mV/div	±1.5 V						+0.97 to +1.03
1 V/div	±3.0 V						+0.97 to +1.03
2 V/div	±6.0 V						+0.97 to +1.03
5 V/div	±15.0 V						+0.97 to +1.03
10 V/div	±30.0 V						+0.97 to +1.03

Table 14 Analog Bandwidth - Maximum Frequency Check

	Vin @ 1 MHz	Vout @ 1 MHz	Calculated Gain @ 1 MHz (Test Limit = greater than -3 dB)	Vin @ Max Freq	Vout @ Max Freq	Calculated Gain @ Max Freq (Test Limit = greater than -3 dB)
Channel 1						
Channel 2						
Max frequency: DS01152B = 150 MHz, DS01102B = 100 MHz, DS01072B = 70 MHz, DS01052B = 50 MHz						

Table 15 Time Scale Accuracy

Limits	Measured time scale error (ppm)	Pass/Fail
±50 ppm over 1 ms		

Table 16 Trigger Sensitivity

Test Limits	Ch1	Ch2
≥ 5 mV/div: 1.5 division at maximum bandwidth		
≥ 5 mV/div: 1 division at 10 MHz		
< 5 mV/div: 1.5 division at 20 MHz		
< 5 mV/div: 1 division at 10 MHz		

Returning the Oscilloscope to Keysight for Service

Before shipping the oscilloscope to Keysight Technologies, contact your nearest Keysight Technologies oscilloscope Support Center (or Keysight Technologies Service Center if outside the United States) for additional details.

1 Write the following information on a tag and attach it to the oscilloscope.

- Name and address of owner.
- Oscilloscope model number.
- Oscilloscope serial number.
- Description of the service required or failure indications.

2 Remove all accessories from the oscilloscope.

Accessories include all cables. Do not include accessories unless they are associated with the failure symptoms.

3 Protect the oscilloscope by wrapping it in plastic or heavy paper.

4 Pack the oscilloscope in foam or other shock absorbing material and place it in a strong shipping container.

You can use the original shipping materials or order materials from an Keysight Technologies Sales Office. If neither are available, place 8 to 10 cm (3 to 4 inches) of shock-absorbing material around the oscilloscope and place it in a box that does not allow movement during shipping.

5 Seal the shipping container securely.

6 Mark the shipping container as FRAGILE.

In any correspondence, refer to oscilloscope by model number and full serial number.

Contacting Keysight

Information on contacting Keysight Technologies can be found at www.keysight.com/find/contactus.

1 Service

A Safety Notices

Warnings 41

Safety Symbols 42

This apparatus has been designed and tested in accordance with IEC Publication 1010, Safety Requirements for Measuring Apparatus, and has been supplied in a safe condition. This is a Safety Class I instrument (provided with terminal for protective earthing). Before applying power, verify that the correct safety precautions are taken (see the following warnings). In addition, note the external markings on the instrument that are described under "Safety Symbols."

Warnings

- Before turning on the instrument, you must connect the protective earth terminal of the instrument to the protective conductor of the (mains) power cord. The mains plug shall only be inserted in a socket outlet provided with a protective earth contact. You must not negate the protective action by using an extension cord (power cable) without a protective conductor (grounding). Grounding one conductor of a two-conductor outlet is not sufficient protection.
- Only fuses with the required rated current, voltage, and specified type (normal blow, time delay, etc.) should be used. Do not use repaired fuses or short-circuited fuse holders. To do so could cause a shock or fire hazard.
- If you energize this instrument by an auto transformer (for voltage reduction or mains isolation), the common terminal must be connected to the earth terminal of the power source.
- Whenever it is likely that the ground protection is impaired, you must make the instrument inoperative and secure it against any unintended operation.

A Safety Notices

- Service instructions are for trained service personnel. To avoid dangerous electric shock, do not perform any service unless qualified to do so. Do not attempt internal service or adjustment unless another person, capable of rendering first aid and resuscitation, is present.
- Do not install substitute parts or perform any unauthorized modification to the instrument.
- Capacitors inside the instrument may retain a charge even if the instrument is disconnected from its source of supply.
- Do not operate the instrument in the presence of flammable gasses or fumes. Operation of any electrical instrument in such an environment constitutes a definite safety hazard.
- Do not use the instrument in a manner not specified by the manufacturer.

Safety Symbols



Instruction manual symbol: the product is marked with this symbol when it is necessary for you to refer to the instruction manual in order to protect against damage to the product.



Hazardous voltage symbol.



Earth terminal symbol: Used to indicate a circuit common connected to grounded chassis.

Index

A

analog band width - maximum
frequency check, 21
at a glance, 3

B

built-in help, 3

C

calibration, 15
cleaning the oscilloscope, 12
counter, frequency, 3
cursor measurements, 3

D

DC gain accuracy test, 16
digital filter, 3

E

equipment for performance testing, 13

F

frequency counter, hardware, 3

H

hardware frequency counter, 3

I

input voltage, 16, 21
internal storage, 3

L

LED display, 3

M

math function waveforms, 3
memory, 3, 22
model number, 38

P

performance test interval, 13
performance test record, 13
performance, testing, 13

R

refresh rate, 3

S

safety
notices, 41
symbols, 42
sample rate, 3
serial number, 38
symbols, safety, 42

T

test equipment, 13
testing performance, 13
time measurements, 3
triggering, 3

U

USB ports, 3

V

voltage measurements, 3

W

warnings, 41
waveforms, recording/playing-back, 3

Index

www.keysight.com

© Keysight Technologies, Inc. 2012-2013

Printed in Available in electronic format only
Third Edition, April 2013



54139-97015

