

Best Practice Solution

Fluke 831 Laser Shaft Alignment Tool

PRECISION SHAFT ALIGNMENT MADE EASY

A simple three step process provides machine condition answers without difficult analysis.

- Intuitive guided user interface for quick and complete alignments without extensive alignment education or complicated programs that customers won't use
- Up to 50% of damage to rotating machinery is directly related to misalignment—most customers ignore it and simply replace the bearings and seals
- Flexible couplings do not make up for the misalignment in a machine they simply transfer the forces to the bearings and seals causing rapid wear and failure

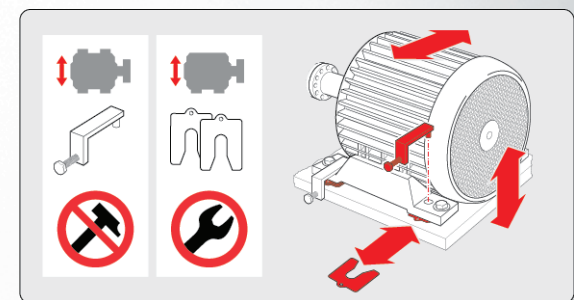
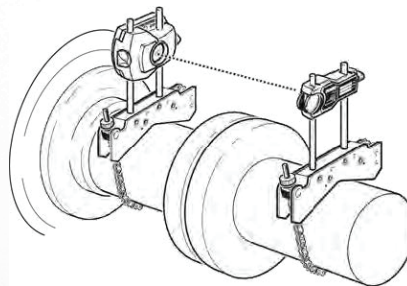
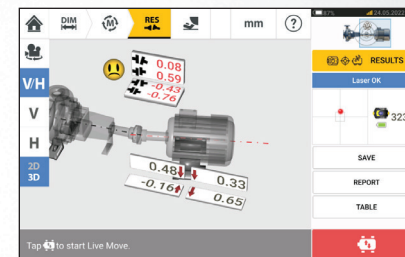
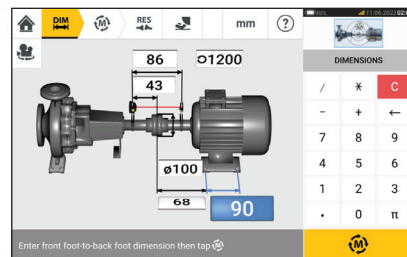

ANSWERS not just data— easy to read report

FLUKE®

Why precision alignment?

Today's maintenance departments can't afford crippling unplanned downtime and wasted energy.

You could be losing thousands of dollars per year in replacement bearings and hours of unnecessary repair time. See the benefits of precision alignment on most of your machines, not just a few of the most critical:

- ✓ Reduce your energy consumption
- ✓ Fewer failures of seals, couplings, and bearings
- ✓ Lower vibration levels— that result in fewer mechanical faults
- ✓ No shaft cracking or failures
- ✓ No loose foundation bolts



Combine the Fluke 831 with the Fluke 835 to align both coupled and belt-drive machines

Precision alignment can provide

UP TO **65 %**
Reduction in seal repairs

UP TO **50 %**
Longer bearing life

UP TO **10 %**
Reduction in energy waste

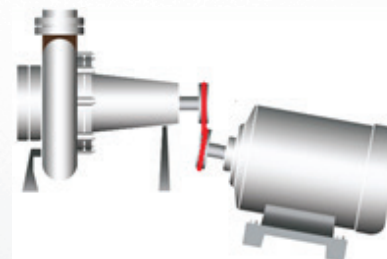
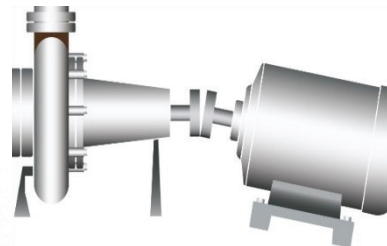

Total condition maintenance in four simple steps: To keep your plant up and running

SCREEN

DIAGNOSE

CORRECT

VERIFY AND REPORT

820-2 LED Stroboscope



805 FC
Vibration Meter



810 Vibration Tester

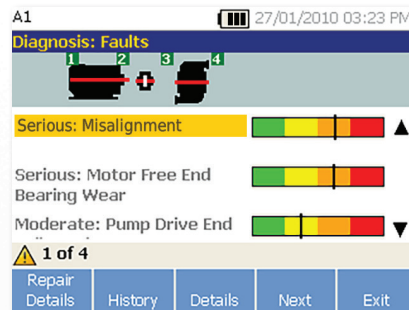

831 & 835 Laser Alignment Tools

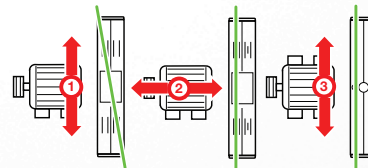
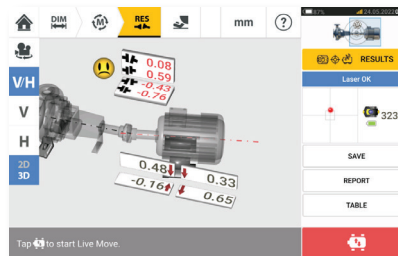

805 FC
Vibration Meter

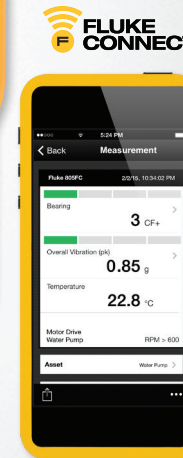

WiFi or cellular service is required to share data. Smartphone, wireless service and data plan not included with purchase. First 5 GB of storage is free. Phone support details can be viewed at fluke.com/phones. The Fluke Connect® system is not available in all countries. Please check availability with your authorized Fluke distributor.

GET ANSWERS NOW

The mechanical family of products

FLUKE®

SCREEN



Fluke 820-2 LED Stroboscope

Rugged, compact and easy-to-use stop motion diagnostic tool

With the Fluke 820-2 LED Stroboscope, investigate and observe potential mechanism failure with confidence on a variety of machinery, in a wide range of industries, without making physical contact with the machine.



Fluke 805 FC Vibration Meter

Make go or no-go maintenance decisions with confidence

The Fluke 805 FC offers frontline mechanical troubleshooting teams a highly reliable and accurate way to check bearings and overall machine health. Instantly upload your data to the Fluke Connect® app and share results—without leaving the field.



DIAGNOSE



Fluke 810 Vibration Tester

Take the advanced vibration expert

The Fluke 810 Vibration Tester empowers mechanical maintenance teams to get immediate answers with a simple step-by-step process that reports on machine faults the first time measurements are taken, without prior measurement history.



CORRECT



Fluke 831 & 835 Laser Alignment Tools

Precision shaft and belt alignment made easy

If you're still using rulers and dial indicators to ensure your rotating machinery is properly aligned, you could be losing thousands of dollars per year. The 831 Laser Shaft Alignment Tool gives you fast, accurate answers to make it easy to take corrective action.



Contact your Fluke distributor for more information

©2022 Fluke Corporation. All trademarks are the property of their respective owners. Smart phone, wireless service and data plan not included with purchase. 6/2022 6013970a-en

Modification of this document is not permitted without written permission from Fluke Corporation.