

# User Manual

## 390B Series

### True RMS Handheld Digital Multimeters



# Compliance Information

---

## **390B, 391B, & 393B**

---

### **EC Declaration of Conformity - EMC**

---

Compliance was demonstrated to the following specifications listed in the Official Journal of the European Communities: EMC Directive 2014/30/EU.

**EN 61010** Safety requirements for electrical equipment for measurement, control, and laboratory use

- Part 1: General requirements
- Part 2-033: Particular requirements for hand-held multimeters and other meters, for domestic and professional use, capable of measuring mains voltage

**EN 61326** Electrical equipment for measurement, control and laboratory use - EMC requirements

- Part 1: General requirements
- Part 2-1: Particular requirements - Test configurations, operational conditions and performance criteria for sensitive test and measurement equipment for EMC unprotected applications
- Part 2-2: Particular requirements - Test configurations, operational conditions and performance criteria for portable testing, measuring and monitoring equipment used in low-voltage distribution systems

**EN 55011:2009+A1:2010** Industrial, scientific and medical equipment. Radio-frequency disturbance characteristics. Limits and methods of measurement

**IEC 61000** Electromagnetic compatibility (EMC)

- Part 3 – 2: Limits — Limits for harmonic current emissions (equipment input current  $\leq 16$  A per phase)
- Part 3-3: Limits - Limitation of voltage changes, voltage fluctuations and flicker in public low-voltage supply systems, for equipment with rated current  $\leq 16$  A per phase and not subject to conditional connection
- Part 4-2: Testing and measurement techniques - Electrostatic discharge immunity test
- Part 4-3: Testing and measurement techniques - Radiated, radio-frequency, electromagnetic field immunity test
- Part 4-4: Testing and measurement techniques - Electrical fast transient/burst immunity test
- Part 4-5: Testing and measurement techniques - Surge immunity test
- Part 4-6: Testing and measurement techniques - Immunity to conducted disturbances, induced by radio-frequency fields
- Part 4-8: Testing and measurement techniques - Power frequency magnetic field immunity test
- Part 4-11: Testing and measurement techniques - Voltage dips, short interruptions and voltage variations immunity tests

---

**394B**

---

**EC Declaration of Conformity - EMC**

---

Compliance was demonstrated to the following specifications listed in the Official Journal of the European Communities: EMC Directive 2014/30/EU.

**EN 61010** Safety requirements for electrical equipment for measurement, control, and laboratory use

- Part 1: General requirements
- Part 2-030: Particular requirements for testing and measuring circuits
- Part 2-033: Particular requirements for hand-held multimeters and other meters, for domestic and professional use, capable of measuring mains voltage

**EN 61326** Electrical equipment for measurement, control and laboratory use - EMC requirements

- Part 1: General requirements
- Part 2-1: Particular requirements - Test configurations, operational conditions and performance criteria for sensitive test and measurement equipment for EMC unprotected applications
- Part 2-2: Particular requirements - Test configurations, operational conditions and performance criteria for portable testing, measuring and monitoring equipment used in low-voltage distribution systems

**EN 55011:2016+A1:2017** Industrial, scientific and medical equipment. Radio-frequency disturbance characteristics. Limits and methods of measurement

**IEC 61000** Electromagnetic compatibility (EMC)

- Part 4-2: Testing and measurement techniques - Electrostatic discharge immunity test
- Part 4-3: Testing and measurement techniques - Radiated, radio-frequency, electromagnetic field immunity test
- Part 4-4: Testing and measurement techniques - Electrical fast transient/burst immunity test
- Part 4-5: Testing and measurement techniques - Surge immunity test
- Part 4-6: Testing and measurement techniques - Immunity to conducted disturbances, induced by radio-frequency fields
- Part 4-8: Testing and measurement techniques - Power frequency magnetic field immunity test

---

## **IEC Measurement Category & Pollution Degree Definitions**

---

**Measurement Category (CAT)** - classification of testing and measuring circuits according to the types of mains circuits to which they are intended to be connected.

**Measurement Category other than II, III, or IV** : circuits that are not directly connected to the mains supply.

**Measurement Category II (CAT II)** : test and measuring circuits connected directly to utilization points (socket outlets and similar prints) of the low-voltage mains installation.

**Measurement Category III (CAT III)** : test and measuring circuits connected to the distribution part of a building's low-voltage mains installation.

**Measurement Category IV (CAT IV)** : test and measuring circuits connected at the source of the building's low-voltage mains installation.

**Mains Isolated** : is for measurements performed on circuits not directly connected to a mains supply.

**Pollution** - addition of foreign matter, solid, liquid, or gaseous (ionized gases) that may produce a reduction of dielectric strength or surface resistivity.

**Pollution Degree 2 (P2)** - only non-conductive pollution occurs except that occasionally a temporary conductivity caused by condensation is expected

---

## Product End-of-Life Handling

---

The equipment may contain substances that could be harmful to the environment or human health if improperly handled at the product's end of life. To avoid release of such substances into the environment and to reduce the use of natural resources, we encourage you to recycle this product to an appropriate system that will ensure that most of the materials are reused or recycled appropriately.



This product is subject to Directive 2012/19/EU of the European Parliament and the Council of the European Union on waste electrical and electronic equipment (WEEE), and in jurisdictions adopting that Directive, is marked as being put on the market after August 13, 2005, and should not be disposed of as unsorted municipal waste. Please utilize your local WEEE collection facilities in the disposition of this product.

---

## Terms and Symbols

---

### Terms

---

#### CAUTION

**A caution statement calls attention to an operating procedure, practice, or condition, which, if not followed correctly, could result in damage to or destruction of parts or the entire product.**

---

#### WARNING

**A warning statement calls attention to an operating procedure, practice, or condition, which, if not followed correctly, could result in injury or death to personnel.**

---

#### NOTICE

A note statement calls attention to an operating procedure, practice, or condition, which, should be noted before proceeding.

---

## Symbols

---



**WARNING - Risk of electric shock.**

---



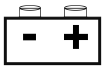
**CAUTION – Statements or instructions that must be consulted in order to find out the nature of the potential hazard and any actions which must be taken.**

---



Equipment protected by double or reinforced insulation

---



Battery

---



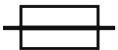
AC measurement

---



DC measurement

---



Fuse

---



**Earth (ground) TERMINAL** - Refer to the instructions accompanying this symbol in this manual.

---



# Safety Notices

The following safety precautions apply to both operating and maintenance personnel and must be followed during all phases of operation, service, and repair of this instrument.

Before applying power to this instrument:

- Read and understand the safety and operational information in this manual.
- Apply all the listed safety precautions.
- Verify that the voltage selector at the line power cord input is set to the correct line voltage. Operating the instrument at an incorrect line voltage will void the warranty.
- Make all connections to the instrument before applying power.
- Do not operate the instrument in ways not specified by this manual or by B&K Precision.

Failure to comply with these precautions or with warnings elsewhere in this manual violates the safety standards of design, manufacture, and intended use of the instrument. B&K Precision assumes no liability for a customer's failure to comply with these requirements.

## Electrical Power

This instrument is intended to be powered from a CATEGORY II mains power environment. The mains power should be 115 V RMS or 230 V RMS. Use only the power cord supplied with the instrument and ensure it is appropriate for your country of use.



**Do not use this instrument in an electrical environment with a higher category rating than what is specified in this manual for this instrument.**

---



**You must ensure that each accessory you use with this instrument has a category rating equal to or higher than the instrument's category rating to maintain the instrument's category rating. Failure to do so will lower the category rating of the measuring system.**

---

## Ground the Instrument

**! WARNING**

To minimize shock hazard, the instrument chassis and cabinet must be connected to an electrical safety ground. This instrument is grounded through the ground conductor of the supplied, three-conductor AC line power cable. The power cable must be plugged into an approved three-conductor electrical outlet. The power jack and mating plug of the power cable meet IEC safety standards.

---

**! WARNING**

Do not alter or defeat the ground connection. Without the safety ground connection, all accessible conductive parts (including control knobs) may provide an electric shock. Failure to use a properly-grounded approved outlet and the recommended three-conductor AC line power cable may result in injury or death.

---

**! WARNING**

Unless otherwise stated, a ground connection on the instrument's front or rear panel is for a reference of potential only and is not to be used as a safety ground. Do not operate in an explosive or flammable atmosphere.

---

## **Environmental Conditions**

---

This instrument is intended to be used in an indoor pollution degree 2 environment. The operating temperature range is 0°C to 40°C and 20% to 80% relative humidity, with no condensation allowed.

Measurements made by this instrument may be outside specifications if the instrument is used in non-office-type environments. Such environments may include rapid temperature or humidity changes, sunlight, vibration and/or mechanical shocks, acoustic noise, electrical noise, strong electric fields, or strong magnetic fields.



**Do not operate the instrument in the presence of flammable gases or vapors, fumes, or finely-divided particulates.**

---

**The instrument is designed to be used in office-type indoor environments. Do not operate the instrument**

- **In the presence of noxious, corrosive, or flammable fumes, gases, vapors, chemicals, or finely-divided particulates.**
  - **In relative humidity conditions outside the instrument's specifications.**
  - **In environments where there is a danger of any liquid being spilled on the instrument or where any liquid can condense on the instrument.**
  - **In air temperatures exceeding the specified operating temperatures.**
  - **In atmospheric pressures outside the specified altitude limits or where the surrounding gas is not air.**
  - **In environments with restricted cooling air flow, even if the air temperatures are within specifications.**
  - **In direct sunlight.**
- 



### Do not operate instrument if damaged

**! WARNING**

If the instrument is damaged, appears to be damaged, or if any liquid, chemical, or other material gets on or inside the instrument, remove the instrument's power cord, remove the instrument from service, label it as not to be operated, and return the instrument to B&K Precision for repair. Notify B&K Precision of the nature of any contamination of the instrument.

---

**! WARNING**

Hazardous voltages may be present in unexpected locations in circuitry being tested when a fault condition in the circuit exists.

---

### Clean the instrument only as instructed

**! WARNING**

Do not clean the instrument, its switches, or its terminals with contact cleaners, abrasives, lubricants, solvents, acids/bases, or other such chemicals. Clean the instrument only with a clean dry lint-free cloth or as instructed in this manual. Not for critical applications.

---

## Do not touch live circuits

### **! WARNING**

**Instrument covers must not be removed by operating personnel. Component replacement and internal adjustments must be made by qualified service-trained maintenance personnel who are aware of the hazards involved when the instrument's covers and shields are removed. Under certain conditions, even with the power cord removed, dangerous voltages may exist when the covers are removed.**

---

To avoid injuries, always disconnect the power cord from the instrument, disconnect all other connections (for example, test leads, computer interface cables, etc.), discharge all circuits, and verify there are no hazardous voltages present on any conductors by measurements with a properly-operating voltage-sensing device before touching any internal parts. Verify the voltage-sensing device is working properly before and after making the measurements by testing with known-operating voltage sources and test for both DC and AC voltages.

Do not attempt any service or adjustment unless another person capable of rendering first aid and resuscitation is present.

## General Safety

### **! WARNING**

**Do not insert any object into an instrument's ventilation openings or other openings.**

---

### **! WARNING**

**This instrument is not authorized for use in contact with the human body or for use as a component in a life-support device or system.**

---

## Servicing

**! WARNING**

Do not substitute parts that are not approved by B&K Precision or modify this instrument. Return the instrument to B&K Precision for service and repair to ensure that safety and performance features are maintained.

---

**! WARNING**

Fuse replacement must be done by qualified service-trained maintenance personnel who are aware of the instrument's fuse requirements and safe replacement procedures. Disconnect the instrument from the power line before replacing fuses. Replace fuses only with new fuses of the fuse types, voltage ratings, and current ratings specified in this manual or on the back of the instrument. Failure to do so may damage the instrument, lead to a safety hazard, or cause a fire. Failure to use the specified fuses will void the warranty.

---

### For continued safe use of the instrument

- Do not place heavy objects on the instrument.
- Do not obstruct cooling air flow to the instrument.
- Do not place a hot soldering iron on the instrument.
- Do not pull the instrument with the power cord, connected probe, or connected test lead.
- Do not move the instrument when a probe is connected to a circuit being tested.

# Contents

Compliance Information	2
390B, 391B, & 393B	2
394B	4
IEC Measurement Category & Pollution Degree Definitions	6
Product End-of-Life Handling	7
Terms and Symbols	7
Safety Notices	9
1 General Information	17
1.1 Product Overview	17
1.2 Contents	18
1.3 Front Panel Overview	19
1.3.1 Push Buttons	20
2 Making Basic Measurements	21
2.1 Measuring AC /DC Voltage	22
2.1.1 High Frequency Reject Mode	23
2.1.2 Making dB Measurements AC mV only	24
2.2 Measuring Resistance	25
2.2.1 Testing for Continuity	26
2.2.2 Testing Diodes	27
2.2.3 Measuring Capacitance	28
2.3 Measuring AC / DC Current	29
2.4 Measuring Frequency	31
2.5 Measuring Temperature °C °F	32
3 Functions	33
3.1 Store and Recall Functions	34
3.2 MAX MIN AVG	35
3.3 Relative Mode	35
3.4 Digit	36
3.5 Auto Hold	36
3.6 Peak Hold	36
3.7 Data Log and Log Rate	37
3.8 Auto Backlight	37
3.9 Power Up Option	37
4 Process Multimeter Functions	38
4.1 DC Current Output	39

4.1.1	Adjustable DC Current Output	40
4.1.2	Auto DC Current Output	40
4.2	Source Mode	41
4.3	Simulation Mode	42
4.4	Loop Power	43
4.4.1	250Ω HART	43
5	Battery and Fuse Replacement	44
6	Specifications	45
7	Service Information	49
8	LIMITED THREE-YEAR WARRANTY	50



# General Information

## 1.1 Product Overview

The 390B Series True RMS multimeters offer a comprehensive solution for general purpose measurement applications. Bundled with a complete set of accessories, these multimeters provide technicians and engineers with accurate results, data logging capabilities, and measurement features for evaluating a variety of electronics or electrical systems.

Advanced features like data logging records measurements to the meter's internal memory at a user-specified sampling interval.

Features	390B	391B	393B
True RMS	AC, AC + DC voltage and current		
DCV Accuracy	± (0.03% + 10 digits)	± (0.03% + 20 digits)	± (0.015% + 20 digits)
Display Count	40,000	40,000	100,000
AutoV/LoZ	✓	-	-
Auto Backlit, Dual Display		✓	
Analog Style Bar Graph		✓	
Relative Mode (% and Δ)		✓	
Min/Max/Avg		✓	
dBm/dB measurement		✓	
Auto Hold, Peak Hold		✓	
Data Log Capacity	40,000 readings	20,000 readings	20,000 readings
Duty Cycle	-	✓	✓
Temperature Probe		✓	
Optical Isolated USB Interface		✓	

**Table 1.1** 390B Series Models



Figure 1.1 390B

## 1.2 Contents

Please inspect the instrument mechanically and electrically upon receiving it. Unpack all items from the shipping carton, and check for any obvious signs of physical damage that may have occurred during transportation. Report any damage to the shipping agent immediately.

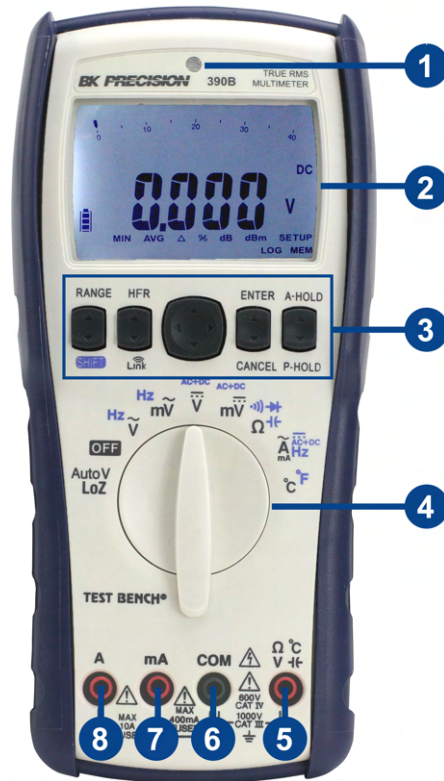
Save the original packing carton for possible future reshipment. Every instrument is shipped with the following contents:

- 390B series DMM
- test leads
- K-type thermocouple (not included with 394B model)
- magnetic hanger strap
- USB communication cable

### NOTICE

Verify that all items above are included in the shipping container. If anything is missing, please contact B&K Precision.

**1.3 Front Panel Overview**



**Figure 1.2** Front Panel

Item	Name	Description
1	Light Sensor	Auto backlight sense point.
2	Display	40,000 /100,000 count dual display
3	Push Buttons	Push buttons. Refer to <b>table 1.3</b> for more information.
4	Rotary Switch	Switches between the available operation modes.
5	Input Terminal	Input terminal for voltage, frequency, resistance, continuity, diode, capacitance and temperature measurements.
6	Return Terminal	Return terminal for all measurements.
7	mA Input Terminal	Input terminal for 0 to 400mA current measurements.
8	A Input Terminal	Input terminal for 0 to 10A current measurements.

**Table 1.2** Front Panel Overview

### 1.3.1 Push Buttons

Button	Description
<b>Shift</b>	Select measurement function.
<b>RANGE</b>	Select measurement range. Press > 1 sec to enter auto range mode.
<b>HFR</b>	Enable/Disable the High Frequency Reject mode for AC measurements.
<b>Link</b>	Enable/Disable the link mode. <b>(390B only)</b>
<b>Digit</b>	Selects the display digit.
<b>Hz</b>	Measures the frequency for voltage or current. <b>(394B only)</b>
<b>ENTER</b>	Enter menu function in pointer position.
<b>CANCEL</b>	Cancel current menu function.
<b>A-HOLD</b>	Enable/Disable the Auto-Hold mode.
<b>P-HOLD</b>	Enable the Peak-Hold mode in the AC or DC measurements. In this mode, press button to select Peak-Hold MAX or MIN. Press > 1 sec to disable the Peak-Hold mode.
<b>REL <math>\Delta</math></b>	Enable/Disable the relative mode. <b>(394B only)</b>

**Table 1.3** Push Buttons

# Making Basic Measurements

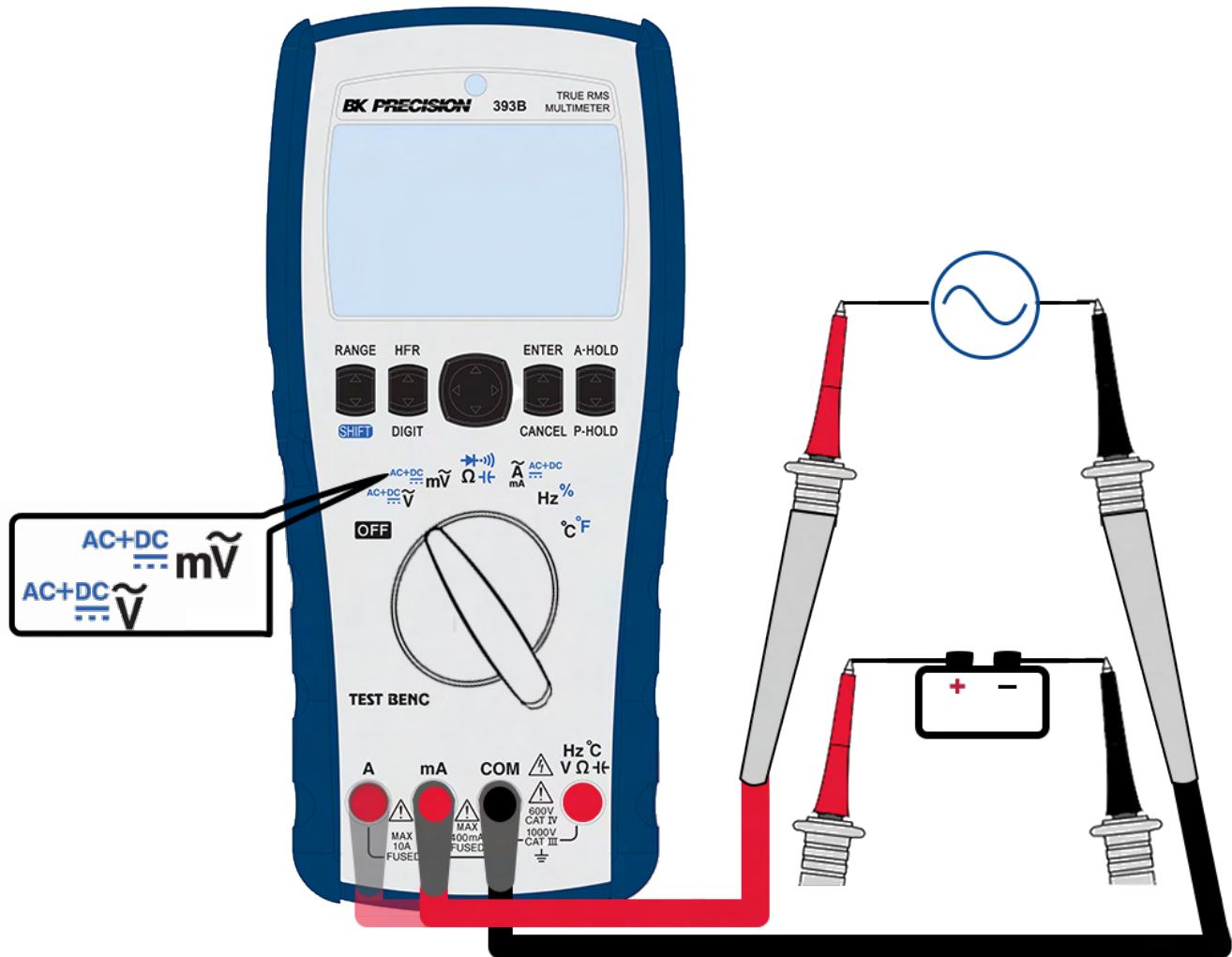
2.1	Measuring AC /DC Voltage	22
2.1.1	High Frequency Reject Mode	23
2.1.2	Making dB Measurements AC mV only	24
2.2	Measuring Resistance	25
2.2.1	Testing for Continuity	26
2.2.2	Testing Diodes	27
2.2.3	Measuring Capacitance	28
2.3	Measuring AC / DC Current	29
2.4	Measuring Frequency	31
2.5	Measuring Temperature °C °F	32

When connecting the test leads to the **DUT (Device Under Test)** connect the common (mA) test lead before connecting the live lead; when removing the test leads, remove the test live lead before removing the common test lead.

The figures on the following pages show how to make basic measurements.

## 2.1 Measuring AC /DC Voltage

Set up your multimeter to measure voltage as shown in **figure 2.1**. Probe the test points and read the display.



**Figure 2.1** Voltage Measurement

### NOTICE

Press the **SHIFT** button to manually select one of the available measuring function (AC/DC/AC+DC). Press and hold the **SHIFT** button to enter manual test mode. In manual test mode the measuring function will automatically selected based on the input signal.

### 2.1.1 High Frequency Reject Mode

The 390B series is equipped with an AC LPF (low-pass filter) to help reduce unwanted electronic noise when measuring AC voltage or AC frequency. The LPF can improve measurement performance on composite sine waves that are typically generated by inverters and variable frequency drives.

Set up the multimeter to measure AC voltage. Press the **HFR** button to enable the LPF. The multimeter will continue measuring in the chosen AC mode, but now the signal diverts through a filter that blocks voltages above 800 Hz.

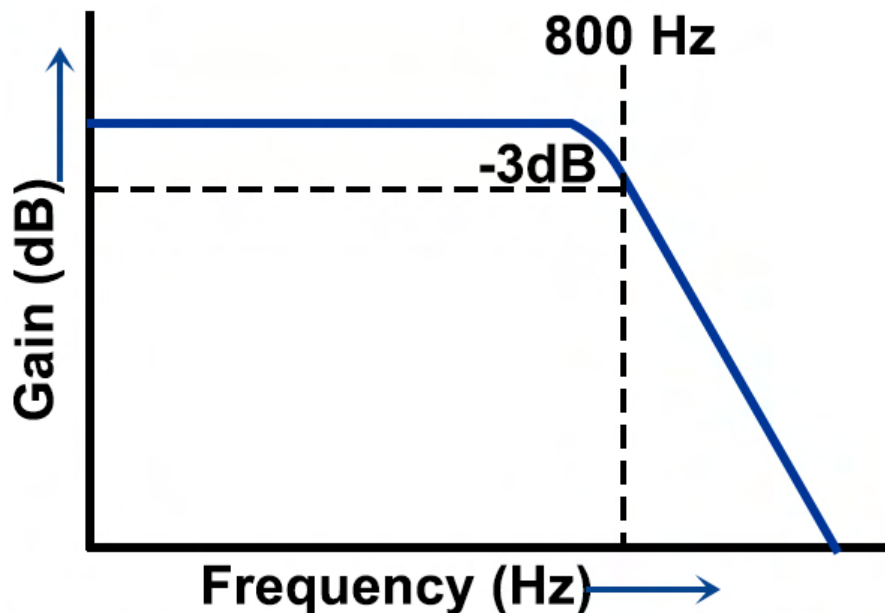


Figure 2.2 High Frequency Reject

To avoid possible electric shock or personal injury, do not use the HFR option to verify the presence of hazardous AC voltages. AC voltage values greater than what are indicated may be present when the LPF is enabled.

**CAUTION**

First, make an AC voltage measurement without LPF to detect the possible presence of hazardous voltages. Then, enable the LPF if required for measurement stability and response speed.

**CAUTION**

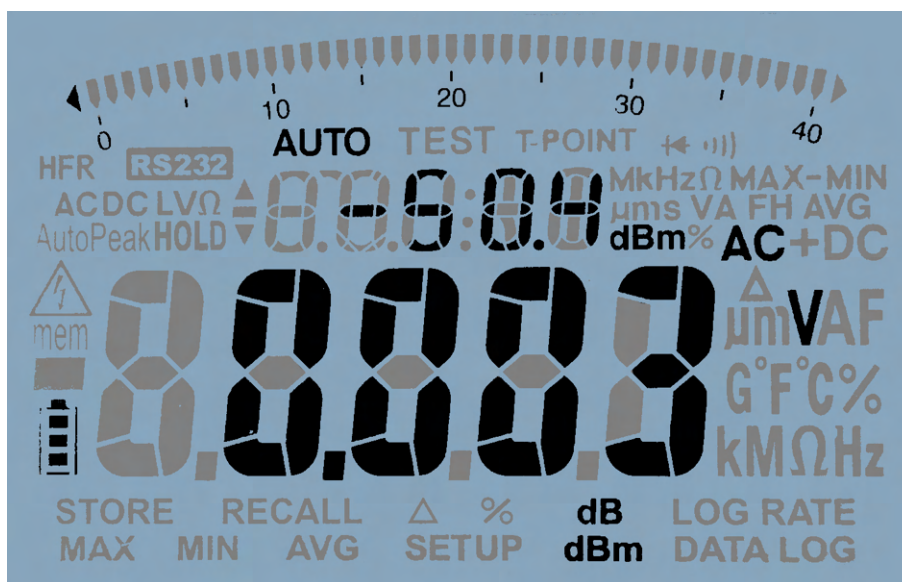
The HFR function is only available for AC voltage measurements. This function is not supported for AC + DC voltage measurements.

### 2.1.2 Making dB Measurements AC mV only

The multimeter is capable of displaying voltage as a dB value, either relative to 1 milliwatt (dBm) or a reference voltage of 1 volt (dB).

To set the multimeter to display values in either dBm or dB, first set up your multimeter to measure AC voltage as shown in **figure 2.1**. Once AC voltage is selected use the navigation keys to select either dB or dBm which are located near the bottom of the display. Once you are hovering over the desired display option press the **ENTER** button.

The dB or dBm display will appear above the voltage reading. You can now probe the test points, and read the display in the selected unit.



**Figure 2.3** Display dB

A dBm measurement must use a reference impedance (resistance) to calculate a dB value based on 1 milliwatt. The reference impedance is set to 50 Ω by default.

**NOTICE**

– A dB measurement uses a 1 volt reference voltage to compare the present measurement against a stored relative value. The difference between the two AC signals is displayed as a dB value. The reference impedance setting is not part of a dB measurement.

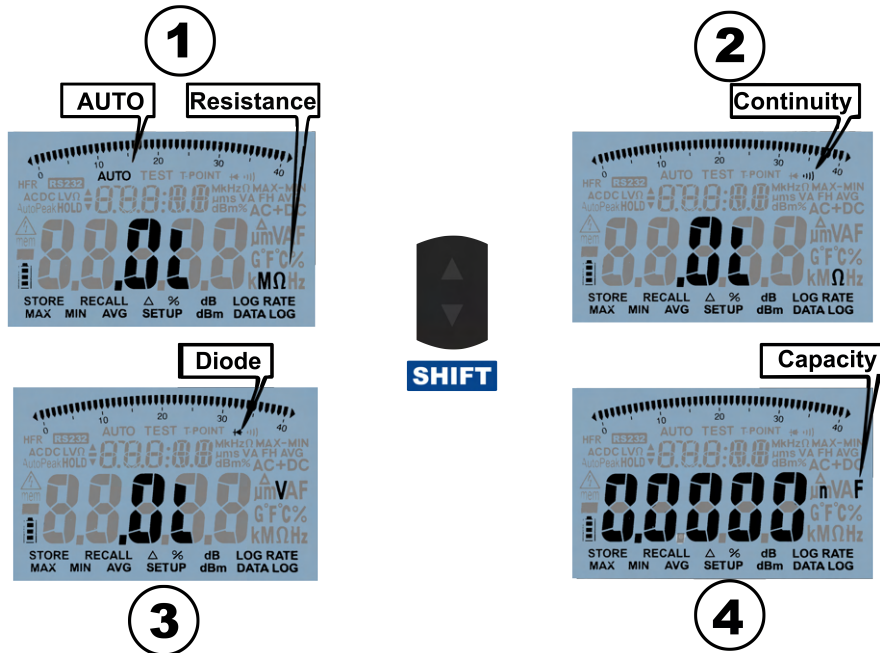
$$dBm = 20 \log \frac{V_{AC}}{0.7746}$$

$$dB = 20 \log \frac{V_{AC}}{1}$$

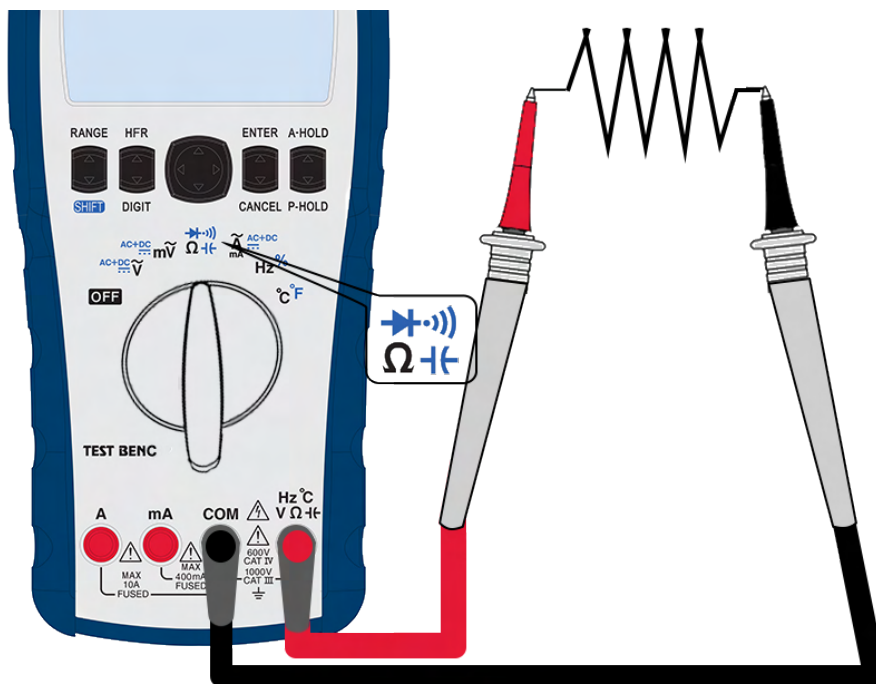


## 2.2 Measuring Resistance

Set up your multimeter to measure resistance as shown in **figure 2.5**. Press the **SHIFT** button to navigate through the available measurements shown in **figure 2.4**. Probe the test points and read the display.



**Figure 2.4** Available Measurement Modes



**Figure 2.5** Resistance Measurement

**⚠ CAUTION**

To avoid possible damage to your multimeter or to the equipment under test, disconnect the circuit power and discharge all high-voltage capacitors before measuring resistance.

**NOTICE**

The test leads can add 0.1 Ω to 0.2 Ω of error to resistance measurements.

**2.2.1 Testing for Continuity**

Set up your multimeter to test continuity as shown in **figure 2.5**. Press the **SHIFT** button once to select test mode 2, continuity, as shown in **figure 2.4**. Probe the test points and listen for a beep.

**⚠ CAUTION**

To avoid possible damage to your multimeter or to the equipment under test, disconnect the circuit power and discharge all high-voltage capacitors before testing for continuity.

**NOTICE**

The continuity test features a beeper that sounds as long as a circuit is not broken. The audible alert allows you to perform quick continuity tests without having to watch the display.

In continuity, a short means a measured value is less than the set threshold resistance values.

Model	Range	Resolution	Accuracy
390B	400.0 Ω	0.1 Ω	0.2 + 2
391B & 393B	400.00 Ω	0.01 Ω	0.2 + 30

**Table 2.1** Threshold Resistance Values

- Open Circuit Voltage: -1.2 V
- Short Test Current: -0.3 mA
- Threshold: Adjustable 10 Ω to 50 Ω
- Buzzer Response Time: < 10 ms

The threshold is adjustable under the **SETUP** menu > Cnt in.

## 2.2.2 Testing Diodes

Set up your multimeter to test diodes as shown in **figure 2.5**. Press the **SHIFT** button twice to select test mode 3, Diode, as shown in **figure 2.4**. Probe the test points as shown in **figure 2.6** and read the display.

Use the diode test to check diodes, transistors, silicon controlled rectifiers (SCRs), and other semiconductor devices. A good diode allows current to flow in one direction only.

This test sends a current through a semiconductor junction and then measures the junction's voltage drop. A typical junction drop is 0.3 V to 0.8 V.

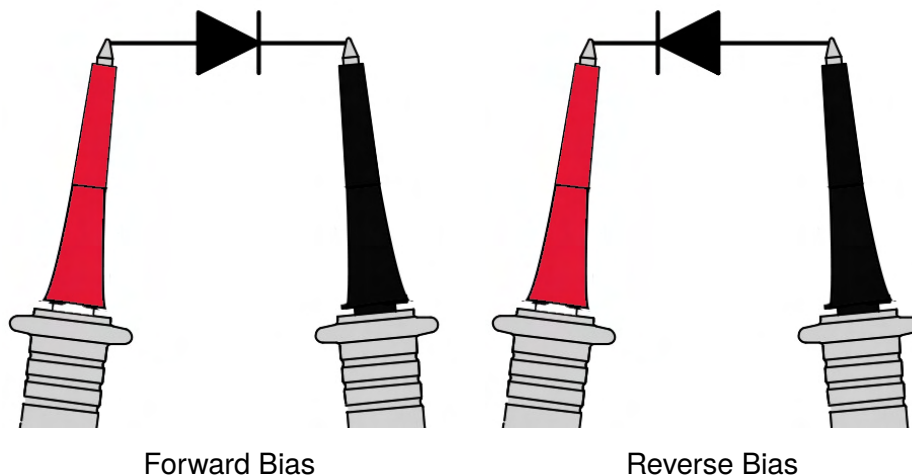
### NOTICE

Connect the red test lead to the positive terminal (anode) of the diode and the black test lead to the negative terminal (cathode).

The multimeter can display diode forward bias of up to approximately 3.1 V. The forward bias of a typical diode is within the range of 0.3 V to 0.8 V; however, the reading can vary depending on the resistance of other pathways between the probe tips.

Reverse the probes (as shown in **figure 2.6**) and measure the voltage across the diode again. Assess the diode according to the following guidelines:

- A diode is considered good if the multimeter displays 0L in reverse bias mode.
- A diode is considered shorted if the multimeter displays approximately 0 V in both forward and reverse bias modes, and the multimeter beeps continuously.
- A diode is considered open if the multimeter displays 0L in both forward and reverse bias modes.



**Figure 2.6** Testing Diodes

## 2.2.3 Measuring Capacitance

Set up your multimeter for capacitance measurement as shown in [figure 2.5](#). Press the **SHIFT** button three times to select test mode 4, Capacitance, as shown in [figure 2.4](#). Probe the test points as shown in [figure 2.7](#) and read the display.

### CAUTION

**To avoid possible damage to the multimeter or to the equipment under test, disconnect circuit power and discharge all high-voltage capacitors before measuring capacitance. Use the DC voltage function to confirm that the capacitor is fully discharged.**

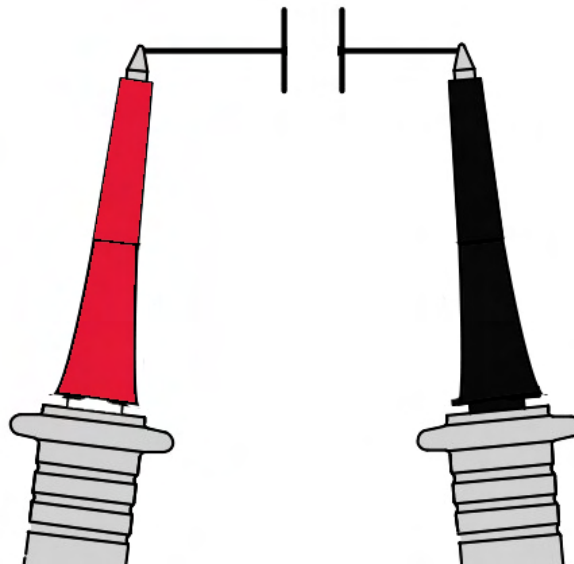
---

### NOTICE

The multimeter measures capacitance by charging the capacitor with a known current for a known period of time, measuring the resulting voltage, and then calculating the capacitance.

For measuring capacitance values greater than 1000  $\mu\text{F}$ , discharge the capacitor first, then select a suitable range for measurement. This will speed up the measurement time and also ensure that the correct capacitance value is obtained.

---



**Figure 2.7** Capacitance Measurement

## 2.3 Measuring AC / DC Current

Set up your multimeter to measure AC or DC current as shown in **figure 2.8**. Press the **SHIFT** button to toggle between AC and DC mode. Open the circuit path to be tested, and probe the test points as shown in **figure 2.8** then read the display.

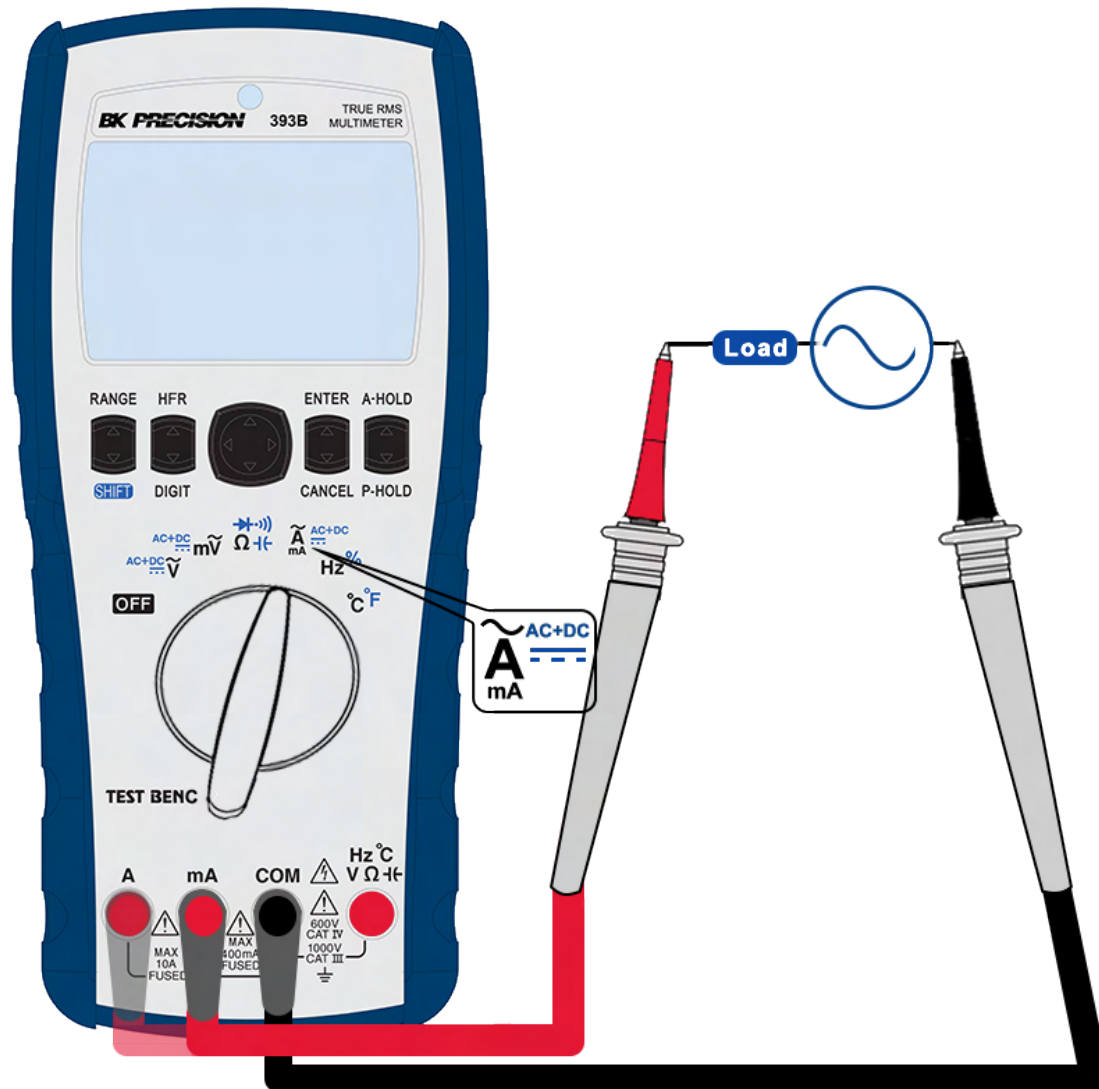


Figure 2.8 Current Measurement

**Before attempting any current measurement, switch off the power source of the circuit and measure the AC or DC voltage to ensure that the power source has been switched off.**

### **⚠ WARNING**

**Never attempt an in-circuit current measurement where the open-circuit potential to earth is greater than 1000 V. Doing so will cause damage to the multimeter and possible electric shock or personal injury.**

To avoid possible damage to the multimeter or to the equipment under test:

- Check the multimeter’s fuses before measuring current.
  - Use the proper terminals, function, and range for your measurement.
  - Never place the probes across (in parallel with) any circuit or component when the leads are plugged into the current terminals.
  - Current can be measured continuously for 10 minutes at mA inputs, and 1 minute at A inputs.
  - After measuring current continuously, allow for a minimum cool down of 20 minutes.
  - Burden Voltage: 2 mV/mA at mA inputs and 60 mV/A at A inputs
  - Overload protection: AC/DC 400 mA at mA inputs, AC/DC 10 A at A inputs
- 



## 2.4 Measuring Frequency

Set up your multimeter to measure frequency as shown in **figure 2.9**. Press the **SHIFT** button to toggle between **period** and **duty**.

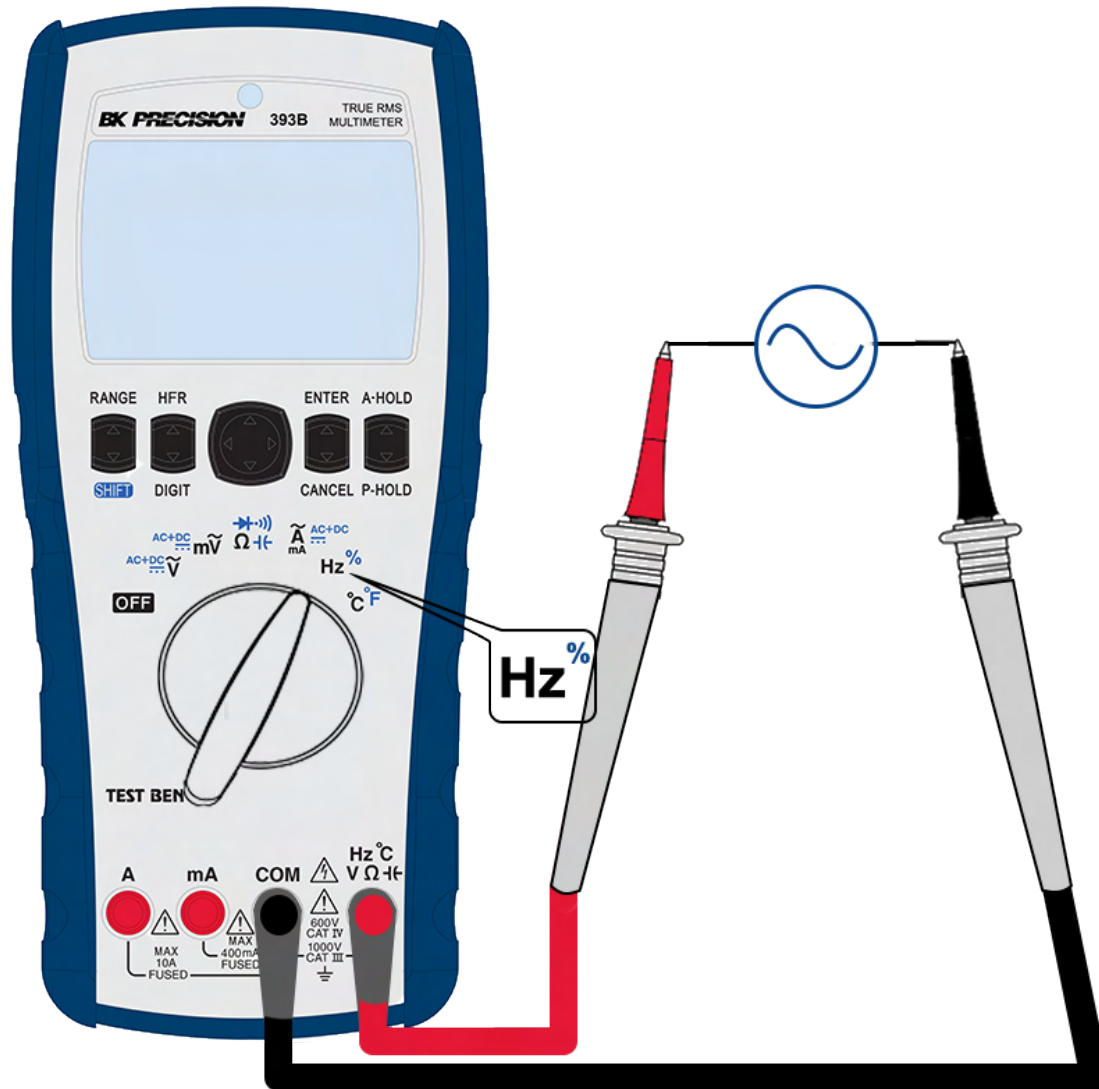


Figure 2.9 Frequency Measurement

### **! WARNING**

Never measure the frequency where the voltage or current level exceeds the specified range. Manually set the voltage or current range if you want to measure frequencies below 20 Hz.

## 2.5 Measuring Temperature °C °F

Set up your multimeter to measure temperature as shown in **figure 2.10**. Press the **SHIFT** button to toggle between **Celsius** and **Fahrenheit**.

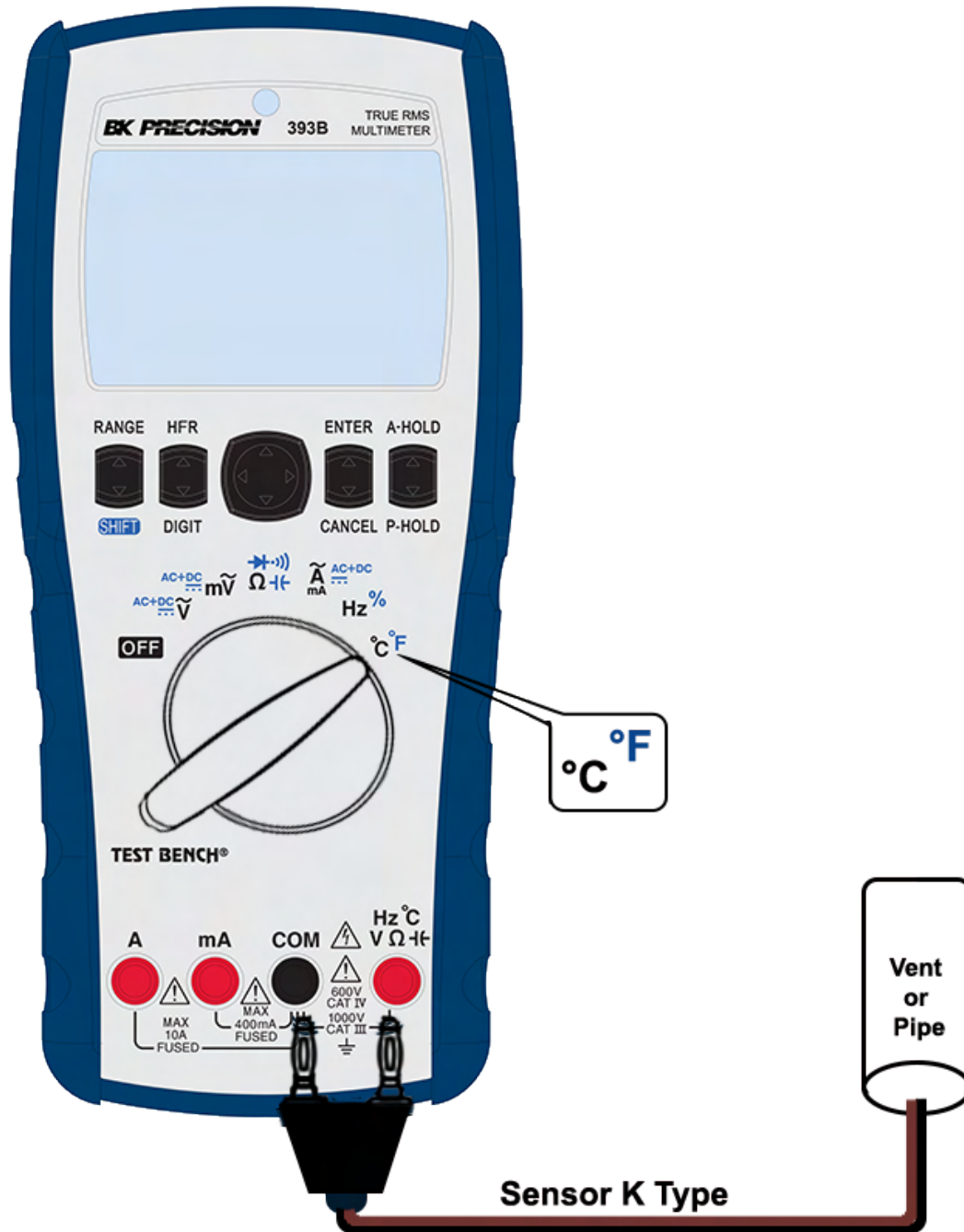


Figure 2.10 Temperature Measurement



**Never measure the frequency where the voltage or current level exceeds the specified range. Manually set the voltage or current range if you want to measure frequencies below 20 Hz.**



# Functions

The 390B series offers the following functions:

3.1	Store and Recall Functions	34
3.2	MAX MIN AVG	35
3.3	Relative Mode	35
3.4	Digit	36
3.5	Auto Hold	36
3.6	Peak Hold	36
3.7	Data Log and Log Rate	37
3.8	Auto Backlight	37
3.9	Power Up Option	37

These functions can be enabled / disabled using the push buttons and the navigation keys. The navigation keys can be used to navigate the **Function** menu located at the bottom portion of the display. The currently selected Function will blink. To enable or enter the menu of the function press the **ENTER** button.

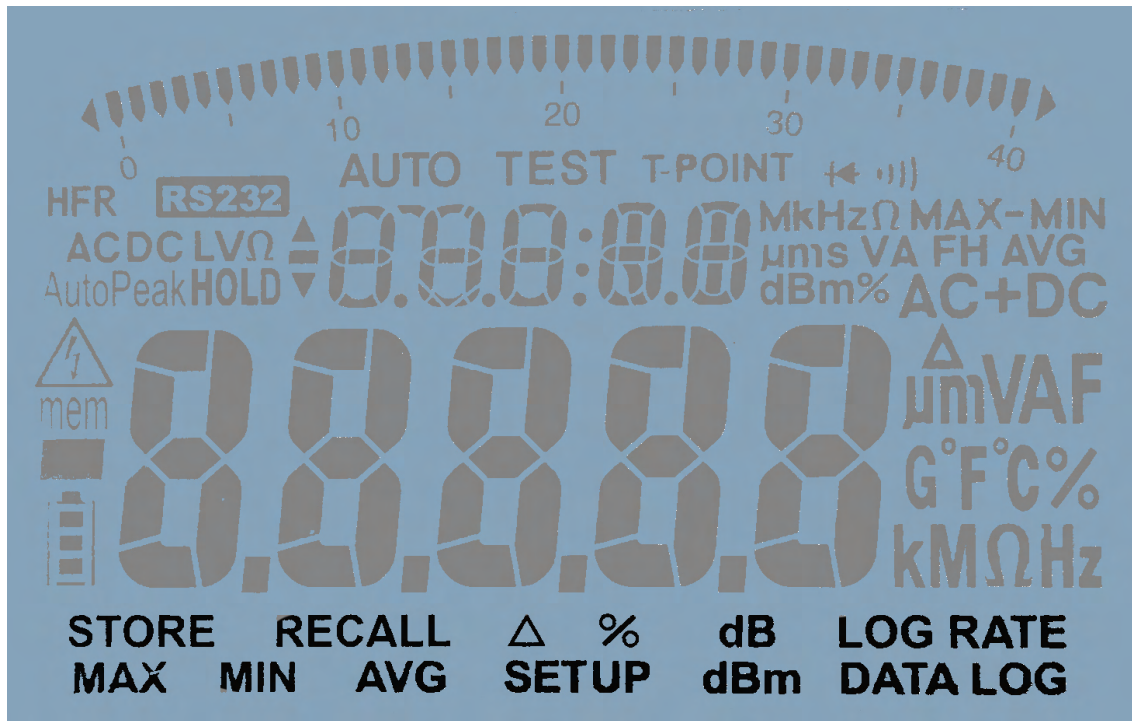
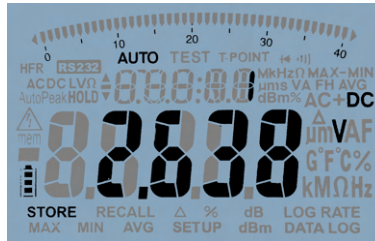


Figure 3.1 Function Menu

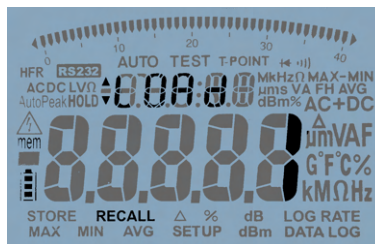
### 3.1 Store and Recall Functions

The store function records the measured value to the internal memory. A total of 1000 measurements can be recorded.

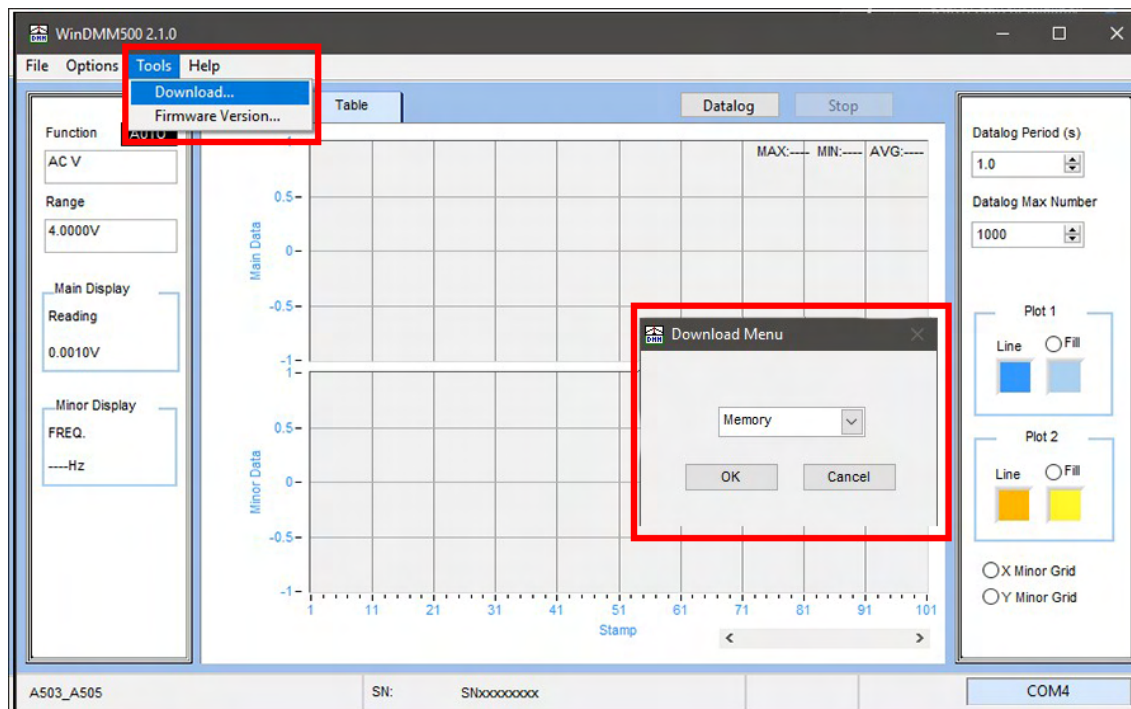


**Figure 3.2** Store Measurement

Recorded measurements can be recalled from memory and displayed one at a time or imported to a PC in spreadsheet format using the provided software



**Figure 3.3** Recall Measurement



**Figure 3.4** Import measurements with software

### 3.2 MAX MIN AVG

The MAX/MIN/AVG mode records the minimum and maximum input values. When the input is measured below the record minimum value or above the record maximum value, the meter records the new value. The MAX/MIN/AVG mode can also calculate the average of the maximum value and the minimum value.



Figure 3.5 Max

### 3.3 Relative Mode

The relative mode records the input value as reference and appears on the upper display. The following displayed measurements will be the calculated difference ( $\Delta$ ) of the reference value and the input value or the difference percent (%) of the reference value and the input value.

One possible application is to increase the accuracy of a resistance measurement by nulling the test lead resistance. Nulling the leads is also particularly important prior to making capacitance measurements.

Relative mode can be set for both auto and manual range settings, but an overload reading cannot be stored as a null value.

**NOTICE**

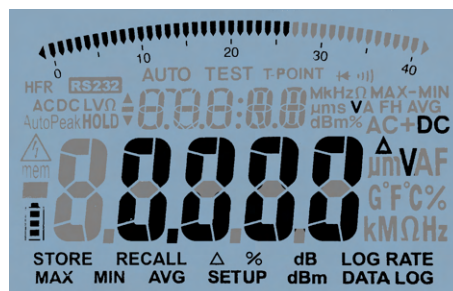


Figure 3.6 Relative Mode

### 3.4 Digit

Press the **DIGIT** button to select the display digit as shown in **figure 3.7**.



**Figure 3.7** Digit Configuration

### 3.5 Auto Hold

The **Auto Hold** function, holds the last measured reading, and the current reading appears on the upper display. When the difference of the hold value and the current value is above 20 counts, the meter beeps and holds the new value. To use the Auto Hold mode, press the A-Hold button as shown in **figure 3.8**.



**Figure 3.8** A-HOLD Function

### 3.6 Peak Hold

The **Peak Hold** function records the peak maximum value and the peak maximum value. When the input goes below the recorded peak minimum value or above the recorded peak maximum value, the meter records the new value. To use the Peak HOLD mode, press the P-HOLD button as shown in **figure 3.9**



**Figure 3.9** P-HOLD Function

### 3.7 Data Log and Log Rate

The Data Logging function provides the convenience of recording test data for future review or analysis. Since data is stored in the nonvolatile memory, the data remains saved even when the multimeter is turned OFF or if the battery is replaced.

The Data Logging feature collects measurement information at the specified log rate. The log rate can be configured between 1 to 600 seconds. **Table 3.1** shows the logging capacity for each model in the series.

Model	390B	391B	393B
Display Count	40,000 count	40,000 count	100,000 count
DC Voltage Basic Accuracy	0.03%	0.03%	0.015%
Wireless Data-logging	✓	-	-
Data Log Capacity	40,000 readings	20,000 readings	20,000 readings

**Table 3.1** Log Capacity

A measurement can manually be logged into the nonvolatile memory using the **Store Function**.

### 3.8 Auto Backlight

The multimeter’s automatic backlight features uses a photoresistor to determine when to automatically enable / disable the backlight.

The auto backlight can be disabled in the Setup Menu.

**NOTICE**

### 3.9 Power Up Option

Press the **Enter** or **Cancel** button while turning the meter ON from the OFF position to call the corresponding function;

**Enter** : Displays the firmware version

**Cancel** : Clear all stored data.

# Process Multimeter Functions

The 394B Process Multimeter combines the capabilities of a mA loop calibrator with a full-featured True RMS multimeter in one package.

The following functions are exclusive to the 394B Model:

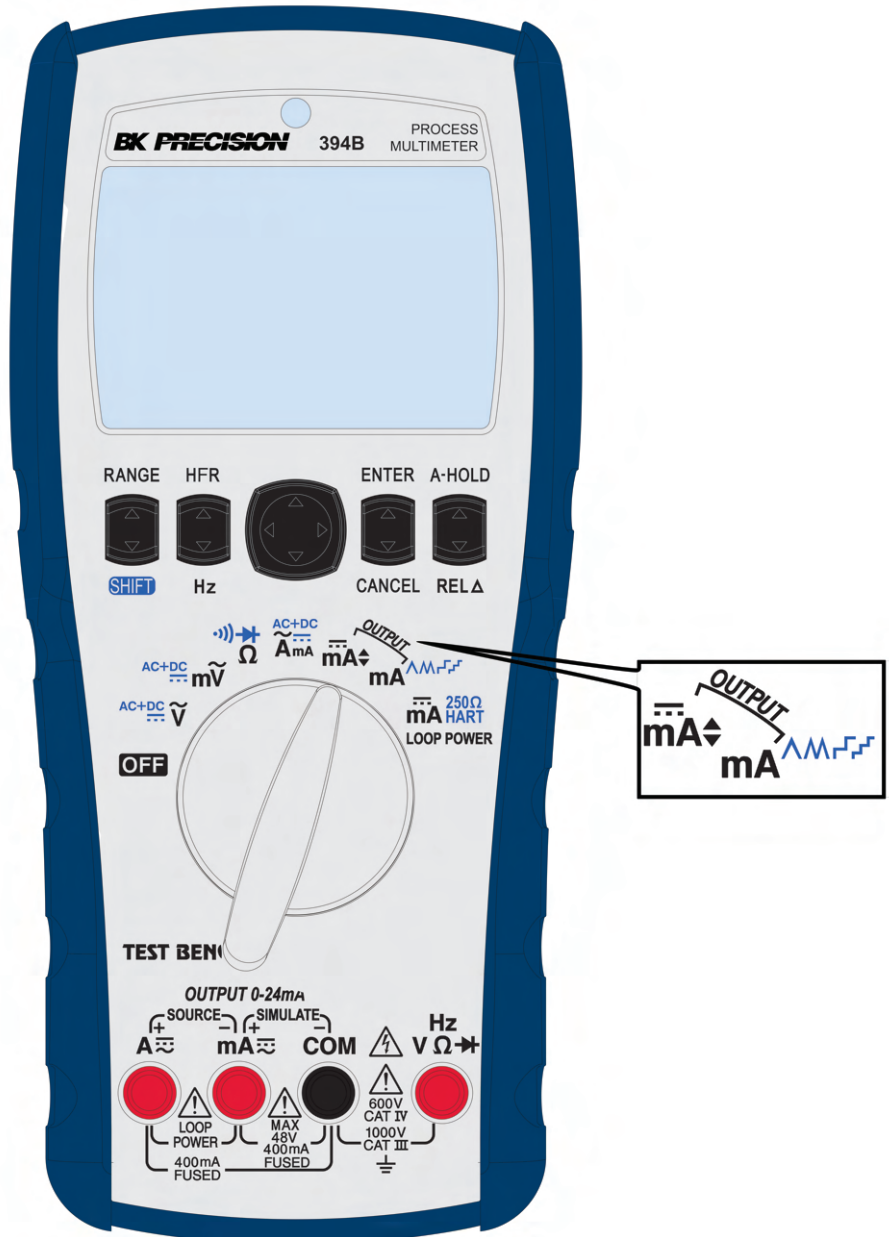
4.1	DC Current Output	39
4.1.1	Adjustable DC Current Output	40
4.1.2	Auto DC Current Output	40
4.2	Source Mode	41
4.3	Simulation Mode	42
4.4	Loop Power	43
4.4.1	250 $\Omega$ HART	43

Key Specifications	
<b>Process Multimeter</b>	
Current Output Ranges	0-20 mA or 4-20 mA, using internal batteries or external loop supply
Current Output Adjustment Modes	Slow ramp, fast ramp, 25% step
Loop Power Supply	> 24 V
250 $\Omega$ HART <sup>®</sup> Mode	✓
<b>General Purpose Multimeter</b>	
True RMS	✓ AC, AC+DC voltage and current
Basic DCV Accuracy	± 0.05%
Display	5 digit / 50,000 count

**Table 4.1** 394B Key Specifications

## 4.1 DC Current Output

To use the DC current output function, turn the rotary knob to the output position (Adjustable DC output or Auto DC output) as shown in **figure 4.1**.



**Figure 4.1** DC Current Output

The DC current output function has both Source Mode & Simulate Mode.

**NOTICE**

The output mode has both types: 0-20mA & 4-20mA.

### 4.1.1 Adjustable DC Current Output

To use the adjustable DC current output function, turn the rotary to the adjustable output position. In this function, you can adjust the DC current output.

- %STEP: 0% / 25% / 50% / 75% / 100% / 120% / 125%
- Fast Setup: 0% / 50% / 100%
- Fine Setup : Minimum resolution 1uA, 0mA to 24mA





% STEP	0-20mA Mode	4-20mA Mode
0%	0mA	4mA
25%	5mA	8mA
50%	10mA	12mA
75%	15mA	16mA
100%	20mA	20mA
120%	24mA	N/A
125%	N/A	24mA

**Table 4.2** Adjustable DC Current Output

### 4.1.2 Auto DC Current Output

To use the auto DC current output function, turn the rotary knob to the auto output position.

In this function, you can press the **SHIFT** button to select 4 kinds of the auto DC current output. Press the HOLD button to pause / continue the output.

Mode	Type	Action
	Linear	0% to 100% to 0% per 40 sec
	Linear	0% to 100% to 0% per 20 sec
	25% Step	0% to 100% to 0%, a step per 15 sec
	25% Step	0% to 100% to 0%, a step per 5 sec

**Table 4.3** Auto DC Current Output



## 4.2 Source Mode

When the meter is in source mode it provides an internal power supply (> 4.5V) to drive the DC current output. To operate in the source mode, place the positive probe in the A terminal and the negative probe in the mA terminal. This will cause the meter to automatically enter the source mode.

Source mode works in both modes Adjustable DC output and Auto DC output. In auto DC current output mode, you can press the **A-HOLD** button to pause / continue the output.

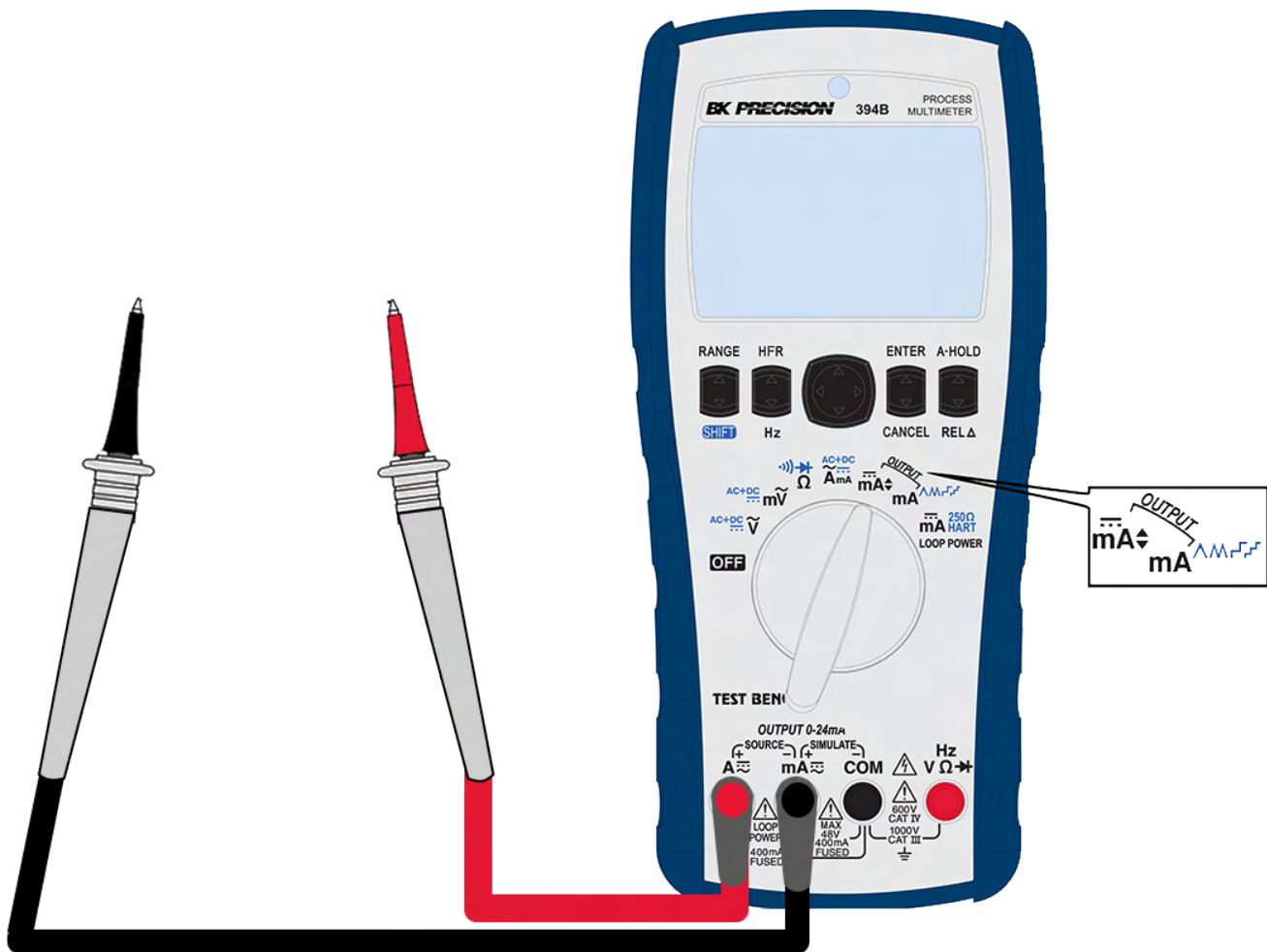


Figure 4.2 Source Mode Connection



**Do not turn the rotary knob while the probe is in the A terminal. This action maybe caused > 30mA to pass through the loop circuit.**

### 4.3 Simulation Mode

In Simulation mode an external power supply (12V to 48V) is needed to drive the DC current output.

To operate in the simulate mode place the positive probe in the mA terminal and the negative probe in the COM terminal. This will cause the meter to automatically enter the simulation mode.

Simulation mode works in both modes Adjustable DC output and Auto DC output. In auto DC current output mode, you can press the **A-HOLD** button to pause / continue the output.

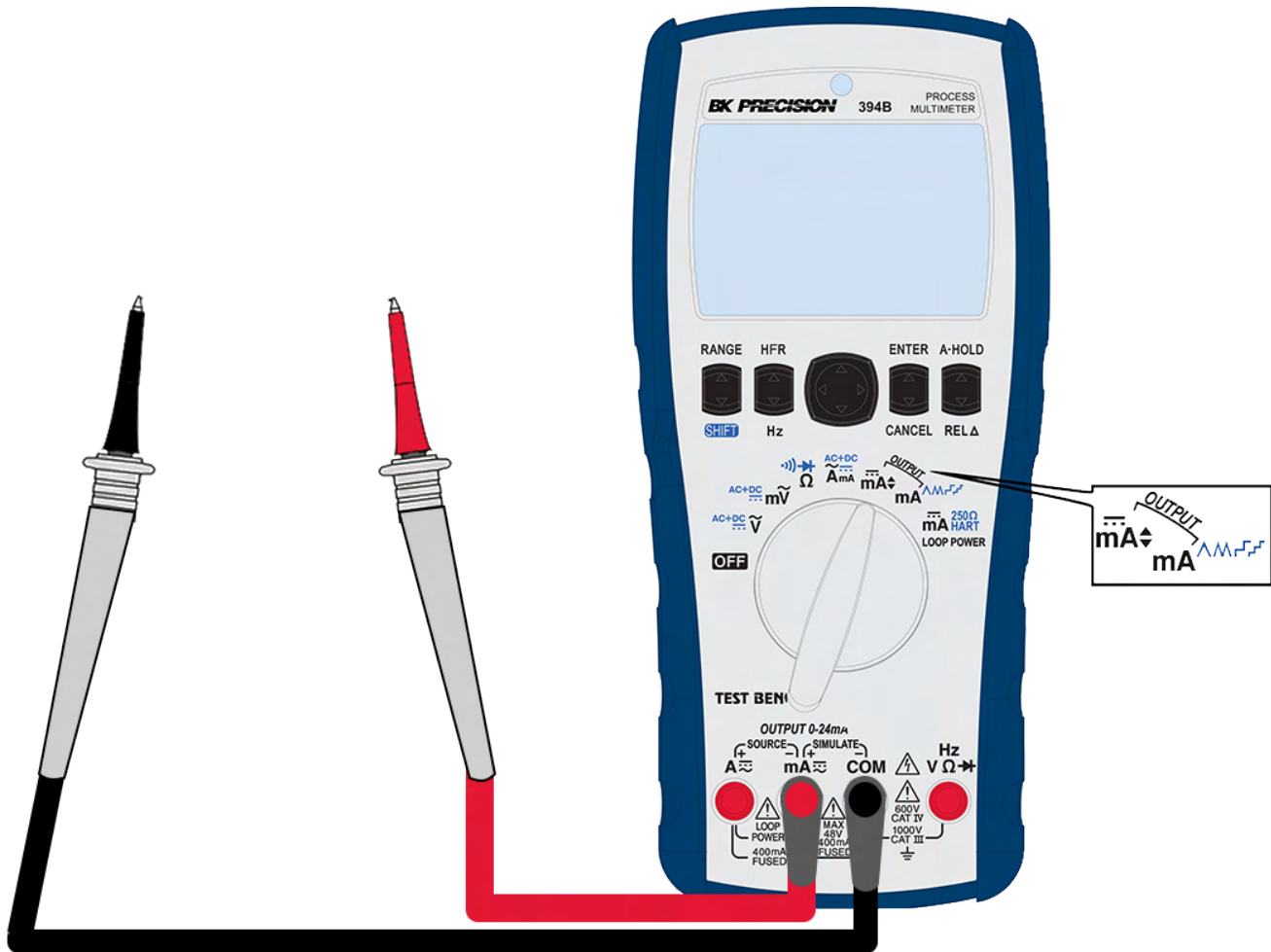


Figure 4.3 Simulation Mode Connection



**Do not turn the rotary knob while the probe is in the A terminal. This action maybe caused > 30mA to pass through the loop circuit.**

### 4.4 Loop Power

To operate in the loop power function, place the positive probe in the mA terminal and the negative probe in the COM terminal.

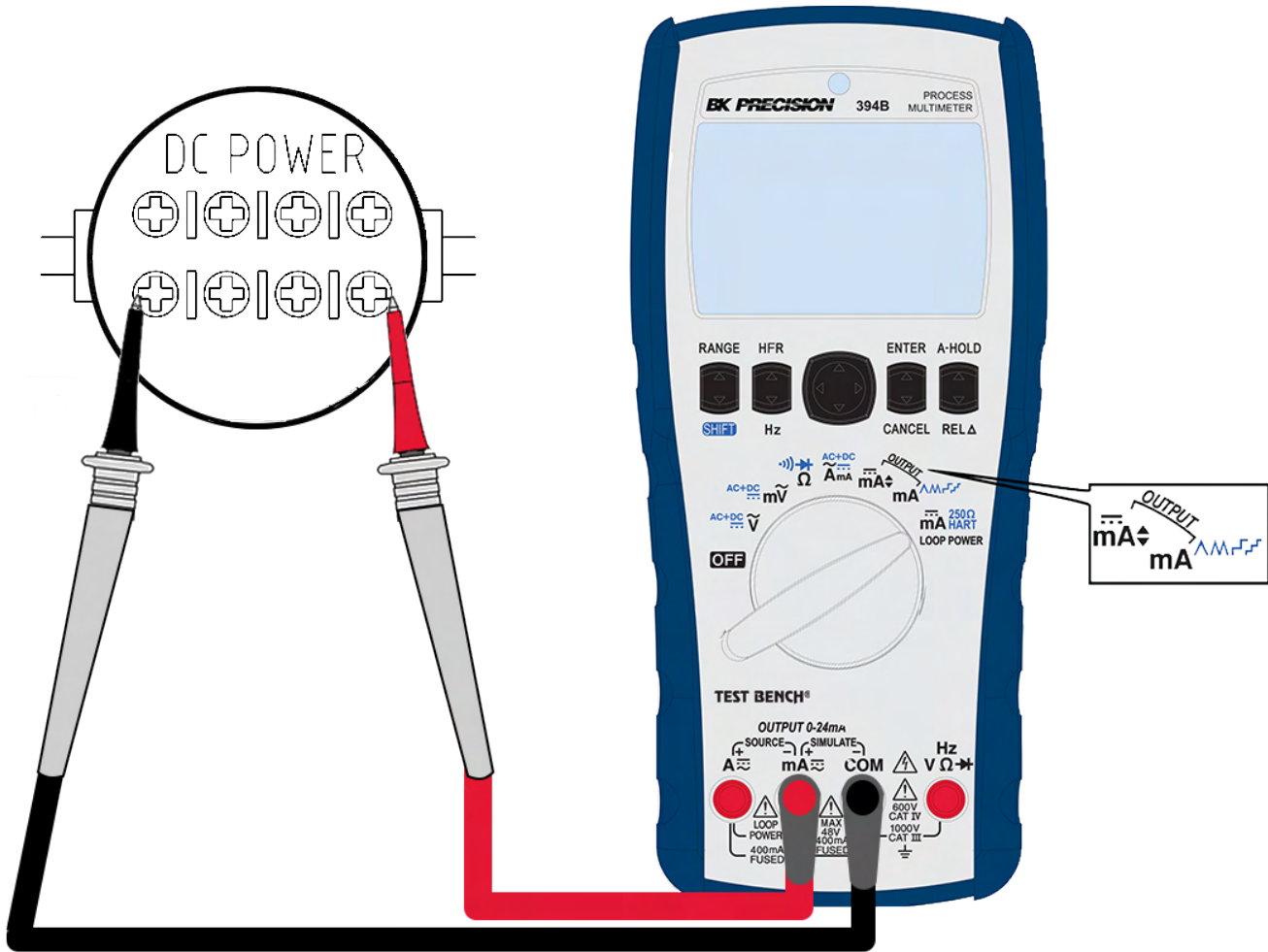


Figure 4.4 Loop Power Mode Connection

**CAUTION**

Do not turn the rotary knob while the probe is in the A terminal. This action may cause > 30mA to pass through the loop circuit.

#### 4.4.1 250Ω HART

Switch the rotary knob to the loop power position, then press the **SHIFT** button to enable / disable the 250Ω HART.

# Battery and Fuse Replacement

Refer to [figure 5.1](#) to replace fuse and the batteries :

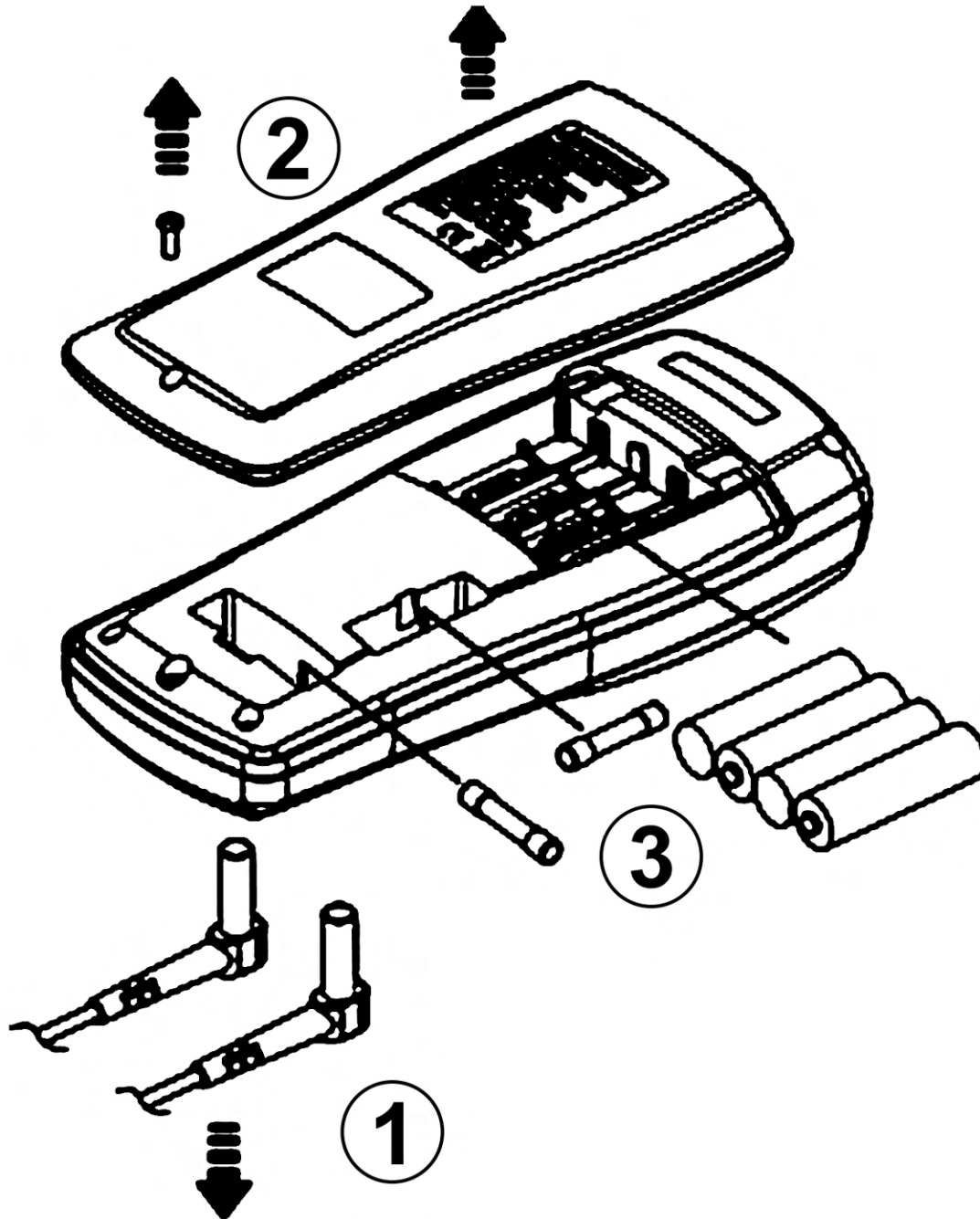


Figure 5.1 Battery and Fuse Replacement

# Specifications

## Specifications are based on the following conditions/assumptions:

- Accuracy specifications:  $\pm$  (% of reading + counts of least significant digit) at  $23\text{ }^{\circ}\text{C} \pm 5\text{ }^{\circ}\text{C}$ , with relative humidity less than 80% RH One year calibration cycle
- Temperature coefficient is  $0.1 \times$  (specified accuracy)/ $^{\circ}\text{C}$  for  $T < 18\text{ }^{\circ}\text{C}$ ,  $T > 28\text{ }^{\circ}\text{C}$
- AC Voltage and AC Current specifications are AC coupled, true RMS
- For non-sinusoidal waveforms:
  - Add 1.0% to accuracy specification for Crest Factor 1.0 to 2.0
  - Add 2.5% to accuracy specification for Crest Factor 2.0 to 2.5
  - Add 4.0% to accuracy specification for Crest Factor 2.5 to 3.0
- For best accuracy use REL ( $\Delta$ ) function to compensate the offsets

## DC Voltage

Model	Range	Resolution	Accuracy
390B	40.00 mV	1 $\mu\text{V}$	0.03 + 3
	400.0 mV	10 $\mu\text{V}$	
	4.000 V	100 $\mu\text{V}$	
	40.00 V	1 mV	
	400.0 V	10 mV	
	1000 V	100 mV	
391B	40.000 mV	1 $\mu\text{V}$	0.030 + 20
	400.00 mV	10 $\mu\text{V}$	
	4.000 V	100 $\mu\text{V}$	
	40.000 V	1 mV	
	400.00 V	10 mV	
	1000.0 V	100 mV	
393B	100.000 mV	1 $\mu\text{V}$	0.025 + 40
	1000.00 mV	10 $\mu\text{V}$	0.020 + 20
	10.0000 V	100 $\mu\text{V}$	0.015 + 20
	100.000 V	1 mV	
	1000.00 V	10 mV	

- Input Impedance: 10 M $\Omega$ , < 100 pF
- Overload Protection: AC/DC 1000 V

## Continuity

Model	Range	Resolution	Accuracy
390B	400.0 $\Omega$	0.1 $\Omega$	0.2 + 2
391B & 393B	400.00 $\Omega$	0.01 $\Omega$	0.2 + 30

- Open Circuit Voltage: -1.2 V
- Short Test Current: -0.3 mA
- Threshold: Adjustable 10  $\Omega$  to 50  $\Omega$
- Buzzer Response Time: < 10 ms

## Diode Test

Model	Range	Resolution	Accuracy
390B	2.000 V	1 mV	1.5 + 2
391B & 393B	2.0000 V	100 $\mu\text{V}$	1.5 + 20

- Open Circuit Voltage: 2.5 V
- Short Test Current: 1 mA

## DC Current

Model	Range	Resolution	Accuracy
390B	40.00 mA	1 $\mu\text{A}$	0.2 + 1
	400.0 mA	10 $\mu\text{A}$	
	4.000 A	100 $\mu\text{A}$	
	10.00 A	1 mA	
391B	40.000 mA	1 $\mu\text{A}$	0.2 + 40
	400.00 mA	10 $\mu\text{A}$	0.2 + 80
	10.000 A	1 mA	
393B	10.0000 mA	0.1 $\mu\text{A}$	0.1 + 40
	100.000 mA	1 $\mu\text{A}$	
	10.0000 A	100 $\mu\text{A}$	0.1 + 80

- Burden Voltage: 2 mV/mA at mA inputs and 60 mV/A at A inputs
- Max. Continuous Measuring Time: 10 minutes at mA inputs, 1 minute at A inputs
- Min. Rest Time: 20 minutes after continuous measuring
- Overload protection: AC/DC 400 mA at mA inputs, AC/DC 10 A at A inputs

## Resistance

Model	Range	Resolution	Accuracy	
390B	400.0 $\Omega$	0.1 $\Omega$	0.2 + 2	
	4.000 k $\Omega$	1 $\Omega$	0.2 + 1	
	40.00 k $\Omega$	10 $\Omega$		
	400.0 k $\Omega$	100 $\Omega$		
	391B	4.000 M $\Omega$	1 k $\Omega$	1.0 + 1
		40.00 M $\Omega$	10 k $\Omega$	2.0 + 20
400.00 $\Omega$		0.01 $\Omega$	0.2 + 30	
4.0000 k $\Omega$		0.1 $\Omega$		
40.000 k $\Omega$		1 $\Omega$		
393B		400.00 k $\Omega$	10 $\Omega$	0.3 + 30
	4.0000 M $\Omega$	100 $\Omega$	1.0 + 30	
	40.000 M $\Omega$	1 k $\Omega$	1.5 + 30	
	1000.00 $\Omega$	0.01 $\Omega$	0.050 + 30	
	10.0000 k $\Omega$	0.1 $\Omega$	0.025 + 30	
	100.000 k $\Omega$	1 $\Omega$		
393B	1000.00 k $\Omega$	10 $\Omega$	0.3 + 30	
	10.0000 M $\Omega$	100 $\Omega$	1.0 + 30	
	40.000 M $\Omega$	1 k $\Omega$	1.5 + 30	

### True RMS AC Voltage

Model	Range	Frequency	Accuracy
390B	40.00 mV <sup>(1)</sup> , 400.0 mV <sup>(1)</sup> , 4.000 V, 40.00 V, 400.0 V <sup>(1)</sup> , 1000 V <sup>(2)</sup>	40 Hz to 70 Hz <sup>(3)</sup>	0.5 + 2
		70 Hz to 1 kHz <sup>(3)</sup>	1.5 + 4
		1 kHz to 5 kHz <sup>(3)</sup>	3.0 + 4
		5 kHz to 100 kHz <sup>(4) (5)</sup>	5.0 + 20
391B	40.000 mV, 400.00 mV	40 Hz to 65 Hz	1.00 + 50
		65 Hz to 1 kHz	3.00 + 50
		1 kHz to 3 kHz	5.00 + 50
	4.0000 V, 40.000 V	40 Hz to 45 Hz	1.50 + 50
		45 Hz to 65 Hz	0.70 + 50
		65 Hz to 1 kHz	1.50 + 50
		1 kHz to 10 kHz	3.00 + 50
		10 kHz to 50 kHz	5.00 + 50
	400.00 V, 1000.0 V	50 kHz to 100 kHz	10.0 + 50
		40 Hz to 45 Hz	1.50 + 50
		45 Hz to 65 Hz	0.70 + 50
		65 Hz to 1 kHz	1.50 + 50
393B	100.000 mV, 1000.00 mV	40 Hz to 65 Hz	0.70 + 50
		66 Hz to 1 kHz	1.50 + 50
		1 kHz to 3 kHz	3.00 + 50
	10.0000 V, 100.000 V	40 Hz to 45 Hz	1.00 + 50
		45 Hz to 65 Hz	0.40 + 50
		65 Hz to 1 kHz	1.00 + 50
		1 kHz to 10 kHz	2.00 + 50
		10 kHz to 20 kHz	3.00 + 50
		20 kHz to 50 kHz	5.00 + 50
	1000.00 V	50 kHz to 100 kHz	10.0 + 50
		40 Hz to 45 Hz	1.00 + 50
		45 Hz to 65 Hz	0.40 + 50
		65 Hz to 1 kHz	1.00 + 50

(1) The bandwidth is 40 Hz to 5 kHz

(2) The bandwidth is 40 Hz to 1 kHz

(3) Below 10% of range, add 2 digits to accuracy

(4) Below 10% of range, add 10 digits to accuracy, < 50 kHz

(5) Below 10% of range, add 20 digits to accuracy, > 50 kHz

### True RMS AC Current

Model	Range	Frequency	Accuracy
390B	40.00 mA, 400.0 mA, 4.000 A, 10.00 A	40 Hz to 70 Hz	0.8 + 2
		70 Hz to 1 kHz	2.0 + 4
		1 kHz to 10 kHz	
391B	40.000 mA, 400.00 mA, 4.0000 A, 10.000 A	40 Hz to 65 Hz	0.8 + 80
		65 Hz to 1 kHz	3.0 + 80
393B	10.0000 mA, 100.000 mA, 10.0000 A	40 Hz to 65 Hz	0.7 + 80
		65 Hz to 1 kHz	2.0 + 80

- Below 5% of range, add 70 digits to accuracy

- Max. Continuous Measuring Time: 10 minutes at mA inputs, 1 minute at A inputs

- Min. Rest Time: 20 minutes after continuous measuring

- Overload Protection: AC/DC 400 mA at mA inputs, AC/DC 10 A at A inputs

**Frequency**

Model	Range	Resolution	Accuracy
390B	400.0 Hz	0.1 Hz	1d (3 3/4-digit mode) 5d (4 3/4-digit mode)
	4.000 kHz	1 Hz	
	40.00 kHz	10 Hz	
	100.0 kHz	100 Hz	
391B & 393B	40.000 Hz	0.001 Hz	0.1 + 10
	400.00 Hz	0.01 Hz	
	4.0000 kHz	0.1 Hz	
	40.000 kHz	1 Hz	
	100.00 kHz	10 Hz	

**Temperature**

Model	Range	Resolution	Accuracy
390B	-200 °C to 1200 °C	0.1 °C	1.0 + 10
	-328 °F to 2192 °F	0.1 °F	1.0 + 18
391B & 393B	-200 °C to 10.0 °C	0.1 °C	1.0 + 2 °C
	-10.1 °C to 1200 °C	0.1 °C	1.0 + 1 °C
	-328 °F to 50.0 °F	0.1 °F	1.0 + 4 °F
	-50.1 °F to 2192 °F	0.1 °F	1.0 + 2 °F

- Specified after 60 minutes of warm-up time  
 - Specification does not include error of the thermocouple probe

**Supplementary Functions**

Model	Function	Range	Accuracy
390B	AC + DC	Same as voltage and current	AC accuracy ± 1.0%
	HFR		AC accuracy ± 1.0% for 40 Hz to 400 Hz
	Peak Hold		AC accuracy ± (3.0% + 200 digits) for 40 Hz to 1 kHz
391B & 393B	AC + DC	Same as AC function	AC accuracy ± 1.0%
	HFR	Same as AC function	AC accuracy ± 1.0% for 40 Hz to 400 Hz
	Peak Hold	391B: Same as AC function x 1.25 393B: Same as AC function x 0.125	AC accuracy ± (3.0% + 100 digits) for 40 Hz to 500 Hz
	dB	120.00 dB	Not specified
	dBm (600 Ω)	120.00 dBm	Not specified

**Capacitance**

Model	Range	Resolution	Accuracy
390B	40.00 nF	10 pF	0.9 + 20
	400.0 nF	100 pF	0.9 + 10
	4.000 μF	1 nF	0.9 + 2
	40.00 μF	10 nF	
	400.0 μF	100 nF	0.9 + 10
	4.000 mF	1 μF	
	40.00 mF	10 μF	
391B & 393B	4.0000 nF	0.1 pF	Not specified
	40.000 nF	1 pF	1.2 + 200
	400.00 nF	10 pF	0.8 + 20
	4.0000 μF	100 pF	
	40.000 μF	1 nF	
	400.00 μF	10 nF	1.2 + 200
	4.0000 mF <sup>(1)</sup>	100 nF	
	40.000 mF <sup>(1)</sup>	1 μF	1.2 + 400

(1) Available in manual range selection only

**General**

Model	390B	391B	393B
Display	4,000 / 40,000 count		10,000 / 100,000 count
Measurement Speed	10 times per second	3 times per second	
Data Log Capacity	40,000 measurements	20,000 measurements	
Connectivity	IR-USB and Bluetooth (class 2)		IR-USB
Power	4 x 1.5 V AA size batteries		
Battery Life (typical)	50 hours	100 hours	
Auto Power Off	Adjustable up to 30 minutes or never		
Low Battery Indicator	√		
Overrange	OL or -OL is displayed		
Temperature	Operating	14 °F to 122 °F (-10 °C to 50 °C) at ≤ 80% relative humidity	
	Storage	-4 °F to 140 °F (-20 °C to 60 °C)	
Safety	EN61010-1 to 600 V CAT IV / 1000 V CAT III		
Dimensions (W x H x D), without case	3.8" x 8.2" x 2" (95 mm x 207 mm x 52 mm)		
Weight	1.4 lbs (630 g)		
Warranty	3 Years		
Standard Accessories	Test leads, K-type thermocouple adapter, protective case, optical-isolated USB cable, magnetic hanging kit, alkaline batteries		



# Service Information

**Warranty Service:** Please go to the support and service section on our website at [bkprecision.com](http://bkprecision.com) to obtain an RMA #. Return the product in the original packaging with proof of purchase to the address below. Clearly state on the RMA the performance problem and return any leads, probes, connectors and accessories that you are using with the device.

**Non-Warranty Service:** Please go to the support and service section on our website at [bkprecision.com](http://bkprecision.com) to obtain an RMA #. Return the product in the original packaging to the address below. Clearly state on the RMA the performance problem and return any leads, probes, connectors and accessories that you are using with the device. Customers not on an open account must include payment in the form of a money order or credit card. For the most current repair charges please refer to the service and support section on our website.

Return all merchandise to B&K Precision Corp. with prepaid shipping. The flat-rate repair charge for Non-Warranty Service does not include return shipping. Return shipping to locations in North America is included for Warranty Service. For overnight shipments and non-North American shipping fees please contact B&K Precision Corp.

Include with the returned instrument your complete return shipping address, contact name, phone number and description of problem.

B&K Precision Corp.  
22820 Savi Ranch Parkway  
Yorba Linda, CA 92887  
[bkprecision.com](http://bkprecision.com)  
714-921-9095

# LIMITED THREE-YEAR WARRANTY

B&K Precision Corp. warrants to the original purchaser that its products and the component parts thereof, will be free from defects in workmanship and materials for a period of **three years** from date of purchase. B&K Precision Corp. will, without charge, repair or replace, at its option, defective product or component parts. Returned product must be accompanied by proof of the purchase date in the form of a sales receipt.

To help us better serve you, please complete the warranty registration for your new instrument via our website [www.bkprecision.com](http://www.bkprecision.com)

**Exclusions: This warranty does not apply in the event of misuse or abuse of the product or as a result of unauthorized alterations or repairs. The warranty is void if the serial number is altered, defaced or removed.**

B&K Precision Corp. shall not be liable for any consequential damages, including without limitation damages resulting from loss of use. Some states do not allow limitations of incidental or consequential damages. So the above limitation or exclusion may not apply to you.

This warranty gives you specific rights and you may have other rights, which vary from state-to-state.

B&K Precision Corp.  
22820 Savi Ranch Parkway  
Yorba Linda, CA 92887  
[www.bkprecision.com](http://www.bkprecision.com)  
714-921-9095