

# D9010DMBA

## De-embedding software for Infiniium Oscilloscopes

This package includes PrecisionProbe and InfiniiSim Basic, two tools designed to de-embed the effect of cables and fixtures from measurements. PrecisionProbe allows you to characterize the response of a probe or cable; InfiniiSim lets you model out probes or cables from a measurement. It is available on all Infiniium oscilloscopes.

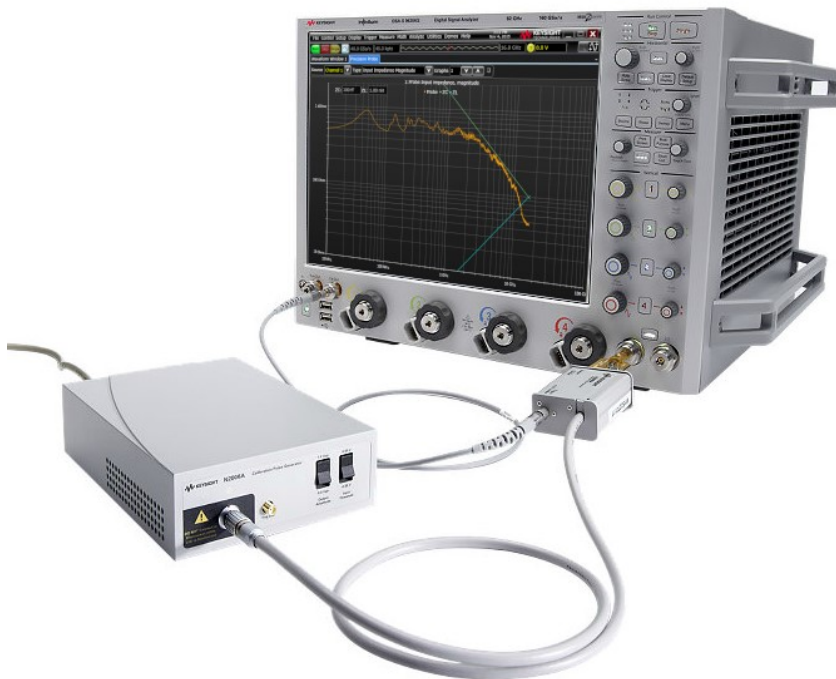

# Table of Contents

Background: Why De-embed? .....	3
Product Overview .....	4
PrecisionProbe .....	5
What is PrecisionProbe .....	5
Two methods for correcting probe responses .....	6
S21 insertion loss correction .....	6
Analysis tools .....	6
PrecisionProbe wizard .....	7
Probe correction .....	7
Bandwidth control .....	7
Understanding the analysis charts .....	8
Conclusion .....	9
Recommended hardware .....	9
InfiniiSim .....	10
What is InfiniiSim? .....	10
Common use models for productivity .....	11
Model your system as detailed as you need .....	12
Ordering Information and Related Literature .....	15
Flexible Software Licensing and KeysightCare Software Support Subscriptions .....	15
Selecting your license .....	16
Examples .....	16
Related literature .....	16

## Background: Why De-embed?

A measurement system is only as good as its weakest link. Users spend thousands of dollars on test and measurement equipment, including oscilloscopes, but then ignore the weakest element in their link, the cable. Oscilloscope vendors now provide methods to strengthen the weak link with the use of de-embedding software. However, de-embedding software requires specific characterization of the cable and the creation of an s-parameter file. To get the correct characterization you must characterize the cable using either a TDR or a VNA. Both of these methods provide characterization and s-parameters, but take time and instrument knowledge and more investment on test and measurement equipment.

It is the time, knowledge, and additional equipment that causes us to simply choose to ignore cable loss, and measurements taken by the oscilloscope now may be measuring the weakest link (the cable) and not the device you wish to measure as cable loss can dominate a measurement. At best you may choose to characterize only one or two cables and use that characterization (s-parameter file) to compensate for of every similar cable you own, causing the magnification of cable-to-cable variability as the cables characteristics vary from the “golden” cable.

Probes and cables are inherently lossy and rarely identical in their characteristics. The loss at times can be substantial, or enough from an ideal flat frequency response to cause variation in measurements and the loss of valuable margins. To compensate for the inherent loss, oscilloscope vendors use DSP correction to compensate for loss caused by probes. If a probe’s characteristics have changed/drifted or were not close to the model to begin with, the compensation may cause the probe to make worse measurements.

You also use custom probes and probe heads. While this provides great convenience for you, it means that the oscilloscope vendor no longer can even provide a “golden” compensation for your probe configuration. As a result, custom probes are uncorrected and inaccurate, but convenient.

You may also want to add something between the probe amplifier and probe head, including a cable to add length or a switch matrix. Adding a new element in the probe system adds inaccuracies as the probe amplifier and browser head are compensated to the model, but the newly created probe system now has no model. The result is that you must except the inaccuracies that have been added or try to characterize the additional element in the probe link. While accepting both of these trade-offs can be sufficient, it is time consuming to evaluate the element every time and not characterizing the element causes loss of margins (including higher jitter, smaller eyes, and slower rise times). This can also be the cause of differences between numbers measured in simulation and the number actually achieved in actual measurements.



Figure 1. Results from InfiniiSim showing what a signal would look like with no cable between the DUT and the oscilloscope.

## Product Overview

This software option contains two key parts: PrecisionProbe and InfiniiSim. PrecisionProbe lets you characterize any cables, probes or fixtures in your test path. InfiniiSim takes these characterizations and can remove them from your measurement results, giving you larger eye openings and more accurate measurements.

If you have the need to simulate a signal within your DUT at a point that can't be probed, you require InfiniiSim Advanced, part of the D9020ASIA software package for Infiniium oscilloscopes.

Please note that this is only a software package. For PrecisionProbe accessories, please consider the hardware accessories outlined in the PrecisionProbe section.

## PrecisionProbe

### What is PrecisionProbe

The PrecisionProbe feature for Infiniium oscilloscopes can solve the problems outlined in the background information by allowing quick characterization of your entire probe system (including cables and switches) using the calibration output of Infiniium oscilloscopes to properly characterize cables and probes.

The software quickly and accurately characterizes the desired element in the system without the need for additional test and measurement equipment. PrecisionProbe software can:

- Remove unwanted cable loss
- Characterize probe input impedance
- Properly Create Custom Probe Transfer Function

Now every probe and cable in your system can have the exact same frequency response probe to probe or cable to cable, without the inaccuracies that using one model can produce. Custom probes can now be properly characterized, and unwanted responses can be removed. Not only does PrecisionProbe characterize the cables, it allows for immediate use on the same instrument. You can characterize your measuring system and be using it within five minutes without adding more complicated, expensive equipment. PrecisionProbe saves time and money while increasing accuracy. When combining InfiniiMax probes with switches between the amplifier and the probe head, Precision- Probe allows for full correction and automation of each probes path. Full automation is then available to allow for swapping of the inputs and never leaving the automation.

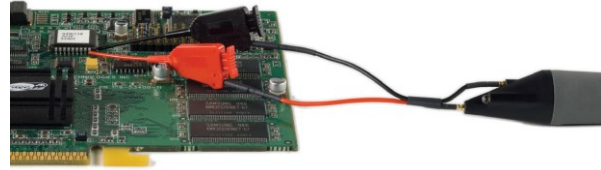

Figure 2. grabber tips on an active probe.

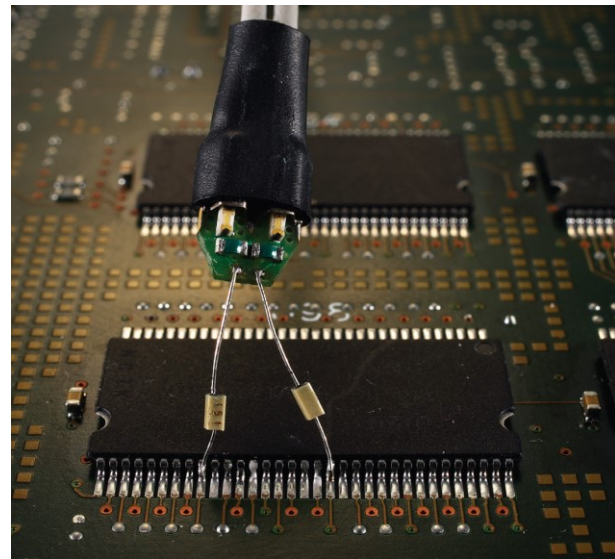

Figure 3. Probe with LW ZIP head

## Two methods for correcting probe responses

$V_{out}/V_{in}$  characterizes the output of the probe as a function of the input at the probe tips. Defining the response this way allows you to evaluate the probe's accuracy in reproducing the actual signal present in your system with the probe attached. This correction is known as  $V_{out}/V_{in}$ , which is what you'd see with a real band limited probe that has finite input impedance. PrecisionProbe corrects the " $V_{out}/V_{in}$ " response to be flat with frequency and phase to your defined bandwidth limit. It does not correct the loading effects of the probe. It should be noted that Keysight's probe frequency response corrections are typically defined using  $V_{out}/V_{in}$ .

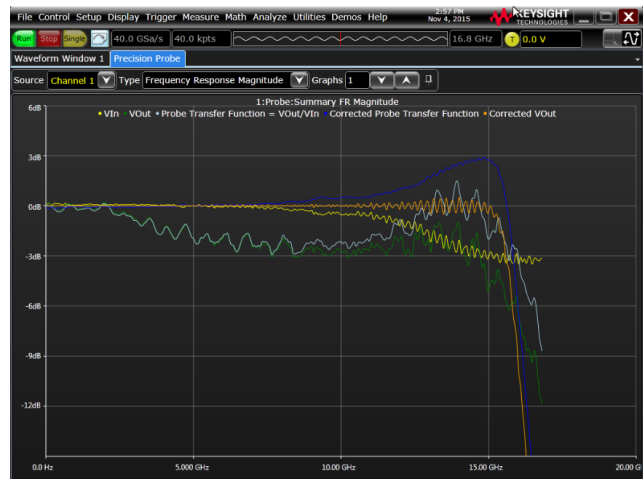

Figure 4. This chart shows the probe/cable's frequency response magnitude and the corrected response.

The second way to correct probes is an estimate known as  $V_{out}/V_{source}$ , this method corrects the probe as "what would be there if the probe were not present." There are oscilloscope and probe manufacturers that design their probes and DSP correction software to display what the waveform "would have been" in the absence of the probe. One drawback of defining the probe's response in this manner is that if the probe's loading causes your circuit to lose some timing or amplitude margin, you probably want to know that when you make a measurement.  $V_{out}/V_{source}$  compensation will hide these effects from you. PrecisionProbe also gives you the freedom to choose this method of correction, which can be effective if probing at the transmitter.

## S21 insertion loss correction

PrecisionCable can be used to remove insertion loss caused by cables or fixtures. Previously the only way to do this analysis was to characterize the cable using simulation, TDR, or a VNA. All of these methods can be accurate and can yield the desired results. You would then take the newly created s-parameter file to the oscilloscope and use the de-embedding software to remove the insertion loss of the fixture or cable. While this method works, it requires extra equipment and effort. PrecisionCable allows for this characterization to be done inside of the same oscilloscope that the measurements will be taken. Characterizing the cables and fixtures takes less than five minutes in many cases which saves significant time. Additionally, This measurement does require access to both ends of the fixture or cable, similar to methods such as VNA and TDR.

## Analysis tools

PrecisionProbe provides many tools to allow you to know exactly what has been characterized and what parameters have been improved by the innovative software.



## PrecisionProbe wizard

PrecisionProbe provides an easy to follow guide with its wizard. The wizard takes you step by step through the setup of the software and ensures that your measurements are taken with the highest signal integrity.

## Probe correction

To maximize margins, it is important to correct each probe identically and to ensure the correction method is the same. The Probe Correction menu allows you to change between Vout/Vin and Vout/Vsource. PrecisionProbe also allows for the source impedance via s-parameter file or an estimate. This is important when measuring Vout/Vsource to ensure a high level of accuracy as assuming an ideal 50 ohm environment can cause unwanted errors.

## Bandwidth control

Software such as PrecisionProbe can amplify high frequency noise when correcting for the loss of a probe or cable. The high frequency noise can then cause unwanted noise and inaccuracies. Bandwidth control allows you to remove unwanted high frequency noise by providing a filter. PrecisionProbe also provides the ability to control the amount of gain that is applied to the signal. You can increase the amount of boosting which improves risetimes but also increases noise, or you can decrease the amount of boosting, decreasing noise but degrading rise times.

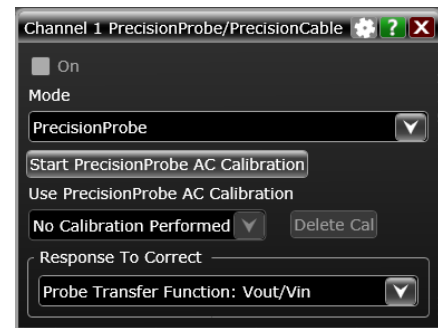

Figure 5: the PrecisionProbe setup window.

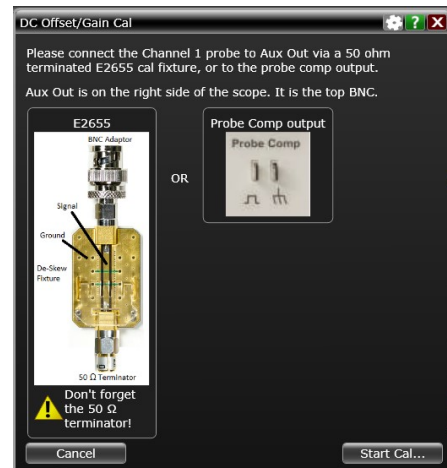

Figure 6. PrecisionProbe wizard setup.

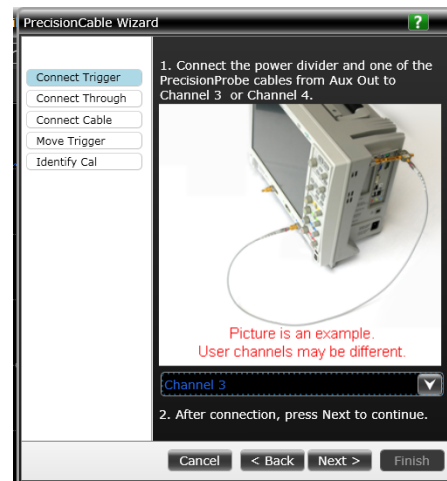

Figure 7. PrecisionCable wizard setup.

## Understanding the analysis charts

PrecisionProbe comes with many analysis charts that make understanding the characterization and correction very easy and provide insight that is unique to Keysight oscilloscopes.

### The summary chart

The summary chart shows the frequency response of the corrected probe or  $V_{out}$  (notice how flat the response is). The chart also shows the transfer function (TF) that is applied to the signal.

### Probe input impedance

Knowing the impedance profile of the probe allows you to estimate the loading of the probe system. PrecisionProbe allows for you to characterize the impedance profile, along with quickly determining the capacitance, impedance and inductance. Markers allow for easy viewing of the capacitance and inductance at each frequency.

### Probe correction filter

The probe correction filter simply shows the filter that is being applied to adjust for the probe. This filter is designed to ensure the signal stays perfectly flat.

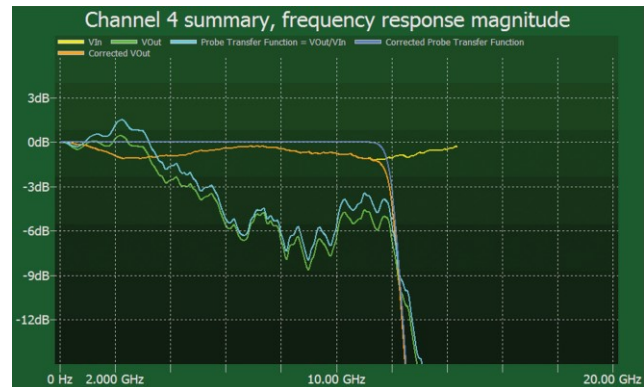

Figure 8: the summary chart.

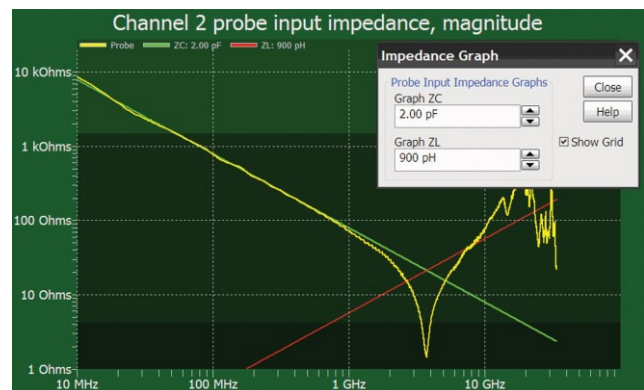

Figure 9. characterizing a 2 pF capacitor.

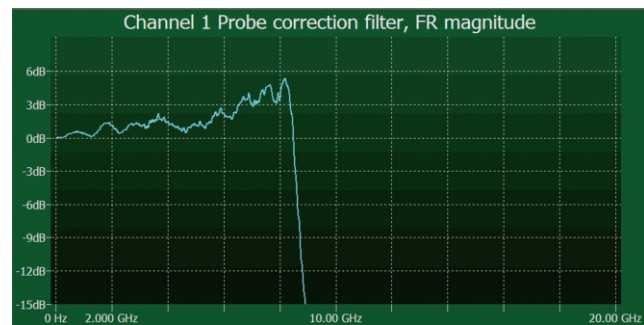

Figure 10. probe correction summary.



## Conclusion

Using PrecisionProbe provides the highest level of accuracy without requiring additional equipment. PrecisionProbe will help with accuracy by doing the following:

- Removing insertion loss caused by cables
- Characterizing the impedance of your probe
- Removing probe to probe variation
- Correcting for loss and non-linearities in custom probes
- Correcting for solutions such as switch matrices

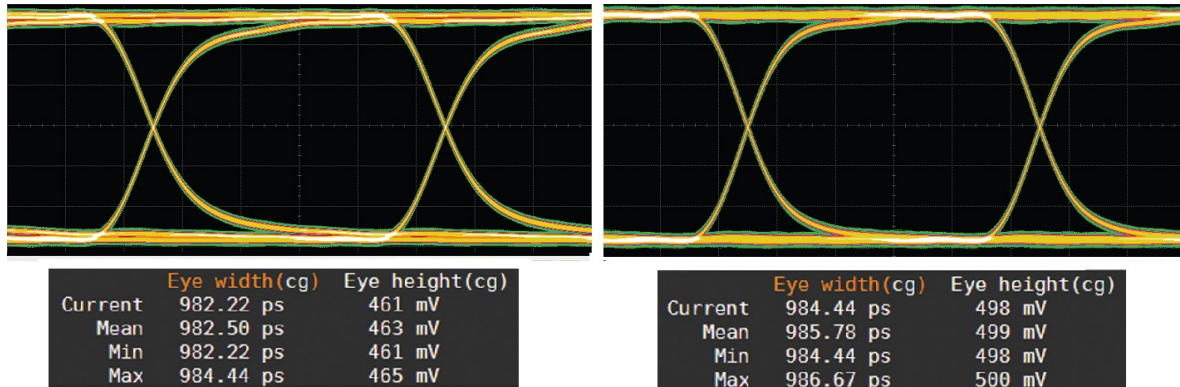

Figure 11. A real time eye with (right) and without (left) PrecisionProbe. In this case, probe correction nets a 37 mV higher eye, an 8% increase.

## Recommended hardware

Finally, here is some recommended hardware for probe characterization. Please use this table to make the correct accessory choice based on your desired oscilloscope and bandwidth. No hardware is included with D9010DMBA. For under 33 GHz, there are kits available specific to the oscilloscope family. The Kit number and contents are listed below. For 33 GHz and above, there is no kit provided; simply order the two parts in the table below.

9000 / 90000 / S-Series	V- / Z- / UXR Series	
Kit: N2161A	Kit: N2162A (for < 33 GHz)	No kit, just purchase (for > 33 GHz)
<ul style="list-style-type: none"> <li>• 11636B (x1)</li> <li>• 5061-5311 (x2)</li> <li>• M-M coax adapter (x2)</li> <li>• N2812B (x3)</li> <li>• BNC(M) to SMA(F) (x3)</li> </ul>	<ul style="list-style-type: none"> <li>• 5061-5311 (x2)</li> <li>• N2812B (x3)</li> </ul>	<ul style="list-style-type: none"> <li>• N2806A</li> <li>• N2814A</li> </ul>

# InfiniiSim

## What is InfiniiSim?

InfiniiSim has two modes: Basic and Advanced. Basic is available in D9010DMBA, Advanced is available in D9020ASIA. Advanced has all capabilities of Basic, and more. This document will describe the features of both, with notes telling you if the feature is Advanced only. If you need Advanced mode, consider D9020ASIA instead.

InfiniiSim works by relating the transfer functions of two circuits to yield an overall transfer function between them. The two circuits (the 'measurement circuit' and 'simulation circuit') are defined by the user. The measurement circuit represents the measurement setup the user has on the bench, while the simulation circuit represents the circuit the user would like have. As an example, the measurement circuit shown in Figure 1 comprehends a source device being measured by an oscilloscope with a cable in between.

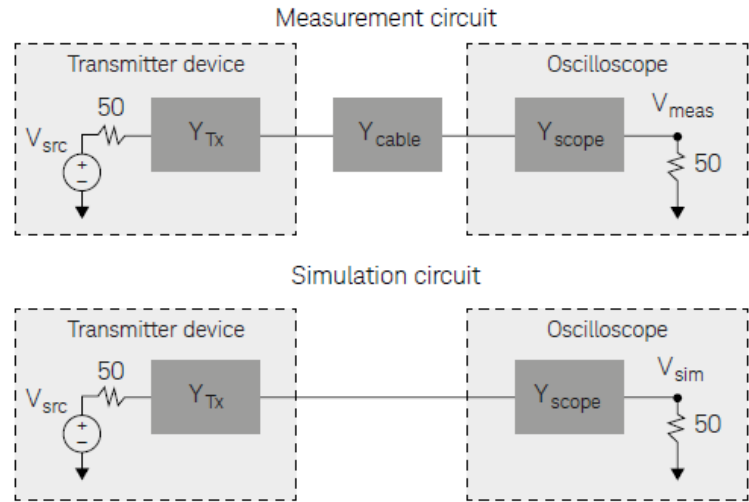

The simulation circuit has the cable removed. By relating the observation points in both circuits (the same location in this instance) to the source voltage, an overall transfer function that removes the effects of the cable results.

For the measurement circuit:

$$H_m(f) = \frac{V_{meas}(f)}{V_{src}(f)}$$

For the simulation circuit:

$$H_s(f) = \frac{V_{sim}(f)}{V_{src}(f)}$$

Relating the two to create the overall transfer function:

$$H(f) = \frac{H_s(f)}{H_m(f)} = \frac{V_{sim}(f)/V_{src}(f)}{V_{meas}(f)/V_{src}(f)} = \frac{V_{sim}(f)}{V_{meas}(f)}$$

Such that:

$$V_{meas}(f) * H(f) = V_{sim}(f)$$

We now have a simulation result that indicates the measurement we would get if the cable was removed. This example is the simplest case that InfiniiSim handles. More blocks can be used in the simulations and other observation points considered.

## Common use models for productivity

InfiniiSim works by relating the transfer functions of two circuits to yield an overall transfer function between them. The two circuits (the 'measurement circuit' and 'simulation circuit') are defined by the user. The measurement circuit represents the measurement setup the user has on the bench, while the simulation circuit represents the circuit the user would like have. As an example, the measurement circuit shown in Figure 1 comprehends a source device being measured by an oscilloscope with a cable in between.

1. **Removal of channel element insertion loss:** One block of loss such as from a cable or fixture between a digital source and the oscilloscope. The inverse gain of the block (S21-1) is determined and its time response is convolved with the acquisition.
2. **Inserting a channel element insertion loss:** One block of loss such as from a standard cable model to be inserted before the oscilloscope. The S21 of the block is determined and its time response is convolved with the acquisition.
3. **Remove scope input reflection (Advanced only):** Modeled using two blocks - one for the transmitter source and the other for the oscilloscope input (so the oscilloscope input reflection can be removed)
4. **Remove all effects of a channel element (Advanced only):** Using S-parameter models of source and scope load, the effects of a channel element are totally removed. This is different from 1 above (removing insertion loss) in that the interactions between the elements are taken into account. This provides the most accurate way to remove a channel element.
5. **Add all effects of a channel element (Advanced only):** Using S-parameter models of source and scope load with, a complete insertion of a channel element is performed. This is different from the Inserting a channel element insertion loss (#2 above) in that the reflective interactions between the elements are taken into account. This provides the most accurate rendering to insert a channel element such as a standard cable.
6. **Replace one channel element with another (Advanced only):** Modeled after removing or adding all effects of a channel element, one channel element block is easily substituted for another. Interactions between transmitter and oscilloscope elements are taken into account.
7. **Measurement plane relocation (Advanced only):** Measurement plane relocation allows you to view any voltage waveform in a circuit as the circuit exists by moving the simulation node to any location you desire. This is an 'in situ' analysis so is not a 'removal' or 'insertion' viewpoint.
8. **Relocate the observation node of a probed measurement (Advanced only):** View any voltage waveform in the probed circuit as the circuit exists by moving the simulation node to any location you desire. This is an 'in situ' analysis so it is not a 'removal' or 'insertion' viewpoint.
9. **Remove loading effects of oscilloscope probe (Advanced only):** To remove the loading effects of a probe, a topology of circuit blocks is given that allows probe models to be considered in the measurement. An oscilloscope probe, while it might be defined as 'high impedance', really does have a loading effect on the circuit. This effect can be taken into account and removed.
10. **Remove loading effects of a DDR interposer and probe (Advanced only):** To remove the effects of an interposer board in validating a dual data (DDR) memory system where the signals of the ball grid array (BGA) are not exposed and are unavailable for direct probing.
11. **General purpose configuration (Advanced only):** General topologies are provided for greater flexibility. General purpose probe, 6 block, and 9 block topologies are available with user defined measurement and simulation points and each block can be defined as having combinations of up to three elements in cascade or parallel arrangement so 27 total circuit elements can be defined for the most sophisticated scenarios.

## Model your system as detailed as you need

InfiniiSim waveform transformation toolset offers a wide breadth of possibilities to suit your goals:

### One block for simplest path compensation

Often you will simply want to compensate for the loss of a channel element, such as a cable or fixture. The one block model shown right gets this job done. It can also be extended to a remove/replace operation by changing simulation parameters. This is available in Basic and Advanced versions.

### Three-block analysis for true channel element removal and insertion

When the most precision is required for a single channel element removal and insertion is required you will need at least the 3 block model (Advanced only). This model uses block descriptions for the transmitter and the oscilloscope as well as the channel to describe the full system. The inclusion of the transmitter and oscilloscope blocks enable most complete waveform rendering by including the reflective S-parameter elements in the mathematical calculation of the transfer function used to transform from the measurement, M to the simulated measurement, S.

### General purpose configurations

The InfiniiSim waveform transformation toolset includes three general purpose topologies to enable detail tailoring of the description of your circuit. For probe modeling, the general-purpose probe topology is used while for SMA differential probe usage, the general purpose 6 block model will find use in a majority of cases. For those very sophisticated applications, possibly using both high impedance probes and differential SMA probe heads, the general-purpose model can be used to describe these complex scenarios. One block analysis is available on Basic, while two or more blocks requires Advanced.

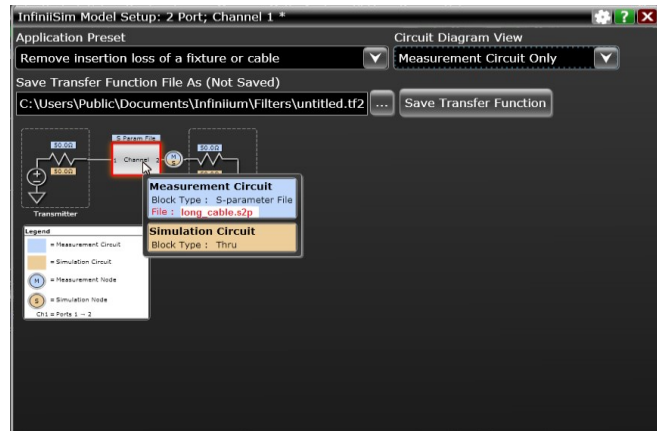

Figure 2. One block channel element removal

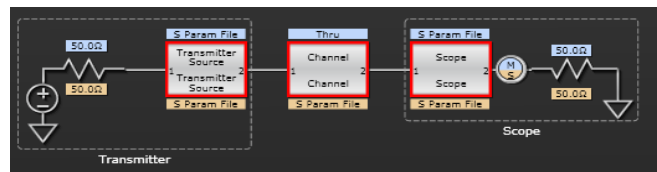

Figure 3. Three-block analysis for channel element insertion.

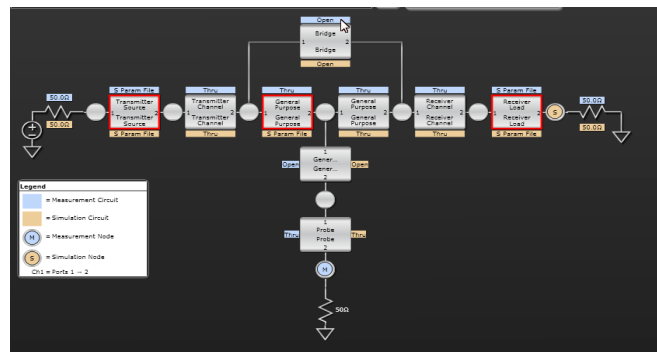

Figure 4. InfiniiSim can handle the most sophisticated system configurations with the general purpose 9-block configuration shown above.

## Circuit models to define your setup (Advanced only)

The InfiniiSim waveform transformation toolset provides a graphical user interface for you to define your system as you understand it and can be almost arbitrarily complex. This is accomplished through topology selection and circuit block definition. The most common circuit block definition is that of an S-parameter model which can be measured directly using a vector network analyzer, be derived from a time domain reflectometer with appropriate conversion software or be created from a simulation tool such as the Advanced Design System.

S-Parameters can be entered as two port models (.s2p files) or as 4 port models (.s4p files). Circuit descriptions such as R-L-C definition or 'open' and 'thru' are also available as are more complex blocks that result from cascaded or parallel combinations of circuit elements. The InfiniiSim waveform transformation software makes AC small signal linearity assumptions to derive transfer functions from an actual measured location (node) to another location that where you aim to simulate measurement. This location may physically exist (but not be probable), or may incorporate a circuit model not actually present. The transfer function is used to derive a time domain 'filter' that is convolved with the acquisition to transform the acquired waveform to a waveform at the desired location.

### Measurement and simulation circuits (Advanced only)

The core of the InfiniiSim waveform transformation software is in defining two circuits: one that defines your measurement setup and the other to define what you desire to have as your measurement. The first we call the 'measurement circuit' and the second is the 'simulation circuit'. These can be as simple as one block between the source and the oscilloscope load, or as complex as nine circuit blocks as in general purpose model. The simulation and measurement circuits share the topology selected, however, in many cases, circuit definitions for each block will be very different from measurement to simulation. This leads to great flexibility in transforming acquisitions at a measurement point to any other virtually probed location. For the circuit shown in Figure 6, for instance, Block 'P' has an S parameter file describing its loading during measurement, however, for simulation, the loading is desired to be eliminated, thus the 'open' designation.

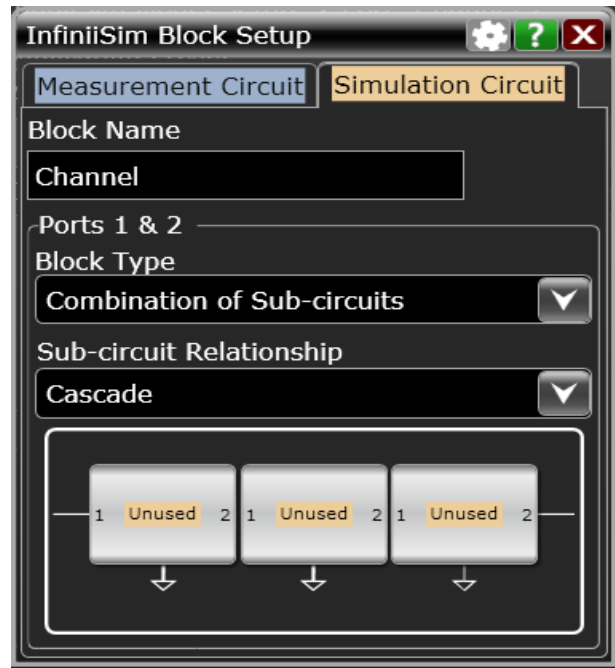

Figure 5. Sub-circuit capability: Any given InfiniiSim standard block can be described as a combination of sub-circuits.

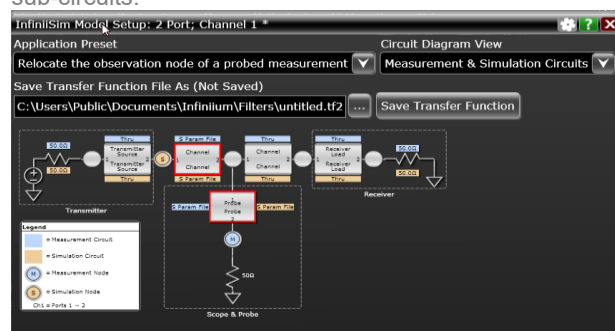

Figure 6. Measurement and Simulation circuits. Blue designates the measurement circuit elements while the brown labeling designates the simulation circuit elements.

## See what you deserve to see

With the InfiniiSim waveform transformation toolset, you can see transformed signals in confidence whether channel elements are being inserted removed or whether the measurement plane is being relocated. Figure 7 shows a waveform of a digital signal at 1.8 Gb/s going through a combination of fixture and cable. Note that for the longer sequences of identical digits the waveform reaches a level that is very different from when the data changes frequently. This is called ISI and is seen when the channel exhibits low pass filter characteristics. The fixture and cables were measured with a 4-port Vector Network Analyzer and removed using the channel element removal selection in InfiniiSim. The yellow CH1 trace in Figure 7 depicts the results. Note the blue waveform depicting the 'before measurement' directly at the transmitter versus the yellow waveform transformed using the 4-port channel model of the fixture.

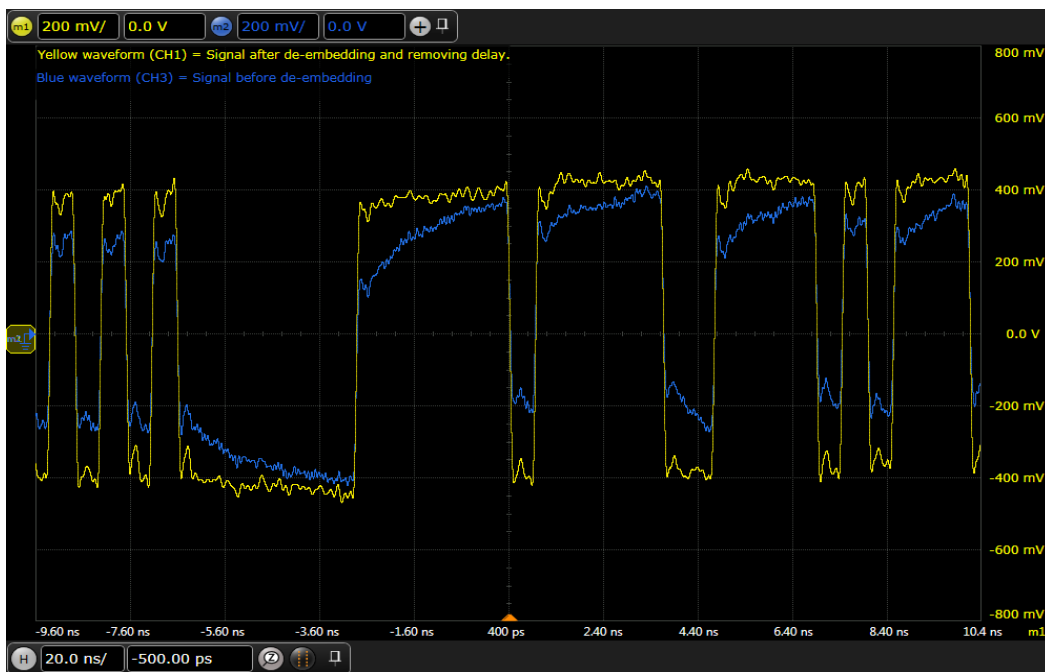

Figure 7. De-embedded, yellow, channel 1 waveform along with original channel 3 waveform.



## Ordering Information and Related Literature

### Flexible Software Licensing and KeysightCare Software Support Subscriptions

Keysight offers a variety of flexible licensing options to fit your needs and budget. Choose your license term, license type, and KeysightCare software support subscription.

#### License Terms

**Perpetual** – Perpetual licenses can be used indefinitely.

**Time-based** – Time-based licenses can be used through the term of the license only (6, 12, 24, or 36 months).

#### License Types

**Node-locked** – License can be used on one specified instrument/computer.

**Transportable** – License can be used on one instrument/computer at a time but may be transferred to another using Keysight Software Manager (internet connection required).

**USB Portable** – License can be used on one instrument/computer at a time but may be transferred to another using a certified USB dongle (available for additional purchase with Keysight part number E8900-D10).

**Floating (single site)** – Networked instruments/computers can access a license from a server one at a time. Multiple licenses can be purchased for concurrent usage.

#### KeysightCare Software Support Subscriptions

Perpetual licenses are sold with a 12 (default), 24, 36, or 60-month software support subscription. Support subscriptions can be renewed for a fee after that.

Time-based licenses include a software support subscription through the term of the license.

**KeysightCare Software Support Subscription provides peace of mind amid evolving technologies.**

- Ensure your software is always current with the latest enhancements and measurement standards.
- Gain additional insight into your problems with live access to our team of technical experts.
- Stay on schedule with fast turnaround times and priority escalations when you need support.

## Selecting your license

- Step 1.** Choose your software product (eg. D9010DMBA).
- Step 2.** Choose your license term: perpetual or time-based.
- Step 3.** Choose your license type: node-locked, transportable, USB portable, or floating.
- Step 4.** Depending on the license term, choose your support subscription duration.

## Examples

If you selected:	Your quote will look like:	
D9010DMBA node-locked perpetual license with a 12-month support subscription	<b>Part Number</b>	<b>Description</b>
	D9010DMBA	De-embedding Software (Precision Probe, InfiniiSim Basic)
	R-B5P-001-A	Node-locked perpetual license
	R-B6P-001-L	KeysightCare software support subscription, node-locked–12 months
D9010DMBA transportable time-based 6-month license	<b>Part Number</b>	<b>Description</b>
	D9010DMBA	De-embedding Software (Precision Probe, InfiniiSim Basic)
	R-B4P-001-F	6-months, node-locked KeysightCare software support subscription

To configure your product and request a quote:

<http://www.keysight.com/find/software>

Contact your Keysight representative or authorized partner for more information or to place an order:

[www.keysight.com/find/contactus](http://www.keysight.com/find/contactus)

## Related literature

Type	Description / URL
Brochure	<a href="#">Infiniium S-Series</a> (500 MHz to 8 GHz real time oscilloscope)
Brochure	<a href="#">Infiniium V-Series</a> (8 GHz to 33 GHz real time oscilloscope)
Data Sheet	<a href="#">Infiniium UXR Series</a> (13 GHz to 110 GHz real time oscilloscope)
Brochure	<a href="#">30 Things Only Infiniium Oscilloscopes Can Do</a>
App Note	<a href="#">Practical Application of the InfiniiSim Waveform Toolset</a>

Learn more at: [www.keysight.com](http://www.keysight.com)

For more information on Keysight Technologies' products, applications or services, please contact your local Keysight office. The complete list is available at: [www.keysight.com/find/contactus](http://www.keysight.com/find/contactus)

