

# Introduction to Oscilloscopes

*A Hands-On Laboratory Guide  
to Oscilloscopes using the  
Rigol DS1104Z*

**By: Tom Briggs,  
Department of Computer Science & Engineering  
Shippensburg University of Pennsylvania**

# Introduction to Oscilloscopes

## Objectives

- Understand basic function of oscilloscope
- Understand basic operation and controls of an oscilloscope
- Make measurements using an oscilloscope
- Properly use oscilloscope to prevent risks to safety and equipment damage

## Equipment List

- One Rigol DSO1140-Z or MSO1104-Z Oscilloscope
- Two Rigol RP2200 Passive 1x/10x probes
- One Rigol DS6K Demo Board w/ USB connector
- One PC with USB host
- One USB thumb drive to save captured images, formatted to FAT32

## Overview of an Oscilloscope

An oscilloscope is an electronic test instrument that displays the value of an electric signal over time. The display of the oscilloscope shows the amplitude (usually voltage) of a signal on the Y-axis, and time along the X-axis. Oscilloscopes are commonly used to:

- measure shape of a waveform (a graph of voltage over time),
- measure amplitude and frequency of a signal,
- and detect glitches and noise in a signal.

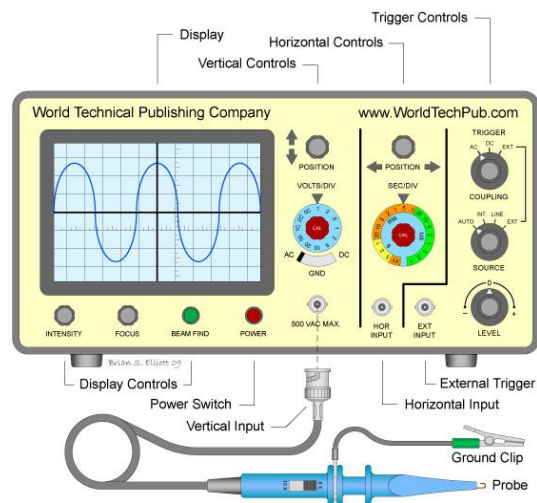

<sup>1</sup> "WTPC Oscilloscope-1". Licensed under CC BY-SA 3.0 via Wikipedia - [https://en.wikipedia.org/wiki/File:WTPC\\_Oscilloscope-1.jpg#/media/File:WTPC\\_Oscilloscope-1.jpg](https://en.wikipedia.org/wiki/File:WTPC_Oscilloscope-1.jpg#/media/File:WTPC_Oscilloscope-1.jpg)

Oscilloscopes (o-scopes or even just scopes), together with multimeters and power supplies are essential tools on an electronics workbench. Early o-scopes used a cathode-ray-tube (CRT) and analog amplifiers to display the signal on their screen. Modern scopes are typically digital capture, storage, and display allowing for a greater range of capture and analysis of the signal.

Digital Storage Oscilloscopes (DSO) read a voltage on an input channel, amplify the signal, condition the signal, and finally convert the signal with an Analog-to-Digital Converter (ADC). The ADC samples the voltage into an  $n$ -bit sample taken every  $t$  s. These samples are stored in the scopes memory and then displayed on the screen.

The newest generation of scopes are Mixed-Signal Oscilloscopes (MSO), allowing some number of *analog* input signals, as well as a larger number of *digital* input signals. An analog signal can have a range of values and we are interested in seeing the actual amplitude of the signal. A digital scope must store the  $n$  bits from the ADC for each sample. A digital signal has two values, true or false. Like any other digital device, these truth values are mapped onto voltage thresholds ( $V_H$  and  $V_L$ ). When the analog voltage,  $V_{in} \geq V_H$ , then the signal represents true, and when the voltage  $V_{in} \leq V_L$ , the signal represents false. An MSO scope can *digitize* the signal and store only the 1's and 0's for each sample. As a result, we lose the exact voltage level of the signal, but gain a much wider input bus. For example, many MSO scopes have 2 or 4 analog inputs, but have 16 (or more) digital inputs. When using the analog inputs, an MSO scope is equivalent to a DSO.

## Essential Parts and Controls

Almost every oscilloscope will have the following parts / controls:



**Display** - The display on the oscilloscope shows the current status of the signal.

**Graticule** - The display has a horizontal and vertical lines dividing the screen into a grid. In the Y-axis, each horizontal line represents some number of **Volts / Division**. Along the X-axis, each vertical line represents the number of **Seconds / Division**. The graticule helps reference the value of the signal. Controls on the scope can change the Volts/Div and the Seconds/Div for the captured signal. The term graticule is a hold over from the days of CRT tubes when the lines would be physically etched on the CRT display.

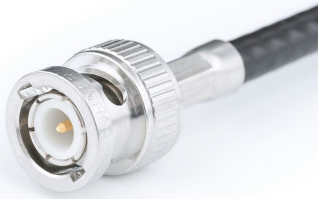

**Analog Input Channels** - The input channels are located on the front of the unit. The input channels are the industry standard Bayonet Neill-Concelman (BNC) connectors. The inner conductor carries the signal, and the outer shielding connects common ground. It is important to always have the oscilloscope connected to ground.

**Analog Probes** - The o-scopes probes have a BNC connection on one end, and both a ground and probe tip on the other end. Probes can be connected to any of the input channels on the front of the scope. The analog probes can be connected to any of the analog input channels. This allows different parts of a circuit to be simultaneously captured and analyzed.



**Horizontal Scale Controls** - This knob on the oscilloscope adjusts the time per division. Turning the horizontal knob to the counter-clockwise increases the time per division, and clockwise decreases the timer per division. The absolute minimum and maximum are determined by the properties of the oscilloscope. Generally, as the horizontal scale decreases more of the instantaneous details of the signal are visible but then less of the signal's period will be visible. If the scope has 12 horizontal graticules, and the time-base is set for 1ms / division, then 12ms of the signal will be displayed at a given time.

**Vertical Scale Controls** - The vertical scale on the scope adjusts the volts per division. Turning the knob counter-clockwise increases the volts per division, and clockwise decreases it. As the voltage decreases, less peak-to-peak amplitude will be visible, but the signal will also show increased *sensitivity* (smaller changes to amplitude). If the scope has 8 vertical graticules and the voltage-scale is set for 1V / division, then 8V of amplitude (peak-to-peak) can be displayed, which could be -4V to 4V, or 0 to 8V, or even 5V to 13V.

**Horizontal Position Control** - This knob will change the displayed horizontal position. The scope captures more data that can be displayed on a screen. Change the horizontal position will allow different parts of the signal to be displayed.

**Vertical Position Control** - This knob will translate the drawn signal up and down on the screen. This is especially useful when there are multiple channels active or when the voltage has a *DC bias*. For example, if the capture signal has a peak-to-peak amplitude of 5V to 13V, using the vertical control could bring the “top” of the signal down to the center of the screen, allowing a full-range of display.

**Trigger Control** - Most oscilloscopes have one or more different triggers. The trigger controls allow the selection and configuration of the trigger and the associated display options. For example, a common trigger mode is called *edge triggering* which can detect when a signal crosses a threshold. When this happens, the scope will display signal right before and right after the event.

**Vernier Dials** - These allows the knob to have dual functionality. Pressing in and turning the knob will have different behavior than simply turning it. For example, the vertical scale makes small adjustments (.1V/div) unless it is pressed in, then the adjustments are much larger.

## Performance Terms

Oscilloscopes have several key performance characteristics. These determine what types of signals can be captured by the scope and the associated probes.

**Bandwidth** - Bandwidth describes the frequency range of the oscilloscope (in Megahertz MHz). The bandwidth describes the frequency at which the sampled signal's amplitude will be attenuated to 70.7% of its original value (that is -3 dB attenuation in signals terms). Signal attenuation describes a reduction in the strength of a signal during transmission. Thus, a signal that was transmitted with 1V peak-to-peak amplitude at 100MHz would be received at 0.7V peak-to-peak amplitude on a 100MHz scope.

The figure below shows a typical attenuation curve. As the frequency goes up, attenuation losses mount and error rates increase. To measure a signal with 3% loss, we are limited to 30% of the scope's bandwidth.



As the signal degrades, it will have the same general shape, it would be considerably degraded and not useful for serious analysis. Smaller perturbations in the input signal will be lost entirely. Also note that the steepness of the curve suggests that exceeding the upper-bandwidth limit *may* yield a captured signal, it will be of very poor quality.

Most vendors recommend the 5-times rule: select an oscilloscope that has 5-times the bandwidth as the fastest signal to be measured. To accurately capture a signal at 100MHz would require a 500MHz scope. The Rigol MSO1104-Z's are rated at 100MHz, which means the fastest signal they can measure without attenuation losses would be 20MHz.

Faster scopes are certainly available, but at a price. For example, the TekTronix DPO7054C is a 500MHz with a list price of \$18,800. The Rigol MSO1104-Z 100MHz scope has a list price of about \$800. Comparing dollars per MHz, the Rigol scope comes in at \$8/MHz, while the higher-end TekTronix scope is \$37/MHz. The point is that increasing performance usually implies more than linear growth in cost.

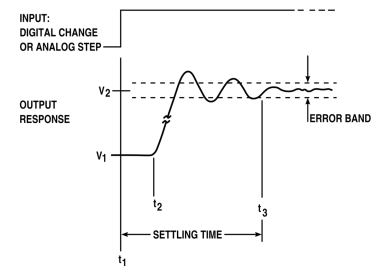

**Risetime** - Parasitic induction and other factors can cause high-frequency noise when a signal makes an edge transition. If the scope's rise-time is slower than the signal's rise time, the scope will show a "false-positive" signal that may actually cause the device-under-test (DUT) to reject. There is another 5-times rule, such that the scope's rise-time should be 5-times faster than the fastest signal.

**Sample Rate** - Digital scopes must convert an analog value into a digital sample and store that in the scope's memory. The stored signal is then visually reconstructed on the display with missing data *interpolated* as if the data were actually present. Interpolated data is not actually present, rather it is simply made up mathematically. The higher the sampling rate, the more samples are recorded, and the fewer points are interpolated, and the more faithful the signal will be to its original. The *Nyquist* theorem requires at least 2-times the number of samples per second as the highest frequency to have reasonable reconstruction, but that is a minimum. *Oversampling* captures more points and provides a more accurate display. The recommendation is another 5-times rule: the scope's sampling rate should be at least 5 times than the fastest frequency.

Example: a 100MHz sampled signal needs at least 500M samps/sec (on a 500MHz scope).

**Record Length / Memory Size** - Digital scopes store the captured data into memory. The larger the memory the greater the record length, the more time a signal can be captured. The time is:

$$T_{\text{acq}} = \text{record length} / \text{sample rate}$$

Having a larger record length allows a digital scope to allow the user to scroll through more than one screenful of data, or to perform more advanced analysis and triggering. With more memory, the same signal can be captured with a higher sample rate to enable a more accurate reconstruction.

## Exercises

1. What is the minimum oscilloscope required to properly capture 4ms of a 1V pk-pk 50MHz sine wave?
2. Suppose there were a 1V pk-pk sine wave and we suspected that there was noise in the signal (e.g. 0.05V pk-pk noise). Would you *increase* or *decrease* the vertical scale to effectively “zoom in” on the noise?
3. To capture and display a sine-wave, would you use the analog or digital channels of the scope?
4. Find the performance specifications described above for the Rigol MSO1104-Z plus oscilloscope and record them here:

## Rigol DS1104Z-S+

The Rigol MSO1104Z-S+ is a Mixed-Signal Oscilloscope. This instrument is based on the Rigol DS1104Z scope, but contains a 16 digital channel and logic analyzer and a two channel arbitrary function generator. These optional features will be covered in a different lab.

### *Key Features*

Among the important features and specifications for this unit, the DS1104Z includes:

- 100MHz bandwidth (3dB roll-off)
- 4 Analog input channels (BNC)
- 16 Digital input channels

- 12-bit Analog to Digital Conversion (ADC)
- 1GSa/s maximum real-time sample rate (500MSa/s two active channels, 250MSa/s four active channels).
- 12M points memory depth
- Real-time hardware waveform recording and playback functions (up to 60,000 points)
- 1mV/div to 10V/div dynamic range
- USB, LAN, and GPIB commands for remote control, setup, and testing
- CAT I 300 Vrms / CAT II 100 Vrms maximum input voltage
- 5ns/div to 50s/div time base
- Scope rise-time: 3.5ns
- DC gain accuracy: <10mV

### Front Panel

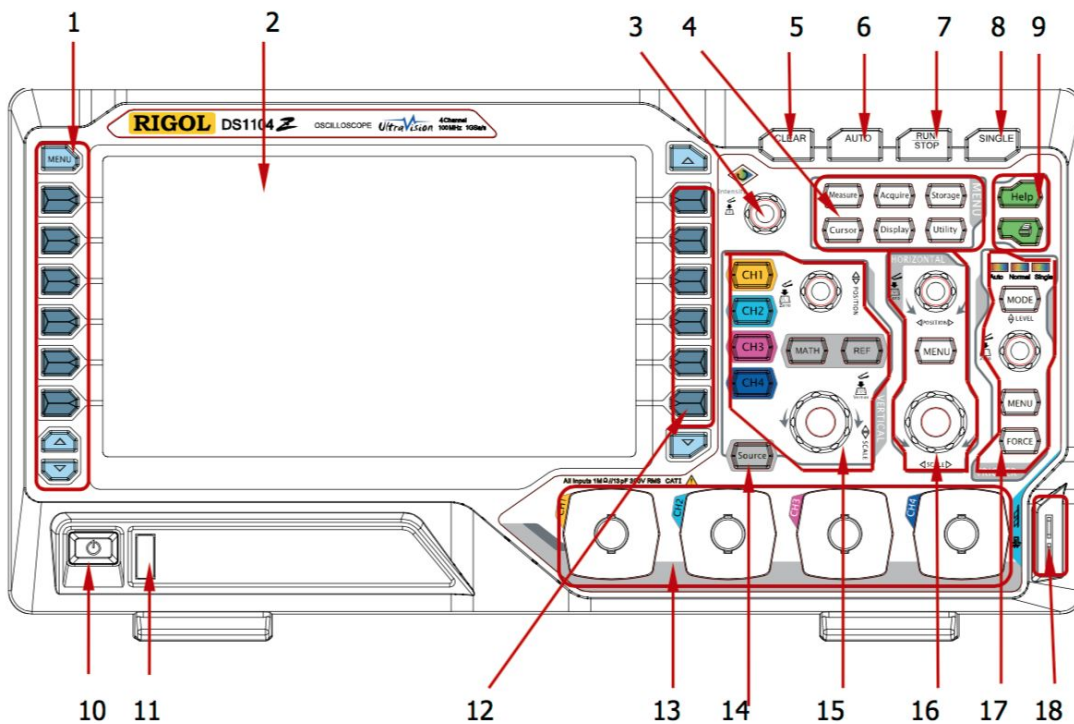

3

1 - Measurement Menu Softkeys	10 - Power switch
2 - LCD Display	11 - USB Host (USB drive, power)
3 - Multi-function Knob	12 - Function Menu Softkeys

<sup>3</sup> Rigol DS1104Z Site: <http://www.rigolna.com/products/digital-oscilloscopes/ds1000Z/ds1104z/>



4 - Function Selection Keys	13 - Analog Input Channels (1-4)
5 - CLEAR button	14 - Function Generator Menu
6 - AUTO button	15 - Vertical Controls / Channel Controls
7 - RUN/STOP button	16 - Horizontal Controls
8 - SINGLE button	17 - Trigger Controls
9 - Help & Print	18 - Probe compensation port

## Front Panel Functions

### Vertical Control Group

**CH1, CH2, CH3, and CH4** select the corresponding analog input channel. Pressing the channel key turns on and selects the channel, pressing it again turns the channel off. Turning a channel on enables the real-time sampling and display of the channel.

**MATH** selects the math virtual channel. The digital o-scope is capable of performing a number of math operations on the sampled data, which is then displayed on the screen. For example, using the **MATH** function, both the sampled data on CH1 and its absolute value can be displayed.

**REF** selects the reference virtual channel. The scope has a number of built-in reference waveforms, or it can record a portion of a sampled waveform and play it back. This is very useful to compare a working unit to a failed unit to quickly spot any differences. This can also be used for automating testing of equipment.

The **Vertical POSITION** knob modifies the vertical position of the current channel's waveform on the display. Turning the knob translates the displayed signal up and down on the screen. The "offset" position is displayed on the screen. Pressing the knob reset the position to 0. This adjustment is useful to move a signal on the screen so it doesn't overlap, or to make a signal overlap to measure its offset from another signal. Each channel has its own vertical position.

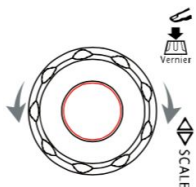

The **Vertical SCALE** knob modifies the vertical scale of the current channel. Turn the knob to increase or decrease the Y-Axis scale (e.g. Volts per division).

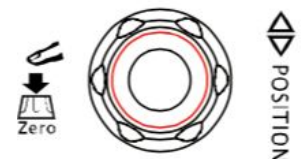
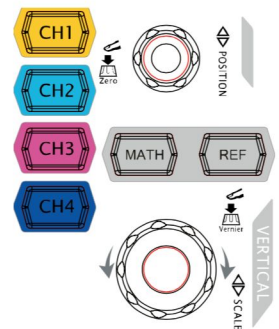

This will scale the displayed amplitude of the signal, effectively zooming the display in or out. This knob has *Vernier* capabilities, pushing the knob in while turning will switch from *fine* to *coarse* grained adjustments. Each channel gets its own vertical scale. This can be useful when trying to visualize a correlation between two signals, such as the input to an amplifier versus its output.

## Horizontal Control Group

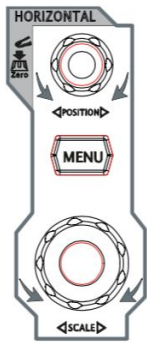

The Horizontal control group includes controls that affect the X-axis (which is usually the time base). Unlike the Vertical Control Group which affect only the selected channel, the Horizontal Control Group affects all displayed channels. Remember that the digital o-scope typically collects more samples than can fit on a screen and the signal is faster than a human can see. To display the signal, the scope *triggers* on some condition (such as a rising voltage) and displays the collected data. The digital memory of the scope holds samples before and after this trigger point. These controls allow the operator to select what data is displayed, and the sampling / display rate of the signal.

The **MENU** button opens the horizontal control menu on the display and enables the *right soft-keys* (#12 on front panel diagram).

The **Horizontal SCALE** knob modifies the horizontal time base (typically seconds / division). The horizontal scale allows operator to effectively zoom in/out on a sample. By decreasing the time per division, more samples are collected and more detail in the signal can be seen. Zooming in on previously captured data will only show as much detail as was originally sampled (*compressed mode*). Pressing the knob will enable the *sweep* mode where the scope just collects data with some periodicity.



## Control Button Group

There are four buttons along the top of the unit (#5 - #8 on the front panel diagram).



If the unit is in a stopped state and displaying previously captured data, pressing this key will clear all waveforms on the screen. If the unit is in a run state, new waveforms will still be displayed.



The auto-set button is one of the most useful tools when first learning how to use an oscilloscope. Pressing this button will cause the scope to automatically adjust the vertical scale, time base, and trigger mode according to the current input signals.



This key will toggle capturing the scope between run mode (capturing data) and stop mode (display last captured data). The scope is running when the button is green (yellow) and stopped when it is red.

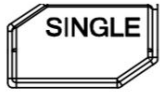

This key will set the trigger mode to single, which will cause the scope to enter Stop mode upon the first trigger condition (or when the FORCE button is pressed).

### Multifunction Knob

The multifunction knob (#3 on the front panel display) is used to control several different functions.

**Waveform Intensity** - In non-operational mode, this mode adjusts the brightness of the displayed waveform. Pressing it in centers the display at 50%. In old analog/CRT displays, every time the waveform displayed on a location, the spot's phosphor would become brighter and brighter. Digital scopes mimic this (*digital phosphorescence*). Dropping the intensity will cause common spots to become brighter and rare anomalies will be dim.



**Menu Selection & Operation Knob** - In menu operation mode this knob controls the options associated with a softkey. Rotating the knob will move the selection cursor up or down, and pressing the button will select the item.

**Keyboard Operation** The multifunction knob is also used to control pop-up keyboards. Rotate the knob to select the desired letter or number, and then press the button to select the value to add to the input.



### Function Menu

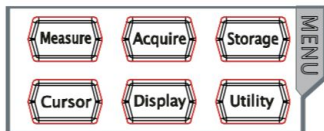

The function menu controls various options that influence the operation of the oscilloscope. Pressing one of these buttons causes the right-hand options list and soft-keys on the display to reflect the currently selected function.

**Measure** - on-screen measurements and statistics.

**Acquire** - signal acquisition mode and memory depth

**Storage** - file storage and recall, including storing screen shots, waveforms, and saved signals.

**Cursor** - on-screen cursor measurements.

**Display** - display parameters, such as persistence time, intensity, graticule configuration

**Utility** - system utilities, configuration, and other advanced tools

### Print Control



The Rigol oscilloscope supports saving a screen-shot as a PNG image file onto a USB "thumb-drive." The drive must be formatted as FAT32, must be less than 8GB, and must be plugged into the front USB port before turning the unit on. Pressing the print button will capture the screen

## Rigol DS104Z Display

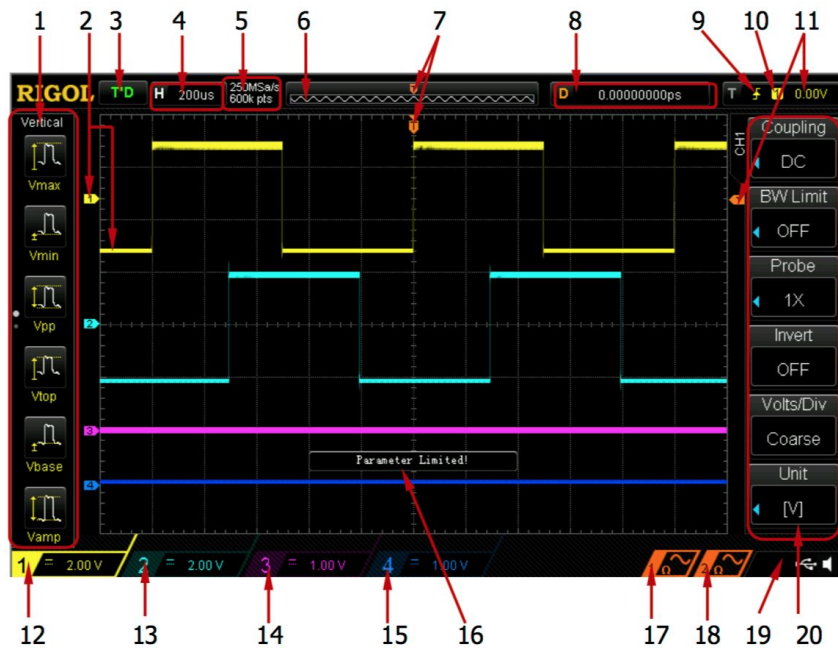

1 - Auto Measurement Items	11 - Trigger Level
2 - Channel Label / Waveform	12 - CH1 Vertical Scale
3 - Operational Mode	13 - CH2 Vertical Scale
4 - Horizontal Time Base	14 - CH3 Vertical Scale
5 - Sample Rate / Memory Depth	15 - CH4 Vertical Scale
6 - Waveform Memory	16 - Message Box
7 - Trigger Position	17 - Source 1 Waveform
8 - Horizontal Position	18 - Source 2 Waveform
9 - Trigger Type	19 - Notification Area
10 - Trigger Source	20 - Operation Menu

## Probes

The probes are the scope's connection to the device-under-test (DUT), and proper selection and setup of the probes is almost as important as the selection of the scope. Just like the scope, there are a number of different performance characteristics that describe the probe and that will impact the accuracy of the signal that is delivered to the scope's processing front-end.

One key characteristic of the probe is that it should not disrupt the circuit that is being tested (should not *load* the DUT). In order to do this, the probe must have very *high-impedance* and low *input-capacitance*. The higher the impedance, the lower the sensitivity to small voltages. As a consequence, there isn't a single one-probe for all occasions.

Before considering the actual probe, we should consider the coaxial wire that connects the probe to the scope. This wire typically has 50 Ohm impedance and 90pF of capacitance per meter. The wire is the greatest source of capacitance in the probe, and must be accounted for.

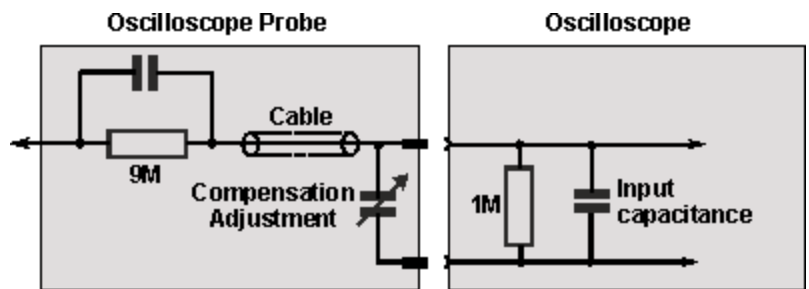

To reduce DUT load, the probe will have a large resistor. A 1X probe will have a 1M Ohm resistor in series with the signal, and about 120pF capacitance (cable and construction losses). This creates a delay in the propagation of the signal through the probe to the scope. The standard 1X probe is suitable for tasks where the driven impedance is much lower than 1M.

Another very common probe, the 10X probe, has a total of 10M Ohm resistance in series, and 12.2pF shunt capacitor to create an identical time constant to the 1X probe. This probe is more suitable for tasks that have a higher output impedances (such as many transistor-to-transistor logic devices, FETs, and CMOS devices).

**1X/10X Switch** - Many probes include a 1X/10X switch that allows the operator to select between the two modes. The scope channel must be configured to match the switch setting. Typically the 1X mode will be more limited than a dedicated 1X mode.

<sup>4</sup> Image from: [http://www.radio-electronics.com/info/t\\_and\\_m/oscilloscope/oscilloscope-probes.php](http://www.radio-electronics.com/info/t_and_m/oscilloscope/oscilloscope-probes.php)

**Compensation** - Passive probes may also include a compensation adjustment to adjust for small variations in the probe's capacitance. These adjustments are variable capacitors in parallel with the probe's circuitry.

**Input Resistance** - The series resistance of the probe adds to the circuit under test. As the input resistance nears the CUT's resistance, the probe begins functioning as a voltage divider.

**Input Capacitance** - The capacitance the probe tip adds to the circuit under test. This capacitance can have an impact on the circuit under test.

**Maximum Input Voltage** - The maximum input voltage the probe is safely rated for. Most probes are either Category II (150V AC) or Category III (300V AC). These values should be considered *absolute maximums* and should never be exceeded. There is significant risk to personal injury if these levels are exceeded.

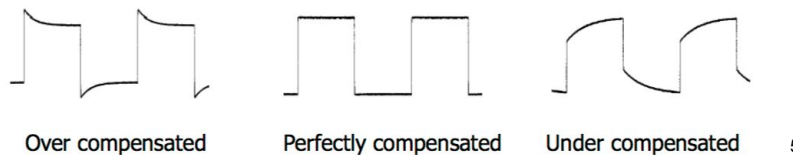

**Probe Compensation** - Most oscilloscopes have a probe-compensation reference signal driven to their front panel. On the Rigol scopes, there are two metal tabs on the front-right of the unit. This signal is a square-wave that can be used to check and adjust the probe's compensation.

**Active Probes** - Passive probes are constructed out of simple resistors, capacitors, and other passive elements. Active probes include dedicated amplifiers in the probe tip. These probes are able to measure much smaller and faster signals than signals than their passive counterparts, as the internal amplifiers reduce the impact of the wire's attenuation.



**Spring Clips** - Most scope probes have needle-tips that can be placed on very small *surface mount device* pins and pads. To connect a probe to a larger wire, most probes have a spring clip "hood" that goes on the end of the probe. Squeezing the tip exposes a metal hook that will grab an exposed wire when it is released.

---

<sup>5</sup> DS1000Z User's Guide

## Exercises

5. Find the specs of the Rigol RP2200 passive probe and record their parameters.
6. Suppose we needed to measure a 10MHz signal, should the RP2200 be on 1X or 10X?
7. Suppose we are measuring a circuit that has a 100K Ohm resistor being driven by 3.3V DC. What would the impact on the DUT by using a 1X and 10X probe? (*Hint: Ohm's Law*)

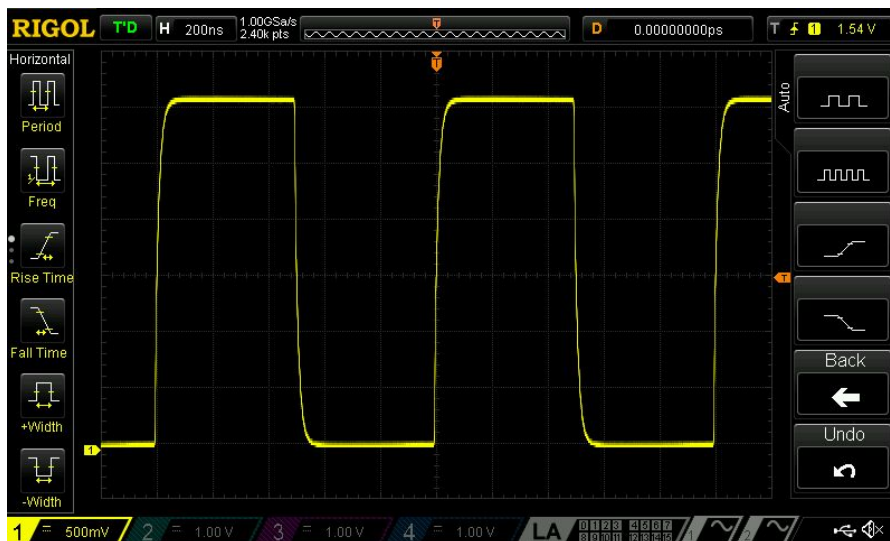

*Plot of the Compensation Waveform from Rigol MSO1104Z Scope*

## Lab Activity

1. Turn off the scope
2. Insert a USB key into the front panel of the Rigol MSO1104Z scope.
3. Turn on the scope
4. Press the front panel "AUTO" button to set the scope into a default state
5. Connect an RP2200 probe to channel 1 of scope
6. Use the probe slider switch to select 10X

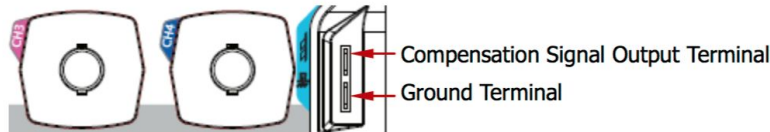

7. Place the ground connector on the ground tab on the reference signal (bottom tab).  
**ALWAYS PLACE GROUND FIRST**
8. Place a spring-clip hood onto the probe tip
9. Connect the spring-tip to to the reference signal output
10. Press the "AUTO" button again to automatically set the vertical and horizontal scales on the display
11. Press the green "Printer" button to save the image to your USB key. Include the screen shot in your lab report.

## Exercises

8. What are the volts per division determined by auto-set?
9. What is the peak-to-peak voltage?
10. What is the frequency? Time?
11. The RP2200 manual shows the voltage vs. frequency curve. Suppose we had a 10V signal at 1MHz, how much would you expect the signal to attenuate at 10MHz?



## Probe Compensation

The RP2200 probes have a compensation screw to match the channel inputs. Use the 1KHz wave form, ensure the probe is set for 10X, and then adjust the compensation trimmer (screw) until the wave looks like the flat-topped square wave shown in the “*Probe Compensation - Perfectly Compensated*” figure on page 15. The RP2200 manual provides proper procedures and pictures.

## Probe Grounding

The outer-shielding of the o-scope probe is connected, through the o-scope internal circuitry, to the chassis earth ground. In fact, there is a *dead short* through each of the metal shields on each of the four channels to each other and to earth ground.

This means that all measurements taken through the scope are referenced against earth-ground. Zero volts is zero volts against earth, 5V is 5V against earth. For devices that have an *isolated ground*, such as a battery or isolated transformer, there is no return path for current through earth ground. The ground connection on the probe can be connected safely to almost any point in the isolated circuit as an alternative reference point for measurements.

Most lab power-supplies (e.g. Rigol DP382) have an *isolation transformer* that isolates them from earth ground. The black “neutral” connection is “ground” for that port, and is not connected through to other channels or common earth ground. There are occasions where the *green* earth ground connection can be connected to the neutral, and then the power supply would no longer be isolated.

Many devices do not have an isolation transformer, and are earth-ground referenced - such as your personal computer. For example, using a multimeter to check for continuity, the shielding on the USB connector of a PC that is plugged will be a short to the shielding on the O-Scope ports as. Accidentally connecting the ground lead on the probe to any powered part of the circuit will establish a *dead short* through the device, the ground lead of the probe, through the scope, and back to mains power. Doing so can cause serious injury, including electrocution, burns, or lacerations from catastrophic probe failure. Even worse, it is possible that the device under test (DUT) is isolated until it is plugged into a PC, and then the short occurs!

As a general rule, one should **always** ground the probes to the neutral / ground rail of the circuit to be measured. That connection should **always** be made first and be made secure so that it doesn't slip off. That connection should **always** be isolated from “earth ground” so that it doesn't cause a short that will damage the probe or the circuit. Use a multimeter to check for shorts **before** applying power.

# Triggers

Most signals captured by an oscilloscope are continuous, without end. Consider a 1 MHz clock signal, each edge happens every 500 ns. If the scope were to show this on the screen, it is way beyond human ability to actually see the signal. Instead, the scope will show a *rolling sample* of the signal. (See figure on page 20 - “Rolling Plot of 1 MHz Signal from DSK Board”)

Triggers allow the scope’s operator to identify conditions that will cause the scope to stop the rolling value and display the captured signal. There are a wide range of different types of trigger supported by different oscilloscopes. The Rigol DS1104Z+ we have here supports the following types:

- Edge Trigger - Trigger on the level of the specified edge of a signal
- Pulse Trigger - Trigger on the positive or negative pulse width of a signal
- Slope Trigger - Trigger on the positive or negative slope of the signal (slew)
- Video Trigger - Trigger on specified video standards (NTSC, PAL)
- Pattern trigger - Trigger on a specified pattern (AND of input channels)
- Duration Trigger - Trigger on duration of a specified pattern
- Setup/Hold Trigger - Trigger on setup and hold time of clock vs. logic signal
- TimeOut Trigger - Trigger when delta-T of clock is outside of specification
- Runt Trigger - Trigger when a pulse edge passes through one level but not another
- Windows Trigger - Trigger when the signal leaves a high/low level window
- Delay Trigger - Trigger when the time difference between two signals it outside of spec
- Nth Edge Trigger - Trigger on the nth edge of a signal
- RS232 Trigger - Trigger on RS232 serial bus data and events
- I2C Trigger - Trigger on I2C serial bus data and events (start, stop, data)
- SPI Trigger - Trigger on SPI serial bus data and events

A complete description of the different types of triggers and their configurations is shown the in DS1104Z user’s manual. This section introduces a few of the basic triggers.

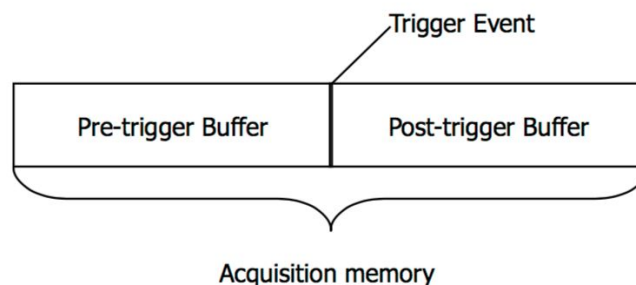

In a digital scope, the memory of the scope is divided into a pre-trigger buffer and a post-trigger buffer. The pre-trigger buffer is a circular FIFO queue that discards the oldest sample when a newer one is added. When the trigger logic detects an event, the pre-trigger buffer is frozen

and the post trigger buffer is filled (once), and the signal is displayed. The size of the memory and the sample rate determine how much of the signal can be captured before and after.

## Trigger Holdoff

Trigger holdoff is the amount of time that the scope waits before re-arming the trigger circuitry. The trigger will not rearm until the holdoff time of has expired, however data is still being collected into the sample memory. The holdoff can range from 16ns to 10s.

## Trigger Level

Triggers use various *trigger levels* to allow the operator to determine a level appropriate for their application. The trigger level vernier dial (on the far right of the unit) allows the user to change the trigger level value (an orange line with a trigger mark will be displayed on the screen, and the trigger level will be displayed in the upper-right corner of the screen.

The trigger level can be especially useful when dealing with digital logic. For example, suppose a particular digital circuit considers voltages above 1.75V to be logic high, and below 0.8V to be logic low. We could use a trigger to measure the *rise time* between the 0.8V and 1.75V levels by adjusting the trigger level.

## Trigger Sweep

The trigger sweep setting can be one of:

- **Auto** - No matter whether the trigger condition is met, there is always a waveform displayed on the screen. When the trigger condition is met, the data is frozen for a brief period before it returns to scanning for the next trigger. To trigger on unchanging DC voltages, auto mode must be used.
- **Normal** - In this mode, the trigger holds and displays the last trigger, and waits for the next. When the trigger is found, the display is updated.
- **Single** - In this mode, nothing is displayed until the trigger is detected, the signal is captured, and the unit stops scanning for another trigger. The Green Run/Stop indicator turns red.

## Edge Trigger

An Edge Trigger detects when the voltage goes from below the *Trigger Level* to above (a rising edge) or from above to below (a falling edge). The Edge Trigger in the Rigol scope uses three different edge types:

-  Rising Edge
-  Falling Edge
-  Any Edge

Adjusting the trigger level will cause the scope to trigger on different portions of the signal. For digital logic systems, it is often useful to set the trigger to either the logic-high or logic-low threshold levels for the type of technology being used.

### Edge Trigger Lab Activity

1. Connect the DS6K demo-board's USB cable to a power source (e.g. PC)
2. Insert a USB disk into the oscilloscope, turn the device on.
3. Connect an RP2200 probe's ground to any of the ground connections on the demo board (with the USB connector facing you, the 5th loop connector is a ground connection).
4. Connect the tip of the RP2200 (using the spring-loaded hood) to the square "Square" signal loop (second loop left of the connector).
5. Press the "Auto" button the oscilloscope.
6. Your signal should look like the following picture:









Rolling Plot of 1 MHz Signal from DSK Board

7. Press the trigger "MENU" button to bring up the trigger menu on the right-hand side of the display.
8. Press the blue function buttons to select:
  - a. Type: Edge
  - b. Source: CH1
  - c. Slope: Falling (arrow pointing down)
  - d. Sweep: Auto
9. Observe the difference between Rising and Falling slopes.
10. Adjust the trigger level upwards to until the signal is just rolling on the screen, then jog it downwards until the signal start to occasionally trigger. Record the trigger level where this happens.

11. Put the trigger level well above the square wave again to make it free run
12. Change the sweep type to Single
13. Bring the trigger level down (slowly) until the unit triggers (there will be a wave-form on the screen and the run/stop light will become red). Record the trigger level when this happens.
  
14. Next, change the sweep mode to Normal
15. Lower the trigger level below the thresholds used above
16. Next slowly raise the trigger level until the trigger just starts to “jitter”, and then raise it at least 0.05V more, describe your results.

## Pulse Trigger

The Pulse trigger can be used to trigger on the width of a pulse. The trigger can detect:

-  When the positive pulse width is greater than the specified width
-  When the positive pulse width is less than the specified width
-  When the positive pulse width of the signal is greater than the lower-limit, and lower than the upper-limit
-  When the negative pulse width is greater than the specified width
-  When the negative pulse width is lower than the specified width
-  When the negative pulse width is lower than the upper limit, and greater than the lower limit.

As with the edge trigger, the trigger level determines when the signal crosses into a positive or negative pulse. The pulse width is determined as a positive to negative edge transition.

This trigger type also has a time setting to describe the ideal pulse-width.





## Pulse Trigger Lab Activity

1. Repeat steps 1-6 of the Edge Trigger Lab Activity
2. Press the trigger “MENU” button to bring up the trigger menu on the right-hand side of the display.
3. Press the blue function buttons to select:
  - a. Type: Pulse
  - b. Source: CH1

- c. When: Width is greater than
  - d. Setting: 500ns (press the vernier to bring up a dialog to enter the value)
  - e. Sweep: Single
4. Record your results
  
5. Change the Setting to 501ns
6. Press the Single button
7. Record you results, and observe how many times the board triggers in 1 minute.
  
8. Move the probe to the “GLITCH\_CLK” located in the upper-right of the board. This is also a 100KHz square-wave 2.5V pk-pk, but it has noise injected into it. Note: if you move the ground clip, it must be plugged in first!
9. Press the trigger “MENU” button to bring up the trigger menu on the right-hand side of the display.
10. Raise the trigger level to 1.5V
11. Press the blue function buttons to select:
  - a. Type: Pulse
  - b. Source: CH1
  - c. When: Negative width is less than
  - d. Setting: 500ns (press the vernier to bring up a dialog to enter the value)
  - e. Sweep: Single
12. Roll the trigger level down towards 1V - record the voltage when the unit triggers on a short pulse width.

## Pattern Trigger

The pattern trigger is a sophisticated trigger that can detect a pattern that is a logical “AND” of the values of the input channels. Each channel can be triggered on:

-  High Level (above trigger level)
-  Low Level (below trigger level)
-  Don't care
-  Positive Edge - low to high crossing trigger level
-  Negative Edge - high to low crossing trigger level



The pattern trigger is also related to the Duration Trigger in that the same pattern can be described, and the duration can ensure that the pattern is held for a minimum or maximum time.

### Pattern Trigger Lab Activity

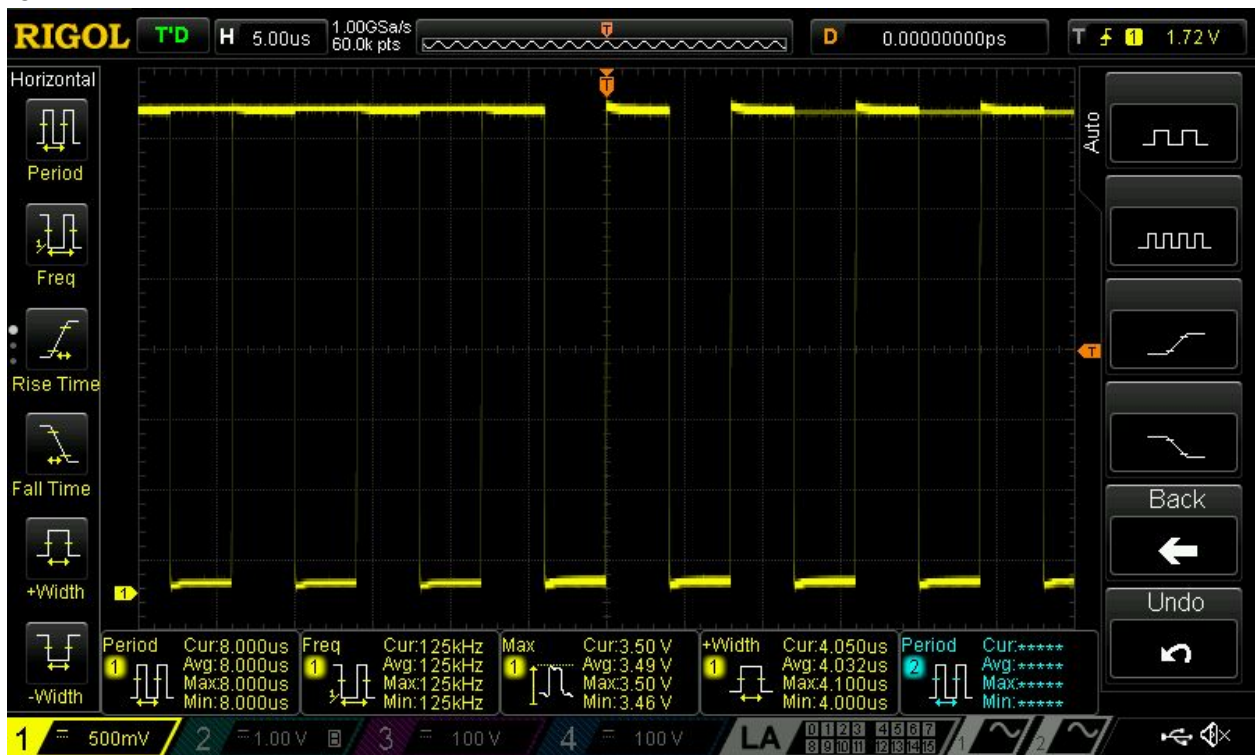
1. Repeat steps 1-6 of the Edge Trigger Lab Activity
2. Connect Channel 1's probe to the "GLITCH\_CLK" located in the upper-right of the board. This is also a 100KHz square-wave 2.5V pk-pk, but it has noise injected into it. Note: if you move the ground clip, it must be plugged in first!
3. Plug another RP2200 probe to channel 2.
4. Connect the probe's ground to a ground loop on the DS6K board
5. Connect the probe's tip to the I2C\_SCL loop (on the far left of the board)
6. Press the "Auto" button to auto-set the scope. This should appear as the following figure:



7. Press the Trigger Menu button
8. Press the blue function buttons to select:
  - a. Type: Pattern
  - b. Source: CH1
    - i. Use the dial to select **H** - but don't press it yet
    - ii. Use the Trigger Level dial to set the trigger level to 1.5V
    - iii. Press the selection dial in to accept channel 1's configuration
  - c. Source automatically becomes CH2
    - i. Use the dial to select **Y** - but don't press it yet

- ii. Use the Trigger Level to select a voltage that is about 15V
- iii. Press the selection button to accept CH2
- d. Source automatically become CH3
  - i. Use the dial to select  (don't care) and press the button
- e. Source automatically becomes CH4
  - i. Use the dial to select  (don't care) and press the button
- f. Sweep: Automatic
- 9. The display shows that the I2C\_SCL signal always falls during the high-edge of the GLITCH\_CLK signal.
- 10. Press the printer-button to record a screen capture of this display.

## Timeout Trigger

The Timeout Trigger is an easier tool to use to determine when a signal is too-long or too short. Using the Timeout Trigger we can determine if the time interval ( $\Delta T$ ) between a rising edge and its next falling edge (or vice versa) is too long or too short.

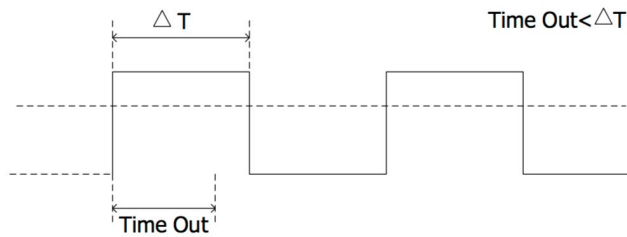



## Runt Trigger

Runts are electrical signals that pass from one logic level but do not pass through the next level.

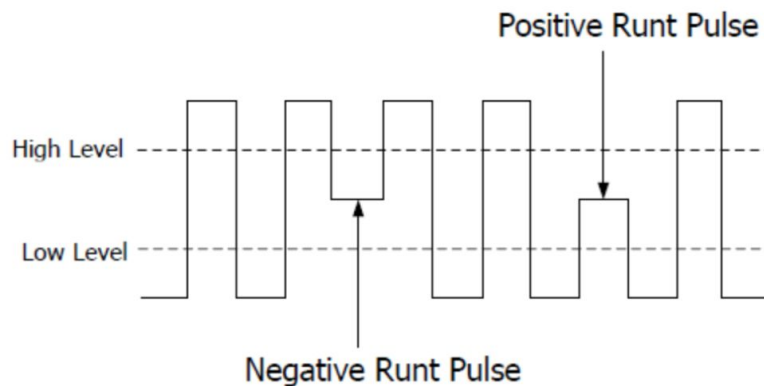

### Runt Trigger Lab Activity

1. Repeat steps 1-6 of the Edge Trigger Lab Activity
2. Connect Channel 1's probe to the "GLITCH\_CLK" located in the upper-right of the board. This is also a 100KHz square-wave 2.5V pk-pk, but it has noise injected into it. Note: if you move the ground clip, it must be plugged in first!
3. Press Trigger Menu
4. Press the trigger "MENU" button to bring up the trigger menu on the right-hand side of the display.
5. Press the blue function buttons to select:
  - a. Type: Runt
  - b. Source: CH1
  - c. Polarity: positive-to-negative
  - d. Qualifier None
  - e. Window: select first option and use the Trigger Level knob to select "Up Level" to be 1.5V
  - f. Window: select the second option and use the Trigger Level knob to select "Low Level" to be 500mV.
  - g. Sweep: Auto
  - h. The window should capture the glitchy clock, press the Printer Button to capture the output.

## RS-232 / I2C / SPI Trigger

These triggers can detect events in the serial communications protocol, such as:

- start of transmission,
- end of transmission,
- successful data transmission,
- specific data value, or
- transmission error.

Coupled with other advanced features of the digital scope, these triggers can be used to detect transmission events on the line, showing the actual electrical values, as well as the decoded / interpreted bus values of those values. Being able to see both the electrical and logic domain on the same screen, as well as what might be happening on the voltage rails of the board makes this an indispensable tool.

### RS-232 Trigger Lab Activity

1. Connect the DS6K demo-board's USB cable to a power source (e.g. PC)
2. Insert a USB disk into the oscilloscope, turn the device on.
3. Connect an RP2200 probe's ground to any of the ground connections on the demo board (with the USB connector facing you, the 5th loop connector is a ground connection).
4. Connect the probe's tip to the RS232\_TX signal on the left-hand side of the DS6K board.
5. Press the "Auto" button to auto-set the scope
6. Press the "Trigger Menu" button
7. Use the blue functions buttons to select:
  - a. Type: RS232
  - b. Source: CH1
  - c. Polarity: low to high
  - d. When: Start
  - e. BaudRate: 9600
  - f. Sweep: Single
8. The screen should show the bit-pattern for a single character when the trigger stops;
9. Use the horizontal scale to capture at least 3 "characters" being transmitted (don't restart the trigger). Save your image to the USB drive.
10. If you try to use the horizontal scale to capture 4 characters what happens to the display? Save your image to the USB drive.
11. Use the horizontal scale to zoom back into see 1 character.
12. Use the horizontal position to move the trigger point on the screen - this shows more of the pre-trigger or post-trigger memory
13. Double press the horizontal position to re-center the display on the center of the trigger window.

14. Use the horizontal scale knob to move the display “out” to a larger time base, and press the “Single” button - this captures more data (but with fewer samples per second).
15. Press the horizontal scale knob to open the “wave viewer” and then use the horizontal position to move through the captured data. Record the number of captured characters in one trigger event:
  
16. Repeat steps 1-6 of this activity
17. Use the blue functions buttons to select:
  - a. Type: RS232
  - b. Source: CH1
  - c. Polarity: low to high
  - d. When: Data
  - e. Data Bits: 8
  - f. Data: 48
  - g. Press the light-blue “Down Arrow”
  - h. Baud Rate: 9600
  - i. Sweep: Single
18. When the scope triggers, it has detected that the DSK6 board transmitted the character corresponding to 48 (in decimal, 30 in hexadecimal, or the digit 0 in ASCII code).
19. Press the printer button to capture the screen.

## Exercises

12. Summarize the differences you observed in the sweep modes of the edge trigger
  
  
  
  
  
  
  
  
  
  
13. Suppose you suspected that the clock for a logic device was erratic and was causing errors in the system. The clock should have been a 10MHz clock (square wave) that was 3.3V pk-to-pk, with a logic high threshold of 1.5V, and a logic low threshold of 0.8V. Describe the scope settings you would use to detect whether this was the case.
  
  
  
  
  
  
  
  
  
  
14. You suspect that a device has a timing issue. Normally, changes in a logic signal are only supposed to occur during the high level of the clock, but you suspect that they are occasionally happening during the low level of the clock. Describe the scope trigger

settings you would use to detect that this his happening.

15. What are the trigger conditions for the I2C bus? SPI bus?

# Oscilloscope Measurements

Digital oscilloscopes are capable of performing sophisticated analysis and measurements of the captured signals. There are several different ways to take measurements from the scope, including:

- **Manual Measurements** - Using the graticule of the scope
- **Cursor Measurements** - Using the *cursors* to select points on the screen
- **Automatic Measurements** - Using the built-in measurement tools

## Signal Measurements

There are a number of common characteristics that describe an electrical signal over time.

### Time Parameters for Single Signal

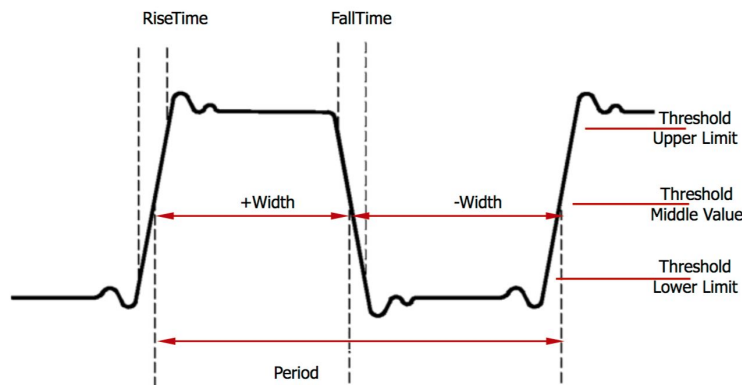

The figure shows a non-ideal square wave over time. The signal is showing the effects of capacitance and inductance on the shape of the curve, creating *slew* (the rise and fall time) and *ringing* (the oscillations just before and after the changes to the signal). These are the actual electrical levels of the signal, however, we may also be interested in the *logical properties*, such as when the signal crosses *logic thresholds* corresponding to Boolean true and false (high and low).

### Time Parameters for Two Signals

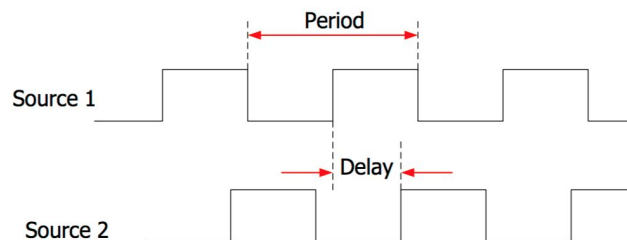

Individually, each signal has its own time parameters. In this case, we are interested in characterizing the relationship between two signals. Typically, we are interested in finding the delay between them (*phase*). These delays can be caused by *transmission line effects*, such as long transmission lines; or they could be caused by *propagation delays* in the electronic circuits themselves, or even *latency* in a processing system.

## Vertical Parameters

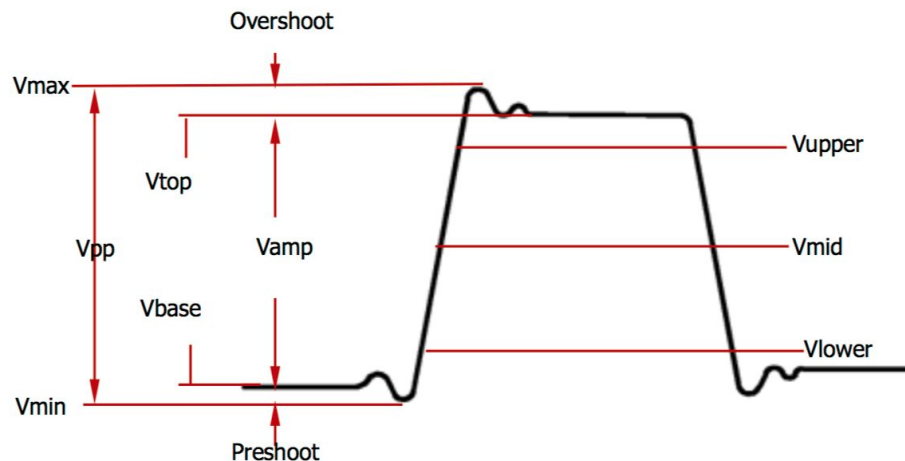

The vertical parameters of a signal describe how the voltage is changing. These measure the voltage levels of the signal as it propagates.

## Cursor Measurements

Cursors can be used to measure X- and Y-axis values on the waveform. To enable the cursor controls, press the "Cursor" button on the front panel.

There are three different cursor modes:

- **Manual** - The operator moves the cursors
- **Track** -
- **Auto**

### *Manual Cursor Mode*

In manual cursor mode, two pair of cursors is shown on the screen and a measurement window is overlaid on the screen. Using the blue selection buttons can move each of the four cursors. The measurement window will display various measurements based on each of the cursor positions.

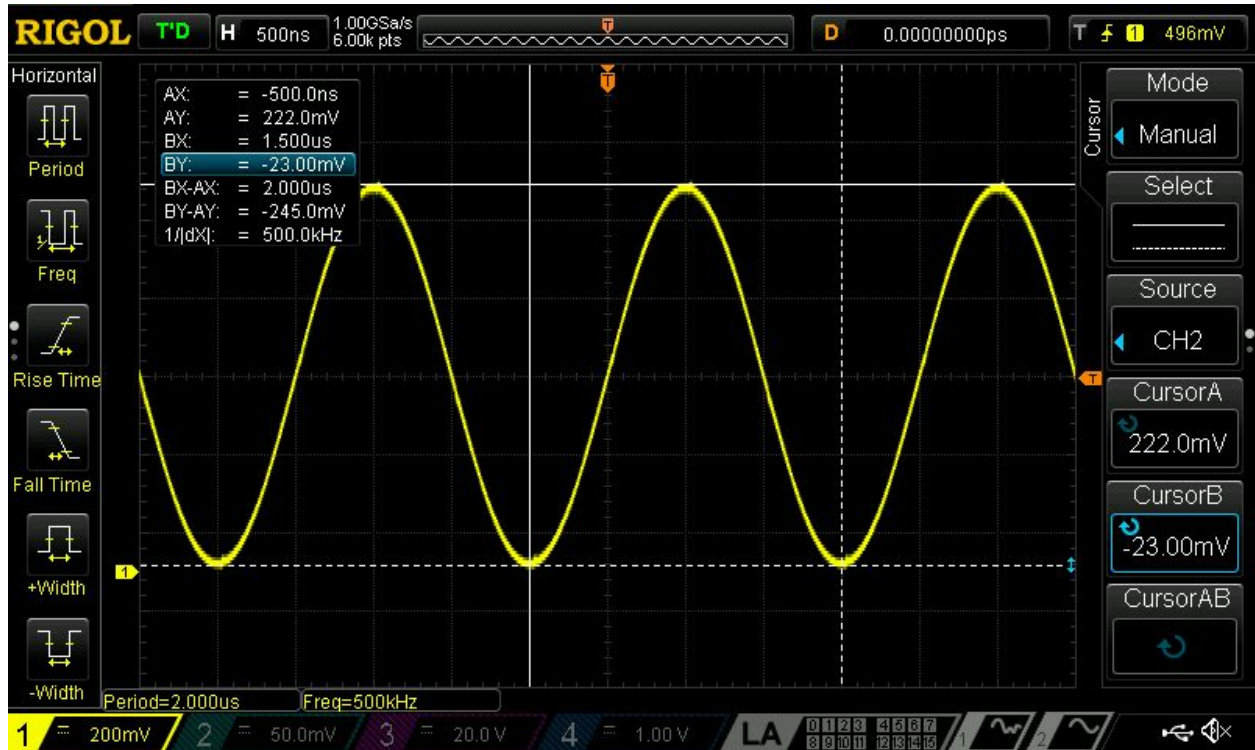

The measurement window include:

- AX : X value of the A cursor, trigger referenced
- AY : Y value of the A cursor, ground referenced
- BX : X value of the B cursor, trigger referenced
- BY : Y value of the B cursor, ground referenced
- BX-AX : horizontal difference of the cursors (delta-T, period)
- BY-AY : vertical difference of the cursors (delta-V)
- $1/|dX|$  : The reciprocal of BX-AX (frequency)

## Track Cursor Mode

In this mode, two cursors are displayed. The Y-axis values track along one of the selected input channels as the operator adjusts the position of the X-axis for each of the cursor bars. The same measurements are shown as in the manual mode. The advantage to this mode is that the operator doesn't have to visually determine the Y-axis levels, the scope will do this automatically.

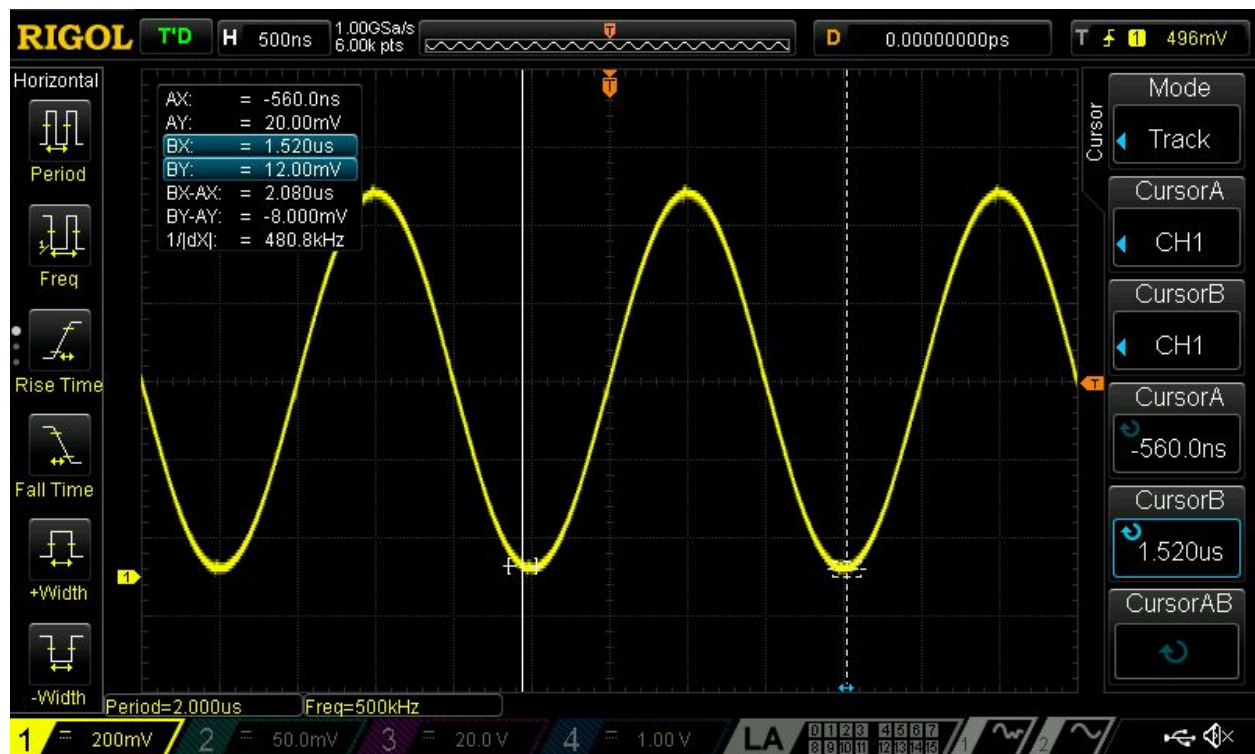

## Automatic Cursor Mode

This mode uses the cursor positions to identify regions of the signal to analyze, and then the operator selects one or more “quick measurements” to be displayed for that region. The subject of quick measurements will be described in the next section.

## Cursor Lab Activity

1. Connect the DS6K demo-board's USB cable to a power source (e.g. PC)
2. Insert a USB disk into the oscilloscope, turn the device on.
3. Connect an RP2200 probe's ground to any of the ground connections on the demo board (with the USB connector facing you, the 5th loop connector is a ground connection).



4. Connect the probe's tip to the SINE loop on the bottom, right of center of the DSK6 to get a 1V pk-pk sine wave.
5. Press the "Auto" button to auto-set the scope
6. Press the "Trigger Menu" button
7. Use the blue buttons to select:
  - a. Type: Edge
  - b. Source: CH1
  - c. Slope: Rising
  - d. Sweep: Auto
8. Use the "Trigger Level" control to select 500mV
9. Press the "Cursor" button (one of the 6 mode buttons)
10. Use the blue function buttons to select:
  - a. Mode: Manual
  - b. Select: Horizontal lines
  - c. Source: CH1
  - d. CursorA: use the selection knob to move the cursor to the top of the wave
  - e. CursorB: use the selection knob to move the cursor to the bottom of the wave
  - f. Select: Vertical lines
  - g. CursorA: use the selection knob to pick a point on the wave (e.g. the bottom)
  - h. CursorB: use the selection knob to pick the same point on the next wave
  - i. Record the 7 measurements here:
  
11. Use the blue function buttons to select *track* mode:
  - a. Mode: Track
  - b. CursorA: CH1
  - c. CursorB: CH1
  - d. CursorA: select the point where AY reads 500mV on the rising edge
  - e. CursorB: select the next point where BY reads 500mV on the rising edge
12. Record the 7 measurements here:
  
13. Double press the selection knob and move the cursor - describe what happens:

14. While the cursor menu is displayed, what happens when you press the cursor menu a second time? third time?

## **Automatic Measurements**

There are a number of measurements that the DS1104Z scope can perform, grouped by category.

### **Quick Measurements**

After pressing the AUTO button, the scope's display will include a number of quick measurements on the right-side of the display. Pressing one of these quick measurements will display the selected result on the bottom of the screen. The four "quick" measurements are:

- Single-period: measure the "period" and "frequency" of the the current signal within a single captured period
- Multi-period: measure the "period" and "frequency" of the current signal within multiple records and display the results
- Rise-Time: measure the rise-time
- Fall-Time: measure the fall-time

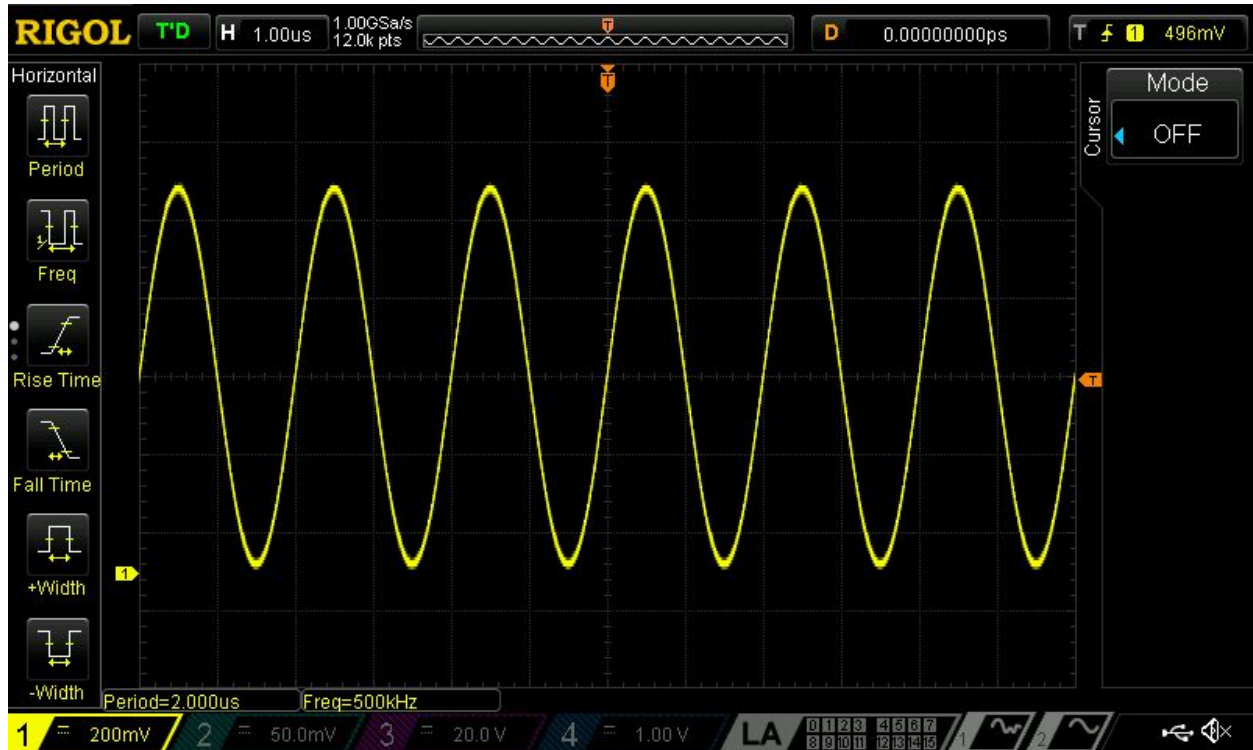

### One-Key Measurement

On the left-hand side of the instrument there are six soft-keys that select a measurement. The Menu button selects between Horizontal and Vertical measurements. Selecting a measurement turns on the display at the bottom of the screen. There are up to 5 items that can be displayed in this way.

The 16 horizontal measurements that can be enabled are:

- Period, Frequency, Rise Time, Fall Time, +Width, -Width
- +Duty, -Duty, tVmax, tVmin, +Rate, -Rate
- Delay Rising 1->2, Delay Falling 1->2, Phase Rising 1->2, Phase Falling 1->2

The vertical measures that can be enabled are:

- Vmax, Vmin, Vpp, Vtop, Vbase, Vamp
- Vupper, Vmid, Vlower, Vavg, Vrms, Overshoot
- Preshoot, Area, Per.Area, Per.Vrms, Variance

Turning these signals on adds the measurement at the bottom of the screen. The source of the measurement can be selected by pressing the “Measure” mode button and choosing a source. If a measurement either does not apply, has no input, or is invalid, it will be displayed as “\*\*\*\*\*”.

To turn a measurement off, press the “Measure” mode button and choose the “Clear” option and then select the measurement to remove.

### One-Key Measurement of all 32-Parameters

Pressing the measure button, then “Measure All” will toggle the display over all measurements for the selected signal. This can be useful, but does take up a large portion of the display window.



### One-Key Measurement Lab Activity

1. Connect the DS6K demo-board's USB cable to a power source (e.g. PC)
2. Insert a USB disk into the oscilloscope, turn the device on.
3. Connect an RP2200 probe's ground to any of the ground connections on the demo board (with the USB connector facing you, the 5th loop connector is a ground connection).
4. Connect the probe's tip to the MANU\_AN loop on the top, center of the DSK6 to get a square-wave.
5. Press the “Auto” button to auto-set the scope
6. Measure the following values:
  - o Preshoot:
  - o Overshoot:
  - o +Duty:
  - o Period:
  - o Frequency:

## Measurement Statistics

Instantaneous measurements are certainly useful for a variety of tasks, but sometimes it is important to characterize the performance of a system over a longer period of time. In addition to measuring a variety of instantaneous signal attributes, the scope can also use its deep memory to compute running statistics, including:

- Extremum measurements: Current, Average, Deviation, Count
- Difference measurements: Average, Max, Min

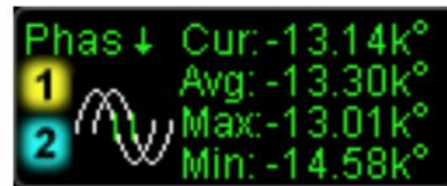
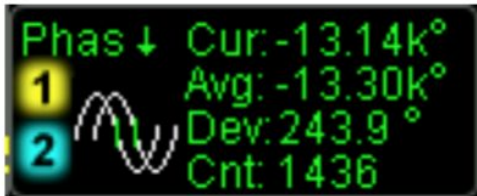

## Statistics Function Lab Activity

7. Connect the DS6K demo-board's USB cable to a power source (e.g. PC)
8. Insert a USB disk into the oscilloscope, turn the device on.
9. Connect an RP2200 probe's ground to any of the ground connections on the demo board (with the USB connector facing you, the 5th loop connector is a ground connection).
10. Connect the probe's tip to the MANU\_AN loop on the top, center of the DSK6 to get a square-wave.
11. Press the "Auto" button to auto-set the scope
12. Enable over-shoot and pre-shoot measurements
13. Enable display of the statistic (extremum), record the values:
14. Enable the display of the statistics (difference), record the values:
15. Use the print button to save the image to your thumb drive.
16. Describe what happens when pressing the "reset stat" button. Does repeating the experiment yield the same result? Do you expect that it should?