

48 Unit Management Cart

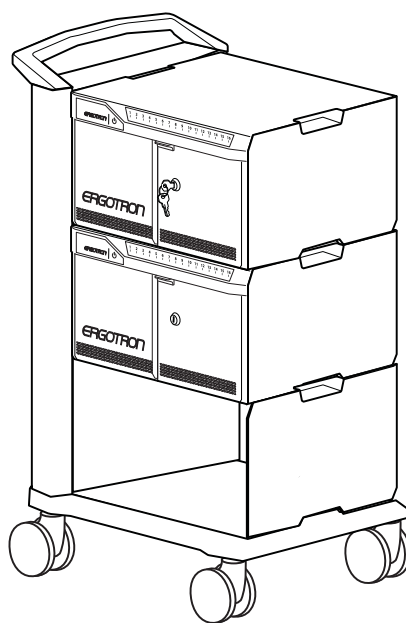

32 Unit Management Cart





 www.ergotron.com
 USA 1-800-888-8458
Europe +31 (0)33-45 45 600
China 86-769-86018920

Table of Contents

Hazard Symbols Review	2
Components & Tools.....	2
Features	3
Charging Set-up.....	4
LED and Syncing.....	8
Cleaning and Maintenance.....	10
Specifications.....	11
Service and Warranty Information	11

Safety Hazard Review

These symbols alert users of a safety condition that demands attention. All Charging and Managed Cart users should be able to recognize and understand the significance of the following Safety Hazards if encountered on the Cart or within Cart documentation. Children who are not able to recognize and respond appropriately to Safety Alerts should not use the Cart without adult supervision!

Symbol	Signal Word	Level of Hazard
	NOTE	A NOTE indicates important information that helps you make better use of your Cart.
	CAUTION	A CAUTION indicates either potential damage to hardware or loss of data and tells you how to avoid the problem.
	WARNING	A WARNING indicates either potential for property damage, personal injury, or death.
	ELECTRICAL	An Electrical indicates an impending electrical hazard which, if not avoided, may result in personal injury, fire and/or death.

Components

One Tablet Management Cart

Security wrench (for service use only)

Tools

Set-up requires a Phillips screwdriver

Features

48 Unit Management Cart

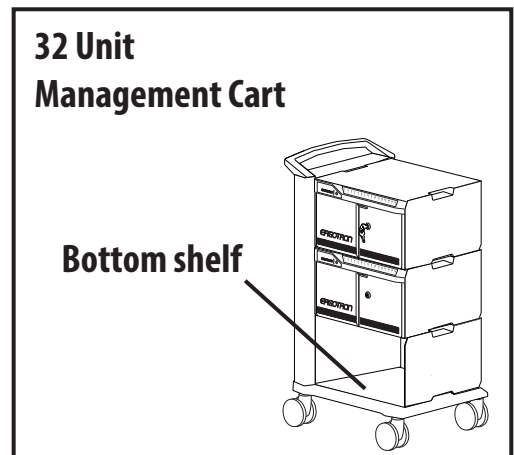
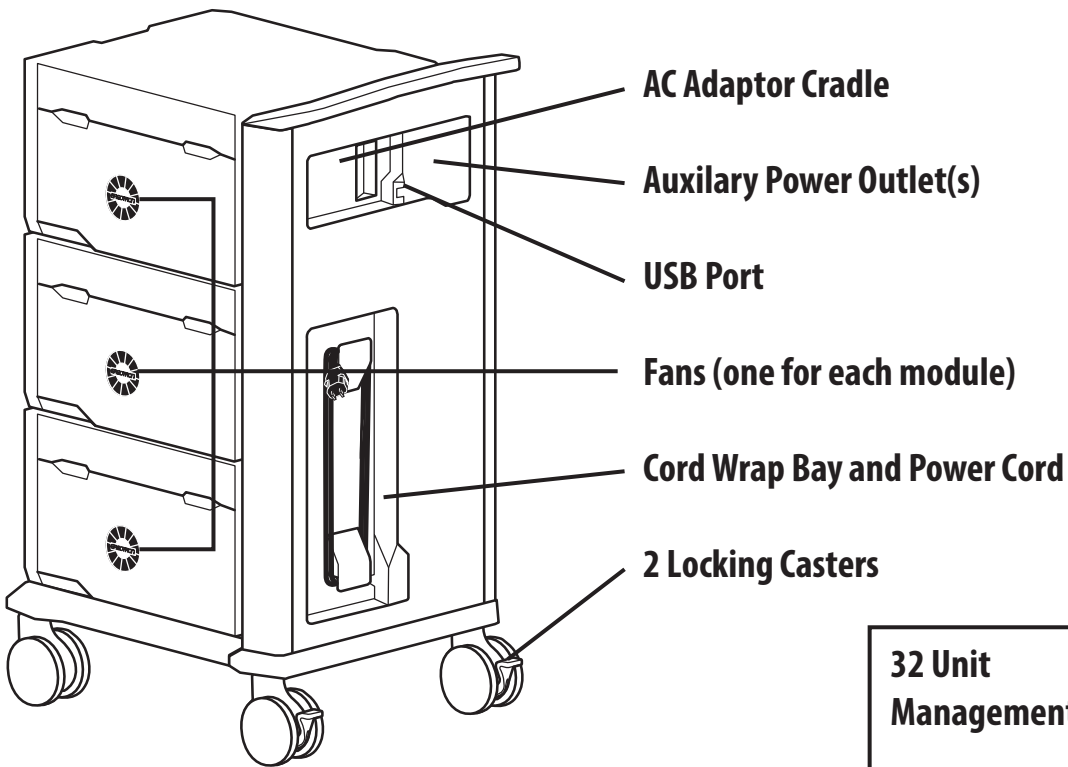
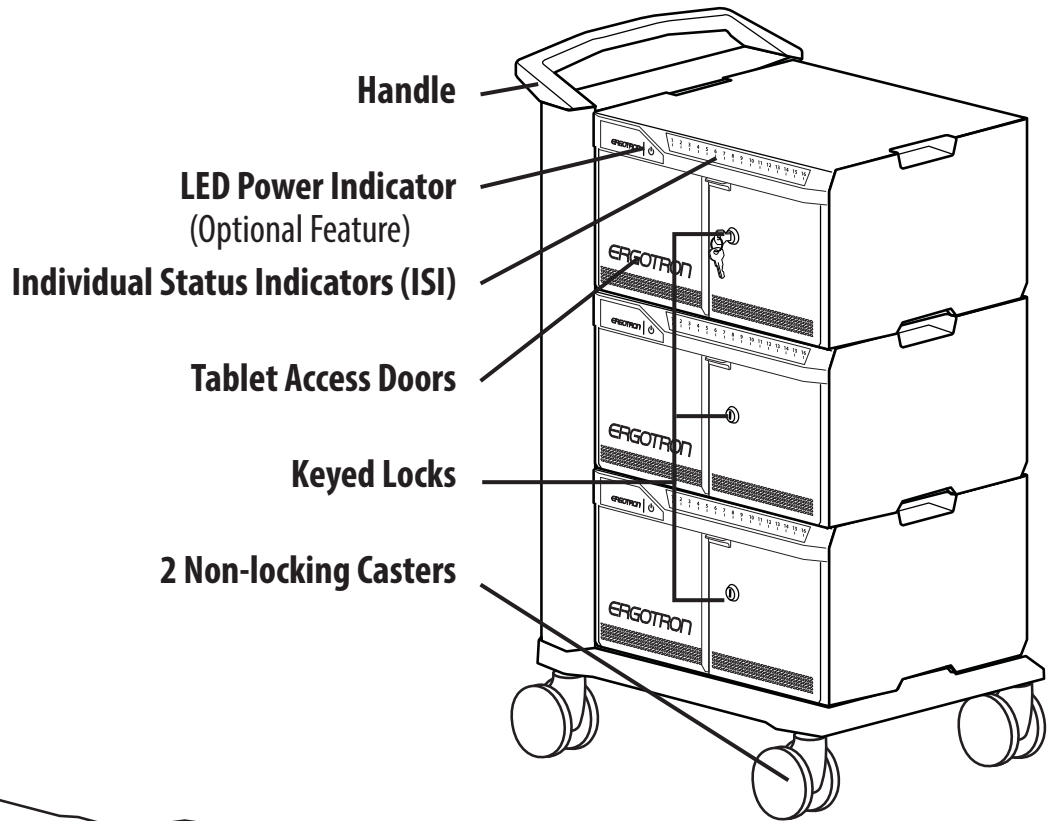

Tablet Charging Set-up

- 1 Make sure the cart power cord is disconnected from wall power supply before proceeding.

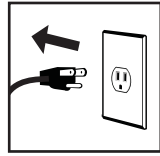

Unlock the module and open the doors.



NOTE: the cart power cord acts as the connect/disconnect device switching power off and on.

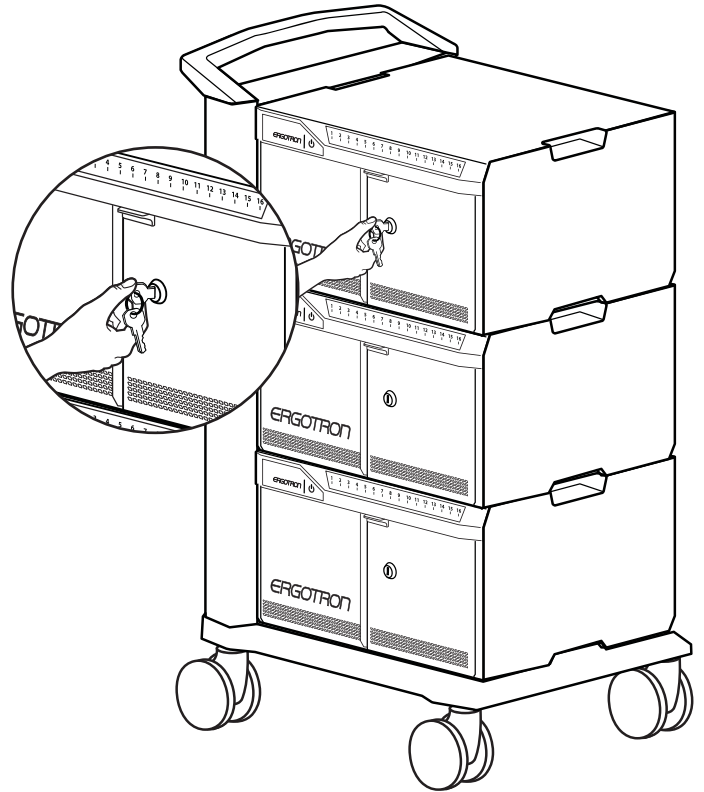

- 2 Use a Phillips screwdriver to remove the two screws located on the interior sides of the module; save screws to reinsert later.

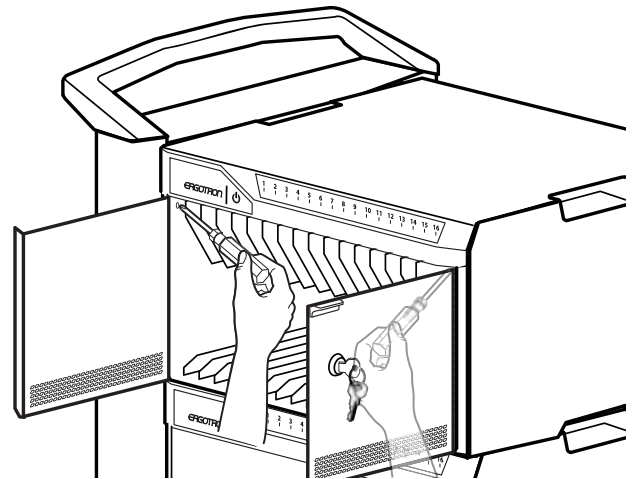

- 3 Partially slide out the module drawer. You'll need to unplug two cables before sliding the drawer completely out. Open the strap to access the two cables.



Tablet Charging Set-up

- 4** Unplug the USB and DC power cables (push up on the lever under the DC connector to release). The drawer can now be removed.

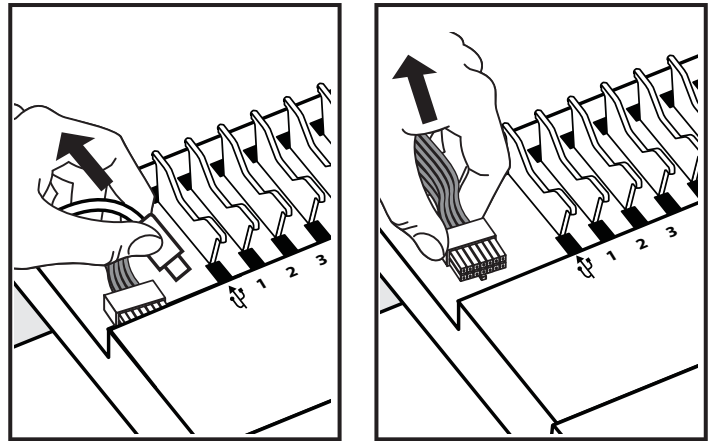

- 5** Place the drawer up-side-down on the cart top. Line up a tablet USB cable along numbers 1 to 8 on the drawer as a way to measure out slack (represented by dashed line).

Both the 30 pin and Lightning cable designs are compatible with the Tablet Management Cart. Please use the cable which is appropriate for your Apple device.

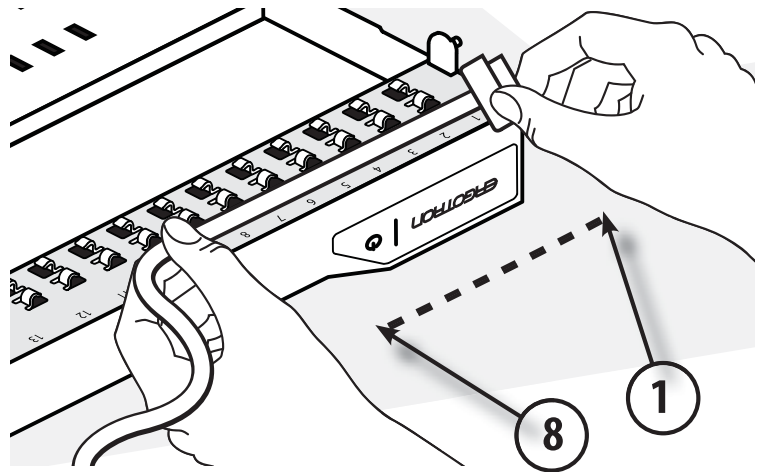

- 6** Route the tablet USB cable through the slots to the back of the drawer maintaining the slack measured in previous step.

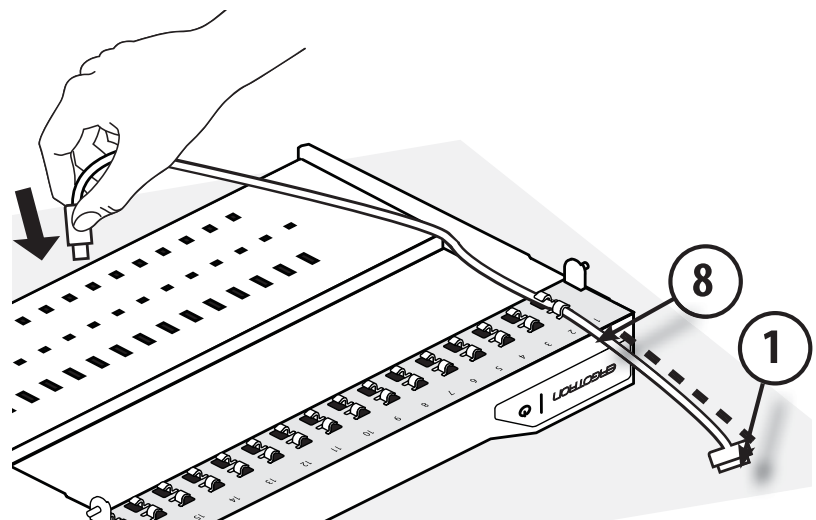

Tablet Charging Set-up

- 7** Turn over the drawer. Wrap the excess USB cable around the cable organizer.

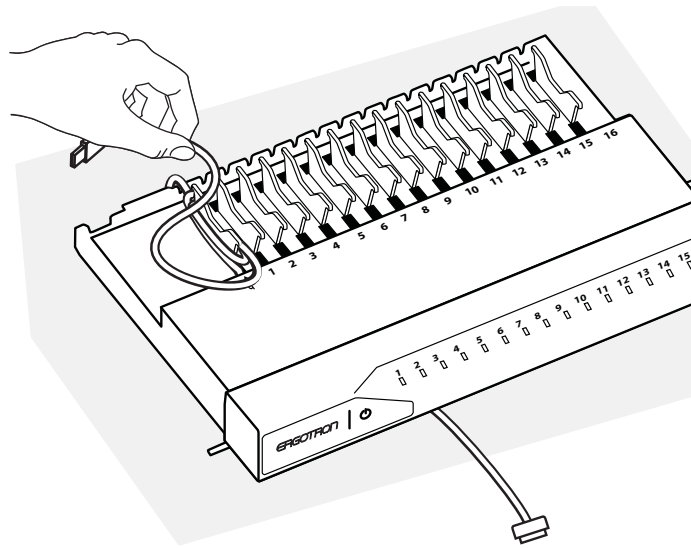

- 8** Connect the USB cable to the corresponding USB port. Repeat USB cabling steps 5 through 8 for the rest of the iPad devices going into this module.

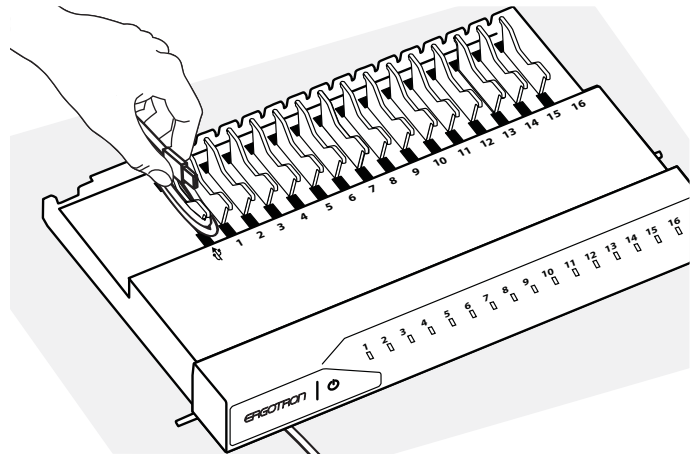

- 9** Slide the drawer partially into the module. Reconnect the USB and DC cables and wrap the straps around the cables.

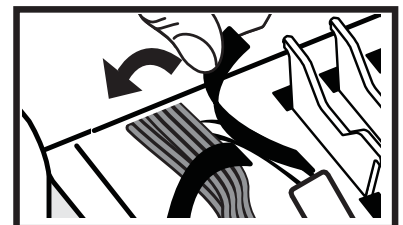
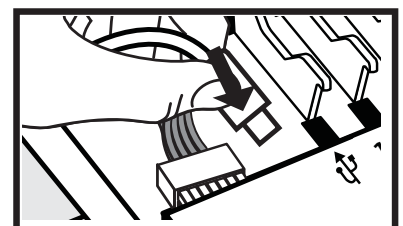
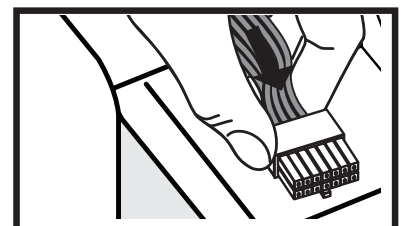
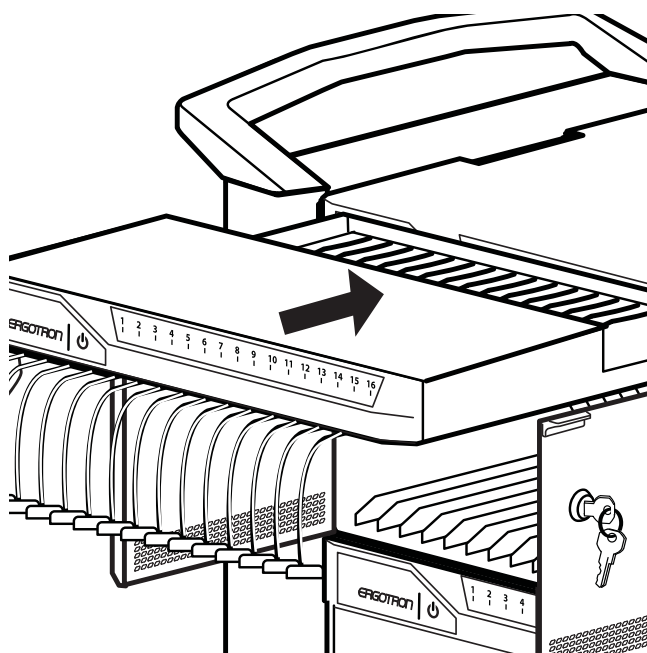

Tablet Charging Set-up

- 10** Slide the drawer completely into the module. Insert the screws removed in step 2 and tighten.

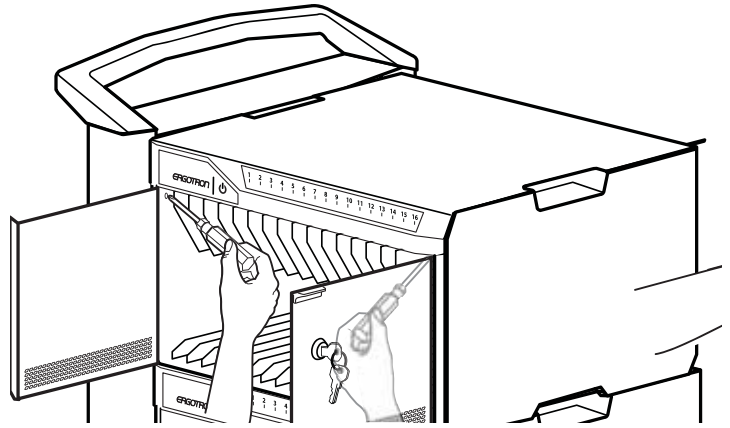

- 11** Insert iPad devices into module. Connect the tablet USB charging cables to the iPad devices. Repeat Steps 1 - 10 for the other modules.

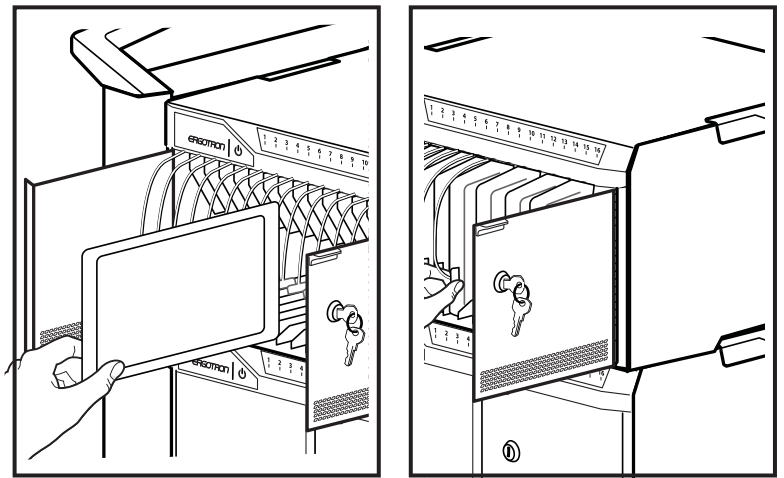

12 Tablet Charging

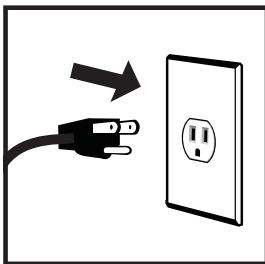

To begin charging the tablets, plug in the Cart power cord.

The power cord is used to turn the Cart power on and off. Charging occurs whenever the cart power cord is connected **UNLESS** a Macintosh® or PC notebook USB cable is connected to the cart for syncing.





Tablet Syncing instructions begin on the next page.



NOTE: the cart power cord acts as the connect/disconnect device switching power off and on.



LED - Indicators

Power Indicator – communicates sync and charge status with the following signals:

-  **Off** = **No power to the module.**
-  **On - solid** = **iPad devices are charging.**
-  **On - slow blink** = **Computer is plugged into auxillary USB outlet and iPad devices are ready to sync or are syncing.**
-  **On - fast blink** = **Fault Status. Please make sure all cables are seated correctly within cable drawer and cart is operating within specified operating temperature. Contact Ergotron Customer Support if problem continues.**

Optional Feature

Individual Status Indicators (ISI) – sequentially numbered LEDs corresponding to each tablet in the module:

-  **Green** = **Fully charged.**
-  **Amber** = **Charging in progress.**

 **NOTE:** if module is syncing all ISIs will be green.

When used with the iPad (1st generation) and iPad 2, the ISI lights will continue to stay lit showing the color green indefinitely after the unit is completely charged. When used with an iPad mini, an iPad with Retina Display (4th generation), or an iPad 3 and iOS 6.0 or later, the ISI will stay lit for approximately 15 minutes after the unit is completely charged. At this time, the iPad will turn off to conserve battery life, so the ISI will turn off also.

Syncing

 **NOTE:** complete the Tablet Charging instructions explained on the previous pages before starting the Syncing Instructions. iPad devices should be charged at least 50% before starting the syncing process.

The iPad devices will mount as USB devices when the included USB cable is connected to a host notebook via the USB port on the exterior of the module.

Apple iPad or iPod touch® devices will sync to a host notebook using iTunes®. If the Macintosh or PC notebook power is on, and the notebook is running iTunes or Apple Configurator, the devices will sync to the notebook automatically when the USB cable is connected from the notebook to the USB port on the exterior of the module.

Please see included separate instructions for specific setup of iTunes and your Apple devices.

Syncing

- 1 Place your Apple device, power adaptor and a USB cable on the cart work top.

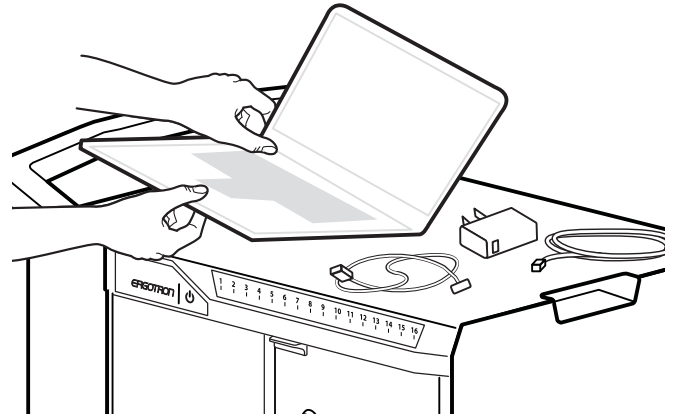

- 2 Plug the USB and power adaptor cables into the notebook; route the ends of the cables down the side of the cart, and strap the power adaptor into the recessed area to store.

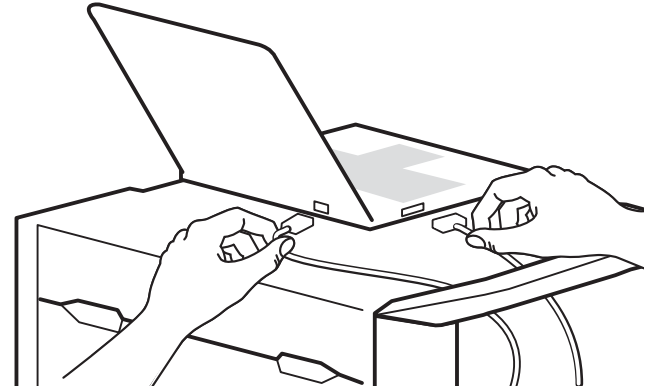

- 3 Connect the notebook USB cable to the port on the side of the cart.

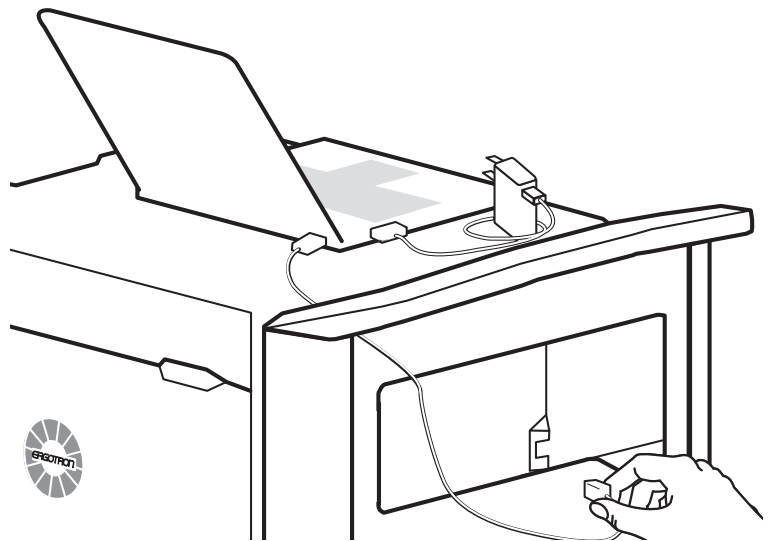

- 4 Connect the Apple device power adaptor into the auxiliary outlet on the side of the cart. Tuck the access cables into the recessed area. Switch on the notebook power to begin syncing.

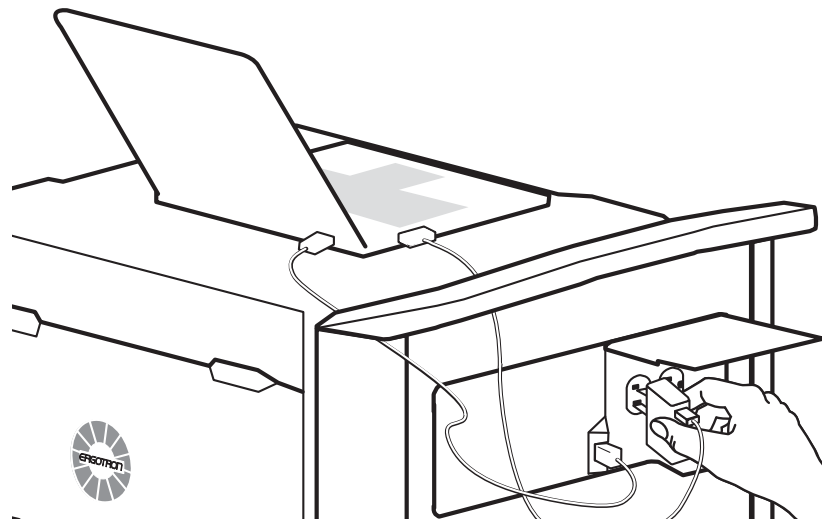

Cleaning and Maintenance

Cart and Equipment Electric Safety

There are specific risks associated with the use of equipment having power cables. You must be aware of, and avoid these risks when the Cart is located in close proximity to children.

 **WARNING:** Failure to observe the following Electrical Safety notices can result in fire or death by electric shock.

 Electrical cables can be hazardous. Misuse can result in fire or death by electrical shock.

- Double Pole / Neutral Fusing
- Inspect power cables thoroughly before each use.
- Do not use cables that are damaged.
- Insert the plug completely into the outlet.
- Grasp the plug to remove from the outlet.
- Do not unplug by pulling on the cable.
- Do not use excessive force to make connections.
- Do not plug the cable into an extension cable.
- Do not remove, bend or modify any metal prongs or pins of cable.
- Do not drive, drag or place objects over the cable.
- Do not walk on the cable.
- Avoid overheating. Uncoil the cable and do not cover it with any material.
- Do not run cable through doorways, holes in ceilings, walls or floors.

 Keep the Cart away from water.

- Do not use it when wet.
- Do not place the Cart in close proximity to flammable liquids or gases.

 This cart is intended for use only with loading as indicated. Use with loads greater than indicated may result in instability causing possible injury.

 The cart power cord acts as the connect/disconnect device switching power off and on.

 **CAUTION:** Changes or Modifications not expressly approved by Ergotron could void the user's authority to operate the equipment.

Cart Use Safety

There are specific risks associated with the use of Cart when moving or stationary (for charging or storage). You must be aware of, and avoid these risks when the Cart is located in close proximity to children.

 **WARNING:** Failure to observe the following Cart Use Safety notices may result in serious personal injury or equipment damage.

Only Adults should move this cart.

- Do not allow anyone to sit, stand, or climb on the Cart.
- Do not lift the Cart from the bottom.
- Do not block the fans and vent openings. To prevent overheating, leave at least 127 mm (5-inch) clearance around fans and vents.

The Cart is designed to be used indoors only.

- Do not use the Cart to transport or store equipment other than what has been noted in this guide.
- Do not use the Cart to store liquids or cleaning supplies.
- Do not place heavy objects on the Cart surface or shelf.
 - The maximum weight capacity of the top surface is 11.4 kg (25 lb).
 - The maximum weight capacity of the shelf is 16 kg (35.2 lb).

Moving the Cart

- Before moving the Cart:
 1. Disconnect the power cable from the wall.
 2. Make sure the cable is wrapped and secure.
 3. Close and lock the doors.
 4. Remove items from the top work surface.
 5. Unlock the casters.
- Push (do not pull) the Cart for optimum maneuverability and to prevent muscle strain.
- Do not move the Cart across rough, uneven or irregular surfaces such as gravel.

Parking the Cart

Observe these safety alerts for times when the cart is stationary:

- Do not park the Cart in areas of heavy traffic.
- Do not run cables through doorways, holes in ceilings, walls, or floors.
- Do not run cables across hallways, classrooms, or other areas where they will be walked on.
- Do not leave Cart unattended in areas where children have access.
- Keep Cart doors closed and locked whenever it is unattended or parked for charging or storage.
- Keep Cart casters locked whenever it is unattended.



Specifications

This device complies with Part 15 of the FCC Rules. Operation is subject to the following two conditions: 1) This device may not cause harmful interference. 2) This device must accept any interference received, including interference that may cause undesired operation. This Class A digital apparatus complies with Canadian ICES-003. / Cet appareil numérique de la classe A est conforme à la norme NMB-003 du Canada.

Cart dimensions

23"W x 18.4"D x 39.3"H (58.4 x 46.7 x 100 cm)

Cart weight (w/o equipment)

32 Unit Cart	100 lbs (45.4 kg)
48 Unit Cart	126.5 lbs (57.4 kg)

Rated weight capacity

Top Work Surface	25 lb (11.3 kg)
Bottom Shelf (32 Unit Carts, only)	25 lb (11.3 kg)

Maximum tablet size

Individual tablet dimensions (including cover):
up to 10.8 H x 7.7 W x 0.95 in D (27.4 x 19.6 x 2.4 cm)

Individual tablet weight:
up to 2.2 lb (1 kg)

LED status indicators (ISI) - Optional feature

Lights indicate power status and syncing activity

32 Unit Cart	32 LED lights
48 Unit Cart	48 LED lights

Cooling/ventilation

One 5-volt DC continuous operation fan in each module

External power outlet(s)

One or two outlets, depending on region

100/120 V~, 3A, 50/60 Hz or
220/230/240 V~, 1.5A, 50/60 Hz

Shipping dimensions

46.1 x 29.9 x 22.8 in (117 x 76 x 58 cm)

Shipping weight

32 Unit Cart	147 lb (67 kg)
48 Unit Cart	175.5 lb (80 kg)

Power system

100/120 V~, 9.1A, 50/60 Hz or
220/230/240 V~, 4.3A, 50/60 Hz
Depending on region and model of Cart

Tip Test/Angle: 10 degrees

Environmental

Temperature range:
Operating 0° to 30°C (32° to 86°F)
Storage -40° to 60°C (-40° to 140°F)

Relative humidity (maximum):
Operating 10%–90% (non condensing)
Storage 5%–95% (non condensing)

Altitude (maximum): 2000 m (6,562 ft)

Compatibility:

Made for
iPhone 5, iPhone 4S, iPhone 3GS, iPod touch (5th generation), iPod touch (4th generation), iPod touch (3rd generation), iPad mini, iPad with Retina Display (4th generation), iPad (3rd generation), iPad 2, iPad

Service and Warranty

**For Service on the Ergotron Tablet Managing Cart
for iPad**

Visit www.ergotron.com



NOTE: When contacting customer service, reference the serial number.

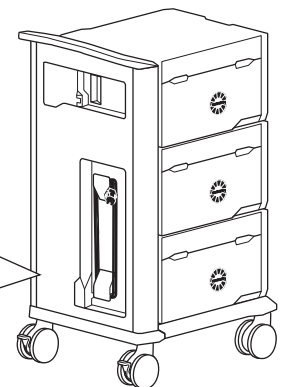



© 2013 Ergotron, Inc.
All rights reserved.

While Ergotron, Inc. makes every effort to provide accurate and complete information on the installation and use of its products, it will not be held liable for any editorial errors or omissions (including those made in the process of translation from English to another language), or for incidental, special or consequential damages of any nature resulting from furnishing this instruction and performance of equipment in connection with this instruction. Ergotron, Inc. reserves the right to make changes in the product design and/or product documentation without notification to its users. For the most current product information, or to know if this document is available in languages other than those herein, please contact Ergotron. No part of this publication may be reproduced, stored in a retrieval system, or transmitted in any form or by any means, electronic, mechanical, photocopying, recording or otherwise without the prior written consent of Ergotron, Inc., 1181 Trapp Road, Eagan, Minnesota, 55121, USA Patents Pending and Patented U.S. & Foreign. Ergotron is a registered trademark of Ergotron, Inc.

Americas Sales and Corporate Headquarters

St. Paul, MN USA
(800) 888-8458
+1-651-681-7600
www.ergotron.com
sales@ergotron.com

EMEA Sales

Amersfoort, The Netherlands
+31 33 45 45 600
www.ergotron.com
info.eu@ergotron.com

APAC Sales

Tokyo, Japan
www.ergotron.com
apaccustomerservice@ergotron.com

Worldwide OEM Sales

www.ergotron.com
info.oem@ergotron.com