

EXTECH[®]

User Manual

600 A True RMS AC/DC Clamp Meter with IR Thermometer

MODEL EX623A

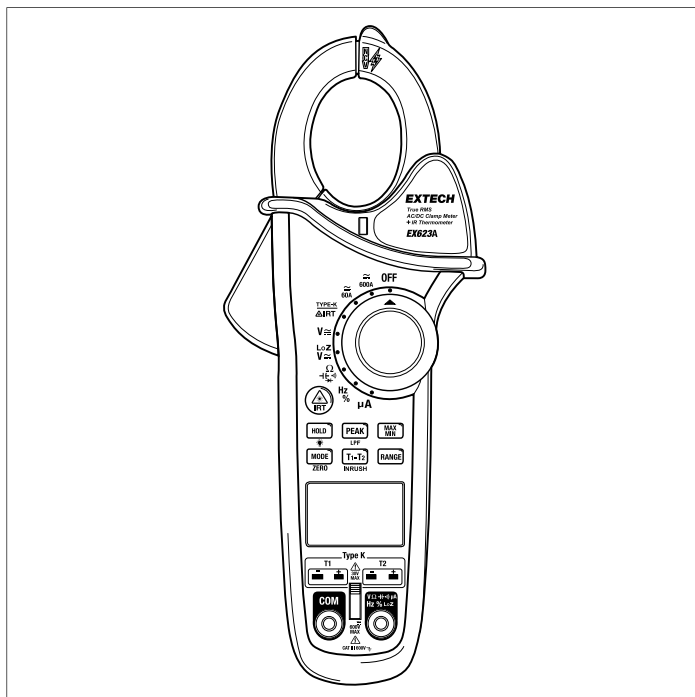

Table of contents

1	Introduction.....	1
2	Safety	2
2.1	Safety Notes.....	2
2.2	International Safety Symbols.....	2
2.3	Maximum Input Ranges	4
2.4	FCC Compliance	4
3	Product Description	5
3.1	Meter Front	5
3.2	Meter Back	6
3.3	Button Descriptions.....	6
3.4	Display Icon Descriptions	7
4	Meter Power	8
4.1	Automatic Power Off (APO).....	8
5	Operation	9
5.1	Input Shutter Switch	9
5.2	Automatic and Manual Range	10
5.3	LCD Backlight.....	10
5.4	Maximum and Minimum Readings.....	10
5.5	Data Hold	10
5.6	Non-Contact Voltage Detector	11
5.7	AC/DC Current Clamp Measurements.....	12
5.7.1	Polarity Considerations	12
5.7.2	Frequency of Current Measurements.....	13
5.7.3	Peak Max	13
5.7.4	Inrush AC Current Measurements.....	13
5.7.5	DC Current Zero	13
5.8	AC/DC Voltage Measurements	14
5.8.1	Frequency of Voltage Measurements.....	14
5.8.2	Peak Max	15
5.8.3	Low Pass Filter Function.....	15
5.9	Low Impedance Voltage Measurements (Lo Z).....	15
5.10	Resistance Measurements	16
5.11	Continuity Test	17
5.12	Diode Test.....	18
5.13	Capacitance Measurements	20
5.14	Frequency and Duty Cycle Measurements	21

Table of contents

5.15	Microampere (μ A) AC/DC Current Measurements	22
5.16	Type K Thermocouple Temperature Measurements	23
5.17	Non-Contact IR Temperature Measurements	25
	5.17.1 Distance to Spot Ratio	25
	5.17.2 IR Measurement Considerations	26
6	Maintenance	27
6.1	Cleaning and Storage	27
6.2	Battery Replacement	27
	6.2.1 Battery Safety	27
6.3	Fuse Replacement	27
7	Specifications	28
7.1	General Specifications	28
7.2	Electrical Specifications	29
7.3	Measurement Specifications	30
7.4	IR Thermometer Specifications	32
8	Customer Support	33
9	Warranty	34

1 Introduction

Congratulations on your purchase of this Extech EX623A True RMS Clamp Meter. This meter measures AC/DC Current, AC/DC Voltage, Resistance/Continuity, Capacitance, Diode, Frequency, Duty Cycle, and Temperature.

Special features include two thermocouple inputs, a non-contact IR temperature detector, and a non-contact voltage detector.



The double moulded case is designed for heavy duty use. This meter is shipped fully tested and calibrated and, with proper use, will provide years of reliable service.

2 Safety

2.1 Safety Notes

- Do not exceed the maximum input range for any function (see table in Section 2.3).
- Do not apply voltage to the meter when the resistance, capacitance, or diode functions are selected.
- Set the function switch OFF when the meter is not in use.

2.2 International Safety Symbols

	This symbol, adjacent to another symbol or terminal, indicates that the user must refer to the manual for further information.
	This symbol, adjacent to a terminal, indicates that, under normal use, hazardous voltages may be present
	Double insulation.
WARNING	Warnings indicate a potentially hazardous situation, which if not avoided, could result in death or serious injury.
CAUTION	Cautions indicate a potentially hazardous situation, which if not avoided, may result in damage to the product.

	WARNING
<ul style="list-style-type: none">• Improper use of this meter can cause damage, shock, injury or death. Read and understand this user manual before operating the meter.• Set the function switch to the appropriate position before measuring.• When measuring voltage do not switch to the current or resistance modes.• Do not measure current on a circuit whose voltage exceeds 600 V.• When changing ranges, always disconnect the test leads from the circuit under test.• Voltage checks on electrical outlets can be difficult and misleading because of the uncertainty of connection to the recessed electrical contacts. Other means should be used to ensure that the terminals are not 'live'.• Do not place or use the device in strong direct sunlight for extended periods.	

**CAUTION**

- For indoor use only.
- Always remove the test leads before replacing the battery or fuses.
- Inspect the condition of the test leads and the meter itself for any damage before operating the meter. Repair or replace any damage before use.
- Use great care when making measurements if the voltages are greater than 35 V DC or 25 V AC RMS. These voltages are considered a shock hazard.
- Always discharge capacitors and remove power from the device under test before performing Diode, Resistance or Continuity tests.
- If the equipment is used in a manner not specified by the manufacturer, the protection provided by the equipment may be impaired.
- Do not allow children to play with this meter or any of the materials that accompany it, including the packaging.
- Remove the batteries when storing the meter for > 60 days.
- Expired or damaged batteries can cause cauterization on contact with the skin. Always use suitable hand protection when handling such batteries.
- Do not short circuit the battery and do not dispose of the battery in a fire.
- **Do not directly view or direct the laser pointer at an eye.** Low power visible lasers do not normally present a hazard, but may present some potential for hazard if viewed directly for extended periods of time.
- Use of controls or adjustments or performance of procedures other than those specified herein may result in hazardous radiation exposure.



LASER RADIATION - DO NOT STARE INTO BEAM
RAYONNEMENT LASER NE REGARDEZ PAS LE FAISCEAU
CLASS 2 CONSUMER LASER PRODUCT

WAVELENGTH: 650nm MAX OUTPUT POWER < 1mW

IEC 60825-1:2014

COMPLIES WITH 21 CFR 1040.10

AND 1040.11 EXCEPT FOR

CONFORMANCE WITH IEC 60825-1

ED. 3 AS DESCRIBED IN LASER

NOTICE NO. 56, DATED MAY 8, 2019,

EN 60825-1:2014/A11:2021, EN 50689:2021

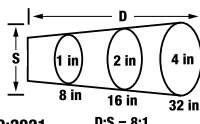

Laser light beam divergence

< 12 mm (0.5 in.) typical spot diameter at a distance of 32.8 ft. (10 m)

2.3 Maximum Input Ranges

Function	Maximum Input
AC/DC Current (A)	600 A AC/DC
AC/DC Current (μ A)	6000 μ A AC/DC
AC/DC Voltage and LoZ Voltage	600 V AC/DC
Resistance, Capacitance, Frequency, Diode	250 V AC/DC
Type K Temperature	30 V DC, 24 V AC

2.4 FCC Compliance

This equipment has been tested and found to comply with the limits for a Class B digital device, pursuant to part 15 of the FCC Rules. These limits are designed to provide reasonable protection against harmful interference in a residential installation. This equipment generates, uses, and can radiate radio frequency energy and, if not installed and used in accordance with the instructions, may cause harmful interference to radio communications. However, there is no guarantee that interference will not occur in a particular installation. If this equipment does cause harmful interference to radio or television reception, which can be determined by turning the equipment off and on, the user is encouraged to try to correct the interference by one or more of the following measures:

1. Reorient or relocate the receiving antenna.
2. Increase the separation between the equipment and receiver.
3. Connect the equipment into an outlet on a circuit different from that to which the receiver is connected.
4. Consult the dealer or an experienced radio/TV technician for help.

	WARNING
Changes or modifications not expressly approved by the party responsible for compliance could void the user's authority to operate the equipment.	

3 Product Description

3.1 Meter Front

Refer to Figure 3.1 below for these numbered items.

1. Non-contact voltage (NCV) detector
2. Current clamp
3. NCV LED indicator
4. Clamp opening trigger
5. Function switch
6. Control buttons (Section 3.1)
7. Backlit LCD (Section 3.4)
8. Thermocouple input jacks
9. Negative test lead jack
10. Positive test lead jack
11. Input shutter switch

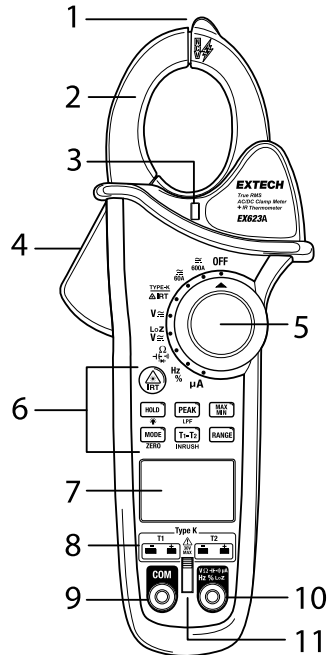

Figure 3.1 Meter Front.

3.2 Meter Back

1. Laser pointer lens
2. IR temperature lens
3. Battery and fuse compartment
4. Compartment screw

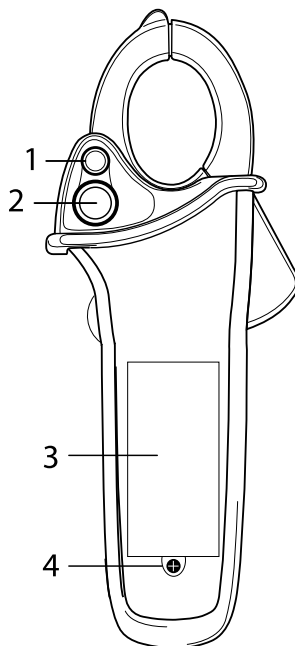











Figure 3.2 Meter Back.

3.3 Button Descriptions

	Press and hold to display the temperature of the targeted spot. Use the Laser pointer for targeting. Release the button to exit.
	Data Hold Mode. Short press to freeze/unfreeze the display reading. Long press to switch the LCD backlight on or off.
	Peak Mode: Short press to show/hide the measured current's signal peak. Low Pass Filter (LPF): Long press to engage or remove the low pass filter, for AC voltage measurements.
	Maximum and Minimum Readings: Short press to view MAX signal, short press again to show MIN signal. Press again to exit the mode.

	<p>Short press to select an alternate mode for the function in use. For example, use MODE to select AC or DC when measuring voltage or current.</p> <p>Long press to activate the DC current zero function.</p>
	<p>Temperature Display Mode: With a thermocouple connected to one or both inputs, choose the display configuration. Show T1, T2, or T1 minus T2 temperature.</p> <p>Long press, when measuring AC current, to engage (or exit) the inrush capture mode.</p>
	<p>Short press this button to switch to the manual range, and use it to step through the available ranges. Long press to return to the Auto range mode.</p>

3.4 Display Icon Descriptions

HOLD	Data Hold	F	Farads (Capacitance)
	Auto Power OFF (APO)	Hz	Hertz (Frequency)
AUTO	Automatic Range	%	Duty Cycle ratio
	Peak Hold	°C / °F	Temperature units
DC	Direct Current	T1, T2, T1-T2	Thermocouple display modes
AC	Alternating Current	n, m, μ, M, k	Unit of measure prefixes
MAX	Maximum reading		Continuity test
MIN	Minimum reading		Diode test
	Low battery		Laser pointer
ZERO	DC A Zero	LPF	Low pass filter
mV / V	Millivolts and Volts	Lo Z	Low impedance mode
Ω	Ohms (Resistance)	INRUSH	Inrush Current mode
A	Amperes (Current)		

4 Meter Power

The meter is powered by one (1) 9 V battery. The battery compartment is located on the back of the meter.

When the battery power is critically low, the battery icon  appears. Replace the battery when this icon appears. See the Maintenance section for battery replacement instructions.

4.1 Automatic Power Off (APO)

To conserve battery life, the meter automatically switches off after approximately 15 minutes. To turn the meter on again, turn the function switch to the OFF position and then to the desired function position.

To disable the APO, follow the steps below.

1. From the OFF position, hold the MODE button and rotate the FUNCTION switch to a measurement function.
2. The meter will beep four times, release the MODE button.
3. APO is now disabled (APO icon  switches off).
4. When the function switch is turned to the OFF position, APO is again enabled (default).

5 Operation

NOTE

Read and understand all Warning and Caution statements in this user manual prior to use. Set the function switch to the OFF position when the meter is not in use.

5.1 Input Shutter Switch

	CAUTION
The input shutter is an important safety feature. If it is damaged or inoperable, do not use the meter. Contact FLIR for servicing.	

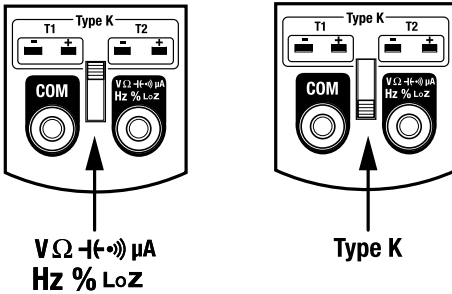

Figure 5.1 Input Shutter. Put the switch in the lower position when measuring thermocouple temperature. Put the switch in the upper position for all test lead measurements.

The input shutter is located between the two test lead jacks on the front of the meter (item 11, in Figure 3.1). Its purpose is to prevent the user from simultaneously connecting thermocouples and test leads to the meter.

When the input shutter is in the DOWN position, the test lead jacks are shuttered, prohibiting test lead insertion. Put the shutter in the down position when connecting thermocouples to the meter.

When the input shutter is in the UP position, the thermocouple input jacks are shuttered, prohibiting thermocouple insertion. Put the shutter in the up position when connecting test leads to the meter.

5.2 Automatic and Manual Range

In the voltage, resistance, capacitance, frequency, and μA current functions, the meter automatically selects the optimum range. To use manual range mode, follow the steps below.

1. Press the **RANGE** button. The **AUTO** display icon will switch off.
2. Now use the **RANGE** button to step through the available ranges.
3. To return to the automatic mode, long press the **RANGE** key for 2 seconds. The **AUTO** icon will reappear.

5.3 LCD Backlight

The LCD is equipped with backlighting for easier viewing, especially in dimly lit areas. Long press the backlight button for 2 seconds to switch the backlight on or off. The backlight automatically switches off after 3 minutes.

5.4 Maximum and Minimum Readings

1. Press the **MAX/MIN** button. The **MAX** display icon will appear, and the meter will display the highest reading. The display will only update when a higher reading is measured.
2. Press the **MAX/MIN** button again. The **MIN** display icon will appear, and the meter will display the lowest reading. The display will only update when a lower reading is measured.
3. To exit the mode, long press the **MAX/MIN** button for 2 seconds.

5.5 Data Hold

To freeze the displayed reading, press the **HOLD** button, the **HOLD** icon will appear. Press the **HOLD** button to return to normal operation.

5.6 Non-Contact Voltage Detector



WARNING

Risk of Electrocution. Before use, always test the voltage detector on a known live circuit to verify proper operation.

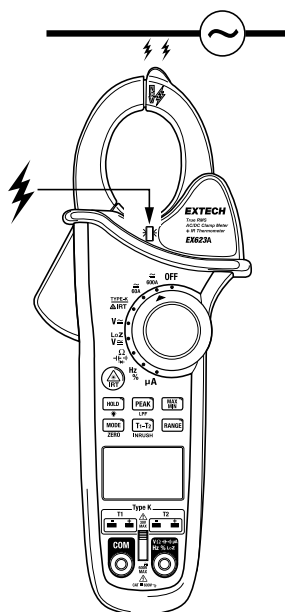

Figure 5.2 Non-Contact Voltage measurements.

1. Remove the test leads from the meter.
2. Rotate the function switch to any measurement position.
3. Place the clamp tip near, or on, the conductor under test.
4. If AC voltage is present, the red NCV detector LED will switch on. The detectable voltage range is 100 to 600 V AC.

NOTE

Conductors in electrical cord sets are often twisted. For best results, move the probe tip along a length of the cord to assure placing the tip in close proximity to the live conductor.

The detector is designed with high sensitivity. Static electricity, or other sources of energy, may randomly trip the sensor; this is normal operation.

5.7 AC/DC Current Clamp Measurements

	WARNING
Disconnect the test leads before making clamp measurements.	

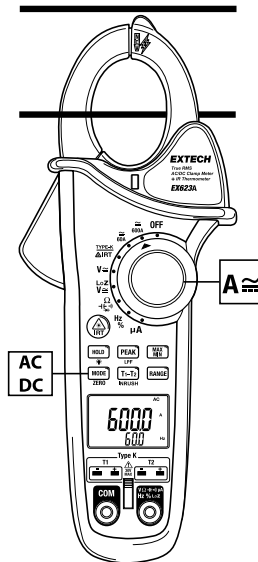

Figure 5.3 Current Clamp measurements. Clamp only one conductor, as shown.

1. Rotate the function switch to the **600 A** position.
2. Press the **MODE** button to select AC or DC.
3. Press the trigger to open jaw. Fully enclose only **one** conductor as shown in Figure 5.3.
4. Read the current value in the display.
5. If the value is less than 60 A, rotate the function switch to the **60 A** position to improve resolution.

5.7.1 Polarity Considerations

When measuring from front to back on the EX623A, a minus (-) sign will precede the displayed reading. When measuring from back to front, a positive (+) sign will precede the displayed reading.

5.7.2 Frequency of Current Measurements

When measuring AC current, the measured frequency is shown on the lower area of the display.

5.7.3 Peak Max

When measuring AC current, press the **PEAK** button to activate the peak capture circuit. The display icon **MAX** will appear at the top of the LCD. The meter will now display the measured signal's peak. Press the **PEAK** button again to exit this mode.

5.7.4 Inrush AC Current Measurements

When measuring AC current you can capture inrush current. Follow the steps above to set up a test, and continue with the steps below.

1. Long press the **INRUSH** button for 2 seconds to activate the inrush current feature. **INRUSH** will appear on the display.
2. Switch on the circuit under test and view the inrush current reading on the display.
3. To exit the inrush mode, long press the **INRUSH** button for 2 seconds.

5.7.5 DC Current Zero

The Zero feature removes offset values and improves accuracy for DC current measurements. To perform a zero, select the DC current mode and, with no conductor in the jaw, long press the **ZERO** button until the beeper sounds. The display will zero. The offset value is now stored and removed from subsequent measurements.

5.8 AC/DC Voltage Measurements



CAUTION

Do not measure voltage if a motor on the circuit is being switched on or off. Large voltage surges may occur that can damage the meter.

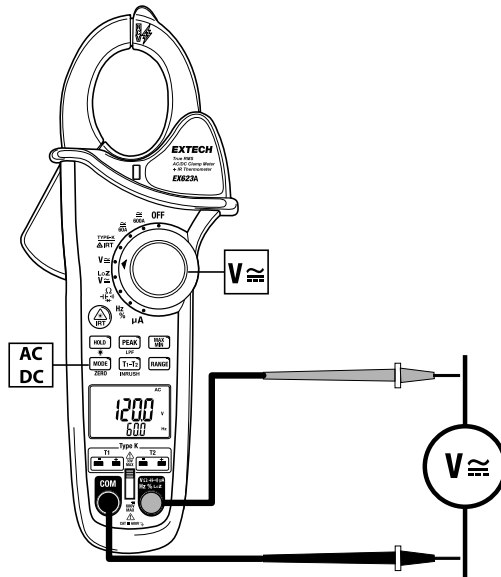

Figure 5.4 AC/DC Voltage measurement test setup.

1. Slide the input shutter switch to the up position.
2. Rotate the function switch to the **V** position.
3. Press the **MODE** button to select AC or DC Voltage.
4. Insert the black test lead plug into the negative **COM** jack. Insert the red test lead plug into the positive **V** jack.
5. Touch the black test probe tip to the negative side of the circuit. Touch the red test probe tip to the positive side of the circuit.
6. Read the voltage value in the display.

5.8.1 Frequency of Voltage Measurements

When measuring AC Voltage, the measured frequency is shown on the lower area of the display.

5.8.2 Peak Max

When measuring AC voltage, press the **PEAK** button to activate the peak capture circuit. The **P-MAX** display icon will appear at the top of the LCD. The meter will now display the measured signal's peak. Press the **PEAK** button again to exit this mode.

5.8.3 Low Pass Filter Function

When measuring AC voltage you can introduce a low pass filter into the measurement circuit. This allows you to safely measure voltage on variable frequency drives (VFD), and other such devices. Follow the steps above to set up a test, and continue with the steps below.

1. When measuring AC voltage, long press the **LPF** button for 2 seconds to activate the low pass filter. **LPF** will appear on the display.
2. The low pass filter is now active, read the voltage on the display.
3. Long press the **LPF** button for 2 seconds to exit.

5.9 Low Impedance Voltage Measurements (Lo Z)



CAUTION

Do not measure voltage if a motor on the circuit is being switched on or off. Large voltage surges may occur that can damage the meter.

The low impedance mode is useful in applications where 'ghost' voltages are a concern.

1. Set the function switch to the **Lo Z** position.
2. Insert the black test lead plug into the negative **COM** jack. Insert the red test lead plug into the positive **V** jack.
3. Touch the black test probe tip to the negative side of the circuit. Touch the red test probe tip to the positive side of the circuit.
4. Read the voltage in the display.

5.10 Resistance Measurements

	CAUTION
Remove power from the device under test before making resistance measurements.	

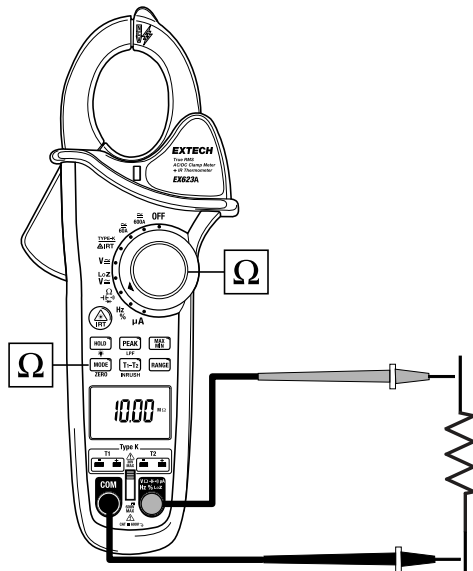



Figure 5.5 Resistance measurement test setup.

1. Slide the input shutter to the up position.
2. Set the function switch to the Ω position.
3. If the resistance mode is not selected, use the **MODE** button to select it.
4. Insert the black test lead plug into the negative **COM** jack. Insert the red test lead plug into the positive Ω jack.
5. Touch the black test probe tip to one side of the device. Touch the red test probe tip to the other side of the device.
6. Read the resistance value in the display.

5.11 Continuity Test

	CAUTION
Remove power from the device under test before making continuity measurements.	

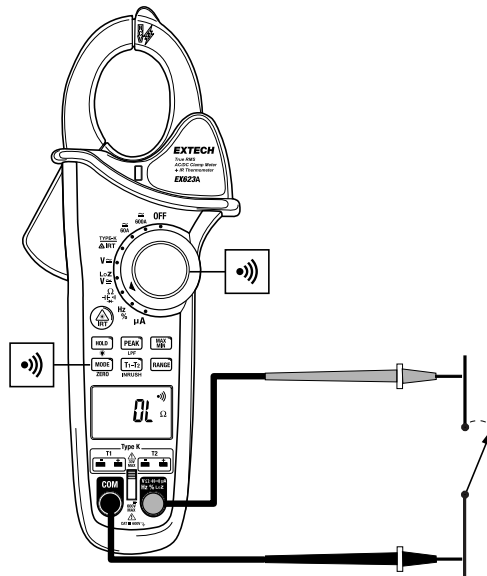



Figure 5.6 Continuity test setup. In the figure, the circuit is open, so the display shows OL. If the switch is closed, the circuit would be shorted and the meter's audible beeper would sound.

1. Slide the input shutter to the up position.
2. Set the function switch to the  position.
3. Press the **MODE** button to select the continuity mode.
4. Touch the test probe tips across the circuit or component under test.
5. View the resistance measurement on the display.
6. If the resistance is $< 50 \Omega$, a steady tone will sound. **OL** will display if the circuit is open or the measurement is out of range.

5.12 Diode Test



CAUTION

Remove power from the device under test before making diode measurements.

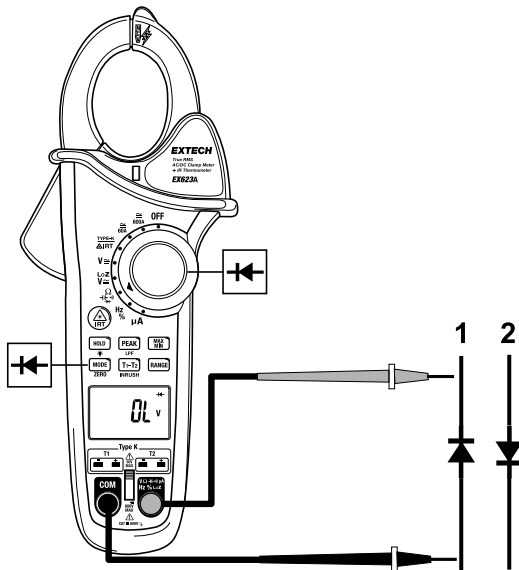

Figure 5.7 Diode test setup. Take a measurement in both positions (1 and 2) as shown in the figure. Follow the instruction in this section to interpret the test results.

1. Slide the input shutter to the up position.
2. Set the function switch to the \rightarrow position.
3. Press the **MODE** button to select the diode test mode.
4. Touch the test probe tips across the diode or semiconductor junction under test. Note the meter reading.
5. Reverse polarity by reversing the red and black lead tips. Note this reading.

6. The diode or junction can be evaluated as follows.

If one reading is 0.400 V to 0.800 V, and the other reading is **OL**, then the diode is good.

If both readings are **OL** the device is bad (open).

If both readings are very low or zero, the device is bad (shorted).

5.13 Capacitance Measurements

	WARNING
To avoid electric shock, discharge the capacitor before measuring.	

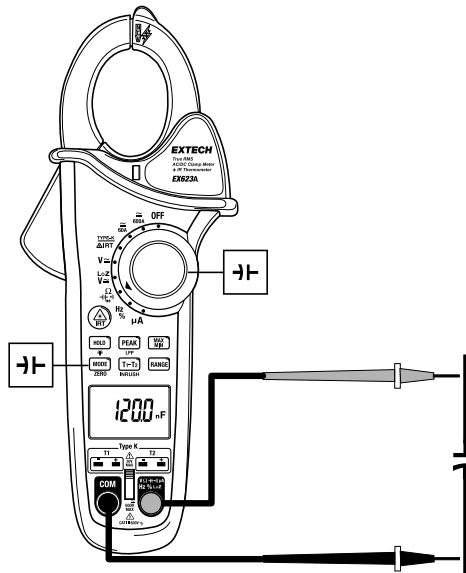



Figure 5.8 Capacitance test setup.

1. Slide the input shutter to the up position.
2. Rotate the function switch to the capacitance position ||- .
3. Use the MODE button to select the capacitance function.
4. Insert the black test lead plug into the negative **COM** jack.
5. Insert the red test lead plug into the positive jack.
6. Touch the black test probe tip to one side of the device. Touch the red test probe tip to the other side of the device.
7. Read the capacitance value in the display.

	CAUTION
For large capacitors, allow sufficient time for readings to stabilize.	

5.14 Frequency and Duty Cycle Measurements

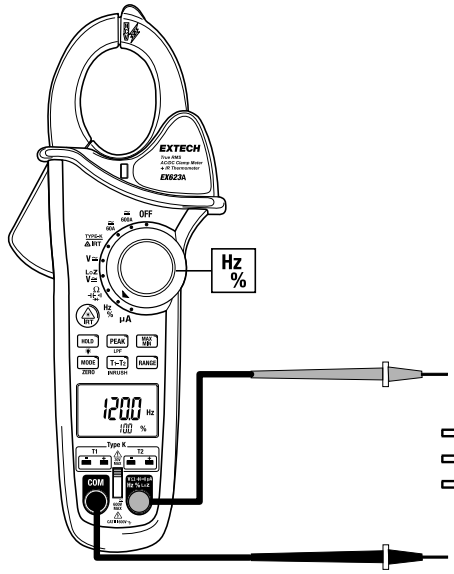

Figure 5.9 Frequency and Duty Cycle measurement setup.

1. Slide the input shutter to the up position.
2. Rotate the function switch to the **Hz %** position.
3. Insert the black test lead plug into the negative **COM** jack. Insert the red test lead plug into the positive **Hz** jack.
4. Touch the black test probe tip to one side of the device. Touch the red test probe tip to the other side of the device.
5. Read the frequency value on the upper, large display. Read the duty cycle on the lower, small display.
6. Press the **MODE** button to show the duty cycle on the larger display.

5.15 Microampere (μA) AC/DC Current Measurements

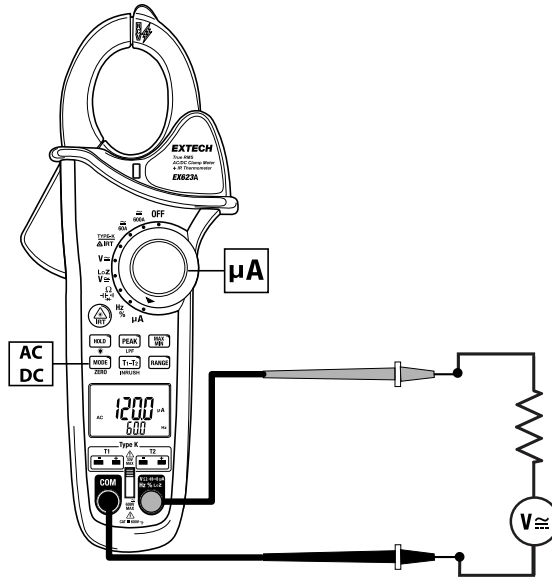

Figure 5.10 Microampere measurement test setup.

1. Slide the input shutter to the upper position.
2. Rotate the function switch to the μA position.
3. Press the **MODE** button to select AC or DC.
4. Insert the black test lead plug into the negative **COM** jack. Insert the red test lead plug into the positive μA jack.
5. Turn power off, to the circuit under test, and make a break in the circuit.
6. Insert the meter in series with the circuit by touching the black test probe tip to the negative side of the break, and the red test probe tip to the positive side of the break.
7. Switch circuit power on.
8. Read the current value in the display. For AC measurements, the frequency (Hz) will be shown on the lower display digits.

5.16 Type K Thermocouple Temperature Measurements



CAUTION

The supplied thermocouple is rated for 482°F (250°C) maximum. If a higher temperature range is needed, acquire a suitably rated thermocouple. If a higher temperature is measured with the supplied probe, damage to the thermocouple and meter is possible.

For an open input, the meter will display dashes (— — —).

For temperature over-range, the meter will display **OL**.

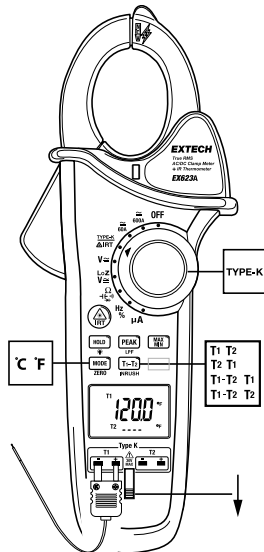



Figure 5.11 Thermocouple temperature test setup.

1. Slide the input shutter down to the lower position.
2. Rotate the function switch to the **TYPE k** position.
3. Press the **MODE** button to select °F or °C.
4. Insert the temperature probe(s) into the **T1** and/or **T2** Type K connectors.
5. Touch the temperature probe tip to the surface under test.
6. Read the temperature measurement on the display.
7. Press the **T1-T2** button to step through the four display modes, as described in the table below.

	Upper Display	Lower Display
Mode 1	T1	T2
Mode 2	T2	T1
Mode 3	T1 minus T2	T1
Mode 4	T1 minus T2	T2

5.17 Non-Contact IR Temperature Measurements

	CAUTION
<p>Do not directly view or point the laser at an eye. Low power visible lasers do not normally present a hazard, but may present some potential for hazard if viewed directly for extended periods of time.</p>	

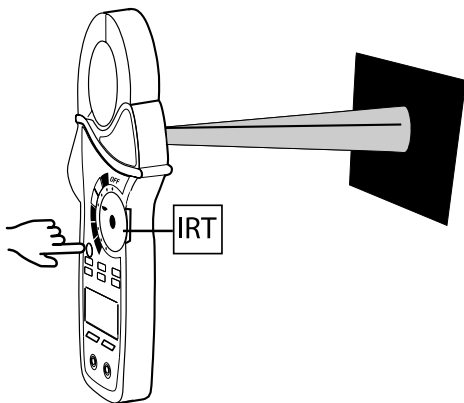

Figure 5.12 IR Temperature measurements. Press the IRT button to activate the thermometer and laser pointer. Release the button to switch off.

1. Rotate the function switch to the **IRT** position.
2. Press and hold the **IRT** button and aim the laser pointer toward the surface to be measured.
3. With the **IRT** button still depressed, long press the **MODE** button to toggle °F and °C temperature units.
4. Read the temperature measurement in the display.
5. The area of the surface to be measured must be larger than the measurement spot size (to avoid measuring surrounding surfaces). The measurement spot size depends on the distance the meter is from the target. See the Distance to Spot ratio section, next, for more information.

5.17.1 Distance to Spot Ratio

The meter has an 8:1 distance to spot ratio. For example, at a distance of 8 in. from the spot, the spot size is 1 in. The size of the measurement spot changes as the meter's distance from the spot changes, as shown in Figure 5.13, below.

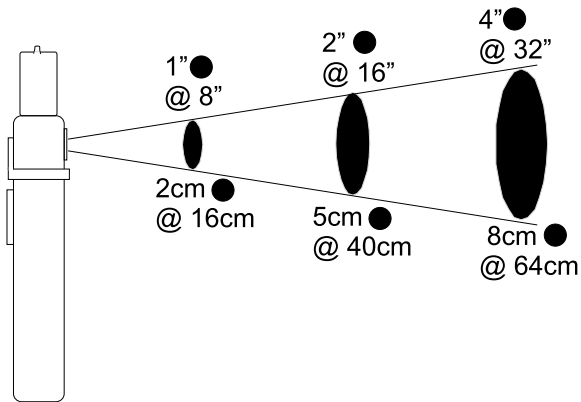

Figure 5.13 Distance to Spot Ratio 8:1.

5.17.2 IR Measurement Considerations

- If the surface of the object under test is covered with frost, oil, grime, etc., clean the area before taking measurements.
- If an object's surface is highly reflective, apply masking tape or flat black paint to the surface before measuring.
- Accurate measurements are difficult to make on transparent surfaces, such as glass.
- Steam, dust, smoke, etc. can obscure measurements.
- To find a hot spot, aim the meter outside the area of interest then scan across (in an up and down motion) until the hot spot is located.

6 Maintenance



CAUTION

To avoid electrical shock, disconnect the meter from the circuit under test, remove the test leads from the input terminals, and turn the function switch to the OFF position, before opening the case. Do not operate the meter with an open case.

6.1 Cleaning and Storage

Periodically wipe the case with a damp cloth and mild detergent; do not use abrasives or solvents. If the meter is not to be used for 60 days or more, remove the battery and store it separately.

6.2 Battery Replacement

1. Remove the Phillips head screw that secures the rear battery door.
2. Replace the 9 V battery.
3. Secure the battery compartment before use.

6.2.1 Battery Safety

- Please dispose of batteries responsibly; observe local, state, and national regulations.
- Never dispose of batteries in a fire; batteries may explode or leak.

6.3 Fuse Replacement

1. Remove the Phillips head screw that secures the rear battery door.
2. Remove the battery.
3. Remove the two (2) Phillips head screws that secure the fuse compartment.
4. Replace the fuse with one of equal rating: 200 mA, 600 V ceramic fast blow, 5 x 20 mm (ASTM HV510 H).
5. Secure the fuse compartment door, install the battery, and secure the battery compartment.

7 Specifications

7.1 General Specifications

Display	6000 count (3–5/6 digits) backlit LCD
Clamp jaw opening	1.25 in. 932 mm) approximately
Over-range indication	OL display
Battery power	One (1) 9 V battery (NEDA 1604)
Low battery indication	Battery symbol  is displayed
Auto Power Off (APO)	After approximately 15 minutes of inactivity
Operating temperature	32 to 122°F (0 to 50°C)
Operating humidity	Max 80% RH up to 87°F (31°C) decreasing linearly to 50% at 104°F (40°C)
Storage temperature	-4° to 140°F (-20 to 60°C)
Storage humidity	< 80% RH
Operating altitude	7000 ft. (2000 m) maximum
Dimensions	9.5 x 3.8 x 1.75 in. (241 x 96 x 44.5 mm)
Weight	11.1 oz. (315 g)
Safety	Meter: Over-voltage Category III 600 V, Pollution Degree 2 Test leads: Over-voltage Category IV 600 V, Category III 1000 V
Agency approvals	ETL, CE, UKCA

7.2 Electrical Specifications

Measurement rate	3 readings per second, nominal
Input impedance	10 M Ω (Voltage AC/DC)
AC bandwidth	50 to 1000 Hz (AC voltage); 50/60 Hz (AC current)
AC response	True RMS (AC voltage and current)
Crest Factor 50/60 Hz	3.0 in 60 A and 600 A ranges 1.4 in 1000 A range Specified for 5% to 100% of range
Supplied Thermocouple	Type K; rated 482°F (250°C) maximum
Non-Contact Voltage (NCV) response	100 to 600 V AC
Peak detector	> 1 ms
Fuse	200 mA, 600 V ceramic fast blow, 5 x 20 mm

7.3 Measurement Specifications

Function	Range	Resolution	Accuracy (% of reading + digits)
AC Current 50/60 Hz True RMS	40.00 A	0.01 A	±(1.5% + 5 digits)
	40.01 to 60.00 A		±(2.8% + 5 digits)
	400.0 A	0.1 A	±(1.5% + 5 digits)
	400.1 to 600.0 A		±(2.8% + 5 digits)
DC Current	40.00 A	0.01 A	±(1.5% + 5 digits)
	40.01 to 60.00 A		±(2.8% + 5 digits)
	400.0 A	0.1 A	±(1.5% + 5 digits)
	400.1 to 600.0 A		±(2.8% + 5 digits)
AC/DC µA Current	600.0 µA	0.1 µA	DC: ±(1.0% + 2 digits)
	6000 µA	1 µA	AC: ±(1.5% + 2 digits)
AC Voltage 50/60 Hz True RMS	600.0 mV	0.1 mV	±(1.0% + 20 digits)
	6.000 V	0.001 V	
	60.00 V	0.01 V	
	600.0 V	0.1 V	
DC Voltage	600.0 mV	0.1 mV	±(0.8% + 2 digits)
	6.000 V	0.001 V	±(1.5% + 5 digits)
	60.00 V	0.01 V	
	600.0 V	0.1 V	±(2.0% + 2 digits)
Lo Z AC/DC Voltage	6.000 V	0.001 V	±(3.0% + 30 digits)
	60.00 V	0.01 V	
	600.0 V	0.1 V	
	Input impedance varies from 2.5 to 3.5 kΩ in Lo Z mode.		
Resistance	600.0 Ω	0.1 Ω	±(1.0% + 4 digits)
	6.000 kΩ	0.001 kΩ	±(1.5% + 2 digits)
	60.00kΩ	0.01 kΩ	
	600.0 kΩ	0.1 kΩ	
	6.000 MΩ	0.001 MΩ	±(2.5% + 3 digits)
	60.00 MΩ	0.01MΩ	±(5.5% + 5 digits)

Continuity	Threshold 50 Ω (test current: < 0.9 mA)		
Diode	Test current: 1.5 mA, typical; Open circuit voltage: 3.2 V DC, typical		
Capacitance	6.000 nF	0.001 nF	$\pm(5.0\% + 30 \text{ digits})$
	60.00 nF	0.001 nF	$\pm(5.0\% + 20 \text{ digits})$
	600.0 nF	0.1 nF	$\pm(3.0\% + 5 \text{ digits})$
	6.000 μF	0.001 μF	
	60.00 μF	0.01 μF	
	600.0 μF	0.1 μF	$\pm(4.0\% + 10 \text{ digits})$
	6.000 mF	0.001 mF	$\pm(10.0\% + 10 \text{ digits})$
	40.00 mF	0.01 mF	
Frequency (Clamp)	400.0 Hz	0.1 Hz	$\pm(1.0\% + 3 \text{ digits})$
	Sensitivity: 5 A RMS minimum		
Frequency (Test leads)	9.999 Hz	0.001 Hz	$\pm(0.1\% + 4 \text{ digits})$
	99.99 Hz	0.01 Hz	
	999.9 Hz	0.1 Hz	
	9.999 kHz	0.001 kHz	
	99.99 kHz	0.01 kHz	
	Sensitivity: 5 to 5 kHz; 0.8 V RMS min.; 5 kHz to 150 kHz; 5 V RMS min.		
Duty Cycle	0.5% to 99.0%	0.1%	$\pm(1.2\% + 2 \text{ digits})$
	Pulse width: 100 μs to 100 ms, Frequency: 5 Hz to 150 kHz		
Temperature (Type K)	-58 to 1832°F (-50 to 1000°C)	0.1° < 1000° 1° > 1000°	$\pm(3.0\% + 9^\circ\text{F} (5^\circ\text{C}))$
	The supplied thermocouple is rated for 482°F (250°C) maximum. If a higher temperature range is needed, acquire a suitably rated thermocouple. If a higher temperature is measured with the supplied probe, damage to the thermocouple and meter is possible.		
	Specification does not include probe accuracy		
Temperature (IR)	-58 to -4°F (-50 to -20°C)	0.1°	$\pm 9^\circ\text{F} (5^\circ\text{C})$
	-4 to 518°F (-20 to 270°C)		$\pm 2\%$ of reading or $\pm 3^\circ\text{F} (2^\circ\text{C})$ whichever is greater

7.4 IR Thermometer Specifications

IR Spectral Response	6 to 16 μm
IR Emissivity	0.95 (fixed)
IR Distance to Spot ratio	8:1
Laser pointer	Class 2 laser < 1 mW power; Wavelength: 630 to 670 nm

8 Customer Support

Customer Support Local Telephone List:

<https://support.flir.com/contact>

Returns (RMA):

<https://customer.flir.com/Home>

9 Warranty

Teledyne FLIR warrants this Extech brand instrument to be free of defects in parts and workmanship for two years from date of shipment. To view the full warranty text, please visit the support site, link below.

<https://www.flir.com/support-center/warranty/>

Manufacturer Address:

Teledyne FLIR Commercial Systems, Inc.

10F, No. 57, Zhouzi Street, NeiHu District

Taipei City, 114676, Taiwan

Website

<http://www.flir.com>

Customer support

<http://support.flir.com>

Copyright

© 2024, FLIR Systems, Inc. All rights reserved worldwide.

Disclaimer

Specifications subject to change without further notice. Models and accessories subject to regional market considerations. License procedures may apply. Products described herein may be subject to US Export Regulations. Please refer to exportquestions@flir.com with any questions.

Publ. No.: NAS100174
Release: AA
Commit: 97578
Head: 97616
Language: en-US
Modified: 2024-05-08
Formatted: 2024-05-09

