

301D/301E

Clamp Meter

Users Manual

Nov 2022, Rev.1, 4/2024

© 2024 Fluke Corporation. All rights reserved.

Specifications are subject to change without notice.

All product names are trademarks of their respective companies.

LIMITED WARRANTY AND LIMITATION OF LIABILITY

Each Fluke product is warranted to be free from defects in material and workmanship under normal use and service. The warranty period is one year and begins on the date of shipment. This warranty extends only to the original buyer or end-user customer of a Fluke authorized reseller, and does not apply to fuses, disposable batteries, or to any product which, in Fluke's opinion, has been misused, altered, neglected, contaminated, or damaged by accident or abnormal conditions of operation or handling. Fluke warrants that software will operate substantially in accordance with its functional specifications for 90 days and that it has been properly recorded on non-defective media. Fluke does not warrant that software will be error free or operate without interruption.

Fluke authorized resellers shall extend this warranty on new and unused products to end-user customers only but have no authority to extend a greater or different warranty on behalf of Fluke. Warranty support is available only if product is purchased through a Fluke authorized sales outlet or Buyer has paid the applicable international price. Fluke reserves the right to invoice Buyer for importation costs of repair/replacement parts when product purchased in one country is submitted for repair in another country.

Fluke's warranty obligation is limited, at Fluke's option, to refund of the purchase price, free of charge repair, or replacement of a defective product which is returned to a Fluke authorized service center within the warranty period.

To obtain warranty service, contact your nearest Fluke authorized service center to obtain return authorization information, then send the product to that service center, with a description of the difficulty, postage and insurance prepaid (FOB Destination). Fluke assumes no risk for damage in transit. Following warranty repair, the product will be returned to Buyer, transportation prepaid (FOB Destination). If Fluke determines that failure was caused by neglect, misuse, contamination, alteration, accident, or abnormal condition of operation or handling, including overvoltage failures caused by use outside the product's specified rating, or normal wear and tear of mechanical components, Fluke will provide an estimate of repair costs and obtain authorization before commencing the work. Following repair, the product will be returned to the Buyer transportation prepaid and the Buyer will be billed for the repair and return transportation charges (FOB Shipping Point).

THIS WARRANTY IS BUYER'S SOLE AND EXCLUSIVE REMEDY AND IS IN LIEU OF ALL OTHER WARRANTIES, EXPRESS OR IMPLIED, INCLUDING BUT NOT LIMITED TO ANY IMPLIED WARRANTY OF MERCHANTABILITY OR FITNESS FOR A PARTICULAR PURPOSE. FLUKE SHALL NOT BE LIABLE FOR ANY SPECIAL, INDIRECT, INCIDENTAL OR CONSEQUENTIAL DAMAGES OR LOSSES, INCLUDING LOSS OF DATA, ARISING FROM ANY CAUSE OR THEORY.

Since some countries or states do not allow limitation of the term of an implied warranty, or exclusion or limitation of incidental or consequential damages, the limitations and exclusions of this warranty may not apply to every buyer. If any provision of this Warranty is held invalid or unenforceable by a court or other decision-maker of competent jurisdiction, such holding will not affect the validity or enforceability of any other provision.

Fluke Corporation
P.O. Box 9090
Everett, WA 98206-9090
U.S.A.

Table of Contents

	Title	Page
Introduction		1
Contact Fluke		1
Safety		2
Before You Start		2
Battery		2
Features/Controls.....		3
Display		4
Power		5
Auto Power Off		5
Backlight		5
Power-On Options		5
Basic Measurements		6
Hazardous Voltage Indicator		6
AC Voltage Measurement with Test Leads.....		6
Hz under AC Voltage Measurement with Test Leads.....		6
DC Voltage Measurement with Test Leads.....		6
Continuity		7
Resistance		7
Capacitance		7
Test Diodes		8
Amps AC		8
Amps AC Measurement with Jaw		8
Hz under Amps AC Measurement with Jaw.....		8
Amps DC.....		9
Amps DC Measurement with Jaw		9
Measurement Features		9
Display Hold		9
Firmware Version.....		9
Maintenance		10
How to Clean the Case		10
Environmental		10
Service		10
Specifications		11
General		11
Safety		12
Accuracy Specifications		13
Continuity Threshold		13

Introduction

The Fluke 301D/301E Clamp Meter (the Product) measures current and voltage, resistance, continuity, diode, capacitance and frequency. The 301D/301E can measure AC and DC current.

Contact Fluke

Fluke Corporation operates worldwide. For local contact information, go to our website:

www.fluke.com.

To register your product, view, print, or download the latest manual or manual supplement, go to our website.

Fluke Corporation

P.O. Box 9090

Everett, WA 98206-9090

+1-425-446-5500

fluke-info@fluke.com

Safety

General Safety Information is in the printed Safety Information document that ships with the Product and at www.fluke.com. More specific safety information is listed where applicable.

A **Warning** identifies conditions and procedures that are dangerous to the user. A **Caution** identifies conditions and procedures that can cause damage to the Product or the equipment under test.

Before You Start

Battery

⚠️⚠️ Warning

To prevent personal injury and for safe operation of the Product:

- The battery door must be closed and locked before you operate the Product.
- Remove all probes, test leads, and accessories before the battery door is opened.
- Replace the batteries when the low battery indicator shows to prevent incorrect measurements.
- When batteries are changed, ensure that the calibration seal in the battery compartment is not damaged. If damaged, the Product may not be safe to use. Return the Product to Fluke for replacement of the seal.

⚠️ Caution

To prevent damage to the battery:

- Repair the Product before use if the battery leaks.
- Do not expose battery to heat sources or high-temperature environments such as an unattended vehicle in the sun.
- Always operate in the specified temperature range.
- Do not incinerate the Product and/or battery.

The Product ships with the batteries. To replace batteries, see [Figure 1](#).

Figure 1. Battery Replacement

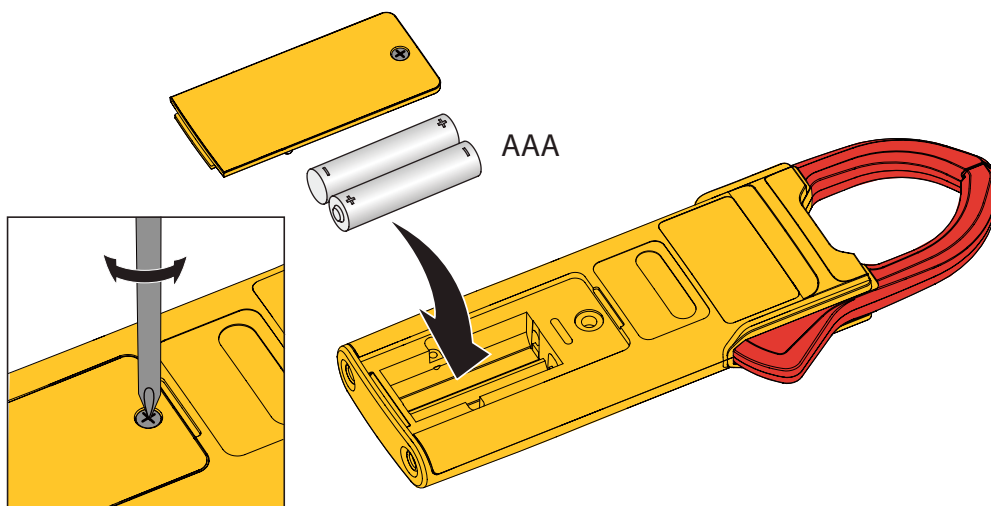

Features/Controls

Table 1 is a list of features and controls.

Table 1. Feature/Control Descriptions

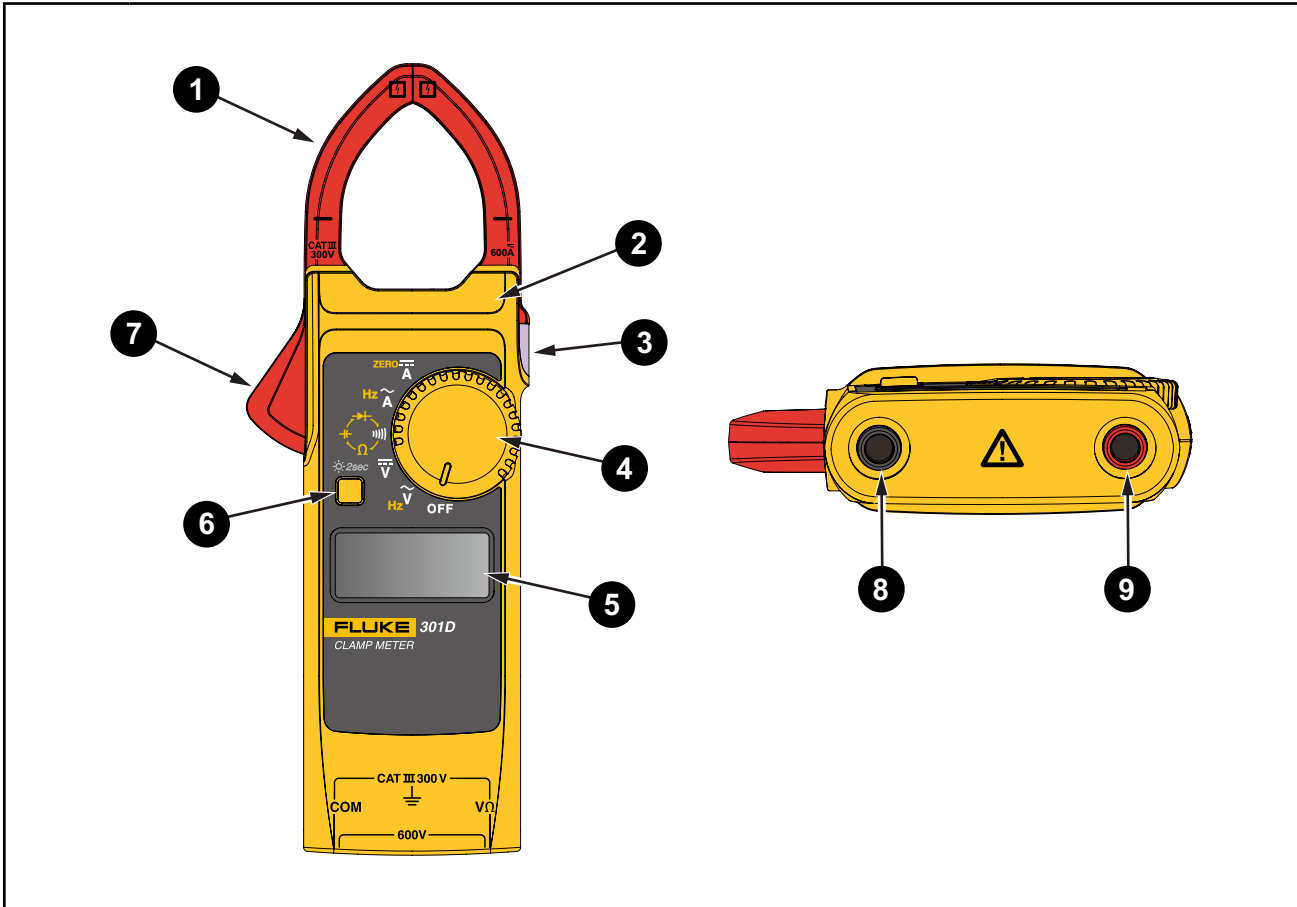

Item	Description
1	Jaw
2	Tactile Barrier
3	Hold
4	Control Knob
5	Display
6	Extends the function selection to yellow items on the control knob. Push >2 s to turn on/turn off the backlight.
7	Trigger
8	COM terminal
9	Volts/Ohm input terminal

Display

Table 2 is a list of the display annunciators.

Table 2. Display

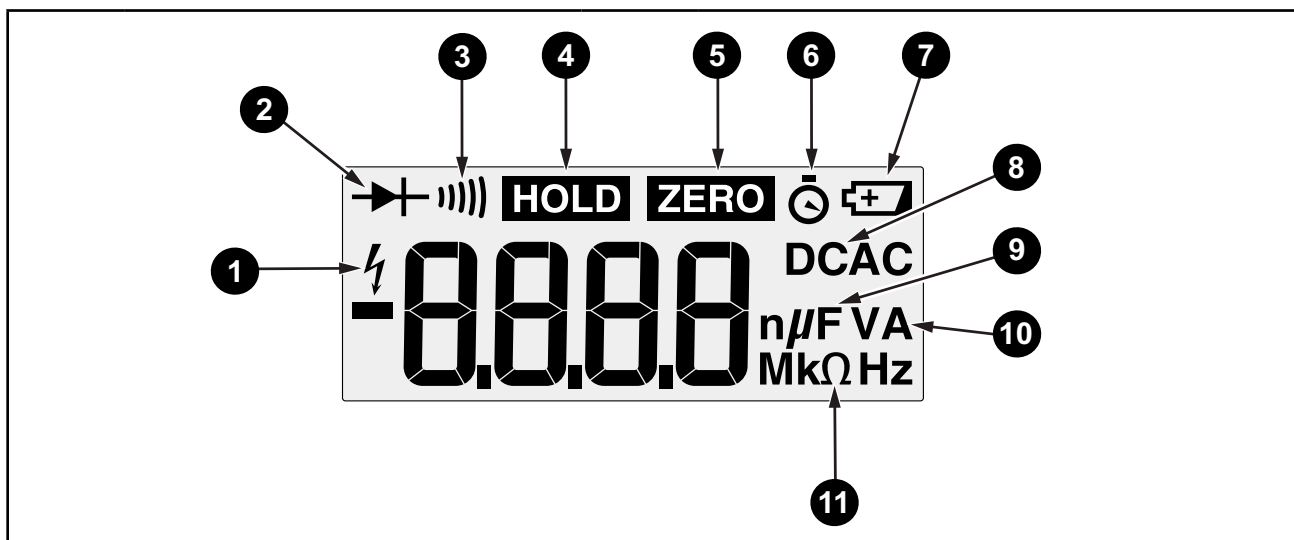

Item	Description	Item	Description
1	Hazardous voltage	6	Auto Power off
2	Diode test selected	7	Low battery. Replace battery.
3	Continuity selected	8	DC or AC measurement
4	Display hold enabled	9	Farads for capacitance
5	Zero indication	10	Unit of measurement for voltage or current
11	Unit of Resistance or Frequency		

Power

Two AAA batteries supply power to the Clamp:

- To turn on the Clamp, rotate the control knob from OFF to a function.
- To turn off the Clamp, rotate the control knob to OFF.

Auto Power Off

The Clamp automatically powers off after 20 minutes of no use. If the Clamp automatically powers off, turn the control knob to OFF and then to a function to resume operation. The  shown in the display means Auto power off is on.

To disable auto power off, see [Power-On Options](#).

Backlight

The display on the Clamp includes a backlight that improves the readability in dim work areas.

- Push  >2 s to toggle on/toggle off the backlight.

The backlight has an auto off feature that turns off the backlight after 2 minutes of no use. To disable the auto off backlight feature, see [Power-On Options](#).

Power-On Options





Power-on options allow you to customize the controls:

- Disable Auto Power Off
- Disable Auto Backlight Off
- View firmware version and light all LCD segments

To select a power-on option:

1. Turn off the Clamp.
2. See [Table 3](#) for option and button sequence.

Table 3. Power-On Options

Option	Button Sequence
Disable Auto Power Off	 + ON (rotate control knob). Display shows P_oFF .
Disable Auto Backlight Off	 button + ON (rotate control knob). Display shows L_oFF .
View firmware version and light all LCD segments	 or  button + ON (rotate control knob)



Basic Measurements

Warning

To prevent possible electrical shock, fire, or personal injury:

- Hold the Product behind the tactile barrier.
- Do not measure current while the test leads are in the input jacks.

Hazardous Voltage Indicator

When the Product senses a voltage more than $\pm 30\text{V}$ or a voltage overload() at voltage functions, even if the HOLD function is selected,  shows on the display to tell you a hazardous voltage is at the Product input.

AC Voltage Measurement with Test Leads

To measure ac voltage:

1. Turn the control knob to $\tilde{\text{V}}$.
2. Connect the black test lead to the **COM** terminal and the red test lead to the **V Ω** terminal.
3. Touch the probes to the test points of the circuit.
The display shows the ac voltage.

Hz under AC Voltage Measurement with Test Leads

To measure Hz:

1. Turn the control knob to $\tilde{\text{V}}$.
2. Push  to shift to the Hz function.
3. Connect the black test lead to the **COM** terminal and the red test lead to the **V Ω** terminal.
4. Touch the probes to the test points of the circuit.
The display shows the measurement.

DC Voltage Measurement with Test Leads

To measure dc voltage:

1. Turn the control knob to $\bar{\text{V}}$.
2. Connect the black test lead to the **COM** terminal and the red test lead to the **V Ω** terminal.
3. Touch the probes to the test points of the circuit.
The display shows the measurement.

Continuity



To measure continuity:

1. Turn the control knob to .
2. Remove power from the circuit to test.
3. Connect the black test lead to the **COM** terminal and the red test lead to the **VΩ** terminal.
4. Touch the probes to the test points of the circuit.

If the resistance is $<30\ \Omega$, the beeper sounds continuously to indicate continuity. If the display shows OL , the circuit is open.

Resistance

To measure resistance:

1. Turn the control knob to .
2. Push  to shift to the Ω function.
3. Remove power from the circuit to test.
4. Connect the black test lead to the **COM** terminal and the red test lead to the **VΩ** terminal.
5. Touch the probes to the test points of the circuit.

The display shows the value.

If the display shows OL , the circuit is open or higher than the measurement range.



Capacitance

The Clamp determines capacitance by charging a capacitor with a known current, measuring the resulting voltage, then calculating the capacitance.

Note

A good capacitor stores an electrical charge and may remain energized after power is removed. Before you touch the capacitor or make a measurement, turn all power OFF, use the Product to confirm that power is OFF, and carefully discharge the capacitor by connecting a resistor across the leads. Be sure to wear appropriate personal protective equipment.

To measure capacitance:

1. Turn the control knob to .
2. Push  twice to shift to the F function.
3. Remove the capacitor from the circuit and discharge the capacitor.
4. Connect the black test lead to the **COM** terminal and the red test lead to the **VΩ** terminal.
5. Touch the probes to the capacitor leads.

The display shows the measurement.





OL indicates the capacitor is faulty or the capacitance value is higher than the measurement range.

Test Diodes

Caution

To prevent possible damage to the Product or to the equipment under test, disconnect circuit power and discharge all high-voltage capacitors before you test diodes.

To test a diode:

1. Turn the rotary switch to .
2. Push  three times to shift to  function.
3. Connect the red test lead to the **VΩ** terminal and the black test lead to the **COM** terminal.
4. Connect the red probe to the anode side and the black test lead to the cathode side of the diode under test.
5. See the display for the forward bias voltage value.
6. If you reverse the polarity of the test leads with diode polarity, the display reading shows . Use this reading to distinguish the anode and cathode sides of a diode.

Amps AC

Warning

To prevent electrical shock, do not measure current while the test leads are in the input jacks.



Amps AC Measurement with Jaw

To measure amps ac:

1. Turn the control knob to .
2. Position the Clamp jaw around the conductor.
The display shows the amps ac measurement.

Hz under Amps AC Measurement with Jaw

To measure Hz:

1. Turn the control knob to .
2. Push  to shift to the Hz function.
3. Position the Clamp jaw around the conductor.
The display shows the measurement.

Amps DC

Warning

To prevent electrical shock, do not measure current while the test leads are in the input jacks.

Amps DC Measurement with Jaw

To measure amps dc:

1. Turn the control knob to $\overline{\text{A}}$.
2. Push  to compensate (zero) not clamp any conductor.
3. Position the Clamp jaw around the conductor.

The display shows the amps dc measurement.

Note: Do the zero action after "Zero" indication disappeared.

Measurement Features



This section is about the Clamp features you can use for measurements.

Warning

To prevent possible electrical shock, fire, or personal injury:

- Do not use the HOLD function to measure unknown potentials. When HOLD is turned on, the display does not change when a different potential is measured.
- Disconnect power and discharge all highvoltage capacitors before you measure continuity, resistance, capacitance, or a diode junction.

Display Hold

To capture and hold the display reading, push **HOLD**. The display freezes the readings and **HOLD** is continuously on. The Product reminds you that the measurement is not live. When in HOLD mode, if the Product senses a voltage more than ± 30 V or a voltage overload (),  shows on the display to tell you a hazardous voltage is at the Product input.

When in HOLD mode, push **HOLD** again to resume normal operation with live readings.

Firmware Version

To find the firmware version for the Clamp, see [Power-On Options](#).

Maintenance

The Product does not require routine maintenance.

Warning

To prevent possible electrical shock, fire, or personal injury:

- Remove the input signals before you clean the Product.
- Repair the Product before use if the battery leaks. Battery leakage may create a shock hazard or damage the Product.
- Use only specified replacement parts.
- Have an approved technician repair the Product.
- Remove the batteries if the Product is not used for an extended period of time, or if stored in temperatures above 50 °C. If the batteries are not removed, battery leakage may result.

How to Clean the Case

Wipe the case with a damp cloth and mild detergent.

Caution

Do not use abrasives, isopropyl alcohol, or solvents to clean the case or lens/window.

Environmental

This Product has electronic printed circuit boards. Dispose of the Product in a professional and environmentally appropriate manner. Delete personal data on the Product before disposal.

Remove batteries that are not integrated into the electrical system before disposal and dispose of batteries separately.

If this Product has an integral battery, put the entire Product in the electrical waste.

See [Contact Fluke](#) for more information.

Service

Have an authorized Fluke Calibration service center service the Product at one-year intervals to maintain optimum performance. Contact your equipment distributor or authorized Fluke Calibration Service Center for any equipment performance failure or to schedule regular maintenance service. See [Contact Fluke](#) for more information.

[Table 4](#) is a list of the available replacement parts.

Table 4. Replacement Parts

Item	Quantity	Fluke Part Number
BATTERY AAA1.5V PACKING	1	5128983
Battery Door	1	5336951
TL75, Test lead with two caps	1	4306653

Specifications

General

Maximum Voltage

Between any Terminal and Earth Ground.....	300 V
Between V/ Ω Terminal and COM Terminal	600 V

Display (LCD)..... 6000 counts, updates 3/sec

Battery

Type.....	2 AAA IEC LR03 alkaline
Life.....	80 hours

Automatic Power Off 20 minutes

Temperature

Operating.....	-10 °C to 50 °C
Storage.....	-30 °C to 60 °C

Operating Humidity..... Non condensing (<10°C)
≤90 % RH (at 10 °C to 30 °C)
≤75 % RH (at 30 °C to 40 °C)
≤45 % RH (at 40 °C to 50 °C)

Altitude

Operating.....	2000 m
Storage.....	12 000 m

Temperature Coefficient..... 0.1 x (specified accuracy) /°C (<18 °C or >28 °C)

Size (L x W x H) 190 mm x 52 mm x 16 mm

Size (L x W x H with barrier and trigger) 190 mm x 68 mm x 22 mm

Weight (with batteries) 154 g

Jaw Opening..... 34 mm

Ingress Protection (IP) Rating IEC 60529: IP30 non-operating

Electromagnetic Compatibility (EMC)

International	IEC 61326-1: Portable, Electromagnetic Environment, IEC 61326-2-2 <i>CISPR 11: Group 1, Class A</i> <i>Group 1: Equipment has intentionally generated and/or uses conductively-coupled radio frequency energy that is necessary for the internal function of the equipment itself.</i> <i>Class A: Equipment is suitable for use in all establishments other than domestic and those directly connected to a low-voltage power supply network that supplies buildings used for domestic purposes. There may be potential difficulties in ensuring electromagnetic compatibility in other environments due to conducted and radiated disturbances.</i> <i>Caution: This equipment is not intended for use in residential environments and may not provide adequate protection to radio reception in such environments.</i>
Korea (KCC).....	Class A equipment (Industrial Broadcast & Communications Equipment) <i>Class A: Equipment meets requirements for industrial electromagnetic wave equipment and the seller or user should take notice of it. This equipment is intended for use in business environments and not to be used in homes.</i>
USA (FCC).....	47 CFR 15 subpart B. This product is considered an exempt device per clause 15.103.

Safety

General	IEC 61010-1, Pollution Degree 2
Measurement	IEC 61010-2-032: CAT III 300V

Accuracy Specifications

Accuracy is specified for 1 year after calibration, at operating temperatures of 18 °C to 28 °C, relative humidity at 0 % to 90 %. Accuracy specifications take the form of: \pm ([% of Reading] + [Number of Least Significant Digits]).

Function	Range	Resolution	Accuracy	
			301D	301E
AC Volts (45 to 400 Hz) \tilde{V}	600.0 V	0.1 V	1.5 % ⁺⁵	1.5 % ⁺⁵
Voltage Frequency (Hz) 1 Hz~99.99 kHz Threshold 10.0 V	9.999 Hz 99.99 Hz 999.9 Hz 9.999 kHz 99.99 kHz	0.001 Hz 0.01 Hz 0.1 Hz 0.001 kHz 0.01 kHz	0.1 % ⁺³	0.1 % ⁺³
DC Volts \bar{V}	600.0 V	0.1 V	1 % ⁺⁵	1 % ⁺⁵
Resistance (Ohms) Ω	600.0 Ω 6.000 k Ω 60.00 k Ω	0.1 Ω 0.001 k Ω 0.01 k Ω	1 % ⁺⁵	1 % ⁺⁵
Capacitance μF	9.999 μF 99.99 μF 999.9 μF	0.001 μF 0.01 μF 0.1 μF	2 % ⁺⁵ 5 % ⁺⁵ 5 % ⁺⁵	2 % ⁺⁵ 5 % ⁺⁵ 5 % ⁺⁵
Diode \rightarrow	3.000 V	0.001 V	10 %	10 %
AC Current (45 to 400 Hz) \tilde{A}	60.00 A ^[2] 600.0 A 1000 A	0.01 A 0.1 A 1 A	2 % ⁺¹⁰ 2 % ⁺⁵ NA	2 % ⁺¹⁰ 2 % ⁺⁵ 2 % ⁺⁵
AAC Frequency (Hz) Threshold 10.00 A	45.0-400.0 Hz	0.1 Hz	0.1 % ⁺³	0.1 % ⁺³
DC Current \bar{A} ^[1]	60.00 A ^[2] 600.0 A 1000 A	0.01 A 0.1 A 1 A	2 % ⁺¹⁰ 2 % ⁺⁵ NA	2 % ⁺¹⁰ 2 % ⁺⁵ 2 % ⁺⁵
<p><i>Note:</i> [1] After zero operation. [2] <1% range, unspecified.</p>				

Continuity Threshold

Function	Threshold
Continuity Threshold	30 Ω