

HAKKO FX-888D SOLDERING STATION

Instruction Manual

Thank you for purchasing the HAKKO FX-888D soldering station.
Please read this manual before operating the HAKKO FX-888D.
Keep this manual readily accessible for reference.

1. PACKING LIST AND PART NAMES Please check to make sure that all items listed below are included in the package.

HAKKO FX-888D Station 1	Cleaning wire 1
HAKKO FX-8801 Soldering iron 1	
Iron holder (with cleaning sponge) 1	
Instruction Manual 1	

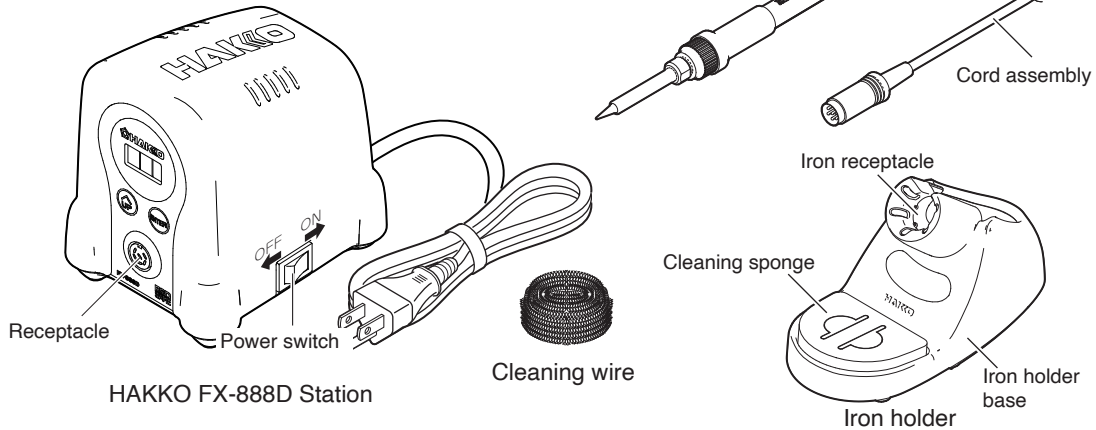

*HAKKO FX-8802 / FX-8803 / FX-8804 (not included) can be connected to HAKKO FX-888D station.
*When using the HAKKO FX-8802/FX-8803/FX-8804, please use it with the applicable iron holder.

2. SPECIFICATIONS

Power consumption	70W
● Station	
Output	AC26V
Temperature range	120 - 899°F (50 - 480°C)
Temperature stability	±1.8°F (±1°C) at idle temperature {When set to 400-899°F (200-480°C)}
Dimensions (W × H × D)	3.9(W) × 4.7(H) × 4.7(D) in. (100 × 120 × 120 mm)
Weight (w/o cord)	2.6 lb. (1.2kg)

● HAKKO FX-8801 Soldering iron

Power consumption	AC26V 65W
Tip to ground resistance	< 2 Ω
Tip to ground potential	< 2 mV
Heating element	Ceramic heater
Cord	3.9 ft. (1.2m)
Total length (w/o cord)	8.5 in. (217mm) with 1.6D tip
Weight (w/o cord)	0.10 lb. (46g / 1.62 oz.) with 1.6D tip

* The temperature was measured using the FG-100 thermometer. * This product is protected against electrostatic discharge.
* Specifications and design are subject to change without notice.

⚠ CAUTION

■ Handling precautions for ESD Safe products

This product contains electrostatic countermeasures, so please use the following precautions:

1. Not all plastic parts are insulators, they may be conductive. Be careful not to expose live electrical parts or damage insulating materials when performing repairs or replacing parts.
2. Be sure to ground the product before use.

3. WARNINGS, CAUTIONS AND NOTES

Warnings, cautions and notes are placed at critical points in this manual to direct the operator's attention to significant items. They are defined as follows:

⚠ WARNING: Failure to comply with a WARNING may result in serious injury or death.

⚠ CAUTION : Failure to comply with a CAUTION may result in injury to the operator, or damage to the items involved.

⚠ WARNING

When power is ON, tip temperatures will be between 120 to 899°F. (50 and 480°C) To avoid injury or damage to personnel and items in the work area, observe the following:

- Do not touch the tip or the metal parts near the tip.
- Do not allow the tip to come close to, or touch, flammable materials.
- Inform others in the area that the unit is hot and should not be touched.
- Turn the power off when not in use, or left unattended.
- Turn the power off when changing parts or storing the HAKKO FX-888D.
- This appliance can be used by children aged from 8 years and above and persons with reduced physical, sensory or mental capabilities or lack of experience and knowledge if they have been given supervision or instruction concerning use of the appliance in safe way and understand the hazards involved.
- Children shall not play with the appliance.
- Cleaning and user maintenance shall not be made by children without supervision.
- The unit is for a counter or workbench use only.
- If the power cord is damaged, it must be replaced by the manufacturer, its service agent or similarly qualified person in order to avoid personal injury or damage to the unit.

To prevent accidents or damage to the HAKKO FX-888D, be sure to observe the following:

⚠ CAUTION

- Do not use the HAKKO FX-888D for applications other than soldering.
- Do not strike the iron against hard objects to remove excess solder. This will damage the iron.
- Do not modify the HAKKO FX-888D.
- Use only genuine Hakko replacement parts.
- Do not allow the HAKKO FX-888D to become wet, or use it with wet hands.
- Remove power and iron cords by holding the plug, not the wires.
- Be sure the work area is well ventilated. Soldering produces smoke.
- While using the HAKKO FX-888D, don't do anything which may cause bodily harm or physical damage.

4. INITIAL SETUP

A. Setup the iron holder

1. Fit the small sponge pieces into the hollows of the iron holder base.
2. Add an appropriate amount of water into the iron holder base. The small sponge will absorb water and help keep the large sponge damp at all times.
3. Dampen the large sponge and place it on the iron holder base.

⚠ CAUTION

Be sure the sponge is moistened with water before use to avoid damaging the tip.

*When using a Cleaning Wire

Place it in the iron holder as shown on the right. See "2.Using a Cleaning Wire" in section "7. MAINTENANCE"

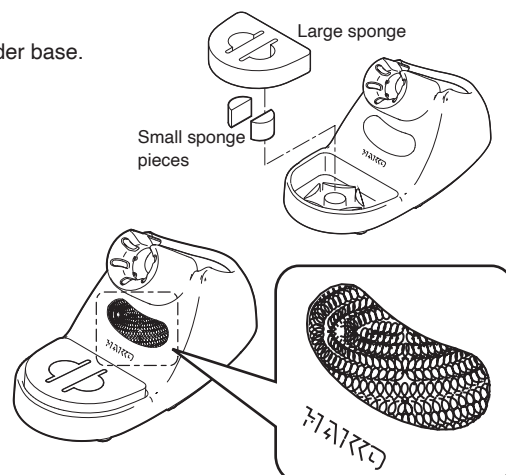

4. INITIAL SETUP

B. Connect the iron to the station

⚠ CAUTION

Be sure to turn off the power before connecting or disconnecting the cord assembly for the iron to and from the receptacle to avoid damaging the circuit board.

1. Connect the cord assembly to the receptacle.

⚠ CAUTION

Do not use any iron other than those listed in Section 1 of this manual. Doing so may result in inadequate performance and / or possible damage to the unit.

2. Place the iron into the iron holder.
3. Plug the power cord into an appropriate power supply.

⚠ CAUTION

The unit is protected against electrostatic discharge and must be grounded for full efficiency.

Push on the plug until it stops, making sure it is securely connected.

Receptacle

To disconnect, hold the plug and pull it out of the receptacle.

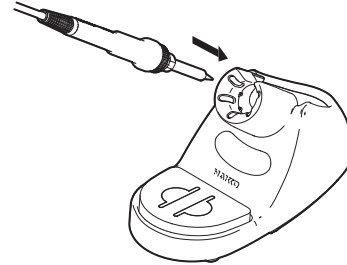

5. OPERATION

● Operation and indication

Switch and control button

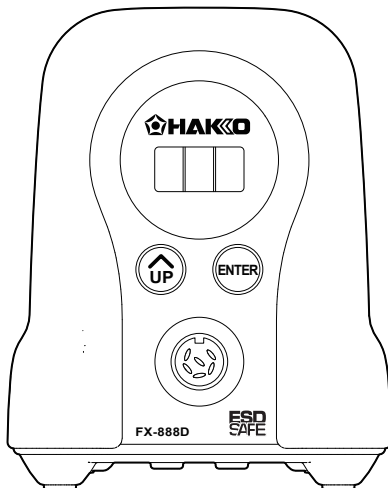

The front panel for the FX-888D has the following two control buttons.



— Use this button to select and change settings.

In the temperature preset mode, pressing this button will change the selected preset temperature while the unit is in operation.

Pressing and holding the button will start the adjustment mode.



— Use this button to make and confirm selections.

Pressing this button will display the current set temperature.

Pressing and holding the button will start the temperature setting mode.

A. Turn on the power switch

After turning on the power switch, **88.8** will be displayed for two seconds, and current temperature will be displayed. When the display stabilizes, the LED heater lamp will begin to flash.



Heater lamp

⚠ CAUTION

Place the iron in the iron holder when not in use.
Turn the power off when the FX-888D is not in use for an extended period.

B. After use

Always clean the tip and coat it with fresh solder after use.

5. OPERATION

● Making Changes to Settings

⚠ CAUTION

If no buttons are pressed for at least one minute during the process of changing settings of the unit, the system will exit and return to operating mode and display the current temperature.

A. Changing the set temperature

The temperature setting range is from 120 to 899°F. (from 50 to 480°C)

By default, the temperature is set to 750°F. (399°C)

Example : Changing from 750°F to 800°F

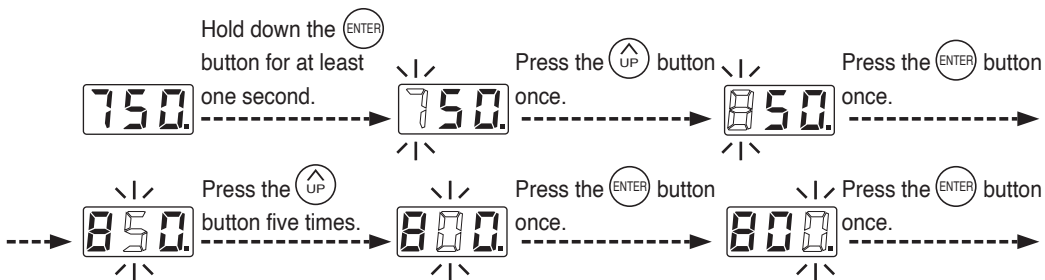

The desired temperature is saved to the system memory.
Heater control will begin after the new set temperature is displayed.

B. The preset mode

The HAKKO FX-888D has a preset mode that will allow the unit to store up to 5 preset temperatures you can change between instead of using the above normal mode.

Initial preset temperatures

P1	: 600°F (316°C)
P2	: 700°F (371°C)
P3	: 750°F (399°C)
P4	: 800°F (427°C)
P5	: 850°F (454°C)

The initial number of active presets is set to 5 at the factory.
The default selected preset is set to P3 at the factory.

Example : Changing preset temperature from preset No.1(250°C) to No.3(350°C).

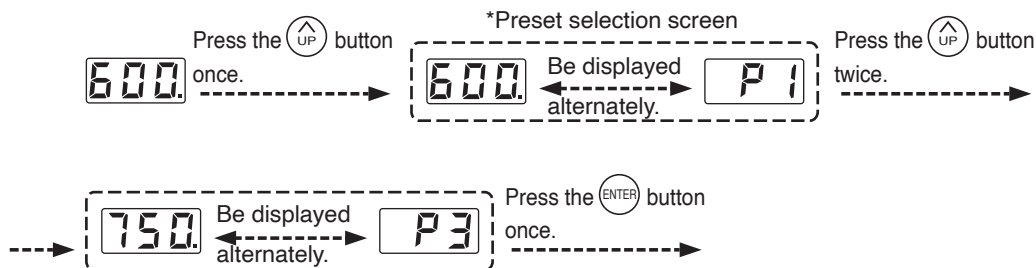

Heater control will begin with new preset temperature.

The procedure for making changes to the preset temperatures is the same as changing the set temperature.

Enter the parameter setting to change the mode. (Please refer to [6. PARAMETER SETTING])

5. OPERATION





C. Performing the temperature adjustment

When replacing the iron, heater or tip, a temperature adjustment may be required. Use adjustment mode to perform the temperature adjustment.

⚠ CAUTION

- Enter the observed value in the adjustment mode after the tip temperature stabilizes.
- The maximum single adjustment that can be made is $\pm 150^{\circ}\text{C}$ (270°F) relative to the set temperature. If a larger adjustment is needed, make the first adjustment at the maximum value of 150°C (270°F), then repeat the adjustment process.

Example : If the measured temperature is 380°C , and the set temperature is 400°C .

1. Press and hold the  button down for at least two seconds.
 -  is displayed. If you press the  button, the display will move to the adjust mode.
2. Changing from  to .
 - The procedure for changing the value in adjustment mode is the same as setting the temperature in normal mode. Please refer to Section 5 - OPERATION.

NOTE :

During adjustment mode, the hundreds digit will accept values from 0 through 6 if the temperature is set to display in $^{\circ}\text{C}$, or the values 0 through 9 if the temperature is set to display in $^{\circ}\text{F}$.

3. Press the  button to exit the setting after changing the values.
 - The tip temperature will be adjusted accordingly.

* How to distinguish between Temperature Setting Mode and Adjustment Mode.

The display differs in the temperature setting and the adjustment mode.

In the Temperature Setting Mode



In the Adjustment Mode

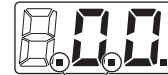

Identification lamps are on in the adjustment mode.

⚠ CAUTION

Please be sure to confirm the status of the identification lamps so that you do not enter a value in the wrong mode.

5. OPERATION

D. Restriction on setting changes (Password function)

It is possible to restrict certain setting changes to the unit.

There are three choices for the password setting. (The factory default is "0 : Open")

	0 : Open	1 : Partial	2 : Restricted
Move to the parameter setting mode	○	×	×
Move to the temperature setting mode	○	△	×
Move to the preset selection mode	○	△	×
Move to the adjust mode	○	△	×

○ : You can make changes without entering a password.

△ : You can choose whether or not a password is needed to make changes.

×

Select and input three letters for password from six letters on the right.



Example: The procedure for changing the set temperature when the unit is restricted by a password. (Password is "AbC")

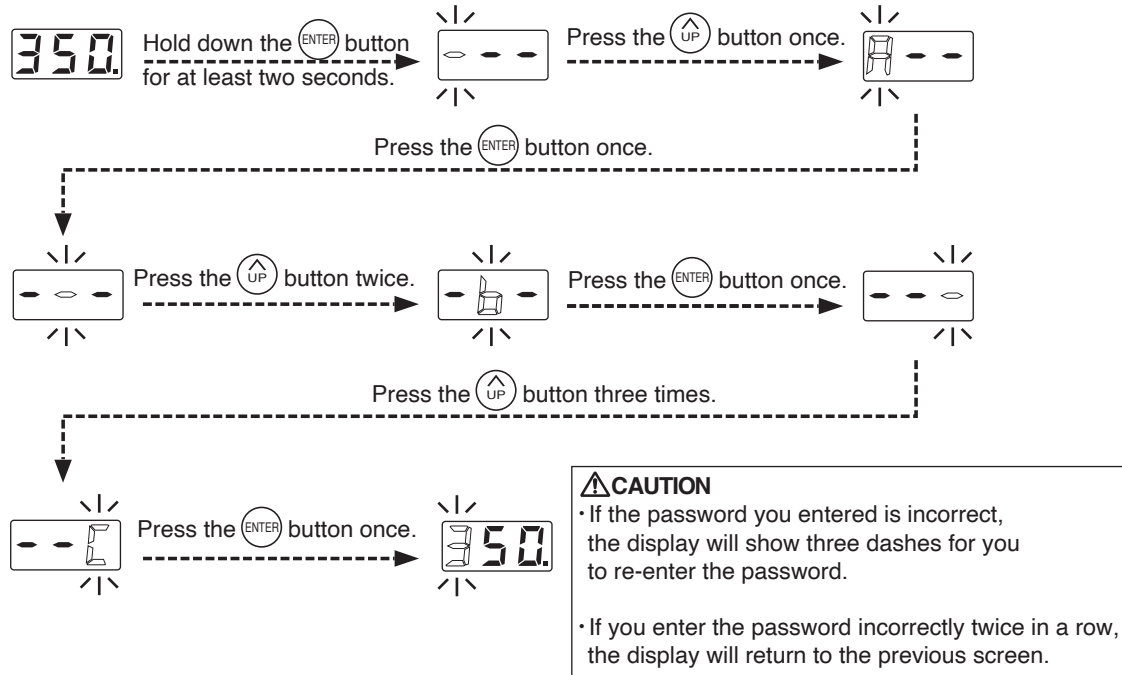

The unit will move to the change setting screen for each mode after entering the password.

Please change the setting for each mode according to the procedure.

(In the above example, please refer to the procedure for setting the temperature.)

6. PARAMETER SETTING

The HAKKO FX-888D has the following parameters.

Parameter name	Parameter No.	Value	Initial value
°C / °F selection	01	°C / °F	°F
Low temperature error setting	03	54~270°F (30~150°C)	270°F
Setting mode selection	11	0 : The normal mode / 1 : The preset mode	0
The number of preset *		<input type="text" value="2P"/> (2 pcs) ~ <input type="text" value="5P"/> (5 pcs)	<input type="text" value="5P"/>
Password setting	14	0 : Open / 1 : Partial / 2 : Restricted	0
Temperature setting mode **		<input type="text" value="10"/> : ○ / <input type="text" value="11"/> : ×	<input type="text" value="11"/>
Preset selection mode **		<input type="text" value="20"/> : ○ / <input type="text" value="21"/> : ×	<input type="text" value="20"/>
Adjust mode **		<input type="text" value="30"/> : ○ / <input type="text" value="31"/> : ×	<input type="text" value="31"/>
Password ***		ABCDEF Select three letters	-



*It is displayed only when "1:Preset mode" is selected in the setting mode.

**It is displayed only when "1:Custom" is selected in the password setting.

***It is displayed only when either "1:Custom" or "2:valid" is selected in the password setting.

The HAKKO FX-888D has the following four parameters. Turn the power on while pressing the  button.

Perform the setting to select the desired parameter No..

Press the  button to change the values, and press the  button to execute.

● 01: °C or °F temperature display selection

The displayed temperature can be switched between Celsius and Fahrenheit.

● 03: Low temperature error setting

If the sensor temperature goes below the low-limit temperature although heating element is on, an error will be displayed.

● 11: Setting mode selection

Temperature setting can be switched between the normal mode and the preset mode.

If selecting the preset mode, you will be asked for the number of preset you required.

Press the  button to set the number.

● 14: Password setting

Select "Open", "Partial" or "Restricted" for password setting. If selecting Restricted, perform the setting for password. If selecting Partial, choose whether or not the password function is needed when moving to the temperature setting mode, the preset mode and the adjust mode and set the password.

■ Parameter entering mode

1. Turn off the power switch.
2. Turn on the power switch while pressing the  button.
3. When the display shows , the station is in parameter entering mode.

6. PARAMETER SETTING

■ Parameter entering mode

● °C or °F temperature display selection

1. Either or will be displayed if you press the button when is displayed.
2. and will be switched alternately if you press the button.
3. The display will return to if you press the button after selecting.

● Low temperature error setting

1. Press the button to change the display to .
2. The low-limit temperature will be displayed if you press the button. Enter the value in the same manner as setting the temperature in the normal mode [5. OPERATION ●The normal mode]
3. The display will return to if you press the button after setting.

● Setting mode selection









1. Press the button to change the display to .
2. If you press the button, the display will move to the setting mode selection screen. If you press the button, (The normal mode) and (The preset mode) will be switched alternately.
3. The display will return to if you press the button after selecting.*

*** If you select the preset mode, the display will move to the preset selection screen.**













4. The number of active preset will be displayed If you press the button at 3.
(Example : If the number is three, is displayed.)
5. Press the button to change the value and select the number of active preset you required.
The unit will accept values from 2P through 5P.
6. The display will return to if you press the button after selecting.

6. PARAMETER SETTING

● Password setting





1. Press the  button to change the display to .
2. If you press the  button, the display will move to the password setting mode selection screen.
If you press the  button,  (Open),  (Partial) and  (Restricted) will be switched alternately.
3. If you press the  button after selecting, the display will return to . *1、2









***1 The display will move to the following selection screen if you select  (Partial).**

4. If you press the  button at 3, you will be asked whether or not the password function is needed when moving to the temperature setting mode.
5. Either  (without password) or  (with password) will be displayed if you press the  button.
6. If you press the  button after selecting, you will be asked whether or not the password function is needed when moving to the preset selection mode.
7. Either  (without password) or  (with password) will be displayed if you press the  button.
8. If you press the  button after selecting, you will be asked whether or not the password function is needed when moving to the adjust mode.
9. Either  (without password) or  (with password) will be displayed if you press the  button.
10. If you press the  button after selecting, the display will move to password setting screen.

***2 If you select  (Restricted), the display will move to the following password setting screen.**

If you select  (Partial), the display will move to the following the password setting screen after selecting *1.

11. The hundreds digits in the display will begin to flash. It indicates that you can enter the value.
Press the  button to enter the letter you required.
12. The tens digits in the display will begin to flash if you press the  button after entering.
Use the same procedure to enter the letters for tens and units digit.
13. The display will return to  if you press the  button after entering the units digit.

After changing parameters, press and hold the  button down for at least two seconds until  is displayed.
At this time, you can switch between  and  by pressing the  button. Select  if you are finished making changes or  if you need to go back and make more changes. Press the  button to confirm you selection.

Changes will not be completed until  is displayed and you press the  button.

Please note that no changes will be made if you turn off the power while making changes.

7. MAINTENANCE

Performing proper and periodic maintenance extends product life. Efficient soldering depends upon the temperature, quality and quantity of the solder and flux.

Apply the following service procedure as dictated by the conditions of usage.

WARNING

Since the soldering iron can reach a very high temperature, please work carefully. Except the case especially indicated, always turn the power switch OFF and disconnect the power plug before performing any maintenance procedure.

● Tip Maintenance

1. Set the temperature to 482°F (250°C).
2. When the temperature stabilizes, clean the tip with the cleaning sponge and check the condition of the tip.
3. If the solder plated part of the tip is covered with black oxide, apply fresh solder containing flux, and clean the tip again. Repeat until all the oxide is removed, then coat the tip with fresh solder.
4. If the tip is deformed or heavily eroded, replace it with a new one.

CAUTION

Do not file the tip in an attempt to remove the black oxide.

■ Cleaning the tip using the iron holder

1. Using the cleaning sponge

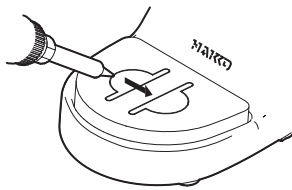

Use the cleaning sponge that comes with the product to clean the tip. It offers wide-ranging uses, from simple removal of excess solder to complete elimination of matter occurring as a result of oxidization.

2. Using the cleaning wire

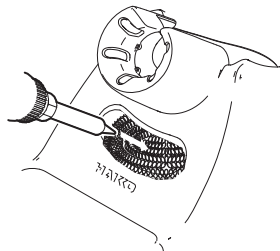

Material that is not removed easily with the cleaning sponge can likely be removed using the cleaning wire.

8. CHECKING PROCEDURE

Disconnect the plug of the cord assembly and measure the resistance value between the pins of the connecting plug as follows.

If the values of "a" and "b" are outside the value in the table, replace the heating element (sensor) and/or cord assembly.

If the value of "c" is over the value in the table, remove the oxidization film by lightly rubbing with sand-paper or steel wool the points shown in the drawing on the right.

a. Between pins 4 & 5 (Heating Element)	2.5 - 3.5 Ω (at time of room temperature)
b. Between pins 1 & 2 (sensor)	43 - 58 Ω
c. Between pin 3 & Tip	2 Ω or less

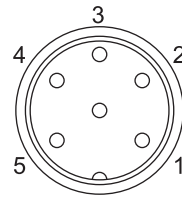

Buff lightly.

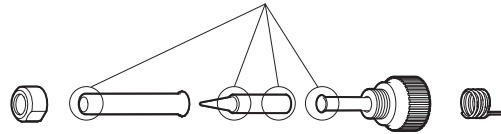

● Disassembling

1. Broken Heating Element/Sensor

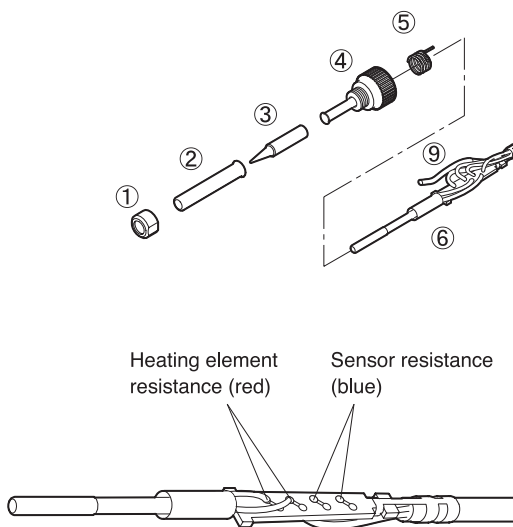

1. Turn the nut ① counterclockwise and remove the tip enclosure ② and the tip ③.
2. Turn the nipple ④ counterclockwise and remove it from the iron.
3. Pull both the heating element ⑥ and the cord assembly ⑦ out of the handle ⑧. (Toward the tip of the iron).
4. Pull the grounding spring ⑤ out of the sleeve of the terminal ⑨.

* Measure when the heating element is at room temperature.

1. Heating element resistance (red) 2.5 - 3.5 Ω

2. Sensor resistance (blue) 43- 58 Ω

If the resistance value is not normal, replace the heating element. (Refer to the instructions included with the replacement part.)

After replacement

- ① Measure the resistance between pins 4 and 1, 4 and 2, 5 and 1, and 5 and 2. If it is not ∞ , the heating element and sensor are touching. This will damage the circuit board.
- ② Measure the resistance "a," "b," and "c" to confirm that the leads are not twisted and that the grounding spring is properly connected.

2. Broken Cord Assembly

There are two methods of testing the cord assembly.

1. Turn the unit ON and set the temperature to 899°F. Then bend the iron cord at various locations along its length, including in the strain relief area. The cord assembly needs to be replaced if S-E is displayed or although the LED heater lamp flashes, the tip temperature doesn't rise.

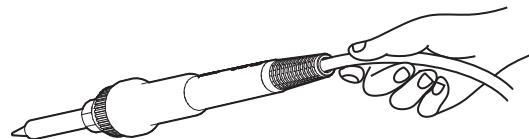

2. Check the resistance between the plug pin and the terminal lead.
Pin 1: Red Pin 2: Blue Pin 3: Green Pin 4: White Pin 5: Black
Resistance: 0 Ω .
If it is higher than 0 Ω or is ∞ , the cord should be replaced.

⚠ CAUTION

The power lamp starts to flash when the temperature reaches 880°F (480°C) regardless of the condition of the cord.

9. TROUBLE SHOOTING GUIDE

⚠ WARNING

- Before checking the inside of the FX-888D or replacing parts, be sure to disconnect the power plug.
- If the power cord is damaged, it must be replaced by the manufacturer, its service agent or similarly qualified person in order to avoid personal injury or damage to the unit.

- Nothing happens when the power switch is turned on.

CHECK: Is the power cord and/or connecting plug disconnected?

ACTION: Connect it.

CHECK: Is the fuse blown?

ACTION: Determine why the fuse blew and eliminate the cause, then replace the fuse.

a. Is the inside of the iron short-circuited?

b. Is the grounding spring touching the heating element?

c. Is the heating element lead twisted and short-circuited?

Try replacing the fuse even if the cause cannot be identified. If it still blows, return the product for repair.

- The heater lamp lights up but the tip does not heat up.

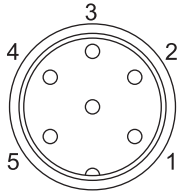

CHECK: Is the cord assembly broken? Is the heating element/sensor broken?

ACTION: If the cord assembly is broken, replace the HAKKO FX-8801. If the heating element / sensor is broken, replace the heating element.

a. Between pins 4 & 5 (Heating Element)	2.5 - 3.5 Ω (at time of room temperature)
b. Between pins 1 & 2 (sensor)	43 - 58 Ω
c. Between pin 3 & Tip	2 Ω or less

- The Heater- error [H-E] is displayed.

CHECK: Is the heater broken?

ACTION: If the heater is broken, replace the heating element.

- The tip heats up intermittently.

CHECK: Is the cord assembly broken?

ACTION: If the cord assembly is broken, replace the HAKKO FX-8801.

- Solder does not wet to the tip.

CHECK: Is the tip temperature too high?

ACTION: Set an appropriate temperature.

CHECK: Is the tip coated with black oxide?

ACTION: Remove the black oxide. (Refer to "Tip Maintenance.")

- The tip temperature is too low.

CHECK: Is the tip coated with black oxide?

ACTION: Remove the black oxide. (Refer to "Tip Maintenance.")

CHECK: Is the iron temperature adjusted correctly?

ACTION: Perform the temperature adjustment.

- The tip can not be pulled off.

CHECK: Is the tip seized? Is the tip swollen because of deterioration?

ACTION: Replace the tip and the heating element.

- The tip doesn't hold the desired temperature.

CHECK: Is the iron temperature adjusted correctly?

ACTION: Perform the temperature adjustment.

10. TIP STYLES

Unit: mm (in.)

T18-B SHAPE-B

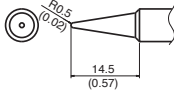

T18-SB SHAPE-SB

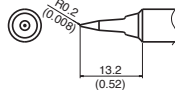

T18-BR02 SHAPE-0.2BR

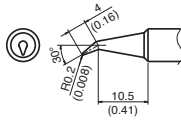

T18-BL SHAPE-BL

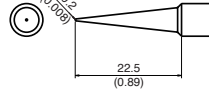

T18-C05 SHAPE-0.5C

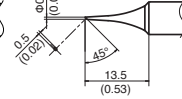

T18-C08 SHAPE-0.8C

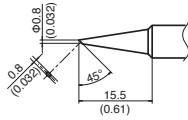

T18-C1 SHAPE-1C
T18-CF1*

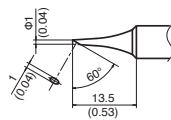

T18-CF15* SHAPE-1.5C

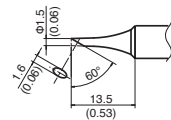

T18-C2 SHAPE-2C
T18-CF2*

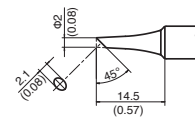

T18-CSF25* SHAPE-2.5CS

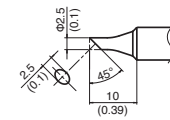

T18-C3 SHAPE-3C
T18-CF3*

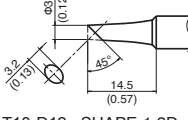

T18-C4 SHAPE-4C
T18-CF4*

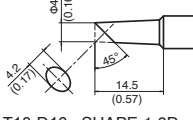

T18-C5 SHAPE-5C

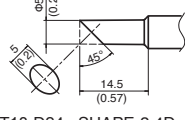

T18-K SHAPE-K

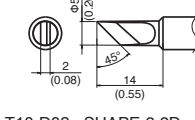

T18-D08 SHAPE-0.8D

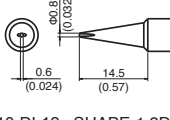

T18-D12 SHAPE-1.2D

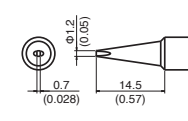

T18-D16 SHAPE-1.6D

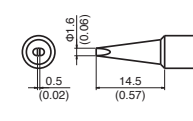

T18-D24 SHAPE-2.4D

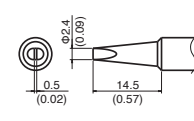

T18-D32 SHAPE-3.2D

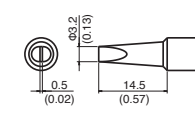

T18-DL12 SHAPE-1.2DL

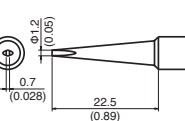

T18-DL2 SHAPE-2DL

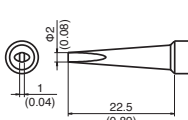

T18-DL32 SHAPE-3.2DL

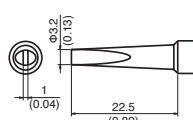

T18-S3

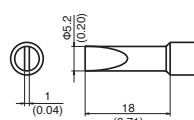

T18-S4

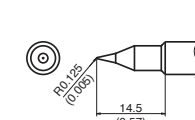

T18-S6

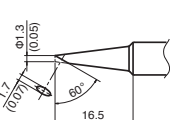

T18-S7

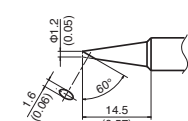

T18-S9

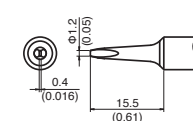

T18-I SHAPE-I

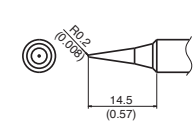

T18-IS SHAPE-IS

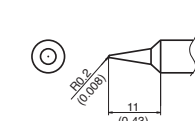

* Tinned on the soldering surface only.

● Use only genuine Hakko soldering iron tips. Replacement tips for the HAKKO FX-888D are designated the T18 series.

11. PARTS LIST

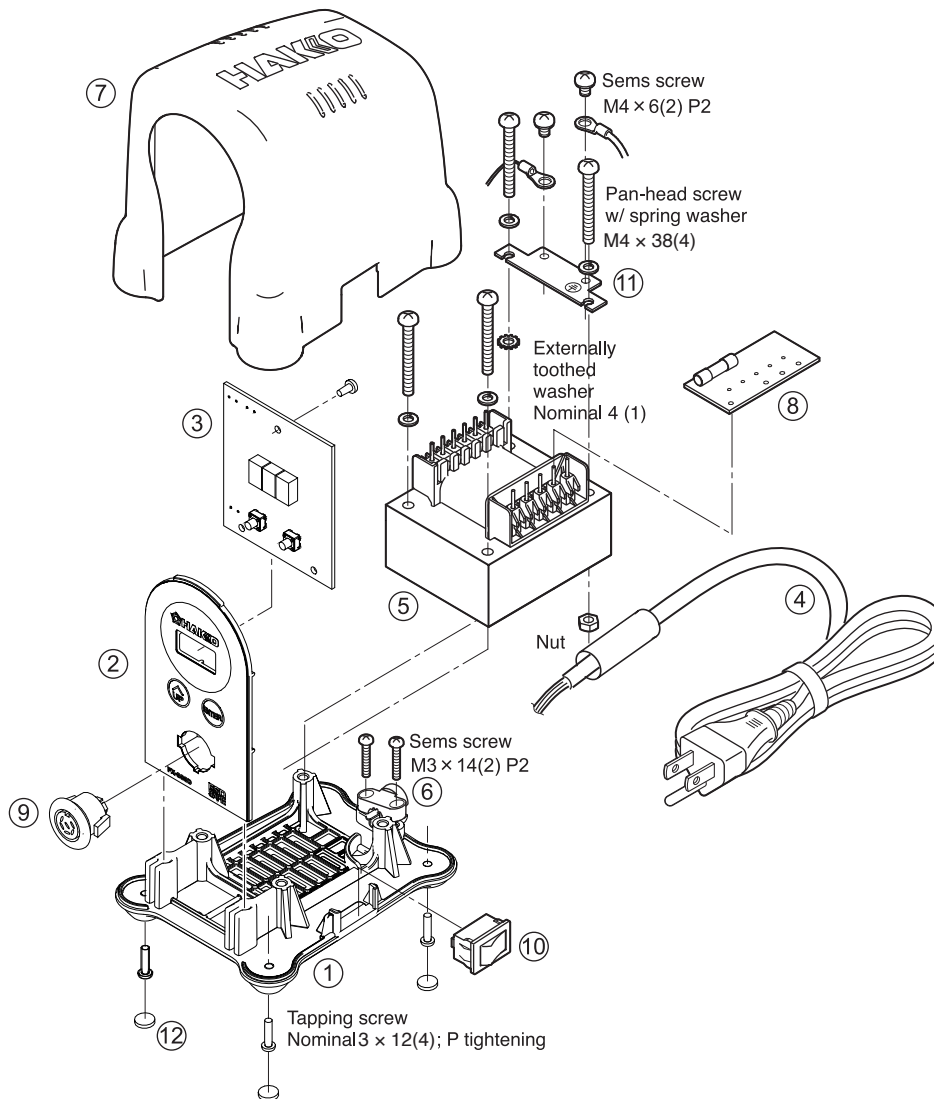

● HAKKO FX-888D Station

Item No.	Part No.	Part Name	Specifications
①	B3733	Chassis	
②	B3734	Front panel / Yellow	For Blue-Yellow
	B3735	Front panel / Gray	For Silver
③	B3736	P.W.B	For temperature control
④	B3741	Power cord, 3 wired cord & American plug	With tube, USA
	B3742	Power cord, 3 wired cord but no plug	With tube
	B3743	Power cord, 3 wired cord & BS plug	With tube
	B3744	Power cord, 3 wired cord & European plug	With tube, CE
	B3745	Power cord, 3 wired cord & BS plug	With tube, CE
	B3746	Power cord, 3 wired cord & Australian plug	With tube
	B3747	Power cord, 3 wired cord & Chinese plug	With tube
	B3748	Power cord, 3 wired cord & SI plug	With tube
	B3749	Power cord, 3 wired cord & American plug (B)	With tube

Item No.	Part No.	Part Name	Specifications
⑤	B3737	Transformer	100-110V
	B3738	Transformer	120V
	B3739	Transformer	220-240V
⑥	B3750	Cord stopper	
⑦	B3450	Upper case / Blue-Yellow	
	B3452	Upper case / Silver	
⑧	B3721	P.W.B / 100V	With fuse and rubber feet
	B3722	P.W.B / 110 -120V	With fuse and rubber feet
	B3680	P.W.B / 220V	With fuse and rubber feet
	B3723	P.W.B / 230V	With fuse and rubber feet
	B3724	P.W.B / 240V	With fuse and rubber feet
⑨	B3463	Receptacle	
⑩	B2852	Switch	
⑪	B2227	Grounding plate	
⑫	B2405	Rubber feet	

11. PARTS LIST

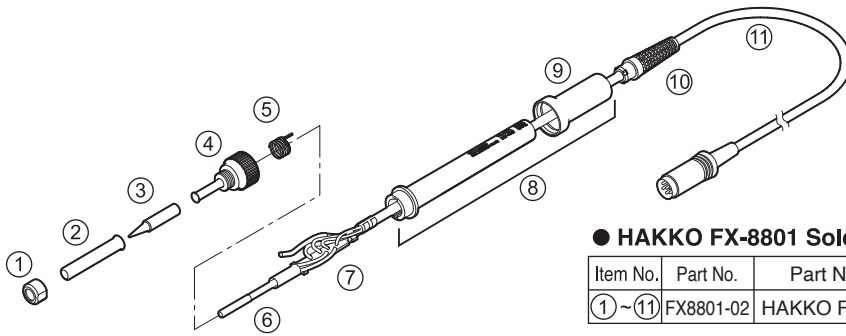

● HAKKO FX-8801 Soldering Iron

Item No.	Part No.	Part Name	Specifications
①~⑪	FX8801-02	HAKKO FX-8801	

● Soldering Iron Parts

Item No.	Part No.	Part Name	Specifications
①	B1785	Nut	
②	B3469	Tip enclosure	
③		Tip	See "10. TIP STYLES"
④	B2022	Nipple	
⑤	B2032	Grounding spring	
⑥	A1560	Heating element	26V-65W
⑦	B2028	Terminal board	With cord stopper
⑧	B3470	Handle	With handle cover
⑨	B3471	Handle cover	
⑩	B3467	Cord bushing	
⑪	B3468	Cord assembly	

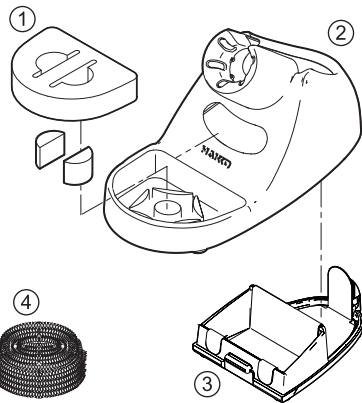

● HAKKO FH-800 Iron Holder

Item No.	Part No.	Part Name	Specifications
①~⑤	FH800-03BY	HAKKO FH-800	Blue-Yellow
①~⑤	FH800-03SV	HAKKO FH-800	Silver

● Iron Holder Parts

Item No.	Part No.	Part Name	Specifications
①	A1559	Cleaning sponge	
②	B3472	Iron holder base	Blue-Yellow with rubber foot
	B3473	Iron holder base	Silver with rubber foot
③	B3751	Bottom plate	with Protective Sheet & rubber foot
④	A1561	Cleaning wire	

⚠ CAUTION

For safety reasons, please attach the protective sheet to the bottom plate when using the soldering iron.

● Optional Parts

Part No.	Part Name	Specifications
B3474	Rubber cleaner	

- 各言語（日本語、英語、中国語、フランス語、ドイツ語、韓国語）の取扱説明書は以下のURL、HAKKO Document Portalからダウンロードしてご覧いただけます。（商品によっては設定の無い言語がありますが、ご了承ください。）
- 各国語言（日語、英語、中文、法語、德語、韓語）的使用說明書可以通過以下网站的 HAKKO Document Portal 下載參閱。（有一部分的产品沒有設定外語對應、請見諒）
- Instruction manual in the language of Japanese, English, Chinese, French, German, and Korean can be downloaded from the HAKKO Document Portal. (Please note that some languages may not be available depending on the product.)

➔ <https://www.hakko.com/english/support/doc/>

HAKKO
HAKKO CORPORATION

HEAD OFFICE

4-5, Shiokusa 2-chome, Naniwa-ku, Osaka 556-0024 JAPAN
TEL: +81-6-6561-3225 FAX: +81-6-6561-8466
<https://www.hakko.com> E-mail: sales@hakko.com

OVERSEAS AFFILIATES

U.S.A.: AMERICAN HAKKO PRODUCTS, INC.
TEL: (661) 294-0090 FAX: (661) 294-0096
Toll Free (800) 88-HAKKO
<https://www.HakkoUSA.com> E-mail: Support@HakkoUSA.com

HONG KONG: HAKKO DEVELOPMENT CO., LTD.
TEL: 2811-5588 FAX: 2590-0217
<https://www.hakko.com.cn> E-mail: info@hakko.com.hk

SINGAPORE: HAKKO PRODUCTS PTE., LTD.
TEL: 6748-2277 FAX: 6744-0033
<https://www.hakko.com.sg> E-mail: sales@hakko.com.sg

Please access the web address below for other distributors.

<https://www.hakko.com>