

# BT3554-50 BT3554-51 BT3554-52

## BATTERY TESTER

# HIOKI

## Instruction Manual



Read carefully before use.  
Keep for future reference.

EN

Sept. 2021 Revised edition 3  
BT3554F961-03 21-09H





# Battery Tester Quick Guide

## Let's start by measuring a fresh battery

To evaluate whether batteries have deteriorated, measure the internal resistance of a fresh battery. Deteriorated batteries will have about 1.5 to 2 times (values for reference purposes) as high internal resistance as a fresh one. Use these values as guidelines when determining deterioration evaluation values.

### Example: Changes in the internal resistance and voltage associated with battery deterioration

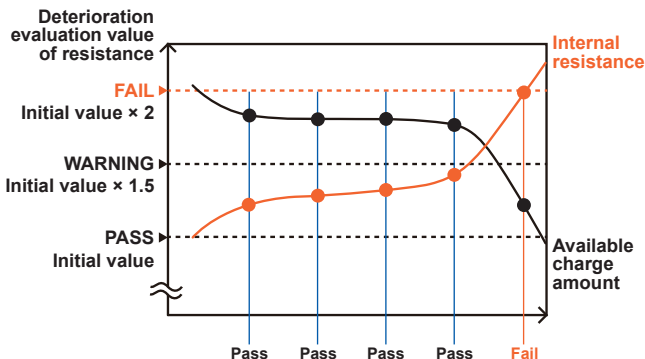
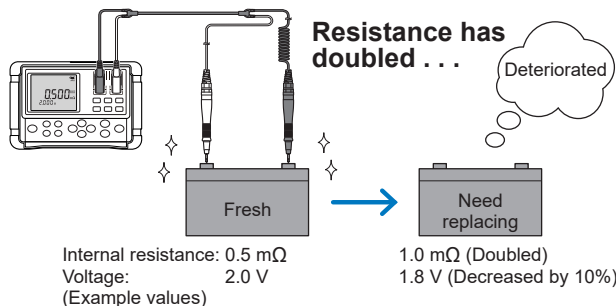

## Basic instruction on how to use the instrument

- 1** Connect the test lead to the instrument.

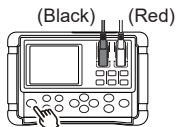

Hold down for at least 1 s.

- 2** Turn on the instrument.

Set the date and time when using the instrument for the first time.  
(p. 45)

- 3** Choose a resistance range.  
(p. 49)



- 4** Choose a voltage range.  
(p. 49)



- 5** Enable the automatic hold and automatic memory functions.

(The **AUTO HOLD** and **AUTOMEMORY** segments will appear.)



**Tips** When the measured values become stable, the display will automatically freeze them.  
See "3.6 Automatic Hold Function" (p. 61).

Immediately after the display freezes measured values, the instrument will automatically save them.  
See "5.3 Automatic Memory Function" (p. 89).

**6** Connect the test lead to a battery under measurement.

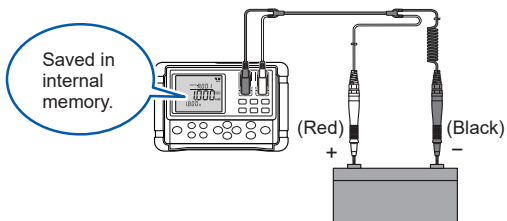

## Convenient functions

### ● Comparator function

You can set threshold values to evaluate battery deterioration using the comparator function. (p. 69)

#### Example of setting deterioration evaluation values

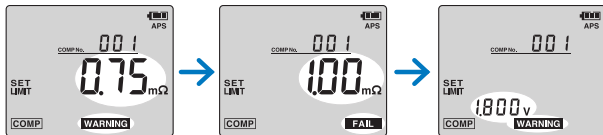
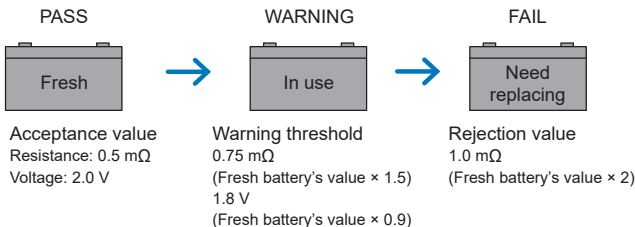

### ● Downloading measured values to your computer

You can connect the instrument and your computer using the accompanying USB cable to download measured values. (p. 105)



## ● Profile information **NEW** (p. 84)

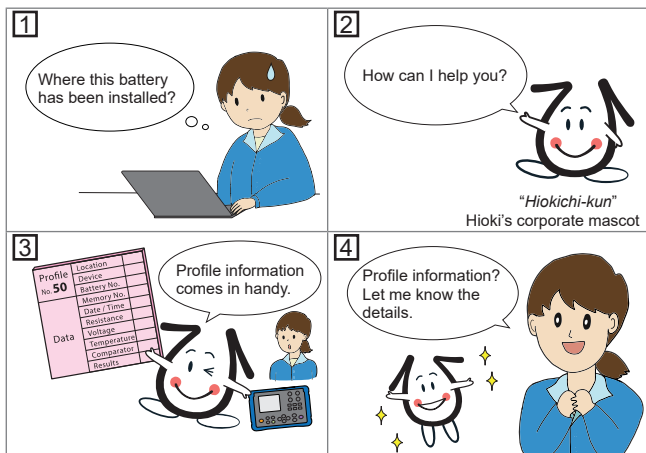

The use of profile information lets you save measured data associating with detail information.

### Concept of a data set to be saved

Profile information	Profile number	1
	Location information	HIOKI 1F UPS ROOM
	Device information	UPS 1-1
	Battery number	1
Measured data	Memory number	A.001
	Date and time	2020/4/20 13:00:00 (yyyy/mm/dd hh:mm)
	Resistance value	●.●●● mΩ
	Voltage value	●●.●● V
	Temperature	●●.●●°C
	Comparator threshold values	● mΩ, ● mΩ, ● V
	Comparison result	PASS, WARNING, or FAIL

## ● Measurement recording prompt **NEW** (p. 97)

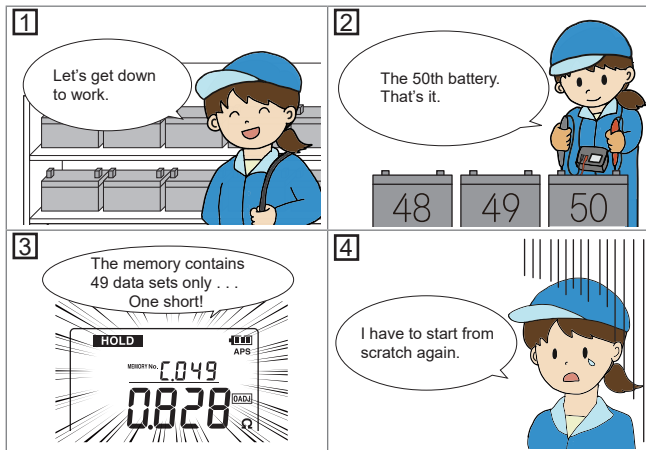

The measurement recording prompt uses voice prompts and the display to inform you of the battery number you are to measure next. You can get your jobs done neatly, which will no longer require you to start all over again.

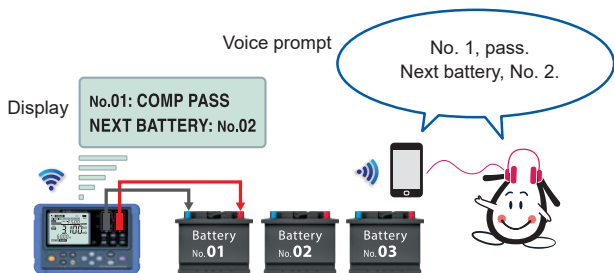



# Contents

<b>Battery Tester Quick Guide</b>	
<b>Introduction</b> .....	<b>1</b>
<b>Verifying Package Contents</b> .....	<b>3</b>
<b>Options</b> .....	<b>4</b>
<b>Safety Information</b> .....	<b>8</b>
<b>Operating Precautions</b> .....	<b>12</b>

## **1 Overview 23**

<b>1.1 Evaluating Battery Deterioration</b> .....	<b>23</b>
<b>1.2 Overview</b> .....	<b>26</b>
<b>1.3 Features</b> .....	<b>28</b>
<b>1.4 Names and Functions of Parts</b> .....	<b>30</b>
<b>1.5 Outer Dimension Drawing</b> .....	<b>38</b>

## **2 Preparing for Measurement 39**

<b>2.1 Installing/Replacing LR6 Alkaline Batteries</b> .....	<b>39</b>
<b>2.2 Attaching the Z5041 Protector</b> .....	<b>40</b>
<b>2.3 Connecting the Z3210 Wireless Adapter (Option)</b> .....	<b>41</b>
<b>2.4 Connecting the Test Lead</b> .....	<b>42</b>
Bundling up the Pin Type Lead and the 9466 Remote Control Switch .....	43
<b>2.5 Turning On/Off the Instrument</b> .....	<b>44</b>
<b>2.6 Setting the Date and Time</b> .....	<b>45</b>
<b>2.7 Attaching the Neck Strap</b> .....	<b>46</b>

<b>3</b>	<b>Measurement</b>	<b>47</b>
3.1	Inspection Before Measurement.....	48
3.2	Setting the Measurement Ranges .....	49
3.3	Noise-Frequency Reduction Function .....	51
3.4	Adjusting the Zero Point (Zero Adjustment) .....	52
	How to short-circuit various test lead .....	53
	Performing zero adjustment.....	56
	Troubleshooting on zero adjustment.....	58
	Canceling the zero adjustment .....	58
3.5	Using the Hold Function.....	59
	Disabling the hold function.....	59
	Freezing measured values using the 9466 Remote Control Switch .....	60
3.6	Automatic Hold Function .....	61
3.7	Determining Battery-Deterioration Evaluation Values.....	63
3.8	Measuring Batteries (Inspection) .....	64
	Measurement error .....	67
	Warning display .....	67
3.9	Measuring Temperature.....	68
<b>4</b>	<b>Comparator Function (Evaluation Based on Threshold Values)</b>	<b>69</b>
4.1	Overview .....	69
4.2	Enabling the Comparator Function .....	70
4.3	Setting Threshold Values for the Comparator .....	71
	Comparison table for the comparator .....	78
4.4	Setting the Comparator Buzzer .....	80
4.5	Canceling the Comparator Function .....	81

<b>5</b>	<b>Memory Function</b>	<b>83</b>
5.1	<b>Overview</b> .....	<b>83</b>
	Memory structure .....	83
	Profile information .....	84
5.2	<b>Saving Data in the Memory</b> .....	<b>87</b>
5.3	<b>Automatic Memory Function</b> .....	<b>89</b>
5.4	<b>Disabling the Memory Function</b> .....	<b>91</b>
5.5	<b>Reading Out Saved Data</b> .....	<b>92</b>
5.6	<b>Deleting Measured Data</b> .....	<b>94</b>
	Deleting a single measured data set .....	94
	Deleting all data contained in a unit.....	95
	Deleting entire data.....	96
<b>6</b>	<b>Measurement Recording Prompt Function</b>	<b>97</b>
6.1	<b>Preliminary Preparation</b> .....	<b>98</b>
	Transferring the profile information to the instrument .....	98
6.2	<b>Visual Prompt From the Instrument</b> .....	<b>100</b>
6.3	<b>Visual Prompt and Voice Prompt</b> .....	<b>103</b>
<b>7</b>	<b>Communications Function</b>	<b>105</b>
7.1	<b>Communicating With a Computer</b> .....	<b>107</b>
7.2	<b>Communicating With a Mobile Device</b> .....	<b>108</b>
	Enabling/disabling the wireless communications function .....	111
7.3	<b>Z3210-to-Excel® Direct Data Entry Function (Excel® Direct Input Function, HID Function)</b> .....	<b>112</b>
	Enabling/disabling the HID function.....	113

<b>8</b>	<b>Other Features</b>	<b>115</b>
8.1	<b>Backlight</b> .....	<b>115</b>
	Turning on/off the backlight.....	115
	Enabling/disabling automatic backlighting shutoff .....	115
8.2	<b>Automatic Power Saving Function (APS)</b> .....	<b>116</b>
8.3	<b>Instrument's Battery Level Indicator</b> .....	<b>118</b>
8.4	<b>System Reset</b> .....	<b>119</b>
	Default settings (Factory-configured settings) .....	120
<b>9</b>	<b>Specifications</b>	<b>121</b>
9.1	<b>General Specifications</b> .....	<b>121</b>
9.2	<b>Basic Specifications</b> .....	<b>123</b>
9.3	<b>Accuracy Specifications</b> .....	<b>125</b>
9.4	<b>Function Specifications</b> .....	<b>127</b>
9.5	<b>Default Settings and Resettable Settings</b> .....	<b>139</b>
<b>10</b>	<b>Maintenance and Service</b>	<b>141</b>
10.1	<b>Repair, Inspection, and Cleaning</b> .....	<b>141</b>
10.2	<b>Troubleshooting</b> .....	<b>143</b>
	Before returning the instrument for repair .....	143
10.3	<b>Error Messages</b> .....	<b>146</b>
10.4	<b>FAQ</b> .....	<b>148</b>
10.5	<b>Replacing the Fuse</b> .....	<b>149</b>
10.6	<b>Replacing the Tip Pin of the Test Lead</b> .....	<b>150</b>
10.7	<b>Disposing the Instrument (Removing the Lithium Battery)</b> .....	<b>153</b>

## **11 Appendix 155**

<b>11.1 Effects of Extending the Test Lead and Induced Voltage</b> .....	<b>155</b>
How to reduce induced voltages.....	155
<b>11.2 Effects of Eddy Currents</b> .....	<b>156</b>
<b>11.3 AC Four-Terminal Method Measurement</b> .....	<b>157</b>
<b>11.4 Effects of Current Density</b> .....	<b>159</b>
When an object under measurement is wide or thick .....	159
<b>11.5 Synchronous Detection</b> .....	<b>162</b>
<b>11.6 Calibration</b> .....	<b>164</b>
Calibrating the resistance measurement unit .....	164
Calibrating the voltage measurement unit .....	165



## **Index 167**

## **Warranty Certificate**



## Introduction

Thank you very much for choosing the Hioki BT3554-50, BT3554-51, BT3554-52 Battery Tester. To ensure your ability to get the most out of this instrument over the long term, please read this manual carefully and keep it available for future reference.

Model number (Order code)	Model name printed on the instrument	Standard accessory lead
BT3554-50		None
BT3554-51		9465-10 Pin Type Lead 
BT3554-52		L2020 Pin Type Lead 

Hereafter, the model number is referred to as the one that appears on the product, *BT3554-50*.

### Latest edition of instruction manual

The contents of this manual are subject to change, for example as a result of product improvements or changes to specifications.

The latest edition can be downloaded from Hioki's website.

<https://www.hioki.com/global/support/download>



## **Trademarks**

- Android, Google Play, and Google Chrome are trademarks of Google, Inc.
- IOS is a registered trademark of Cisco Systems, Inc. and/or its affiliates in the United States and certain other countries.
- Windows and Microsoft Excel are either registered trademarks or trademarks of Microsoft Corporation in the United States and other countries.
- The Bluetooth® word mark and logos are registered trademarks owned by Bluetooth SIG, Inc. and any use of such marks by Hioki E.E. Corporation is under license. Other trademarks and trade names are those of their respective owners.
- Other products and company names are trade names, registered trademarks, or trademarks of their respective owners.



## Verifying Package Contents

When you open the package, carefully inspect the instrument to ensure that everything is in good condition, and that no damage occurred during shipping. In particular, check the accessories, panel switches, and connectors. If the instrument seems to have been damaged or does not work as specified, contact your authorized Hioki distributor or reseller.

Confirm that these contents are provided.

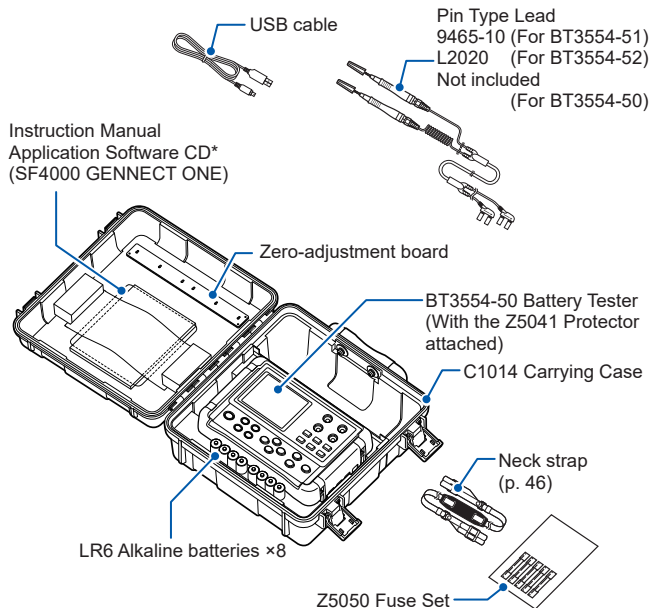

\*: The latest version can be downloaded from our website.

## Options

The options listed below are available for the instrument. To order an option, contact your authorized Hioki distributor or reseller. Options are subject to change. Please check Hioki's website for the latest information. Please check Hioki's website for the latest information.

### Model 9465-10 Pin Type Lead

This pin type lead has a four-terminal structure.



### Model L2020 Pin Type Lead

This pin type lead has a four-terminal structure and can be used for hard-to-reach measurement targets.



### Model 9465-90 Tip Pin

The 9465-90 is a replacement tip pin for the 9465-10 and L2020 Pin Type Lead.

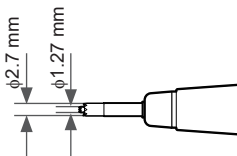

## Model 9772 Pin Type Lead

This pin type lead has parallel arranged pins. The pins possess high-strength wear-resistant. This lead, having the pins that can be inserted into a hole 5 mm in diameter, lets you perform measurement without removing terminal covers. You can also perform measurement in virtually any location because the pins can be inserted diagonally in hard-to-reach places.



## Model 9772-90 Tip Pin

The 9772-90 is a replacement tip pin for the 9772 Pin Type Lead.

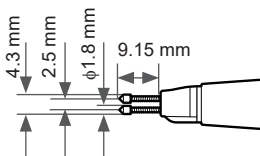

## Model 9460 Clip Type Lead with Temperature Sensor

Using the 9460 lets you measure resistance, voltage, and temperature simultaneously.

Clip (Black)

Temperature sensor



### Model 9466 Remote Control Switch

Attaching the 9466 to the test lead lets you freeze displayed values during measurement.

Supported models:

- Model 9465-10 Pin Type Lead
- Model 9772 Pin Type Lead
- Model L2020 Pin Type Lead

Mini plug  $\phi 2.5$  mm  
(Connect to EXT.HOLD)



### Model 9467 Large Clip Type Lead

The 9467 can clip on thick rodlike terminals of measurement targets. You can perform four-terminal measurement just by clipping the lead on to the target.

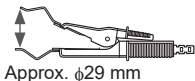

### Model 9451 Temperature Probe

(Cable length: 1.5 m)

Connect the 9451 to the TEMP. SENSOR terminal on the top face of the instrument.



**Model 9451S Temperature Probe**

Order code: 9451-01

(Cable length: 0.1 m)

Connect the 9451S to the TEMP. SENSOR terminal on the top face of the instrument.

**Model Z5038 0 Adj Board**

(For the 9465-10, L2020, and 9772)

Hook-and-loop fasteners are separately necessary to stick the Z5038 to the carrying case. Please use commercially available hook-and-loop fasteners.

**Model Z5050 Fuse Set**

Always use the specified fuse.

**Model Z3210 Wireless Adapter****Model C1014 Carrying Case****Model Z5041 Protector**

## Safety Information

This instrument is designed to conform to IEC 61010 Safety Standards, and has been thoroughly tested for safety prior to shipment. However, using the instrument in a way not described in this manual may negate the provided safety features. Carefully read the following safety notes before using the instrument.

### **DANGER**



Mishandling the instrument could result in bodily injury or even death, as well as damage to the instrument. Familiarize yourself with the instructions and precautions in this manual before use.

### **WARNING**



Electricity can potentially cause serious events such as an electric shock, heat generation, fire, and an arc flash due to a short-circuit. If you have not used any electrical measuring instruments before, you should be supervised by a technician who has experience in electrical measurement.

## Protective gear







### **WARNING**







Performing measurement using this instrument involves live-line work. To prevent an electric shock, use appropriate protective insulation and adhere to applicable laws and regulations.

## Symbols and abbreviations



In this document, the severity levels of risk and hazard are classified as follows.

 <b>DANGER</b>	Indicates an imminently hazardous situation that will result in death of or serious injury to the operator.
 <b>WARNING</b>	Indicates a potentially hazardous situation that may result in death of or serious injury to the operator.
 <b>CAUTION</b>	Indicates a potentially hazardous situation that may result in minor or moderate injury to the operator or damage to the instrument or malfunction.
<b>IMPORTANT</b>	Indicates information or content that is particularly important from the standpoint of operating or maintaining the instrument.
	Indicates useful advice concerning instrument performance and operation.
	Indicates a high voltage hazard. Failure to verify safety or improper handling of the instrument could lead to an electric shock, burn, or death.
	Indicates an action that must not be performed.
	Indicates an action that must be performed.
<b>HOLD</b>	Indicates a control key.
<b>[HOLD]</b>	Indicates elements on the display.

## Symbols on the instrument

	Indicates the presence of a potential hazard. When the symbol is printed on the instrument, refer to a corresponding topic in the Instruction Manual.
	Indicates a fuse.
	Indicates a grounding terminal.
	Indicates DC (Direct Current).
	Indicates the power button that switches the instrument between on and off states.

## Symbols for various standards

	Indicates that the product is subject to the Waste Electrical and Electronic Equipment (WEEE) Directive in EU member nations. Dispose of the product in accordance with local regulations.
	Indicates that the product complies with standards imposed by EU directives.

## Character expression

The instrument's display expresses the alphanumeric characters as



follows.

A	B	C	D	E	F	G	H	I	J	K	L	M	N	O	P	Q	R	S	T	U	V	W	X	Y	Z
A	b	C	d	E	F	G	H	I	J	K	L	M	N	O	P	Q	R	S	T	U	V	W	X	Y	Z

1	2	3	4	5	6	7	8	9	0
1	2	3	4	5	6	7	8	9	0

Some different expressions are used as below:

<i>Clr Unit</i>	Indicates that the saved data has been deleted.
<i>FAIL</i>	Indicates that the comparator buzzer is set to FAIL.
<i>Error Adc</i>	Indicates that the A/D converter communications error occurs.

## Accuracy labeling

The instrument accuracy is expressed by defining a percentage of the reading and a limit value for errors in terms of digits.

<b>reading</b>	<b>Display value</b> Indicates the value displayed by the instrument. Limit values for reading errors are expressed as a percentage of the reading ("% of reading").
<b>digits</b>	<b>Resolution</b> Indicates the minimum display unit (in other words, the smallest digit that can have a value of 1) for a digital measuring instrument. Limit values for digit errors are expressed using digits.

## Operating Precautions

Observe the following precautionary information to ensure that the instrument can be used safely and in a manner that allows it to perform as described in its specifications.

Use of the instrument should confirm not only to its specifications, but also to the specifications of all accessories, options, LR6 Alkaline batteries, and other equipment in use.

### Installing the instrument

#### CAUTION

Installing the instrument in inappropriate locations could cause a malfunction of the instrument or an accident.

- Exposed to direct sunlight or high temperature
- Exposed to corrosive or combustible gases
- Exposed to a strong electromagnetic fields or electrostatic charges
- Near induction heating systems (such as high-frequency induction heating systems and IH cooking equipment)
- Susceptible to vibration
- Exposed to water, oil, chemicals, or solvents
- Exposed to high humidity or condensation
- Exposed to high concentrations of dust particles

Do not place the instrument on an unstable or uneven surface. Doing so could cause the instrument to fall or turn over, causing bodily injury or damage to the instrument.

## Preliminary checks

### **DANGER**

If the test lead or the instrument is damaged, there is a risk of an electric shock. Perform the following inspection before use:



- Check that the insulation of the test lead is neither ripped nor torn and that no metal parts are exposed. Replace the test lead with a one specified by Hioki.
- Check the instrument for any damage that may have occurred during storage or shipping, and perform functional checks before use. If you find any damage to the instrument, please contact your authorized Hioki distributor or reseller.

## Precautions for Transportation

During shipment of the instrument, handle it carefully so that it is not damaged due to a vibration or shock.

## Handling the instrument

### **DANGER**



To prevent an electric shock, do not remove the instrument's case. The internal components of the instrument carry high voltages and may become very hot during operation.

### **CAUTION**



To avoid damage to the instrument, do not subject it to vibration or mechanical shock during transportation and handling. Exercise particular care to avoid subjecting the instrument to mechanical shock, for example by dropping.

## Precautions for measurement

**⚠ DANGER**

To prevent an electric shock, be careful to avoid shorting live lines with the test lead tip.

**⚠ WARNING**

- Do not use the instrument to measure circuits that exceed its ratings or specifications. Damage to the instrument can cause an electric shock.
- Do not measure any voltage that would exceed the instrument's maximum input voltage (terminal-to-terminal) or maximum rated line-to-ground voltage of 60 V.



Maximum input voltage  
(terminal-to-terminal)

60 V DC

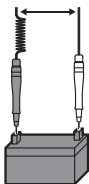

Maximum rated  
voltage to earth

60 V DC

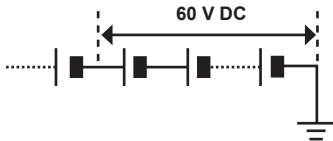

- Do not measure AC voltage.

## **WARNING**



- **Connect the test lead correctly.**
- **Wear gloves of rubber or similar material during measurement.**
- **Ventilate the rooms where batteries have been installed before measuring batteries to prevent explosions. Sparks may occur when a test lead is connected to a battery to be measured, which can ignite any accumulated inflammable gases such as hydrogen.**

## **CAUTION**



After measuring a high-voltage battery, first short-circuit the test lead to discharge the DC elimination capacitor connected across the lead before continuing to measure a low-voltage battery. Otherwise the low-voltage battery may be subject to an excess voltage, causing damage to the battery.



To avoid damage to the instrument, do not apply voltage to the EXT.HOLD and TEMP.SENSOR terminal.

**IMPORTANT**

- Do not place the test lead in contact with the measurement terminals of a leaky battery. Doing so may cause a degradation in the instrument functionality due to exposure to electrolyte from the leaky battery.
- Subjecting the test lead to an excessive common-mode voltage could cause the following issues:
  - (1) Unstable measured values
  - (2) Wire-break detection display ([-----])Attaching ferrite cores around the test lead or placing the instrument some distance away from the floor may have a lightening the effect.

### IMPORTANT

- If there is a potential difference between the SOURCE- terminal and SENSE - terminal or between the SOURCE + terminal and SENSE + terminal, the instrument cannot perform correct measurement.

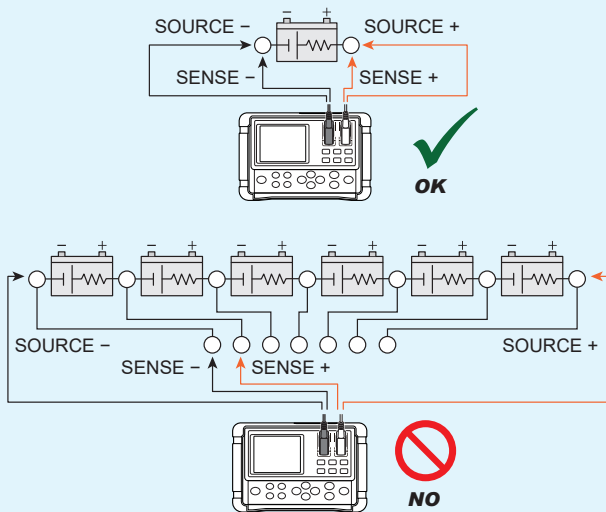



## Handling the test lead

### CAUTION

Do not subject the pin type lead tip to force when it is in contact with the battery under measurement at a tilted angle.



Avoid subjecting the temperature probe tip to physical shock, and avoid sharp bends in the lead. These may damage the probe or break a wire.

### IMPORTANT

Use only the Hioki-specified test lead. Using another test lead may result in incorrect measurements due to loose connections or other reasons. Besides, Hioki does not guarantee the accuracy and proper operation.

## Zero-adjustment board

### WARNING



To prevent short-circuit accidents, do not place the zero-adjustment board on top of a battery under measurement.

## Instrument's batteries and fuse

### **WARNING**

- To avoid an electric shock, disconnect the test lead from the object under measurement before open the cover to replace the LR6 Alkaline batteries or fuse.
- To prevent instrument damage or an electric shock, use only the screw for securing the fuse cover in place that is originally installed. If you have lost the screw or find that the screw is damaged, please contact your Hioki distributor for a replacement.
- Use a fuse only specified by Hioki.



Failure to observe this could damage the instrument, resulting in bodily injury.

Specified fuse: Model Z5050 Fuse Set (216.630, Littelfuse Inc., fast-acting, rating: 250 V / F 630 mA, interrupting rating: 1500 A)

- Do not short-circuit, recharge, or disassemble LR6 Alkaline batteries, or dispose of them in fire. Batteries may explode if mistreated.
- Do not use the instrument with the fuse holder short-circuited.



Failure to observe this could damage the instrument, resulting in bodily injury.

 **CAUTION**

Poor performance or damage from LR6 Alkaline battery leakage could result. Observe the cautions listed below:

- Do not mix old and new LR6 Alkaline batteries, or different types of LR6 Alkaline batteries.
- Be careful to observe the battery polarity during installation.
- Do not use LR6 Alkaline batteries after their recommended expiry date.
- Do not allow weak LR6 Alkaline batteries to remain in the instrument.
- Replace LR6 Alkaline batteries only with ones of the specified type.
- Remove the LR6 Alkaline batteries from the instrument if they are to be stored for a long time.



Handle and dispose of LR6 Alkaline batteries in accordance with local regulations.

### **Precautions related to use of the CD**

- Exercise care to keep the recorded side of the disc free of dirt and scratches. When writing text on the disc's label, use a pen or marker with a soft tip.
- Keep the disc inside a protective case and do not expose to direct sunlight, high temperature, or high humidity.
- Hioki is not liable for any issues your computer system experiences in the course of using this disc.



## 1.1 Evaluating Battery Deterioration

**IMPORTANT**

To evaluate whether batteries have deteriorated, first measure the internal resistance of a fresh or non-defective battery.

If a battery has deteriorated, the internal resistance will increase by 50 to 100 percent (value for reference purposes) from its initial value.

The graph below shows the relation between the amount of battery charge available and the initial value of internal resistance in a lead-acid battery. “CS,” “HS,” and “MSE” denote lead-acid battery types according to Japanese Industrial Standard (JIS).

The internal resistance of an MSE (sealed stationary lead-acid battery) can be graphically read at **approximately 1 mΩ (100 Ah)** and **approximately 0.13 mΩ (1000 Ah)**.

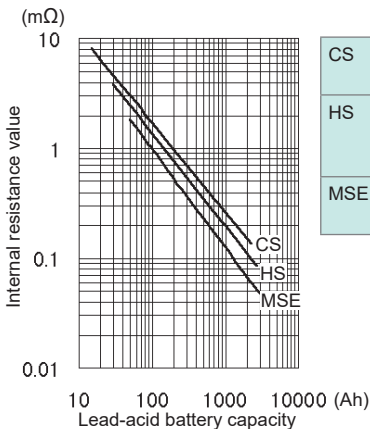

CS	Clad-type stationary lead-acid battery
HS	High-rate-discharge paste-type stationary lead-acid battery
MSE	Sealed stationary lead-acid battery

- For an MSE (sealed stationary lead-acid battery), the warning threshold (WARNING) of the internal resistance is defined as about 1.5 times its initial value. The rejection value (FAIL) varies depending on the manufacturer.
- Initial values of internal resistance may vary among batteries under measurement with the same capacity, depending on the model or manufacturer. Use the graph on the previous page for reference purposes.
- Warning thresholds (WARNING) and rejection values (FAIL) of internal resistance vary depending on the manufacturer.

Source: Battery technician certification textbook, Battery Association of Japan (BAJ)



The battery measurement values can be compared with the present threshold values using the comparator function to determine the scope in which the values fall within: PASS, WARNING, or FAIL.

See “4 Comparator Function (Evaluation Based on Threshold Values)” (p. 69).

Changes in the internal resistance of open (liquid) stationary lead-acid batteries, including CS and HS, and alkaline lead-acid batteries, may be smaller than sealed lead-acid batteries. Thus, it is sometimes difficult to determine whether such batteries have been deteriorated.

### **Measuring lithium-ion batteries**

The instrument measures internal resistance and voltage of batteries using AC having a frequency of 1 kHz. The internal resistance of lithium-ion batteries can also be measured; however, that of a packed battery will include the protective resistance, which is installed in packed batteries. Besides, the instrument may not be able to diagnose and evaluate the deterioration of such batteries because changes in the internal resistance of lithium-ion batteries due to deterioration may be smaller than lead-acid batteries.

## 1.2 Overview

The instrument measures internal resistance, voltage, and terminal temperature of lead-acid, nickel-cadmium, nickel-hydrogen, and other types of batteries, enabling you to determine if batteries have deteriorated.

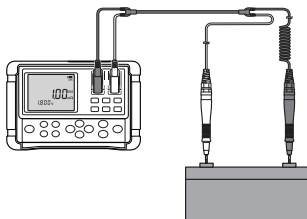

To measure terminal temperature, the 9460 Clip Type Lead with Temperature Sensor (option) is required. To measure an ambient temperature, the 9451/9451S Temperature Probe (option) is required.

After measurement, connecting the instrument to your computer with the accompanying USB cable enables measured data transfer to the computer. Also, you can browse through and record measured data on your smart phone or tablet using the wireless communications function.



Using the wireless communications function requires the Z3210 Wireless Adapter.

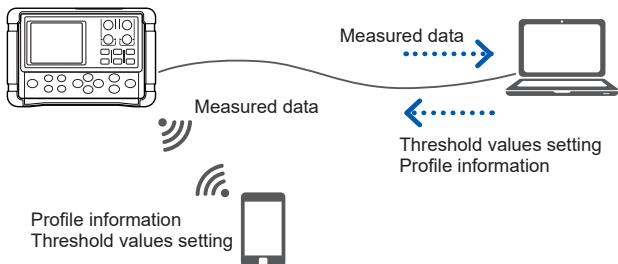

## 1.3 Features

### ● **Facilitated data management**

**Measured data can be saved in connection with profile information.** **NEW**

The instrument can save up to 6000 data sets consisting of presently measured data (resistance, voltage, temperature, comparison result). This equates to up to 12 units, each of which consisting of 500 cell cubicles.

The instrument can be populated 100 sets of profile information (comments, such as location information and device information, and the battery number information).

Saving measured data in connection with profile information makes it possible for you to manage measurement locations, UPSs, and batteries easily.

### ● **Measurement recording prompt** **NEW**

The instrument and your mobile device with GENNECT Cross installed, using the display and voice prompts, respectively, can inform you of comparison results and the battery number you are to measure next. This enables you to record measured data quickly.

### ● **Automatic hold function and automatic memory function**

When these functions are enabled, the instrument can automatically, at the instance when the display freezes measured values, save the measured values in its internal memory. This can lead to increased operational efficiency.

### ● **Measurement without the need for UPS system shutdown**

The instrument uses high-precision AC low-resistance measurement technology and noise reduction technology. Time

required for measurement will be reduced since the instrument is capable of measuring live wires without requiring a UPS system shutdown.

### ● **Reliable measured values**

The instrument is capable of obtaining reliable measured values without being affected by wire resistance of the test lead or contact resistance because it uses the AC four-terminal method to measure internal resistance.

### ● **Simultaneous display of resistance, voltage, and temperature**

Without switching functions, the instrument can display battery internal resistance, voltage, and terminal temperature simultaneously. To measure terminal temperature, the 9460 Clip Type Lead with Temperature Sensor (option) is required. To measure an ambient temperature, the 9451/9451S Temperature Probe (option) is required.

### ● **Comparator function**

The comparator function enables you to set threshold values for internal resistance and voltage. This can evaluate whether batteries have deteriorated more easily.

### ● **Computer interface**

Measured data can be transferred to your computer.

### ● **Wireless communications function**

Connecting the Z3210 Wireless Adapter (option) enables you to browse through and record measured values with your smart phone and tablet.

You can utilize the measurement recording prompt in sync with your mobile device with GENNECT Cross installed.

## 1.4 Names and Functions of Parts

### Front (1)

Display (p. 34)

SOURCE -







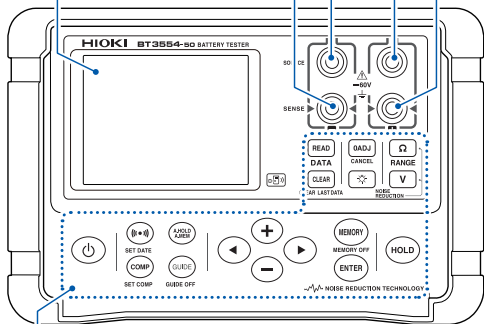



SOURCE +

SENSE -

SENSE +



Operation keys

Key name	Pressing once	Holding down for at least 1 s.	Turning on instrument while holding down
	-	Turns on/off instrument.	-
 SET DATE	Enables/disables comparator buzzer.	Allows you to confirm and set date and time.	Enables/disables Z3210 HID setting.
 SET COMP	Enables/disables comparator. Allows you to set comparator number.	Allows you to set comparator threshold values.	-
	Enables/disables automatic hold. Enables/disables automatic memory.	-	Disables wire-break detection.
 GUIDE OFF	Starts measurement recording prompt.	Stops measurement recording prompt.	-
	Allows you to modify various setting values.	-	-
	Switches settings. Moves digit focus.	-	-
 MEMORY OFF	Enables memory function. Saves measured values.	Disables memory function.	-
	Confirms your entry.	-	Displays serial number.
	Freezes measured value. Disable hold function.	-	Enables/disables automatic power saving.

## Front (2)

Display (p. 34)

SOURCE -







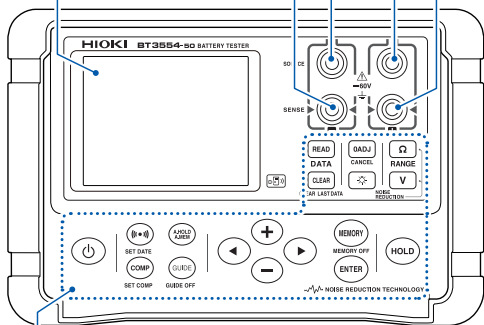

SOURCE +

SENSE -





SENSE +



Operation keys

Key name	Pressing once	Holding down for at least 1 s.	Turning on instrument while holding down
	Loads/cancels saved measured values.	-	-
 CLEAR LAST DATA	Deletes various settings.	Deletes latest saved data.	Resets system.
 CANCEL	Performs zero adjustment.	Cancels zero adjustment.	-
	Turns on/off backlight.	Enables/disables wireless communications.	Enables/disables automatic backlighting shutoff.
	Switches resistance ranges.	Enables/disables noise-frequency reduction. (While pressing the  key)	-
	Switches voltage ranges.	Enables/disables noise-frequency reduction. (While pressing the  key)	Shows all LCD segments.

## How to toggle the temperature measurement units

- 1 While holding down the , , and  keys, turn on the instrument.
- 2 Holding down the  key for 3 s to toggle between Celsius and Fahrenheit.
- 3 Press the  key to confirm your choice.

## Display

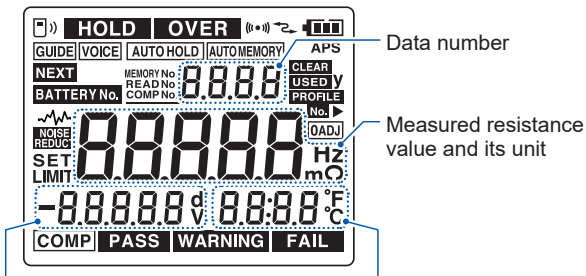

Measured voltage value  
and its unit

Measured temperature  
value and its unit

	Wireless communications function enabled.	<b>CLEAR</b>	Memory deleted.
<b>HOLD</b>	Freezes measured values.	<b>USED</b>	Chosen memory number occupied.
<b>OVER</b>	Input overflows.	<b>PROFILE</b>	Chosen memory number contains profile information.
	Comparator buzzer enabled.	<b>No.</b>	Profile number
	Communicating through USB.	<b>OADJ</b>	Zero adjustment enabled
	Instrument's battery level		Noise-frequency reduction enabled.
<b>GUIDE</b>	Measurement recording prompt enabled.	<b>SET</b>	Function being set.



<b>VOICE</b>	Measurement recording voice prompt enabled.	<b>LIMIT</b>	Comparator threshold values being set.
<b>AUTO HOLD</b>	Automatic hold enabled.	<b>COMP</b>	Comparator enabled.
<b>AUTO MEMORY</b>	Automatic memory enabled.	<b>PASS</b>	PASS judgment given.
<b>APS</b>	Automatic power saving enabled.	<b>WARNING</b>	WARNING result given.
<b>NEXT BATTERY No.</b>	Next battery number to be measured and recorded (When measurement recording prompt enabled)	<b>FAIL</b>	FAIL judgment given.
<b>MEMORY No.</b>	Memory number to be saved		
<b>READ No.</b>	Memory number to be loaded		
<b>COMP No.</b>	Comparator number		

When all segments on the display are shown, segments other than those listed above also appear, which are not used.

## Top

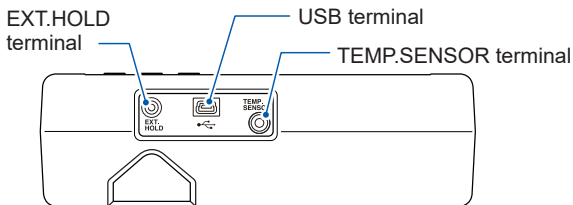

EXT.HOLD terminal	Connect the 9466 Remote Control Switch (option) here.
USB terminal	Connect the USB cable here.
TEMP.SENSOR terminal	Connect the mini plug of the 9460 Clip Type Lead with Temperature Sensor (option) here. Connect the 9451/9451S Temperature Probe here.

## Rear

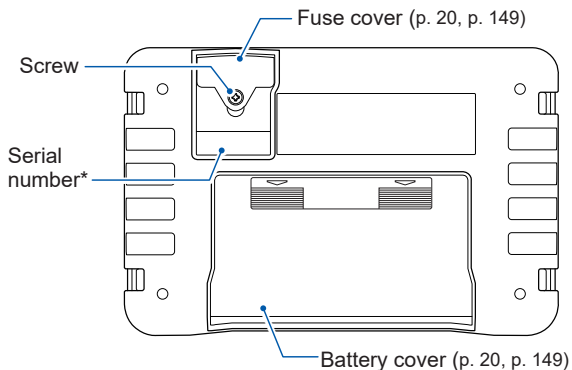

\*: The serial number consists of nine digits. The first two (from the left) indicate the year of manufacture, and the next two indicate the month of manufacture. Required for production control. Do not peel off the label.

## 1.5 Outer Dimension Drawing

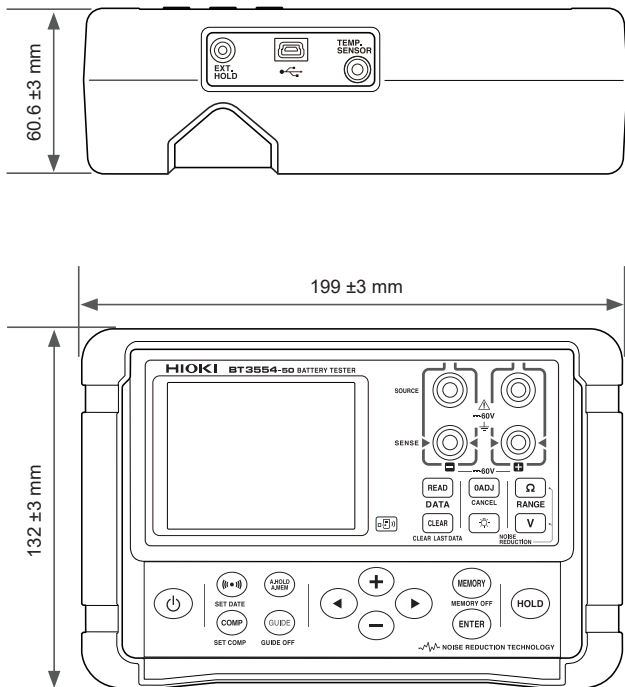

## 2

# Preparing for Measurement

## 2.1 Installing/Replacing LR6 Alkaline Batteries

When using the instrument for the first time, insert eight LR6 Alkaline batteries. Before attempting measurement, check the instrument's battery level. If the instrument's batteries are running low, replace the LR6 Alkaline batteries with fresh ones.

When the  segment blinks, which indicates that the instrument's batteries are running low, replace them as soon as possible.

- 1 Turn off the instrument and remove the test lead.**

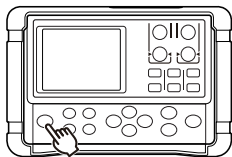

1

- 2 Remove the battery cover on the rear of the instrument.**
- 3 Ensure correct polarity and insert eight LR6 Alkaline batteries.**
- 4 Install the battery cover.**

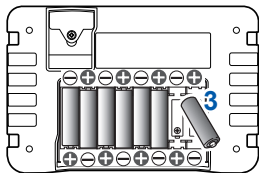

4 ↑ ↓ 2

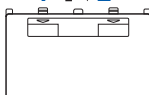

The batteries can continuously provide power to the instrument with the Z3210 not installed for about 8.3 hours (with the Z3210 installed for communications, about 8.2 hours).

## 2.2 Attaching the Z5041 Protector

If the Z5041 Protector has been removed from the instrument, attach it by following the instruction below.

- 1** Turn off the instrument and remove the test lead.
- 2** Insert the instrument into the Z5041 Protector.

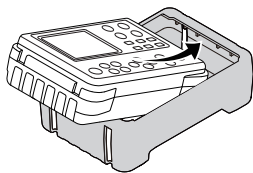

Observe the proper orientation.

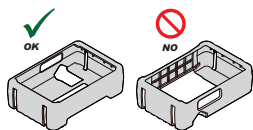

- 3** Push the instrument into the Protector in the direction of the arrow.

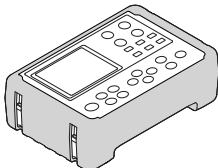
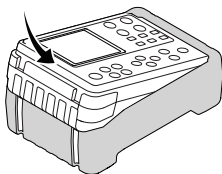

(Completed)

## 2.3 Connecting the Z3210 Wireless Adapter (Option)

Installing the Z3210 Wireless Adapter (option) in the instrument lets you use the wireless communications function.

See “7.2 Communicating With a Mobile Device” (p. 108).

### ⚠ WARNING



**Turn off the instrument and remove the test lead.**  
Failure to do so could cause an electric shock.

### ⚠ CAUTION



**Before handling the Z3210, eliminate static electricity from your body by touching any metallic part, such as a doorknob.**

Failure to do so could cause static electricity to damage the Z3210.

- 1** Turn off the instrument and remove the test lead.
- 2** Remove the Z5041 Protector while pressing down it as shown.
- 3** Remove the protective cap with a flathead screw driver.
- 4** Insert the Z3210, observing the correct orientation, as far as it will go.
- 5** Attach the Protector.

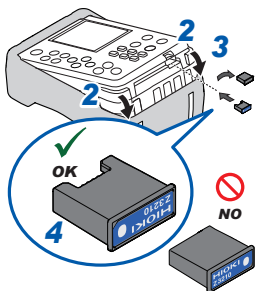

- Store the removed protective cap.
- When removing the Z3210, install the protective cap.

## 2.4 Connecting the Test Lead

### WARNING



To avoid an electric shock, be sure to connect the test lead properly.

This section describes how to connect the test lead to the instrument. Connect the test lead's connectors to all four terminals: the SOURCE terminals (positive and negative) and the SENSE terminals (positive and negative).

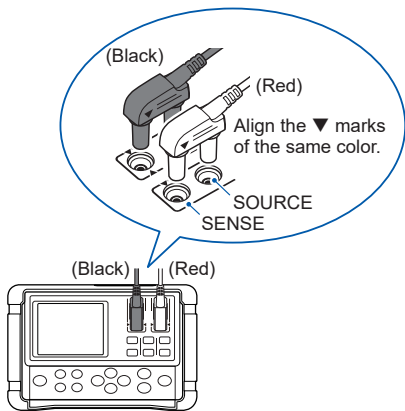

When using the 9460 Clip Type Lead with Temperature Sensor (option), connect the mini plug to the TEMP.SENSOR terminal. See "3.9 Measuring Temperature" (p. 68).



## Bundling up the Pin Type Lead and the 9466 Remote Control Switch

You can bundle up the Pin Type Lead (the 9465-10, 9772, L2020) and the 9466 Remote Control Switch (option). Attach the Remote Control Switch to the probe of the Pin Type Lead. Bundle up the two cables using the spiral tubes.

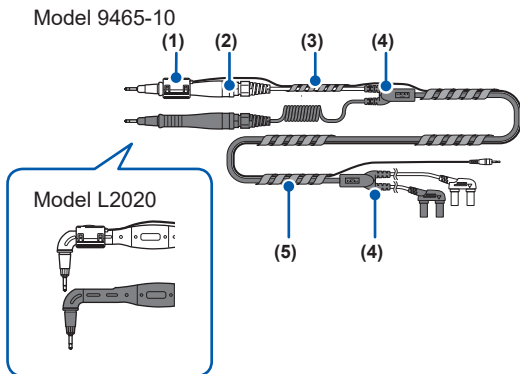

(1)	Model 9466 Remote Control Switch
(2)	Probe
(3)	Spiral tube (small) Bundle up the cables at the center of the lead between the probe and probe-side junction with the spiral tube.
(4)	Junctions
(5)	Spiral tubes (large) Bundle up the cables between the junctions if you wish.

## 2.5 Turning On/Off the Instrument

Hold down the  key for at least 1 s to turn on/off the instrument.

Confirm the date and time settings when using the instrument for the first time.

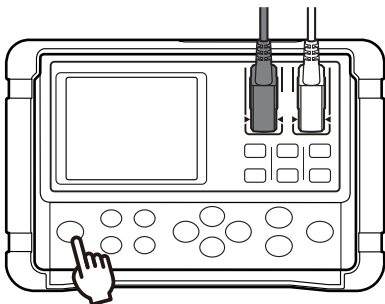

Hold down for at least 1 s.

When the  segment blinks, which indicates that the instrument's batteries are running low, replace them as soon as possible.

See “9.5 Default Settings and Resettable Settings” (p. 139).

## 2.6 Setting the Date and Time

The instrument can show the date and time. Confirm the date and time settings when using the instrument for the first time. The time is displayed using a 24-hour clock. The instrument's calendar can automatically recognize leap years.

1



(Hold down for at least 1 s.)

Let the date and time appear.

Holding down the key at least 1 s again will hide the date and time.



2

2



Enter the date and time (in the yyyy/mm/dd hh:mm format).

3



Confirm your entry.

Date and time will not be set if you switch over the display from the clock setup mode without pressing the **ENTER** key.

**Tips**

You can also set the date and time using GENNECT ONE or GENNECT Cross.

## 2.7 Attaching the Neck Strap

You can hang the instrument from your neck using the neck strap. Attach the neck strap as described below.

- 1 Turn off the instrument and remove the test lead.**
- 2 Pass the webbing through the openings of the instrument and fix the webbing with the tri-glide slides.**  
(There are two openings on each of the left and right side)
- 3 Adjust the length of the neck strap.**

You can put the instrument in the carrying case with the neck strap attached.

- 4 Check that the neck strap is not removed even if you pull it.**

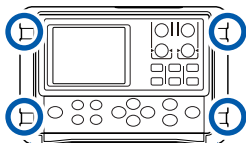

Face the webbing through the tri-glide outside.





To ensure safe operation, be sure to read “Operating Precautions” (p. 12) before starting the measurements.

- There is a considerable difference in the battery's internal resistances between a full-charge state and a discharge state. To improve evaluation accuracy, perform measurements under a constant condition (for example, in a full-charge state).
- Terminals of lead-acid batteries (objects under measurement) have a high resistance. Thus, resistance values may differ between contact locations, the case side and the tip of the terminals. Place the test lead into contact with the terminals at the same location every time.  
See “11.4 Effects of Current Density” (p. 159).
- Use the 9460 Clip Type Lead with Temperature Sensor (option) to measure the temperature of the battery terminals. Otherwise, use a non-contact thermometer, such as a radiation thermometer, for safety.
- If terminals are covered with an insulating layer, the measurement current cannot flow sufficiently, resulting in measurement failure. In such a case, clean the terminals to remove the insulation layer before measurement.

## 3.1 Inspection Before Measurement

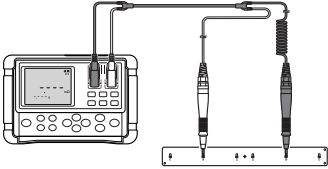
Check the instrument for any damage that may have occurred during storage or shipping, and perform functional checks before use. If you find any damage to the instrument, please contact your authorized Hioki distributor or reseller.

Inspection item	Checking method
Has the fuse blown?	Place the test lead into contact with the zero-adjustment board. If the resistance readout remains the [----] segments, the fuse may have blown or the test lead may have broken. Replace the fuse or test lead with a new one.
Has the test lead broken?	
Does the instrument's battery level remain enough?	The display, in the top right, includes the battery level indicator  for the instrument's batteries. If the indicator exhibits  , the batteries should be replaced early. Please have spare LR6 Alkaline batteries ready.
Inspecting batteries to be measured	If terminals are covered with an insulating layer, the measurement current cannot flow sufficiently, resulting in measurement failure. In such a case, clean the terminals to remove the insulation layer before measurement.

## 3.2 Setting the Measurement Ranges

This section describes how to set resistance and voltage measurement ranges.

Resistance ranges	3 m $\Omega$ , 30 m $\Omega$ , 300 m $\Omega$ , 3 $\Omega$
Voltage ranges	6 V, 60 V
Temperature range	(Single range) Since the instrument has a single temperature measurement range, setting the temperature range is not required.

Press the  **$\Omega$**  key or **V** key to display the present settings. Press the key repeatedly to cycle through the ranges.

## Resistance ranges

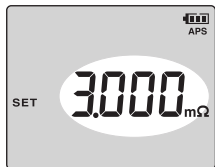
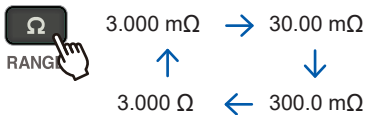

## Voltage ranges

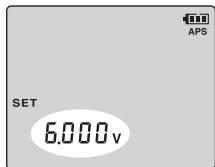

After a certain period of inactivity, the instrument will confirm your entry and the display will return to measurement mode.



### 3.3 Noise-Frequency Reduction Function

Enabling the noise-frequency reduction function can reduce the effects of noise exhibited in measurement environments, resulting in smaller variation in measured values. Resistance measured values will become more stable.

(Noise reduction technology)

Noise-frequency reduction function disabled

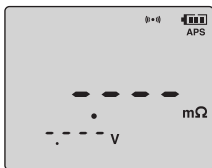

Noise-frequency reduction function enabled

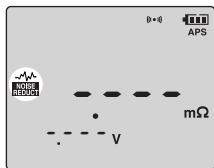

When the  segment pops up:

The noise-frequency reduction function is enabled.

When the  segment is blinking:

The noise frequencies are being avoided.

#### Disabling the noise-frequency reduction function

Cycling the instrument will disable the function.

- It may take longer to perform measurement with the noise-frequency reduction function enabled.

This time, the instrument will blink the  segment.

- It may not be possible to avoid all noise depending on the noise frequency.

## 3.4 Adjusting the Zero Point (Zero Adjustment)

When the zero adjustment function is executed, the instrument will regard the measured values (correction values) as zero to display subsequent measurement results.

Only if an accessory or optional test lead is used, the instrument can meet the accuracy specifications even without executing the zero adjustment.

However, execute the zero adjustment in the following cases:

- When you wish to increase measurement accuracy  
For the 3 m $\Omega$  range, the accuracy specifications differ depending on whether zero adjustment has been performed.  
See “9.3 Accuracy Specifications” (p. 125).
- When using a test lead, including Hioki product, that is not an accessory or option of the instrument or whose length has been extended

### IMPORTANT

Use only the Hioki-specified test lead. Hioki does not guarantee the accuracy and proper operation if any test lead not specified by the company is used.

- Performing zero adjustment adjusts the zero points of all ranges.
- Even after the instrument has been turned off, the correction values will be retained and with the zero adjustment function remaining enabled.
- After replacing the test lead, always perform zero adjustment prior to measurement.
- Always use the included or optional zero-adjustment board when performing zero adjustment.
- Keep the test lead short-circuited during zero adjustment.
- Keep the tips of the test lead away from any metal components.

## How to short-circuit various test lead

### For Pin Type Lead

Use the included or optional zero-adjustment board. The zero adjustment can be achieved based on the AC four-terminal method.

- 1 Choose two holes on the zero-adjustment board whose interval is nearly equal to the distance between the two terminals on a battery to be measured.

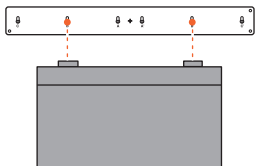

3

- 2 Press the test lead against the zero-adjustment board in a vertical direction.

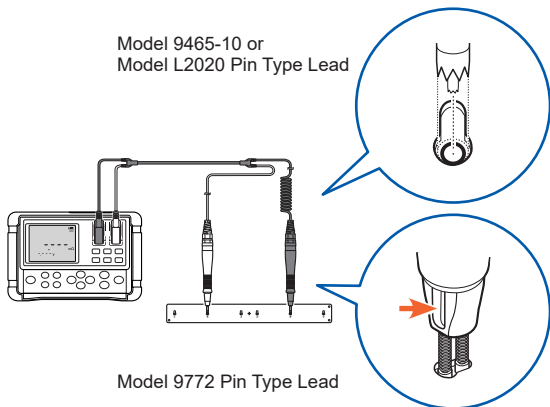

Insert the pins with the marked (engraved) side of the probe facing you.

- Keep the zero-adjustment board at least 10 cm away from the instrument.
- Always use the accompanying or optional zero-adjustment board when performing zero adjustment.
- Insert the pin tips into the hole on the zero-adjustment board and place each of the SOURCE and SENSE terminals into contact with the hole on the board. (See the figure below.)

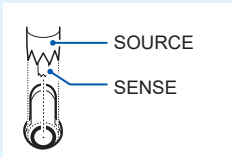

- Do not place the zero-adjustment board on top of the battery or any metal. Electromagnetic induction effect could result in unstable measurement values. In such a case, keep the zero-adjustment board away from any metal.
- If zero adjustment is performed with the Pin Type Lead short-circuited at the tips or using a metal sheet other than the zero-adjustment board intended for this purpose, the instrument cannot adjust the zero point accurately.
- When the distance between the terminals on the battery (target under measurement) is more than that between the holes on the zero-adjustment board, use the outermost holes to perform zero adjustment.
- Consider the zero-adjustment board to be a consumable. It is recommended to replace it with a new one after the use of around 700 times.

## For Clip Type Lead

Engage the red and black clips together, and then perform zero adjustment.

### Model 9460 Clip Type Lead with Temperature Sensor

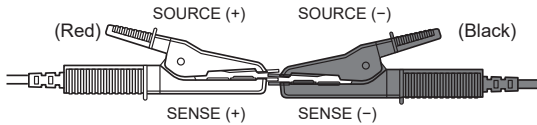

### Model 9467 Large Clip Type Lead

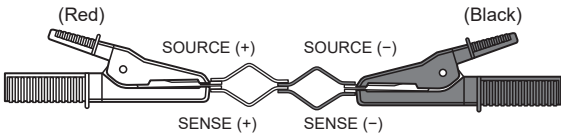

## Performing zero adjustment

- 1 Check if the test lead has been connected properly.

Disconnect the test lead from the measurement target if connected.

- 2 Press the **0ADJ** key.

The instrument will be put on standby for acquiring the correction value.

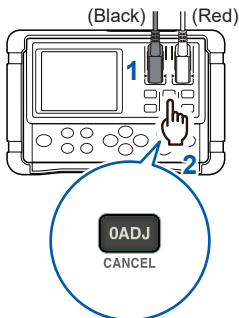

- 3 While the **[0AdJ]** segment is blinking, short-circuit the test lead using the zero-adjustment board.

See "How to short-circuit various test lead" (p. 53).

Failure to short-circuit the test lead while the display is blinking will result in an error.

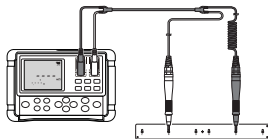

For Pin Type Lead

The instrument will automatically start obtaining correction values.

When the zero adjustment has been completed, the instrument will display the **[0ADJ]** segment and return the display to measurement mode.

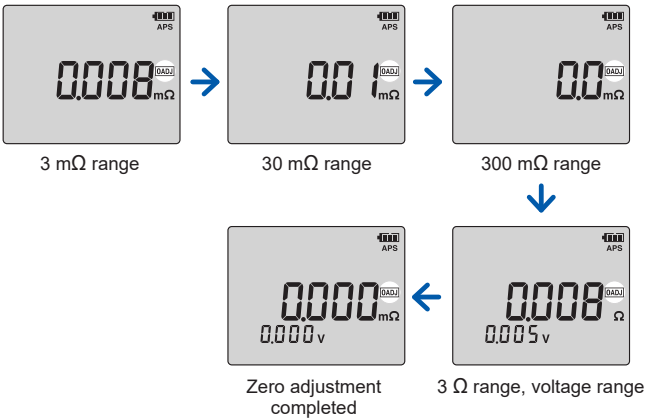

3

- Keep the test lead short-circuited until the zero adjustment is completed.
- The zero adjustment will start even if the key is pressed after the test lead has been short-circuited.

## Troubleshooting on zero adjustment

Check item	Solution
Has the fuse blown?	Check if the fuse has blown. (p. 149)
Do the obtained correction values exceed 300 counts in either resistance or voltage range?	Reconnect the test lead to the instrument.
	The test lead may be broken. Replace the fuse or test lead with a new one.
	Remove dirt from the zero-adjustment board.
Did you short-circuit the test lead properly while the instrument was in standby for obtaining correction values?	While the instrument is in standby for obtaining correction values (for about 10 s), short-circuit the test lead using the zero-adjustment board to perform zero adjustment.

## Canceling the zero adjustment

Press the **0ADJ** key for at least 1 s with the zero adjustment function enabled to cancel the zero-adjustment.

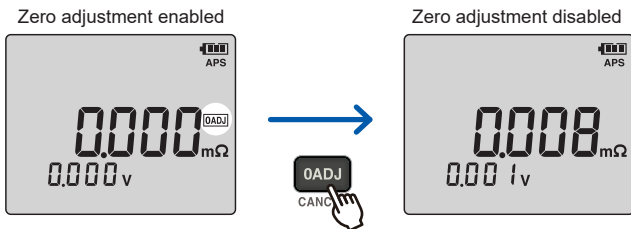

Hold down for at least 1 s.



## 3.5 Using the Hold Function

This section describes how to freeze measured values on the display using the hold function. Press the **HOLD** key. The **[HOLD]** segment will appear and the display will freeze measured values.

- When a warning display appears or the voltage readout exhibits the [----] segments, the instrument cannot freeze the displayed value.
- When you change any settings, the instrument will disable the hold function.
- Turning off the instrument will disable the hold function.



Using the automatic hold function can automatically freeze measured values after they have stabilized.  
See "3.6 Automatic Hold Function" (p. 61).

Hold function disabled

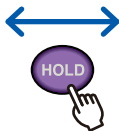

Hold function enabled

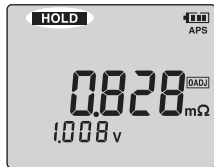

### Disabling the hold function

Press the **HOLD** key again to disable the hold function.

## Freezing measured values using the 9466 Remote Control Switch

The 9466 Remote Control Switch (option) is available for the operation in the same way as when using the **HOLD** key.

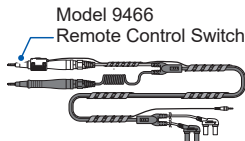

- 1 Disconnect the test lead from the battery under measurement.
- 2 Insert the mini-plug of the 9466 Remote Control Switch into the EXT.HOLD terminal.

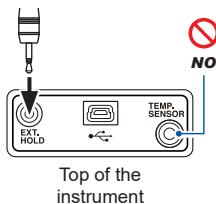

- 3 Connect the connectors of the test lead to the instrument.

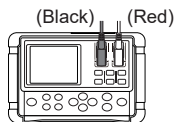

- 4 Press the **PRESS** button on the 9466 Remote Control Switch.

The instrument will freeze measured values.

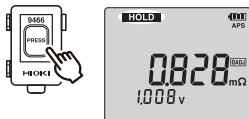

### Disabling the hold function

Press the **PRESS** button on the 9466 Remote Control Switch or the **HOLD** key on the instrument.

## 3.6 Automatic Hold Function

This section describes how to automatically freeze measured values after they have stabilized.

Press the **A.HOLD/A.MEM** key several times to display the **[AUTO HOLD]** segment.

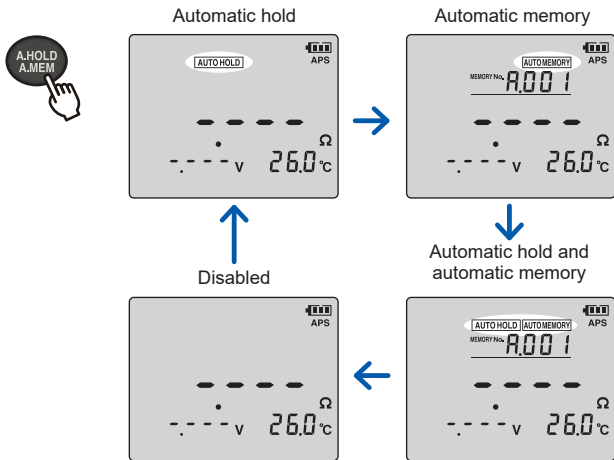

To disable the hold function, press the **HOLD** key or the **PRESS** button on the 9466 Remote Control Switch.

The automatic hold will not work in the following cases:

- When the resistance readout exhibit the [----] segments
- When the [OVER] segment and the maximum display value of the resistance are blinking



Using the automatic memory function in combination with the automatic hold function can automatically freeze and save measurement values.

### Canceling the automatic hold function

Press the **A.HOLD/A.MEM** key several times to hide the **[AUTO HOLD]** segment.

## 3.7 Determining Battery-Deterioration Evaluation Values

To evaluate whether batteries have deteriorated, first, measure the internal resistance of a fresh or non-defective battery, and then decide the battery-deterioration evaluation values.

Deteriorated batteries will have about 1.5 to 2 times (values for reference purposes) as high internal resistance, generating only 0.9 times as high voltage as a fresh one. Use these values as guidelines when determining deterioration evaluation values.

### Example of deterioration evaluation values

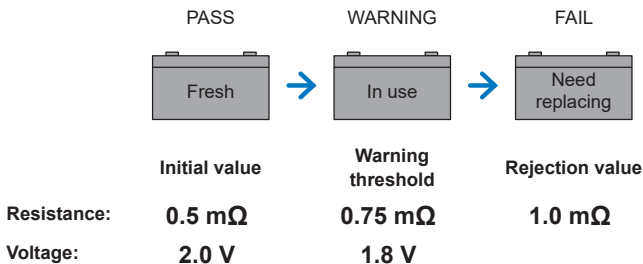

The above values will vary depending on the manufacturer and battery model.

See “1.1 Evaluating Battery Deterioration” (p. 23).

## 3.8 Measuring Batteries (Inspection)

- 1 Prepare for measurement. (p. 39)
- 2 Set the resistance and voltage ranges. (p. 49)
- 3 Perform zero adjustment. (p. 52)

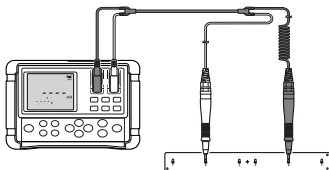

- 4 Connect the test lead to a battery under measurement.

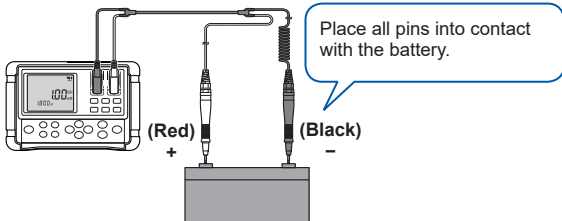

See “11.1 Effects of Extending the Test Lead and Induced Voltage” (p. 155), “11.2 Effects of Eddy Currents” (p. 156), and “11.4 Effects of Current Density” (p. 159).

## 5 Read the measured values.

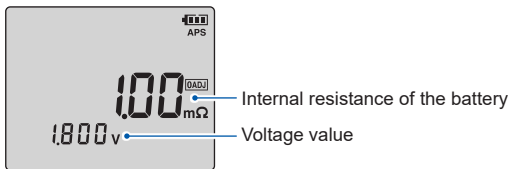

## 6 Use the measured values to evaluate whether the battery has deteriorated.

Example:

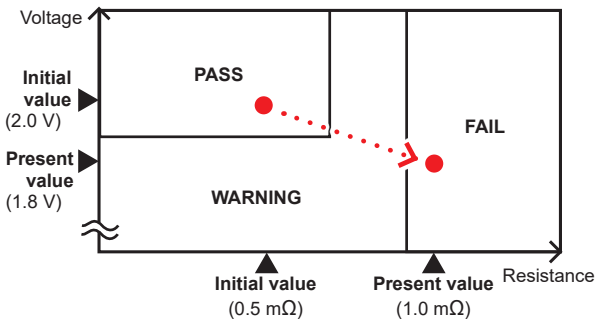

As shown above, this battery needs replacing.

**To freeze measured values**

▶ See “3.5 Using the Hold Function” (p. 59).

**To save measured values.**

▶ Measurement values can be saved by pressing the **MEMORY** key while the display is freezing the values.  
See “5.2 Saving Data in the Memory” (p. 87).

**To load the saved data to your computer**

▶ See “7 Communications Function” (p. 105).

**To set threshold values to evaluate whether a battery has deteriorated**

▶ Based on the deterioration evaluation values, you can set threshold values to evaluate whether batteries have deteriorated.  
See “4 Comparator Function (Evaluation Based on Threshold Values)” (p. 69).



## Measurement error

Even if the [----] segments appear and the [OVER] segment blinks on the display (at the same time, the maximum display value blinks), this does not indicate an error.

[----]	<ul style="list-style-type: none"> <li>• If the resistance readout exhibits the [----] segments, the test lead may be open-circuited. Otherwise, the instrument cannot perform measurement because of a failure, such as no current flows due to a broken test lead.</li> <li>• The test lead may not be connected correctly to the target under measurement.</li> <li>• The resistance of the target under measurement significantly exceeds the measurement range.</li> </ul>
Blinking the [OVER] segment and maximum display value	<ul style="list-style-type: none"> <li>• Resistance, voltage, or temperature may exceed each measurable range.</li> </ul>

### IMPORTANT

When measuring contact resistances of relays or connectors, be aware that the instrument will generate an open-terminal voltage of 5 V at maximum. The open-terminal voltage may damage the oxidized coating on the contacts of targets under measurement, leading to incorrect measurements.

## Warning display

If an overvoltage is input, the instrument will show the [OVER] segment and the blinking maximum display value on the display, backlight the display in red, and produce beeps.

## 3.9 Measuring Temperature

Use the 9460 Clip Type Lead with Temperature Sensor (option) to measure battery temperature.

Use the 9451/9451S Temperature Probe (option) to measure an ambient temperature.

See “Options” (p. 4).

- 1 Connect the connectors of the 9460 Clip Type Lead with Temperature Sensor to the instrument.**

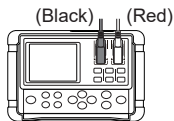

- 2 Connect the mini-plug of the 9460 Clip Type Lead with Temperature Sensor to the TEMP.SENSOR terminal.**

Connect the mini-plug of the 9451/9451S Temperature Probe to the TEMP.SENSOR terminal.

The instrument will detect the temperature sensor and automatically display the temperature.

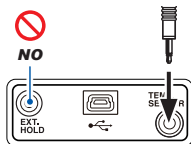

Top of the instrument



You can toggle between the two temperature measurement units: Celsius and Fahrenheit.

See “How to toggle the temperature measurement units” (p. 33).

# 4

## Comparator Function (Evaluation Based on Threshold Values)

### 4.1 Overview

The comparator function compares measured values of batteries with the preset threshold values to evaluate batteries on a three-level basis consisting of PASS, WARNING, and FAIL.

#### Comparator threshold values

Set the resistance warning threshold, resistance rejection value, and voltage warning threshold. Up to 200 comparison conditions can be set.

For information about how to set the thresholds, see “1.1 Evaluating Battery Deterioration” (p. 23).

#### Comparator buzzer

The instrument with the default settings will produce beeps when the comparator yields the WARNING or FAIL result.

See “4.4 Setting the Comparator Buzzer” (p. 80).

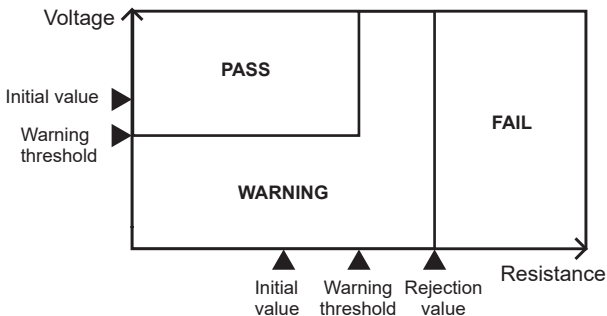

## 4.2 Enabling the Comparator Function

- 1**  **Press the key.**

A blinking comparator number will appear.

Press the **COMP** key again to return to normal measurement mode.



- 2**  **Choose a comparator number.**

You can choose a number from between 1 and 200.

- 3**  **Confirm your entry.**

The comparator function will be enabled.

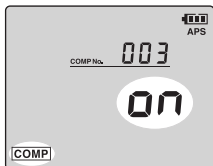

When the comparator function is enabled, the measurement range will switch over to that specified in the comparator setting with the chosen number.

## 4.3 Setting Threshold Values for the Comparator

This section describes how to set threshold values for the comparator (resistance warning threshold, resistance rejection value, voltage warning threshold).



You can set the threshold values through GENNECT ONE or GENNECT Cross.

See GENNECT ONE (contained in the accompanying CD) or User Manual on GENNECT Cross.

**Example: Threshold values for a battery that initially has an internal resistance of 0.4  $\Omega$  and generates a voltage of 2 V.**

Resistance warning threshold: 0.6  $\Omega$  (1.5 times the initial value)

Resistance rejection value: 0.8  $\Omega$  (2 times the initial value)

Voltage warning threshold: 1.8 V

\*: The initial values mean the resistance value a fresh battery or non-defective battery has and the initial voltage value such a battery can generate.

## Choosing a comparator number

- 1**  **Hold down the key for at least 1 s.**

A blinking comparator number will appear.

Press the **COMP** key again to return to normal measurement mode.

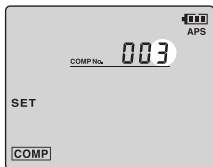

- 2**  **Choose a comparator number.**

You can choose a number from between 1 and 200.

- 3**  **Confirm your entry.**

The display will return to range setup mode.

## Setting the range

- 1**  Choose a resistance range.  
(The decimal point position will move.)

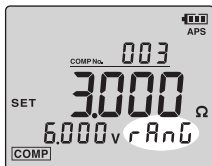

- 2**  Choose a voltage range.  
(The decimal point position will move.)

- 3**  Confirm your entry.  
The resistance warning threshold and the **[WARNING]** segment will blink.

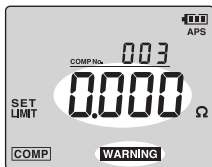

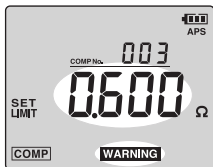

## Setting the threshold values

- 1**  Set the resistance warning threshold.



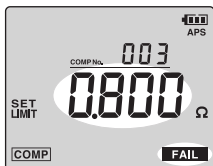

- 2**  Confirm your entry.  
The resistance rejection value and the **[FAIL]** segment will blink.

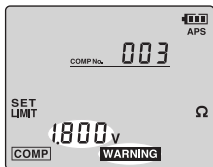

- 3**  Set the resistance rejection value.

- 4**  Confirm your entry.  
The voltage warning threshold and the **[WARNING]** will blink.



- 5**  Set the voltage warning threshold.

- 6**  Confirm your entry.



## 7 Set the voltage evaluation method.

When you have chosen the **[PoL]**, reversely connecting the red and black wires of the test lead will cause the **[WARNING]** result.

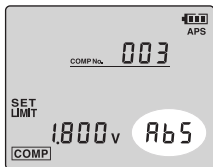

### **[WARNING]**

(Red) (Black)

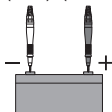

(Black) (Red)

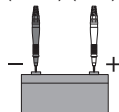

Voltage evaluation method	Comparison method	Data to be saved
<b>[Abs]</b> (Default setting)	Evaluates absolute voltage values, regardless of whether they are positive or negative.	Signed (minus sign only)
<b>[PoL]</b>	The <b>[WARNING]</b> result will be given for the negative voltage value. If the test lead is placed into contact in reverse polarity with a battery (the red and black probes with the negative and positive terminals, respectively), the result will be given.	Signed (minus sign only)

You can set the evaluation method using version 1.8 or later of GENNECT Cross.

8



**Confirm your entry.**

The display will return to measurement mode with the comparator function enabled. The settings are now saved.

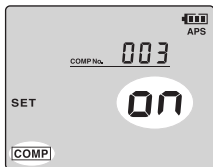

If you set the resistance rejection value that is less than the resistance warning threshold, the warning threshold will change to the same value as the resistance rejection value.

## When a PASS judgment is given

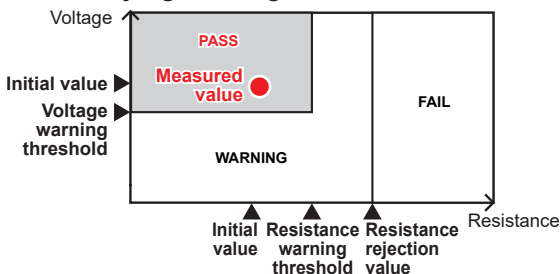

## When a WARNING result is given

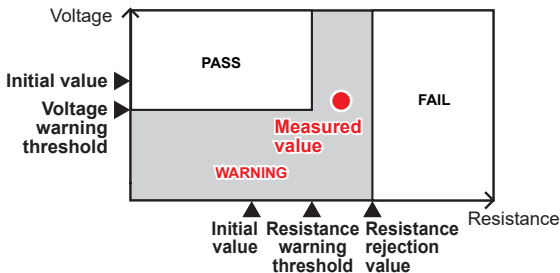

## When a FAIL judgment is given

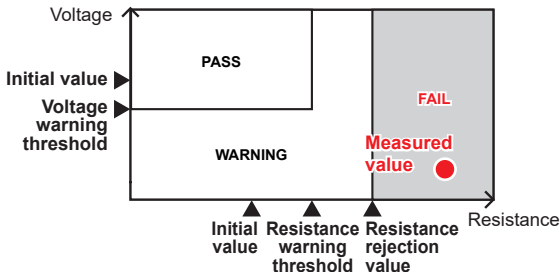

## Comparison table for the comparator

The instrument will show a result and produce beeps as shown in the following table:

	Resistance warning threshold	Resistance rejection value	
	Resistance (low)	Resistance (medium)	Resistance (high)
<b>Voltage (high)</b>	PASS	WARNING	FAIL
<b>Voltage warning threshold</b>			
<b>Voltage (low)</b>	WARNING	WARNING	FAIL

The boundary conditions are as follows:

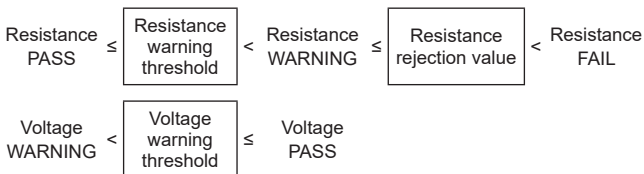

## Examples of how to read the comparator output table

### Example 1:

If the measured resistance is less than or equal to the resistance warning threshold, and the measured voltage is more than or equal to the voltage warning threshold, the **[PASS]** segment will appear.

### Example 2:

If the measured resistance exceeds the resistance warning threshold but is less than or equal to the resistance rejection value, and the measured voltage exceeds the voltage warning threshold, the instrument will show the **[WARNING]** segment and produce beeps.

When the resistance warning threshold and resistance are set to the same value, the boundary conditions are as shown below:

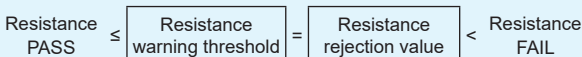

## 4.4 Setting the Comparator Buzzer

This section describes how to set the instrument to produce beeps according to the comparison result. The comparator buzzer can be set in the following states: By default, the instrument has been set to produce beeps when the comparator gives a WARNING result or a FAIL judgment.

<b>Disabled</b>	The instrument will not produce beeps regardless of comparison results.
<b>Sounds for PASS</b>	The instrument will produce beeps when the comparator gives a PASS judgment.
<b>Sounds for FAIL judgments</b>	The instrument will backlight the display in red and produce beeps when the comparator gives a WARNING result or a FAIL judgment.

When you press the  key, the present comparator buzzer setting will appear. Press the key repeatedly to cycle through the settings.

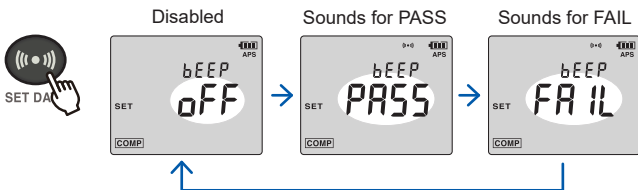

After a certain period of inactivity, the instrument will confirm your entry and the display will return to measurement mode.

The key tone cannot be set.

## 4.5 Canceling the Comparator Function

When the comparator is enabled, pressing the **COMP** key can disable the comparator function.

Comparator function enabled

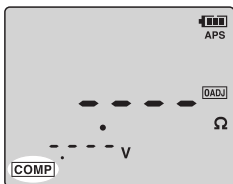

Comparator function disabled

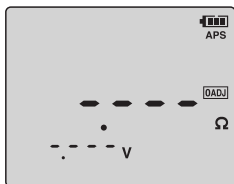

- The range keys cannot be used while the comparator function is enabled.
- If there are no measurement values, the [-----] segments will appear and the comparator will not work.
- Even when the instrument is turned off, the comparator settings are saved; the comparator will be enabled when the instrument is turned on again.





## 5

## Memory Function

## 5.1 Overview

The instrument can store up to 6000 data sets consisting of presently measured values\*.

After measurement, you can browse and send saved data to your computer or mobile device.

The internal-memory structure is as follows:

\*: Date and time, resistance, voltage, temperature, comparator threshold values, and comparison results

## Memory structure

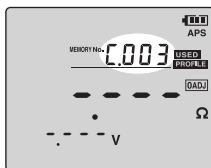

(Display example)

Unit label (12 units)	Memory number (500 cells)			
A	001	...	499	500
B	001	...	499	500
C	001	...	499	500
D	001	...	499	500
E	001	...	499	500
F	001	...	499	500
G	001	...	499	500
H	001	...	499	500
J	001	...	499	500
L	001	...	499	500
N	001	...	499	500
P	001	...	499	500

## Profile information

The instrument can be populated 100 sets of profile information (comments, such as location information and device information, and the battery numbers of batteries under measurement). You can save measured data in connection with profile information previously registered.

### Concept for registering profile information in the memory

Profile information

Profile number* <sup>1</sup>	1	
Location information* <sup>2</sup>	HIOKI 1F UPS ROOM	
Device information* <sup>2</sup>	UPS 1-1	
Battery number* <sup>3</sup>	Start	1
	End	50

Measured data to be saved

Memory number
A.001
A.050

\*1: Can be chosen from between 1 and 100.

\*2: Any comment can be registered. Strings at most 72 bytes

\*3: The number assigned to the battery under measurement. Can be chosen from between 1 and 500.

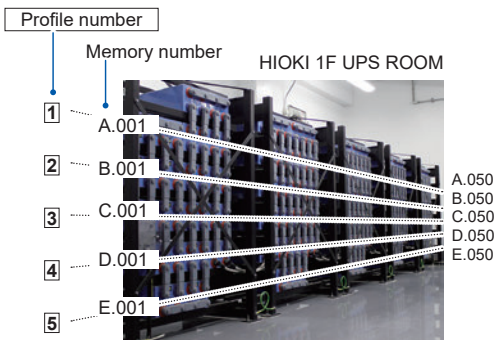

You can save measured data associating with profile information previously registered. This makes the control of information, including the UPSs equipped with batteries under measurement and their locations, easier.

### Concept of a data set to be saved

Profile information	Profile number	1
	Location information	HIOKI 1F UPS ROOM
	Device information	UPS 1-1
	Battery number	1
Measured data	Memory number	A.001
	Date and time	2020/4/20 13:00:00 (yyyy/mm/dd hh:mm)
	Resistance value	●.●●● mΩ
	Voltage value	●●.●● V
	Temperature	●●.●●°C
	Comparator threshold values	● mΩ, ● mΩ, ● V
	Comparison result	PASS, WARNING, or FAIL

5

When you choose a memory number that has already been assigned to a profile information set, the **[PROFILE]** segment will appear.

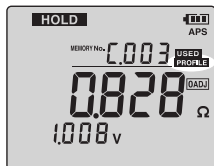

## How to register profile information

Computer	Use GENNECT ONE to register. The profile information can be transferred via the USB interface.
Smart phone / Tablet	Use version 1.8 or later of GENNECT Cross to register. The profile information can be wirelessly transferred. The instrument requires the Z3210 Wireless Adapter to be connected.

- Operating the instrument only cannot register or delete profile information.
- Details of profile information transferred to the instrument cannot be seen on the instrument's display.

**Tips**

### **To transfer profile information registered in the instrument to your computer or start phone**

You can load the information on GENNECT ONE or GENNECT Cross.

See GENNECT ONE (contained in the accompanying CD) or User Manual on GENNECT Cross.

## 5.2 Saving Data in the Memory

Pressing the **MEMORY** key stores the present measurement values. For information about handy features, see “5.3 Automatic Memory Function” (p. 89)

**1**  **Enable the memory function.**

MEMORY OFF

**2**  **Choose a memory number.**

After a certain period of inactivity, the instrument will confirm your entry and return the display to measurement mode. When the memory function is enabled, you can always choose a memory number.



**3**  **Confirm your entry.**

[USED]	Measured values has already been saved. (The data will be overwritten)
[PROFILE]	Profile information has already been registered.

**4**  **Freeze the measured values.**

See “3.5 Using the Hold Function” (p. 59).

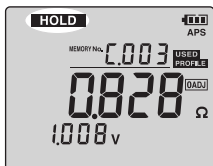

5



### Save measured values.

The instrument will assign the chosen number to the measured values and save them.

After the data has been saved, the subsequent available memory number will appear.

The hold function will be disabled.

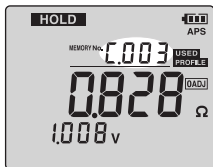

- Holding down the **CLEAR** key for at least 1 s can delete the data saved most recently. However, you can delete immediately after the data has been saved only. Every time you hold down the key for at least 1 s, the instrument will delete the data that is the latest at the time and return the display to the first memory number in the unit to display the contents.
- While the measurement recording prompt is operating, the instrument will return the memory number corresponding to the first battery number to display the contents.

## 5.3 Automatic Memory Function

Immediately after the display freezes the measured values, the instrument will automatically save them.

Press the **A.HOLD/A.MEM** key several times to display the **[AUTO MEMORY]** segment. The memory function will also be enabled.

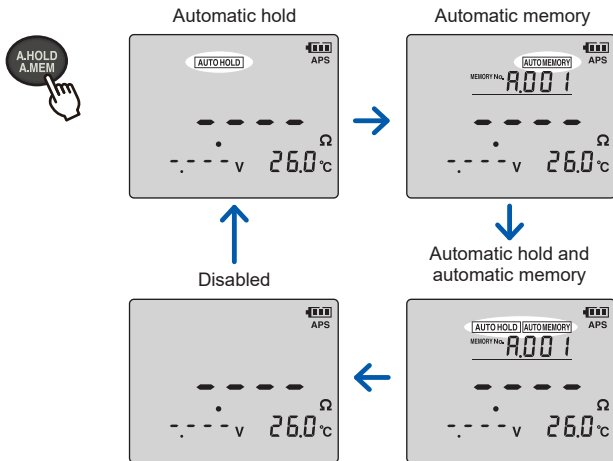

Use the cursor keys to choose a memory number to save. If you choose the memory number already assigned to a measured data set, the **[USED]** segment will appear.

Concurrent use of the automatic memory and automatic hold functions lets the instrument automatically freeze the displayed data and save it.

## Disabling the Automatic memory Function

Press the **A.HOLD/A.MEM** key several times to hide the **[AUTO MEMORY]** segment.



## 5.4 Disabling the Memory Function

To disable the memory function with it enabled, hold down the **MEMORY** key for at least 1 s. The instrument will display the **[oFF]** segments and return the display to normal mode.

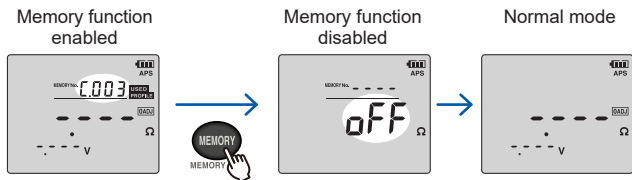

Hold down for at least 1 s.

## 5.5 Reading Out Saved Data

This section describes how to read out and display saved measured values.

**1**  **Switch over the display to memory readout mode.**

**2**  **Choose a memory number you wish to read out.**

The instrument will display the measurement values with the memory number you chose.

**3** **To return the display to measurement mode, press the **READ** key.**



- Hold down the  key for at least 1 s to check the saved date and time.
- The comparison result of the read-out data will be also displayed.
- You cannot choose the memory numbers not containing any data.
- If no data has been saved, the display will show the [----] segments and return to measurement mode.

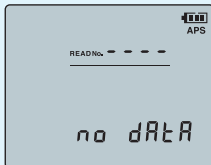

- The memory numbers with the blinking **[PROFILE]** segment indicates that the profile information has been registered there.
- Displayed data measured using the 9460 Clip Type Lead with Temperature Sensor (option) and the 9451/9451S Temperature Probe (option) will include temperature.

## 5.6 Deleting Measured Data

### IMPORTANT

- Use of the **CLEAR** key of the instrument can delete measured data only.  
Profile information cannot be deleted.
- Use GENNECT ONE or GENNECT Cross to delete profile information.

### Deleting a single measured data set

**1**  Switch over the display to memory readout mode.

**2**  Choose a memory number to delete.

The instrument will display the measurement values to which the memory number you chose has been assigned.



**3**  Press the key once.

After 3 s of inactivity, the display will return to memory readout mode.



**4**  Confirm your entry.

The data set with the memory number you chose will be deleted.

## Deleting all data contained in a unit

- 1** **READ** Switch over the display to memory readout mode.

- 2**  Choose a unit to delete.

- 3** **CLEAR**  
CLEAR LAST DATA Press the key twice.

After 3 s of inactivity, the display will return to memory readout mode.

- 4** **ENTER** Confirm your entry.

All data (500 data sets) stored in the unit will be deleted.

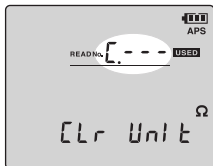
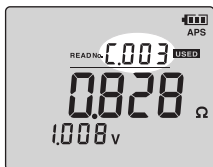

## Deleting entire data

---

- 1** **READ** Switch over the display to memory readout mode.

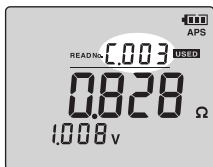

- 2** **CLEAR** CLEAR LAST DATA Press the key three times.

After 3 s of inactivity, the display will return to memory readout mode.

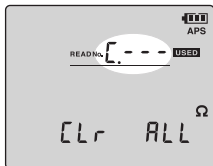

- 3** **ENTER** Confirm your entry.

Entire data (12 units, 6000 data sets) will be deleted.

## 6

## Measurement Recording Prompt Function

The instrument and your mobile device with GENNECT Cross installed, using the display and voice prompts, respectively, can inform you of comparison results and the battery number you are to measure next. This enables you to record measured data quickly. Install the latest version of GENNECT Cross. The voice prompt function can be used under version 1.8 or later of GENNECT Cross.

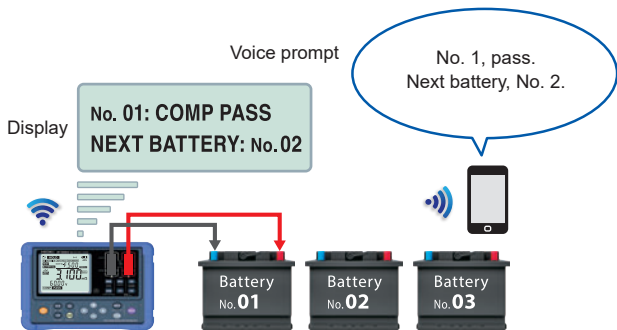

### IMPORTANT

Check that the instrument's battery level remains sufficiently. If the instrument is shut off while using the measurement recording prompt, you cannot restart the prompt beginning from the number where the prompt stopped.

## 6.1 Preliminary Preparation

### Transferring the profile information to the instrument

---

The instrument can be populated 100 sets of profile information (comments, such as location information and device information, and the numbers assigned to batteries under measurement). You can save measured data in connection with profile information previously registered.

#### For a mobile device

- 1** Connect the Z3210 Wireless Adapter (option) into the instrument.

See “2.3 Connecting the Z3210 Wireless Adapter (Option)” (p. 41).

- 2** Install version 1.8 or later of GENNECT Cross on your mobile device.
- 3** Use GENNECT CROSS to register profile numbers, battery numbers, and memory numbers corresponding to the battery numbers.
- 4** Transfer the profile information to the instrument.





## For the computer

- 1** Connect the instrument and your computer using the USB cable.
- 2** Install GENNECT ONE.
- 3** Use GENNECT ONE to register profile numbers, battery numbers, and memory numbers corresponding to the battery numbers.
- 4** Transfer the profile information to the instrument.



## 6.2 Visual Prompt From the Instrument

You can perform measurements by following the visual prompt from the instrument alone. GENNECT Cross will not operate in sync with the instrument.

To compare measured values with the threshold values, preset the comparator function.

See “4 Comparator Function (Evaluation Based on Threshold Values)” (p. 69).

- 1**  **Switch over the display to the profile number selection mode.**

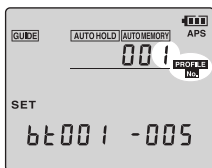

- 2**  **Choose a profile number to be used in the measurement recording prompt.**

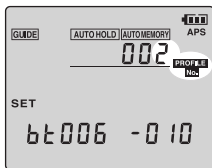

- 3**  **Confirm your entry.**

The automatic hold function and automatic memory function will automatically be enabled.

- 4**  Choose between using and not using the comparator function.

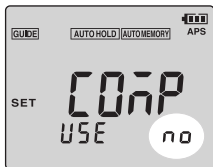

- 5**  Confirm your entry.

(When you chose not using the comparator function, the display will switch over to measurement prompt start mode.)

- 6**  When you chose using the comparator function, choose a comparator number.

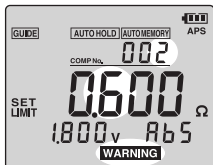

- 7**  Confirm your entry.

The instrument will switch over the display to measurement-prompt start mode, starting the measurement recording prompt.

The battery number you are to measure next and record and the memory number will blink.

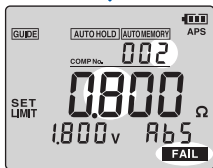

## 8

### Measure the battery.

The comparison result and measured data will be saved in connection with profile information.

After the recording, the battery number you are to measure and record next will blink.

After you finish the measurement of the battery to which the last number has been assigned, the measurement recording prompt will stop.

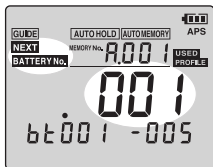

## 6.3 Visual Prompt and Voice Prompt

You can perform measurements by following the voice prompt from GENNECT Cross (version 1.8 or later required) that communicates with the instrument.

To compare measured values with the threshold values, preset the comparator function.

See “4 Comparator Function (Evaluation Based on Threshold Values)” (p. 69).

- 1** Hold down the  key for at least 1 s (When the wireless communications function is disabled).

The wireless communications function will be enabled.  
Connecting the Z3210 Wireless Adapter (option) is required.

- 2** Run GENNECT Cross on your mobile device and register the instrument to pair with.

- 3** Select the battery function on GENNECT Cross.

- 4** Use GENNECT Cross to start the measurement recording prompt.

The blinking [VOICE] segment will appear on the display.



**If you mistakenly measured wrong batteries**

Holding down the **CLEAR** key for at least 1 s can delete the data set saved most recently. Every time you hold down the **CLEAR** key for at least 1 s, the instrument will delete the data that is the latest at the time. You can return the display to the first battery number.

**To change the comparator function settings during the measurement recording prompt**

The settings cannot be changed. Stop the measurement recording prompt and use the instrument to set the comparator settings.

**To disable the automatic hold function and automatic memory function during the measurement recording prompt**

You can disable them using the instrument. To freeze and save the measured values after disabling the functions, use the keys.

**To quit the measurement recording prompt**

Hold down the **GUIDE** key for at least 1 s. Alternatively, use GENNECT Cross to quit. However, you cannot restart the prompt beginning from the number where you quit.

## 7

## Communications Function

Using the USB cable enables the instrument to communicate with your computer.

Installing the Z3210 Wireless Adapter (option) enables the instrument to communicate wirelessly with your smart phone or tablet.

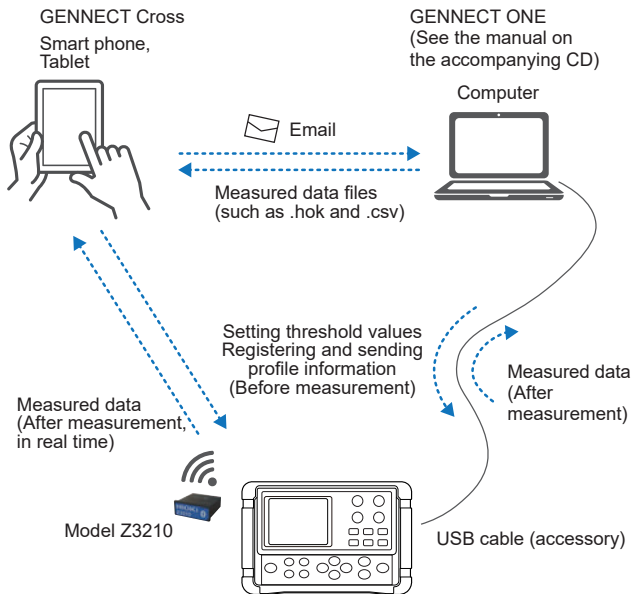

Hioki can deliver application software for each mobile devices and computers.

For mobile devices  
GENNECT CROSS special site

<https://gennect.net/en/cross/index>



For computers  
GENNECT ONE special site

<https://gennect.net/en/one/index>



## 7.1 Communicating With a Computer

By using the supplied USB cable, you can send data to your computer or control the instrument from the computer.

For more information, see the manual on the CD.

The computer uses the virtual COM port as the USB interface.

- Insert the connector in the proper direction when connecting the USB cable.
- The display will show the **[PC]** segments when communications are in progress through the USB cable.
- Do not disconnect the USB cable during USB communications. The dedicated computer application software will display a warning message when communications fail due to cable disconnection. Connect the USB cable again.

## 7.2 Communicating With a Mobile Device

Enabling the wireless communications function lets you use your mobile device to do various works, such as browsing measured data saved in the instrument, creating reports, and running the measurement recording voice prompt.

For details, see User Manual on GENNECT Cross (free-of-charge application).

- 1 Connect the Z3210 Wireless Adapter (option) into the instrument. (p. 41)**

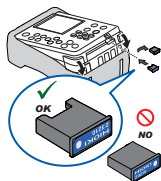

- 2 Install GENNECT Cross on your mobile device.**



- 3 Turn on the instrument.**

- 4 Enable the wireless communications function.**

When the instrument is turned on for the first time after the installation of the Z3210, the wireless communications function will be enabled.



Hold down for at least 1 s.

**5** Run GENNECT Cross on your mobile communication device and register the instrument to pair with.

**6** Select various functions to perform measurement.

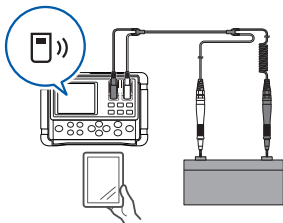

- The communication distance is about 10 m with a clear line of sight. The communicatable distance may greatly vary depending on the presence of an obstruction (walls or metallic shielding object) and the distance between the floor (ground) and the instrument. To ensure stable measurement, make sure that the radio-wave intensity is sufficient.
- GENNECT Cross is free of charge. However, the customer is responsible for the cost to download the application software and connect to the Internet when using the software
- GENNECT Cross may not properly operate depending on the mobile device.
- For the first time (before being paired with any instrument), the app will launch with the pairing setup screen.
- GENNECT Cross's pairing setup screen will automatically pair with the instrument (up to eight instruments).
- Allow about 5 to 30 s for the instrument to pair with the app after turning on. If the instrument fails to pair even if one minute has elapsed, relaunch GENNECT Cross and cycle the instrument.
- The Z3210 uses the 2.4 GHz band wireless technology. When there is a device that uses the same frequency band such as a wireless LAN (IEEE 802.11.b/g/n) near your mobile device, the communication may not be established.

**IMPORTANT**

Placing the instrument on the floor or the ground will cause the communications distance to decrease. To keep the instrument away from the floor or the ground, it is recommended to place the instrument on a desktop or a workbench or hang the instrument from your neck using the neck strap.

## Enabling/disabling the wireless communications function

Holding down the  key for at least 1 s can enable/disable the wireless communications function.

When the instrument is turned on for the first time after the installation of the Z3210, the wireless communications function will be enabled.

- On: Wireless communications function enabled
- Blinking: Now communicating
- Off: Wireless communications function disabled

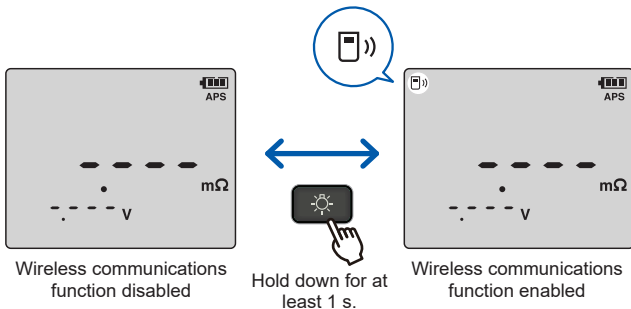

Even when the wireless communications function is enabled, connecting the instrument and a computer using the USB cable disables the function.

## 7.3 Z3210-to-Excel<sup>®</sup> Direct Data Entry Function (Excel<sup>®</sup> Direct Input Function, HID Function)

The human interface device (HID) profile, with which the Z3210 Wireless Adapter is equipped, is a profile same as that wireless keyboards use.

Preparatory to data entry, open an Excel<sup>®</sup> file on your mobile device or computer and choose a cell. Freezing the instrument's display can enter the measured values on the cells.

The use of this function with the automatic hold function enabled comes in handy.

See “3.6 Automatic Hold Function” (p. 61).

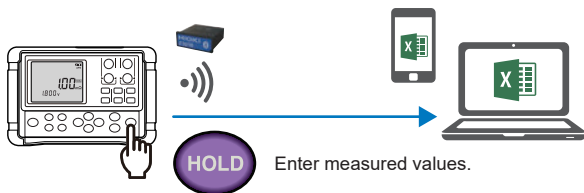

HID ON	Choose this option to enter measured values in a Excel <sup>®</sup> file or a text file. The instrument cannot communicate with GENNECT Cross.
HID OFF	Choose this option to use GENNECT Cross.

The setting whether the HID function has been enabled or disabled will not be saved in the instrument but in the Z3210.

## Enabling/disabling the HID function

1



Turn off the instrument.

2

Connect the Z3210  
Wireless Adapter (option)  
into the instrument.  
(p. 41)

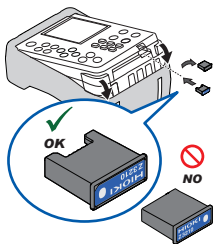

3



+



Switch over the display  
to HID setting mode.

The instrument will display  
the HID setting saved in  
the Z3210.

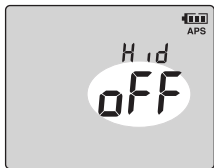

If the [---] strings is displayed, an old version  
of the firmware has been installed in the Z3210.  
Update it to the latest version.  
Use version 1.8 or later of GENNECT Cross to  
update.

4



Choose between [off]  
and [on].

5



Confirm your entry.

The display will return to  
measurement mode.



(When enabled)

7

## IMPORTANT

### To switch over from the HID function to GENNECT Cross

If you start GENNECT Cross without canceling the pairing between the mobile device and the instrument, GENNECT Cross may not be able to recognize the instrument as a connectible device. Follow the procedure below to reconnect the instrument to GENNECT Cross.

1. Use the **Bluetooth**<sup>®</sup> setting of your mobile device to delete the instrument.
2. Disable the Z3210's HID function. (p. 113)
3. Use the Instrument Setting of GENNECT Cross to reconnect the instrument.

For detail information, please visit the Z3210's website.

<https://z3210.gennect.net>



Learn more here!



## 8.1 Backlight

## Turning on/off the backlight

Pressing the  key can turn on/off the display backlight.





If inactivity continues or a measurement-current anomaly continues to be detected for at least 40 s, the backlight will be automatically turned off.

## Enabling/disabling automatic backlighting shutoff

You can enable/disable the automatic backlighting shutoff.

Enabled: Turning off the backlight automatically

Disabled: Not turning off the backlight automatically

- 1  Turn off the instrument.
- 2  +  Switch over the display to automatic backlighting-shutoff setup mode.
- 3  Choose between [oFF] and [on].
- 4  Confirm your entry.

The display will return to measurement mode.

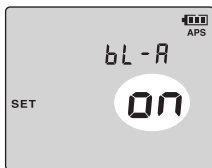

(When enabled)

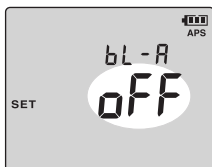

(When disabled)

## 8.2 Automatic Power Saving Function (APS)

Enabling the automatic power saving function can reduce power consumption of the instrument. The instrument will automatically be turned off if inactivity continues for about 10 minutes in one of the following states:

- When the resistance readout exhibits the [----] segments
- Freezes measured data (Measurement suspension state)
- In mode other than measurement mode (Any of setup modes or data readout mode)
- After completion of communications

The [APS] segment will start blinking one minute before shutoff.

The following conditions will disable this function.



- While communicating with a computer or a mobile device
- While the measurement recording prompt is operating

## Enabling/disabling the automatic power saving

Enabled: Turning off the instrument automatically

Disabled: Not turning off the instrument automatically

**1**  Turn off the instrument.

**2**  Switch over the display to automatic power saving setup mode.  
+  

**3**  Choose between [oFF] and [on].

**4**  Confirm your entry.

The instrument will be restarted.

The settings will not change if the instrument is turned off without your confirmation.

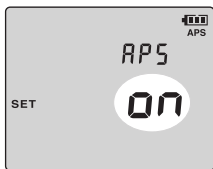

(When enabled)

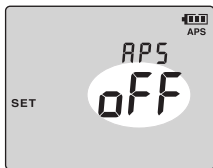

(When disabled)

- For continuous use of the instrument, disable the APS function. (Default setting: enabled)
- If the display unintentionally switches over to automatic power saving setup mode, cycle the instrument. The instrument will be turned on without changing the settings.

## 8.3 Instrument's Battery Level Indicator

The display, in the top right, includes the battery level indicator for the instrument's batteries.



Instrument's battery level indicator	Instrument's battery state
	Not discharged.
	Partially discharged.
	Almost exhausted. Replace as soon as possible.
	(Blinking) Exhausted. Replace with fresh batteries.

- Using manganese batteries significantly reduces the continuous operating time of the instrument.
- The battery level indicator does not function accurately when nickel-metal hydride batteries are used.
- The battery level indicator serves as an approximate guideline for the continuous operating time.

## 8.4 System Reset

This section describes how to reset the instrument to its default state.

However, note that the following settings will not be reverted:

- Date and time
- Saved profile information (100 sets)
- Saved measured data (6000 data sets)
- Comparator threshold values (200 sets)

**1**  Turn off the instrument.

**2**  CLEAR LAST DATA **+** Switch over the display to system reset mode.



**3**  Select [yES].

To cancel the system reset operation, select [no].

**4**  Confirm your entry.

The instrument will be restarted.

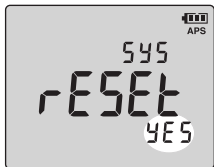

## **Default settings (Factory-configured settings)** .....

See “9.5 Default Settings and Resettable Settings” (p. 139).

- If the display unintentionally switches over to system reset mode, cycle the instrument. The instrument settings are restored without resetting the system.
- For more information on how to delete saved measured data, see “5.6 Deleting Measured Data” (p. 94).

## 9.1 General Specifications

<b>Operating environment</b>	Indoor use, pollution degree 2, up to 2000 m (6562 ft.)
<b>Operating temperature and humidity</b>	Temperature: 0°C to 40°C (32°F to 104°F) Humidity: 80% RH or less (no condensation)
<b>Storage temperature and humidity</b>	Temperature: -10°C to 50°C (14°F to 122°F) Humidity: 80% RH or less (no condensation)
<b>Standards</b>	Safety: EN 61010 EMC: EN 61326
<b>Power supply</b>	LR6 Alkaline batteries ×8 Rated supply voltage: 1.5 V DC × 8 Maximum rated power: 3 VA Nickel-metal hydride batteries can be used. (However, the battery level indicator does not support use of nickel-metal hydride batteries.)
<b>Continuous operating time</b>	About 8.3 hour (with the Z3210 not connected) About 8.2 hour (with the Z3210 connected, wirelessly communicating) These has been specified as values used for reference purposes when the instrument operates on the accompanying LR6 Alkaline batteries with the display not backlit at an ambient temperature of 23°C. However, the values may vary depending on the operation condition.
<b>Backup battery lifetime</b>	About 10 years (value used for reference purposes at 23°C)

---

<b>Interface</b>	<ul style="list-style-type: none"><li>• USB Communications speed: USB 2.0 Class: CDC class Connector: USB mini B</li><li>• Wireless communications are available with the Z3210 connected. The factory-installed protective cap has to be removed to connect the Z3210.</li></ul>
<b>Dimensions</b>	Approx. 199W × 132H × 60.6D mm (7.83"W × 5.20"H × 2.39"D) (With the Z5041 Protector attached)
<b>Weight</b>	Approx. 960 g (33.9 oz.) (including LR6 Alkaline batteries and Z5041 Protector)
<b>Product warranty period</b>	3 years
<b>Fuse</b>	250 V / F 630 mA (216.630, Littelfuse, Inc.) Equipped with one fuse
<b>Accessories</b>	p. 3
<b>Options</b>	p. 4
<b>Display</b>	LCD (FSTN type, black-and-white)

---



## 9.2 Basic Specifications

<b>Measurement parameters</b>	<ul style="list-style-type: none"> <li>• Measuring battery internal resistance</li> <li>• Measuring battery terminal voltage (DC voltage only)</li> <li>• Measuring temperature</li> </ul>
<b>Measurable ranges</b>	<p>Resistance measurement: 0.000 m<math>\Omega</math> to 3.100 <math>\Omega</math> (4-range configuration)</p> <p>Voltage measurement: 0.000 V to <math>\pm 60.00</math> V (2-range configuration)</p> <p>Temperature measurement: -10.0°C to 60.0°C (single-range configuration)</p>
<b>Maximum input voltage</b>	<p>60 V DC (between the positive and negative measurement terminals)</p> <p>AC voltage cannot input.</p>
<b>Maximum rated voltage to earth</b>	<p>60 V DC (Measurement category not rated)</p> <p>Anticipated transient overvoltage 330 V (between all measurement terminals and ground)</p>
<b>Measurement method</b>	<p>Resistance measurement: AC four-terminal method Open-circuited terminal voltage: 5 V peak at a maximum</p> <p>Measurement current: 1.6 mA to 160 mA (Fixed according to the resistance measurement range setting)</p> <p>Temperature measurement: Platinum temperature sensor (500 <math>\Omega</math> at 25°C)</p> <p>A/D conversion method: Delta-sigma modulation</p> <p>Display update rate: 3 times/s (Resistance, voltage, and temperature measured as a set)</p>

---

<b>Measurement terminals</b>	<ul style="list-style-type: none"><li>• For measuring resistance and voltage: Banana sockets</li><li>• Maximum input voltage: <math>\pm 60</math> V DC at a maximum (Not accept AC voltage input)</li><li>• Input resistance: 20 k<math>\Omega</math> or more</li><li>• Temperature-measurement input terminal: Earphone-jack type (<math>\phi 3.5</math> mm)</li><li>• Switch input terminal: Earphone-jack type (<math>\phi 2.5</math> mm)</li></ul>
<b>Measurement time</b>	100 ms
<b>Response time</b>	Approx. 1.6 s

---

## 9.3 Accuracy Specifications

<b>Accuracy guarantee conditions</b>	<p>Accuracy guarantee duration: 1 year</p> <p>Accuracy guarantee duration after adjustment made by Hioki: 1 year</p> <p>Accuracy guarantee temperature and humidity range: 23°C ±5°C (73°F ±9°F), 80% RH or less</p> <p>Warm-up time: None (Not required)</p>
<b>Temperature characteristics</b>	<p>Within the operating temperatures, add (measurement accuracy) × 0.1/°C. (Except the range of 18°C to 28°C)</p>
<b>Resistance measurement accuracy</b>	<p>Measurement current accuracy: ±10%</p> <p>Measurement current frequency: 1 kHz ±30 Hz 1 kHz ±80 Hz if the noise-frequency reduction function is enabled.</p>

Range setting	Maximum displayable value	Resolution	Measurement accuracy	Measurement current
3 mΩ	3.100 mΩ	1 μΩ	±1.0% of reading ±8 digits	160 mA
30 mΩ	31.00 mΩ	10 μΩ	±0.8% of reading ±6 digits	160 mA
300 mΩ	310.0 mΩ	100 μΩ		16 mA
3 Ω	3.100 Ω	1 mΩ		1.6 mA

- Add the following values to the measurement accuracy as influence values if zero adjustment has not been performed in the 3 mΩ range (reference values).

When the 9465-10 is used:	±5 digits
When L2020 is used:	±6 digits
When the 9772 is used:	±1 digit
When the 9460 is used:	±16 digits
When the 9467 is used:	±5 digits

## Accuracy Specifications

- When a Hioki's test lead other than those listed above or whose length has been extended is used, the accuracy can be guaranteed only after zero-adjustment is performed.
- When a test lead other than those made by Hioki is used, the accuracy and proper operation cannot be guaranteed.
- Zero adjustment involving the 9465-10, L2020, or 9772 has to be performed using the accompanying zero-adjustment board or the Z5038 0 Adj Board.

### Voltage measurement accuracy

Range setting	Maximum displayable value	Resolution	Measurement accuracy
6 V	±6.000 V	1 mV	±0.08% of reading ±6 digits
60 V	±60.00 V	10 mV	

### Temperature measurement accuracy

When the 9460 Clip Type Lead with Temperature Sensor is used

Measurable range	Maximum displayable value	Resolution	Measurement accuracy
-10°C to 60°C (14°F to 140°F)	60.0°C (140.0°F)	0.1°C (0.1°F)	±1.0°C (±1.8°F)

- When the 9451 Temperature Probe (length: 1.5 m) is used, add ±0.5°C to the accuracy listed above.
- When the 9451S Temperature Probe (length: 0.1 m) is used, add ±0.5°C to the accuracy listed above.
- Accuracy of the BT3554-50 alone  
Under simulated input conditions: ±0.5°C (±0.9°F)
- Unit conversion formula:  
Fahrenheit (°F) = (9 ÷ 5) × Celsius (°C) + 32

## 9.4 Function Specifications

### (1) Measurement-current anomaly detection

<b>Operation</b>	Detects measurement-current anomalies.
<b>Display</b>	The [----] segments appear (For resistance and voltage readouts).
<b>Default setting</b>	Enabled (Cannot be disabled)

### (2) Wire break detection



<b>Operation</b>	Detects a broken source-side cable and a blown fuse. Detects a broken sense-side cable
<b>Display</b>	Function enabled: The [----] segments appear (For resistance and voltage readouts). Function disabled: The [----] segments appear (For resistance readout). A measured value appears (For voltage readout).
<b>Default setting</b>	Enabled
<b>How to disable</b>	See “1.4 Names and Functions of Parts” (p. 30).

### (3) Warning display

<b>Operation</b>	Informs the user that the input exceeds the measurable range of the present range setting.
<b>Display</b>	The [OVER] segment and the range's maximum display value blink (For resistance and voltage readouts). Backlights the display in red, produces beeps (When the input voltage exceeds the maximum value).
<b>Default setting</b>	Enabled (Cannot be disabled)

## (4) Noise-frequency reduction

(Noise reduction technology)

<b>Operation</b>	Avoids noise frequencies using the noise reduction technology.
<b>Display</b>	Function enabled: The  segment appears. During reduction of noise frequencies: The  segment blinks.
<b>Default setting</b>	Disabled
<b>How to set</b>	See “3.3 Noise-Frequency Reduction Function” (p. 51).

## (5) Zero adjustment

<b>Operation</b>	Internally adjusts the instrument so that it provides the zero indications corresponding to the measured values obtained through zero adjustment.
<b>Display</b>	During zero adjustment: The <b>[0ADJ]</b> segment blinks (While obtaining the correction value). Enabled: The <b>[0ADJ]</b> segment appears (With the correction value enabled).
<b>Default setting</b>	Disabled
<b>Correction range</b>	Up to 300 counts for each range of the resistance and voltage values
<b>How to correct</b>	See “3.4 Adjusting the Zero Point (Zero Adjustment)” (p. 52).

## (6) Comparator

<b>Operation</b>	<p>Compares measurement values with set threshold values and informs the user about the results.</p> <p>Means of giving comparison results:</p> <p style="padding-left: 2em;">Displays results according to the following table and produces beeps.</p> <p>If the comparator yields a WARNING or FAIL judgment, the display will be backlit in red in conjunction with beeps.</p> <p>(When the display is backlit in red, the white backlight will be turned off.)</p>		
------------------	--	--	--

	Resistance (low)	Resistance (medium)	Resistance (high)
Voltage (high)	PASS	WARNING	FAIL
Voltage (low)	WARNING	WARNING	FAIL

<b>Display</b>	<p>When the comparator function enabled:</p> <p style="padding-left: 2em;">The <b>[COMP]</b> segment and the comparator number appear. ( <u>COMP No.</u> )</p> <p>When the memory function is enabled, no comparator number appears.</p>		
----------------	--	--	--

<b>Default setting</b>	Disabled
------------------------	----------

<b>How to set</b>	See “4.2 Enabling the Comparator Function” (p. 70) and “4.3 Setting Threshold Values for the Comparator” (p. 71).
-------------------	---

<b>Number of settings to be saved</b>	200 tables
---------------------------------------	------------

## (7) Comparator buzzer

<b>Operation</b>	Produces beeps according to the comparison result.
<b>Display</b>	The [ <b>(••)</b> ] and [ <b>COMP</b> ] segments appear.
<b>Default setting</b>	Sounds for FAIL judgments
<b>How to set</b>	See “4.4 Setting the Comparator Buzzer” (p. 80).

## (8) Hold

<b>Operation</b>	Freezes displayed values (Suspends refresh of displayed values). Disabled when the voltage readout exhibits the [ <b>-----</b> ] segments.
<b>Display</b>	When the values freeze: The [ <b>HOLD</b> ] segment appears.
<b>How to set</b>	See “3.5 Using the Hold Function” (p. 59).

## (9) Automatic hold

<b>Operation</b>	Automatically freezes the measured values once the resistance value has been stabilized. The values are not refreshed sequentially.
<b>Display</b>	When the function is enabled: The [ <b>AUTO HOLD</b> ] segment appears. When the display is freezing: The [ <b>HOLD</b> ] segment appears.
<b>Default setting</b>	Disabled
<b>How to set</b>	See “3.6 Automatic Hold Function” (p. 61).



## (10) Memory

<b>Operation</b>	Saves, reads out, and deletes measured data. Saves and deletes profile information.
<b>Default setting</b>	Disabled
<b>Number of data sets</b>	6000
<b>Memory structure</b>	500 data sets per unit (12 units)
<b>Unit name</b>	A, B, C, D, E, F, G, H, J, L, N, and P
<b>Memory number</b>	Unit name with the number of 1 to 500 suffixed

<b>Saved items</b>	<p>Measured data can be saved in connection with profile information.</p>
	<p>Measured data (Saving, reading out, and deleting data are available by using the instrument)</p> <ol style="list-style-type: none"> <li>1. Date and time</li> <li>2. Resistance value, voltage value, temperature</li> <li>3. Comparator threshold values, comparison result</li> </ol>
	<p>Profile information (Saving, reading out, and deleting information are unavailable by using the instrument)          Saving, reading out, and deleting information are available by using the computer application software that comes with the instrument or through the Z3210.</p> <ol style="list-style-type: none"> <li>1. Profile number: Number between 1 and 100              Numbers cannot be duplicated.              The following information consisting of items 2, 3, and, 4, are saved for each profile number.</li> <li>2. Location information:              Strings at most 72 bytes in length              Example:              72 characters of one-byte alphabet and numbers              Any comment, such as the UPS location</li> <li>3. Device information:              Strings at most 72 bytes in length              Example:              72 characters of one-byte alphabet and numbers              Any comment, such as the UPS control number.</li> <li>4. Battery number: Number between 1 and 500 (start number, last number)              Numbers assigned to objects under measurement, which are used by the measurement recording voice prompt</li> </ol>
<b>Saving location</b>	<p>Saved in the internal non-volatile ROM.</p>
<b>How to save data</b>	<p>See “5.2 Saving Data in the Memory” (p. 87).</p>

## (11) Automatic memory

<b>Operation</b>	Automatically saves the measured data once the display has frozen the values. After displaying the <b>[USED]</b> segment, automatically increments the memory number by one. The saved data can be deleted using the <b>CLEAR</b> key.
<b>Display</b>	When the function is enabled: The <b>[AUTO MEMORY]</b> segment appears.
<b>Default setting</b>	Disabled
<b>How to set</b>	See "5.3 Automatic Memory Function" (p. 89).





## (12) Measurement recording prompt

<b>Operation</b>	The visual prompt on the display and the voice prompt inform the user about the battery number the user is to measure next. (The voice prompt, generated from a smart phone or a tablet, is available when the Z3210 and the supported application, GENNECT Cross are used)
<b>Preliminary preparation</b>	Store the profile information received from GENNECT Cross / GENNECT ONE, which are the supported applications (into the internal non-volatile ROM). (Profile numbers, battery numbers, and memory numbers corresponding to the battery numbers are necessary)
<b>Default setting</b>	Disabled
<b>How to start</b>	See "6 Measurement Recording Prompt Function" (p. 97).

### (13) Automatic power saving

<b>Operation</b>	Automatically turns off the instrument if inactivity continues or a measurement-current anomaly continues to be detected for 10 minutes ( $\pm 1$ minute).
<b>Display</b>	The [APS] segment appears.
<b>Default setting</b>	Enabled
<b>Conditions where the function is disabled</b> (The function is automatically disabled)	During communications While the measurement recording prompt is operating
<b>How to set</b>	See "1.4 Names and Functions of Parts" (p. 30).

### (14) Instrument's battery level detection

<b>Operation</b>	Displays instrument's battery level  (The accuracy can be guaranteed until the indicator blinks)
<b>Display</b>	Four-level indicator (For LR6 Alkaline batteries).  10.1 V or more  9.2 V to 10.1 V  8.0 V to 9.2 V  (blinking) 7.6 V to 8.0 V (Shutdown) Less than 7.6 V The indicator has an error of $\pm 0.2$ V.
<b>How to disable</b>	None

### (15) Date and time

<b>Operation</b>	24-hour clock; leap years are adjusted automatically.
<b>Accuracy</b>	Approx. 4 minutes per month

<b>Default setting</b>	2020/1/1 00:00 (in the yyyy/mm/dd hh:mm format) The instrument starts with the display in setup mode for the first time.
<b>How to set</b>	See “2.6 Setting the Date and Time” (p. 45).
<b>Other capabilities</b>	Backup capability Built-in backup lithium battery life: About 10 years

## (16) Backlight

<b>Operation</b>	Turning on/off the backlight of the display in white.
<b>Default setting</b>	Automatic backlighting shutoff enabled If inactivity continues or a measurement-current anomaly continues to be detected for 40 s ( $\pm 5$ s), the backlight will automatically be turned off.
<b>How to set</b>	(Enabling/disabling the automatic backlighting shutoff function) See “8.1 Backlight” (p. 115).

## (17) Self tests

<b>LCD</b>	Displays all segments. See “1.4 Names and Functions of Parts” (p. 30).
<b>ROM</b>	Accesses to check when the instrument is turned on.
<b>Other capabilities</b>	Detects the A/D converter and other hardware anomalies.



## (18) System reset

<b>Operation</b>	Reverts all the settings, excluding the comparator threshold values and saved data, to the factory default. See “9.5 Default Settings and Resettable Settings” (p. 139).
<b>How to reset</b>	See “8.4 System Reset” (p. 119).

## (19) Communicating via USB.

<b>Operation</b>	Handles commands to communicate with computers.
<b>System requirements</b>	Windows 8 or Windows 10 (During wireless communications, connecting the instrument with the Z3210 installed to a computer via the USB interface will automatically disable the wireless communications)
<b>How to communicate</b>	See “7.1 Communicating With a Computer” (p. 107).

## (20) Wireless communications (Only with the Z3210 installed)

<b>Operation</b>	Transfers measured values to a smart phone or a tablet to display. When the  segment hides: Wireless communications disabled When the  segment appears: Wireless communications enabled When the  segment blinks: Now communicating
<b>Default setting</b>	Enabled (When the instrument is turned on for the first time after the installation of the Z3210)
<b>Communications distance</b>	Approx. 10 m (line of sight)
<b>Supported applications</b>	GENNECT Cross for iOS GENNECT Cross for Android
<b>How to communicate</b>	See “7.2 Communicating With a Mobile Device” (p. 108).

## (21) The Z3210 HID setting

### (Only when the Z3210 is connected)

<b>Operation</b>	The Z3210 HID function can be enabled/disabled (The setting is saved in the Z3210). Disabled: Communicates with GENNECT Cross. Enabled: Transfers measured values to applications, such as a spreadsheet.
<b>Switching settings</b>	See "7.3 Z3210-to-Excel <sup>®</sup> Direct Data Entry Function (Excel <sup>®</sup> Direct Input Function, HID Function)" (p. 112)

## (22) Error display

<b>Operation</b>	Displays error messages.
<b>Display</b>	See "10.3 Error Messages" (p. 146).

## (23) Serial number display

<b>Operation</b>	Displays the instrument's serial number. See "1.4 Names and Functions of Parts" (p. 30).
------------------	---

## (24) Computer application software GENNECT ONE

<b>USB communications</b>	<ul style="list-style-type: none"> <li>• Reading out and deleting data saved in the memory</li> <li>• Editing and transferring the comparator table</li> <li>• Editing and transferring profile information</li> </ul>
<b>Computer</b>	<ul style="list-style-type: none"> <li>• Report generation function</li> </ul>

## **(25) Smart phone / tablet application software GENNECT Cross**

---

<b>Wireless communications (Model Z3210)</b>	<ul style="list-style-type: none"><li>• Reading out and deleting data saved in the memory</li><li>• Editing and transferring the comparator table</li><li>• Editing and transferring profile information</li><li>• Measurement recording prompt</li><li>• Updating the BT3554-50</li></ul>
<b>Smart phone / Tablet</b>	<ul style="list-style-type: none"><li>• Report generation function</li></ul>

---

## **(26) Converting the temperature measurement unit**

---

<b>Operation</b>	Celsius-to-Fahrenheit conversion (US specifications)
<b>How to set</b>	See "How to toggle the temperature measurement units" (p. 33)

---



## 9.5 Default Settings and Resettable Settings

✓: Reset, –: Not reset

Setting	Default setting	System reset	Startup reset
Date and time	2020/1/1 00:00 (in the yyyy/mm/dd hh:mm format)	–	–
Resistance range	3.000 mΩ	✓	–
Voltage range	6.000 V	✓	–
Zero adjustment	Not executed	✓	–
Automatic hold	Disabled* <sup>1</sup>	✓	–
Automatic memory	Disabled* <sup>1</sup>	✓	–
Comparator	Disabled	✓	–
Comparator buzzer	Sounds for FAIL judgments	✓	–
Comparator's voltage threshold values	Not set (0.000 mΩ, 0.000 V)	–	–
Voltage evaluation method	ABS (based on absolute value)	✓	–
Automatic power saving	Enabled	✓	–
Noise-frequency reduction	Disabled	✓	✓
Wireless communications	Enabled* <sup>2</sup>	✓	–
Wire break detection	Enabled	✓	✓
Backlight	Automatic backlighting shutoff enabled	✓	–
Memory function	Disabled	–	–
Measured data saved in the memory	None	–	–
Profile information saved in the memory	None	–	–

## Default Settings and Resettable Settings

Setting	Default setting	System reset	Startup reset
Memory number	A001	–	–
Temperature measurement unit	Degree Celsius	–	–

- \*1: Starting the measurement recording prompt will automatically enable the automatic hold and automatic memory.
- \*2: When the instrument is turned on for the first time after the installation of the Z3210, wireless communications will be automatically enabled.

## 10.1 Repair, Inspection, and Cleaning



### WARNING



Do not attempt to modify, disassemble, or try to repair the instrument. Doing so may cause a fire, electric shock, or injury.

### Calibration

The calibration period varies with the conditions and environment of use. It is recommended to determine a calibration period based on those factors and to have the instrument regularly calibrated by Hioki.

### Precautions for Transportation

Be sure to follow these precautions when transporting the instrument:

- Remove the LR6 Alkaline batteries from the instrument in order to avoid damage. Additionally, be sure to double box the instrument. Accidental damage suffered in transit is not covered by the warranty.
- Attach a description of the issue when sending out your instrument for repair.

### Cleaning

If the instrument becomes dirty, wipe the instrument clean with a soft cloth moistened with water or a neutral detergent. Wipe the display gently with a soft, dry cloth.

#### IMPORTANT

Never use solvents such as benzene, alcohol, acetone, ether, ketone, thinners or gasoline. Doing so could deform and discolor the instrument.

## Replacement parts and service lives

The performance of some parts used in the instrument may degrade during the course of extended use. To ensure your ability to use the instrument into the indefinite future, Hioki recommends regular replacement of these parts. Please contact your authorized Hioki distributor or reseller when you need to do so. Service life varies with the operating environment and frequency of use. Please note that performance is not necessarily guaranteed for the duration of the recommended replacement cycle.

Part name	Recommended replacement cycle	Remarks and conditions
Backup battery	About 10 years	Replace it if the time and date are completely wrong when the instrument is turned on.

## 10.2 Troubleshooting

If damage is suspected, read the "Troubleshooting" section to remedy the problem. If this does not help you, contacting your authorized Hioki distributor or reseller.

### Before returning the instrument for repair

If the instrument is not operating correctly, check the following:

Error	Cause	Solution
Nothing is displayed on the screen even after the power key is pressed.	The instrument's batteries are exhausted.	Replace them with fresh ones. (p. 39)
	The batteries have been inserted incorrectly.	Reinsert the batteries correctly. (p. 39)
Zero adjustment cannot be performed. The display shows the <b>[Err]</b> segments.	The fuse has blown.	Replace it with a new fuse. (p. 149)
	The 9772 Pin Type Lead has been short-circuited in an incorrect way.	Insert the test lead, with the marked (engraved) side facing you, into the holes of the zero-adjustment board. (p. 53)
The <b>Ω</b> or <b>V</b> key became inoperable.	The comparator function has been enabled.	Use the <b>COMP</b> key to disable the comparator function.
The <b>MEMORY</b> key is not responsive to the user's actions.	The display does not freeze the measured values.	Use the <b>HOLD</b> key to freeze the measured data.

Error	Cause	Solution
The display shows nothing even after the <b>READ</b> key is pressed.	This key cannot be used when no data has been saved.	–
The comparison result is not correct.	Incorrect comparator threshold values have been set.	Set the correct threshold values. (p. 71)
When the 9460 Clip Type Lead with Temperature Sensor is used, the display shows no temperature.	The 9460 Clip Type Lead with Temperature Sensor has been connected incorrectly.	Connect it correctly. (p. 68)
The display shows incorrect measurement values. <ul style="list-style-type: none"> <li>• The display shows the <b>[---</b> segments.</li> <li>• Both the <b>[OVER]</b> segment and the maximum display values blink.</li> </ul>	The test lead has been connected incorrectly.	Connect the test lead correctly. (p. 42)
	The test lead has a break.	Replace it with a new test lead.
	The fuse has blown.	Replace it with a new fuse. (p. 149)
	Zero adjustment has not been performed correctly.	Perform zero adjustment correctly. (p. 52)
An appropriate range has not chosen.	Use the range key to choose the appropriate range. (p. 49)	

Error	Cause	Solution
When the instrument is turned on, the clock does not keep good time.	The built-in backup lithium battery of the instrument needs to be replaced.	The user cannot replace the lithium battery. Contact your authorized Hioki distributor or reseller.
The instrument cannot communicate with GENNECT Cross.	The Z3210 Wireless Adapter is not connected.	Connect the Z3210 Wireless Adapter to the instrument. (p. 41)
	The Z3210 Wireless Adapter's HID setting has been enabled.	Disable the Z3210 Wireless Adapter's HID setting. Disconnect the instrument using your mobile device once, and restart GENNECT Cross. (p. 112)

## 10.3 Error Messages

If the display shows an error, follow a procedure described below to troubleshoot the error.

Message	Description	Solution
<b>Error</b>	Function error (Zero adjustment has ended in failure)	Connect the test lead correctly and perform zero adjustment. (p. 52)
<b>Error no AdJ</b>	Adjustment data error (No- adjustment error)	The instrument needs to be repaired. Contact your authorized Hioki distributor or reseller.
<b>Error Adc</b>	A/D converter communications error	
<b>Error 001</b> <b>Error 002</b> From <b>Error 011</b> to <b>Error 018</b>	Internal variable error	
<b>Error 008</b>	Z3210 communications error (Poor connection, malfunction of the Z3210 or hardware)	Replace the Z3210 with another one. If the instrument can communicate after the replacement, the Z3210 is faulty. If the instrument cannot communicate after the replacement, the instrument is faulty. Contact your authorized Hioki distributor or reseller.



Even if the [----] segments and the blinking [OVER] segment appear on the display (at the same time, the maximum display value blinks), this does not indicate an error.

- The display will show the [----] segments when the input terminals have been open-circuited.
- Both the [OVER] segment and the maximum display value will blink when the input value exceeds the measurable scope of the set range. Set the range correctly.

## 10.4 FAQ

Question	Answer
Can manganese batteries be used as a power source?	The continuous operating time (p. 121) of the instrument has been defined considering the use of LR6 Alkaline batteries. <b>Note that the use of manganese batteries will considerably reduces the continuous operating time.</b> (For about 2.5 hours, value used for reference purposes)
Can nickel-metal hydride batteries be used?	Can be used. However, there is a difference in discharge characteristics between nickel-metal hydride batteries and alkaline batteries. Hence, significant errors will develop in the instrument's battery level indicator when nickel-metal hydride batteries are used. <b>Due to those errors, note that the instrument may be suddenly shut down, regardless of the remaining battery life as shown by the battery level indicator.</b>
Is there a maximum capacity of batteries (amp-hours) of which the instrument can measure the internal resistance and voltage?	There is no limitation on the capacity of batteries because the instrument uses AC signals for measurement and DC current does not flow through the instrument.
What are the appropriate threshold values?	See "1.1 Evaluating Battery Deterioration" (p. 23).

## 10.5 Replacing the Fuse

If the fuse has blown, replace it as described below.

### WARNING

- Use a fuse only specified by Hioki.
- Failure to observe this could damage the instrument, resulting in bodily injury.
- Specified fuse: Model Z5050 Fuse Set (216.630, Littelfuse Inc., fast-acting, rating: 250 V / F 630 mA, interrupting rating: 1500 A)**

- 1 Turn off the instrument and remove the test lead.
- 2 Using a Phillips screwdriver, loosen the screw to remove the fuse cover on the rear of the instrument.
- 3 Remove the blown fuse and put a specified new fuse in the fuse holder.
- 4 Place the fuse cover and tighten the screw.

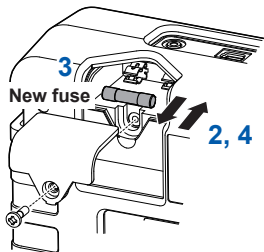

### IMPORTANT

Avoid hitting the fuse holders with a tool when replacing the fuse. Deformation of a fuse holder could result in poor contact between the fuse and holder, making measurement impossible.

## 10.6 Replacing the Tip Pin of the Test Lead

The conductive contact pin is replaceable. Replace the pin with a new one if it is broken or worn.

The 9465-90 Tip Pin, a single-piece construction of a conductive contact pin and a plastic pin base, is available at extra cost.

### For the 9465-10

- 1 Turn off the instrument and remove the test lead.**
- 2 Rotate the collet nut to loose, letting the cable be unfixed.**

(The cable has been fixed by tightening the collet nut.)

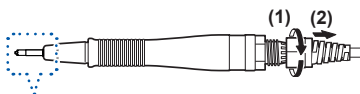

Model 9465-90 Tip Pin

To prevent a wire brake . . .

- Do not pull the cable.
- Do not twist the cable.

- 3 While pinching the pin base so that the cable dose not twist, rotate the grip to loosen.**

(1) Pinch the pin base tightly.

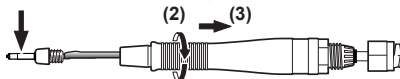

Beware of risk of injury from sharp end.

- 4 Pinch the transparent tube and pull the pin base to remove the tip pin.**

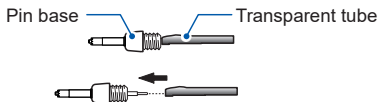

Do not subject the cable to stress to prevent a wire brake.

- 5 Insert a new 9465-90 Tip Pin and press the tip against a hard surface.**

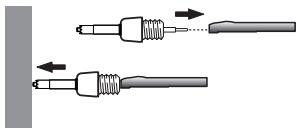

- 6 Assemble the grip in the reverse order of disassembling.**

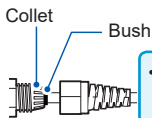

- To prevent a wire break, project the bush about 1 mm from the end face of the collet.
- Be careful not to push the bush too deeply.

Do not pull or twist the cable during assembling.

- 7 After tightening the collet nut, gently pull and twist the cable to check if it has firmly been fixed. Loose connections could cause a wire break or poor contact.**

- 8 Check for proper operation.**

Measure a non-defective object to check if the measured resistance is correct before use.

## For the L2020

- 1 Turn off the instrument and remove the test lead.**

- 2 Rotate the grip to loosen.**

Please beware of injury since the tip has a sharp point.

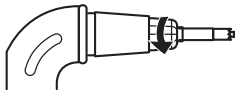

- 3 Remove the tip pin.**

Model 9465-90 Tip Pin

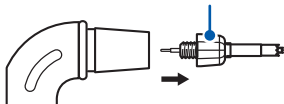

- 4 Insert a new tip pin.**

Model 9465-90 Tip Pin

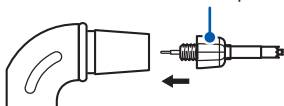

- 5 Rotate the grip to fasten.**

Fasten until it stops.

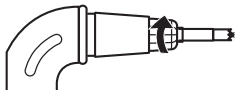

- 6 Check if it has been firmly fixed. Loose connections could cause a wire break or poor contact.**

- 7 Check for proper operation.**

Measure a non-defective object to check if the measured resistance is correct before use.

## 10.7 Disposing the Instrument (Removing the Lithium Battery)

When disposing of this instrument, remove the lithium battery and dispose of them in accordance with local regulations.

### CALIFORNIA, USA ONLY

Perchlorate Material – special handling may apply.

See [www.dtsc.ca.gov/hazardouswaste/perchlorate](http://www.dtsc.ca.gov/hazardouswaste/perchlorate)

- 1 Turn off the instrument and remove the test lead.**

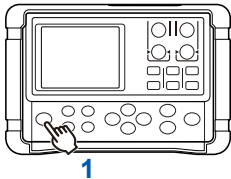

- 2 Remove the Z5041 Protector.**

- 3** Remove the four screws on the rear of the instrument using a Phillips screwdriver.
- 4** Pull off the cable connected to the battery holder.
- 5** Remove the upper PCB.
- 6** Using tweezers or a similar tool, remove the lithium battery mounted on the lower PCB.

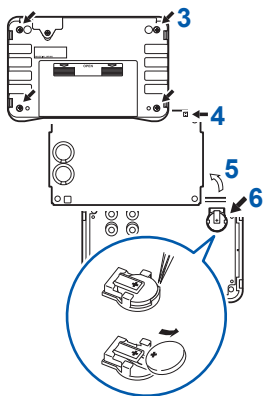



## 11.1 Effects of Extending the Test Lead and Induced Voltage

Custom-ordering enables the extension of a test lead. Contact your authorized Hioki distributor or reseller.

Do not attempt to extend a test lead by yourself.

### How to reduce induced voltages

---

The instrument, which uses AC to measure minute resistances, is susceptible to induced voltages. An induced voltage referred to here means a voltage that allows the current generated in the instrument to build an inductive coupling in the test lead and affects the signaling system.

Since there is a phase difference of 90 degrees from the AC current (reference signal), the induced voltage, if its level is low, can be ideally eliminated with synchronous detection. However, if its level is high, the induced voltage distorts the signals, causing incorrect synchronous detection. Since the induced voltage increases with the length of the test lead, the key to reducing the induced voltage is to shorten the test lead. Reducing the length of the branched section is particularly effective.

Even when a standard test lead is used, if its arrangement significantly differs between when zero adjustment was executed and when measurement was performed using the 3 m $\Omega$  range, the effects of the induced voltage can cause measurement values to vary by approximately 15 digits.

## 11.2 Effects of Eddy Currents

The AC current generated in the instrument induces eddy currents in the surrounding metallic plates. This could induce voltage in the test lead.

Since there is a phase difference of 90 degrees from the AC current (reference signal), the induced voltage cannot be eliminated with synchronous detection, resulting in measurement errors

The effects of eddy currents is a phenomenon unique to ohmmeters that measure resistance using an AC source. To protect the test lead from such effects, keep metallic parts, including metallic plates, away from the test lead (branched section).

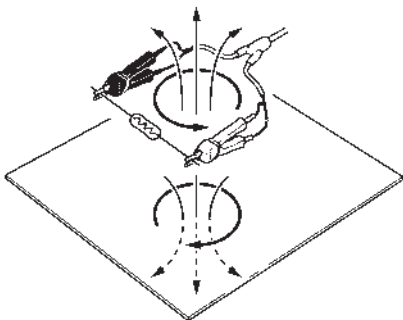

## 11.3 AC Four-Terminal Method Measurement

The instrument uses the AC four-terminal method for resistance measurement to cancel out wire resistance of the test lead and contact resistance between the test lead and the object under measurement. The following figure shows the principle of the AC four-terminal measurement method.

Resistance measurement circuit

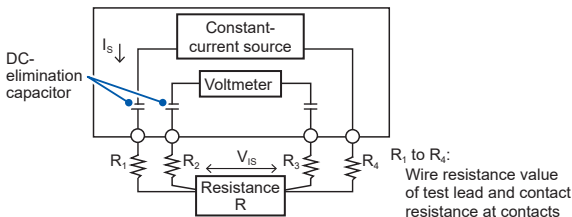

The instrument applies the AC current  $I_s$  from the instrument's SOURCE terminals to the object under measurement. The voltage drop  $V_{IS}$ , due to the impedance of the object under measurement, is measured across the SENSE terminals. At this time, the SENSE terminals connects to the internal high-impedance voltmeter. Thus, little current flows through the resistances  $R_2$  and  $R_3$ , a wire resistance and a contact resistance, respectively. As a result, little voltage drops across the resistances  $R_2$  and  $R_3$ . In this way, the voltage drop due to the resistances  $R_2$  and  $R_3$  is canceled out. The instrument uses synchronous detection to separate the internal impedance of the object under measurement into effective resistance and reactance and displays the effective resistance alone.

If one of the following resistances increases, the instrument can no longer normally flow current to the object under measurement:

- Wire resistance of test lead
- Contact resistance between the object under measurement and test lead
- Contact resistance between the test lead and instrument

In such cases, the instrument will fail to perform measurement and show the [----] segments as the resistance readout. For more information on measurement errors, see “Measurement error” (p. 67).

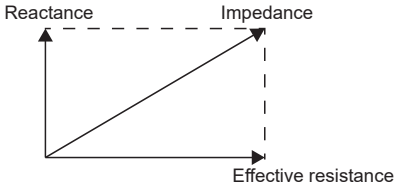

## 11.4 Effects of Current Density

### When an object under measurement is wide or thick

---

When an object under measurement is wide or thick, such as a plate or block, performing accurate measurements is difficult when a Clip Type Lead or Pin Type Lead is used. In such cases, variations in the contact pressure and contact angle could lead to variations in measurement values from a few to a few-dozen percent. For example, when the instrument measures resistance of a metal sheet 370 mm long, 300 mm wide, and 0.4 mm thick, measured values will significantly vary even the probes are placed into contact at the same locations on the sheet.

- Pin Type Lead  
with a pin-to-pin distance of 0.2 mm: 1.1 m $\Omega$
- Pin Type Lead  
with a pin-to-pin distance of 0.5 mm: 0.92 m $\Omega$  to 0.97 m $\Omega$
- Model 9287-10 Clip Type Lead: 0.85 m $\Omega$  to 0.95 m $\Omega$   
(Model 9287-10 has been discontinued)

This is not due to the contact resistance between probes and the object under measurement but the current distribution in the object. Figure 1 illustrates an example of plotted equipotential lines on a metal plate. Just like the relationship between winds and atmospheric pressure patterns, used in weather forecasts, current density is higher where the equipotential lines are close to each other; and lower farther apart. This figure shows that the vicinity of the current injecting points has steeper potential gradients. This is because the electric current, just now spreading across the metal plate, has a higher current density. Thus, when voltage detecting terminals are placed near the current injecting points, just the slightest change in contact positions can lead to major variation in measured values.

To avoid these effects, detect voltage across the two points located the inside of the two current injecting points using a four-terminal test lead such as the Hioki 9453 Four Terminal Lead. The current distribution is generally considered to become stable at a distance equivalent to the width or thickness or more inwardly away from the current injecting points.

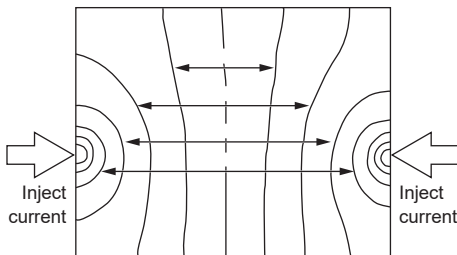

**Figure 1: Equipotential lines on a metal plate, showing the current distribution at 50  $\mu\text{V}$  intervals when a current of 1 A is injected from the distal points of the plate ( $W300 \times L370 \times t0.4$ )**

As shown in Figure 2, it is preferable to place the SENSE terminals at the points a distance equivalent to the width or thickness inwardly away from the SOURCE terminals are placed.

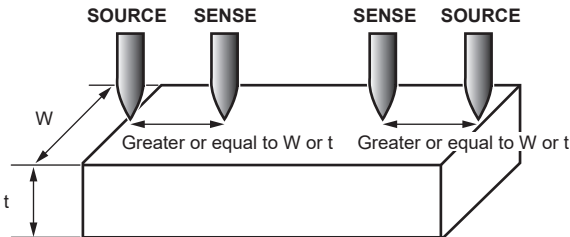

**Figure 2: Contact locations when the object under measurement is wide or thick**

**IMPORTANT**

It is important to keep track of variation over time in order to determine if a battery has deteriorated. Hence, use the same test lead for every measurement.

## 11.5 Synchronous Detection

The figure below provides an equivalent circuit for a battery. If an object under measurement include other components other than pure resistance component, as shown in this figure, synchronous detection can be used to obtain the effective resistance of the object under measurement. The synchronous detection is also used to separate faint signals from noise.

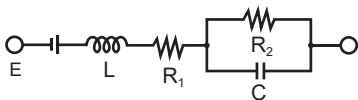

The synchronous detection is a detection method that can separate the signal component having the same frequency as the reference signal's frequency from a signal. The figure below illustrates a simplified schematic diagram of the synchronous detection method. The system consists of the multiply circuit, which multiplies two signals, and the low-pass filter (LPF), which allows only DC components of the multiply circuit output to pass.

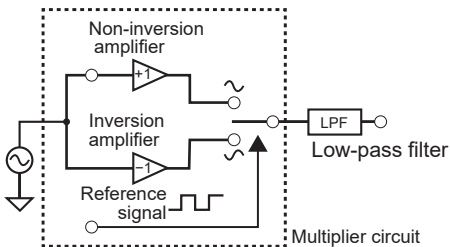



Where the reference signal voltage of the AC current generated in the instrument is  $v_1$ , the signal voltage for use in synchronous detection is  $v_2$ . These parameters may be expressed by the equation given below. A phase difference from  $v_1$ , due to a reactance component, is represented as  $\theta$  in the equation for  $v_2$ .

$$v_1 = A \sin \omega t$$

$$v_2 = B \sin(\omega t + \theta)$$

When synchronous detection applies to both  $v_1$  and  $v_2$ , they are expressed as follows:

$$v_1 \times v_2 = \frac{1}{2} B \cos \theta - \frac{1}{2} AB \cos(2\omega t + \theta)$$

The first term indicates the voltage drop due to the effective resistance. The second term is attenuated by the LPF. The instrument exhibits the first term.

## 11.6 Calibration

### ⚠ CAUTION



To avoid damage to the instrument, do not apply a voltage between the positive (+) SOURCE and SENSE terminals or between the negative (-) SOURCE and SENSE terminals. Also, do not perform measurements when the instrument has been turned off.

For the calibration environment, see the accuracy guarantee conditions in “9.3 Accuracy Specifications” (p. 125).

### Calibrating the resistance measurement unit

- Use standard resistors that are subject to minimal levels of deterioration with age and have stable temperature characteristics.
- Use four-terminal-structure resistors to avoid effects due to the resistors' leads.
- Always use the AC having a frequency of 1 kHz to calibrate the resistances. A wire-wound resistor, which has a higher inductance component, does not have effective resistance (the real part of impedance; the component displayed on the instrument) equivalent to pure resistance (DC resistance).
- Connect the instrument and a standard resistor as shown below:

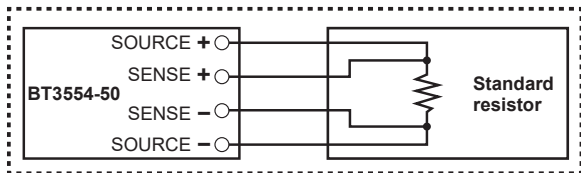

## Calibrating the voltage measurement unit

- Use a generator that can output a DC voltage of 60 V.
- Connect the instrument and generator as shown below:

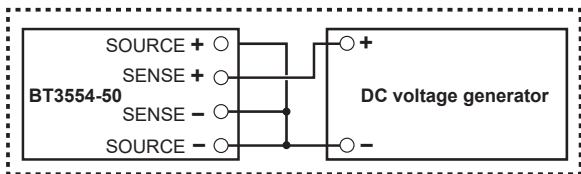

- Do not apply AC current from the instrument to the generator. Doing so may cause the generator to malfunction.
- Use a generator having a low output-impedance ( $50\ \Omega$  or less).
- If the [-----] segments are displayed, the wire-break detection function of the instrument needs to be disabled.

## How to disable the wire-break detection function

- 1** Turn off the instrument.
- 2** While holding down the **A.HOLD/A.MEM** key, turn on the instrument.

The **[on]** segments will blink.

- 3** Use the cursor keys to switch over from the **[on]** segments to the **[oFF]** segments.
- 4** Press the **ENTER** key.

The wire-break detection function will be disabled and the instrument will be restarted.

Restart the instrument after calibration. The wire-break detection function will be enabled again. Do not disable the wire-break detection function in normal use for measurement.

## A

---

AbS.....	75
Accuracy.....	11, 125
AC four-terminal method .....	157
Application software .....	107
APS .....	116
Automatic memory function .....	89
Automatic power saving function.....	116

## B

---

Backlight.....	115
Battery level indicator .....	118
Bundling the cables .....	43

## C

---

Calibration .....	141, 164
Clad-type stationary lead-acid battery .....	23
Communications function .....	105
Comparator buzzer.....	80
Comparator function .....	69
Comparator number .....	70, 72
Computer.....	107
Continuous operating time.....	121
CS.....	23
csv .....	105
Current density .....	159

## D

---

Date and time .....	45
Default settings list .....	120
Deleting .....	94, 95, 96
Deterioration evaluation values .....	63
Display.....	34

**E**

---

Eddy current .....	156
Excel® direct input function .....	112

**F**

---

Fuse .....	20, 149
------------	---------

**G**

---

GENNECT Cross .....	105
---------------------	-----

**H**

---

HID .....	112
High-rate-discharge paste-type stationary lead-acid battery .....	23
hok .....	105
Hold function .....	59
HS .....	23
Human interface device profile .....	112

**I**

---

Induced voltage .....	155
Initial value .....	63, 71
Input terminals .....	36
Installation .....	12
Internal resistance .....	23

**J**

---

Japanese Industrial Standards .....	23
-------------------------------------	----

**L**

---

Lithium-ion battery .....	25
---------------------------	----

**M**

Maximum input voltage.....	15
Maximum rated voltage to earth.....	15
Measurement error.....	67
Measurement range.....	49
Measurement recording prompt.....	97
Memory function.....	83
Model 9460 Clip Type Lead with Temperature Sensor.....	5, 55, 68
Model 9465-10 Pin Type Lead.....	4, 150
Model 9465-90 Tip Pin.....	4, 151
Model 9466 Remote Control Switch.....	6, 43, 60
Model 9467 Large Clip Type Lead.....	6, 55
Model 9772-90 Tip Pin.....	5
Model 9772 Pin Type Lead.....	5, 53
Model L2020 Pin Type Lead.....	4, 53
Model Z3210 Wireless Adapter.....	41
Model Z5038 0 Adj Board.....	7
Model Z5041 Protector.....	40
Model Z5050 Fuse Set.....	7, 20, 149
MSE.....	23

**N**

Neck strap.....	46
Noise-frequency reduction function.....	51

**O**

Operation keys.....	30, 32
Options.....	4

**P**

Pin tip.....	54, 150
PoL.....	75
Pre-measurement inspection.....	48
Profile information.....	84

**R**

---

Reading out the memory .....	92
Replacement parts .....	142
Resistance ranges.....	50, 73
Resistance rejection value.....	71, 74
Resistance warning threshold .....	71, 74

**S**

---

Saving.....	87
Sealed stationary lead-acid battery .....	23
Serial number .....	37
Synchronous detection.....	162
System reset.....	119

**T**

---

Temperature .....	5, 49, 68
TEMP.SENSOR terminal .....	68
Test lead .....	42
Threshold values .....	71

**U**

---

USB communications .....	107
--------------------------	-----

**V**

---

Voltage ranges.....	50, 73
Voltage warning threshold .....	71, 74

**W**

---

Warning display .....	67
Wire-break detection .....	127
Wire-break detection function.....	166



**Z**

---

Zero adjustment.....	52
Zero-adjustment board .....	53



# Warranty Certificate

# HIOKI

Model	Serial number	Warranty period Three (3) years from date of purchase ( ___ / ___ )
-------	---------------	--

Customer name: \_\_\_\_\_

Customer address: \_\_\_\_\_

### Important

- Please retain this warranty certificate. Duplicates cannot be reissued.
- Complete the certificate with the model number, serial number, and date of purchase, along with your name and address. The personal information you provide on this form will only be used to provide repair service and information about Hioki products and services.

This document certifies that the product has been inspected and verified to conform to Hioki's standards.

Please contact the place of purchase in the event of a malfunction and provide this document, in which case Hioki will repair or replace the product subject to the warranty terms described below.

### Warranty terms

1. The product is guaranteed to operate properly during the warranty period (three [3] years from the date of purchase).  
If the date of purchase is unknown, the warranty period is defined as three (3) years from the date (month and year) of manufacture (as indicated by the first four digits of the serial number in YYYY format).
2. If the product came with an AC adapter, the adapter is warranted for one (1) year from the date of purchase.
3. The accuracy of measured values and other data generated by the product is guaranteed as described in the product specifications.
4. In the event that the product or AC adapter malfunctions during its respective warranty period due to a defect of workmanship or materials, Hioki will repair or replace the product or AC adapter free of charge.
5. The following malfunctions and issues are not covered by the warranty and as such are not subject to free repair or replacement:
  - 1. Malfunctions or damage of consumables, parts with a defined service life, etc.
  - 2. Malfunctions or damage of connectors, cables, etc.
  - 3. Malfunctions or damage caused by shipment, dropping, relocation, etc., after purchase of the product
  - 4. Malfunctions or damage caused by inappropriate handling that violates information found in the instruction manual or on precautionary labeling on the product itself
  - 5. Malfunctions or damage caused by a failure to perform maintenance or inspections as required by law or recommended in the instruction manual
  - 6. Malfunctions or damage caused by fire, storms or flooding, earthquakes, lightning, power anomalies (involving voltage, frequency, etc.), war or unrest, contamination with radiation, or other acts of God
  - 7. Damage that is limited to the product's appearance (cosmetic blemishes, deformation of enclosure shape, fading of color, etc.)
  - 8. Other malfunctions or damage for which Hioki is not responsible
6. The warranty will be considered invalidated in the following circumstances, in which case Hioki will be unable to perform service such as repair or calibration:
  - 1. If the product has been repaired or modified by a company, entity, or individual other than Hioki
  - 2. If the product has been embedded in another piece of equipment for use in a special application (aerospace, nuclear power, medical use, vehicle control, etc.) without Hioki's having received prior notice
7. If you experience a loss caused by use of the product and Hioki determines that it is responsible for the underlying issue, Hioki will provide compensation in an amount not to exceed the purchase price, with the following exceptions:
  - 1. Secondary damage arising from damage to a measured device or component that was caused by use of the product
  - 2. Damage arising from measurement results provided by the product
  - 3. Damage to a device other than the product that was sustained when connecting the device to the product (including via network connections)
8. Hioki reserves the right to decline to perform repair, calibration, or other service for products for which a certain amount of time has passed since their manufacture, products whose parts have been discontinued, and products that cannot be repaired due to unforeseen circumstances.

**HIOKI E.E. CORPORATION**

<http://www.hioki.com>

18-07 EN-3





# HIOKI

[www.hioki.com/](http://www.hioki.com/)



**All regional  
contact  
information**

## **HEADQUARTERS**

81 Koizumi  
Ueda, Nagano 386-1192 Japan

## **HIOKI EUROPE GmbH**

Rudolf-Diesel-Strasse 5  
65760 Eschborn, Germany  
[hioki@hioki.eu](mailto:hioki@hioki.eu)

2103 EN

---

Edited and published by HIOKI E.E. CORPORATION

Printed in Japan

- CE declarations of conformity can be downloaded from our website.
- Contents subject to change without notice.
- This document contains copyrighted content.
- It is prohibited to copy, reproduce, or modify the content of this document without permission.
- Company names, product names, etc. mentioned in this document are trademarks or registered trademarks of their respective companies.