

HIOKI

PD3259-50

Instruction Manual

DIGITAL PHASE DETECTOR



EN

June 2021 Revised edition 1
PD3259C961-01 21-06H



Contents

Introduction.....	1
Checking Package Contents	2
Options (Sold Separately).....	3
Safety Information	4
Operating Precautions	9

1 Overview 13

1.1 Overview and Features	13
1.2 Part Names and Functions	15

2 Preparing for Measurement 21

2.1 Measurement Procedure	21
2.2 Attaching the Color Clips	22
2.3 Attaching the Strap	23
2.4 Installing/Replacing Batteries	24
How to install batteries.....	27
2.5 Installing the Z3210 Wireless Adapter.....	28
How to install the Z3210	29
2.6 Inspecting the Instrument	30

3 Performing Measurement 33

3.1 Switching the Screen Mode	33
3.2 How to Use Voltage Sensors.....	34
3.3 Affixing the Voltage Sensors.....	36
3.4 Measuring Line-to-Line Voltages in a Three-Phase Circuit	37
3.5 Checking the Phase Sequence in a Three-Phase Circuit (Phase Detection Function).....	39

3.6	Measuring the frequency	41
3.7	Displaying the Predicted Three-Phase Circuit Status	42
3.8	Power Key Combinations	43
	Auto-power save function	45
	Disabling the auto-power save function.....	46
	Switching the phase display (Phase display switching function).....	47
	Beeping sound setting	48
	Checking the firmware version information and serial number	49
3.9	Hold Function	50
	Setting the hold function	50
3.10	Backlight Function	51
	Enabling the backlight function	51
3.11	Wireless Communications Function	52
	Using GENNECT Cross (application)	52
	Z3210-to-Excel® direct data entry function (Excel® direct input function, HID function)	56

4 Specifications 61

4.1	General Specifications	61
4.2	Input Specifications / Measurement Specifications	63
	Basic specifications	63
	Accuracy specifications	64
4.3	Functional Specifications	65
4.4	Other Specifications	65

5	Maintenance and Service	67
5.1	Repair, Calibration, and Cleaning	67
5.2	Troubleshooting	68
	Errors and status codes	72
6	Appendix	73
6.1	Three-Phase System	73
6.2	Voltage Sensors of the PD3259-50	74
	Index	77
	Warranty Certificate	

Introduction

Thank you for choosing the Hioki PD3259-50 Digital Phase Detector. To ensure your ability to get the most out of this instrument over the long term, please read this manual carefully and keep it available for future reference.

Checking Package Contents

When you receive the instrument, inspect it to ensure that no damage occurred during shipment.

Pay particular attention to accessories, panel keys, and connectors. If you find any damage or discover that the instrument does not perform as indicated in its specifications, please contact your authorized Hioki distributor or reseller.

Confirm that these contents are provided.

- Model PD3259-50**
Digital Phase Detector

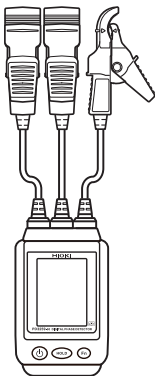

Accessories

- LR6 Alkaline batteries ×4**



- Instruction manual**
(This document)

- Operating Precautions**
(0990A907)

- Spiral tubes (black)**



- Color clips (white, red, blue, yellow)**



×2 (each color)

- Model C0203**
Carrying Case



Options (Sold Separately)

The options listed below are available for the instrument. To order an option, please contact your authorized Hioki distributor or reseller.

Options are subject to change. Please check Hioki's website for the latest information.

Model Z5020 Magnetic Strap (p.23)



Using this strap lets you attach the instrument on a wall, such as a metal surface.

Model Z3210 Wireless Adapter (p.28)



Installing the Z3210 to the instrument lets you receive and send data wirelessly.

See “3.11 Wireless Communications Function” (p.52).

Safety Information

This instrument is designed to conform to IEC 61010 Safety Standards, and has been thoroughly tested for safety prior to shipment. However, using the instrument in a way not described in this manual may negate the provided safety features. Carefully read the following safety notes before using the instrument.

CAUTION



- Mishandling during use could damage to the instrument. Familiarize yourself with the instructions and precautions in this manual before use.
- If you have not used any electrical measuring instruments before, you should be supervised by a technician who has experience in electrical measurement.

Protective gear







WARNING









Performing measurement using this instrument involves live-line work. To prevent an electric shock, use appropriate protective insulation and adhere to applicable laws and regulations.

Notations



In this document, the severity levels of risk and hazard are classified as follows.

 DANGER	Indicates an imminently hazardous situation that will result in death of or serious injury to the operator.
 WARNING	Indicates a potentially hazardous situation that may result in death of or serious injury to the operator.
 CAUTION	Indicates a potentially hazardous situation that may result in minor or moderate injury to the operator or damage to the instrument or malfunction.
IMPORTANT	Indicates information or content that is particularly important from the standpoint of operating or maintaining the instrument.
	Indicates a strong magnetic-field hazard. The effects of the magnetic force can cause abnormal operation of heart pacemakers and/or medical electronics.
	Indicates a high-voltage hazard. Failure to verify safety or improper handling of the instrument could lead to an electric shock, burn, or death.
	Indicates an action that must not be performed.
	Indicates the action that must be performed.
*	Indicates additional information is described below.
[]	Names of user interface elements on the screen are enclosed in brackets ([]).
HOLD (Boldface)	Alphanumeric characters shown in bold indicate the characters that appear on the control keys.

Symbols on the instrument

	Indicates the presence of a potential hazard. For more information about locations where this symbol appears on the instrument components, see a corresponding topic in the Instruction Manual.
	Indicates an instrument that has been protected throughout by double insulation or reinforced insulation.
	Indicates the grounding terminal.
	Indicates DC (Direct current).
	Indicates AC (Alternating current).
	Indicates the power button that switches the instrument between on and off states.

Symbols for various standards

	Indicates the Waste Electrical and Electronic Equipment Directive (WEEE Directive) in EU member states.
	Indicates that the product complies with standards imposed by EU directives.

Trademarks

- Microsoft Excel is either a registered trademark or a trademark of Microsoft Corporation in the United States and other countries.
- The Bluetooth® word mark and logos are registered trademarks owned by Bluetooth SIG, Inc. and any use of such marks by Hioki E.E. Corporation is under license. Other trademarks and trade names are those of their respective owners.

Segments on the screen

The screen of this instrument displays characters in the following manner.

A	B	C	D	E	F	G	H	I	J	K	L	M	N	O	P	Q	R	S	T	U	V	W	X	Y	Z
A	b	C	d	E	F	G	H	.	U	L	ñ	o	P	q	r	S	t	U	u	y	Y	z	z	z	z

1	2	3	4	5	6	7	8	9	0
1	2	3	4	5	6	7	8	9	0

Accuracy

Hioki expresses accuracy as error limit values specified in terms of percentages of reading and digits.

Reading (Displayed value)	Refers to the displayed value of the measuring instrument. The limit values of reading errors are expressed in percent of reading (% of reading, % rdg).
Digit (Resolution)	Refers to the smallest change in the indication on the digital measuring instrument, i.e., the numeral one in the rightmost place. The limit values of digit errors are expressed in terms of digits (dgt).

Measurement categories

To ensure safe operation of measuring instruments, IEC 61010 specifies the measurement categories, which classifies testing and measuring circuits into three categories according to the types of mains circuits to which they are intended to be connected.

DANGER



- **Do not use a measuring instrument for measurements on a mains circuit that exceeds the range of the measurement category rated for the instrument. Failure to observe this can cause a severe accident.**
- **Do not use a measuring instrument without a measurement category rating for measurements on a mains circuit. Failure to observe this can cause a severe accident.**

This instrument conforms to the safety requirements for CAT IV 600 V measuring instruments.

CAT II: Applicable to test and measuring circuits connected directly to utilization points (socket outlets and similar points) of the low-voltage mains installation.

CAT III: Applicable to test and measuring circuits connected to the distribution part of the building's low-voltage mains installation.

CAT IV: Applicable to test and measuring circuits connected at the source of the building's low-voltage mains installation.

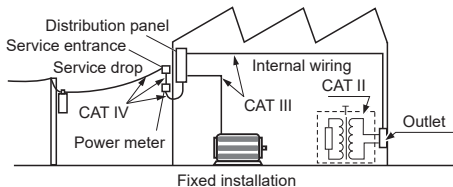

Operating Precautions

Observe the following precautionary information to ensure that the instrument can be used safely and in a manner that allows it to perform as described in its specifications.

Use of the instrument should conform not only to its specifications, but also to the specifications of all accessories, options, batteries, and other equipment in use.

WARNING



Do not use the instrument to measure circuits that exceed its ratings or specifications.

Damage to the instrument can cause an electric shock.

Check the instrument for any damage that may have occurred during storage or shipping, and perform functional checks before use.

If you find any damage, contact your authorized Hioki distributor or reseller.

This instrument complies with EN 61326 Class A.

This instrument may cause interference if used in residential areas.

Such use must be avoided unless the user takes special measures to reduce electromagnetic emissions to prevent interference to the reception of radio and television broadcasts.

Installation

DANGER



Individuals with electronic medical devices such as a pacemaker must not use the Z5020 Magnetic Strap. Such individuals must avoid even proximity to the Z5020 Magnetic Strap, as it could be dangerous. Medical device operation could be compromised, presenting a hazard to human life.

WARNING

Installing the instrument in inappropriate locations could cause a malfunction of the instrument or an accident.

Avoid locations that are:



- Exposed to direct sunlight or high temperature
- Exposed to corrosive or combustible gases
- Exposed to strong electromagnetic fields or electrostatic charges
- Near induction heating systems (such as high-frequency induction heating systems and IH cooking equipment)
- Susceptible to vibration
- Exposed to water, oil, chemicals, or solvents
- Exposed to high humidity or condensation
- Exposed to high concentrations of dust particles

Handling of the instrument

DANGER



To prevent an electric shock, do not touch any areas beyond the barrier while the instrument is in use.

CAUTION



To avoid damage to the instrument, do not subject it to vibration or mechanical shock during transportation and handling. Exercise particular care to avoid subjecting the instrument to mechanical shock, for example by dropping.

Turn off the instrument after use.

Handling the voltage sensors

IMPORTANT

If the target to be measured is an insulated cable with dirt or moisture on its insulation, the instrument may read lower values than the actual voltage. In this case, wipe it clean with a dry cloth before measurement.

Failure to do so may cause inaccurate measurement, in particular, if the measurement is performed with multi-conductor, heavily insulated, or dirty cables.

Handling of the cables

WARNING



To prevent an electric shock, check that the inside of the cable is not exposed. If any color is visible from the inside of the cable, do not use the instrument.

CAUTION



- Avoid stepping on or pinching cables, which could damage the cables insulation.
- To prevent damage due to snapped wires, do not bend or pull the base of the voltage sensor or cables.



The cable is hardened in freezing temperatures. Do not bend or pull it to avoid tearing its shield or breaking cables.

Precautions when transporting the instrument

CAUTION



During shipment of the instrument, handle it carefully so that it is not damaged due to a vibration or shock.

1.1 Overview and Features

The PD3259 is a phase detector with an integrated voltmeter that can measure line-to-line voltages, check phase sequence, measure frequency, and check for live cables and the grounding phase in three-phase circuits.

Thanks to no-metal-contact voltage measurement technology, you can measure voltage by just affixing the voltage sensors to cables, facilitating safe working conditions. In addition, because the instrument lets you measure line-to-line voltages, verify that cables are live, and check phase voltages and the grounding phase at once, it will eliminate wiring errors and reduce work times.

By installing the Z3210 Wireless Adapter (optional) in the instrument, you can log measured data acquired through the instrument and create measurement reports with your mobile communications devices.

Three-phase line-to-line voltage measurement

Measures line-to-line voltages in a three-phase circuit from outside the cable insulation (without any metal contact).

Frequency measurement

Open-phase prediction function

Phase detection function

Determines whether the three-phase circuit has positive or negative (reverse) phase sequence.

Hold function

Freezes the measured values and phase detection result shown on the display.

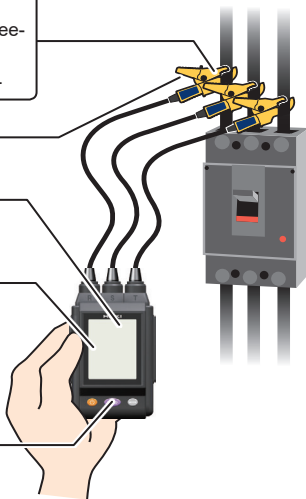

1.2 Part Names and Functions

Front

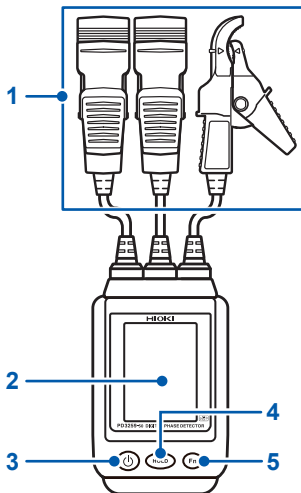

1	Voltage sensors	Detect voltage.	p.34
2	Display	Shows measured values and judgment results.	p.18
3	Power key	Turns on/off the instrument.	–
4	HOLD key	Freezes the judgment result and measured values shown on the display. Simultaneously pressing and holding the HOLD and Fn keys toggles the wireless communications function on and off.	p.50 p.52
5	Fn key	Switches over the screen and function. Simultaneously pressing and holding the HOLD and Fn keys toggles the wireless communications function on and off.	p.33 p.52

Rear

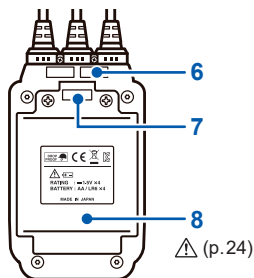

6	Serial number label	The 9-digit serial number indicates the year (first two digits) and the month of manufacture (next two digits).	p.49
7	Strap slot	Attach the Z5020 Magnetic Strap (optional) here.	p.23
8	Battery cover	Remove the cover when replacing the batteries.	p.24

Voltage sensors

1

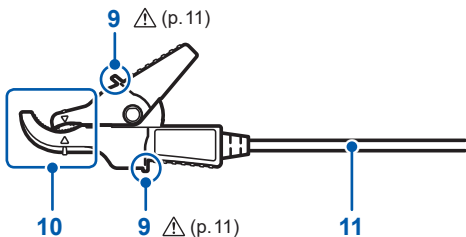

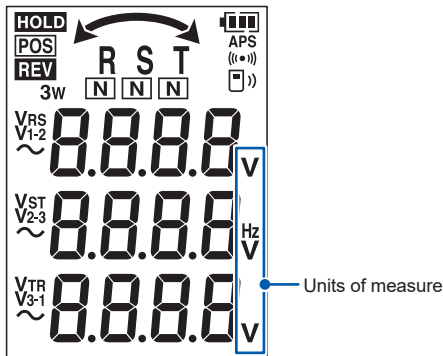

9	Barriers	To prevent an electric shock, do not touch any areas beyond the barrier while the instrument is in use.	p.34
10	Clips	Affix the clips to each insulated cable to be measured so that the mark points to the cable.	p.34
11	Cables	You can attach the color clips, which came with the instrument, here.	p.22

Display



HOLD	Indicates that the hold function is enabled.	p.50
((••))	Indicates that the beeping sound setting for the phase detection function is enabled.	p.39
APS	Indicates that the auto-power save function is enabled.	p.45
	Indicates the remaining battery level.	p.26
R S T (1 2 3)	Indicates phases. The screen mode can be switched. If an open phase is suggested, the indicator for corresponding phase will be hidden.	p.42 p.47
V_{RS} (V_{1-2})	Indicates that the line-to-line voltage V_{RS} (V_{1-2}) is displayed.	p.37
V_{ST} (V_{2-3})	Indicates that the line-to-line voltage V_{ST} (V_{2-3}) is displayed.	p.37
V_{TR} (V_{3-1})	Indicates that the line-to-line voltage V_{TR} (V_{3-1}) is displayed.	p.37
~	Indicates the circuit under measurement carries AC (alternating current).	—

POS	Indicates that the phase detection function determines the circuit has a positive phase sequence.	p.39
REV	Indicates that the phase detection function determines the circuit has a negative (reverse) phase sequence.	p.39
N	Indicates that the phase is predicted to be the grounding phase.	p.42
	Indicates whether the circuit has positive or negative (reverse) phase sequence using the arrow direction.	p.39
3W	Indicates the measurement target is a three-phase three-wire circuit.	–
	Indicates the status of the wireless communications.	p.52

2.1 Measurement Procedure

Before using the instrument, be sure to read “Operating Precautions” (p.9).

Setting up, connecting, and turning on the instrument

Insert the batteries. (p.24)

Inspect the instrument before use. (p.30)

Turn on the instrument. (p.15)

Affix the voltage sensors. (p.34)

Arrange to use other options as needed.

Performing measurement

Perform measurement. (p.33)

- Measuring line-to-line voltages in a three-phase circuit (p.37)
- Checking phase sequence in a three-phase circuit (phase sequence detection) (p.39)
- Measuring the frequency (p.41)

Freeze the measured values and phase sequence judgment result shown on the display. (p.50)

Finishing measurement

Turn off the instrument. (p.15)

2.2 Attaching the Color Clips

Attach the accompanying color clips and spiral tubes as needed. Attaching the color clips (white, red, blue, and yellow) to make the voltage sensors distinguishable from each other.

Color-code the sensors according to the three-phase labeling system of your country or region.

You can bind cables together using the spiral tubes.

- 1** Attach the clips with the same color on the clip side and the instrument side of each cable.
- 2** Bind cables together using the spiral tubes.

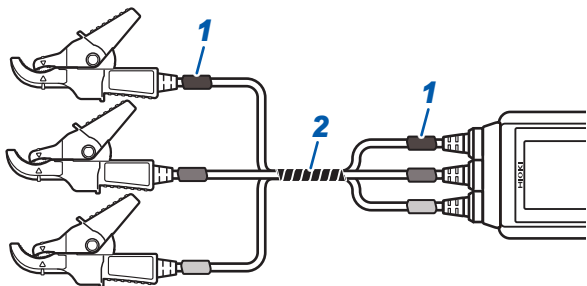

2.3 Attaching the Strap

Attaching the Z5020 Magnetic Strap (optional), which is equipped with a magnet, to the instrument lets you attach the instrument on a steel plate or wall surfaces.

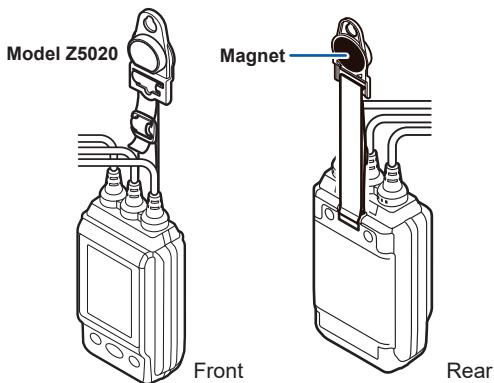
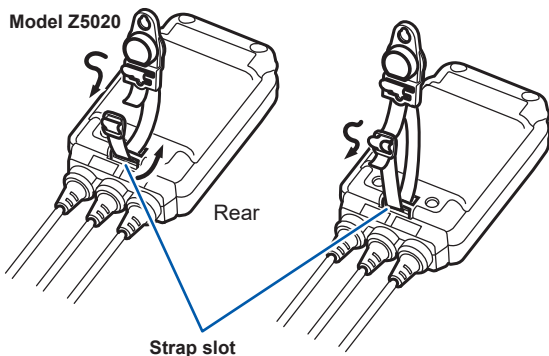

2.4 Installing/Replacing Batteries

When using the instrument, insert four LR6 Alkaline batteries. Verify that sufficient battery power remains before measurement. If the batteries are exhausted (p.26), replace the batteries with fresh ones.

WARNING



- **To avoid an electric shock, turn off the instrument and remove the voltage sensors from the target under measurement before replacing the batteries.**



Do not short-circuit, recharge, disassemble the batteries, or dispose of them in fire. Batteries may explode if mistreated.



To prevent instrument damage or an electric shock, use only the screws that are originally installed for securing the battery cover in place. (M3 × 8 mm)
If you have lost any screws or find that any screws are damaged, please contact your authorized Hioki distributor or reseller for a replacement.

 **CAUTION**





Poor performance or damage from battery leakage could result.

- Do not mix old and fresh batteries, or different types of batteries.
- Pay attention to the polarity markings, “+” and “-,” so that you do not insert the batteries the wrong way around.
- Do not use batteries after their recommended expiry dates.
- Do not leave a depleted battery inside the instrument.
- Replace batteries only with the specified type of ones.
- Remove the batteries from the instrument if it is to be stored for a long time.



- Handle and dispose of batteries in accordance with local regulations.
- When the batteries are exhausted, the  symbols will blink. In this case, the accuracy of any values are not guaranteed. Thus, replace the batteries with fresh ones as soon as possible.

Battery indicator

	<p>Batteries partially discharged.</p>
	<p>The graduations in the indicator disappear from the left as the battery's power falls.</p>
	<p>Low batteries. Keep fresh batteries handy.</p>
	<p>Blinking The batteries have run out. Replace the batteries with fresh ones immediately. If you continue to use, the instrument can be unexpectedly shut down. Measurement accuracy cannot be guaranteed in this state.</p>

The battery indicator provides a rough guideline of how much continuous operating time remains.

Shutdown



When the indicator shows no remaining battery power (the  icon is blinking), the string **[bAtt Lo]** will be shown for 2 s, and the instrument will shut down.

How to install batteries

You will need:

- Phillips-head screwdriver (No. 2)
- LR6 Alkaline batteries ×4

- 1** Remove the voltage sensors from the target under measurement and turn off the instrument.
- 2** Loosen the screws that holds the battery cover in place with the screwdriver and remove the cover.
- 3** If replacing the batteries, remove all old batteries.
- 4** Insert four fresh batteries, observing the polarity markings.
- 5** Reattach the battery cover and tighten the screws.

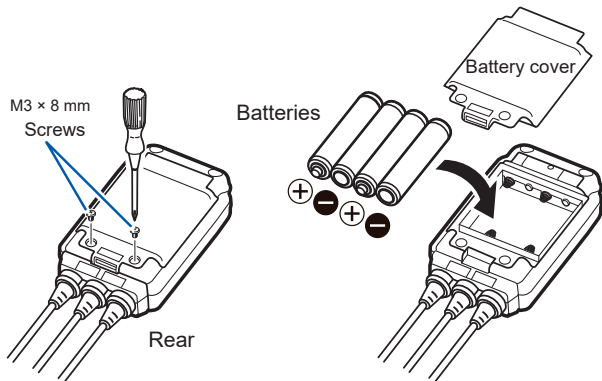

Do not remove the protective cover (p.29) on the Z3210 insertion slot. Doing so could impair the dust resistance and water resistance.

2.5 Installing the Z3210 Wireless Adapter

By installing the Z3210 Wireless Adapter (optional) in the instrument, you can wirelessly log measured data acquired through the instrument and create measurement reports with your mobile communications devices.

See “3.11 Wireless Communications Function” (p.52).

WARNING



- **To avoid an electric shock, turn off the instrument and remove the voltage sensors from the target under measurement before installing the Z3210.**



- **After installing the Z3210, reattach the protective cover and battery cover and secure the screws before using the instrument.**
- **To prevent instrument damage or an electric shock, use only the screws that are originally installed for securing the battery cover in place. If you have lost any screws or find that any screws are damaged, please contact your authorized Hioki distributor or reseller for a replacement.**

CAUTION



After touching any metallic part, such as a doorknob, to eliminate static electricity from your body, connect/disconnect the Z3210. Failure to do so could cause static electricity to damage the Z3210.

How to install the Z3210

You will need:

- Phillips-head screwdriver (No. 2)
- Model Z3210 Wireless Adapter

- 1** Remove the voltage sensors from the target under measurement and turn off the instrument.
- 2** Loosen the screws that holds the battery cover in place with the screwdriver and remove the cover.
- 3** Remove the protective cover from the Z3210 insertion slot.
- 4** Install the Z3210, observing the correct orientation, as far as it will go.
- 5** Attach the protective cover into the Z3210 insertion slot.
- 6** Reattach the battery cover and tighten the screws.

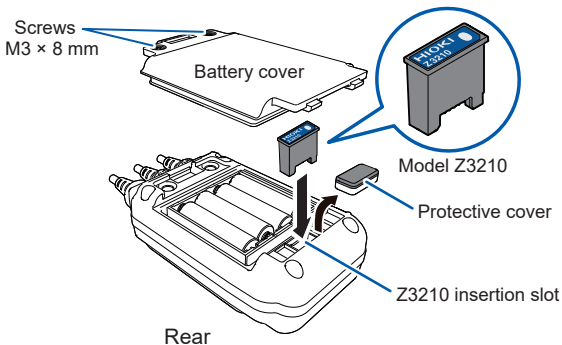

To maintain the dust resistance and water resistance, put the protective cover on the Z3210 insertion slot regardless of the presence or absence of the Z3210.

2.6 Inspecting the Instrument

Check the instrument for any damage that may have occurred during storage or shipping, and perform functional checks before use. If you find any damage, contact your authorized Hioki distributor or reseller.

Checking item	Action
Does an error code appear on the display?	When an error code appears, see "Errors and status codes" (p.72) to identify the error.
Are there any cracks or other damage?	The instrument's insulation may have been compromised. Avoid using the instrument and have it repaired. Failure to do so could cause an electric shock.
Is the cables' insulation damaged, or is any metal exposed?	If there is any damage, avoid using the instrument and have it repaired. Failure to do so could cause an electric shock.
Are the batteries exhausted?	If there is insufficient battery power remaining, replace the batteries with fresh ones. (p.24)
Does the display show something at the time of power-on?	If nothing is showing up, replace the batteries with fresh ones and check again. (p.24)

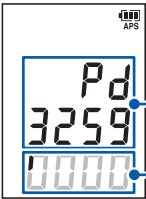
Checking item	Action
Does the display show the string “Pd3259” and a startup animation at the time of power-on?	<p>When the screen switches over from the power-on screen (the string “Pd3259” and the startup animation) to the measurement screen, the instrument operates normally. When an error code appears, see “Errors and status codes” (p.72) to identify the error.</p> <div data-bbox="440 637 870 895"><p>Power-on screen</p><p>The diagram shows a digital display with three sections. The top section contains the text 'Pd' above '3259'. The bottom section contains a sequence of four zeros '0000'. A battery icon and the letters 'APS' are in the top right corner. Blue lines with dots point from the text 'Pd3259' and 'Startup animation' to the corresponding elements on the display.</p></div>

3

Performing Measurement

3.1 Switching the Screen Mode

When you press the **Fn** key, the screen mode will switch over.

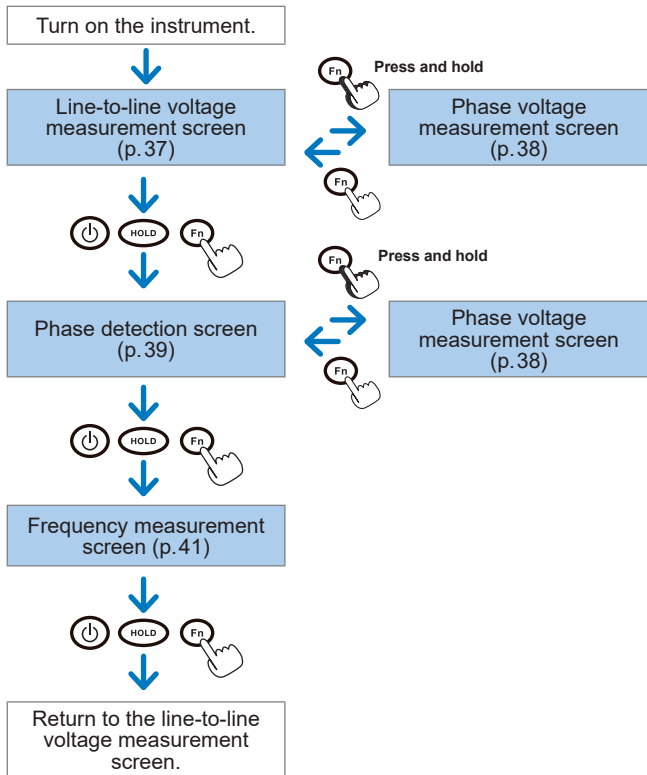

3.2 How to Use Voltage Sensors

How to affix the voltage sensors properly

Affix each sensor to an insulated cable to be measured so that the mark points to the cable. The sensor can be affixed to a cable with diameters ranging from 6 mm to 30 mm.

⚠ DANGER



To prevent an electric shock, do not touch any areas beyond the barrier while the instrument is in use.

Example: For thick insulated cables

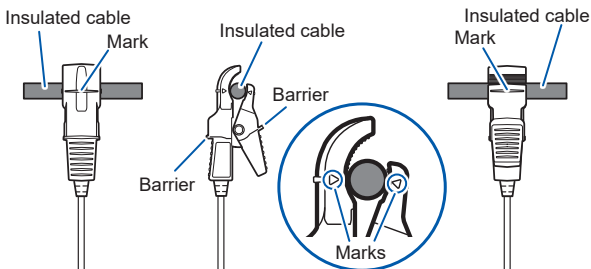

Example: For thin insulated wires

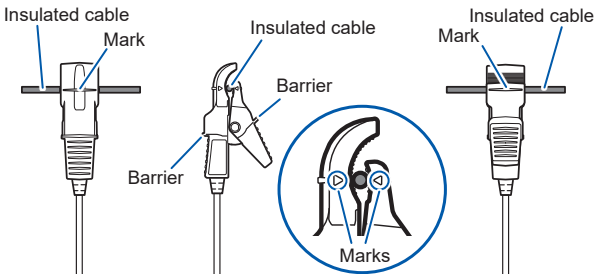

Improperly affixed sensor

A voltage sensor affixed improperly will be susceptible to effects of nearby cables, resulting in inaccurate measurement.

The insulated cable is pinched by the tips of the clip.

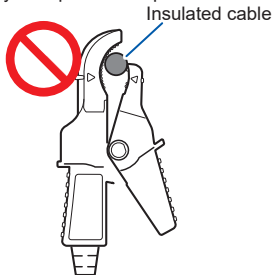

The sensor is affixed to the insulated cable at an angle.

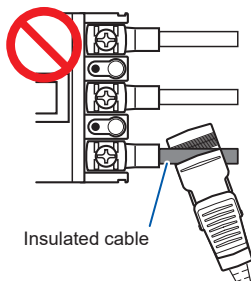

The insulated cable is inserted too close to the pivot point.

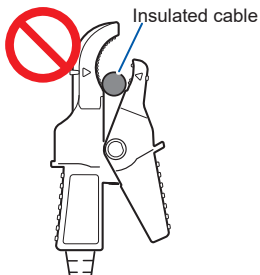

The sensor is affixed to two insulated cables together, each of which carries a voltage different from each other.

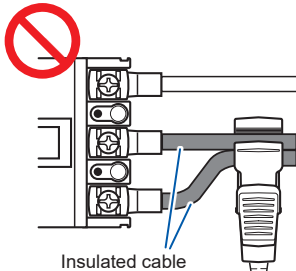

IMPORTANT

If an insulated cables under measurement are dirt or wet, the instrument may display values lower than the actual voltages. In this case, wipe them clean with a dry cloth before measurement.

3.3 Affixing the Voltage Sensors

Affix the voltage sensors R (1), S (2), and T (3) to the cables respectively of phase R (1), S (2), and T (3).

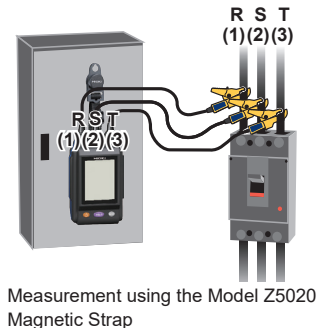
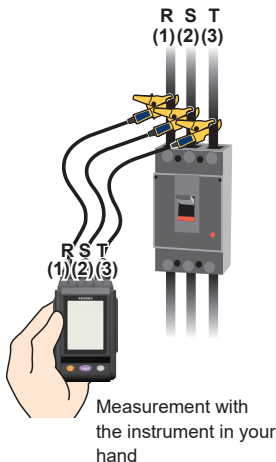

Phase labeling systems

Many labeling systems exist for three-phase systems.

<Examples>

First phase	Second phase	Third phase
R	S	T
L1	L2	L3
A	B	C
U	V	W

Affix voltage sensors R (1), S (2), and T (3) respectively to the first, second, and third phases of the three-phase circuit.

3.4 Measuring Line-to-Line Voltages in a Three-Phase Circuit

Three-phase line-to-line voltage measurement

The display will show voltages; V_{RS} , V_{ST} , and V_{TR} (or V_{1-2} , V_{2-3} , and V_{3-1}).

When measuring a three-phase circuit, the display will show the three line-to-line voltage values.



1 Display the line-to-line voltage measurement screen.

The line-to-line voltage measurement screen is displayed first at the time of the start-up. When you wish to display the phase detection screen, press the **Fn** key.

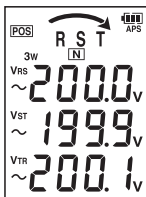

2 Check the measured values.

If the line-to-line voltage is less than 30.0 V, the string **[Lo]** will be shown; if the line-to-line voltage exceeds 600.0 V, the string **[ovEr]** will be shown.

The instrument can measure line-to-line voltage between any two voltage sensors affixed to a circuit other than the three-phase system.

Phase voltage measurement (values for reference purposes)

The display will show V_R , V_S , and V_T (or V_1 , V_2 , and V_3).

When measuring a three-phase circuit, the display will show the three phase voltage values. However, since the neutral line cannot be measured, the displayed values indicate a line-to-ground voltage of each phase using the virtual neutral point (ground) as the reference.

The displayed phase voltages, accuracy of which is not guaranteed, can be used for reference only.



1 Display the line-to-line voltage measurement screen.

The line-to-line voltage measurement screen is displayed first at the time of the start-up.



Press and hold

2 Press and hold the Fn key.

The phase voltage measurement screen will be displayed.

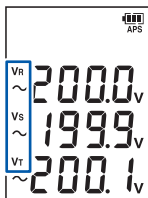

3 Check the displayed values.

If the phase voltage is less than 30.0 V, the string [Lo] will be shown; if the phase voltage exceeds 400.0 V, the string [ovEr] will be shown.



4 Press the Fn key.

The line-to-line voltage measurement screen will be displayed.

3.5 Checking the Phase Sequence in a Three-Phase Circuit (Phase Detection Function)

The instrument displays the phase detection result when measuring a three-phase circuit.

The display will be backlit and the instrument will emit beeping sounds to indicate the phase detection result.

However, the instrument will emit no sound if the beeping sound setting is disabled. (p.48)



1 Display the phase detection screen. (p.33)

2 Check the phase detection screen.

When the circuit has positive phase sequence

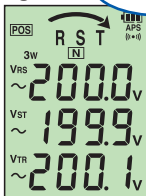

The display will show the following icons:

POS, , and .

The display will be backlit in yellow green, and the instrument will emit a series of short beeping sounds.

When the circuit has negative (reverse) phase sequence

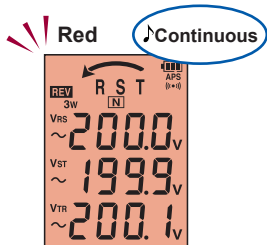

The display will show the following icons:

REV, , and .

The display will be backlit in red, and the instrument will emit a continuous beeping sound.

(The instrument will automatically stop beeping sounds after 10 s or once the hold function is enabled.)

If the instrument fails to detect phase sequence, the **POS** or **REV** icon or any arrow will not appear.



Press twice

3 Press the **Fn** key twice.

The line-to-line voltage measurement screen will be displayed.

3.6 Measuring the frequency

The instrument will measure the frequency of the line-to-line voltage V_{RS} .



- 1 Display the frequency measurement screen. (p.33)



- 2 Check the measured value. (The frequency of the line-to-line voltage V_{RS} will be displayed.)

When the measured frequency is less than 45.0 Hz, the string [Lo] will be shown; if the frequency exceeds 66.0 Hz, the string [ovEr] will be shown.



- 3 Press the Fn key.

The line-to-line voltage measurement screen will be displayed.

During frequency measurement, only the frequency of the line-to-line voltage V_{RS} is measured.

The instrument measures the frequency of the differential signal acquired between voltage sensors R (1) and S (2).

3.7 Displaying the Predicted Three-Phase Circuit Status

When measuring a three-phase delta-wired circuit with one phase grounded, the PD3259 can automatically predict the grounding phase.

In addition, the instrument can predict whether the three-phase circuit has an open phase.

The results are shown using icons on the display.

These functions are available only in Japan.



Grounding phase prediction

If phase S is grounded, the [N] icon will be shown underneath the S icon.

Similarly, if phase R is grounded, the [N] icon will be shown underneath the R icon; if the phase T is grounded, the [N] icon will be shown underneath the T icon.

(The similar display manner is used for the phase labeling system with 1, 2, and 3.)



Open-phase prediction

If the instrument predicts that the three-phase circuit has an open phase, the icon corresponding to that among the R S T icons (or the 1 2 3 icons) will be hidden.

Proper identification of the grounding phase or open phase is not guaranteed for these predictions. Results may be inaccurate if the circuit incorporates complex wiring or if the distance between the measurement point and a wire break point meets certain criteria.

3.8 Power Key Combinations

Use the keys at the time of start-up to configure the following settings:

- Auto-power save function
- Phase display switching function
- Beeping sound setting
- Firmware version number and serial numbers display

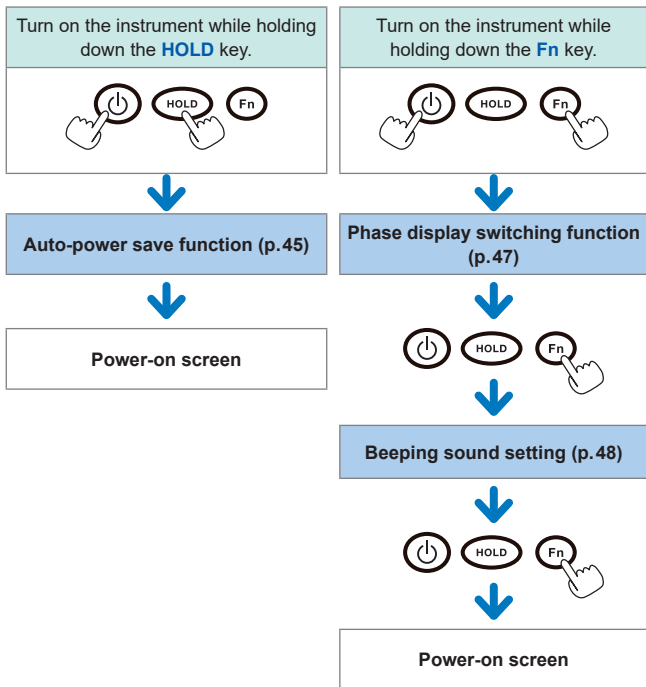

Power Key Combinations

Turn on the instrument while holding down the **HOLD** and **Fn** keys.



Firmware version information (p.49)



Serial number (p.49)



Power-on screen

If you press the **HOLD** and **Fn** keys simultaneously while the serial number is being displayed, the screen will enter the HID setting mode (p.57).

Auto-power save function

The instrument provides functionality for limiting battery consumption.

When the auto-power save function is enabled, the instrument will be automatically turned off after 10 minutes of inactivity.

(The instrument will emit a series of short beeping sounds starting 30 s before the power-off.)



The [APS] icon will be displayed.
(Indicating that auto-power save is enabled)

3

The auto-power save function will be enabled when the instrument is normally turned on.

This section describes how to disable the auto-power save function.
(p.46)

Disabling the auto-power save function

You can set the auto-power save function disabled.



Turn on the instrument while holding down the **HOLD** key.



The string **[APS OFF]** will be shown.

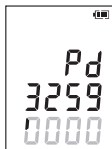

The power-on screen will be displayed.



The **[APS]** icon will be turned off.
(Indicating that auto-power save is disabled)

Switching the phase display (Phase display switching function)

This section describes how to choose between two phase labeling systems, one using “R S T” and one using “1 2 3”.

Phase display	“R S T”	“1 2 3”
Line-to-line voltage display	VRS, VST, VTR	V1-2, V2-3, V3-1



- 1 Turn on the instrument while holding down the **Fn** key.

3

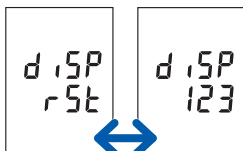

- 2 Press the **HOLD** key to choose the phase labeling system.
[rst] ↔ [123]



- 3 Press the **Fn** key.



- 4 Press the **Fn** key again.



After the power-on screen is displayed, the line-to-line voltage measurement screen will be displayed.

The phase display switching function setting will be saved and also applied at the next startup of the instrument.

Beeping sound setting

This section describes how to enable and disable the beeping sound setting.

You can set the instrument so that it emits beeping sounds when keys are pressed and the phase sequence is determined.



- 1 Turn on the instrument while holding down the **Fn** key.



- 2 Press the **Fn** key.

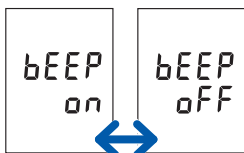

- 3 Press **HOLD** to choose whether to enable or disable the beeping sound setting.
[on]↔[off]



- 4 Press the **Fn** key.

After the power-on screen is displayed, the line-to-line voltage measurement screen will be displayed.

The beeping sound setting will be saved and also applied at the next startup of the instrument.

Checking the firmware version information and serial number

This section describes how to display firmware version information along with the instrument's serial number.



- 1 Turn on the instrument while holding down both the **HOLD** and **Fn** keys.

The string **[vEr]** and firmware version number will be displayed.

3



- 2 Press the **Fn** key.



- 3 Check the serial number.

Example: Serial number *201200001*
The serial number consists of nine digits. The first four digits indicate the year (its last two digits only) and the month of manufacture.



- 4 Press the **Fn** key.

After the power-on screen is displayed, the line-to-line voltage measurement screen will be displayed.

3.9 Hold Function

This section describes how to freeze measured values and phase detection results shown on the display.

The hold function can be used on the voltage measurement screen, phase detection screen, and frequency measurement screen.

Setting the hold function

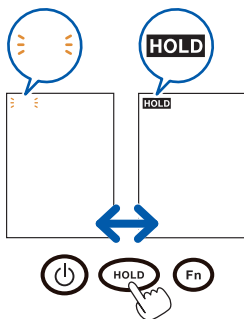

Press **HOLD** to choose whether to enable or disable the hold function.

When the **[HOLD]** icon is hidden (during normal operation):
The hold function is disabled.

When the **[HOLD]** icon is shown:
The hold function is enabled.
(The display will freeze the measured values and judgment results.)

When the instrument determines that the circuit has positive phase sequence or when it fails to detect phase sequence, the display will be backlit in green yellow. When the instrument determined that the circuit has negative (reverse) phase sequence, the display will be backlit in red.

3.10 Backlight Function

This section describes how to turn on the backlight. The backlight makes it possible to observe the display clearly in dim locations where the LCD would otherwise be difficult to see.

Enabling the backlight function



Press and hold



Yellow green



Pressing and holding the **HOLD** key to choose whether to enable or disable the backlight function.

Ordinarily the display will be backlit in yellow green; however, it will be backlit in red when the instrument determines that the circuit has negative (reverse) phase sequence. (p.39)

The backlight will be automatically turned off after 30 s regardless of the hold function setting or screen switching.

However, when the phase detection screen shows a phase detection result, the backlight will change in color depending of the phase detection result after 30 s has elapsed.

3.11 Wireless Communications Function

Using GENNECT Cross (application)

Enabling the wireless communications function lets you check measured data acquired through the instrument and create measurement reports with your mobile communications devices. The Z3210 Wireless Adapter is required to use this function. Concurrent use of GENNECT Cross and HID function (p.56) is not available.

For details, see the Help function in GENNECT Cross (free-of-charge application).



GENNECT Cross Special Site

<https://gennect.net/en/cross/index>



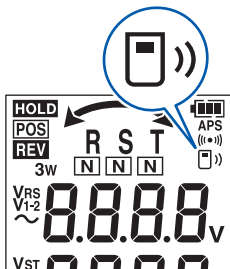

Blinking: While sending and receiving data wirelessly

On: Communications function enabled

Off: Communications function disabled

Simultaneously pressing and holding the **HOLD** and **Fn** keys toggles the wireless communications function on and off.

- 1 Connect the Z3210 Wireless Adapter into the instrument. (p.28)
- 2 Install GENNECT Cross onto your mobile communications device.
- 3 Turn on the instrument.
- 4 Press and hold the **HOLD** and **Fn** keys simultaneously to turn on the wireless communications function.
The display will show the  icon.
- 5 Start GENNECT Cross and register the instrument to connect.
- 6 Select each function and perform measurement.

- The communications distance is about 10 m with a clear line of sight. The communicable distance may vary greatly depending on the presence of an obstruction (wall or metallic shielding object) and the distance between the floor (ground) and instrument. To ensure the stable communications, make sure that the radio wave intensity is sufficient.
- GENNECT Cross is free of charge; however, the customer is responsible for the cost to download the application software and connect to the Internet when using the software.
- Some mobile communications devices cannot operate GENNECT Cross.
- The Z3210 uses the 2.4 GHz band wireless technology. When there is a device that uses the same frequency band such as a wireless LAN (IEEE 802.11, 802.11b, 802.11g, 802.11n) near your mobile communications device, the communications may not be established.
- When starting for the first time, GENNECT Cross will display the connection setting screen.
- GENNECT Cross with the connection setting screen shown will automatically register up to eight measuring instruments when they are located nearby.
- Leave the instrument for 5 s to 30 s after power up until the instrument is registered for connection. If no registration has completed after one minute has elapsed, restart GENNECT Cross and the instrument.
- When you turn on the instrument for the first time after installing the Z3210, the instrument will start with the wireless communications function enabled. The setting will be retained even after power off.

- Even when the Z3210 has been connected, GENNECT Cross or the Z3210's HID function cannot acquire any phase voltages. (p.38)
- When the Z3210 has been connected, GENNECT Cross and the Z3210's HID function can acquire unbalanced voltage ratios.

$$U_{\text{umb}} (\%) = \frac{(\text{Negative sequence voltage})}{(\text{Positive sequence voltage})} \times 100$$

Z3210-to-Excel[®] direct data entry function (Excel[®] direct input function, HID function)

The human interface device (HID) profile, with which the Z3210 Wireless Adapter is equipped, is a profile same as that wireless keyboards use.

Using this function requires the Z3210 Wireless Adapter (option). Concurrent use of GENNECT Cross (p.52) and HID function is not available.

Preparatory to data entry, open an Excel[®] file on your mobile device or computer and choose a cell. When the instrument's display freezes, the measured values will be entered on the cells. See "3.9 Hold Function" (p.50).

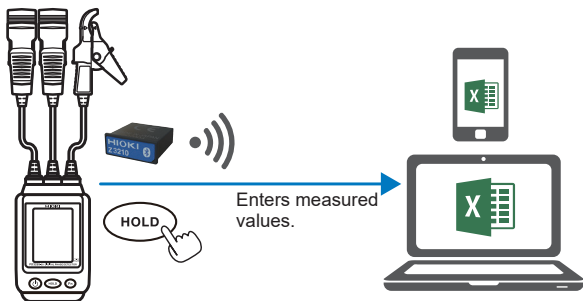

HID ON	Select to enter measured values in a Excel [®] , text, or other file. No communication with GENNECT Cross is available.
HID ON	Select to use GENNECT Cross.

The setting whether the HID function has been enabled or disabled will not be saved in the instrument but in the Z3210.

Setting the HID function



- 1 After making sure the instrument is tuned off, turn it on while holding down both the **HOLD** and **Fn** keys.

The firmware version number (p.49) will be displayed.



- 2 Press the **Fn** key.

The serial number (p.49) will be displayed.



- 3 Press the **HOLD** and **Fn** keys simultaneously.

The HID function setting will be displayed.

If you do not wish to switch the setting, turn the instrument off.

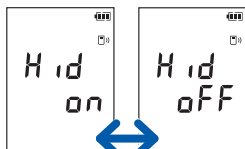

- 4 Press the **HOLD** key to choose whether to enable or disable the HID setting. **[on]↔[oFF]**



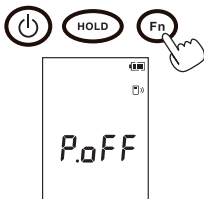

5 Press the **Fn** key.

The HID function setting will be confirmed.

After displaying **[P.oFF]**, the instrument will automatically be turned off.

IMPORTANT

To switch over from the HID function to GENNECT Cross
If you start GENNECT Cross without canceling the pairing between the mobile device and the instrument, GENNECT Cross may not be able to recognize the instrument as a connectible device.

Follow the procedure below to reconnect the instrument to GENNECT Cross.

1. Use the **Bluetooth**[®] setting of your mobile device to delete the instrument.
2. Disable the Z3210's HID function. (p.63)
3. Use the Instrument Setting of GENNECT Cross to reconnect the instrument.

3

For detail information, please visit the Z3210's website.

<https://z3210.gennect.net>



Learn more here !

4

Specifications

4.1 General Specifications

Operating environment	Indoors, pollution degree 2, altitude up to 2000 m (6562 ft.)
Operating temperature and humidity	-25°C to 50°C (-13°F to 122°F), 80% RH or less (no condensation) 50°C to 65°C (122°F to 149°F), 50% RH or less (no condensation)
Storage temperature and humidity	-25°C to 65°C (-13°F to 149°F), 80% RH or less (no condensation)
Dust resistance and water resistance	Main body (excluding voltage sensors): IP54 (EN 60529)
Standards	Safety: EN 61010 EMC: EN 61326 Class A
Power supply	LR6 Alkaline batteries ×4 Rated supply voltage: 1.5 V DC × 4 Maximum rated power: 3 VA
Continuous operating time	When using LR6 Alkaline batteries ×4 (value for reference purposes, at 23°C) <ul style="list-style-type: none"> • Approx. 5 h (display backlight off, Z3210 not installed, in standby mode) • Approx. 4 h (display backlight off, Z3210 installed, wirelessly communicating, in standby mode)
Dimensions	Main body: Approx. 84W × 146H × 46D mm (3.31"W × 5.75"H × 1.81"D)
Cable length	Approx. 0.5 m
Mass	Approx. 590 g (20.8 oz., including batteries)
Product warranty period	3 years

General Specifications

Accessories	See p.2.
--------------------	----------

Options	See p.3.
----------------	----------

4.2 Input Specifications / Measurement Specifications

Basic specifications

Measurement items	Three-phase AC voltage (line-to-line voltage, line-to-ground voltage, phase), frequency
Measurement targets	Insulated cables, metal parts Use on shielded cables not supported Three-phase system, 90.0 V AC to 520.0 V AC (45 Hz to 66 Hz)
Measurable conductor diameter	Outer diameter: $\phi 6$ mm to 30 mm
Voltage detection method	Coupled capacitance cancellation method
Rated voltage of voltage sensor	Line-to-ground voltage of 400 V AC per circuit where each voltage sensor is affixed
Voltage measurement method	Digital sampling, true RMS method
Measurement display format	LCD including three four-digit seven-segment representations
Response time	3 s or less
Display update rate	500 ms \pm 10 ms
Maximum rated line-to-ground voltage	600 V AC (CAT IV) Anticipated transient overvoltage: 8000 V

Accuracy specifications

Accuracy guarantee conditions	Accuracy guarantee period: 1 year Accuracy guarantee period after adjustment made by Hioki: 1 year Accuracy guarantee temperature and humidity range: 23°C ±5°C (73°F ±9°F), 80% RH or less Warm-up time: 10 s at a maximum Number of voltage sensor's clip open/close cycles: 8000 or less
Line-to-line voltage measurement accuracy	±2.0% rdg ±8 dgt (accuracy guaranteed for 1 year) ±3.0% rdg ±8 dgt (accuracy guaranteed for 3 years; value for reference purposes)
Frequency measurement accuracy	±0.5% rdg ±1 dgt
Effects of external magnetic fields	Within ±6.0 V in 400 A/m AC (50 Hz/60 Hz) field
Effects of nearby wires	Add ±4.0 V to measured voltage values. (Assuming an adjacent wire with a potential difference of 400 V AC is placed in contact with the voltage sensor's clip.)
Temperature coefficient	±0.4 V/°C (at temperatures outside a range of 23°C ±5°C)
Effects of humidity	Add ±4.0 V to measured voltage values. (When measuring insulated cables at a humidity range of 70% RH to 80% RH)
Line-to-line voltage phase difference drift	±5.0°

4.3 Functional Specifications

Phase detection function	Positive phase sequence, negative (reverse) phase sequence (three-phase three-wire system, three-phase four-wire system)
Open-phase prediction function	Prediction of an open phase.

4.4 Other Specifications

Hold function	Pressing the HOLD key freezes the displayed values.
Display backlight function	<p>The display will be backlit in yellow green when the hold function is enabled.</p> <p>However, it will be backlit in red when the instrument determines the circuit has negative (reverse) phase sequence.</p> <p>Pressing and holding the HOLD key activates the backlight.</p> <p>Backlight time: 30 s \pm 2 s at a maximum.</p>
Beeping sound function	<p>Key tone: Single tone</p> <p>When the phase detection function detects positive phase sequence: Intermittent tones</p> <p>When the phase detection function detects negative (reverse) phase sequence: Continuous tone (10 s \pm 1 s at a maximum)</p> <p>The beeping sound can be muted.</p>
Wireless communications (Only with the Z3210 installed)	<p>The wireless communications function can be toggled between on and off.</p> <p>(Press and hold the HOLD and Fn keys to toggle)</p> <p>Communications distance: About 10 m with a clear line of sight</p>

Auto-power save (APS)	The instrument will automatically be turned off after 10 minutes of inactivity. The auto-power-off function can be disabled.
Battery low warning	Remaining battery power is indicated (in 4 levels).
Drop-proof functionality	Onto concrete : 1 m.
Version update function	Updating the instrument's firmware is available using GENNECT Cross. Version requirements: GENNECT Cross (version 1.8 or later) Firmware (version 2.00 or later)

5.1 Repair, Calibration, and Cleaning**IMPORTANT**

If the instrument becomes dirty, wipe the instrument clean with a soft cloth moistened with water or a neutral detergent.

Disposal

Dispose of the instrument in accordance with local regulations.

Calibration

The calibration period varies with the conditions and environment of use. It is recommended to determine a calibration period based on those factors and to have the instrument regularly calibrated by Hioki.

5.2 Troubleshooting

If damage is suspected, read the “Troubleshooting” section to remedy the problem. If this does not help you, contacting your authorized Hioki distributor or reseller.

Before having the instrument repaired

Symptom	Cause	Remedy	Reference page
The screen does not show anything when the instrument is turned on.	Batteries other than specified type are used. Batteries are installed backwards.	Use the specified type of batteries only. Install the batteries, observing correct polarity as indicated by the markings.	p.24
	The batteries are exhausted.	Replace the batteries with fresh ones.	p.24
No measured values are shown on the display .	The voltage sensors are affixed to the cables under measurement improperly.	Properly affix the voltage sensors to the cables again.	p.34
	Two or three voltage sensors are affixed to one cable under measurement.	Affix each voltage sensor to just one cable.	p.34

Symptom	Cause	Remedy	Reference page
Measured values fail to stabilize.	The measurement target has a frequency other than 50 Hz or 60 Hz.	<p>The instrument is designed exclusively for use for measuring circuits with a frequency of 50 Hz and 60 Hz (accuracy guarantee frequency range: 45 Hz to 66 Hz).</p> <p>The instrument cannot accurately measure circuits with a frequency of 400 Hz, which is mainly used in ships and aircraft.</p>	-

Symptom	Cause	Remedy	Reference page
Phase detection results fail to stabilize.	The measurement target has a frequency other than 50 Hz or 60 Hz.	The instrument is designed exclusively for use for measuring circuits with a frequency of 50 Hz and 60 Hz (accuracy guarantee frequency range: 45 Hz to 66 Hz). The instrument cannot accurately measure circuits with a frequency of 400 Hz, which is mainly used in ships and aircraft.	-
	The voltage sensors are affixed to the cables under measurement improperly.	Properly Affix the voltage sensors again.	p.34
	Two or more voltage sensors are affixed to one cable under measurement.	Affix each voltage sensor to just one cable.	p.34
The instrument displays lower values than the actual voltage.	The insulated cables under measurement get soiled or wet.	Wipe the insulation surfaces clean with a dry cloth before measurement.	-
	The voltage sensors are placed closely on each other.	Place the voltage sensors on individual phases some distance away from each other.	-

Symptom	Cause	Remedy	Reference page
The instrument displays measured values with no signal inputted.	You are holding or moving a voltage sensor. There is electrically floating metal close to a voltage sensor.	The instrument may be subjected to effects of dielectric voltage, displaying values. This does not represent a malfunction.	-

Errors and status codes

The instrument will show error codes and other information, according to the error and operation status, on the display. If the instrument is in need of repair, contact your authorized Hioki distributor or reseller.

Code	Description	Remedy
Err 001	ROM error program	Replace the batteries with fresh ones. (p.24) If this fails to resolve the issue, the instrument is in need of repair.
Err 002	ROM error adjustment data	
Err 005	ADC error Hardware failure	
Err 008	Z3210 communications error Poor connection, failure in Z3210 or hardware	Follow the instruction below. Reconnect the Z3210. (p.28) Connect another Z3210. If the instrument still shows the error code, contact your authorized Hioki distributor or reseller.
Err 009	Firmware update error	Use GENNECT Cross to update the instrument again.
APS → P.oFF	Shutdown by auto-power save function	Turn on the instrument again. (p.15)
bAtt → P.oFF	Shutdown due to battery exhaustion	Replace the batteries with fresh ones. (p.24)

6.1 Three-Phase System

Three-phase 400 V line

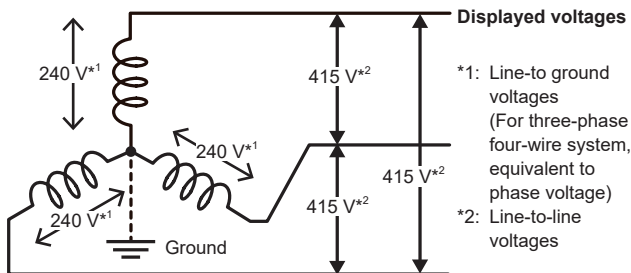

The 400 V line depicted in the figure has line-to-line voltages each of which is 415 V yet has line-to-ground voltages each of which is approximately 240 V. You can use a measuring instrument whose the input rating of a line-to-ground voltage is 300 V to measure this circuit

Each voltage sensor has an input rating of a line-to-ground voltage of 400 V, enabling the PD3259-50 to safely measure lines which has line-to-line voltages each of which is 415 V.

6.2 Voltage Sensors of the PD3259-50

Each voltage sensor of the instrument incorporates an internal electrode (metal plate). When the voltage sensor is affixed to the measurement target (cable), the minuscule current I flows due to capacitive coupling between the measurement target and the voltage sensor's internal electrode.

$$I = 2\pi fCV \quad (1)$$

f : Frequency of measurement target (Hz)

C : Capacitance between the measurement target and the voltage sensor's internal electrode (F)

V : Voltage (AC) between the measurement target and the voltage sensor's internal electrode (V)

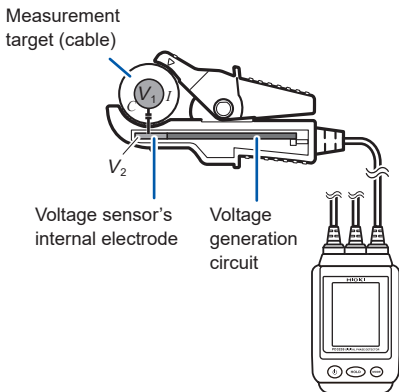

V_2 is controlled so that $I = 0$.
Assuming that $V_1 = V_2$ when $I = 0$, V_2 is measured.

Based on equation (1), $I = 0$ when $V = 0$ (when the measurement target and the voltage sensor's internal electrode have the same potential).

The instrument's voltage sensor detects the minuscule current I , and the voltage of the voltage sensor's internal electrode is controlled so that $I = 0$. The same voltage (V_2) as the measurement target's voltage (V_1) is generated internally by the sensor.

The instrument implements a voltage measurement method that does not require contact with exposed metal surfaces on the measurement target by measuring the voltage generated internally by the voltage sensor (V_2) when $V_1 = V_2$. (This method is known as the coupled capacitance cancellation method.)

Number

3W icon..... 19

A

APS icon..... 18, 45

Auto-power save function..... 18, 45

 Disabling..... 46

B

Backlight..... 51

Barriers..... 17, 34

Batteries..... 2, 24, 27, 61

Beeping sound..... 48, 65

C

Cable length..... 61

Cables..... 12, 17

Clips..... 17, 35

Color clips..... 2, 22

Communications function..... 52

Coupled capacitance..... 74

Coupled capacitance cancellation method..... 75

D

Display..... 15

E

Error codes..... 72

F

Firmware version information	49
Fn key	15
Frequency measurement	41, 64

G

GENNECT Cross	52
Grounding phase	42

H

HID	56
Hold function	50, 65
HOLD icon	18
HOLD key	15
Human interface device profile	56

I

Insulated cables	34, 63
------------------------	--------

L

Line-to-line voltage	18, 37
Line-to-line voltage measurement screen	37, 38

M

Magnetic Strap	3, 23
Model Z3210	3, 28, 52, 56
Model Z5020	3, 23

N

Negative (reverse) phase sequence	19, 40
---	--------

O

Open-phase prediction	42, 65
Options	3

P

Phase detection.....	18, 39, 65
Phase display	18, 47
Phase sequence.....	39
Phase voltage.....	38
POS icon	19
Positive phase sequence.....	19, 39
Power key.....	15
Power-on screen	31
Protective cover.....	29

R

Repair	68
REV icon.....	19

S

Serial number	16, 49
Shutdown.....	26
Spiral tubes.....	2, 22
Strap slot	16, 23

T

Three-phase line-to-line voltage measurement.....	37
---	----

V

Voltage sensors	15, 17, 34, 74
-----------------------	----------------

W

Wireless Adapter	3, 28, 52, 56
Wireless communications.....	28, 52

Warranty Certificate

HIOKI

Model	Serial number	Warranty period Three (3) years from date of purchase (___ / ___)
-------	---------------	--

Customer name: _____

Customer address: _____

Important

- Please retain this warranty certificate. Duplicates cannot be reissued.
- Complete the certificate with the model number, serial number, and date of purchase, along with your name and address. The personal information you provide on this form will only be used to provide repair service and information about Hioki products and services.

This document certifies that the product has been inspected and verified to conform to Hioki's standards.

Please contact the place of purchase in the event of a malfunction and provide this document, in which case Hioki will repair or replace the product subject to the warranty terms described below.

Warranty terms

1. The product is guaranteed to operate properly during the warranty period (three [3] years from the date of purchase).
If the date of purchase is unknown, the warranty period is defined as three (3) years from the date (month and year) of manufacture (as indicated by the first four digits of the serial number in YYMM format).
2. If the product came with an AC adapter, the adapter is warranted for one (1) year from the date of purchase.
3. The accuracy of measured values and other data generated by the product is guaranteed as described in the product specifications.
4. In the event that the product or AC adapter malfunctions during its respective warranty period due to a defect of workmanship or materials, Hioki will repair or replace the product or AC adapter free of charge.
5. The following malfunctions and issues are not covered by the warranty and as such are not subject to free repair or replacement:
 - 1. Malfunctions or damage of consumables, parts with a defined service life, etc.
 - 2. Malfunctions or damage of connectors, cables, etc.
 - 3. Malfunctions or damage caused by shipment, dropping, relocation, etc., after purchase of the product
 - 4. Malfunctions or damage caused by inappropriate handling that violates information found in the instruction manual or on precautionary labeling on the product itself
 - 5. Malfunctions or damage caused by a failure to perform maintenance or inspections as required by law or recommended in the instruction manual
 - 6. Malfunctions or damage caused by fire, storms or flooding, earthquakes, lightning, power anomalies (involving voltage, frequency, etc.), war or unrest, contamination with radiation, or other acts of God
 - 7. Damage that is limited to the product's appearance (cosmetic blemishes, deformation of enclosure shape, fading of color, etc.)
 - 8. Other malfunctions or damage for which Hioki is not responsible
6. The warranty will be considered invalidated in the following circumstances, in which case Hioki will be unable to perform service such as repair or calibration:
 - 1. If the product has been repaired or modified by a company, entity, or individual other than Hioki
 - 2. If the product has been embedded in another piece of equipment for use in a special application (aerospace, nuclear power, medical use, vehicle control, etc.) without Hioki's having received prior notice
7. If you experience a loss caused by use of the product and Hioki determines that it is responsible for the underlying issue, Hioki will provide compensation in an amount not to exceed the purchase price, with the following exceptions:
 - 1. Secondary damage arising from damage to a measured device or component that was caused by use of the product
 - 2. Damage arising from measurement results provided by the product
 - 3. Damage to a device other than the product that was sustained when connecting the device to the product (including via network connections)
8. Hioki reserves the right to decline to perform repair, calibration, or other service for products for which a certain amount of time has passed since their manufacture, products whose parts have been discontinued, and products that cannot be repaired due to unforeseen circumstances.

HIOKI E.E. CORPORATION

<http://www.hioki.com>

18-07 EN-3

HIOKI

www.hioki.com/



**All regional
contact
information**

HEADQUARTERS

81 Koizumi
Ueda, Nagano 386-1192 Japan

HIOKI EUROPE GmbH

Helfmann-Park 2
65760 Eschborn, Germany
hioki@hioki.eu

2111 EN

Edited and published by HIOKI E.E. CORPORATION

Printed in Japan

- CE declarations of conformity can be downloaded from our website.
- Contents subject to change without notice.
- This document contains copyrighted content.
- It is prohibited to copy, reproduce, or modify the content of this document without permission.
- Company names, product names, etc. mentioned in this document are trademarks or registered trademarks of their respective companies.