

PW3360-20

HIOKI

PW3360-21

Instruction Manual

CLAMP ON POWER LOGGER



Video

Scan this code to watch the instructional video(s).
Carrier charges may apply.



! Be sure to read this manual before using the instrument.

▶ p.5

✓ When using the instrument for the first time

Names and Functions of Parts ▶ p.16

Measurement Preparations ▶ p.23

📖 Troubleshooting

Maintenance and Service ▶ p.217

Error Indication ▶ p.221

EN

July 2021 Revised edition 8
PW3360A981-08 21-07H



600397438

Contents

Introduction	1
Confirming Package Contents	2
Safety Information	5
Operating Precautions	8
Measurement Flowchart	10

Chapter 1

Overview	13
-----------------------	-----------

1.1 Product Overview	13
1.2 Features	14
1.3 Names and Functions of Parts	16
1.4 Screen Configuration	19
1.5 On-Screen Indicators	21

Chapter 2

Measurement Preparations	23
---------------------------------------	-----------

2.1 Preparation Flowchart	23
2.2 Preparing to Use the Instrument after Purchase ..	24
■ Bundle the Voltage Cord Leads with the Spiral Tubes	24
■ Attaching Color clips around Clamp Sensors and Grouping Together Cables	25
■ Installing (replacing) the Battery Pack	27
■ Storing the Instrument in the C1005 Carrying Case (Option)	30
■ Setting the Language and Measurement Line Frequency (50 Hz/60 Hz)	31
2.3 Pre-Operation Inspection	32
2.4 Inserting (Removing) an SD Memory Card	33
2.5 Supplying the Power	36
■ Connecting the AC Adapter	36
■ Supplying Power from Measurement Lines (Using the PW9003 Voltage Line Power Adapter)	38
2.6 Turning the Power On/Off	43

Chapter 3

Connecting to Lines to be Measured _____ 45

- 3.1 Connection Procedure 46**
- 3.2 Setting Measurement Conditions on the Wiring Diagram Screen 47**
- 3.3 Connecting the Voltage Cords 52**
- 3.4 Connecting the Clamp Sensors 55**
- 3.5 Connecting the Voltage Cords to Lines to be Measured 57**
- 3.6 Connecting Clamp Sensors to Lines to be Measured 58**
 - Load Current Measurement 58
 - Leakage Current Measurement 59
- 3.7 Attaching Cords on a Wall (if required) 60**
- 3.8 Setting the Current Range 61**
- 3.9 Verifying Correct Wiring (Wiring Check) 63**

Chapter 4

Changing Settings _____ 67

- 4.1 Viewing and Using the Settings Screen 68**
 - 4.2 Changing Measurement Settings 69**
 - Measurement 1 Setting Screen 69
 - Measurement 2 Setting Screen 71
 - 4.3 Changing Recording (Save) Settings 75**
 - Recording 1 Setting Screen 75
 - Recording 2 Setting Screen 80
 - 4.4 Changing System Settings (as Necessary) 83**
 - System 1 Setting Screen 83
 - System 2 Setting Screen 85
 - 4.5 Initializing the Instrument (System Reset) 86**
 - Reverting the Instrument to Its Factory Settings (Factory Reset) 87
 - 4.6 Factory Settings 88**
-

Chapter 5 Viewing Measurement Data _____ 89

5.1	Viewing and Using the Measurement Screen	89
■	1P2W x 2 or 1P2W x 3 Wiring	90
5.2	List of Measurement Screens	91
5.3	Viewing Data (Voltage, Current, Power, and Energy) as a List	92
5.4	Viewing Voltage and Current Value Details	93
5.5	Viewing Power Details (Channel Power Values) ..	94
5.6	Viewing Energy (Active Energy and Reactive Energy)	95
5.7	Viewing a Demand Graph	96
5.8	Viewing a Harmonic Graph (PW3360-21 only)	97
5.9	Viewing a Harmonic List (PW3360-21 only)	99
5.10	Viewing Waveforms	100
■	Changing the Zoom Factor for the Vertical Axis Used to Display Voltage and Current Waveforms	101
5.11	Enlarging Measured Values on the Display	102
5.12	Viewing a Trend Graph	103

Chapter 6 Starting and Stopping Recording and Measurement _____ 105

6.1	Starting Recording	106
■	Starting Recording Manually	106
■	Starting Recording by Specifying a Time	107
■	Starting Recording at a Good Time Division (Interval Time)	108
6.2	Stopping Recording	109
■	Stopping Recording Manually	109
■	Stopping Recording by Specifying a Time	109
6.3	Using Repeat Recording	110
6.4	Operation When a Power Outage Occurs While Recording	112

Chapter 7	
Quick Set	113
7.1	Settings Configured with the Quick Set 113
7.2	Settings That Can Be Added to Quick Set Settings 114
Chapter 8	
Saving Data and Manipulating Files	117
8.1	Viewing and Using the File Screen 118
8.2	Folder and File Structure 120
■	SD Memory Card 120
■	Internal Memory 125
8.3	Saving Copies of the Screen (SD Memory Card Only) 126
8.4	Saving Settings Files 127
8.5	Loading Settings Files 128
■	SD Memory Card 128
■	Internal Memory 129
8.6	Copying Internal Memory Files to the SD Memory Card 130
8.7	Deleting Folders and Files 131
8.8	Formatting the SD Memory Card or Internal Memory 132
Chapter 9	
Analyzing Data on a Computer	135
9.1	Copying Data to a Computer (SD) 136
9.2	Copying Data to a Computer (USB) 138
9.3	SF1001 Power Logger Viewer (Optional) 140
9.4	Checking Recording and Measurement Data with Excel® 142
■	Opening recording and measurement data 142
■	Saving Data as an Excel® File 143
■	Example of Data from a Measurement File 144
■	Measurement File Contents 144
■	Converting Measured Value Exponential Data 152

Chapter 10	
Using Communications (LAN)	153
10.1 LAN Communications	153
■ Configure the Instrument's LAN Settings	154
■ Connecting the Instrument and Computer with a LAN Cable	156
10.2 Remote Control of the Instrument by Internet Browser	159
■ Operating the Instrument Remotely	161
■ Setting a Password	162
■ If You Forget Your Password	162
10.3 Downloading Recorded Data to Computer	163
■ Setup	163
■ Download	165
10.4 Making good use of GENNECT One	168
■ Installation	169
Chapter 11	
Using Pulse Input and Output	171
11.1 Connecting Wires to the Pulse I/O Terminals	172
11.2 Configuring Pulse Settings	173
11.3 Inputting a Pulse Signal	174
■ Signal Input Method	174
11.4 Outputting a Pulse Signal	176
Chapter 12	
Specifications	179
12.1 General Specifications	179
12.2 Basic Specifications	181
12.3 Detailed Measurement Specifications	185
12.4 Functional Specifications	193
12.5 Calculation Formulas	204
12.6 Range Configuration and Accuracy by Clamp Sensor	213
■ When the 9660, 9661, or 9695-03 is Used	214
■ When the 9669 is Used	214

- When the 9694 or 9695-02 is used (CAT III, 300 V) 215
- When the CT9667 is Used 215
- 12.7 Model PW9003 Voltage Line Power Adapter 216**

Chapter 13

Maintenance and Service _____ 217

- 13.1 Trouble Shooting 217**
 - Before Having the Instrument Repaired 219
- 13.2 Cleaning 221**
- 13.3 Error Indication 221**
- 13.4 Disposing of the Instrument 226**

Appendix _____ A1

- Appendix1 How the Instrument Samples Data..... A1**
- Appendix2 Three-phase 3-wire Measurement..... A2**
- Appendix3 Method for Calculating Active Power Accuracy..... A5**
- Appendix4 Terminology A6**

Index _____ Index 1

Introduction

Thank you for purchasing the HIOKI Model PW3360 Clamp on Power Logger. To obtain maximum performance from the instrument, please read this manual first, and keep it handy for future reference.

Trademarks

- Microsoft, Windows, Excel, and Internet Explorer are either registered trademarks or trademarks of Microsoft Corporation in the United States and other countries.
- SD, SDHC Logos are trademarks of SD-3C LLC.

Model Numbers

In this Instruction Manual, "PW3360" is used as the instrument model.

Model No.	Harmonic measurement function	Operation panel
PW3360-10	Not available	Japanese
PW3360-11	Available	
PW3360-20	Not available	English
PW3360-21	Available	
PW3360-30	Not available	Chinese
PW3360-31	Available	

Confirming Package Contents

- When you receive the instrument, inspect it carefully to ensure that no damage occurred during shipping. In particular, check the accessories, panel keys, and connectors. If damage is evident, or if it fails to operate according to the specifications, contact your authorized Hioki distributor or reseller.
- Use the original packing materials when transporting the instrument, if possible.

Check that the package contents are correct.

- Model PW3360 Clamp on Power Logger..... 1



Accessories

- Model L9438-53 Voltage Cord 1 Set
 - Alligator Clip 4
(red, yellow, blue, and black /one each)
 - 3 m, Banana - banana leads 4
(red, yellow, blue, and black /one each)
 - Spiral tubes 5
(for banding the cords)

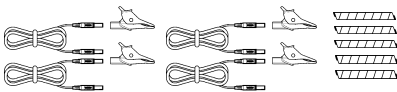

See: "Bundle the Voltage Cord Leads with the Spiral Tubes" (p. 24)
3.3, "Connecting the Voltage Cords" (p. 52)

- Model Z1006 AC Adapter 1
(includes power cord)



- USB Cable 1
(Ver.2.0, with ferrite cores, approx. 0.9 m)



- Application Software CD 1
(SF4000 GENNECT One)

The latest version can be downloaded from our website.



- Instruction Manual (This document) ... 1



- Measurement Guide 1



- Colored clip in red, yellow, blue and white
(color coding for current sensors).....x2 each
- Spiral tubes in black (cord bundling for current sensors) 5

See: "Attaching Color clips around Clamp Sensors and Grouping Together Cables" (p. 25)

Options

The following options are available for the instrument. Contact your authorized Hioki distributor or reseller when ordering.

The options are subject to change. Visit our website for updated information.

For current measurement

- Model 9660 Clamp on Sensor (100 Arms rated)
- Model 9661 Clamp on Sensor (500 Arms rated)
- Model 9669 Clamp on Sensor (1000 Arms rated)
- Model 9694 Clamp on Sensor (5 Arms rated)
- Model 9695-02 Clamp on Sensor (50 Arms rated)
- Model 9695-03 Clamp on Sensor (100 Arms rated)
- Model 9219 Connection Cable (For use with Model 9695-02/9695-03)
- Model CT9667 Flexible Clamp on Sensor (5000 A rms rated)
- Model CT9667-01/CT9667-02/CT9667-03 AC Flexible Current Sensor (5000 A rms rated)
- Model 9657-10 Clamp on Leak Sensor
- Model 9675 Clamp on Leak Sensor
- Model 9290-10 Clamp on Adapter

For voltage measurement

- Model L9438-53 Voltage Cord (CAT III, 1000 V, 10 A / CAT IV, 600 V, 10 A)
- Model 9804-01 Magnet Adapter (Red 1, for changing the voltage cord tips)
(CAT IV, 1000 V, 2 A)
- Model 9804-02 Magnet Adapter (Black 1, for changing the voltage cord tips)
(CAT IV, 1000 V, 2 A)
- Model L1021-01 Patch Cord (Red 1, for branching voltage input)
(CAT III, 1000 V, 10 A / CAT IV, 600 V, 10 A)
- Model L1021-02 Patch Cord (Black 1, for branching voltage input)
(CAT III, 1000 V, 10 A / CAT IV, 600 V, 10 A)

Power supply

- Model PW9003 Voltage Line Power Adapter
(for supplying power from measurement lines)
- Model PW9002 Battery Set (The 9459 Battery Pack and battery case set)
- Model 9459 Battery Pack
(for replacing the 9459 Battery Pack that comes with PW9002)
- Model Z1006 AC Adapter

Media for recording

- Model Z4001 SD Memory Card 2 GB
- Model Z4003 SD Memory Card 8 GB

For communications

- Model 9642 LAN Cable
-

4

Confirming Package Contents

Software

- Model SF1001 Power Logger Viewer

Carrying case

- Model C1005 Carrying Case

Attaching strap

- Model Z5004 Magnetic Strap
-

Safety Information

This instrument is designed to comply with IEC 61010 Safety Standards, and has been thoroughly tested for safety prior to shipment. However, mishandling during use could result in injury or death, as well as damage to the instrument. Using the instrument in a way not described in this manual may negate the provided safety features.

Before using the instrument, be certain to carefully read the following safety notes.



DANGER

Mishandling during use could result in injury or death, as well as damage to the instrument. Be certain that you understand the instructions and precautions in the manual before use.





WARNING

With regard to the electricity supply, there are risks of electric shock, heat generation, fire, and arc discharge due to short circuits. If persons unfamiliar with electricity measuring instruments are to use the product, another person familiar with such instruments must supervise operations.

This manual contains information and warnings essential for safe operation of the instrument and for maintaining it in safe operating condition. Before using the instrument, be certain to carefully read the following safety notes.

Symbols on the instrument



In the manual, the  symbol indicates particularly important information that the user should read before using the instrument. The  symbol printed on the instrument indicates that the user should refer to a corresponding topic in the manual (marked with the  symbol) before using the relevant function.



Indicates a grounding terminal.



Indicates AC (Alternating Current).



Indicates DC (Direct Current).



Indicates the ON side of the power switch.







Indicates the OFF side of the power switch.



Safety Information

Notation

The following symbols in this manual indicate the relative importance of cautions and warnings.

 DANGER	Indicates that incorrect operation presents an extreme hazard that could result in serious injury or death to the user.
 WARNING	Indicates that incorrect operation presents a significant hazard that could result in serious injury or death to the user.
 CAUTION	Indicates that incorrect operation presents a possibility of injury to the user or damage to the instrument.
NOTE	Indicates advisory items related to performance or correct operation of the instrument.
(p.)	Indicates the location of reference information.
	Indicates the prohibited action.
*	Indicates that descriptive information is provided below.
Windows	Unless otherwise specified, "Windows" represents Windows XP, Windows Vista (32-bit), Windows 7 (32-bit/64-bit), Windows 8 (32-bit/64-bit) or Windows 10 (32-bit/64-bit).
[]	Names of settings, buttons, and other screen elements are enclosed in brackets.
Dialog	Dialog box represents a Windows dialog box.

Symbols for various standards

	<p>WEEE marking: This symbol indicates that the electrical and electronic appliance is put on the EU market after August 13, 2005, and producers of the Member States are required to display it on the appliance under Article 11.2 of Directive 2002/96/EC (WEEE).</p>
 Ni-MH	<p>This is a recycle mark established under the Resource Recycling Promotion Law (only for Japan).</p>
	<p>Indicates that the product conforms to regulations set out by the EU Directive.</p>

Accuracy

We define measurement tolerances in terms of f.s. (full scale), rdg. (reading) and dgt. (digit) values, with the following meanings:

f.s.	(maximum display value or scale length) The maximum displayable value or scale length. This is usually the name of the currently selected range.
rdg.	(reading or displayed value) The value currently being measured and indicated on the measuring instrument.
dgt.	(resolution) The smallest displayable unit on a digital measuring instrument, i.e., the input value that causes the digital display to show a "1" as the least-significant digit.

Measurement categories

This device complies with CAT III (600 V)/ IV (300 V) safety requirements.

To ensure safe operation of measurement products, IEC 61010 establishes safety standards for various electrical environments, categorized as CAT II to CAT IV, and called measurement categories.

CAT II	Primary electrical circuits in equipment connected to an AC electrical outlet by a power cord (portable tools, household appliances, etc.) CAT II covers directly measuring electrical outlet receptacles.
CAT III	Primary electrical circuits of heavy equipment (fixed installations) connected directly to the distribution panel, and feeders from the distribution panel to outlets.
CAT IV	The circuit from the service drop to the service entrance, and to the power meter and primary overcurrent protection device (distribution panel).

Using a measurement device in an environment designated with a higher-numbered category than that for which the device is rated could result in a severe accident, and must be carefully avoided.

Use of a measurement instrument that is not CAT-rated in CAT II to CAT IV measurement applications could result in a severe accident, and must be carefully avoided.

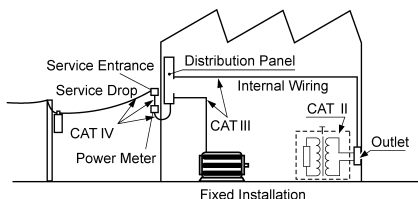

Operating Precautions



Follow these precautions to ensure safe operation and to obtain the full benefits of the various functions.

Preliminary Checks

Before using the instrument for the first time, verify that it operates normally to ensure that no damage occurred during storage or shipping. If you find any damage, contact your authorized Hioki distributor or reseller.



Before using the instrument, verify that damage to any of the voltage cords' insulation has not revealed the white (insulator) part of the cord or its metallic conductor. Cord damage may result in electric shock. Replace with part number L9438-53.

Instrument Installation

Storage temperature and humidity range

-20°C to 60°C (-4°F to 140°F), 80%RH or less (non-condensating)

If the instrument will not be used for an extended period, remove the battery pack and store at a temperature from -20°C to 30°C (-4°F to 86°F).

Operating temperature and humidity range

-10°C to 50°C (14°F to 122°F), 80%RH or less (non-condensating)

When operating on battery power: 0°C to 40°C (32°F to 104°F)

When charging the battery: 10°C to 40°C (50°F to 104°F)

When sending or receiving data over a LAN: 0°C to 50°C (32°F to 122°F)

Avoid the following locations that could cause an accident or damage to the instrument.



Exposed to direct sunlight
Exposed to high temperature



In the presence of corrosive or explosive gases



Exposed to water, oil, other chemicals, or solvents
Exposed to high humidity or condensation



Exposed to strong electromagnetic fields
Near electromagnetic radiators



Exposed to high levels of particulate dust

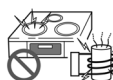

Near induction heating systems (e.g., high-frequency induction heating systems and IH cooking utensils)



Subject to vibration

Handling the Instrument

- ⚠ CAUTION**
- To avoid damage to the instrument, protect it from physical shock when transporting and handling. Be especially careful to avoid physical shock from dropping.
 - This instrument may cause interference if used in residential areas. Such use must be avoided unless the user takes special measures to reduce electromagnetic emissions to prevent interference to the reception of radio and television broadcasts.

Handling the Clamp Sensor

- ⚠ DANGER** **To avoid short circuits and potentially life-threatening hazards, never attach the clamp to a circuit that operates at more than maximum rated voltage to earth, or over bare conductors.**

- ⚠ CAUTION**
- Be careful to avoid dropping the clamps or otherwise subjecting them to mechanical shock, which could damage the mating surfaces of the core and adversely affect measurement.
 - Keep the clamp jaws and core slits free from foreign objects, which could interfere with clamping action.
 - Keep the clamp closed when not in use, to avoid accumulating dust or dirt on the mating core surfaces, which could interfere with clamp performance.

Handling the Cables

- ⚠ CAUTION** To prevent cable damage, do not step on cables or pinch them between other objects. Do not bend or pull on cables at their base.

Using Magnetic Strap

- ⚠ DANGER** **Persons wearing electronic medical devices such as a pacemaker should not use the Magnet Adapter and Magnetic Strap. Such persons should avoid even proximity to the Magnet Adapter and Magnetic Strap, as it may be dangerous. Medical device operation could be compromised, presenting a hazard to human life.**

- ⚠ CAUTION** Do not bring the Magnet Adapter and Magnetic Strap near magnetic media such as floppy disks, magnetic cards, pre-paid cards, or magnetized tickets. Doing so may corrupt and may render them unusable. Furthermore, if the Magnet Adapter and Magnetic Strap is brought near precision electronic equipment such as computers, TV screens, or electronic wrist watches, they may fail.

Measurement Flowchart

This section presents a series of instrument operations without using the Quick Set function. For more information about the Quick Set function, see the Measurement Guide (published separately in color).

Measurement preparations

(At purchase)

- Secure the voltage cords together with a spiral tube. (p. 24)
- Attach the color clips around the clamp sensor cables. (p. 25)
- Grouping together clamp cables (p. 25)
- Install the battery pack. (p. 27)
- Setting the language and measurement line frequency (p. 31)

Pre-Operation Inspection (p. 32)

Inserting an SD memory card (p. 33)

Supplying power (p. 36)

Turning the power on (p. 43)

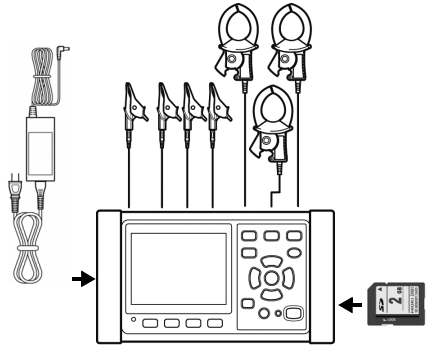

Connecting to lines to be measured and check

Setting measurement conditions on the Wiring Diagram Screen (p. 47)

Attach voltage cords (p. 52)

Connecting clamp sensors (p. 55)

Connecting to measurement lines (p. 57)(p. 58)

Setting the current range (p. 61)

Wiring check (p. 63)

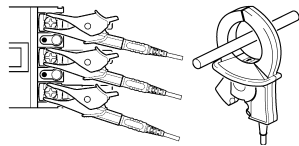

Wiring Check screen

Recording settings (p. 75)

Save destination

Folder/ File name

Clock

Save interval

Recording start

Change the settings of measurement (calculation selection, energy cost), system, and interface when required.

Save items

Recording stop

Viewing measurement data (p. 89)



MEAS POWER		I123 9661 50A		13:01:21 09:24:53
3P4W				
P1	7.320kW	S1	7.321kVA	
P2	8.102kW	S2	8.102kVA	
P3	7.766kW	S3	7.766kVA	
P	23.187kW	S	23.189kVA	
Q1	LEAD 0.089kvar	PF1	LEAD 0.9999	
Q2	LEAD 0.097kvar	PF2	LEAD 0.9999	
Q3	LEAD 0.090kvar	PF3	LEAD 0.9999	
Q	LEAD 0.276kvar	PF	LEAD 0.9999	
SCREEN		HOLD		

[MEAS, LIST] screen

Starting recording (p. 106) / Stopping recording (p. 109)

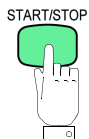

Measurement is complete

Disconnect the cables from the measurement lines.

Turn off the instrument.

Analyzing data on a computer (p. 135)



Overview

Chapter 1

1

Chapter 1 Overview

1.1 Product Overview

The PW3360 Clamp on Power Logger is a clamp-type power meter capable of measuring lines with from single-phase to three-phase four-wire.

In addition to basic measurements including voltage, current, power, power factor, and energy, the instrument can perform demand measurement and harmonic measurement (PW3360-21 harmonic model only), which are important parameters in power management.

The Quick Set makes the instrument simple enough to be used even by beginners by enabling them to configure basic settings, wirings, recording settings, and the start of recording through a series of steps.

The PW3360 Clamp on Power Logger supports extended data acquisition and automated measurement, thanks to the use of the SD memory card and USB/LAN interface. This makes the PW3360 Clamp on Power Logger suitable for power measurement at commercial frequencies involved in the power maintenance and management of a building or factory.

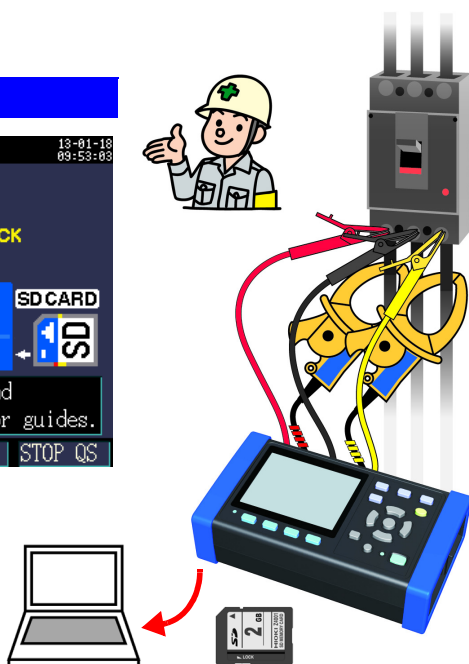
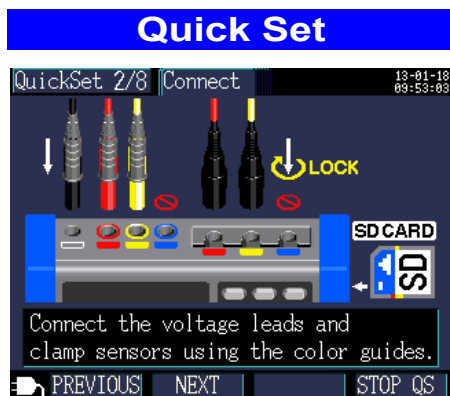

1.2 Features

◆ Quick Set function

The Quick Set function simplifies instrument operation by walking users through a series of steps to configure basic settings, wirings, wiring check (wiring confirmation), recording settings, and the start of recording in order to prevent mistakes.

See: Chapter 7, "Quick Set" (p. 113), Measurement Guide (published separately in color)

◆ Wiring Check (wiring confirmation)

When wirings have been set up improperly, a help function displays hints to help users establish proper wirings.

See: 3.9, "Verifying Correct Wiring (Wiring Check)" (p. 63)

◆ Ability to make measurements even when power is not available from a wall outlet

The PW9003 Voltage Line Power Adapter (option) can be used to supply power from measurement lines.

See: "Supplying Power from Measurement Lines (Using the PW9003 Voltage Line Power Adapter)" (p. 38)

◆ Ability to operate for about 8 hours on battery power

Even when AC power is unavailable, the optional battery pack can be used to enable about eight hours of measurement.

See: "Installing (replacing) the Battery Pack" (p. 27)

◆ Corresponding to the various power lines

The instrument can perform single-phase/2-wire (up to three circuits), single-phase/3-wire, 3-phase/3-wire (2-power measurement/3-power measurement), and 3-phase/4-wire measurement. When performing single-phase/3-wire, or 3-phase/3-wire 2-power measurement, the instrument can perform power and leakage current measurement simultaneously.

See: 4.2, "Changing Measurement Settings" (p. 69)

◆ Broad operating temperature range

The instrument can be used at temperatures ranging from -10°C to 50°C. However, the operating temperature range is limited to 0°C to 40°C when operating on battery power and from 0°C to 50°C when using the LAN.

◆ TFT color LCD

The instrument uses an LCD that is easy to see in both dim and bright conditions.

 **Safe design**

Despite its compact footprint, the instrument features a safe design that is CAT IV (300V) and CAT III (600 V) compliant.

 **Extensive line of clamp sensors**

Choose the clamp sensor that's right for your application, with models designed for targets ranging from leakage currents to a maximum rating of 5,000 A.

 **Ability to store data on SD memory cards**

Used with a high-capacity, 2 GB SD memory card, the instrument can record data continuously for up to one year.

 **Communications functionality**

Instrument settings and data can be downloaded via the instrument's USB and LAN interfaces.

See: Chapter 10, "Using Communications (LAN)" (p. 153)







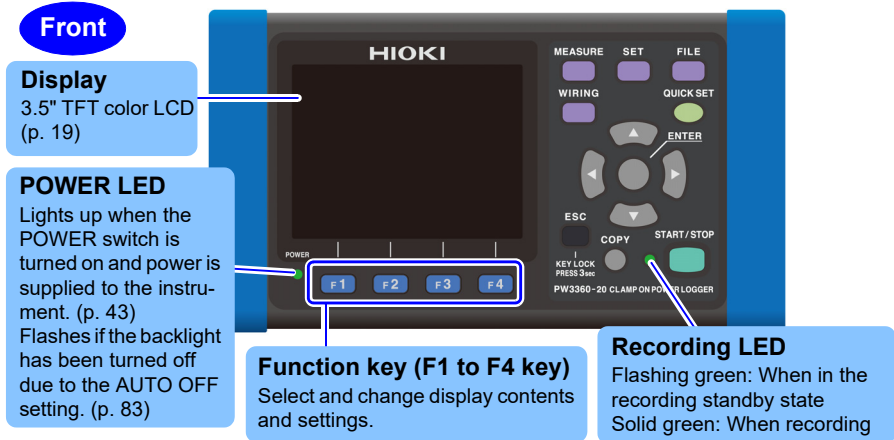

 **Pulse I/O**

Pulse input counts a pulse signal from an external source and saves the result at a constant interval. Unit consumption management can be performed based on power data and pulse counts (production volume). During recording and measurement, pulse output is proportional to active energy.

See: Chapter 11, "Using Pulse Input and Output" (p. 171)

1.3 Names and Functions of Parts



Key	Description	Reference
 MEASURE	Measurement key. Displays the Measurement screen and switches to the next screen.	(p. 89)
 SET	Settings key. Displays the Settings screen and switches to the next screen.	(p. 67)
 FILE	File key. Displays the File (SD memory card/internal memory) screen and switches screens.	(p. 117)
 WIRING	Wiring key. Displays the Wiring Diagram/Wiring Check screen and switches screens.	(p. 45)
 QUICK SET	Quick Set key. Displays the Quick Set screen and switches to the next screen.	(p. 113), Measurement guide
 Enter	Cursor keys. Moves the cursor on the screen. The cursor keys are also used to scroll graphs and waveforms. ●: Enter key. Selects items on the screen and accepts changes.	
 ESC KEY LOCK Press 3 sec	Cancel key. Cancels selections and changes, reverting settings to their previous values. Switches to the previous screen. Pressing and holding the Cancel key for 3 or more seconds activates the key lock (which is canceled by pressing and holding the key again).	
 COPY	Screen Copy key. Outputs an image of the currently displayed screen to the SD memory card.	(p. 126)
 START/STOP	Start/Stop key. Starts and stops recording.	(p. 105)

Right

USB interface

Connect a computer here using the included USB cable.

See: (p. 138)

SD memory card slot

Insert an SD memory card here. Be sure to close the cover when recording.

See: (p. 33)

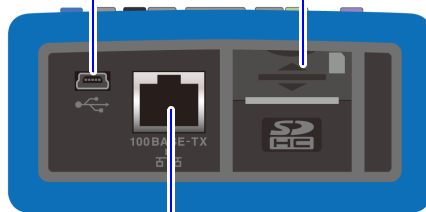
**LAN interface**

Connect a computer here using the optional LAN cable.

See: (p. 153)

Left

Pulse I/O terminal

Pulse input: Counts pulse input from an external source.

Pulse output: Generates pulse output based on integrated energy values.

See: (p. 171)

Charge LED

Lights up while the 9459 Battery Pack is charging.

See: (p. 27)

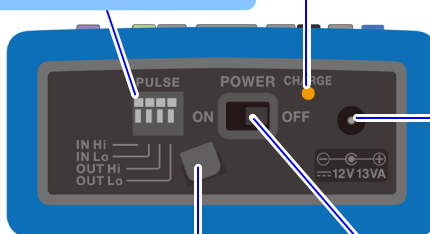
**AC adapter connection jack**

See: (p. 36)

AC adapter hook

Loop the AC adapter cord through this hook.

See: (p. 36)

Power switch

Turns the instrument on and off.

See: (p. 43)

1.3 Names and Functions of Parts

Upper

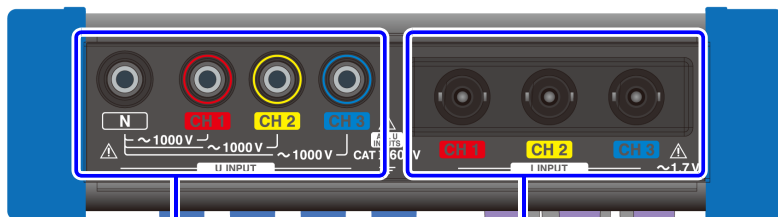

Voltage input terminals

Connect the included L9438-53 Voltage Cord here.

See: (p. 57)

Current input terminals

Connect optional clamp sensors here.

See: (p. 58)

Back

MAC address label

Displays the instrument's unique MAC address, which is used when configuring a LAN connection. Do not remove the label as the information it contains is necessary in order to manage the device.

Serial number

Displays the instrument's serial number. The serial number consists of 9 digits. The first two (from the left) indicate the year of manufacture, and the next two indicate the month of manufacture.

Required for production control. Do not peel off the label.



Indicates the CE mark, KC mark, WEEE Directive mark, and country of manufacture.

Protector

Remove when using the battery. Connect the PW9002 Battery Set (including the 9459 Battery Pack and a battery case).

See: (p. 27)

1.4 Screen Configuration

Measurement screen

Tab: Indicates the name of the currently displayed screen.

Bottom screen: Measurement screen's list screen (shown as **[MEAS, LIST]** in this manual)

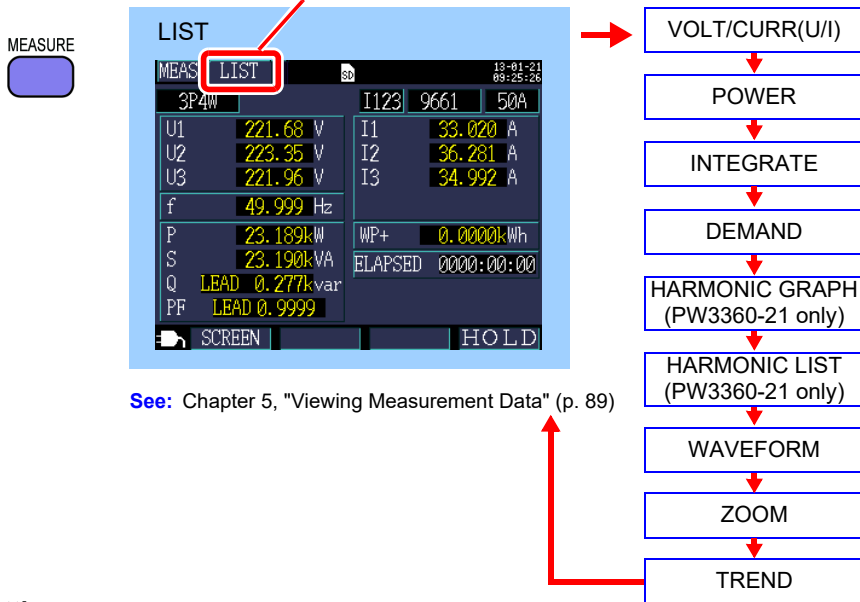

See: Chapter 5, "Viewing Measurement Data" (p. 89)

Setting screen

There are a total of eight Setting screens.

This field indicates which screen is being displayed.

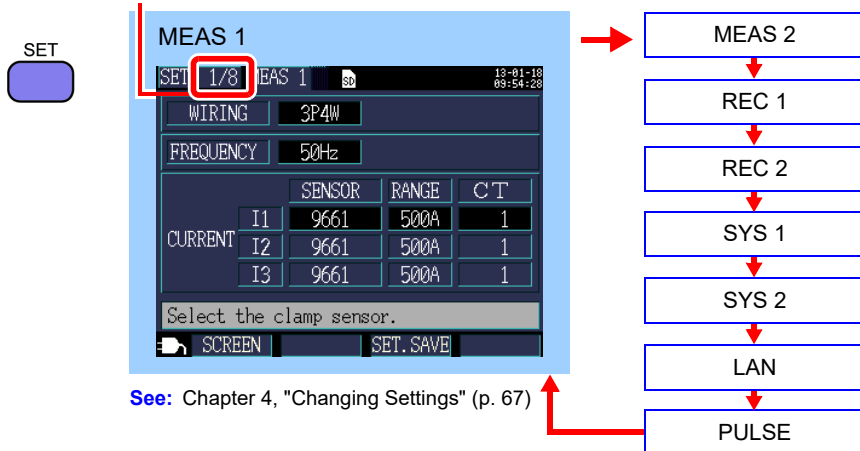

See: Chapter 4, "Changing Settings" (p. 67)

1.4 Screen Configuration

Pressing each of the following keys switches the screens.
 Pressing the **ESC** key returns the screen to the previous screen.

File Screen



SD card

No.	NAME	SIZE	DATE
1	📁 HARDCOPY		13-01-18 09:54
2	📁 SETTING		12-12-19 14:18
3	📁 12122100		12-12-21 12:45

total: 3 files

SD:PW3360
 ⏪ USBDriver SET_LOAD DELETE FORMAT

↔

Memory

No.	NAME	SIZE	DATE
1	📁 60BACK00.CSV	17KB	13-01-18 09:57
2	📁 60BACK01.CSV	9KB	13-01-18 09:57
3	📁 60BACK02.CSV	8KB	13-01-18 09:58

total: 3 files

⏪ COPY SET_LOAD DELETE FORMAT

See: Chapter 8, "Saving Data and Manipulating Files" (p. 117)

Wiring Screen



Wiring Diagram

MEAS VAL LEAK CUR

➔

Wiring Check

3P4W	I123	9661	50A
U1 221 V			
U2 223 V			
U3 222 V			
I1 33.0 A			
I2 36.3 A			
I3 33.0 A			
P 23.0kW			
DPF LEAD 0.97			

PHASE CHK ITEM HOLD

See: Chapter 3, "Connecting to Lines to be Measured" (p. 45)

Quick Set Screen



Quick Set Start

MEAS	LIST
3P4W	I123 9661 500A

U1 0.00 V U2 0.00 V U3 0.00 V

QUICK SET START

Start QUICK SET.

Do you want to initialize the measurement/recording settings?

F Yes: ENTER key STOP QS: ESC key

S Yes: ENTER key STOP QS: ESC key















Q LAG 0.00kvar

PF LAG -----





SCREEN HOLD

See: Chapter 7, "Quick Set" (p. 113)
 Measurement Guide (published separately in color)

1.5 On-Screen Indicators

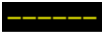
Marks	Description
	Lights up when the save destination is [SD CARD] and an SD memory card is loaded in the instrument.
	Lights red when the SD memory card is being accessed.
	Lights up when the save destination is the instrument's internal memory. Lights up when recording is started with the save destination set to [SD CARD] but no card inserted (in this case, data will be saved to the instrument's internal memory).
	Lights red when the instrument's internal memory is being accessed.
	Indicates that data is being sent or received over the LAN. (p. 153)
	Indicates that data is being sent or received by the HTTP server function. (p. 159)
	Indicates that data is being sent or received both over LAN and by the HTTP server.
	Indicates that data is being sent or received by the USB interface.
	Indicates that recording and measurement are in progress.
	Indicates that the instrument is standing by for recording and measurement to start.
	Indicates how much recording time remains on the SD memory card or in the instrument's internal memory.
	Lights up when the voltage exceeds the peak.
	Lights up when the current exceeds the peak.
	Lights up when both the voltage and current exceed the peak.
	Lights up when the key lock has been activated. (p. 16)

1.5 On-Screen Indicators

Marks	Description
	<p>Indicates that the display range upper limit has been exceeded, causing an over-range event. (p. 183)</p> <p>If the voltage is over-range, the voltage that the instrument is capable of measuring is being exceeded. Immediately disconnect the instrument. If the current is over-range, increase the current range.</p>
	<p>Indicates that measurement is not possible. Power factor cannot be measured when there is no input.</p>
	<p>Lights up when the PW3360 is being operated using the AC adapter. (p. 36)</p>
	<p>Lights up when the PW3360 is being operated on battery power. (p. 27)</p>
	<p>Lights up when the PW3360 is being operated on battery power and there is inadequate battery life remaining. Connect the AC adapter and charge the battery. (p. 27)</p>

Measurement Preparations

Chapter 2

2

Chapter 2 Measurement Preparations

Before starting measurement, connect accessories and options to the instrument. Before performing measurement, be sure to inspect the instrument as well as any accessories and options for possible malfunctions.

2.1 Preparation Flowchart

Follow the procedure described below to prepare for measurement.

(At purchase)

- 1 Secure the voltage cords together with a spiral tube. (p. 24)



(At purchase)

- 2 Attach the color clips around the clamp sensor cables. (p. 25)

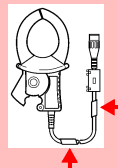

(At purchase)

- 3 Install the battery pack. (p. 27)

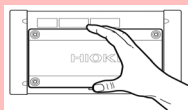

(At purchase)

- 4 Set the language and measurement line frequency. (p. 31)

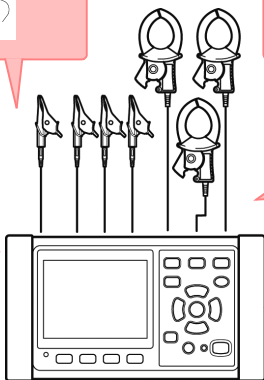

- 5 Perform the pre-measurement inspection. (p. 32)

- 6 Insert an SD memory card. (p. 33)

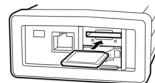

- 7 Connect the AC adapter. (p. 36)

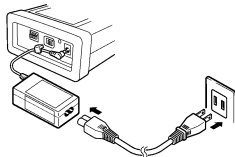

- 8 Turn on the instrument. (p. 43)





2.2 Preparing to Use the Instrument after Purchase

Bundle the Voltage Cord Leads with the Spiral Tubes

5 Spiral Tubes provided with Model L9438-53 Voltage Cord. Use the Spiral Tubes as and when required. The number of voltage cords that will be bound together depends on the measurement target.

Measurement target	Voltage cord to use (color)
Single-phase/2-wire (1P2W), Single-phase/3-wire (1P3W1U)	Two cords (black and red)
Single-phase/3-wire (1P3W), 3-phase/3-wire (3P3W2M)	Three cords (black, red, and yellow)
3-phase/3-wire (3P3W3M)	Three cords (red, yellow, and blue)
3-phase/4-wire (3P4W)	Four cords (black, red, yellow, and blue)

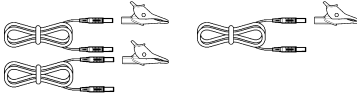
Preparation items: single-phase/3-wire (1P3W) and 3-phase/3-wire (3P3W2M)

Model L9438-53 Voltage Cord			Five Spiral Tubes (for cable bundling)
Banana Plug Leads	three, one each black, red, and yellow	Alligator Clips	three, one each black, red, and yellow

1 Line up the ends of the voltage cords and wrap the spiral tube around them.

Wind a Spiral Tube round the multiple cords. Five Spiral Tubes are provided. Please wind the tubes at appropriate intervals.

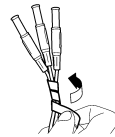

2 Insert the same color alligator clip into each lead.

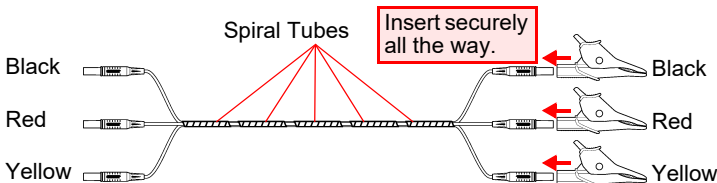

You can also use magnet adapters instead of alligator clips.

- Model 9804-01 Magnet Adapter (optional, red, standard screws: M6 pan-head screw)
- Model 9804-02 Magnet Adapter (optional, black, standard screws: M6 pan-head screw)

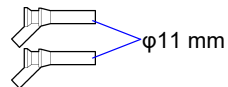

Attaching Color clips around Clamp Sensors and Grouping Together Cables

The instrument includes color clips for use with clamp sensors. In order to prevent erroneous connections, these color clips are attached clamp sensor cables and color-coded to help recognize channels. Once you have attached the color clips around the cables, group multiple clamp sensor cables together with the black spiral tubes as necessary.

Measurement target	Number of clamp sensors in use (Colors of the CH and colored clips)
Single-phase 2-wire (1P2W)	1 (CH1 red)
Single-phase 2-wire (1P2W) 2 circuits	2 (CH1 red, CH2 yellow)
Single-phase 2-wire (1P2W) 3 circuits	3 (CH1 red, CH2 yellow, CH3 blue)
Single-phase 3-wire (1P3W)	2 (CH1 red, CH2 yellow)
Single-phase 3-wire (1P3W) + I	3 (CH1 red, CH2 yellow, CH3 blue)
3-phase 3-wire (3P3W2M)	2 (CH1 red, CH2 yellow)
3-phase 3-wire (3P3W2M) + I	3 (CH1 red, CH2 yellow, CH3 blue)
3-phase 3-wire (3P3W3M)	
3-phase 4-wire (3P4W)	

2.2 Preparing to Use the Instrument after Purchase

Preparation items:

single-phase/3-wire (1P3W) and 3-phase/3-wire (3P3W2M)

	<p>Red x 2 Yellow x 2</p>		<p>Black Five spiral tubes (For grouping together cords)</p>	<p>Model 9661 </p>	<p>Two clamp sensors in use</p>
<p>Colored clips (for color-coding the current sensor)</p>					

1 Attached color clips of the same color around the connector and sensor sides of the clamp sensor cable.

CH1: Red clips
CH2: Yellow clips

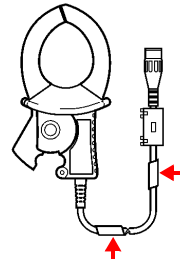

2 Group together multiple clamp sensor cables with spiral tubes.

Line up the ends of multiple clamp sensor cables so that they can be more easily grouped together. Wrap spiral tubes around multiple cables so as to group them together. The instrument includes five spiral tubes, which should be placed at appropriate intervals.

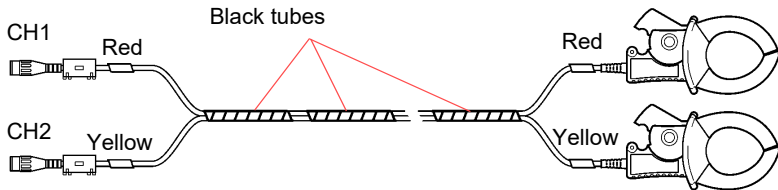

Installing (replacing) the Battery Pack

The battery pack is used to power the instrument during power outages and as a backup power supply. When fully charged, it can provide backup power for approximately 8 hours in the event of a power outage. Note that if a power outage occurs while the battery pack is not being used, displayed measurement data will be erased. (Data that has been recorded on the SD memory card and instrument's internal memory is retained.)

The battery pack is subject to self-discharge. Be sure to charge the battery pack before initial use. If the battery capacity remains very low after recharging, the useful battery life is at an end.

See: "Instrument Installation" (p. 8)

WARNING

- **For battery operation, use only the Hioki Model PW9002 Battery Set. We do not take any responsibility for accidents or damage related to the use of any other batteries and/or screws.**
- **To avoid the possibility of explosion, do not short circuit, disassemble or incinerate battery pack. Handle and dispose of batteries in accordance with local regulations.**
- **To avoid electric shock, turn off the power switch and disconnect the cords and cables before replacing (removing) the battery pack.**
- **After replacing the battery pack, replace the case and screws before using the instrument.**

CAUTION

- Install the battery case onto the PW3360 using the screws supplied with the PW9002 (M3 x 25 mm), keeping the protector attached to the case. Installing the battery case with the protector removed or using screws longer than the accompanying screws may damage the PW3360.
- Do not use the screw holes used for installing the protector or the battery case for other purposes. Doing so may damage the product.

NOTE

- To remove the 9459 Battery Pack, follow Step 4 to 7 in reverse order.
- When removing the PW9002 Battery Set from the back of the instrument and operating the instrument without the battery pack installed, attach the protector, following Step 4 to 7 in reverse order. Attach the protector using the four accompanying screws (M3×6 mm), which secured the protector onto the instrument when you received the instrument. Securing the protector using screws longer than the accompanying screws may damage the instrument.

2.2 Preparing to Use the Instrument after Purchase

Preparation items

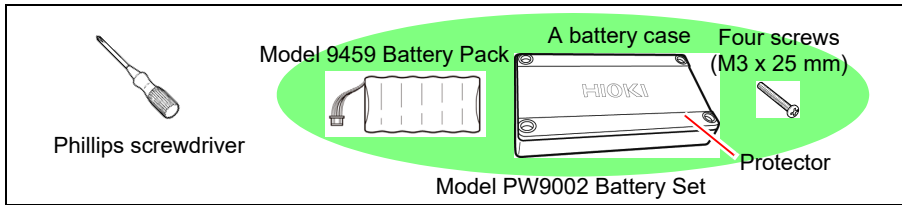

Procedure

1 Turn off the power switch and remove all cords and cables.

2 Turn the instrument over and use a Phillips screwdriver to remove the screws holding the protector in place.

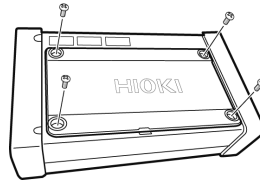

3 Remove the protector from the recessed area in the case.

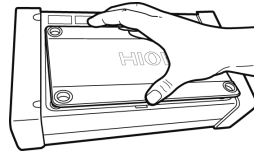

Store the protector and the four screws (M3×6 mm) you removed with care because you will need them when not using the PW9002 Battery Set.

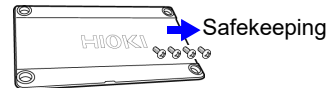

4 Fit the 9459 Battery Pack into the battery case.

Position the battery pack so that the cables are routed through the cutout in the case.

NOTE

When the PW9002 Battery Set is shipped from Hioki factory, the 9459 Battery Pack has already fit into the battery case.

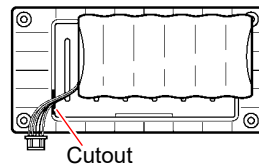

5 Insert the connector from the battery pack into the port on the instrument.

Take care to orient the connector properly and insert it as far as it will go.

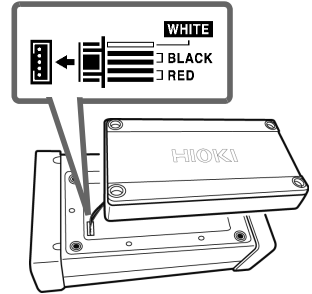
**6** With the battery case facing down, fit it into the recessed area on the instrument.

Exercise care not to pinch the battery pack's wires between the battery case and the instrument.

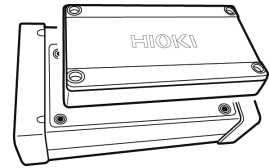
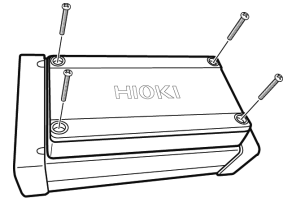
**7** Install the battery case onto the instrument using the four dedicated screws (M3×25 mm) that come with Model PW9002 Battery Set.**8** Connect the AC adapter to the instrument to charge the battery pack.

The battery pack will be charged regardless of whether the power is on.



Left side of the PW3360

Charge LED

On (red): Charging

Off: Fully charged/when the battery pack is not attached

2.2 Preparing to Use the Instrument after Purchase

Storing the Instrument in the C1005 Carrying Case (Option)

The instrument can be stored in the C1005 Carrying Case as follows:

This divider is attached by means of Velcro-style fasteners and can be removed. It can be arranged as desired to accommodate the case's contents.

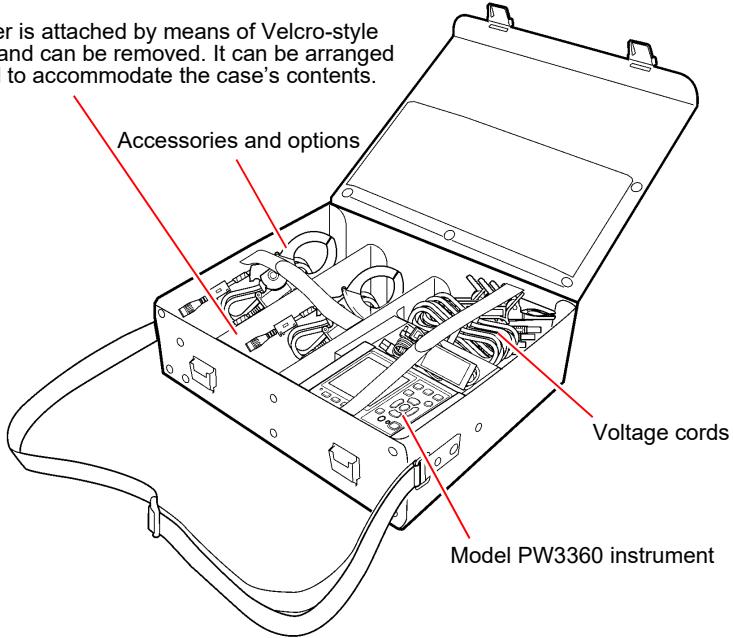

Setting the Language and Measurement Line Frequency (50 Hz/60 Hz)

When you turn on the instrument for the first time after purchase, the Language Setting screen and Frequency Setting screen will be displayed. Configure the settings as desired. Similarly, these settings must be configured if a factory reset is performed to reset the instrument to its default settings.

See: "Reverting the Instrument to Its Factory Settings (Factory Reset)" (p. 87)

NOTE Once the display language and frequency have been set, these setting screens will no longer be displayed when the instrument is powered on. The settings can be changed at any time on the Settings screen.

See: Language setting "System 1 Setting Screen" (p. 83)

See: Frequency setting "Measurement 1 Setting Screen" (p. 69)

1 Turn on the power switch.
The Language Setting screen will be displayed.

2 Select the desired language with the function keys.

The language will be set, and the Frequency Setting screen will be displayed.

NOTE

Pressing the **F4** key **[OTHERS]** enables you to select a language between JAPANESE, ENGLISH, CHINESE, GERMAN, ITALIAN, FRENCH, SPANISH, TURKISH, and KOREAN.



3 Select the desired measurement line frequency with the function keys.

The frequency will be set, and the **[MEAS, LIST]** screen will be displayed.

NOTE

It will not be possible to perform accurate measurement if the actual measurement line frequency differs from the frequency setting.

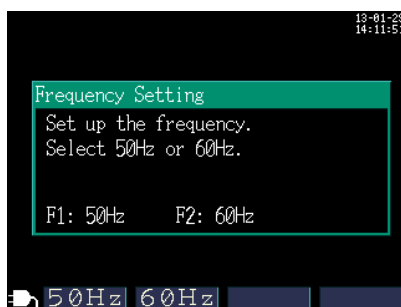

4 If you do not wish to perform measurement, turn off the power switch.

2.3 Pre-Operation Inspection

Before using the instrument the first time, verify that it operates normally to ensure that no damage occurred during storage or shipping. If you find any damage, contact your authorized Hioki distributor or reseller.

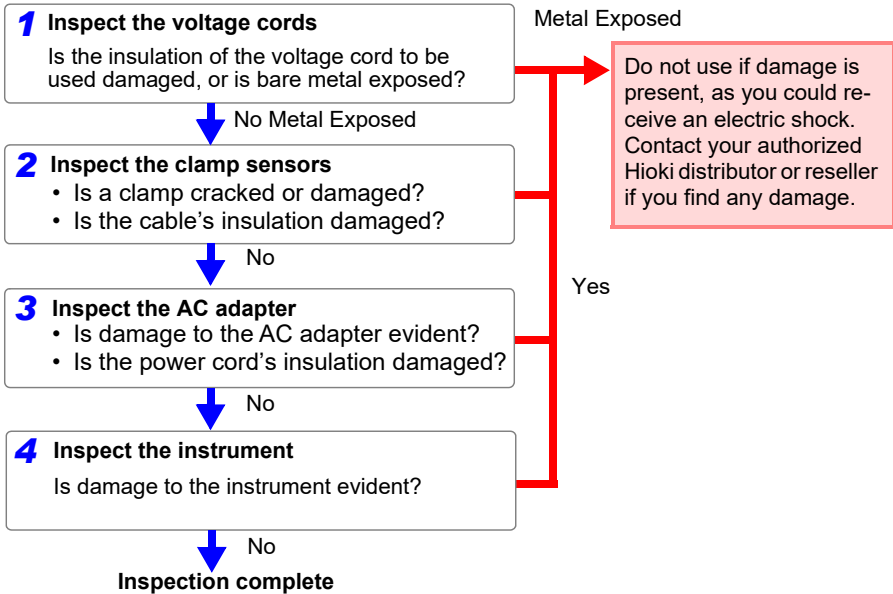

2.4 Inserting (Removing) an SD Memory Card

Measurement data can be stored either on SD memory cards or in the instrument's internal memory. When saving data on an SD memory card, insert an SD memory card and select **[SD CARD]** as the storage destination on the **[SET 3/8, REC 1]** screen.

CAUTION

- Inserting a SD memory card upside down, backwards or in the wrong direction may damage the instrument.
- Some SD memory cards are susceptible to static electricity. Exercise care when using such products because static electricity could damage the SD memory card or cause malfunction of the instrument.

Important

- Use only HIOKI-approved SD memory cards. Other SD memory cards may not work with the instrument, and Hioki is unable to guarantee proper operation.
 - Format SD memory cards with the instrument. Using a computer to format the card may reduce the card's performance.
- See:** "Formatting the SD Memory Card or Internal Memory" (p. 132)

2.4 Inserting (Removing) an SD Memory Card

- NOTE**
- The operating lifetime of the SD memory card is limited by its flash memory. After long-term or frequent usage, data reading and writing capabilities will be degraded. In that case, replace the card with a new one.
 - No compensation is available for loss of data stored on the SD card, regardless of the content or cause of damage or loss. Be sure to back up any important data stored on an SD card.
 - Observe the following to avoid corruption or loss of stored data:
 - (1) Do not touch the electrical contacts on the card or inside the insertion slot with your skin or metallic objects.
 - (2) While writing or reading data, avoid vibration or shock, and do not turn the power off or remove the card from the instrument.
 - (3) Before formatting (initializing) a card, confirm that it contains no important information (files).
 - (4) Do not bend or drop the card, or otherwise subject it to intense shock.
 - The SD memory card's connector is used to judge whether the card is write-protected. If the write-protected lock is in an intermediate position, the determination of whether the card is write-protected will depend on the connector. For example, even if the instrument determines that the card is not write-protected and allows data to be written to it, a computer may determine that it is write-protected, preventing data from being written to it. If you are unable to write data to an SD memory card, manipulate folders and files, or format the card, check the position of the write-protect lock and disengage it if necessary.
-

Inserting the SD memory card

1 Turn off the power switch.

2 Open the SD memory card slot cover.

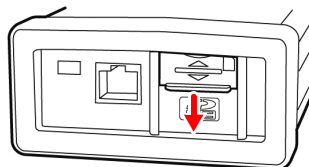

3 Disengage the SD memory card's write-protect lock.



4 Positioning the SD memory card with the top surface facing up, insert it into the slot in the direction shown by the arrow and push it all the way in.

Keep the card level as you insert it. Inserting it at an angle may cause the write-protect lock to engage, preventing data from being written to the card.

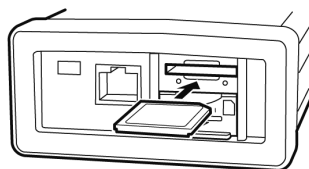

5 Close the SD memory card slot cover.

Be sure to close the cover.

Format new SD memory cards before use.

See: "Formatting the SD Memory Card or Internal Memory" (p. 132)

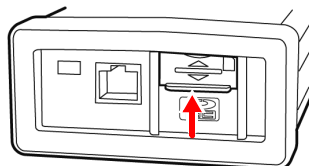

To remove the card, open the cover and push in the SD memory card.

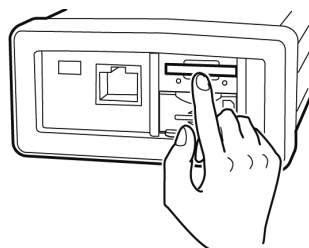

2.5 Supplying the Power

Connecting the AC Adapter



⚠️ WARNING

Use only the specified Model Z1006 AC Adapter. AC adapter input voltage range is 100 to 240 VAC (with $\pm 10\%$ stability) at 50/60 Hz. To avoid electrical hazards and damage to the instrument, do not apply voltage outside of this range.

⚠️ CAUTION

To avoid damaging the power cord, grasp the plug, not the cord, when unplugging it from the power outlet.

NOTE

- Make sure the power is turned off before connecting or disconnecting the AC adapter.
- When using a 250 V power cord, for example with a version of the instrument sold in China, Australia, or the EU, it may appear that the power cord cannot be inserted all the way into the AC adapter. This is normal. As long as the power cord has been inserted into the AC adapter until it stops, there is no problem with the connection.

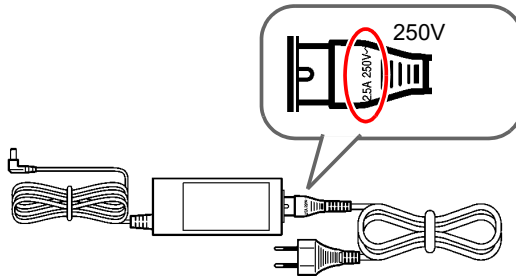

Connect the Z1006 AC Adapter to the instrument and plug it into an outlet as follows:

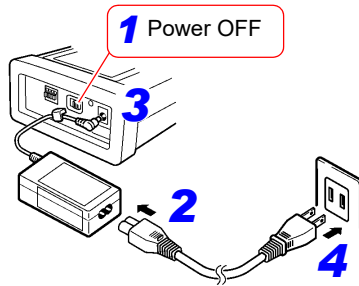

1 Turn off the power switch.

2 Connect the power cord to the inlet on the AC adapter.

3 Connect the AC adapter's output plug to the instrument.

Once the output plug is connected, route the cord underneath the hook (to keep it from being pulled out).

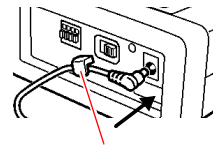

AC adapter hook

4 Connect the power cord's input plug to an outlet.

Supplying Power from Measurement Lines (Using the PW9003 Voltage Line Power Adapter)



Power can be supplied from measurement lines using the PW9003 Voltage Line Power Adapter (option).



WARNING

To avoid electric shock or a short-circuit, observe the following precautions:

- When using the PW9003 Voltage Line Power Adapter, never wire the instrument to measurement lines with a voltage exceeding 240 V.
- Make all connections after turning the PW9003 Voltage Line Power Adapter's power switch off. Making connections with the power switch in the on position is extremely dangerous and may cause sparks between measurement lines and the metal tips on the voltage cords.
- Never wire the instrument to lines that include a high-frequency component other than a commercial frequency, for example the secondary side of an inverter.
- Before connecting the instrument to measurement lines, verify that the voltage and frequency of the measurement lines being used are 100 to 240 VAC and 50 Hz/60 Hz, respectively. Use of the instrument outside the specified supply voltage range may result in equipment damage or an electrical accident.
- The instrument's maximum rated power is 13 VA. When using the PW9003 Voltage Line Power Adapter, do not do so on the secondary side of a voltage transformer (VT or PT).



CAUTION

Avoid using an uninterruptible power supply (UPS) or DC/AC inverter with rectangular wave or pseudo-sine-wave output to power the instrument. Doing so may damage the instrument.

NOTE

- Use of the PW9003 Voltage Line Power Adapter allows the Z1006 AC Adapter to be connected to a CAT III (300 V) circuit without sacrificing safety.
- The fuse is housed in the PW9003 Voltage Line Power Adapter. If the power does not turn on, the fuse may be blown. If this occurs, a replacement or repair cannot be performed by customers. Please contact your authorized Hioki distributor or reseller.

Preparation items

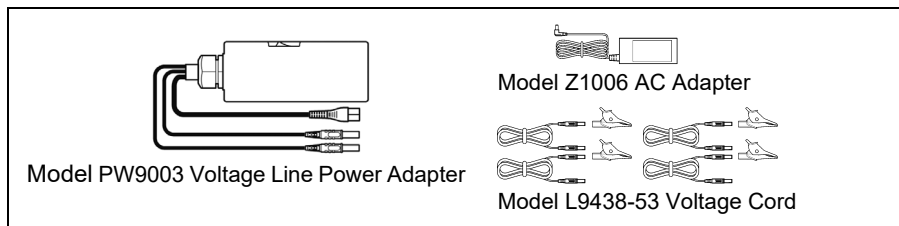

Connecting the PW9003

Be sure to connect the instrument to the measurement target as described in the following procedure. Failing to follow this procedure properly is extremely dangerous. To disconnect the instrument, simply reverse the procedure.

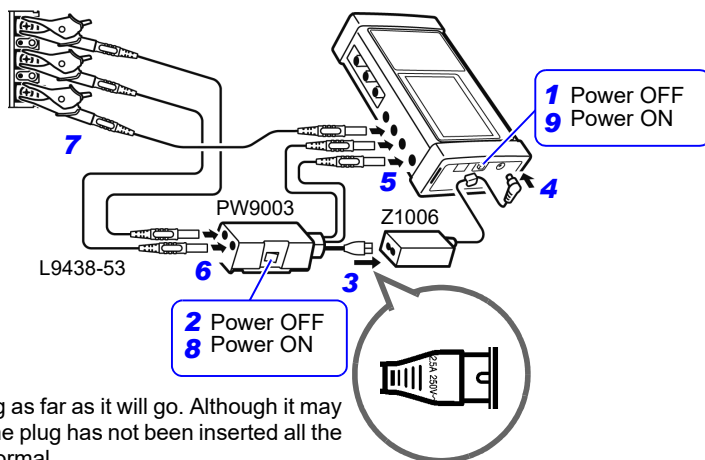

Insert the plug as far as it will go. Although it may appear that the plug has not been inserted all the way, this is normal.

- 1** Turn off the instrument's power switch.
- 2** Turn off the PW9003 Voltage Line Power Adapter's power switch (○).
- 3** Connect the voltage line power adapter's power cord to the AC adapter. Dock the voltage line power adapter and AC adapter as necessary.

Procedure

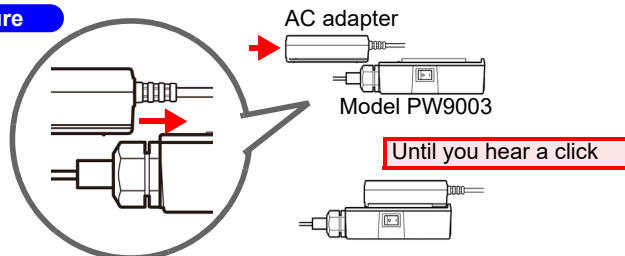

2.5 Supplying the Power

4 Connect the AC adapter's output plug to the instrument.

Once the output plug is connected, route the cord underneath the hook (to keep it from being pulled out).

5 Connect the voltage line power adapter's banana plugs to the instrument's voltage input terminals.

Connecting the voltage line power adapter's banana plugs to the instrument's voltage input terminals

Wirings Model PW9003	1P2W/1P3W/1P3W1U/ 3P3W2M/3P4W	3P3W3M
Black cord	The voltage input N terminal of the PW3360	The voltage input CH2 terminal of the PW3360
Red cord	The voltage input CH1 terminal of the PW3360	The voltage input CH1 terminal of the PW3360

6 Connect the voltage cords to the voltage line power adapter and to the instrument's voltage input terminals.

Connecting the voltage cords to the voltage line power adapter and the instrument's voltage input terminals

Wirings Voltage cord	1P2W 1P3W1U	1P3W 3P3W2M	3P4W	3P3W3M
Black	N terminal of the PW9003			-
Red	CH1 terminal of the PW9003			CH1 terminal of the PW9003
Yellow	-	The voltage input CH2 terminal of the PW3360		N terminal of the PW9003
Blue	-	-	The voltage input CH3 terminal of the PW3360	The voltage input CH3 terminal of the PW3360

7 Connect the voltage cords to the metal part of the measurement lines.

See: 3.2, "Setting Measurement Conditions on the Wiring Diagram Screen" (p. 47)

See: 3.5, "Connecting the Voltage Cords to Lines to be Measured" (p. 57)

8 Turn on the voltage line power adapter's power switch (I).

9 Turn on the instrument's power switch.

[Wiring Check]

1P2W/ 1P3W1U

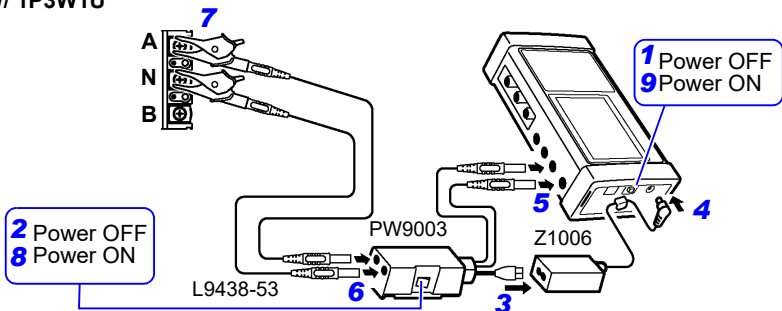

1P3W/ 3P3W2M

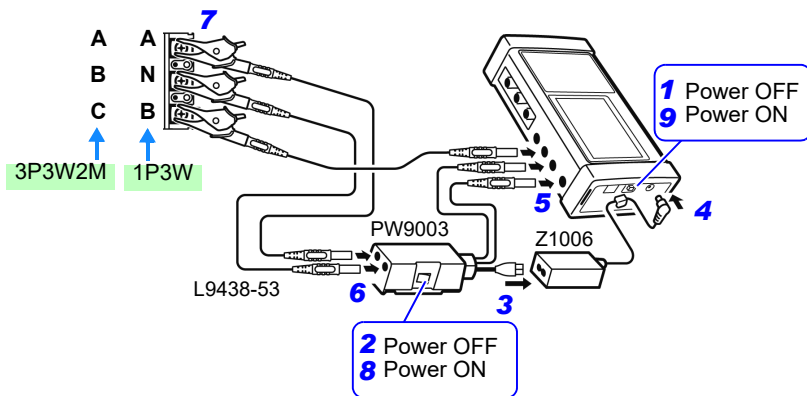

2.5 Supplying the Power

3P4W

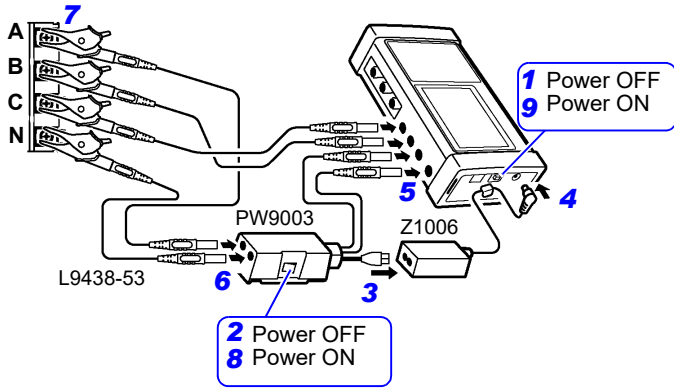

3P3W3M

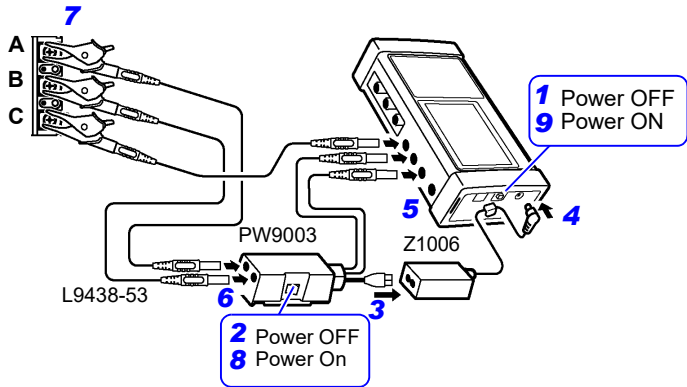

2.6 Turning the Power On/Off

Turn on the instrument. When you're finished making measurements, turn off the instrument.



WARNING

Before turning the instrument on, make sure the supply voltage matches that indicated on the AC adapter. Connection to an improper supply voltage may damage the instrument or AC adapter and present an electrical hazard.



CAUTION

If the instrument encounters an error during the self-test, the instrument is damaged. Contact your authorized Hioki distributor or reseller.

Powering On

Turn on the power switch. When the instrument is turned on, the Self-test screen will be displayed. Once the self-test is complete, the Measurement screen will be displayed.

See: Chapter 7, "Quick Set" (p. 113), Measurement Guide (published separately in color)

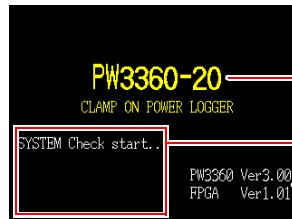
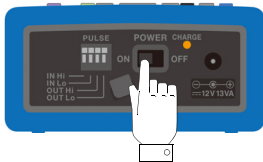

Model No. of the instrument

Internal memory test result

Version

Screen after the power is turned on
(Self-test screen)



Measurement screen

2.6 Turning the Power On/Off

NOTE • If **[QUICK SET at PWR ON]** on the **[SET 6/8, SYS 2]** screen is on, the Quick Set start dialog will be displayed after the self-test is complete.



```
QUICK SET START
Start QUICK SET.
Do you want to initialize the
measurement/recording settings?
Yes: ENTER key  STOP QS: ESC key
```

- If the instrument fails to turn on when using the AC adapter, there may be a break in the power cord or an AC adapter or internal instrument malfunction. Contact your authorized Hioki distributor or reseller.
- If an error message is displayed before the self-test completes, there may be an internal instrument malfunction. Contact your authorized Hioki distributor or reseller.

Powering Off

Turn the POWER switch OFF.

Connecting to Lines to be Measured

Chapter 3

Please read the "Operating Precautions" (p. 8) before making connections.



- Voltage cords or Clamp sensors should only be connected to the secondary side of a breaker, so the breaker can prevent an accident if a short circuit occurs. Connections should never be made to the primary side of a breaker, because unrestricted current flow could cause a serious accident if a short circuit occurs.
- Connect the clamp-on sensors or voltage cords to the instrument first, and then to the active lines to be measured. Observe the following to avoid electric shock and short circuits.
 - (1) Do not allow the voltage cord clips to touch two wires at the same time. Never touch the edge of the metal clips.
 - (2) When the clamp sensor is opened, do not allow the metal part of the clamp to touch any exposed metal, or to short between two lines, and do not use over bare conductors.
- To prevent electrical shock and personnel injury, do not touch any input terminals on the VT (PT), CT or the instrument when they are in operation.
- The maximum rated voltage between terminals is 1000V AC. Attempting to measure voltage in excess of the maximum input could destroy the instrument and result in personal injury or death.
- The maximum rated voltage between input terminals and the ground is as follows;
(CAT III) 600 V AC, (CAT IV) 300 V AC
Attempting to measure voltages exceeding this level with respect to ground could damage the instrument and result in personal injury.

3.1 Connection Procedure

Connect the instrument as follows:

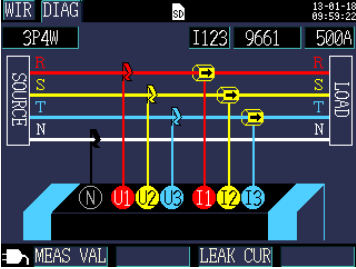
1   Set the measurement conditions. (p. 47)

Wiring diagram screen

2 Attach the voltage cords.(p. 52)

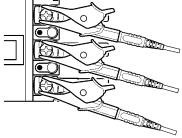
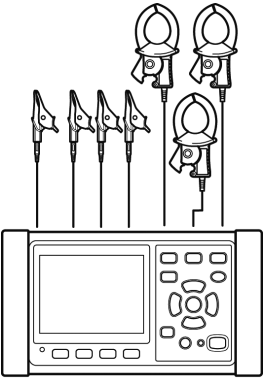

3 Attach the clamp sensors.(p. 55)

4 Make connections. (p. 57)

5 Make connections. (p. 58)

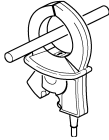

6   Set the current range. (p. 61)
Check the wirings. (p. 63)

[WIR, CHK] screen

3.2 Setting Measurement Conditions on the Wiring Diagram Screen

Use the following procedure to display the **[WIR, DIAG]** screen and set the wiring method and clamp sensor being used.

NOTE The wiring method, clamp sensor, and current range settings can be configured on the Measurement screen, Settings screen, or Wirings screen. The CT ratio and VT (PT) ratio settings, if needed, can be configured on the Settings screen.

See: 4.2, "Changing Measurement Settings" (p. 69)

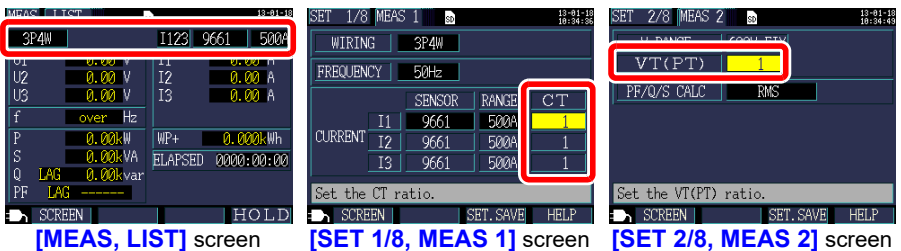

1 Press the **WIRING** key to display the **[WIR, DIAG]** screen.

2 Select the wiring method.

1P2W	For more detailed settings, see the table on the following page.
1P3W	
1P3W1U	
3P3W2M	
3P3W3M	
3P4W	
I only	

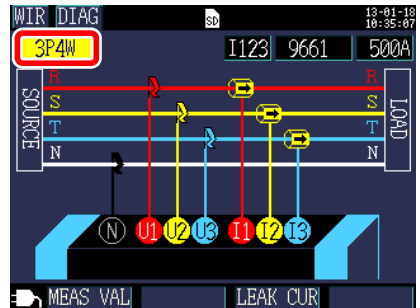

3.2 Setting Measurement Conditions on the Wiring Diagram Screen

Selecting the wiring method

wiring selection	Sub-selection	Name	Detailed description
1P2W	x1 x2 x3	Single-phase/ 2-wire lines	If the single-phase/2-wire lines share the same voltage, you can select from 1 to 3 circuits with the sub-selection. To use only 1P2W measurement and current, use either [1P2Wx2] or [1P2Wx3] . You cannot select the 9657-10 or 9675 Clamp on Leak Sensor.
1P3W	OFF +I	Single-phase/ 3-wire lines	The sub-selection allows you to measure current only (+I) for current CH3 in addition to performing normal 1P3W measurement (OFF).
1P3W1U	OFF +I	Single-phase/ 3-wire lines (1-voltage measurement)	In 1P3W1U measurement, you can easily measure voltage for single-phase/3-wire lines using only CH1. The CH2 voltage RMS value (U2) is temporarily set to the CH1 voltage RMS value (U1) to calculate the 1P3W power. The sub-selection allows you to measure current only (+I) for current CH3 in addition to performing normal 1P3W1U measurement (OFF).
3P3W2M	OFF +I	3-phase/3-wire lines (2-power- meter method)	Three-phase/3-wire measurement is performed from two line-to-line voltages and two line currents. U3 is calculated from U1 and U2, and I3 is calculated from I1 and I2. Although the total active power is the same as 3P3W3M, 3P3W3M is used when measuring the power of individual phases, since that measurement cannot be performed using 3P3W2M. "Appendix2 Three-phase 3-wire Measurement" (p. A2) The sub-selection allows you to measure current only (+I) for current CH3 in addition to performing normal 3P3W2M measurement (OFF).
3P3W3M	-	3-phase/3-wire lines (3-power- meter method)	The three phase voltage is measured based on virtual neutral points, and 3-phase/3-wire measurement is performed from the three line currents. This wiring setup can also be used to confirm the line-to-line voltage of 3-phase/4-wire lines.
3P4W	-	3-phase/4-wire lines	Three-phase/4-wire measurement is performed from three phase voltages and three phase currents. When you wish to confirm the line-to-line voltage to line, use 3P4W connections with the 3P3W3M connection setting.
I only	x1 x2 x3	Current only	This wiring setup is used when you wish to measure only current (not voltage). The sub-selection allows you to select from one to three circuits.

3.2 Setting Measurement Conditions on the Wiring Diagram Screen

Single-phase 2-wire (1P2W)

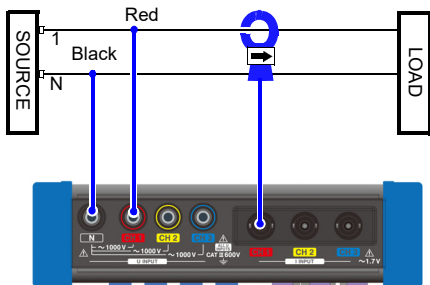

➡ Face the arrow toward the Load

Single-phase 3-wire (1P3W)

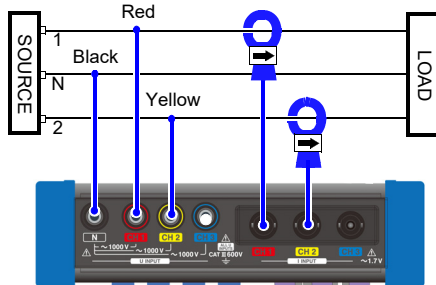

➡ Face the arrow toward the Load

Single-phase 3-wire (1P3W1U) 1-voltage measurement

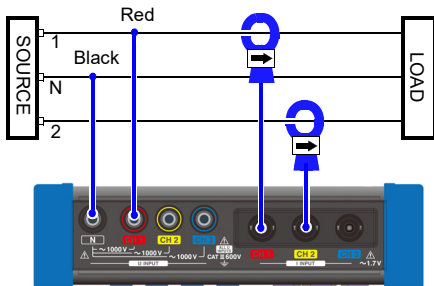

➡ Face the arrow toward the Load

Three-phase 3-wire (3P3W2M) 2-power-meter method

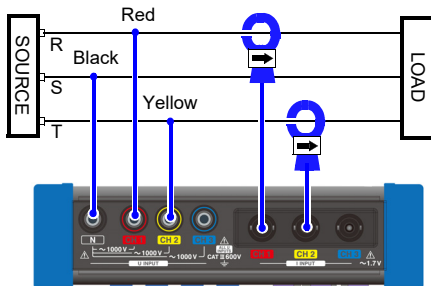

➡ Face the arrow toward the Load

Three-phase 3-wire (3P3W3M) 3-Power-meter method

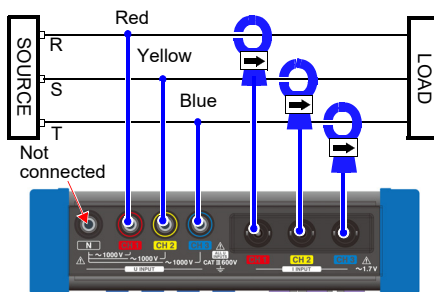

➡ Face the arrow toward the Load

Three-phase 4-wire (3P4W)

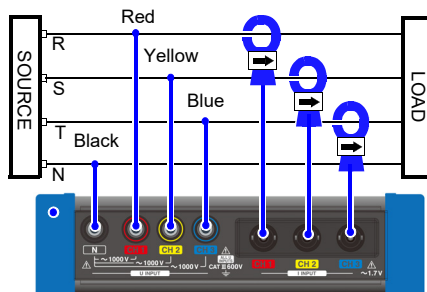

➡ Face the arrow toward the Load

3.2 Setting Measurement Conditions on the Wiring Diagram Screen

3 Select the current channel.

To measure multiple circuits with the wiring, select the corresponding channel and then set the clamp sensor and current range.

1P2Wx2	I1, I2
1P2Wx3	I1, I2, I3
1P3W+I	I12, I3
1P3W1U+I	I12, I3
3P3W2M+I	I12, I3
I only x 2 (Ix2)	I1, I2
I only x 3 (Ix3)	I1, I2, I3

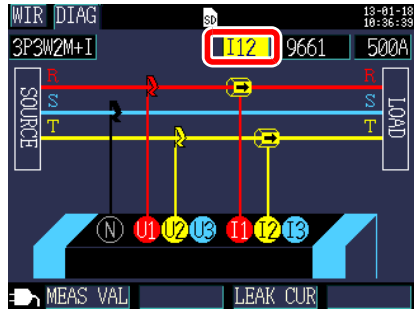

4 Select the clamp sensor.

9660	Load current (power) measurement sensors
9661	
CT9667-500A	
CT9667-5kA	
9669	
9694	
9695-02	
9695-03	Leakage current measurement sensors
9657-10	
9675	

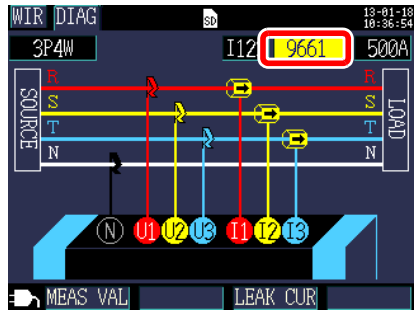

NOTE

- When measuring power lines using multiple channels, combine multiple clamp sensor types.
For example, when measuring 3-phase/4-wire lines, use the same clamp sensor for channels 1 to 3.
- When using the CT9667 Flexible Clamp on Sensor, use the same value for the sensor range setting and the instrument's clamp sensor range setting.
- When using the 9667 Flexible Clamp on Sensor, select the CT9667.
- The 9657-10 and 9675 leakage current measurement sensors can only be selected when the wiring is set to **[I only]**.

3.2 Setting Measurement Conditions on the Wiring Diagram Screen

5

Select the current range.

If you do not know the appropriate range, configure the current range setting while checking the current value on the [WIR, CHK] screen after connecting the instrument.

See: 3.8, "Setting the Current Range" (p. 61)

9660	5A, 10A, 50A, 100A
9661	5A, 10A, 50A, 100A, 500A
CT9667-500A	50A, 100A, 500A
CT9667-5kA	500A, 1kA, 5kA
9669	100A, 200A, 1kA
9694	
9695-02	500mA, 1A, 5A, 10A, 50A
9695-03	5A, 10A, 50A, 100A
9657-10	50mA, 100mA, 500mA, 1A, 5A
9675	5A

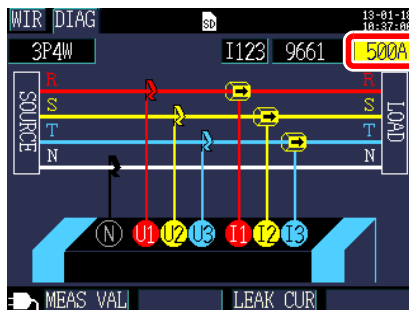

3

3.3 Connecting the Voltage Cords



- To avoid electric shock and short-circuit accidents, use only the specified L9438-53 Voltage Cord to connect the instrument voltage input terminals to the circuit to be tested.
- To ensure voltage cord integrity, grip cords by the plug when connecting or disconnecting them.

Connect the L9438-53 voltage cords to the instrument's voltage input terminals while checking the **[WIR, DIAG]** screen. The instrument ships with one each of the black, red, yellow, and blue voltage cords and alligator clips as well as five spiral tubes. Group the cords together with the spiral tubes as necessary.

See: "Bundle the Voltage Cord Leads with the Spiral Tubes" (p. 24)

Preparation items

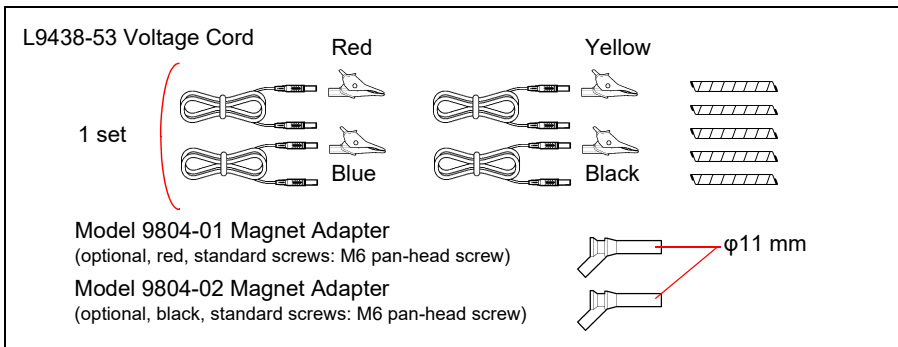

Voltage cords used by wiring type

Measurement target	Voltage cord to use (color)
Single-phase/2-wire (1P2W), Single-phase/3-wire (1P3W1U)	Two cords (black and red)
Single-phase/3-wire (1P3W) 3-phase/3-wire (3P3W2M)	Three cords (black, red, and yellow)
3-phase/3-wire (3P3W3M)	Three cords (red, yellow, and blue)
3-phase/4-wire (3P4W)	Four cords (black, red, yellow, and blue)

The voltage cords connection

- 1** Attach the alligator clip or magnet adapter to the end of the voltage cord.

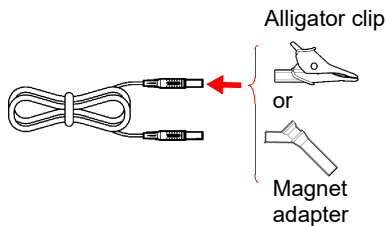

- 2** Insert the voltage cords into the voltage input terminals while checking the [WIR, DIAG] screen.

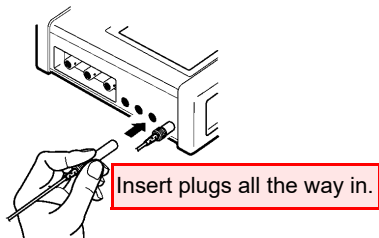
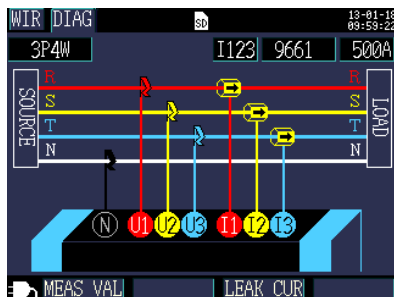

3.4 Connecting the Clamp Sensors



CAUTION When disconnecting the BNC connector, be sure to release the lock before pulling off the connector. Forcibly pulling the connector without releasing the lock, or pulling on the cable, can damage the connector.

Connect the optional clamp sensors to the instrument's current input terminals while checking the **[WIR, DIAG]** screen. (Provide the required number of sensors according to the line and connection type being measured.)

Measurement target	Number of clamp sensors in use (Colors of the CH and colored clips)
Single-phase 2-wire (1P2W)	1 (CH1 red)
Single-phase 2-wire (1P2W) 2 circuits	2 (CH1 red, CH2 yellow)
Single-phase 2-wire (1P2W) 3 circuits	3 (CH1 red, CH2 yellow, CH3 blue)
Single-phase 3-wire (1P3W)	2 (CH1 red, CH2 yellow)
Single-phase 3-wire (1P3W) + I	3 (CH1 red, CH2 yellow, CH3 blue)
3-phase 3-wire (3P3W2M)	2 (CH1 red, CH2 yellow)
3-phase 3-wire (3P3W2M) + I	3 (CH1 red, CH2 yellow, CH3 blue)
3-phase 3-wire (3P3W3M)	
3-phase 4-wire (3P4W)	

See the instruction manual supplied with the clamp sensor for specification details and usage procedures.

3.4 Connecting the Clamp Sensors

- 1** Connect the clamp sensors' BNC connectors to the current input terminals while checking the [WIR, DIAG] screen.

Align the groove on the BNC connector with the connector guide on the instrument and push it into place.

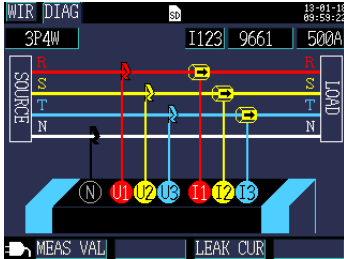

PW3360 current input terminal Connector, align-



Current input terminals



- 2** Turn the connector clockwise to lock it in place.

(To disconnect the connector, turn it counterclockwise to unlock it and then pull.)



Lock

3.5 Connecting the Voltage Cords to Lines to be Measured

Connect the voltage cords to the lines to be measured while checking the [WIR, DIAG] screen.

Example: When using the alligator clips

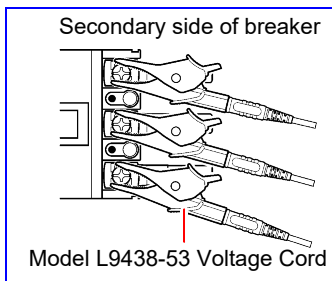

Securely clip the cords to the metallic part of the screw or wiring bar on the secondary side of the circuit breaker.

Example: When using Model 9804-01 or 9804-02 Magnet Adapter (optional, standard screw: M6 pan head screw)

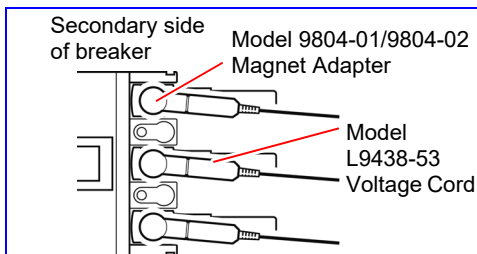

Connect the magnetic part of the 9804-01 or 9804-02 tip to the screws on the secondary side of the breaker.

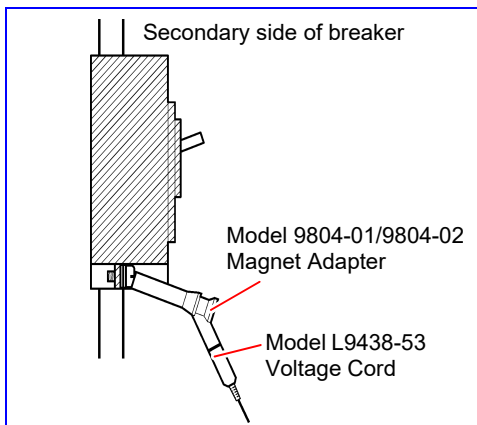

The weight of the voltage cords may prevent you from making a perpendicular connection to the Model 9804-01 or 9804-02 Magnet Adapter. In this case, connect each cords so that it is hanging off the adapter in a manner that balances its weight. Check the voltage values to verify that the connections have been made securely.

3.6 Connecting Clamp Sensors to Lines to be Measured

Connect the clamp sensors to the lines to be measured while checking the **[WIR, DIAG]** screen.



Note that the clamp sensor may be damaged if the applied current exceeds the maximum input current.

For more information about clamp sensor specifications, see the instruction manual that came with the clamp sensor.

Load Current Measurement

Make certain that the current flow direction arrow points toward the load.

Example

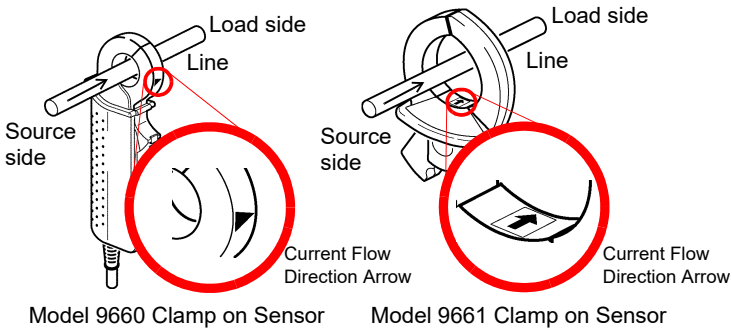

Attach the clamp around only one conductor. Single-phase (2-wire) or three-phase (3-wire) cables clamped together will not produce any reading.

Example

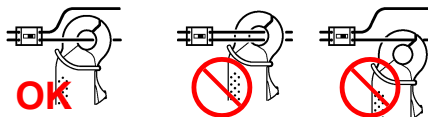

Leakage Current Measurement

single-phase/2-wire: Place the clamp around two wires.
 single-phase/3-wire: Place the clamp around three wires.
 3-phase/3-wire: Place the clamp around three wires.
 3-phase/4-wire: Place the clamp around four wires.
 Grounding wire: Place the clamp around one wire.

Example

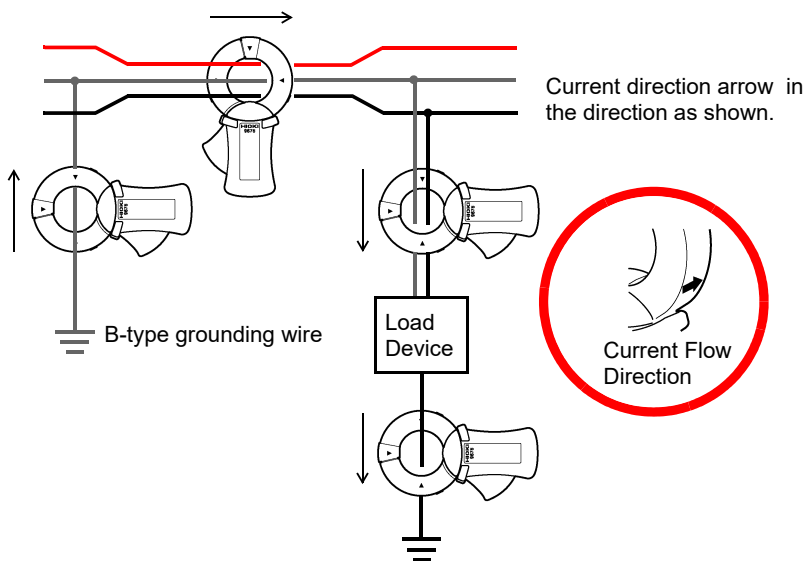

3.7 Attaching Cords on a Wall (if required)

Be sure to read "Using Magnetic Strap" (p. 9)

Using Model Z5004 Magnetic Strap allows you to attach voltage cords and cords of current sensors to a wall or panel (steel).

In particular, Model Z5004 can prevent the own weight of the voltage cords from detaching those alligator clips or magnet adapters.

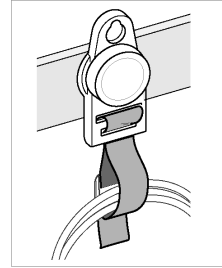

How to attach the strap

Put the strap through the strap loop of the instrument.



Put the strap through the buckle.



The magnetic force varies depending on thickness and unevenness of steel panels. Check for lack of the magnetic force so as not to let the instrument slip down.

3.8 Setting the Current Range

Check the current value on the [WIR, CHK] screen and set an appropriate current range as follows:

1 Press the  key to display the [WIR, CHK] screen.

2 Press  [CIRCUIT] to switch circuits

When measuring multiple single-phase/2-wire (1P2W) circuits or when “current only” is selected, you can set a different range for each circuit.

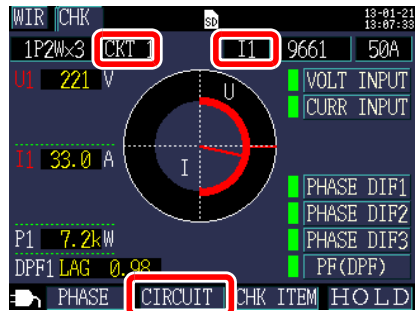

3.8 Setting the Current Range

3 Check the current value and set the current range.

When measuring multiple single-phase/2-wire (1P2W) circuits or when “current only” is selected, you can select other channels in the same way and set the range.

Selecting an appropriate range

Select an appropriate range based information such as the load rating, operating conditions, and breaker rating. If the range is too low, you will experience an over-range event during measurement, making accurate measurement impossible. Conversely, if the range is too high, the error will be too large, making accurate measurement impossible. Set the current range based on the maximum load current that is anticipated during the measurement interval.

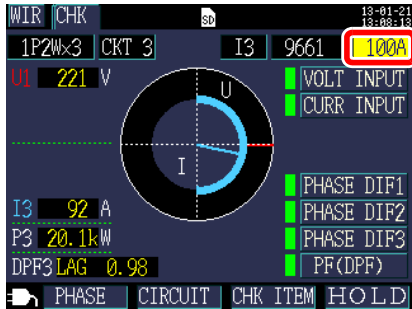

9660	5A, 10A, 50A, 100A
9661	5A, 10A, 50A, 100A, 500A
CT9667-500A	50A, 100A, 500A
CT9667-5kA	500A, 1kA, 5kA
9669	100A, 200A, 1kA
9694	500mA, 1A, 5A, 10A, 50A
9695-02	
9695-03	5A, 10A, 50A, 100A
9657-10	50mA, 100mA, 500mA, 1A, 5A
9675	

3.9 Verifying Correct Wiring (Wiring Check)

Check whether the instrument has been connected properly on the [WIR, CHK] screen.

- 1** Press the **WIRING** key to display the screen.

A green (PASS) wiring confirmation result indicates that there is no problem with the wirings. You can also check the active power and power factor.

How to read the graph

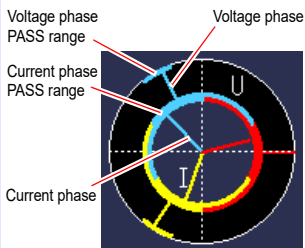

Result

Green : PASS
Red : FAIL
Yellow : CHECK

The power factor is displayed as DPF (displacement power factor) on the Connection Confirmation screen, regardless of the [PF/Q/S CALC] setting.

See: "PF/Q/S calculation" (p. 72)

"Appendix4 Terminology" (p. A6)

- 2** Press the **F1** [PHASE] key.

You can check the voltage and current fundamental wave phase angle (measured value).

See: 5.4, "Viewing Voltage and Current Value Details" (p. 93)

- 3** If you have selected a 1P2W×2 or ×3 circuits

You can change the circuit with [CIRCUIT].

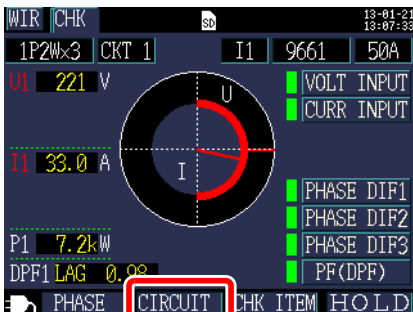

3.9 Verifying Correct Wiring (Wiring Check)

4 If the wiring confirmation result is red (FAIL) or yellow (CHECK)

Press **F3** [CHK ITEM] so that you can move the cursor to the wiring check items.



5 Move the cursor to the item that has been tagged as red (FAIL) or yellow (CHECK) and press the **[ENTER]** key.

A dialog box with helpful information for fixing the wiring will be displayed. Review its content.

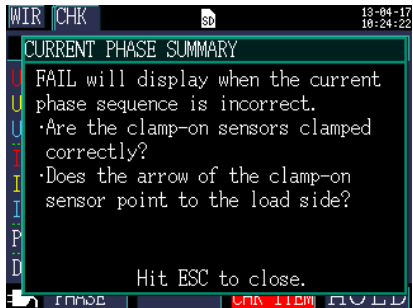

6 Press the **ESC** key to close the dialog box.

Review similar information for other wiring confirmation items as necessary.

7 Press the **WIRING** key to display the [WIR, DIAG] screen and check the actual wirings against the diagram shown on the screen.

8 Fix any incorrect wirings and check the [WIR, CHK] screen again.

3.9 Verifying Correct Wiring (Wiring Check)

If the wiring confirmation result is [CHECK] or [FAIL]

wiring confirmation item	Judgment conditions	Confirmation steps
Voltage input	<p>FAIL will display when voltage value is less than 50V. FAIL will display when at wiring other than 1P2W, the lowest voltage value is 70% or less of the highest voltage value.</p>	<ul style="list-style-type: none"> • Are the voltage test leads completely inserted into the voltage input terminals? • Are the alligator clips attached to the voltage test leads properly? • Are the alligator clips completely attached to the metallic part of the objects to be measured?
	<p>See: 3.3, "Connecting the Voltage Cords" (p. 52) See: 3.5, "Connecting the Voltage Cords to Lines to be Measured" (p. 57)</p>	
Current input	<p>FAIL will display when input is less than 1% of the current range. CHECK will display when input is less than 10% of the current range.</p>	<p>When no current is flowing, a Wiring Check cannot be performed. Operate the equipment and keep current flowing in order to check the wiring. If the equipment cannot be operated, a proper Wiring Check cannot be conducted. Visually check for proper wiring before measuring.</p> <ul style="list-style-type: none"> • Are the clamp-on sensors properly inserted into the current input terminals? • Are the clamp-on sensors clamped correctly? • Is the set current range too large for the input level?
	<p>See: 3.4, "Connecting the Clamp Sensors" (p. 55) See: 3.6, "Connecting Clamp Sensors to Lines to be Measured" (p. 58)</p>	
Voltage phase	<p>FAIL will display when the voltage phase exceeds the range (± 10 degrees of reference.)</p>	<ul style="list-style-type: none"> • Are the wiring settings correct? • Are the voltage leads correctly wired? • Were the phases incorrectly laid out during construction? Switch the voltage test leads and adjust the connections of the clamp-on sensors so that PASS is displayed. To double-check, use a phase detector to confirm that the phases are in the correct sequence.
	<p>See: 3.2, "Setting Measurement Conditions on the Wiring Diagram Screen" (p. 47) See: 3.5, "Connecting the Voltage Cords to Lines to be Measured" (p. 57)</p>	

3.9 Verifying Correct Wiring (Wiring Check)

wiring confirmation item	Judgment conditions	Confirmation steps
Current phase	FAIL will display when the current phase sequence is incorrect.	<ul style="list-style-type: none"> • Are the clamp-on sensors clamped correctly? • Does the arrow of the clamp-on sensor point to the load side?
	<p>See: 3.2, "Setting Measurement Conditions on the Wiring Diagram Screen" (p. 47)</p> <p>See: 3.6, "Connecting Clamp Sensors to Lines to be Measured" (p. 58)</p>	
Phase difference	FAIL will display when each current phase is not within 90° with respect to the voltage of each phase.	<ul style="list-style-type: none"> • Are V leads and clamp sensors connected? • Is arrow of clamp sensor pointed to the load?
	CHECK appears if curr. phase is w/in ± 60 to $\pm 90^\circ$ of each volt. phase.	<ul style="list-style-type: none"> • Are V leads and clamp sensors connected? • Is arrow of clamp sensor pointed to the load? • In light loads, PF may be low and phase diff. may be large. Check wiring for problems and proceed if OK. • When phase advances too much due to phase advancer in light loads, PF may be low and phase diff. may be large. Check wiring for problems and proceed if OK.
	<p>See: 3.3, "Connecting the Voltage Cords" (p. 52) to 3.6, "Connecting Clamp Sensors to Lines to be Measured" (p. 58)</p>	
Power factor	CHECK will display if the power factor of the line to be measured is less than 0.5.	<ul style="list-style-type: none"> • Are the clamp-on sensors clamped correctly? • Does the arrow of the clamp-on sensor point to the load side? • When the load is light, the power factor may be low and the phase difference may be large. Check the wiring and if no problems are observed, you may proceed with the measurement • When the phase advances too much due to the use of a phase advance capacitor during a light load, the power factor may be low and the phase difference may be large. Check the wiring and if no problems are observed, you may proceed with the measurement
		<p>See: 3.4, "Connecting the Clamp Sensors" (p. 55)</p> <p>See: 3.6, "Connecting Clamp Sensors to Lines to be Measured" (p. 58)</p>

Changing Settings

Chapter 4

You can change any setting item on the setting screen.

See: 10.1, "LAN Communications" (p. 153)

See: 11.2, "Configuring Pulse Settings" (p. 173)

4.1 Viewing and Using the Settings Screen

Allows you to switch to the Settings screen and change the Setting screen.



Allows you to review settings details (help function).

Saves settings data.

See: 8.4, "Saving Settings Files" (p. 127)

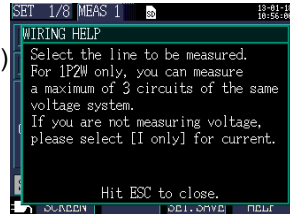

Allows you to select a Settings screen.



Selects a screen name from a list.

Changing an item

Select an item. Display a pull-down menu. Select an item. Accept the selection.

Changing a value

Select an item. Make it editable. Move to the desired digit. Increase the value by 1. Decrease the value by 1. Accept the value.

4.2 Changing Measurement Settings

You can change measurement conditions on the [SET 1/8, MEAS 1] and [SET 2/8, MEAS 2] Settings screens.

Measurement 1 Setting Screen

		SENSOR	RANGE	CT
CURRENT	I1	9661	500A	1
	I2	9661	500A	1
	I3	9661	500A	1

Select the clamp sensor.

SCREEN SET. SAVE

Wiring

Selects the measurement line wiring method.

See: "Selecting the wiring method" (p. 48)

Frequency

Selects the frequency. Use of an improper frequency setting will prevent accurate measurement. Be sure to set the frequency to the measurement line frequency.

Selection

50Hz, 60Hz

4.2 Changing Measurement Settings

- NOTE**
- When a factory reset (p. 87) is performed to reset the instrument to its default settings, no measurement line frequency will have been set. When you turn on the instrument, first set the frequency to the measurement line frequency.

See: "Setting the Language and Measurement Line Frequency (50 Hz/60 Hz)" (p. 31)

- The **[Frequency Setting Error]** dialog box will be displayed if the instrument detects voltage input and determines that the frequency differs from the set frequency. Press the **[ENTER]** key and change the frequency settings.

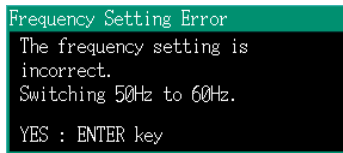

```

Frequency Setting Error
The frequency setting is
incorrect.
Switching 50Hz to 60Hz.
YES : ENTER key
  
```

Clamp sensor, Current range

Selects the clamp sensor being used and the current range.

See: 3.2, "Setting Measurement Conditions on the Wiring Diagram Screen" (p. 47)

CT ratio

Set when using an external CT.

Selection

Manual	0.01 to 9999.99
Select	1/40/60/80/120/160/200/240/300/400/600/800/1200

- NOTE**
- When taking measurements on the secondary side of a current transformer (CT), you can set the CT ratio in order to convert the readings to their primary-side equivalents and display the results. For a CT with a primary-side current of 200 A and a secondary-side current of 5 A, the CT ratio would be 40 (200 A / 5 A).
 - If the 5 A current range were selected with the current sensor, it would be multiplied by the CT ratio of 40 to yield a current range of 200 A.

Measurement 2 Setting Screen

V RANGE	600V FIX
VT(PT)	1
PF/Q/S CALC	RMS
ENERGY COST	UnitCost 0000.00/kWh
	CURRENCY []
THD CALC	THD-F(Fundamental)
Set the VT(PT) ratio.	
SCREEN	SET.SAVE HELP

Voltage range

The voltage range is fixed to 600 V.

VT ratio (PT ratio)

Set when using a VT (PT) to perform measurement.

Selection

Manual	0.01 to 9999.99
Select	1/60/100/200/300/600/700/1000/2000/2500/5000

- NOTE**
- When taking measurements on the secondary side of a voltage transformer (VT), you can set the VT ratio in order to convert the readings to their primary-side equivalents and display the results. For a VT with a primary-side voltage of 6.6 kV and a secondary-side voltage of 110 V, the VT ratio would be 60 (6,600 V / 110 V).
 - Since the current range is fixed at 600 V, it would be multiplied by the VT ratio of 60 to yield a voltage range of 36 kV.

4.2 Changing Measurement Settings

PF/Q/S calculation

Select the method for calculating power factor (PF), reactive power (Q), and apparent power (S).

See: 12.5, "Calculation Formulas" (p. 204)

RMS calculation is generally used in applications such as checking transformer capacity, but fundamental wave calculation is used when measuring power factor and reactive power, which are related to electricity fees.

Selection

RMS	<p>Uses voltage and current RMS values to calculate the power factor, reactive power, and apparent power.</p> <ul style="list-style-type: none"> • Power factor PF (RMS power factor) • Reactive power Q (calculated from RMS values) • Apparent power S (calculated from RMS values)
FUNDAMENTAL	<p>Uses voltage and the current fundamental wave to calculate the power factor, reactive power, and apparent power.</p> <ul style="list-style-type: none"> • Power factor DPF (displacement power factor) • Reactive power Q (fundamental wave reactive power) • Apparent power S (fundamental wave apparent power) <p>This is the same measurement method as is used by reactive-power meters installed at large electricity consumers' facilities. The value will be close to that obtained when using the 3169-20/21 Clamp on Power HiTester's "Use reactive power measurement method" option.</p>

Energy cost

You can display electricity charges by setting the unit cost (per kWh) and having the instrument multiply the electricity charge unit cost by the active energy (consumption) WP+ value.

Selection

Unit Cost	0.00000 to 99999.9/kWh
CURRENCY	Set to any three alphanumeric characters. For example, to use the US dollar as the currency, set to "USD," etc.

Setting the Unit Cost



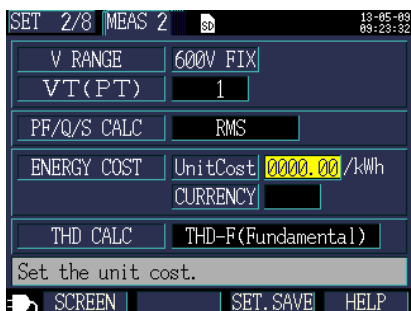

- 1 Move the cursor to **[Unit Cost]**.







- 2 Press the  [ENTER] key.

- 3 A dialog box for setting the unit cost will be displayed.



To slide the decimal point, move the cursor to the decimal point with the  /  cursor keys, and slide it with the  /  cursor keys.

- 4 To set the unit cost, move the cursor to the digit to be changed with the  /  cursor keys, and change the figure with the  /  cursor keys.

- 5 Accept the new value with the  [ENTER] key.

Setting the Currency

- 1** Move the cursor to **[CURRENCY]**.

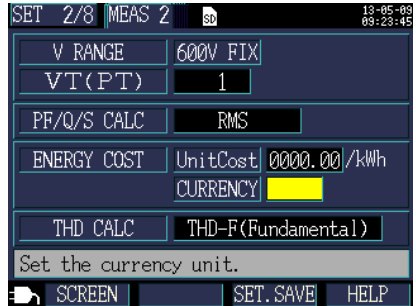

- 2** Press the **[ENTER]** key.

- 3** A dialog box for setting the currency will be displayed.

Select one character at a time with the cursor keys and then accept the entered currency with the **[ENTER]** key.

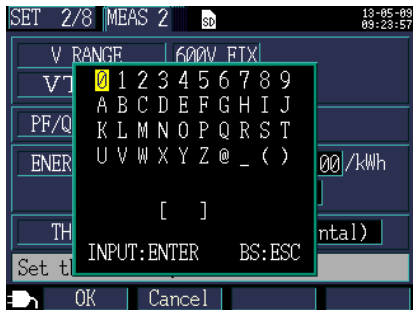

- 4** Once you have entered the currency, accept it with the **[F1]** **[OK]** key. Pressing **[F2]** **[Cancel]** will cancel the entered currency.

THD calculation (PW3360-21 only)

Selects the method used to calculate total harmonic distortion (THD). The THD-F method is typically used.

Selection

THD-F (Fundamental)	Calculates by dividing the harmonic component (total of 2nd to 40th order) by the fundamental wave.
THD-R (RMS)	Calculates by dividing the harmonic component (total of 2nd to 40th order) by the RMS value (total of 1st to 40th order).

4.3 Changing Recording (Save) Settings

You can change the conditions used to record (save) measurement data on the [SET 3/8, REC 1] and [SET 4/8, REC 2] Settings screens.

Recording 1 Setting Screen

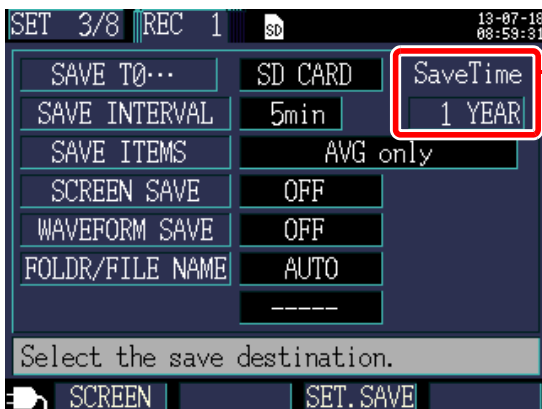

Data storage time
Since the instrument can perform recording and measurement for a maximum of one year, the maximum data storage time is one year.

Save destination

Selects the save destination for measurement data.

Selection

SD CARD	Saves data on the SD memory card. If no SD memory card is inserted, data will be saved in the instrument's internal memory.
INTERNAL M	Saves data in the instrument's internal memory (capacity: approximately 320 KB).

NOTE If the SD memory card is full, the instrument saves data into the internal memory. If both the SD card and the internal memory are full, the instrument stops saving data. The stored data is not overwritten.

Save interval

Selects the interval at which to save measurement data.

Selection

1 sec/2 sec/5 sec/10 sec/15 sec/30 sec,
1 min/2 min/5 min/10 min/15 min/20 min/30 min/60 min

4.3 Changing Recording (Save) Settings

Save items

Selects whether to save the average only or all data (average, maximum, and minimum values) for data that is saved at each interval. Energy- and demand-related measurement data is saved regardless of this setting. With the PW3360-21 (which includes harmonic measurement functionality), you can also set whether to save harmonic data. Harmonic data cannot be saved in the instrument's internal memory.

To save harmonic data, set the save destination to [SD CARD].

When the save destination is set to [Internal M], harmonic data is not saved; only recorded measurement data such as voltage, current, power, demand, energy, and other data are saved to the instrument's internal memory.

When you wish to save peak values, select **[ALL data]**. If **[AVG only]** is set, the instrument will save no peak values because the voltage and current peak values do not have average values.

Model PW3360-20 (without harmonic functionality)

Selection

AVG only	Saves average values only.
ALL data	Saves all data (average, maximum, and minimum values).

Model PW3360-21 (with harmonic functionality)

Selection

AVG only (no Harmonic)	Saves average values only. No harmonic data is saved.
ALL data (no Harmonic)	Saves all kinds of values (average, maximum, and minimum values). No harmonic data is saved.
AVG only (w/Harmonic)	Saves average values only. Harmonic data is also saved.
ALL data (w/Harmonic)	Saves all kinds of values (average, maximum, and minimum values). Harmonic data is also saved.

- NOTE**
- Ordinarily, select “Average only.” When you wish to save data such as the following, select “All (average, maximum, and minimum values)”:
Maximum: To check maximum values for current, power, etc.
Minimum: To check minimum values for voltage, power factor, etc.
 - When a “Current only” connection is being used, average values are not used for the current fundamental wave phase angle.
 - Average values are calculated from the results of continuous calculations performed every 200 ms during the save interval.
 - Maximum and minimum values indicate the largest and smallest results obtained from continuous calculations performed every 200 ms during the save interval.
 - For more information about how average, maximum, and minimum values are processed, see “Maximum/minimum/average value processing methods” (p. 198).
 - Recording and measurement data (CSV format) (including values such as normal voltage, current, power, demand, and energy) and harmonic data (binary format) are saved in different files.
- See:** Chapter 8, “Saving Data and Manipulating Files” (p. 117)

Screen save

Selects whether to save the displayed screen as a BMP file at the specified interval. The shortest interval is 5 minutes. If a value of less than 5 minutes is specified, the screen will be saved every 5 minutes. Screen copies cannot be saved in the instrument’s internal memory. To save screen copies, set the save destination to **[SD CARD]**.

Selection

ON	Saves screen copies.
OFF	Does not save screen copies.

- NOTE** Be sure to perform recording and measurement after displaying the screen you wish to save. The screen being displayed is the screen that will be copied.

4.3 Changing Recording (Save) Settings

Waveform save

Sets whether to save waveform data for each time interval as a binary-format file. The minimum time interval is 1 minute. When the parameter is set to less than 1 minute, waveforms are saved every minute. Waveforms are not saved in the instrument's internal memory. To save waveforms, set the save destination to **[SD card]**. The instrument will save waveforms of two waves in length (420 samples) at 10.24-kilohertz sampling.

Selection

ON	The waveforms will be saved.
OFF	The waveforms will not be saved.

Folder/File name

Sets the filename used to save data.

See: 8.2, "Folder and File Structure" (p. 120)

Selection

MANUAL	Allows the user to set a folder name with a dialog box (up to five byte characters). When measurement is repeated without changing the folder name, a number will be automatically appended to the folder and file name. (Folder/filename + folder sequential number [2 digits])
AUTO	Automatically appends a number in the format "YYMMD-DXX." The first six characters consist of the date, and subsequent numbers consist of a sequential number.

NOTE The maximum file size for measurement data is 200 MB approximately. When this size is exceeded, a separate file will be created in which to save the data. (Folder/filename + folder sequential number [2 digits] + file sequential number [2 digits])

Procedure

- 1** Move the cursor to **[FOLDER/FILE NAME]**.

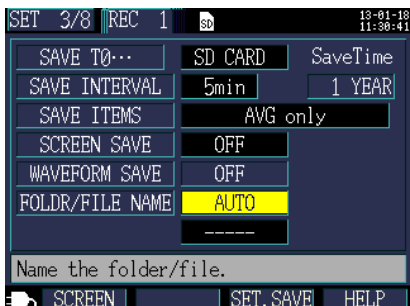

- 2** Press the **[ENTER]** key and select **[MANUAL/AUTO]**.

- 3** If you selected **[MANUAL]**:
A dialog box for inputting the folder and file name will be displayed.
Select one character at a time with the cursor keys and then accept the entered name with the **[ENTER] key.**

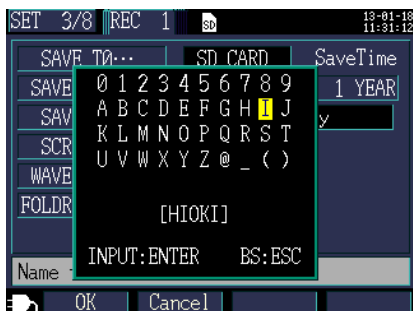



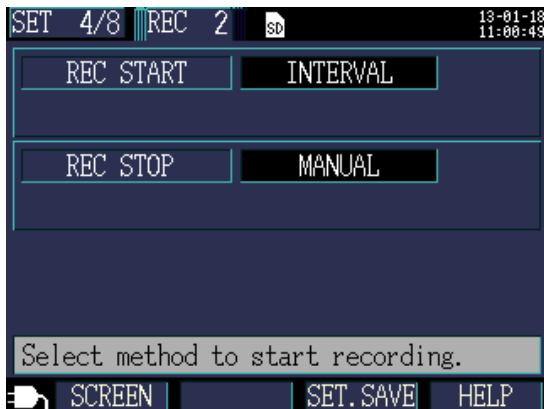

- 4** Once you have entered the folder/filename, accept it with the **[F1] [OK]** key.
Pressing **[F2] [Cancel]** will cancel the entered folder/filename.

Recording 2 Setting Screen

**Recording start method**

Sets the method used to start recording.

Selection

MANUAL	Starts recording from the point at which the ^{START/STOP}  key is pressed.
TIME	Recording is started at the set time (YY/MM/DD hh:mm). If the set time has already passed, the “interval time” starting method is used.
INTERVAL	Starts recording at an even division after the interval time elapses. Example: If the ^{START/STOP}  key is pressed at 10:41:22 with the save interval set to 30 minutes, the instrument will enter the standby state, and recording will start at 11:00:00. Similarly, if the save interval is set to 10 minutes, recording will start at 10:50:00. If the save interval is set to 30 seconds or less, recording will start from the next :00 seconds.
REPEAT	Repeats recording while segmenting files every day. Recording is started on the repeat start date. After the ^{START/STOP}  key is pressed, when the specified recording time period on the start date comes, recording is started. If the ^{START/STOP}  key is pressed after the starting time of the recording time period, the interval time starting method is employed. Recording is stopped when the recording time period on the stop date ends.

Specifying a time

- 1** Move the cursor to the recording start method, press the

 [ENTER] key, and select [TIME].

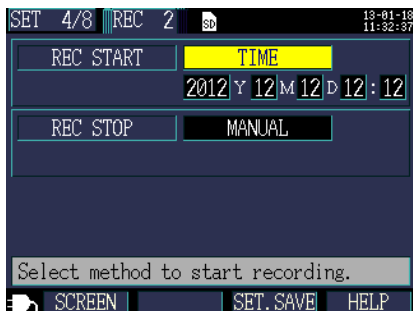

- 2** Move the cursor to the time setting you wish to change and

press the  [ENTER] key.

The cursor will change to the size of one digit, and you will be able to change the setting.

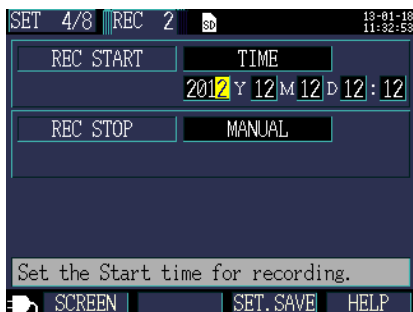

- 3** Change the setting with the  /  cursor keys and then accept the new value with the  [ENTER] key.

Change other settings as necessary.

Recording stop method

Sets the method used to stop recording.

Selection

MANUAL	Stops recording when the  key is pressed.
TIME	Selecting [TIME] causes a dialog box for setting the time to be displayed. Recording is stopped at the set time (YY/MM/DD hh:mm). If the set time has already passed when recording is started, the "manual" stopping method is used.
TIMER	Recording is stopped automatically when the set timer time has elapsed.

4.3 Changing Recording (Save) Settings

Selection

REPEAT	Recording is repeated while segmenting files every day. Recording is stopped when the recording time period on the repeat stop date ends. The stop method cannot be changed during repeat recording.
---------------	--

NOTE The maximum recording and measurement time is up to one year. Recording will stop automatically in one year.

Record period (repeat recording only)

Sets the time period during which to record data when performing repeat recording. If the time period is set to 00:00 to 24:00, recording is reset every day at 0:00 and then resumes immediately.

If the time period is set from 8:00 to 18:00, data (integrated power) is measured and recorded for that period of time only. In this case, data (integrated power) will not be measured from 0:00 to 8:00 or from 18:00 to 24:00.

When repeat recording is selected with Quick Setup, the recording time period is fixed to 00:00 to 24:00 and cannot be changed.

Segment folder (repeat recording only)

Sets the period at which to segment folders.

When repeat recording is selected with Quick Setup, folder segmenting is fixed to off and cannot be changed.

NOTE When loading data into the SF1001 Power Logger Viewer (optional), using folder segmenting prevents data in segmented folders from being loaded together as a single set of data. If you wish to treat all measurements as part of the same set of data using the SF1001, do not use folder segmenting.

Selection

OFF	Disables folder segmenting.
DAY	Creates a new folder every day. Up to 100 days of data can be saved using this setting.
WEEK	Creates a new folder every seven days from the start of recording.
MONTH	Creates a new folder on the first day of every month.

4.4 Changing System Settings (as Necessary)

You can change system settings on the [SET 5/8, SYS 1] and [SET 6/8, SYS 2] Settings screens.

System 1 Setting Screen

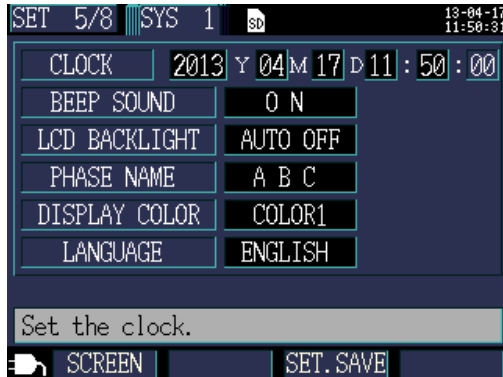

Clock

Sets the date and time (using the Western calendar and 24-hour time).

See: "Specifying a time" (p. 81)

NOTE The seconds cannot be set. After changing the time, pressing the **[ENTER]** key causes the seconds to be reset to 00.

Beep sound

Turns the key press beep on and off.

Selection

ON/OFF

LCD backlight

Selects whether to automatically turn off the LCD backlight.

Selection

AUTO OFF	Automatically turns off the backlight once two minutes have elapsed since the last key operation. The POWER LED will flash while the backlight is off.
ON	Keeps the backlight on at all times.

4.4 Changing System Settings (as Necessary)**Phase name**

Selects the phase names for the measurement lines displayed on the [WIR, DIAG] screen.

Selection

R S T, A B C, L1 L2 L3, U V W

Screen color

Selects the screen color.

Selection

COLOR 1 to 3

Language

Selects the display language.

Selection

JAPANESE	Selects the Japanese display.
ENGLISH	Selects the English display.
CHINESE	Selects the Chinese display.
GERMAN	Selects the German display.
ITALIAN	Selects the Italian display.
FRENCH	Selects the French display.
SPANISH	Selects the Spanish display.
TURKISH	Selects the Turkish display.
KOREAN	Selects the Korean display.

System 2 Setting Screen

**Start Quick Set at power-on**

Selects whether to display the Quick Set start dialog box when the instrument is turned on.

Selection

OFF	Display the Measurement screen instead of displaying the Quick Set start dialog box when the instrument is turned on. The Quick Set can be displayed by pressing the  [QUICK SET] key, even when this option is set to OFF.
ON	Displays the Quick Set start dialog box when the instrument is turned on.

Instrument information

Displays the instrument's serial number and software and FPGA versions.

The serial number consists of 9 digits. The first two (from the left) indicate the year of manufacture, and the next two indicate the month of manufacture.

4.5 Initializing the Instrument (System Reset)

If the instrument seems to be malfunctioning, consult "Before Having the Instrument Repaired" (p. 219). If the cause of the problem remains unclear, try a system reset.

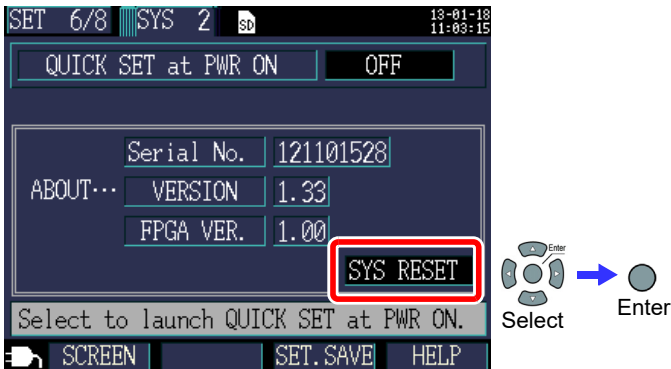



Performing a system reset causes all settings other than the frequency setting, clock, language setting, IP address, subnet mask, and default gateway to be initialized to their default values. The instrument's internal memory will not be erased.

Reverting the Instrument to Its Factory Settings (Factory Reset)

You can revert all settings, including frequency, language, and communications settings, to their default values by turning on the instrument when you perform a factory reset. The instrument's internal memory will be erased.

1 Turn off the power switch.

2 Turn on the instrument while holding down the  [ENTER] and  keys, and continue holding them down until the beep sounds after the self-test is complete.



3 The instrument will be reset to its factory settings, and the Language Setting screen will be displayed.

See: "Setting the Language and Measurement Line Frequency (50 Hz/60 Hz)" (p. 31)



4.6 Factory Settings

All settings' default values are as follows:

Screens	Settings	Default value	
MEAS 1	Wiring	3P4W	
	Frequency	Not set. Select 50 Hz or 60 Hz when the instrument is powered on for the first time.	
	Current	Sensor: Model 9661, Range: 500A, CT ratio: 1	
MEAS 2	Voltage Range	600V fixed	
	VT (PT) ratio	1	
	PF/Q/S Calculation	RMS	
	Energy cost	Unit cost: 0000.00/kWh, Currency: Not set.	
	THD calculation (PW3360-21 only)	THD-F (Distortion component/Fundamental wave)	
REC 1	Save Destination	SD card	
	Save Interval	5 minutes	
	Save Items	PW3360-20: AVG only PW3360-21: AVG only (no harmonics)	
	Screen Save	Off	
	Folder/ File Name	Auto	
REC 2	Recording start method	Interval	
	Recording stop method	Manual	
SYS 1	Clock	Set at time of shipment.	
	BEEP Sound	On	
	LCD Backlight	Auto Off	
	Phase Name	ABC	
	Display color	Color 1	
	Language	Not set. Select Japanese, English, Chinese or OTHERS (JAPANESE/ENGLISH/CHINESE/GERMAN/ITALIAN/FRENCH/SPANISH/TURKISH/KOREAN) when the instrument is powered on for the first time.	
SYS 2	Start Quick Set at power-on	Off	
LAN	IP Address	192.168.1.31	
	Subnet Mask	255.255.255.0	
	Default Gateway	192.168.1.1	
PULSE	Pulse Input	Filter	Off
		Scaling	001.000
		Aux unit	None
		Unit	Not set.
	Pulse Output	Output rate	1 kWh
		Pulse width	100 ms FIX

Viewing Measurement Data

Chapter 5

The PW3360 allows you to view measured values, waveforms, and graphs on the Measurement screen.

5.1 Viewing and Using the Measurement Screen

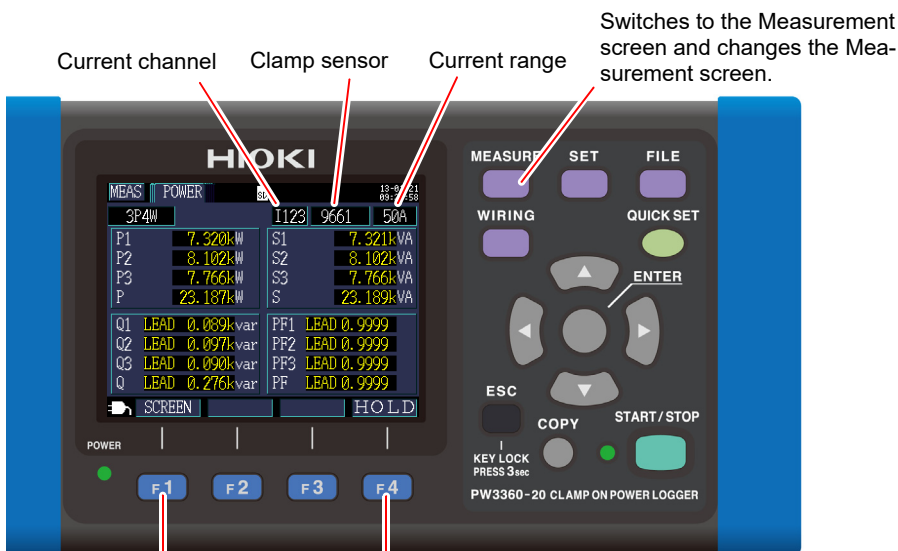

Holds measured values. While values are being held, the HOLD indicator will turn red.



Allows you to select a Measurement screen.



Selects a screen name from a list.

- NOTE**
- If a setting is changed while measured values are being held, the hold will be canceled.
 - The time display is not fixed while measured values are being held.

5.1 Viewing and Using the Measurement Screen

1P2W x 2 or 1P2W x 3 Wiring

For 1P2W x 2 or x 3 wirings, select the circuit.

Selects the circuit.

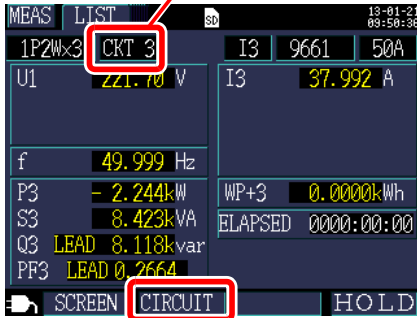



Changes the circuit.

For 1P2W x 2 or 1P2W x 3 wirings, you must change the circuit since the **[MEAS, LIST]** and **[MEAS, POWER]** screens vary with the circuit. The circuit number and current channel displays will change.

5.2 List of Measurement Screens

Screen name	Displayed data	Reference
List	Voltage RMS (U), current RMS (I), frequency (f), active power (P), reactive power (Q), apparent power (S), power factor (PF) or displacement power factor (DPF), active energy (consumption) WP+, and elapsed time (The display can be switched between two and three circuits when using a 1P2W connection.)	"5.3" (p.92)
U/I	Voltage RMS (U), voltage fundamental wave value (Ufnd), voltage waveform peak (Upeak or Upk), voltage fundamental wave phase angle (Udeg), current RMS (I), current fundamental wave value (Ifnd), current waveform peak (Ipeak or IpK), and current fundamental wave phase angle (Ideg)	"5.4" (p.93)
Power	Per-channel and total active power P, apparent power S, reactive power Q, power factor PF or displacement power factor DPF	"5.5" (p.94)
Integ.	Active energy (consumption WP+, regeneration WP-), reactive energy (lag WQ+, lead WQ-), recording start time, recording stop time, elapsed time, energy cost (The display can be switched between two and three circuits when using a 1P2W connection.)	"5.6" (p.95)
Demand	Can be switched to active power demand value (consumption Pdem+, regeneration Pdem-), reactive power demand value (lag QdemLAG, lead QdemLEAD), power factor demand value (PFdem), or pulse input. Maximum demand value: Displays the maximum active power demand value MAX_DEM and the time at which it occurred.	"5.7" (p.96)
Harmonic graph (PW3360-21 only)	Harmonic graph (voltage, current, active power level, content percentage, phase angle)	"5.8" (p.97)
Harmonic list (PW3360-21 only)	Harmonic list (voltage, current, active power level, content percentage, phase angle)	"5.9" (p.99)
Waveform	Displays voltage and current waveforms, voltage and current RMS values, and frequency.	"5.10" (p.100)
Zoom	Enlarged view of 4 user-selected parameters	"5.11" (p.102)
Trend	Displays one measurement parameter as selected by the user. Displays the maximum, average, and minimum values and allows cursor measurement.	"5.12" (p.103)

5.3 Viewing Data (Voltage, Current, Power, and Energy) as a List

Press the  or  key to display the **[MEAS, LIST]** screen.



Selects between power factor PF (RMS calculation) and displacement power factor DPF (fundamental wave calculation) with settings.

See: "PF/Q/S calculation" (p. 72)

5.4 Viewing Voltage and Current Value Details (RMS Values, Fundamental Wave Values, Peak Values, and Phase Angles)

Press the **MEASURE** or **F1 [SCREEN]** key to display the **[MEAS, U/I]** (VOLT/CURR) screen.

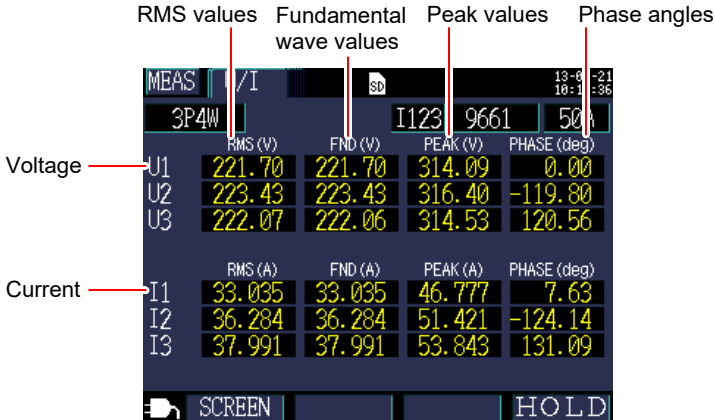



Term	Description
RMS value	The RMS value of 2048 sampling points in a 200 ms interval. The value includes harmonic components.
Fundamental wave value (FND)	The value obtained by extracting only the fundamental wave (50 Hz/60 Hz) component from the voltage or current waveform. "FND" stands for "fundamental."
Peak value (PEAK)	The maximum value of the absolute values of the sampling points (2048 points) in a 200 ms interval.
Fundamental wave phase angle (PHASE)	The phase angle of the fundamental wave component of U1 expressed in terms of 0°. For current only, the fundamental wave phase angle of I1 expressed in terms of 0°.

NOTE For 3P3W3M wirings, the line-to-line voltage is used for RMS calculations, and the phase voltage from the virtual neutral point is used for fundamental wave value, peak value, and fundamental wave phase angle calculations.

See: "Appendix2 Three-phase Measurement" (p. A2)

If you want a value using all line-to-line voltages for a 3-phase/3-wire connection, perform measurement using a 3P3W2M connection. If you want a value using all phase voltages, continue using the 3P3W3M connection but change the connection setting only to 3P4W.

5.5 Viewing Power Details (Channel Power Values)

Press the  or  key to display the **[MEAS, POWER]** screen.

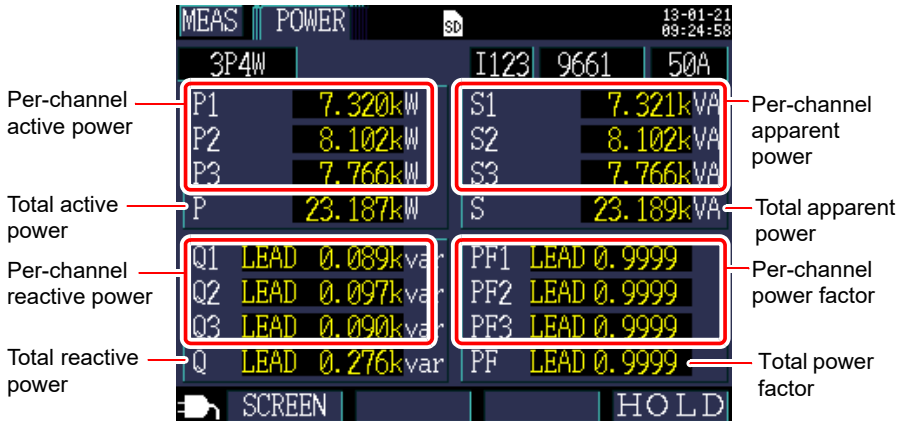



When using the 3-phase/3-wire/2-wattmeter method (3P3W2M), the active power, reactive power, apparent power, and power factor for each channel are obtained by means of a two-wattmeter calculation process and do not have physical significance. However, values for individual channels can serve as reference data when checking the connection.

If you wish to check the balance of power values for individual channels on a 3-phase/3-wire circuit, use the 3-phase/3-wire/3-wattmeter method (3P3W3M).

See: "Appendix2 Three-phase 3-wire Measurement" (p. A2)



5.6 Viewing Energy (Active Energy and Reactive Energy)

Press the  or  [SCREEN] key to display the [MEAS, INTEG.](INTEGRATE) screen.

MEAS		INTEG.		SD	1 YEAR	REC	13-04-11 09:07:06
3P4W		I123		9661	50A		
ACTIVE POWER	CONS	WP+	325.766k Wh				
	REGEN	WP-	0.0000k Wh				
REACTIVE PWR	LAG	WQ+	140.711kvarh				
	LEAD	WQ-	0.0000kvarh				
START	2013-04-10		17:30:00				
STOP	2014-04-10		17:30:00				
ELAPSED	0015:37:06						
ENERGY COST	37.6260 USD						
	SCREEN						HOLD

- NOTE**
- Total energy from the start of recording will be displayed.
 - Energy cost displays the result of multiplying the active energy consumption value WP+ by the Unit cost setting (p. 73).

5.7 Viewing a Demand Graph

Press the  or  [SCREEN] key to display the [MEAS, DEMAND] screen. The instrument stores data for up to 48 of the latest time intervals in its internal memory for user review.

Switches the display parameter.

Active power demand value (consumption Pdem+, regeneration Pdem-)

Reactive power demand value (lag QdemLAG, lead QdemLEAD)

Power factor demand value (PFdem)

Pulse input (Pulse)

When active power demand value (consumption Pdem+) is selected, displays a line indicating the maximum active power demand value (consumption Pdem+) and the time and date of its occurrence.

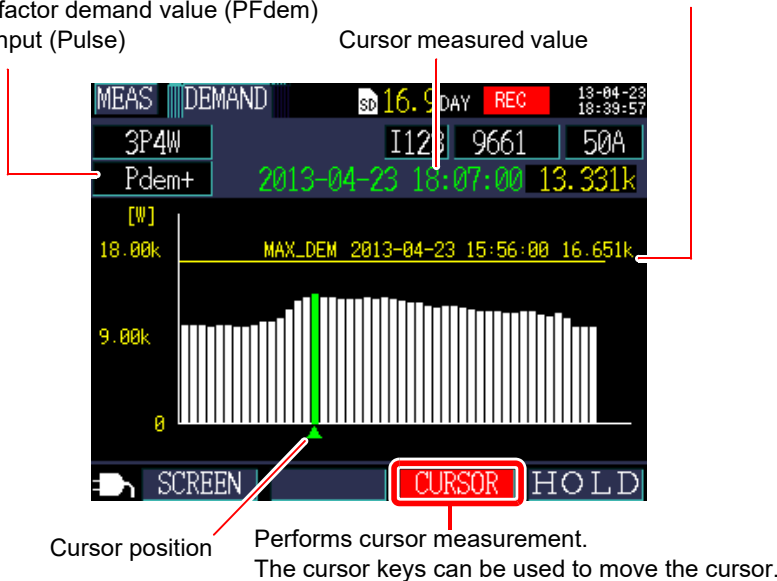

NOTE

- You can review data for up to 48 of the latest time intervals.
- The zoom factor for the vertical axis is set automatically. First, it is set to 1/100, and then switched automatically to 1/5, 1/2, and 1/1 in series according to displayed data levels.
- When using current-only wiring, the display parameter will be fixed to pulse input (Pulse).
- When measured values exceed the display range, the relevant bars are colored.

5.8 Viewing a Harmonic Graph (PW3360-21 only)

Press the **MEASURE** or **F1 [SCREEN]** key to display the **[MEAS, HARM]**(HARMONIC G) screen.

Total harmonic distortion (THD-F or THD-R)

See: "THD calculation (PW3360-21 only)" (p. 74)

THD is not included in power.

Cursor

measured value

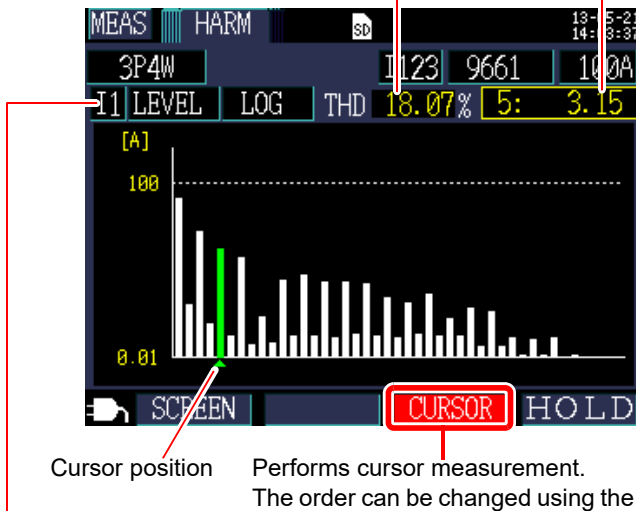

Cursor position

Performs cursor measurement.

The order can be changed using the cursor keys.

Switches the display parameter.

Display parameter	Description
Voltage	U1, U2, U3
Current	I1, I2, I3
Active power	P1, P2, P3, P (total)
LEVEL	Harmonic level for each order Switching between the linear (LINEAR) and logarithmic (LOG) scale axis is available.
%ofFND	Each order's harmonic component expressed as a percentage of the fundamental wave. Switching between the linear (LINEAR) and logarithmic (LOG) scale axis is available.
PHASE	Voltage, current: Phase angle for each order's harmonic component, using the phase of the fundamental wave component for U1 input as 0° Power: Power factor for each order's harmonic component expressed as an angle

5.8 Viewing a Harmonic Graph (PW3360-21 only)

Harmonic power phase angle (vector display) graph screen





Performs cursor measurement.

The order can be changed using the cursor keys.

The display can be changed from the normal bar graph to a vector graph when the display parameter is set to the active power phase angle display. Length is displayed using the LOG axis.

- NOTE**
- The vector length indicates the apparent power for each order's harmonic component as a percentage of the fundamental wave component's apparent power.
 - The horizontal axis indicates active power, while the vertical axis indicates reactive power, both using the LOG axis.

5.9 Viewing a Harmonic List (PW3360-21 only)

Press the  or  key to display the **[MEAS, HARM]**(HARMONIC L) screen.

Total harmonic distortion (THD-F or THD-R)

See: "THD calculation (PW3360-21 only)" (p. 74)

THD is not included in power.

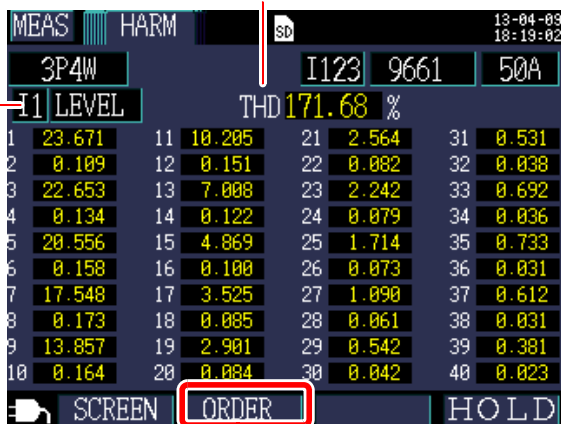

Changes the displayed order.

Press  **[ORDER]** to cycle through the following options: All orders (1st to 40th) → Odd-numbered orders only → 1st to 20th orders → All orders.

Switches the display parameter.

Display parameter	Description
Voltage	U1, U2, U3
Current	I1, I2, I3
Active power	P1, P2, P3, P (total)
LEVEL	Harmonic level for each order Switching between the linear (LINEAR) and logarithmic (LOG) scale axis is available.
%ofFND	Each order's harmonic component expressed as a percentage of the fundamental wave. Switching between the linear (LINEAR) and logarithmic (LOG) scale axis is available.
PHASE	Voltage, current: Phase angle for each order's harmonic component, using the phase of the fundamental wave component for U1 input as 0° Power: Power factor for each order's harmonic component expressed as an angle

5.10 Viewing Waveforms

Press the  or **F1** [**SCREEN**] key to display the **[MEAS, WAVE]**(WAVEFORM) screen.

Voltage waveforms
 U1: Red
 U2: Yellow
 U3: Blue

Voltage vertical axis
 Voltage value for 1 division

Current waveforms
 I1: Red
 I2: Yellow
 I3: Blue

Current vertical axis
 Current value for 1 division

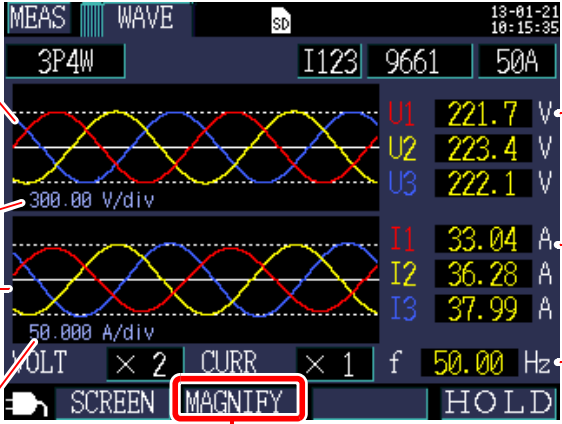

Voltage RMS

Current RMS

Frequency

Changes the zoom factor for the vertical axis used to display voltage and current waveforms. (p. 100)

Changing the Zoom Factor for the Vertical Axis Used to Display Voltage and Current Waveforms

1 Press the **F2** [MAGNIFY] key.
The cursor will move to the zoom factor field, and you will be able to change the setting.

2 Move the cursor to the voltage or current zoom factor and press the **[ENTER]** key.

A dialog box for selecting the zoom factor will be displayed.

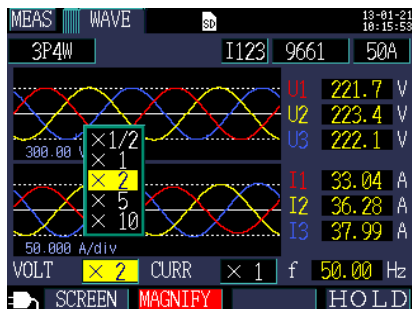

3 Select the desired zoom factor with the cursor's **▲**/**▼** keys and press the **[ENTER]** key.

- NOTE**
- For 1P2W x 2 or 1P2W x 3 wirings, changes to the vertical axis zoom factor will affect all channels, even if individual channels use different clamp sensors or current ranges.
 - For 3P3W3M wirings, the phase voltage from the virtual neutral point is displayed as the voltage waveform, but the line-to-line voltage is displayed as the voltage (RMS).

5.11 Enlarging Measured Values on the Display

Press the  or **F1** [**SCREEN**] key to display the [**MEAS, ZOOM**] screen.

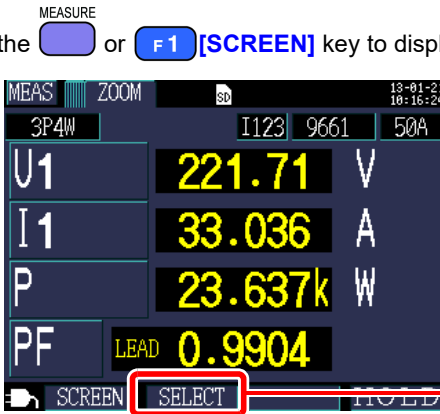

Selects the parameter to enlarge.

Changing display parameters

1 Press the **F2** [**SELECT**] key. The cursor will move to the display parameter field, and you will be able to change the setting.

2 Using the cursor keys, move to the parameter whose enlarged display you wish to change and press the  [**ENTER**] key. A dialog box for selecting the enlarged display will be displayed.

Display of selection position of the scrolling parameter



3 Select the desired parameter with the cursor keys and accept the new setting with the  [**ENTER**] key. Change other parameters similarly.

4 Press the **F2** [**SELECT**] key to cancel the setting process.

NOTE On the expanded display, you cannot select demand or harmonic parameters.

5.12 Viewing a Trend Graph

Press the **MEASURE** or **F1 [SCREEN]** key to display the **[MEAS, TREND]** screen.
 Switches the display parameter.

Maximum value during the save interval
 Average value during the save interval
 Minimum value during the save interval

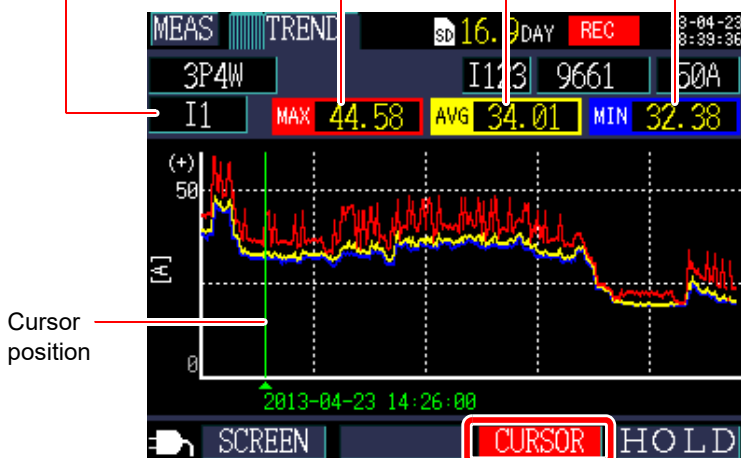

The cursor keys can be used to move the cursor. When the cursor is selected, time-series display updates stop.

Changing the vertical axis or horizontal axis (time axis) zoom factor

- 1 Press the **F2 [MAGNIFY]** key.
 The **[Axis Selection]** dialog box will be displayed.

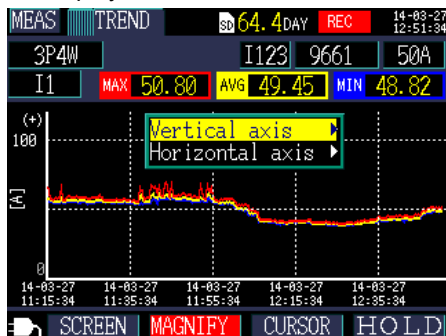

5.12 Viewing a Trend Graph

- 2** Select either [Vertical axis] or [Horizontal axis] with the cursor and press the **[ENTER]** key. The [Magnify Selection] dialog box will be displayed.

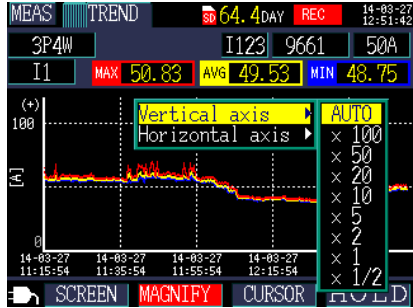

- 3** Select the desired zoom factor with the cursor keys and press the **[ENTER]** key. The other axis can be changed in the same manner.

- NOTE**
- You cannot select demand or harmonic parameters (other than THD) on the time-series display.
 - Data for up to 288 time intervals can be displayed on one screen. If this number is exceeded, older data will be discarded.
For example: Save interval time setting: 1 sec.
Amount of time that can be displayed on 1 screen: 4 minutes 48 seconds
Save interval time setting: 5 min.
Amount of time that can be displayed on 1 screen: 24 hours
 - Time-series data used for display purposes will be lost if the power goes out during recording since that data is not backed up. (However, this is not problematic since the same data will have been saved on the SD memory card or in the instrument's internal memory.) The time-series data will be updated when power is restored.
 - The Plus sign "+" of reactive power (Q) represents a LAG, whereas the minus sign "-" represents a LEAD.
 - When measured values exceed the display range, the background color is changed.

Starting and Stopping Recording and Measurement

Chapter 6

The method used to start and stop recording is set with the **[REC START]** and **[REC STOP]** settings on the **[SET 4/8, REC 2]** screen. Recording and measurement data is saved to the destination selected on the **[SET 3/8, REC 1]** screen.

See: 4.3, "Changing Recording (Save) Settings" (p. 75)

Recording start method

MANUAL

Starts recording when the  key is pressed.

TIME

Starts recording when the specified time is reached.

INTERVAL

Starts recording at an even division based on the save interval time.

REPEAT

Repeats recording while segmenting files every day. Recording is started on the repeat start date.

Recording stop method

MANUAL

Stops recording when the  key is pressed.

TIME

Stops recording when the specified time is reached.

TIMER

Recording is stopped automatically when the set timer time has elapsed.

REPEAT

Recording is repeated while segmenting files every day. Recording is stopped when the recording time period on the repeat stop date ends.



Recording LED

Blinking: Standby for recording
Lights up: Recording

6.1 Starting Recording

NOTE Do not remove the SD memory card while recording is in progress. If the SD memory card is removed during recording, measurement data will be saved in a new file (with a sequentially numbered suffix) when the card is reinserted.

Similarly, if the recording and measurement data file or harmonic data file exceeds 200 MB, all data files being recorded (recording and measurement, harmonic measurement, and waveform) will be segmented, and data will be saved to new files (each with a sequentially numbered suffix).

See: 8.2, "Folder and File Structure" (p. 120)

Starting Recording Manually

- 1 Set the recording start method on the [SET 4/8, REC 2] screen to [MANUAL].

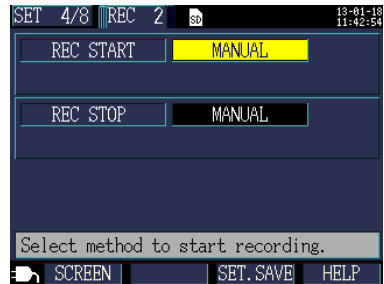

- 2 Press the **START/STOP** key on the **Measurement screen**.
Recording will start (and the Recording LED will light up).



The recording LED On

Starting Recording by Specifying a Time

- 1** Set the recording start method on the [SET 4/8, REC 2] screen to [TIME] and set the start time.

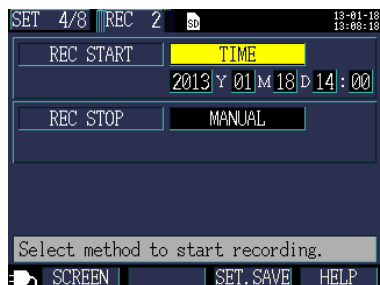

- 2** Press the  key on the Measurement screen. The instrument will enter the standby state.



The recording LED flashing

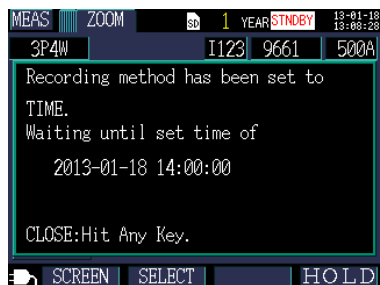

- 3** When the set start time is reached, recording will start (and the RECORDING LED will light up).

NOTE If the recording start time has already passed when the  key is pressed, the “interval time” starting method will be used.

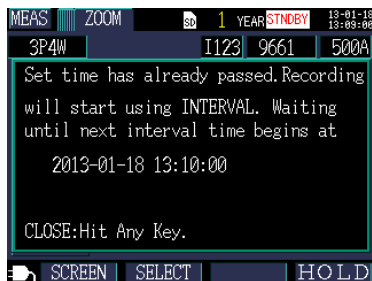

Starting Recording at a Good Time Division (Interval Time)

- 1** Set the recording start method on the [SET 4/8, REC 2] screen to [INTERVAL].

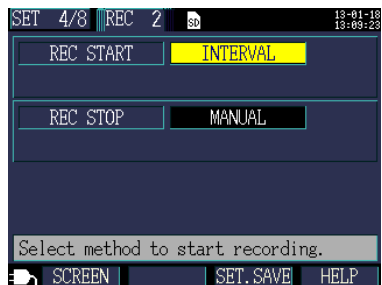

- 2** Press the  key on the Measurement screen.

The instrument will enter the standby state.



The recording LED flashing

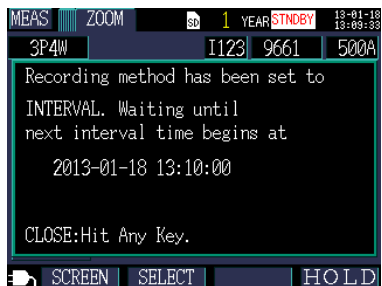

- 3** Recording will start automatically when a good time division is reached based on the save interval time.

Example

If the  key is pressed at 11:22:23 with the interval save time set to 5 minutes, the instrument will start recording at 11:25:00.

NOTE If the save interval is set to 30 seconds or less, recording will start from the next :00 seconds.

6.2 Stopping Recording

Stopping Recording Manually

- 1** Set the recording stop method on the [SET 4/8, REC 2] screen to [MANUAL].

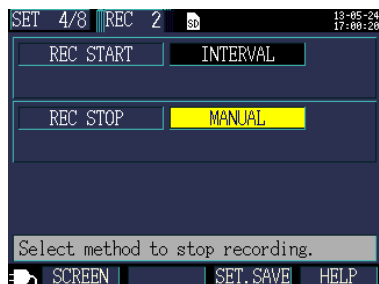

- 2** Press the  key on the Measurement screen. A confirmation dialog box will be displayed.

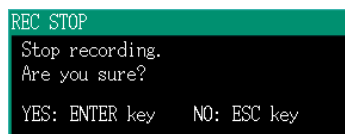

- 3** Press the  [ENTER] key to stop recording.

NOTE The maximum recording and measurement period is one year. Recording will stop automatically after one year.

Stopping Recording by Specifying a Time

Set the recording stop method on the [SET 4/8, REC 2] screen to [TIME] and set the stop time. Once recording has been started and the set recording stop time is reached, recording will stop automatically. To stop recording before the set stop time is reached, press

the  key, just as when stopping recording manually.

NOTE If the recording stop time has already passed when starting recording, the instrument will begin recording and continue until recording is stopped manually. To stop recording manually, press

the  key.

6.3 Using Repeat Recording

- 1** Set the recording start method on the [SET 4/8, REC 2] screen to [REPEAT] and set the start date.

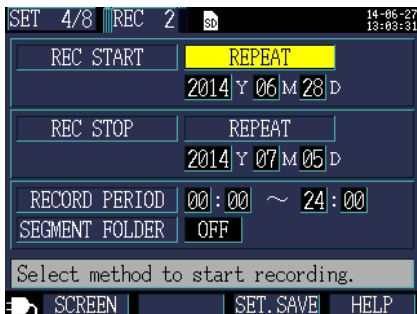

- 2** Set the stop date for the recording stop method.
When using repeat recording, the recording stop method cannot be changed.

- 3** Set the recording time period and folder segmenting method.

- 4** Press the **START/STOP** key on the Measurement screen.

The instrument will enter the standby state.



The recording LED flashing

- 5** Recording will be started at the recording time period start time on the repeat start date.





The recording LED On

NOTE If the  key is pressed after the starting time of the recording time period, the interval time starting method is employed.

6 Recording will be stopped automatically when the recording time period on the set repeat stop date ends.

To stop recording before the set stop time is reached, press the  key, just as when stopping recording manually.

NOTE To stop recording before the set stop time, press the  key, just as you would to stop recording manually.

If the stop date has already passed when the  key is

pressed, the operation is treated as a manual stop.
To stop recording manually, press the  key.

6.4 Operation When a Power Outage Occurs While Recording

If the supply of power to the instrument is cut off while recording is in progress, measurement operation will stop during the outage, but previously recorded measurement data and setting conditions will be backed up. When power returns, a new file will be created, and recording and measurement will continue. If the PW9002 Battery Set (Model 9459 Battery Pack) has been installed, the instrument will automatically switch to battery power in the event of a power outage and continue recording.

NOTE If the supply of power to the instrument is cut off while accessing the SD memory card, files on the card may be corrupted. Since the SD memory card is accessed frequently when recording with a short save interval time, file corruption is more likely if a power outage occurs during such use. It is recommended to avoid power outages by using the optional PW9002 Battery Set (9459 Battery Pack).

Quick Set

Chapter 7

QUICK SET



The Quick Set offers step-by-step guidance on the minimum necessary tasks that must be accomplished in order to perform recording and measurement in the following order: **[Basic Set]**→**[Connect]**→**[U Wiring]**→**[I Wiring]**→**[I Range]**→**[I Check]**→**[Rec Set]**→**[Start]**.

See: Measurement Guide (published separately in color)

When not using the Quick Set, configure all settings as desired.

See: "Measurement Flowchart" (p. 10)

See: Chapter 4, "Changing Settings" (p. 67)

7.1 Settings Configured with the Quick Set

The settings listed below can be configured with the Quick Set. To configure other settings, exit the Quick Set without starting recording after proceeding to **[Quick Set 8/8, Start]** and add the desired settings.

See: 7.2, "Settings That Can Be Added to Quick Set Settings" (p. 114)

- | | |
|---|---|
| <ul style="list-style-type: none"> • Wiring (1P2W/1P3W/3P3W2M/3P3W3M/3P4W) • Clamp sensor • Clock • Current range | <ul style="list-style-type: none"> • Save interval time • Save item • Recording start method • Recording stop method • File name |
|---|---|

7.2 Settings That Can Be Added to Quick Set Settings

Using the following procedure, normal settings can be applied in combination with the Quick Set to perform recording and measurement as desired:

- 1** Press the  key to start the Quick Set.

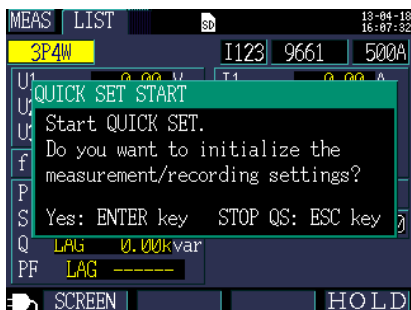

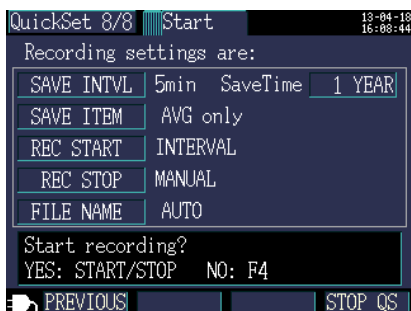

- 2** Following the instructions given by the Quick Set, proceed to the [\[Quick-Set 8/8, START\]](#) screen.

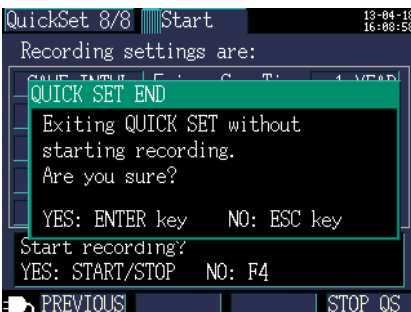

- 3** Without starting recording, press the  [STOP QS] key to exit the Quick Set.

The settings configured with the Quick Set up to this point will be saved.



- 4** Press the  key and configure the necessary settings on the Settings screen.

See: 4.2, "Changing Measurement Settings" (p. 69)

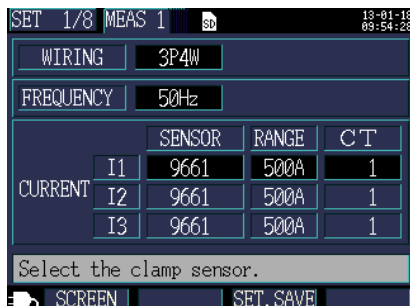

- 5** Reconfirm the wirings and measured values.

See: 3.9, "Verifying Correct Wiring (Wiring Check)" (p. 63)



See: Chapter 5, "Viewing Measurement Data" (p. 89)

U1	U2	U3	f	P	S	Q	PF	I1	I2	I3	WP+	ELAPSED
221.68 V	223.35 V	221.96 V	49.999 Hz	23.189 kW	23.190 kVA	LEAD 0.277 kvar	LEAD 0.9999	33.020 A	36.281 A	34.992 A	0.0000 kWh	0000:00:00

MEAS LIST I123 9661 50A

SCREEN HOLD

- 6** Press the  key on the Measurement screen to start recording.

Saving Data and Manipulating Files

Chapter 8



The PW3360 can save the following data on an SD memory card or in its internal memory.

File contents	Extension	Format	SD memory card	Internal memory
Recording and measurement data	CSV	CSV	Available	Available
Harmonic data (PW3360-21 only)	HRM	Binary	Available	Not available
Screen copy	BMP	BMP	Available	Not available
Waveform data	WUI	Binary	Available	Not available
Setting	SET	Text	Available	Available

The File screen allows you to perform operations such as loading settings data, deleting folders and files, and formatting the SD memory card or internal memory.

8.1 Viewing and Using the File Screen

SD memory card file screen

When you scroll the screen with the  /  cursor keys, the scroll bar indicates your current position.





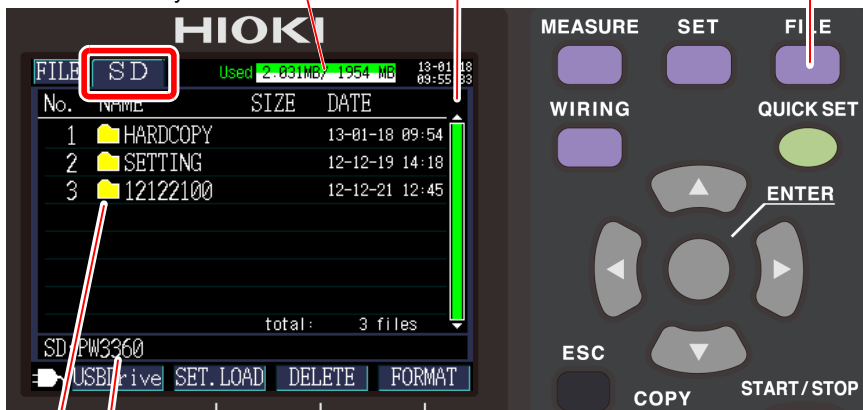

Displays the amount of space used on the SD memory card.





Displays the File screen (SD memory card/internal memory) and switches screens.



Displays the current display location. In this case, the screen is displaying the PW3360 folder on the SD memory card.



Displays a folder and file list. The list order reflects the order in the save area on the SD memory card.

 : Folder  /  or  : Move within the folder hierarchy (select folders and files).
 : File  /  : Move up and down.

Function keys		Reference
	USB Drive	9.2, "Copying Data to a Computer (USB)" (p. 138)
	SET.LOAD	8.5, "Loading Settings Files" (p. 128)
	DELETE	8.7, "Deleting Folders and Files" (p. 131)
	FORMAT	8.8, "Formatting the SD Memory Card or Internal Memory" (p. 132)

- NOTE**
- The File screen can display folder and file names of up to eight byte characters in length (or four double-byte characters). Longer names are truncated and displayed.
 Example: Filename: 1234567890
 Display on File screen: 123456~X (X: number)
 - Up to 204 folders and files can be displayed. Folders and files in excess of that number will not be shown.

Internal memory file screen

When you scroll the screen with the  /  cursor keys, the scroll bar indicates your current position.





Displays the amount of space used on the internal memory.

Displays the File screen (SD memory card/internal memory) and switches screens.



Displays a folder and file list.

The list order reflects the order in the save area on the internal memory.

Function keys		Reference
	COPY	8.6, "Copying Internal Memory Files to the SD Memory Card" (p. 130)
	SET.LOAD	8.5, "Loading Settings Files" (p. 128)
	DELETE	8.7, "Deleting Folders and Files" (p. 131)
	FORMAT	8.8, "Formatting the SD Memory Card or Internal Memory" (p. 132)

8.2 Folder and File Structure

This section describes the folder and file structure on the SD memory card and in the instrument's internal memory.

SD Memory Card

The PW3360 base folder is required in order for the instrument to save data on the SD memory card. If the PW3360 base folder does not exist on the SD memory card, it can be created as follows:

- 1 Insert the SD memory card.**
If the PW3360 base folder does not exist on the card, a dialog box asking whether you wish to create it will be displayed.

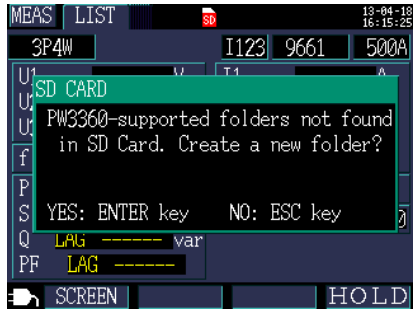

- 2 Accept with the  [ENTER] key.**

The PW3360 base folder (including screen copy and settings folders) will be created in the root folder on the SD memory card.

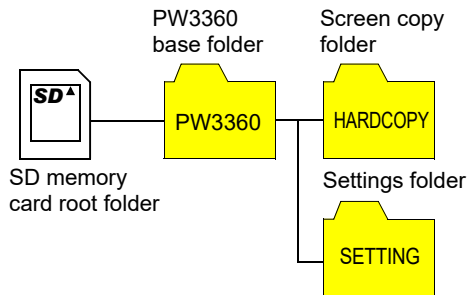

- NOTE**
- Even if you choose **[NO]** on the dialog box asking whether you wish to create the PW3360 base folder, the folder will be created the first time data is saved on the SD memory card.
 - The PW3360 base folder cannot be deleted using the instrument.

Folder and file structure

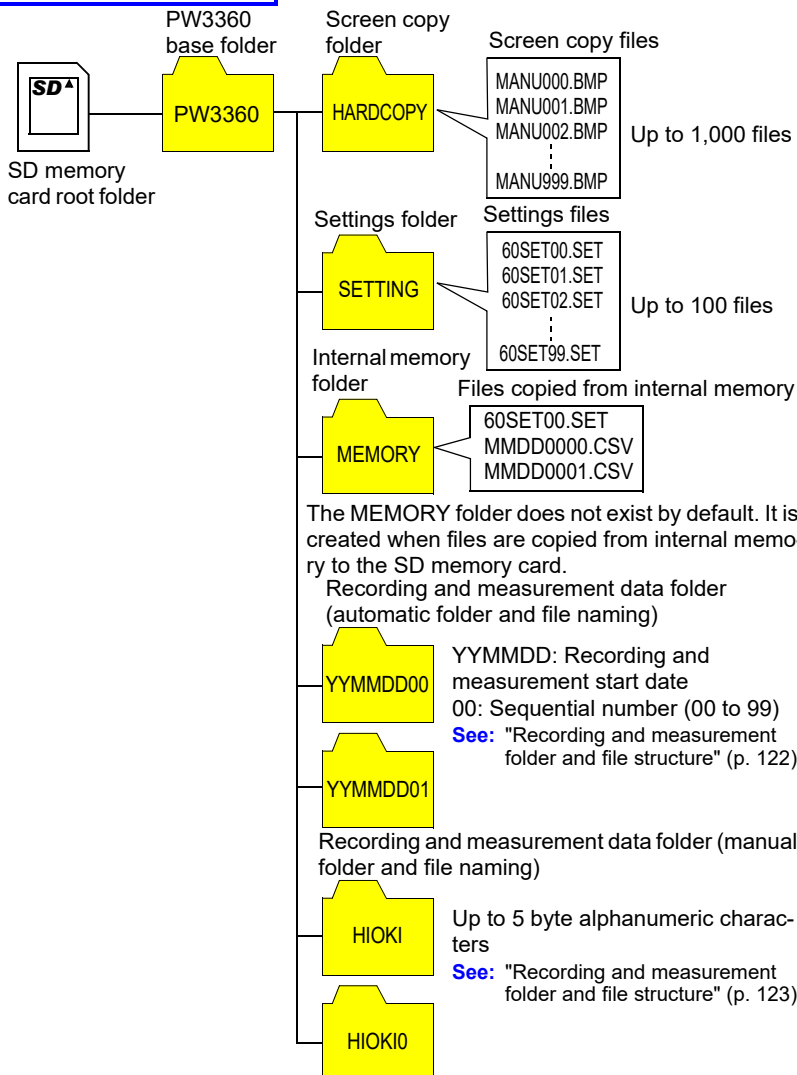

NOTE

- When a recording and measurement data file, harmonic data file (PW3360-21 only), or waveform data file exceeds 200 MB, all files will be segmented and new files added.
- Up to 203 folders can be created under the PW3360 base folder. If a folder is tried to be created above 203 folders, an error will be displayed.

**Recording and measurement folder and file structure
(automatic folder and file naming)**

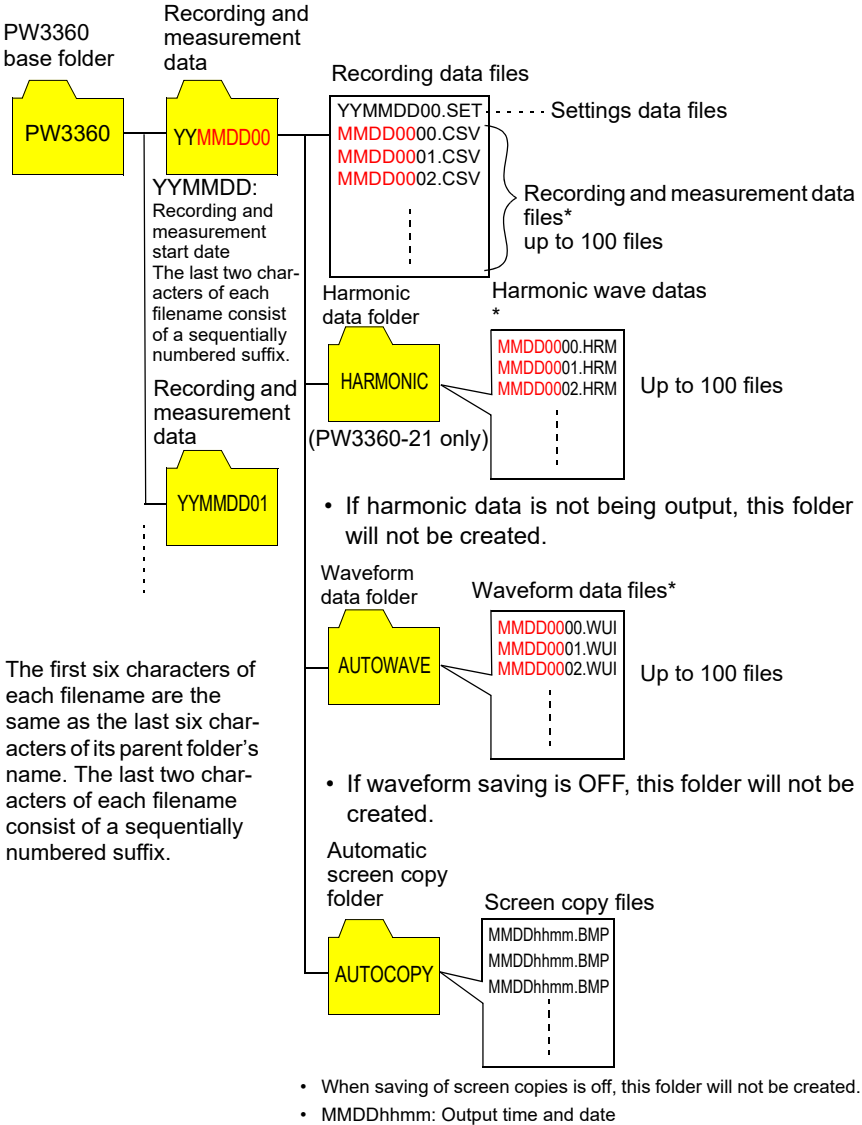

NOTE When a recording and measurement data file, harmonic data file (PW3360-21 only), or waveform data file exceeds 200 MB, all files will be segmented and new files added.

Recording and measurement folder and file structure (manual folder and file naming)

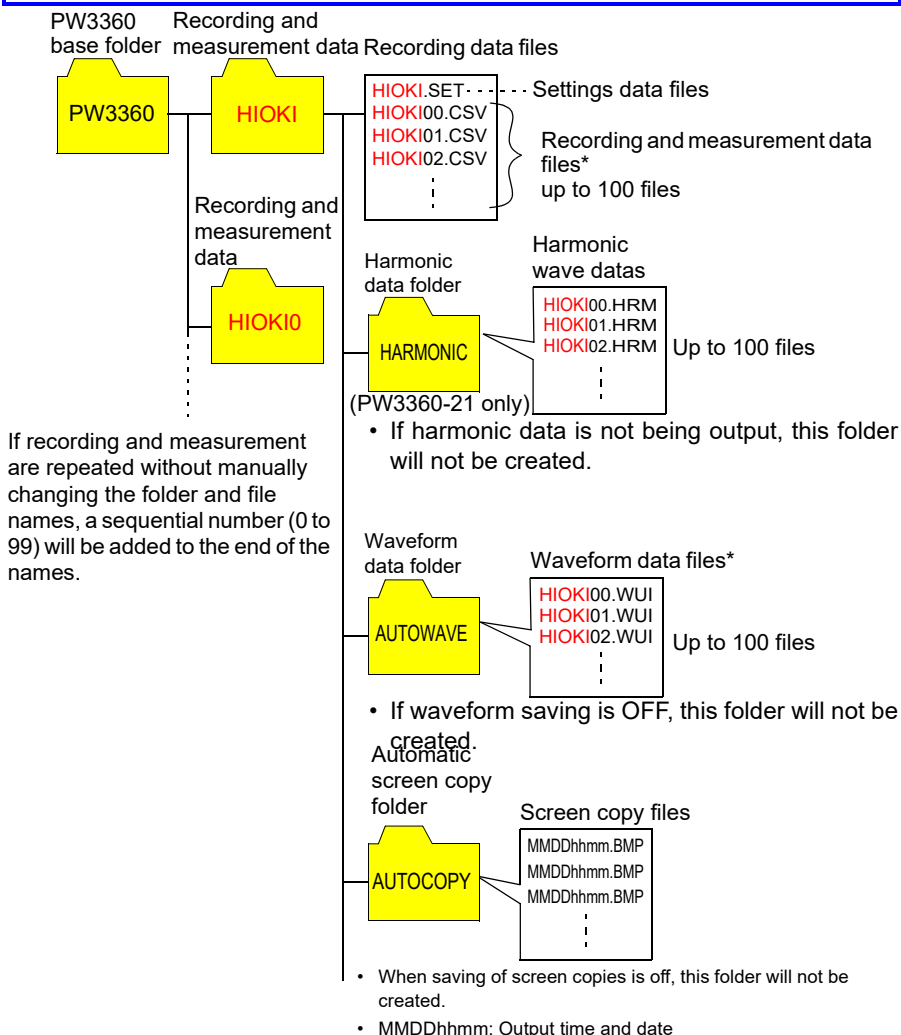

* Filenames

Recording and measurement data folder name (up to 5 characters from the name of the settings folder) + folder sequential number (0 to 99) + file sequential number (00 to 99)

NOTE When a recording and measurement data file, harmonic data file (PW3360-21 only), or waveform data file exceeds 200 MB, all files will be segmented and new files added.

8.2 Folder and File Structure

Available Recording Time

The following table shows a guideline of recording times for which an SD memory card can record data. The available recording time varies depending on setting conditions.

Interval time	Save Time	
	Saving of harmonic data: OFF	Saving of harmonic data: ON
1 seconds	15.9 days	24.7 hours
2 seconds	31.9 days	2.1 days
5 seconds	79.7 days	5.1 days
10 seconds	159 days	10.3 days
15 seconds	242 days	15.4 days

Interval time	Save Time	
	Saving of harmonic data: OFF	Saving of harmonic data: ON
30 s	1 year	30.8 days
1 minutes	1 year	61.7 days
2 minutes	1 year	123 days
5 minutes	1 year	308 days
More than 10 minutes	1 year	1 year

Save conditions for above figures

Measurement target: 3P3W2M

Storage media: Z4001 SD card 2 GB

Saved parameters: ALL data (Saves all data: average, maximum, and minimum values)

Screen copy saving: OFF

Waveform save: OFF

The maximum recording time based on the settings can be confirmed right on the Settings screen.

See: 4.3, "Changing Recording (Save) Settings" (p. 75)

Internal Memory

Only settings files and recording and measurement data files can be saved in the instrument's internal memory. Since harmonic data (PW3360-21 only), screen copies, and waveform data cannot be saved in internal memory, they must be saved on the SD memory card.

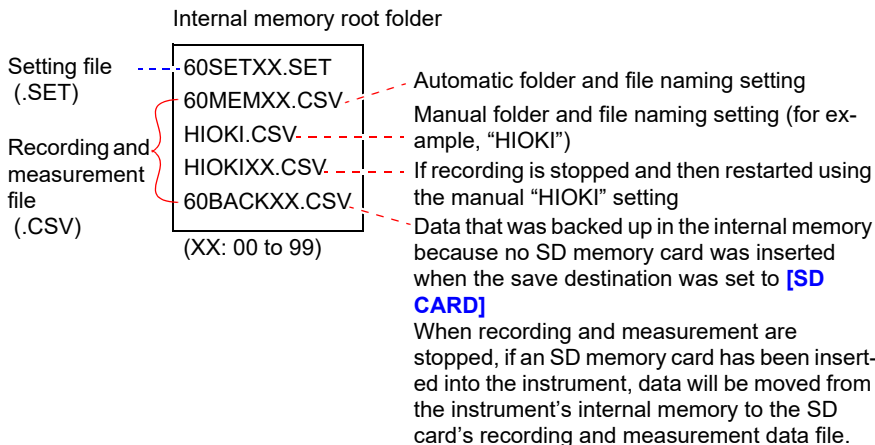

8.3 Saving Copies of the Screen (SD Memory Card Only)

The screen currently being displayed can be saved in BMP file format on the SD memory card.

NOTE Even if the save destination (p. 75) is set to **[Internal M]**, screen copies are saved on the SD memory card. If no SD memory card has been inserted, screen copies cannot be saved.

1 Verify that an SD memory card has been inserted into the instrument.



2 Display the screen you wish to save and press the **COPY** key.

You can save a hold screen by pressing the **F4** **[HOLD]** key.

The screen will be saved in the **[PW3360]-[HARDCOPY]** folder in the SD memory card's root folder (at the top of the card's folder hierarchy).

See: 8.2, "Folder and File Structure" (p. 120)

8.4 Saving Settings Files

By saving the current settings state and then later loading the corresponding settings data, you can restore the instrument to its state at the time the settings were saved.

1 Set the settings file save destination.

Set the save destination on the [SET 3/ 8, REC 1] screen to either SD memory card or internal memory.

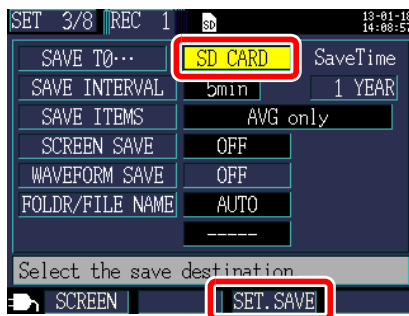

2 Press the **F3** [SET.SAVE] key on the Settings screen.

Save destination	Settings file save location
SD memory card	Files are saved in the [PW3360]- [SETTINGS] folder in the SD memory card's root folder (at the top of the card's folder hierarchy). See: 8.2, "Folder and File Structure" (p. 120)
Internal memory	Files are saved in the root folder (at the top of the internal memory's folder hierarchy). See: "Internal Memory" (p. 129)

- NOTE**
- Up to 100 settings files can be saved.
 - Files are named automatically. 60SETXX.SET (XX:00 to 99)

8.5 Loading Settings Files

This section describes how to load a settings file that was previously saved on the SD memory card or in the instrument's internal memory.

NOTE LAN settings are not loaded.

SD Memory Card

- 1** Press the **FILE** key to display the **[FILE, SD]** screen.



- 2** Select the settings file (with the **.SET** extension) to load.

/ or : Move within the folder hierarchy.

/ : Move up and down.
(Select folders and files)

Settings files saved using the functionality provided by the instrument for saving settings can be found in the **[PW3360] -[SETTING]** folder.



- 3** Press the **F2** **[SET.LOAD]** key.

- 4** When the confirmation dialog box is displayed, press the **[YES]** key.

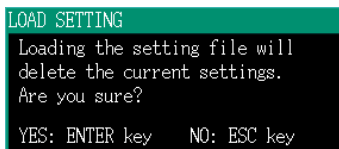



Internal Memory

- 1** Press the  key to display the [FILE, Memory] screen.



- 2** Select the settings file (with the .SET extension) to load.

 /  : Move up and down (select a file).

- 3** Press the  [SET_LOAD] key.

- 4** When the confirmation dialog box is displayed, press the [YES] key.

```
LOAD SETTING
Loading the setting file will
delete the current settings.
Are you sure?
YES: ENTER key    NO: ESC key
```

8.6 Copying Internal Memory Files to the SD Memory Card

This section describes how to copy internal memory files to the SD memory card.

- 1** Press the  key to display the **[FILE, Memory]** screen.

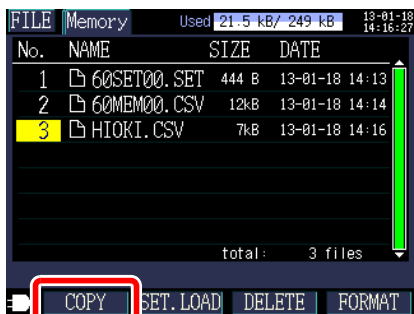

- 2** Select the file to copy to the SD memory card.

- 3** Press the  **[COPY]** key.

- 4** When the confirmation dialog box is displayed, press the

 **[ENTER]** key.

The file will be saved in the **[PW3360] - [MEMORY]** folder in the SD memory card's root folder (at the top of the card's folder hierarchy).

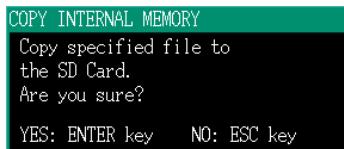

8.7 Deleting Folders and Files

This section describes how to delete folders and files stored on the SD memory card or in the instrument's internal memory.

- 1 Press the **FILE** key to display the **[FILE, SD]** or **[FILE, Memory]** screen.



- 2 Select the folder or file to delete.

◀/▶ or ○ : Move within the folder hierarchy. (SD memory card only)
 ▲/▼ : Move up and down. (Select folders and files)

- 3 Press the **F3 [DELETE]** key. A confirmation dialog box will be displayed.

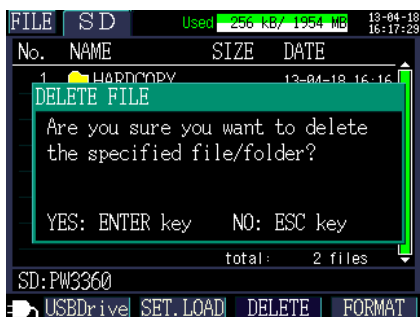

- 4 Accept with the **○ [ENTER]** key.

NOTE The **[PW3360]** folder cannot be deleted.

8.8 Formatting the SD Memory Card or Internal Memory

This section describes how to format an SD memory card or the instrument's internal memory.

- 1** Press the  key to display the **[FILE, SD]** screen or the **[FILE, Memory]** screen.

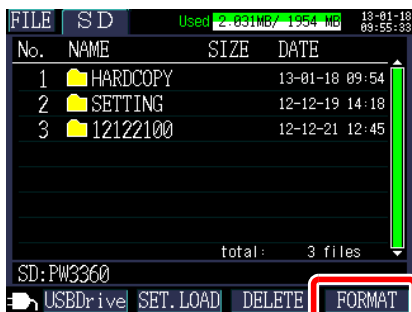

- 2** Press the  **[FORMAT]** key. A confirmation dialog box will be displayed.

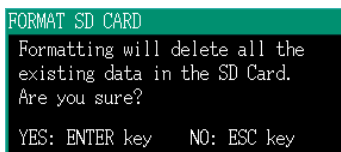

- 3** Accept with the  **[ENTER]** key.

When formatting of an SD memory card completes, the PW3360 basic folder (which is used to store screen copy folder **[HARDCOPY]** and settings folder **[SETTING]**) will be automatically created in the root folder of the card. The card usage and date indications are also updated.

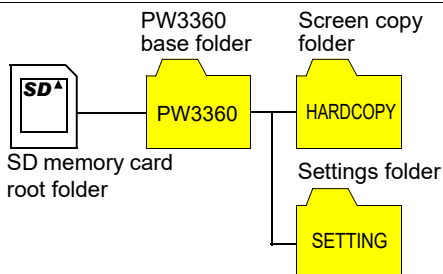

8.8 Formatting the SD Memory Card or Internal Memory

- NOTE**
- Formatting will cause all saved data to be erased, and it cannot be undone. Check the contents of the card or memory before formatting. It is recommended to back up important data on SD memory cards and in the instrument's internal memory.
 - Use the instrument to format SD memory cards. Formatting a card with a computer may prevent the media from being initialized with the dedicated SD format, causing decreased performance in the form of slower read and write speeds.
 - The instrument can only save data to SD memory cards that have been initialized with the dedicated SD format.

Analyzing Data on a Computer

Chapter 9

This section describes how to load data recorded with the instrument onto a computer and analyze it using the optional SF1001 Power Logger Viewer application. Recording and measurement data can also be checked by loading it into the graphic s software such as Excel®.

See: SF1001 Power Logger Viewer Instruction Manual



To access data, either load it from the SD memory card on which it was saved using a computer with an SD memory card reader, or use a USB cable to copy data from the SD memory card or internal memory to the computer.

File content	Extension	Format	Supported application software	
			Model SF1001	GENNECT One
Recording and measurement data	CSV	CSV	Available	Available
Harmonic data (PW3360-21 only)	HRM	Binary	Available	Available
Waveform data	WUI	Binary	Available	Not Available
Screen copy	BMP	BMP	Not Available	Not Available
Setting	SET	Text	Not Available	Not Available

When loading data into the GENNECT One, see "GENNECT One User's Manual (PDF)," which can be displayed by choosing Help in GENNECT One's information menu.

For the installation procedure of GENNECT One, see "Installation" (p. 169).

9.1 Copying Data to a Computer (SD)

This section describes how to eject the SD memory card from the instrument and copy data from the card to a computer. If the computer does not have an SD memory card slot, please purchase an SD memory card reader.

Windows 7

1 Verify that recording and measurement have stopped.

Removing a card while data is being written to it may damage the card.



2 Eject the SD memory card from the instrument.

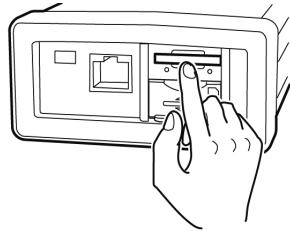

3 Insert the SD memory card into the SD memory card slot on the computer.

4 Click the [Start]-[Computer].

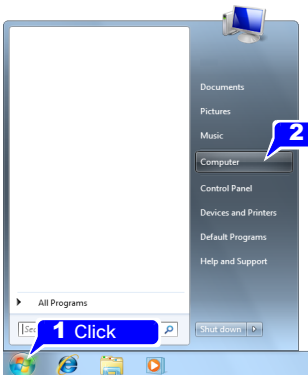

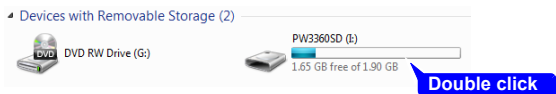
5 Double click the [PW3360SD].**NOTE**

If the SD card was not formatted with instrument, [Removable Disk] will be displayed.

6 Copy the necessary folders or files to the specified folder on the computer.

9.2 Copying Data to a Computer (USB)

This section describes how to copy data from an SD memory card or the instrument's internal memory to a computer by connecting the instrument and computer with the included USB cable.

When connecting the instrument with USB, there is no need to configure any instrument settings.

CAUTION To avoid malfunctions, do not connect or disconnect the USB cable while the instrument is operating.

- NOTE**
- If the instrument and computer are both off and connected with the USB cable, turn on the computer and then the instrument. Powering up the devices in a different order may prevent the instrument and computer from communicating.
 - Copying large data files from the SD memory card to a computer via the instrument's USB interface can be time-consuming. When you need to copy a large data file to a computer, it is recommended to use an SD memory card reader.

1 Turn on the computer.

2 Turn on the instrument.

3 Connect the instrument and computer with the included USB cable.

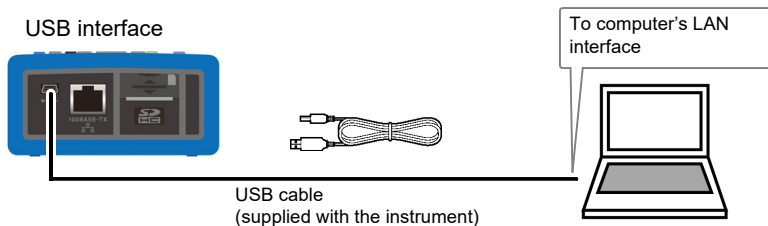

4 Press the  key to display the File screen.

5 Press the **F1** [USB Drive] key on the [FILE, SD] screen.

If the instrument is connected to the computer, the following message will be displayed on the instrument:

Connecting to mass storage.
To cancel, hit ESC.
Cancel: ESC

The computer will recognize the SD memory card and internal memory as removable disks.

• Devices with Removable Storage (3)



Internal memory

SD memory card

If the SD memory card was formatted with the PW3360, "PW3360SD" will have been written to the volume label, and that label will be displayed. If the SD memory card was not formatted with the PW3360, [Removable Disk] (or the previously written volume label) will be displayed.

6 Copy the necessary folders or files to the specified folder on the computer.

NOTE

- To establish the mass storage connection, an SD memory card is required to be inserted.
- Data on the instrument's SD memory card or internal memory cannot be manipulated (to delete files, change filenames, etc.) from the computer.

Disconnecting the cable from the computer

Use the following procedure to disconnect a USB cable that is connected to the instrument from a running computer:

1 Press the **ESC** key to terminate the USB connection.

Alternately, eject the disks by using the [Safely Remove Hardware and Eject Media] icon on the computer.

2 Disconnect the USB cable from the computer.

NOTE

To reconnect the instrument to a computer (as a mass-storage device) after pressing the **ESC** key to terminate the USB connection, disconnect the USB cable, restart the instrument, and then reestablish the connection.

9.3 SF1001 Power Logger Viewer (Optional)

The SF1001 Power Logger Viewer is a software application that runs on a computer to analyze data recorded with the instrument. The SF1001 can load measurement data recorded with the instrument. However, note that it may lose the ability to load files if they are opened with another application or overwritten, causing the format to change.

The SF1001 provides the following capabilities (Refer to the instruction manual of SF1001 for more information):

◆ Displaying a time-series graph (2-axis display)

Select parameters and display a time-series graph. You can also display harmonic data.

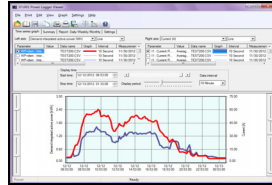

◆ Displaying a ledger-style list

Select parameters and display a time-series data.

◆ Harmonic display (when harmonic data was saved with the PW3360-21)

Displays a harmonic list and harmonic graph for the specified time.

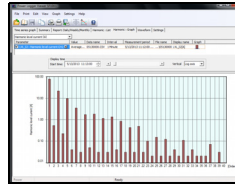

◆ Waveform display (when waveform data was saved)

Displays waveforms.

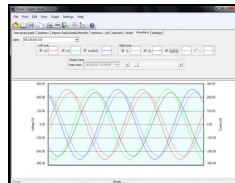

◆ Displaying settings

You can load settings data contained in measurement data and review the setting conditions that were used at the time of measurement.

◆ Printing reports

You can print user-specified measurement data as reports.

The screenshot shows a data report table with columns for Date, Time, and various measurement parameters. The data is organized in a grid format, typical of a report printout.

◆ Converting measurement data into CSV-format files

Parameters displayed on the Time-series Graph screen, Summary screen, Daily/Weekly/Monthly Report screen, and Waveform screen as well as data for the displayed time period can be saved as a CSV-format file. Harmonic graph screen, Harmonic list screen, and Settings screen content cannot be saved.

You can also load harmonic data that was saved in the binary format into a spreadsheet application by converting it to the CSV format.

The screenshot shows a spreadsheet application with columns for Date, Time, and various harmonic data points. The data is organized in a grid format, typical of a CSV file export.

Saving Data as an Excel® File

When you open measurement data in Excel® and overwrite the original file by saving it as a CSV-format file, the file format will change. When you open a measurement (CSV-format) file, save it as an Excel® file (.xls).

1 Click **[file]-[Save As]** on the menu bar.

2 Specify the save destination.
The file can be saved anywhere you wish.

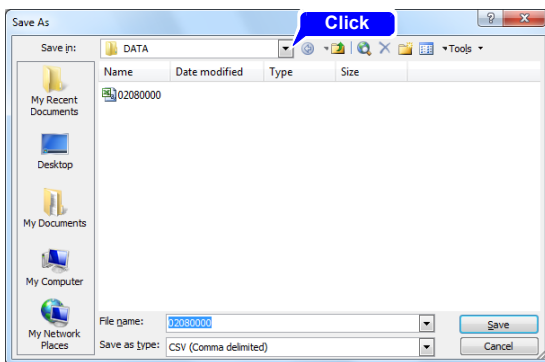

3 Select **[Microsoft Office Excel Workbook]** under **[Save as type]**.

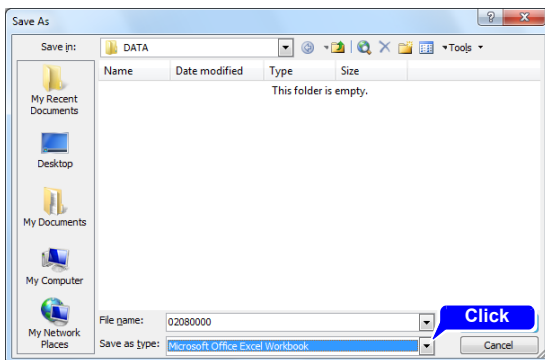

4 Change the filename as necessary and click **[Save]**.

Example of Data from a Measurement File

An example of data from a measurement file is shown below:

1	HIOKI PW3360(Ver1.80)	S/N.121101529								
2	FOLDER	13051301								
3	WIRING	3P4W								
4	OPERATION	RMS								
5	FREQUENCY	50Hz								
6	THD	THD-F								
7	INTERVAL	1min								
8	U RANGE	600V								
9	I RANGE	500A								
10	SENSOR	9661(500A)								
11	VT(PT)		1							
12	CT		1							
13	PULSE		1							
14	ENERGY COST		0							
15										
16	5/13/2013 10:48	START	----- Recording start time							
17	Date	Time	Status	Freq_Avg[Hz]	U1_Avg[V]	Ufnd1_Avg[V]	Udeg1_Avg[deg]	U2_Avg[V]	Ufnd2_Avg[V]	Udeg2_Avg[deg]
18	5/13/2013 10:48									
19	5/13/2013 10:49	0:01:00	0	5.00E+01	2.20E+02	2.20E+02	0.00E+00	2.21E+02	2.21E+02	-1.20E+02
20	5/13/2013 10:50	0:02:00	0	5.00E+01	2.20E+02	2.20E+02	0.00E+00	2.21E+02	2.21E+02	-1.20E+02
21	5/13/2013 10:51	0:03:00	0	5.00E+01	2.20E+02	2.20E+02	0.00E+00	2.21E+02	2.21E+02	-1.20E+02
22	5/13/2013 10:52	0:04:00	0	5.00E+01	2.20E+02	2.20E+02	0.00E+00	2.21E+02	2.21E+02	-1.20E+02
23	5/13/2013 10:53	0:05:00	0	5.00E+01	2.20E+02	2.20E+02	0.00E+00	2.21E+02	2.21E+02	-1.20E+02

Instrument information

Measurement information

Measurement data

Measurement File Contents

Instrument information

Parameter	Parameter name	Format	Description
HIOKI PW3360 (VerX.XX)	Instrument information (Version number)	S/N.123456789	PW3360 serial number
FOLDER	Folder name	Automatic: YYMMDDXX User-specified: ABCDE (5 characters)	Folder name
WIRING	Wiring	1P2W/1P2Wx2/1P2Wx3/ 1P3W/1P3W1U/1P3W+I/ 1P3W1U+I/3P3W2M/ 3P3W2M+I/ 3P3W3M/3P4W/ I/Ix2/Ix3	Wiring settings I: Current only
OPERATION	PF/Q/S calculation selection	RMS/FND	Power factor PF / reactive power Q / apparent power S calculation selection RMS: RMS calculation FND: Fundamental wave calculation
FREQUENCY	Frequency	50Hz/60Hz	Frequency setting

9.4 Checking Recording and Measurement Data with Excel®

Parameter	Parameter name	Format	Description
THD (PW3360-21 only)	THD (Total harmonic distortion) Calculation selection	THD-F/ THD-R	Calculation selection of the total harmonic distortion See: "Appendix4 Terminology" (p. A6)
INTERVAL	Save interval time	1sec/2sec/5sec/10sec/ 15sec/30sec/1min/2min/ 5min/10min/15min/ 20min/30min/60min	Save interval time
U RANGE	Voltage range	600V	Voltage range setting Fixed at 600 V.
I RANGE	Current range	5A/10A/50A/100A/500A (when the 9661 sensor is selected)	Current range setting Varies with clamp sensor type. If there are multiple circuits, the current range for each is included.
SENSOR	Clamp sensor	9660(100A)/9661(500A)/ 9694(5A)/9669(1000A)/9695- 02(50A)/ 9695-03(100A)/ CT9667(500A)/ CT9667(5000A)/ 9657-10(10A)/9675(10A)	Clamp sensor setting If there are multiple circuits, the clamp sensor for each is included.
VT(PT)	VT (PT) ratio	User-specified: 0000.01 to 9999.99 Selected: 1/60/100/200/300/600/ 700/1000/2000/2500/ 5000	VT (PT) ratio setting
CT	CT ratio	User-specified: 0000.01 to 9999.99 Selected: 1/40/60/80/120/ 160/200/240/300/400/600/ 800/1200	CT ratio setting If there are multiple circuits, the ratio for each is included.
PULSE	Pulse input scaling	0.001 to 100.000	Pulse input scaling setting
	Pulse input aux unit	p/n/u/m/none(space)/k/M/G/T	Pulse input aux unit setting
	Pulse input unit	User-specified: ABCDE (5 characters)	Pulse input unit setting
ENERGY COST	Energy unit cost	0.00000 to 99999.9	Energy unit cost setting (/kWh)
	Energy cost currency	User-specified: ABC (3 characters)	Energy cost currency setting

Measurement information

Parameter	Parameter name	Format	Description
Date	Output time and date	YYYY-MM-DD hh:mm:ss	Output time and date
Etime	Elapsed time	hhhh:mm:ss	Elapsed time from start of recording
Status	Measurement Information	HGFEDCBA (A to H: 0 or 1)	A : U1 (voltage CH1) peak exceeded B : U2 (voltage CH2) peak exceeded C : U3 (voltage CH3) peak exceeded D : I1 (current CH1) peak exceeded E : I2 (current CH2) peak exceeded F : I3 (current CH3) peak exceeded G : Frequency error H : Power outage during interval time Example: If data includes I1 (current CH1) data in excess of peak: 00001000

Measurement data header

Parameter	Parameter name	Description
Freq_xxx[Hz]	Frequency	
U1_xxx[V]	Voltage RMS U1(CH1)	See: 5.4, "Viewing Voltage and Current Value Details" (p. 93)
U2_xxx[V]	U2(CH2)	
U3_xxx[V]	U3(CH3)	
U12_xxx[V]	U12(CH12) For 3P3W2M wirings, value for third channel as calculated from U1 and U2	
Ufnd1_xxx[V]	Voltage fundamental waveform value U1(CH1)	See: 5.4, "Viewing Voltage and Current Value Details" (p. 93)
Ufnd2_xxx[V]	U2(CH2)	
Ufnd3_xxx[V]	U3(CH3)	
Ufnd12_xxx[V]	U12(CH12) For 3P3W2M wirings, value for third channel as calculated from U1 and U2	
Upeak1_xxx[V]	Peak value of the voltage waveform (Absolute value) U1(CH1)	See: 5.4, "Viewing Voltage and Current Value Details" (p. 93)
Upeak2_xxx[V]	U2(CH2)	
Upeak3_xxx[V]	U3(CH3)	
Upeak12_xxx[V]	U12(CH12) For 3P3W2M connections, value for third channel as calculated from U1 and U2	
Udeg1_xxx[deg]	Voltage fundamental phase angle U1(CH1)	See: 5.4, "Viewing Voltage and Current Value Details" (p. 93)
Udeg2_xxx[deg]	U2(CH2)	
Udeg3_xxx[deg]	U3(CH3)	
Udeg12_xxx[deg]	U12(CH12) For 3P3W2M connections, value for third channel as calculated from U1 and U2	

9.4 Checking Recording and Measurement Data with Excel®

Parameter	Parameter name	Description
I1_xxx[A]	Current RMS I1(CH1)	See: 5.4, "Viewing Voltage and Current Value Details" (p. 93)
I2_xxx[A]	I2(CH2)	
I3_xxx[A]	I3(CH3)	
I12_xxx[A]	I12(CH12) For 3P3W2M wirings, value for third channel as calculated from I1 and I2	
Ifund1_xxx[A]	Current fundamental wave value I1(CH1)	See: 5.4, "Viewing Voltage and Current Value Details" (p. 93)
Ifund2_xxx[A]	I2(CH2)	
Ifund3_xxx[A]	I3(CH3)	
Ifund12_xxx[A]	I12(CH12) For 3P3W2M wirings, value for third channel as calculated from I1 and I2	
Ipeak1_xxx[A]	Peak value of the current waveform (Absolute value) I1(CH1)	See: 5.4, "Viewing Voltage and Current Value Details" (p. 93)
Ipeak2_xxx[A]	I2(CH2)	
Ipeak3_xxx[A]	I3(CH3)	
Ipeak12_xxx[A]	I12(CH12) For 3P3W2M connections, value for third channel as calculated from I1 and I2	
Ideg1_xxx[deg]	Current fundamental phase angle I1(CH1)	See: 5.4, "Viewing Voltage and Current Value Details" (p. 93)
Ideg2_xxx[deg]	I2(CH2)	
Ideg3_xxx[deg]	I3(CH3)	
Ideg12_xxx[deg]	I12(CH12) For 3P3W2M connections, value for third channel as calculated from I1 and I2	
P1_xxx[W]	Active power P1(CH1)	
P2_xxx[W]	P2(CH2)	
P3_xxx[W]	P3(CH3)	
P_xxx[W]	P(total)	
S1_xxx[VA]	Apparent power S1(CH1)	
S2_xxx[VA]	S2(CH2)	
S3_xxx[VA]	S3(CH3)	
S_xxx[VA]	S(total)	

9.4 Checking Recording and Measurement Data with Excel®

Parameter	Parameter name	Description
Q1_xxx[var]	Reactive power Q1(CH1)	<p>See: "PF/Q/S calculation" (p. 72) "Appendix4 Terminology" (p. A6)</p>
Q2_xxx[var]	Q2(CH2)	
Q3_xxx[var]	Q3(CH3)	
Q_xxx[var]	Q(total)	
PF1_xxx	Power factor PF1(CH1)	
PF2_xxx	PF2(CH2)	
PF3_xxx	PF3(CH3)	
PF_xxx	PF(total)	
DPF1_xxx	Displacement power factor DPF1(CH1)	
DPF2_xxx	DPF2(CH2)	
DPF3_xxx	DPF3(CH3)	<p>Active energy from start of recording (Consumption)</p> <p>Active energy from start of recording (Regeneration)</p> <p>Reactive energy from start of recording (Lag)</p> <p>Reactive energy from start of recording (Lead)</p> <p>Active energy (Consumption) for each interval time</p>
DPF_xxx	DPF(total)	
WP+[Wh]	Active energy (Consumption)	
WP+1[Wh] to WP+3[Wh]	Active energy (Consumption), first circuit to third circuit Active energy (Consumption) for each of three 1P2W circuits	
WP-[Wh]	Active energy (Regeneration)	
WP-1[Wh] to WP-3[Wh]	Active energy (Regeneration), first circuit to third circuit Active energy (Regeneration) for each of three 1P2W circuits	
WQLAG[varh]	Reactive energy (Lag)	
WQLAG1[varh] to WQLAG3[varh]	Reactive energy (Lag) , first circuit to third circuit Reactive energy (Lag) for each of three 1P2W circuits	
WQLEAD[varh]	Reactive energy (Lead)	
WQLEAD1[varh] to WQLEAD3[varh]	Reactive energy (Lead), first circuit to third circuit Reactive energy (Lead) for each of three 1P2W circuits	
WP+dem[Wh]	Active power demand quantity (Consumption)	<p>Active energy (Consumption) for each interval time</p>
WP+dem1[Wh] to WP+dem3[Wh]	Active power demand quantity (Consumption), first circuit to third circuit Active power demand quantity (Consumption) for each of three 1P2W circuits	

9.4 Checking Recording and Measurement Data with Excel®

Parameter	Parameter name	Description
WP-dem[Wh]	Active power demand quantity (Regeneration)	Active energy (Regeneration) for each interval time
WP-dem1[Wh] to WP-dem3[Wh]	Active power demand quantity (Regeneration), first circuit to third circuit Active power demand quantity (Regeneration) for each of three 1P2W circuits	
WQLAGdem[varh]	Reactive power demand quantity (Lag)	Reactive energy (Lag) for each interval time
WQLAGdem1[varh] to WQLAGdem3[varh]	Reactive power demand quantity (Lag), first circuit to third circuit Reactive power demand quantity (Lag) for each of three 1P2W circuits	
WQLEADdem[varh]	Reactive power demand quantity (Lead)	Reactive energy (Lead) for each interval time
WQLEADdem1[varh] to WQLEADdem3[varh]	Reactive power demand quantity (Lead), first circuit to third circuit Active power demand quantity for each of three 1P2W circuits	
Pdem+[W]	Active power demand value (Consumption)	Average value of active power (Consumption) for each interval time
Pdem+1[W] to Pdem+3[W]	Active power demand value (Consumption), first circuit to third circuit Active power demand value (Consumption) for each of three 1P2W circuits	
Pdem-[W]	Active power demand value (Regeneration)	Average value of active power (Regeneration) for each time interval
Pdem-1[W] to Pdem-3[W]	Active power demand value (Regeneration), first circuit to third circuit Active power demand value (Regeneration) for each of three 1P2W circuits	
QdemLAG[var]	Reactive power demand value (Lag)	Average value of reactive power (Lag) for each time interval
QdemLAG1[var] to QdemLAG3[var]	Reactive power demand value (Lag), first circuit to third circuit Reactive power demand value (Lag) for each of three 1P2W circuits	
QdemLEAD[var]	Reactive power demand value (Lead)	Average value of reactive power (Lead) for each time interval
QdemLEAD1[var] to QdemLEAD3[var]	Reactive power demand value (Lead), first circuit to third circuit Reactive power demand value (Lead) for each of three 1P2W circuits	

9.4 Checking Recording and Measurement Data with Excel®

Parameter	Parameter name	Description
PFdem	Power factor demand value	The average value of the power factor for each time interval $\frac{P_{dem} + \sqrt{(P_{dem} +)^2 + (Q_{demLAG})^2}}{2}$
PFdem1 to PFdem3	Power factor demand value, first circuit to third circuit Power factor demand value for each of three 1P2W circuits	
Pulse	Pulse input value	Pulse input count value for each interval time x scaling setting value (including sub-units)

- NOTE**
- For average value data, [Avg] is shown as [xxx].
 - For maximum value data, [Max] is shown as [xxx].
 - For minimum value data, [Min] is shown as [xxx].
 - Units are shown in brackets after the parameter name.
 - Average values are not available for voltage and current peak values.
 - For current-only wirings, no average value is available for the current fundamental wave phase angle.

Measurement data

Data	Data format	Description
Normal data	12.345E+00	Outputs exponential data.
Invalid data	0.0000E+99	If the display reads [----] and measurement is not possible, outputs invalid data. Example: With no input, it is not possible to measure the power factor (resulting in invalid data).

Converting Measured Value Exponential Data

Measured values are displayed exponentially so that the instrument can accommodate values of varying lengths. To make it easier to view data in Excel®, exponential data can be converted into numerical data.

1 Select the column labels you wish to convert into numerical data and right-click with the mouse.

2 Select **[Format Cells]**.

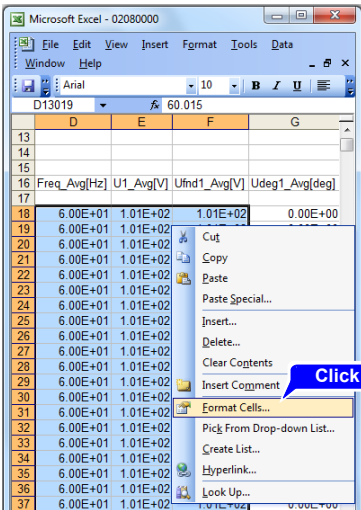

Example

The figure shows column D, E, and F are selected (Microsoft Office Excel® 2003)

3 On the **[Format Cells]** dialog box, click the **[Number]** tab.

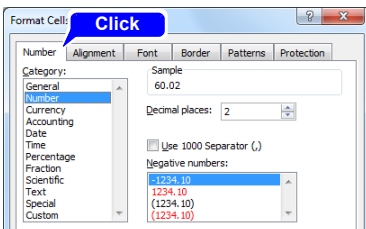

4 Select **[Number]**.

5 Change the number of decimal places as necessary and click **[OK]**.

Using Communications (LAN) Chapter 10

10.1 LAN Communications

Using a LAN connection, you can operate the PW3360 remotely using an Internet browser.

You must configure the instrument's LAN settings, create a network, and connect the instrument and a computer with a LAN cable. The instrument provides functionality for automatically detecting whether a straight or cross cable is being used.

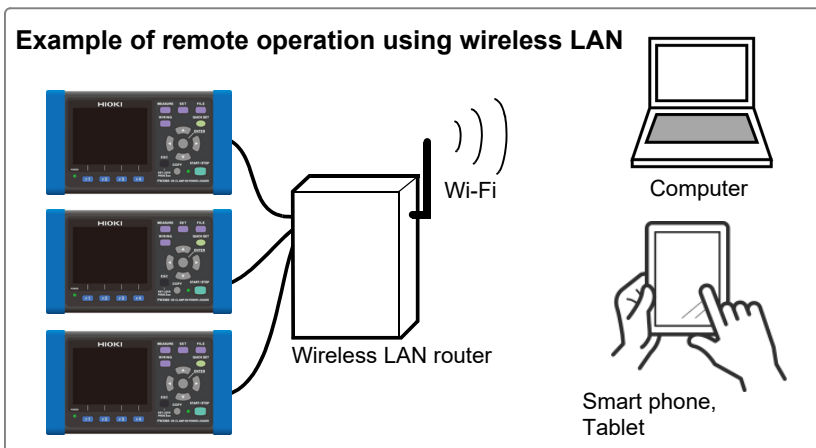
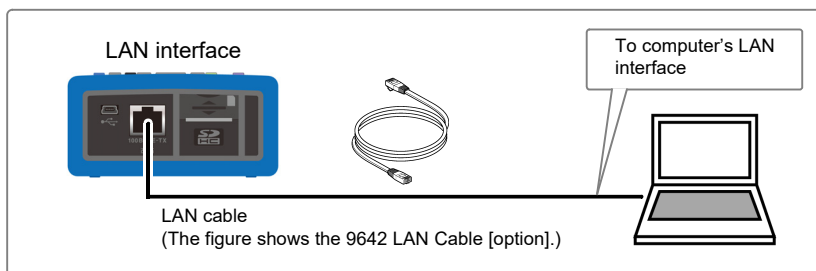

NOTE To connect several units of the PW3360 to a wireless LAN router

The instrument does not support network environments where an IP address is automatically acquired using DHCP. Assign a fixed unique IP address to each PW3360. To configure the wireless LAN router used as the access point, see its instruction manual.

Configure the Instrument's LAN Settings

- NOTE**
- Make these settings before connecting to a network. Changing settings while connected can duplicate IP addresses of other network devices, and incorrect address information may otherwise be presented to the network.
 - The instrument does not support DHCP (automatic IP address assignment) on a network.

- 1** Press the  key to display the [SET 7/8, LAN] screen.

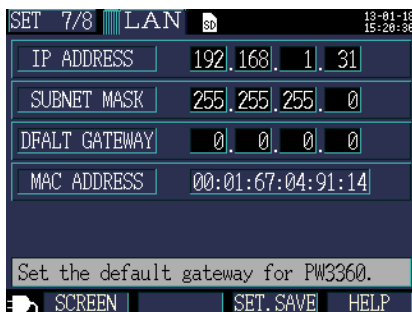

- 2** Configure the settings as desired.

IP Address	Identifies each device connected on a network. Each network device must be set to a unique address. The instrument supports IP version 4, with IP addresses indicated as four decimal octets, e.g., "192.168.0.1".
Subnet Mask	This setting is used to distinguish the address of the network from the addresses of individual network devices. The normal value for this setting is the four decimal octets "255.255.255.0".
Default Gateway	When the computer and instrument are on different but overlapping networks (subnets), this IP address specifies the device to serve as the gateway between the networks. If the computer and instrument are connected one-to-one, no gateway is used, and the instrument's default setting "0.0.0.0" can be kept as is.

NOTE

The MAC address is a hardware-specific address and cannot be changed.

- 3** Restart the instrument.

NOTE

Be sure to restart the instrument after configuring the LAN settings. Failure to do so will prevent the LAN settings from taking effect, making communication impossible.

Network environment configuration

Example 1. Connecting the instrument to an existing network

To connect to an existing network, the network system administrator (IT department) has to assign settings beforehand.

Some network device settings must not be duplicated.

Obtain the administrator's assignments for the following items, and write them down.

IP Address	_____
Subnet Mask	_____
Default Gateway	_____

Example 2. Connecting multiple instruments to a single computer using a hub

When building a local network with no outside connection, the following private IP addresses are recommended.

Configure the network using addresses 192.168.1.0 to 192.168.1.24

IP Address : Computer : 192.168.1.1
 : PW3360 : assign to each instrument in order 192.168.1.2, 192.168.1.3,
 192.168.1.4, ...

Subnet Mask : 255.255.255.0

Default Gateway: Computer : _____
 : PW3360 : 0.0.0.0

Example 3. Connecting one instrument to a single computer using the 9642 LAN Cable

The 9642 LAN Cable can be used with its supplied connection adapter to connect one instrument to one computer, in which case the IP address is freely settable. Use the recommended private IP addresses.

IP Address : Computer : 192.168.1.1
 : PW3360 : 192.168.1.2 (Set to a different IP address than the computer.)

Subnet Mask : 255.255.255.0

Default Gateway: Computer : _____
 : PW3360 : 0.0.0.0

Connecting the Instrument and Computer with a LAN Cable

- When connecting the instrument to your LAN using a LAN cable of more than 30 m or with a cable laid outdoors, take appropriate countermeasures that include installing a surge protector for LANs. Such signal wiring is susceptible to induced lighting, which can cause damage to the instrument.
- To avoid damaging the LAN cable, grasp the connector, not the cable, when unplugging the cable.

Connect the instrument and computer with a LAN cable.
The Ethernet interface jack is on the right side.

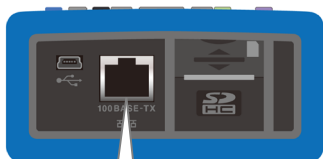

LINK LED RX/TX LED

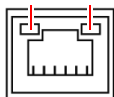

The RX/TX LED blinks when sending and receiving data, and the LINK LED lights when linked to the destination network device.

When connecting the instrument to an existing network
(when connecting the instrument to a hub)

Preparation items(provide either of the following)

A 100Base-TX straight cable
(commercially available)



1 Connect the LAN cable to the instrument's LAN interface.

2 Connect the LAN cable to the hub's 100Base-TX connector.

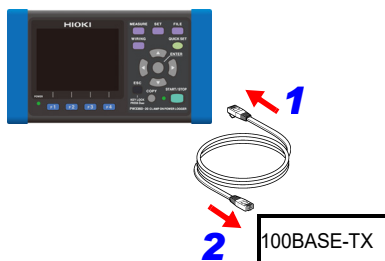

When connecting the instrument directly to a computer
(when connecting the instrument to a computer)

Preparation items(provide either of the following)

A 100Base-TX straight or cross cable



Model 9642 LAN Cable (optional)

1 Connect the LAN cable to the instrument's LAN interface.

2 Connect the LAN cable to the computer's 100Base-TX connector.

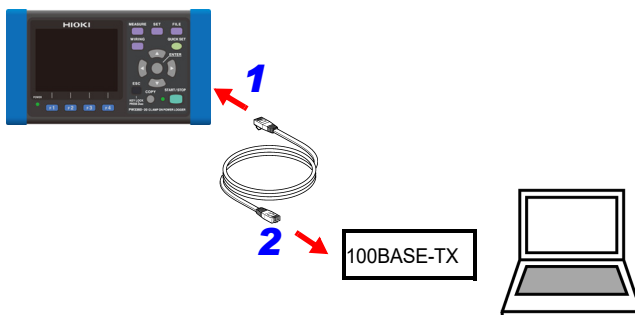

NOTE Since the instrument provides functionality for automatically detecting whether a straight or cross cable is being used, a straight cable may also be used. If you are unable to establish communications with the computer, try a cross conversion cable (9642 accessory).

10.2 Remote Control of the Instrument by Internet Browser

The instrument includes a standard HTTP server function that supports remote control by an internet browser on a computer.

The instrument's display screen and control panel keys are emulated in the browser. Operating procedures are the same as on the instrument.

- NOTE**
- Set the browser security level to “Medium” or “Medium-high,” or enable Active Scripting settings.
 - Unintended operations may occur if remote control is attempted from multiple computers simultaneously. Use one computer at a time for remote control.
 - Remote control can be performed even if the instrument's key lock is active.

1 Launch Internet Explorer®.

2 In the address bar, enter “http://” followed by the IP address with which you configured the instrument.

For example, enter the address as shown below if the instrument's IP address is [192.168.1.31]:

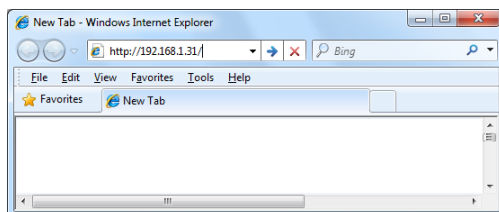

3 If the main page is displayed as shown below, you have successfully connected to the instrument:

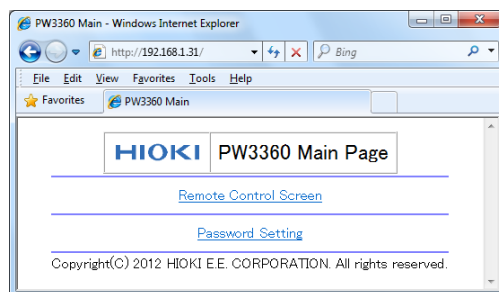

10.2 Remote Control of the Instrument by Internet Browser

If the HTTP screen is not displayed

Check Internet Explorer®'s settings.

- 1** On the Internet Explorer® settings, click **[Tools]-[Internet Options]**.
 - 2** On the **[Advanced]** tab, enable **[Use HTTP1.1]** and disable **[Use HTTP1.1 through proxy connections]**.
 - 3** Under **[LAN settings]** on the **[Connections]** tab, disable the **[Proxy server]** setting.
-
-

Check the LAN settings.

- 1** Check the instrument's LAN settings and the computer's IP address.
See: "Configure the Instrument's LAN Settings" (p. 154)
- 2** Verify that the LINK LED on the LAN interface is on and that the Web mark is being shown on the instrument's screen.
See: "Connecting the Instrument and Computer with a LAN Cable" (p. 156)

NOTE Be sure to restart the instrument after configuring the LAN settings. Failure to do so will prevent the LAN settings from taking effect, making communication impossible.

Operating the Instrument Remotely

- 1 Click **[Remote Control Screen]**.
The remote operation page will be displayed.

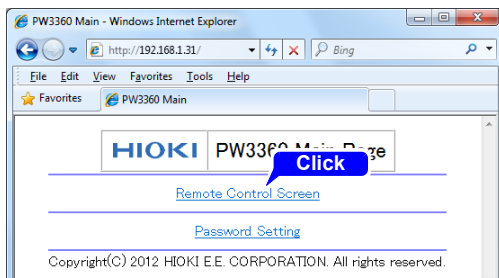

- 2 If a password has been set, the following page will be displayed.



- 3 Enter the password and click the **[SET]** button.
The screen and control panel being displayed on the instrument will be shown in the browser.
(If no password has been set, or if the password has been set to "0000" (the digit zero), this page will not be displayed. The default password is "0000.")

Setting a Password

You can restrict remote operation by setting a password.

1 Click [Password Setting] on the main page.

The following page will be displayed.

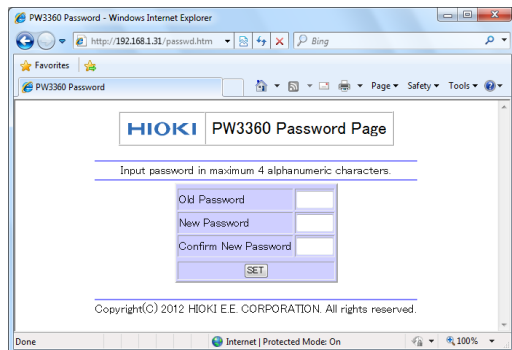
**2 Enter the [Old Password], [New Password], and [Confirm New Password] fields and click the [SET] button.**

Enter up to four English letters. If setting a password for the first time, enter “0000” (four zeroes) as the **[Old Password]**. If changing a previously set password, enter the previously set password.

The new password will become effective immediately.

If You Forget Your Password

Triggering a factory reset (p. 87) on the instrument will cause the password to be reset to its default value of “0000.” The password cannot be initialized by means of remote operation.

10.3 Downloading Recorded Data to Computer

Because the instrument is running an FTP (File Transfer Protocol)* server, using the FTP client function of the computer allows files from the SD memory card or internal memory to be downloaded to the computer.

*: A protocol to transfer files within the network.

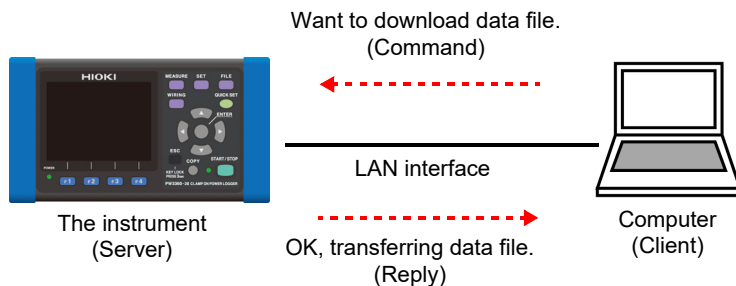

Setup

To download file with the FTP server function, basic LAN communication needs to be configured in advance

See: 10.1, "LAN Communications" (p. 153)

To restrict the connection, use the following procedure for configuration.

1

Press the **SET** key to display the [SET 7/8, LAN], Interface settings screen.



2

Press the **F2** [FTP] key.

3 Enable the authorization setting for the FTP server.

Enable the [AUTHENTICATION] and set a [USER NAME] and [PASSWORD].

The FTP server of this instrument is set to anonymous authentication, thereby allowing all devices on the network to access to the instrument when [AUTHENTICATION] is set to disable.

To complete the settings:

Press the **F1** [OK] key.

**AUTHENTICATION**

Enable when trying to restrict connection to the FTP server.

ON/OFF

USER NAME

Configure a user name used when connecting an FTP client to the instrument. (Up to 20 one-byte characters, example: HIOKI)

PASSWORD

Configure a password used when connecting an FTP client to the instrument. The password does not appear on the screen (displayed as *****). (Up to 20 one-byte characters, example: PW3360)

Download

1 Run an FTP client software.

This section explains an example of using a free software WinSCP. Explorer can be used when the FTP authorization is not used.

2 Enter the following and click [Login].

Host name	IP address of the instrument(p. 154)
User name	When FTP authentication is enabled (p. 164) , enter the
Password	Password setting of the instrument.

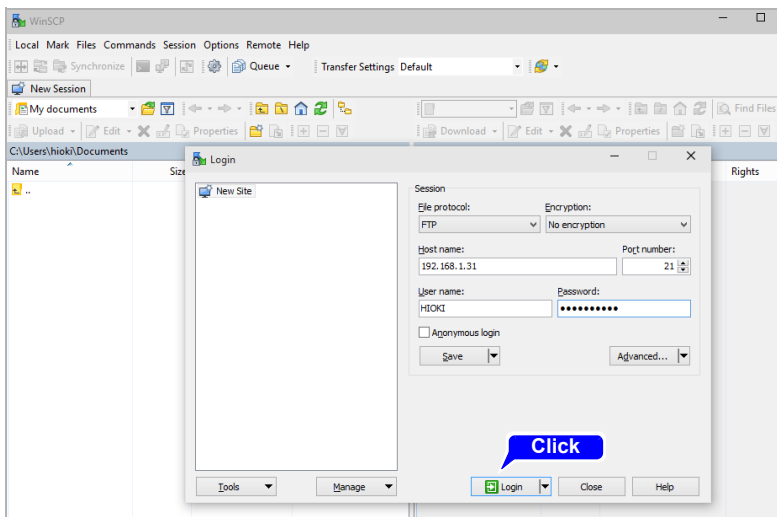

3 Click [SD] or [MEM].

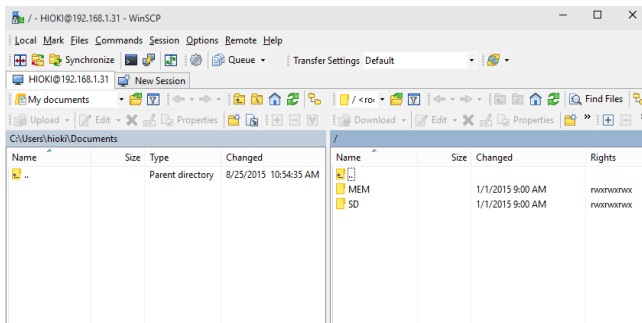

MEM	Internal memory
------------	-----------------

SD	SD memory card
-----------	----------------

4 Copy to any folder by selecting a folder or file.

- To copy measured data, copy the “Folders for measured data”.

See: 8.2, "Folder and File Structure" (p. 120)

- Do not move any folder or file. It is recommended to delete the folder and file after the data is copied and checked.

- Unintended operations may occur if operation is attempted from multiple computers simultaneously. Use one computer at a time when operating.
- The instrument may lose connection if no operation is done for 3 minutes or more after making connections. In such case, start over from procedure 1.
- FTP may not connect when trying to reconnect after being disconnected. In such case, try reconnecting after waiting for about one minute.
- The file being recorded cannot be downloaded during recording. When wanting to download file while continuing to record, have **[Recording start]** configured to **[Repeat]** (p. 110).
This setting repeats the start and stop of the recording every day, allowing the measured data up to the previous day to be downloaded through segmentation of measured data folders.
- Disconnect when changing the SD memory card.
- Avoid accessing any files at the same time as when downloading from within the instrument or externally using such tools as telnet and GENNECT One. Doing so may cause unintended results.
- Date/time of file update between the Internet browser and the instrument may not be identical.

10.3 Downloading Recorded Data to Computer

- Previous data excluding the latest one may end up getting downloaded to the computer (as data left from the previous access gets saved as temporary Internet files in web browsers).

When wanting to perform remote control:

See: 10.2, "Remote Control of the Instrument by Internet Browser" (p. 159)

10.4 Making good use of GENNECT One

The application GENNECT One, which can connect the instrument and your computer on a LAN, has various functions, including real-time measurement observation and measurement file acquisition.

Key features

◆ Logging (LAN)

Can acquire measured values from instruments in a LAN periodically (at logging intervals) and plot them on a single graph in real-time.

◆ Dashboard (LAN)

Can acquire measured values from instruments in a LAN periodically (at monitor intervals) and display them graphically. You can customize where measured values are displayed, background images, and other settings.

◆ Automatic file transfer (LAN)

Centralized management of measurement files saved by LAN-connected instruments by automatically transferring them to a computer.

For details, see GENNECT One special site.



GENNECT One special site

<https://gennect.net/en/one/index>



NOTE The latest version can be downloaded from our website.

Installation

Contents of included CD

File name	File description
Readme_Jpn.pdf	Descriptions of GENNECT One (Japanese)
Readme_Eng.pdf	Descriptions of GENNECT One (English)
setup.exe	GENNECT One Installer

Operating environment

Supported operating systems	Windows 7 (32-bit/64-bit), Windows 8.1 (32-bit/64-bit), Windows 10 (32-bit/64-bit)
Software environment	Microsoft .NET Framework 4.6.2 or later
CPU	Clock speed: 2 GHz or greater
RAM	4 GB or more
Display	1366 × 768 or better resolution
Hard drive	1 GB or more available space
CD-ROM drive	Used for installation

For detailed methods for using, see "GENNECT One User's Manual (PDF)," which can be displayed by choosing Help in GENNECT One's information menu.

Installation procedure

Screen sample: Windows 10

- 1 Start the computer.**
Administrator authority may be required for the installation.
- 2 Set the included CD to the CD-ROM drive.**
- 3 Click the Start button, and then, click [File Explorer](#) to start Explorer.**

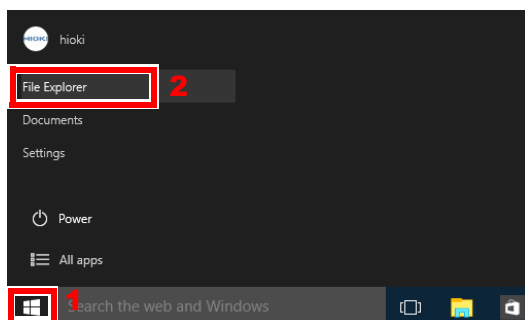

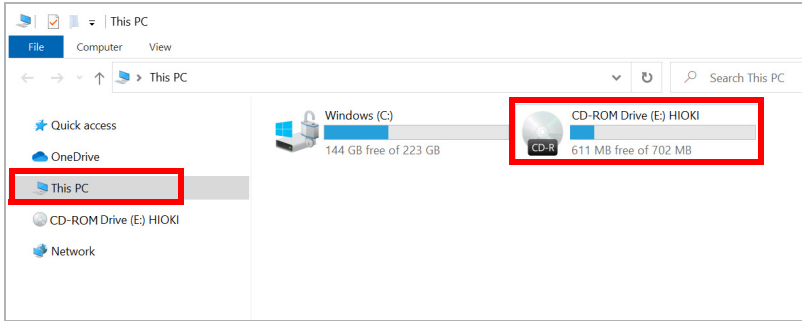
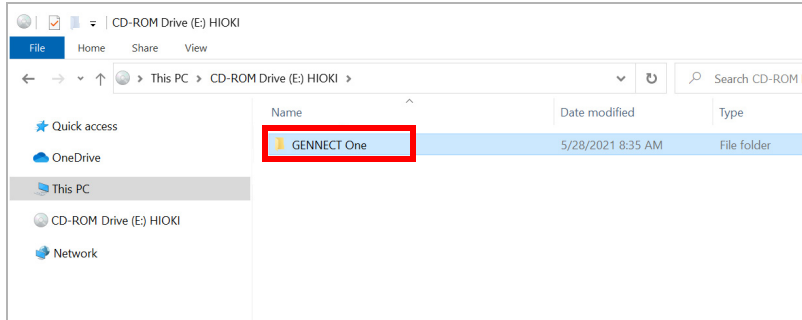
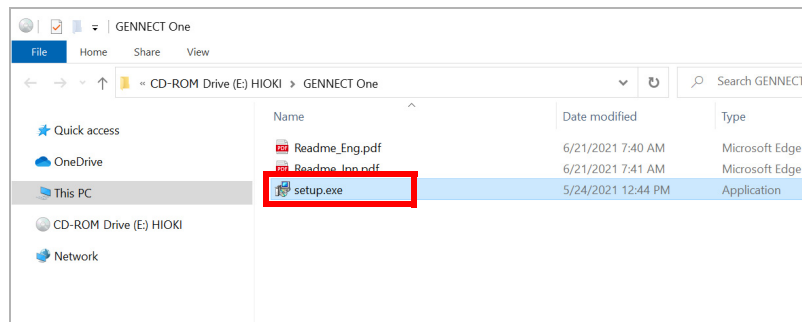
4 Click This PC, and then, double-click CD-ROM Drive.**5 Double-click the GENNECT One folder.****6 Double-click setup.exe (SET UP file).**

Using Pulse Input and Output

Chapter 11

The pulse I/O terminals can be used to input a pulse signal from an external source or to output a pulse signal that is proportional to active energy during recording and measurement.

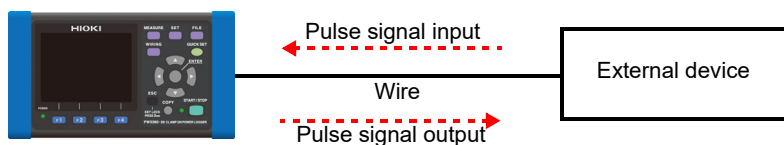

1 Wire the instrument to an external device. (p. 172)

2 Configure the instrument's pulse settings. (p. 173)

3 Use pulse input (p. 174) or output (p. 176).

Pulse input

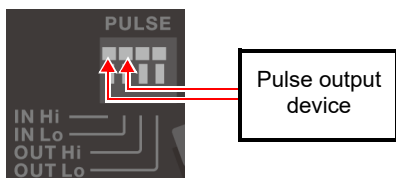

Input a pulse signal from an external source. After configuring scaling (coefficient), sub-unit, and unit (five byte characters) settings, you can convert and measure an input pulse signal. After recording and measurement are started, pulse input values are saved for each save interval.

See: 11.3, "Inputting a Pulse Signal" (p. 174)

Pulse output

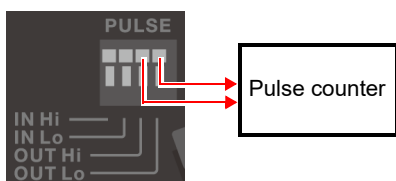

A pulse signal is output each time active energy consumption (WP+) exceeds the pulse output rate during recording and measurement. The output rate can be set from 1 Wh to 1,000 kWh.

See: 11.4, "Outputting a Pulse Signal" (p. 176)

11.1 Connecting Wires to the Pulse I/O Terminals

This section describes how to connect wires to the pulse I/O terminals. When using pulse output, the signal must be pulled up to the external power supply.

See: 11.4, "Outputting a Pulse Signal" (p. 176)



WARNING

To avoid electric shock or damage to the equipment, always observe the following precautions when connecting to pulse input and output terminals.

- Always turn off the power to the instrument and to any devices to be connected before making connections.
- Be careful to avoid exceeding the ratings of pulse input and output terminals.
- During operation, a wire becoming dislocated and contacting another conductive object can be serious hazard. Secure the pulse input and output terminals.
- Ensure that devices and systems to be connected to the pulse input and output terminals are properly isolated.



CAUTION

To avoid electric shock, use the recommended wire type to connect to the current input terminals, or otherwise ensure that the wire used has sufficient current handling capacity and insulation.

Preparation items



Electric wires that conform with:

- single line: $\phi 0.65$ mm (AWG22)
- twisted wire: 0.32 mm² (AWG22)
- diameter of search wire: $\phi 0.12$ mm or more

Supported electric wires:

- single line: $\phi 0.32$ mm to $\phi 0.65$ mm (AWG28 to AWG22)
- twisted wire: 0.08 mm² to 0.32 mm² (AWG28 to AWG22)
- diameter of search wire: $\phi 0.12$ mm or more

Standard direction wire length: 9 mm to 10 mm



A flat head screwdriver
diameter: 3 mm, width of
blade-tip: 2.6 mm

1 Press down on the terminal button using a tool, such as a flat head screwdriver.

2 While the button is depressed, insert the wire into the electric wire connection hole.

3 Release the button.
The electric wire is locked in place.

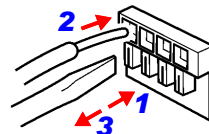

11.2 Configuring Pulse Settings

When using the pulse I/O terminals, you must configure the instrument's pulse settings.

1 Press the  key to display the [SET 8/8, PULSE] screen.

2 Configure the settings as desired.

Pulse input

FILTER	ON/OFF
SCALING	0.001 to 100.000
AUX UNIT	p/n/ μ (u)/m/none/k /M/G/T
UNIT	Up to 5 byte characters

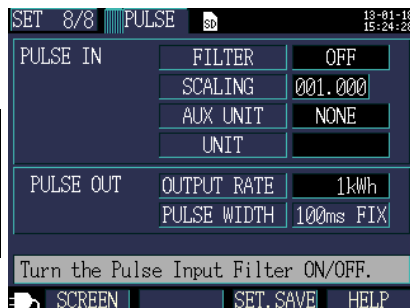

Filter ON (mechanical contact use):

Frequencies of 25 Hz or less (with high and low intervals at least 20 ms in duration)

Filter OFF (electronic contact use):

Frequencies of 5 kHz or less (with high and low intervals at least 100 μ s in duration)

Pulse output

OUTPUT RATE	OFF/1 Wh/10 Wh/100 Wh/1 kWh/10 kWh/100 kWh/1000 kWh
PULSE WIDTH	Fixed to 100 ms (cannot be changed)

NOTE Because the active energy value is updated every second, the instrument can generate pulse output at a maximum rate of 1 pulse per second. Set the pulse output rate so that it is greater than the active energy consumed in 1 second.

Example:

If the maximum active energy consumption in 1 second is 150 Wh, the pulse output rate should be set to a value that is greater than or equal to 1 kWh.

11.3 Inputting a Pulse Signal

This section describes how to input a pulse signal from an external source.

After configuring scaling (coefficient), sub-unit, and unit (five byte characters) settings, you can convert an input pulse signal. When recording and measurement are started, pulses are measured, and pulse values are saved for each save time interval. After recording and measurement, the unit consumption can be calculated based on the pulse input values and active energy.



DANGER

To avoid electrical hazards and damage to the instrument, do not apply voltage exceeding the rated maximum to the pulse input and output terminals (45 V DC).

Signal Input Method

No-voltage contact input

Counted when terminals change from shorted to open.

Voltage input

Counted when the voltage level changes to high.

Input voltage range	HIGH level: 2 V to 45 V LOW level: 0 V to 0.5 V
Maximum rated voltage between terminals	45 V
Maximum rated voltage to earth	Not isolated (GND common with instrument)
Measurement range	0 to 9999 (defined as maximum number of pulses during the save interval time)

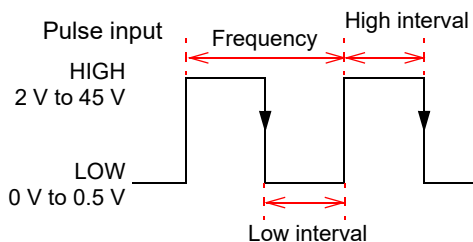

Filter	Frequency	High/Low period
ON (Mechanical contact use)	25 Hz or less	20 ms or more
OFF (Electronic contact use)	5 kHz or less	100 μ s or more

- NOTE**
- The pulse input low terminal is common with the instrument GND and is not isolated. Isolate input as necessary.
 - If the pulse input cable is grouped with other cables, interference such as noise from external sources may cause the instrument to malfunction. Pulse input cables should be routed separately.
 - Excessively long cables may suffer from interference such as noise from external sources, causing the instrument to malfunction. If you encounter this issue, attach a ferrite clamp to the cable as shown in the figure below. (Position the clamp as close as possible to the terminal block.)

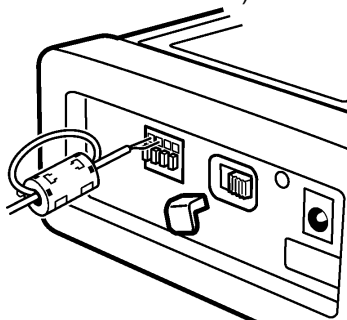

11.4 Outputting a Pulse Signal

A pulse signal is output each time active energy consumption (WP+) exceeds the pulse output rate during recording and measurement. For example, if the output rate is 10 kWh, the pulse signal will be output each time the active energy consumption (WP+) exceeds the output rate after recording and measurement start, specifically at 10 kWh, 20 kWh, and 30 kWh.



DANGER

To avoid electrical hazards and damage to the instrument, do not apply voltage/current exceeding the rated maximum (30 V, 5 mA) to the pulse input and output terminals.

Output signal	Open collector output (photocoupler-isolated) Active LOW
Maximum input voltage	30 V
Maximum input current	5 mAmax.
Target	Active energy consumption (WP+)
Pulse output rate	1Wh/10Wh/100Wh/1kWh/10kWh/100kWh/1000kWh
Pulse width	LOW level: Approx. 100 ms

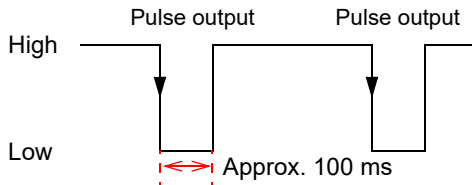

11.4 Outputting a Pulse Signal

The pulse output terminal is isolated from the instrument's internal circuitry. When using pulse output, connect the "PULSE OUT Hi" terminal to an external power supply using a pull-up resistor as shown in the following example external circuit:

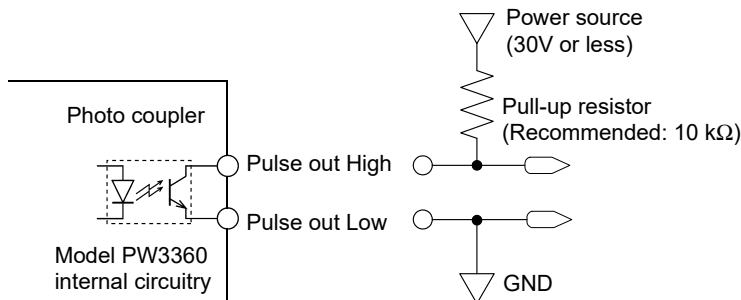

Example external circuit

- NOTE**
- When using the 1P2W x 2 circuit or 1P2W x 3 circuit wiring setting, the active energy for the first circuit drives pulse output. Pulse output cannot be generated for the active energy of the second or third circuit.
 - If the wire connected to the pulse output terminal has a length of more than 100 meters, its stray capacitance can have an adversary effect on proper operation. However, even if the wires have a length of less than 100 m, the system may not work correctly depending on surrounding environments.

Specifications Chapter 12

12.1 General Specifications

Operating environment	Indoors, Pollution degree 2, altitude up to 2,000 m (6562-ft.)
Operating temperature and humidity	-10°C to 50°C (14°F to 122°F), 80%RH or less (non-condensating) When using LAN communications, 0°C to 50°C (32°F to 122°F), When operating on battery power, 0°C to 40°C (32°F to 104°F), when charging the battery, 10°C to 40°C (50°F to 104°F)
Storage temperature and humidity	-20°C to 60°C (-4°F to 140°F), 80%RH or less (non-condensating) However, the battery's storage temperature range is -20°C to 30°C (-4°F to 86°F).
Dielectric strength (50 Hz /60 Hz, 60 minutes)	4.29 kVrms (1 mA sense current) Between voltage input terminals and external control terminals
Power supply	<ul style="list-style-type: none"> Model Z1006 AC Adapter (12 V, 1.25 A) Rated supply voltage 100 VAC to 240 VAC (Voltage fluctuations of $\pm 10\%$ from the rated supply voltage are taken into account.) Rated power supply frequency 50 Hz/60 Hz Anticipated transient overvoltage 2500 V Model 9459 Battery Pack (Ni-MH DC7.2 V 2700 mAh)
Charge function	Charges the battery regardless of whether the instrument is on or off. Charge time: Max. 6 hr. 10 min. (reference value at 23°C/73.4°F)
Maximum rated power	<ul style="list-style-type: none"> When the Z1006 AC Adapter is used 40 VA (including AC adapter) 13 VA (PW3360 instrument only) When the 9459 Battery Pack is used 3VA
Continuous battery operation time	Approx. 8 hr. (Continuous, backlight off) (when using the battery pack)

12.1 General Specifications

Backup battery life	Clock and settings (Lithium battery), Approx. 10 years at 23°C (at 73.4°F)
Dimensions	Without PW9002: Approx. 180W x 100H x 48D mm / Approx. 7.09"W x 3.94"H x 1.89"D (excluding protrusions) With PW9002: Approx. 180W x 100H x 67.2D mm / Approx. 7.09"W x 3.94"H x 2.65"D (excluding protrusions)
Mass	Without PW9002: Approx. 550 g (19.4 oz.) With PW9002: Approx. 830 g (29.3 oz.)
Product warranty period	3 years
Applicable standards	Safety EN61010 Pollution degree 2 EMC EN61326 Class A
Accessories	See: "Accessories" (p. 2)
Options	See: "Options" (p. 3)

12.2 Basic Specifications

Input specifications

Number of channels	Voltage: 3 channels, Current: 3 channels
Measurement line type	Single-phase 2-wire (1P2W, 1P2W × 2 circuits, 1P2W × 3 circuits) Single-phase 3-wire (1P3W, 1P3W1U) Three-phase 3-wire (3P3W2M, 3P3W3M) Three-phase 4-wire (3P4W) Current only
Measurement line Frequency	50 Hz/60 Hz
Input methods	Voltage: Isolated input (U1, U2, U3, and N: channels not isolated) Current: Insulated clamp sensors
Input resistance (50 Hz/60 Hz)	Voltage input section: 3.0 MΩ ± 20%
Maximum rated voltage between terminals	Voltage input section: 1000 VAC, 1400 V _{peak} Current input section: 1.7 VAC, 2.4 V _{peak}
Maximum rated voltage to earth	Voltage input section: 600 V, Measurement Categories III (anticipated transient overvoltage 6000 V) 300 V Measurement Categories IV (anticipated transient overvoltage 6000 V) Current input section: Depends on clamp sensor in use.

Measurement specifications

Measurement method	Digital sampling, zero-cross synchronized calculation method
Sampling	10.24 kHz (50 Hz: 10 cycles; 60 Hz: 12 cycles; 2,048 points) Simultaneous sampling of voltage and current; inter-channel multiplexing at 61.44 kHz Third channel during 3P3W2M measurement is calculated using vector computation.
Calculation processing	50 Hz: Continuous, gapless measurement at 10 cycles 60 Hz: Continuous, gapless measurement at 12 cycles
A/D converter resolution	16-bit

12.2 Basic Specifications

Measurement specifications

Display range	Voltage	: 5 V to 1,000 V; separate warning displayed when over-range Zero-display processing forces voltage RMS values of less than 5 V to be displayed as the value zero. If the voltage RMS value is 0 V, a harmonic voltage of 0 is used for all orders. (PW3360-21 only)
	Current	: 0.4% to 130% of range Separate warning displayed when over-range or over-peak. Zero-display processing forces current RMS values of less than 0.4% to be displayed as the value zero. If the current RMS value is 0 A, a harmonic current of 0 is used for all orders. (PW3360-21 only)
	Power	: 0% to 130% of range (If the voltage RMS value or current RMS value is 0, the power value is displayed as the value zero.) If the voltage RMS value or current RMS value is 0, a harmonic active power and harmonic reactive power of 0 are used for all orders. (PW3360-21 only)
Effective measuring range	Voltage	: 90 V to 780 V; peak: $\pm 1,400$ V
	Current	: 5% to 110% of range; peak: $\pm 400\%$ of range However, maximum range is 200%.
	Power	: 5% to 110% of range
	Frequency	: 45 Hz to 66 Hz
Measurement items		Voltage RMS, current RMS, voltage fundamental wave value, current fundamental wave value, voltage fundamental wave phase angle, current fundamental wave phase angle, frequency (U1), voltage waveform peak (absolute value), current waveform peak (absolute value), active power, reactive power (with lag/lead display), apparent power, power factor (with lag/lead display) or displacement power factor (with lag/lead display), active energy (consumption, regeneration), reactive energy (lag, lead), energy cost display, active power demand quantity (consumption, regeneration), reactive power demand quantity (lag, lead), active power demand value (consumption, regeneration), reactive power demand value (lag, lead), power factor demand, pulse input, harmonic voltage level, harmonic current level, harmonic power level, content percentage, phase angle, total harmonic distortion (THD-F or THD-R) (PW3360-21 only)

**Display range, effective measurement range, effective peak range chart
(representative example: 9661 sensor)**

Item	Range	Display range	Effective measurement range		Display range	Effective peak
		Lower limit	Lower limit	Upper limit	Upper limit	Range
Voltage	600 V single range	5.00 V	90.00 V	780.00 V	1000.0 V	±1400 V _{peak}
Current (Model 9661)	5 A range	0.0200 A	0.2500 A	5.5000 A	6.5000 A	±20 A _{peak}
	10 A range	0.040 A	0.500 A	11.000 A	13.000 A	±40 A _{peak}
	50 A range	0.200 A	2.500 A	55.000 A	65.000 A	±200 A _{peak}
	100 A range	0.40 A	5.00 A	110.00 A	130.00 A	±400 A _{peak}
	500 A range	2.00 A	25.00 A	550.00 A	650.00 A	±1000 A _{peak}

Display specifications

Display update rate	Approx. 0.5 s (excluding SD memory card, during internal memory access LAN and USB communications) However, approx. 1.0 s for energy-related data.
Display	320 x 240 dots, 3.5" TFT color LCD
Language	Japanese/ English/ Chinese (simple)/ German/ Italian/ French/ Spanish/ Turkish/ Korean
Backlight	LED backlight AUTO OFF (2 minutes)/ON The POWER LED flashes during auto-off operation.

Conditions of guaranteed accuracy

Conditions of guaranteed accuracy	Warm-up time of at least 30 minutes, sine wave input, frequency 50 Hz/60 Hz
Temperature and humidity for guaranteed accuracy	23°C ± 5°C (73 ± 9°F), 80%RH or less (applies to all specifications unless otherwise noted)
Display range of guaranteed accuracy	Effective measuring range
Period of guaranteed accuracy	1 year

12.2 Basic Specifications

Other conditions

Real-Time Clock function	Auto-calendar, leap-year correcting 24-hour clock
Real-time clock accuracy	Within ± 0.3 s per a day (power on, 0°C to 50°C) Within ± 0.5 s per a day (power on, -10°C to 0°C)
Temperature characteristic	Within $\pm 0.1\%$ f.s./°C (other than at 23°C \pm 5°C)
Effect of common mode voltage	Within $\pm 0.2\%$ f.s. (600 VAC, 50 Hz/60 Hz, Between voltage input terminals and instrument chassis)
Effect of external magnetic field interference	$\pm 1.5\%$ f.s. (in a magnetic field of 400 A/m rms, 50 Hz/60 Hz)

12.3 Detailed Measurement Specifications

Measurement items

Voltage RMS (U)

Measurement method	True RMS type
Measurement range	600 V single range
Measurement accuracy	45 Hz to 66 Hz: $\pm 0.3\%$ rdg. $\pm 0.1\%$ f.s. With a fundamental frequency of 50 Hz/60 Hz Up to 1 kHz: $\pm 3\%$ rdg. $\pm 0.2\%$ f.s. Up to 3 kHz: $\pm 10\%$ rdg. $\pm 0.2\%$ f.s. With 3P3W3M wirings, add $\pm 0.5\%$ rdg.

Current RMS (I)

Measurement method	True RMS type
Measurement range	<p>Load current</p> <p>Model 9660, 9695-03 (1mV/A) : 5.0000/10.000/50.000/100.00 A Model 9661 (1mV/A) : 5.0000/10.000/50.000/100.00/500.00 A Model 9669 (0.5mV/A) : 100.00/200.00/1.0000k A Model 9694 (10mV/A) : 500.00m/1.0000/5.0000/10.000/50.000 A Model 9695-02 (10mV/A) : 500.00m/1.0000/5.0000/10.000/50.000 A Model CT9667 500A range (1mV/A) : 50.000/100.00/500.00 A Model CT9667 5000A range (0.1mV/A) : 500.00/1.0000 k/5.0000k A</p> <p>Leakage current</p> <p>Model 9657-10, 9675 (100mV/A): 50.000m/100.00m/500.00m/1.0000/5.0000 A</p>
Range control	Manual range
Measurement accuracy	45 Hz to 66 Hz: $\pm 0.3\%$ rdg. $\pm 0.1\%$ f.s. + clamp sensor specifications With a fundamental frequency of 50 Hz/60 Hz Up to 1 kHz: $\pm 3\%$ rdg. $\pm 0.2\%$ f.s. + clamp sensor specifications Up to 3 kHz: $\pm 10\%$ rdg. $\pm 0.2\%$ f.s. + clamp sensor specifications

12.3 Detailed Measurement Specifications

Frequency (f)

Measurement method	Reciprocal method
Measurement range	40.000 Hz to 70.000 Hz
Measurement channel	Voltage U1
Measurement accuracy	±0.5%rdg. For sine wave input from 90 V to 780 V

Voltage waveform peak (U_{peak}/U_{pk}), Current waveform peak (I_{peak}/I_{pk})

Measurement method	Peak value (absolute value) for each calculation interval (10 cycles at 50 Hz or 12 cycles at 60 Hz)
Measurement accuracy	Accuracy not defined.

Active power (P)

Measurement method	Calculated using voltage and current waveform sampling data. See: "Active power" (p. 204)
Measurement range	Combination of voltage × current range See: 12.6, "Range Configuration and Accuracy by Clamp Sensor" (p. 213)
Measurement accuracy	45 Hz to 66 Hz: ±0.3% rdg. ±0.1% f.s. + clamp sensor specifications (power factor = 1) With a fundamental frequency of 50 Hz/60 Hz Up to 1 kHz: ±3% rdg. ±0.2% f.s. + clamp sensor specifications Up to 3 kHz: ±10% rdg. ±0.2% f.s. + clamp sensor specifications
Phase effects	Equivalent to ±0.3° of phase accuracy (at 50 Hz/60 Hz, f.s. input)
Polarity indication	Consumption: Unsigned Regeneration: Negative

Reactive power (Q, PF/Q/S calculation selection: RMS calculations)

Measurement method	Calculated from apparent power and active power. See: "Reactive power" (p. 205)
Measurement range	Combination of voltage range × current range See: 12.6, "Range Configuration and Accuracy by Clamp Sensor" (p. 213)

Reactive power (Q, PF/Q/S calculation selection: RMS calculations)

Measurement accuracy	±1 dgt. relative to calculations from measured values
Lag/Lead display	Uses the sign of reactive power Q (fundamental wave reactive power). Positive : Lag Negative : Lead
Output data	For SD memory card and internal memory output data, the polarity indicates lag/lead. Lag : Positive Lead: Negative

Reactive power (Q, PF/Q/S calculation selection: fundamental calculations)

This reactive power Q is defined as the fundamental wave reactive power.

Measurement method	Calculated from fundamental wave voltage and current. See: "Reactive power" (p. 205)
Measurement range	Combination of voltage range × current range See: 12.6, "Range Configuration and Accuracy by Clamp Sensor" (p. 213)
Measurement accuracy	With a fundamental wave frequency of 45 Hz to 66 Hz: ±0.3% rdg. ±0.1% f.s. + clamp sensor specifications (reactive factor = 1)
Phase effects	Equivalent to ±0.3° of phase accuracy (at 50 Hz/60 Hz, f.s. input)
Lag/Lead display	Positive : Lag Negative : Lead
Output data	For SD memory card and internal memory output data, the polarity indicates lag/lead. Lag : Positive Lead: Negative

Apparent power (S, PF/Q/S calculation selection: RMS value calculation)

Measurement method	Calculated from the voltage RMS and current RMS values. See: "Apparent power" (p. 206)
Measurement range	Combination of voltage × current range See: 12.6, "Range Configuration and Accuracy by Clamp Sensor" (p. 213)
Measurement accuracy	±1 dgt. relative to calculations from measured values.

12.3 Detailed Measurement Specifications

Apparent power (S, PF/Q/S calculation selection: fundamental calculations)

This apparent power S is defined as the fundamental wave apparent power.

Measurement method	Calculated from the fundamental wave active power and the fundamental wave reactive power. See: "Apparent power" (p. 206)
Measurement range	Combination of voltage × current range See: 12.6, "Range Configuration and Accuracy by Clamp Sensor" (p. 213)
Measurement accuracy	±1 dgt. relative to calculations from measured values.

Power factor (PF, PF/Q/S calculation selection: RMS value calculation)

Measurement method	Calculated from the apparent power and active power. See: "Power factor, Displacement power factor" (p. 206)
Measurement range	Lag : 0.0000 to 1.0000 Lead : 0.0000 to 1.0000
Measurement accuracy	±1 dgt. relative to calculations from measured values.
Lag/Lead display	Uses the sign of reactive power Q (fundamental wave reactive power). Positive : Lag Negative : Lead
Output data	For SD memory card and internal memory output data, the polarity indicates lag/lead. Lag : Positive Lead: Negative

Power factor (PF, PF/Q/S calculation selection: fundamental calculations)

This power factor PF is defined as the displacement power factor DPF.

Measurement method	Calculated from the fundamental wave active power and the fundamental wave reactive power. See: "Power factor, Displacement power factor" (p. 206)
Measurement range	Lag : 0.0000 to 1.0000 Lead : 0.0000 to 1.0000
Measurement accuracy	±1 dgt. relative to calculations from measured values

12.3 Detailed Measurement Specifications

Power factor (PF, PF/Q/S calculation selection: fundamental calculations)

This power factor PF is defined as the displacement power factor DPF.

Lag/Lead display	Uses the sign of reactive power Q (fundamental wave reactive power). Positive opposite sign : Lag Negative opposite sign : Lead
Output data	For SD memory card and internal memory output data, the polarity indicates lag/lead. Lag : Positive Lead: Negative

Active energy (WP), Reactive energy (WQ)

Measurement method	Active power values are integrated separately for consumption and regeneration from the start of recording. Reactive power values are integrated separately for lag and lead from the start of recording. See: "Electric energy, Energy cost" (p. 207)
Measurement range	<ul style="list-style-type: none"> Active energy Consumption WP+: 0.00000 mWh to 99999.9 GWh Regeneration WP-: -0.00000 mWh to -99999.9 GWh Reactive energy Lag WQ_LAG : 0.00000 mvarh to 99999.9 Gvarh Lead WQ_LEAD: -0.00000 mvarh to -99999.9 Gvarh
Measurement accuracy	Active power and reactive power measurement accuracy ± 1 dgt.
Integration time accuracy	$\pm 10\text{ppm} \pm 1\text{sec.}$

Energy cost (Ecost)

Measurement method	The active energy (consumption) WP+ is multiplied by the unit cost (per kWh).
Measurement accuracy	Calculation from measured values ± 1 dgt.

12.3 Detailed Measurement Specifications

Active power demand quantity (WPdem), Reactive power demand quantity (WQdem), Data is output but not displayed.

Measurement method	Active power values are integrated separately for consumption and regeneration for each interval time. Reactive power values are integrated separately for lag and lead during the interval time. See: "Demand quantity (output data only; not displayed)" (p. 208)
Measurement items	<ul style="list-style-type: none"> Active power demand quantity Consumption WPdem + Regeneration WPdem - Reactive power demand quantity Lag WQdem_LAG Lead WQdem_LEAD
Measurement accuracy	Active power and reactive power measurement accuracy ± 1 dgt.
Integration time accuracy	± 10 ppm ± 1 sec.

Active power demand Value (Pdem), Reactive power demand quantity (Qdem)

Measurement method	Active power values are averaged separately for consumption and regeneration for each interval time. Reactive power values are averaged separately for lag and lead for each interval time. See: "Demand value, Pulse input" (p. 209)
Measurement items	<ul style="list-style-type: none"> Active power demand value Consumption Pdem + Regeneration Pdem - Reactive power demand value Lag Qdem_LAG Lead Qdem_LEAD
Measurement accuracy	Active power and reactive power measurement accuracy ± 1 dgt.

Power factor demand value (PFdem)

Measurement method	Calculated from the active power demand value Pdem and the reactive power demand value Qdem. See: "Demand value, Pulse input" (p. 209)
Measurement accuracy	± 1 dgt. relative to calculations from measured values

Pulse input (Pin)

Measurement method	The pulse input value is multiplied by the scaling value.
Measurement accuracy	± 1 dgt. relative to calculations from measured values

Harmonic Wave (PW3360-21 only)

Standard	Complies with IEC 61000-4-7:2002, except without intermediate harmonics.
Window width	50 Hz: 10 cycles (with interpolation) 60 Hz: 12 cycles (with interpolation)
No. of window points	Rectangular, 2048 points
Number of orders analyzed	Up to 40th
Analysis parameters	<p>Harmonic level: Harmonic level for each order for voltage, current, and power When using 3P3W2M wiring, the U12 and I12 values calculated for the third channel are not displayed.</p> <p>Harmonic content percentage: Harmonic content percentage for each order for voltage, current, and power See: "Harmonic voltage, current, and power (PW3360-21 only)" (p. 210)</p> <p>Harmonic phase angle: Harmonic phase angle for each order for voltage, current, and power See: "Harmonic phase angle (PW3360-21 only)" (p. 211)</p> <p>Total harmonic distortion: voltage and current (THD-F or THD-R) See: "Total harmonic distortion (PW3360-21 only)" (p. 212)</p>

12.3 Detailed Measurement Specifications

Harmonic Wave (PW3360-21 only)

	<ul style="list-style-type: none">• Harmonics level 1 th to 15 th: $\pm 5\% \text{rdg.} \pm 0.2\% \text{f.s.}$ 16 th to 20 th: $\pm 10\% \text{rdg.} \pm 0.2\% \text{f.s.}$ 21 th to 40 th: $\pm 20\% \text{rdg.} \pm 0.3\% \text{f.s.}$ However, accuracy figures from the clamp sensor specifications are added for current and power.
Measure- ment accu- racy	<ul style="list-style-type: none">• Harmonic power phase angle 1 th to 3 th: $\pm 3^\circ +$ accuracy figures from the clamp sensor specifications 4 th to 40 th: $\pm 0.1^\circ \times k \pm 3^\circ +$ accuracy figures from the clamp sensor specifications (k: number of harmonic order) However, harmonic voltage must be 6 V and current level must be 1% f.s. or higher for each order.• Total harmonic distortion rate No accuracy defined.

12.4 Functional Specifications

Screen display

Measurement	<p>List (voltage, current, frequency, active/apparent/reactive power, power factor, integral energy, elapsed time)</p> <p>Voltage and current details (RMS value, fundamental wave value, waveform peak, phase angle)</p> <p>Power (per-channel and total active/reactive/apparent power, power factor)</p> <p>Energy (active energy, reactive energy, start time, planned stop time, elapsed time, energy cost)</p> <p>Demand (active power demand value, reactive power demand value, power factor demand value, pulse value)</p> <p>Waveforms (display of all channels by voltage and current with user-selectable zoom factor)</p> <p>Enlarged views (selection of four parameters for enlarged views)</p> <p>Trend (Selection of one measurement parameter for a time-series display of maximum, minimum, and average values)</p> <p>Harmonics (voltage, current, and power levels, content percentage, phase angle graph, and list) (PW3360-21 only)</p>
Wiring	Wiring diagram, Wiring check (wiring confirmation)
Setting	Various settings
File	SD memory card and internal memory operations
Quick Set	Provides information about procedures associated with measurement settings, wiring types, wiring check (wiring confirmation), recording settings, and recording initiation.

Wiring diagram screen

Wiring diagram screen	Displays wiring diagrams for single-phase/2-wire (1P2W), single-phase/3-wire (1P3W, 1P3W1U), 3-phase/3-wire (3P3W2M, 3P3W3M), and 3-phase/4-wire (3P4W) connections.
Wiring check screen	Displays measured values (voltage and current RMS values, voltage and current phase angles, active power, and displacement power factor), vector diagrams, and wiring confirmation results.
Settings	Allows the wiring type, clamp sensor type, and range to be changed.
Wiring confirmation (Wiring Check) content	<p>Voltage input, current input, voltage phase, current phase (3-phase only), phase difference, and power factor (CHECK mark displayed if the power factor is 0.5 or less)</p> <p>Displays information about reviewing items for the wiring confirmation result.</p>

12.4 Functional Specifications

Setting screen

Wiring	1P2W/1P2W×2/1P2W×3/ 1P3W/1P3W+I/1P3W1U/1P3W1U+I/ 3P3W2M/3P3W2M+I/3P3W3M/3P4W/ Current only (I)/Current only (I)×2/Current only (I)×3
Frequency	50Hz/60Hz If there is voltage input and the frequency setting is wrong, displays an error and changes the frequency setting.
Clamp sensor	Load current: Model 9660/9661/9694/9669/9695-02/9695-03/ CT9667(500A)/CT9667(5000A) Leakage current: Model 9657-10/9675
Current range	Load current Model 9660, 9695-03 (1mV/A): 5.0000/10.000/50.000/100.00 A Model 9661 (1mV/A): 5.0000/10.000/50.000/100.00/500.00 A Model 9669 (0.5mV/A): 100.00/200.00/1.0000k A Model 9694 (10 mV/A): 500.00m/1.0000/5.0000/10.000/50.000 A Model 9695-02 (10mV/A): 500.00m/1.0000/5.0000/10.000/50.000 A Model CT9667 500A range (1mV/A): 50.000/100.00/500.00 A Model CT9667 5000A range (0.1mV/A): 500.00/1.0000 k/5.0000k A Leakage current Model 9657-10, 9675 (100mV/A): 50.000m/100.00m/500.00m/1.0000/5.0000 A
CT ratio	User-specified: 0.01 to 9999.99 Selected: 1/40/60/80/120/160/200/240/300/400/600/800/1200
Voltage range	600 V fixed
VT (PT) ratio	User-specified: 0.01 to 9999.99 Selected: 1/60/100/200/300/600/700/1000/2000/2500/5000
PF/Q/S calculation selection	RMS calculation / fundamental wave calculation
Energy cost	Unit cost: 0.00000 to 99999.9/kWh Currency: 3 user-specified alphanumeric characters
THD calculation selection (PW3360-21 only)	THD-F/THD-R
Remaining save time	Calculated and displayed based on the amount of space remaining on the SD memory card or in the internal memory, the save interval, and the save items. Also updated during time-series measurement.
Save destination	SD memory card / internal memory (capacity: approx. 320 KB)

Setting screen

Save interval time	1/2/5/10/15/30 sec./ 1/2/5/10/15/20/30/60 min.
Save items	PW3360-20: Average only / all data (maximum, minimum, and average) PW3360-21: Average only (no harmonics)/ all data (No harmonics) / average only (w/harmonics)/ all data (w/harmonics)
Screen copy	ON/OFF (Saves the displayed screen as a BMP at a fixed interval.) The minimum interval time for saving screen copies is 5 min. If the setting is less than 5 min., screen copies will be saved every 5 min.
Waveform save	ON/OFF (Saves waveform data for each time interval in a binary format.) The shortest time interval for saving waveform data is 1 min. When set to a value less than 1 min., waveform data will be saved every minute.
Recording start method	Interval time / manual / specified time (YY/MM/DD hh:mm) / repeat (start date YY/MM/DD) Record period :00:00 to 24:00 (user-configurable) Segment folder :Off/day/week/month
Recording stop method	Manual / specified time (YY/MM/DD hh:mm) / timer (hhhh:mm:ss) / repeat (stop date YY/MM/DD) The maximum recording and measurement time is up to one year.
Folder/file name	Automatically / User-selectable (5 characters)
Quick Set at power-on	ON/OFF If ON, confirms whether to launch the Quick Set when the instrument is turned on.
Instrument Information	Displays the serial number and the software and FPGA versions.
Clock	Sets the date and time (using the Western calendar and 24-hour time).
Backlight	AUTO OFF (2 minutes)/ON AUTO OFF automatically turns off the backlight two minutes after the last key operation. After AUTO OFF operation, the backlight turns back on when any key is operated (including when the key lock is engaged).
Screen color	Screen color can be selected (color 1 / color 2 / color 3).
Beep sound	ON/OFF

12.4 Functional Specifications

Setting screen

Language	JAPANESE/ENGLISH/CHINESE/GERMAN/ITALIAN/FRENCH/ SPANISH/TURKISH/KOREAN
Phase name	R S T/A B C/L1 L2 L3/U V W
System reset	A system reset causes the instrument settings to be reset to their default values. However, the time, language, frequency, IP address, subnet mask, and default gateway are not reset.
LAN setting	IP address : 3 characters.3 characters.3 characters.3 characters (**. **. **. **) Subnet mask : 3 characters.3 characters.3 characters.3 characters (**. **. **. **) Default gateway: 3 characters.3 characters.3 characters.3 characters (**. **. **. **) MAC address : Written at time of shipment from factory.
FTP server settings	Authentication : ON/OFF User name : Up to 20 one-byte characters (When FTP Authentication is set to enable) Password : Up to 20 one-byte characters (When FTP Authentication is set to enable)
Pulse output	Output rate: OFF/1Wh/10Wh/100Wh/1kWh/10kWh/100kWh/1000kWh Pulse width: 100ms
Pulse input	Filter : On/Off Scaling : 0.001 to 100.000 Supplemental unit : p/n/ μ (u)/m/none/k/M/G/T Unit (string) : Max. 5 byte characters

Measurement screen

List	Voltage RMS value U, current RMS value I, frequency f, total active power P, total reactive power Q and apparent power S, power factor PF or displacement power factor DPF, active energy (consumption) WP+, elapsed time TIME
U/I	Voltage RMS value U, voltage fundamental wave value Ufnd, voltage waveform peak Upeak (Upk), voltage fundamental wave phase angle Udeg, current RMS value I, current fundamental wave value Ifnd, current waveform peak IPeak (Ipk), current fundamental wave phase angle Ideg
Power	Per-channel and total active power P, apparent power S, reactive power Q, power factor PF or displacement power factor DPF
Integ.	Active energy (consumption WP+, regeneration WP-), reactive energy (lag WQ+, lead WQ-), recording start time, recording stop time, elapsed time, energy cost
Demand	Can be switched to active power demand value (consumption Pdem+, regeneration Pdem-), reactive power demand value (lag QdemLAG, lead QdemLEAD), power factor demand value (PFdem), or pulse input (Pulse). Displays the maximum active power demand value (MAX_DEM) and the time at which it occurred (this information is not saved).
Harmonic (PW3360-21 only)	Graph (voltage, current, and active power levels, content percentage, phase angle) List (voltage, current, and active power levels, content percentage, phase angle)
Waveform	Displays voltage and current waveforms, voltage and current RMS values, and frequency. The vertical axis zoom factor can be set. With a 3P3W3M connection, displays the phase voltage waveform from the virtual neutral point.
Zoom	Enlarged view of 4 user-selected parameters
Trend	Select and display one measurement parameter, except demand and harmonic (other than THD) parameters. Displays maximum, average, and minimum values and allows cursor measurement.

12.4 Functional Specifications

Maximum/minimum/average value processing methods

Measurement parameter		Average value	Maximum value	Minimum value
		Blank: Arithmetic mean	Blank: Simple max. value	Blank: Simple mini. value
Voltage RMS value	U			
Current RMS value	I			
Frequency	f			
Voltage waveform peak	U _{peak}	No average value		
Current waveform peak	I _{peak}			
Active power	P		Simple maximum and minimum with polarity	
Apparent power	S			
Reactive power	Q	Signed simple average	Lag (positive data polarity)/ Lead (negative data polarity); simple maximum and minimum	
Power factor	PF	Calculated from P _{avg} and S _{avg} .	Maximum and minimum absolute value Signed data based on Lag (positive)/Lead (negative)	
Displacement power factor	DPF	Calculated from P(1) _{avg} and S(1) _{avg} .	Maximum and minimum absolute value Signed data based on Lag (positive)/Lead (negative)	
Harmonic level			For active power, simple maximum and minimum with polarity	
Harmonic content percentage		Nth harmonic average value / fundamental wave average value × 100%		
Harmonic phase angle		Vector average No average value when using current-only wiring.	Simple maximum and minimum with polarity: -180° → 0° → +180°	
Total harmonic distortion rate		Calculated from Nth harmonic average value		

File screen

SD card	Mass storage, loading settings, deleting folders/files, formatting, upgrades
Internal memory	Copying data from internal memory to the SD memory card, loading settings, deleting files, formatting

Quick Set screens

Description	Page/item	Quick Set content
Quick Set confirmation	Confirmation of whether to initialize related measurement and recording settings	
Basic settings	Wirings	1P2W / 1P3W / 3P3W2M / 3P3W3M / 3P4W* (selection)
	Frequency	No display (The frequency setting is not reset when the Quick Set is started.) Display an error if the frequency is wrong and change the frequency.
	VT ratio	No display (fixed to 1)
	Clamp sensor	9660 (100 A) / 9661 (500 A)* / 9669 (1,000 A) / 9694 (5 A) / 9695-02 (50 A) / 9695-03 (100 A) / CT9667 (500 A) / CT9667 (5,000 A)
	CT ratio	No display (fixed to 1)
	THD calculation (PW3360-21 only)	No display (THD-F)
	PF/Q/S calculation selection	No display (RMS calculation)
	Page/item	THD calculation (PW3360-21 only)
	Quick Set content	No display (THD-F)
	Save destination	SD card (disabled) Save to internal memory if no SD card has been inserted.
Time setting	Time setting	

12.4 Functional Specifications

Quick Set screens

Description	Page/item	Quick Set content
Wirings	Wirings	Connect cords to the instrument.
		Make voltage wirings. Check level, phase, and frequency values. If the frequency is wrong, display a window and ask the user whether to change the frequency setting.
		Make current wirings.
		Set the current range.
	Wiring check	Check wirings.
Recording settings	Save interval	1 / 2 / 5 / 10 / 15 / 30 sec., 1 / 2 / 5* / 10 / 15 / 20 / 30 / 60 min. Displays the available save time.
	Save items	PW3360-20: AVG only* / ALL data (maximum, minimum, and average) PW3360-21: AVG only (no Harmonic)* / ALL data (no Harmonic) / AVG only (w/Harmonic) / ALL data (w/Harmonic) No screen saving (no display) No waveform saving (no display)
	Folder/file name	Automatic* / user-selected
	Recording start method	Interval time* / manual / specified time / repeat (recording time period: fixed to 00:00 to 24:00 (no display), segment folder: fixed to off (no display))
	Recording stop method	Manual* / specified time / Timer
	Quick Set start at power-on	Does not display (off)
Recording start	Recording start confirmation	Displays the remaining save time and check start of recording.
	Standby	Reports standby status.

* Default value

External interface specifications

SD memory card interface	
Slot	SD standard compliant x 1
Compatible card	SD memory card/ SDHC memory card (Use only HIOKI-approved SD memory card)
Format	SD memory card format
Saved data	Settings data, measurement data, screen data, and waveform data

LAN interface	
Connector	RJ-45 connector x 1
Electrical specifications	IEEE802.3 compliant
Transmission method	100BASE-TX
Protocol	TCP/IP
Functions	HTTP server function FTP server function (Automatic data acquisition with FTP server, acquisition of file during saving not available, only files stored in an SD card can be downloaded)

USB interface	
Method	USB Ver.2.0 (full speed, high speed) Mass storage class, virtual COM (CDC)
Connection destination	Computer
Supported operating systems	Windows XP/ Windows Vista® (32-bit)/ Windows 7 (32-bit/64-bit) / Window 8 (32-bit/64-bit)/ Window10 (32-bit/64-bit) With latest service packs applied
Functions	When connected to a computer, the SD memory card and internal memory will be recognized as removable disks.

12.4 Functional Specifications

Pulse output	
Functions	Outputs a pulse signal proportional to active energy during integral energy measurement.
Output signal	Open collector, 30 V/5 mA max. (photocoupler-isolated) Active-low
Target	Active energy: For consumption (WP+) component only
Pulse rate	OFF / 1 Wh / 10 Wh / 100 Wh / 1 kWh / 10 kWh / 100 kWh / 1000 kWh (Default value: 1 kWh)
Pulse width	Approx. 100 ms
Connectors	One 4-terminal screwless terminal block (also used for pulse input) 1 pulse output terminal and 1 ground terminal

Pulse input	
Input specifications	No-voltage contact input (counted when terminals change from shorted to open) Voltage input (high: 2 V to 45 V; low: 0 V to 0.5 V; counted when changes to high)
Measurement range	0 to 9,999 (defined as maximum number of pulses during the save interval time)
Maximum rated input between terminals	45 V DC
Maximum rated input between terminals and ground	Not isolated (GND common with instrument)
Filter	Filter ON (mechanical contact use): Frequencies of 25 Hz or less (with high and low intervals at least 20 ms in duration) Filter OFF (electronic contact use): Frequencies of 5 kHz or less (with high and low intervals at least 100 μ s in duration)
Scaling	Values: 0.001 to 100.000 Supplemental unit: p / n / μ / m / none / k / M / G / T Unit (string): Max. 5 byte characters
Connectors	One 4-terminal screwless terminal block (also used for pulse output) 1 pulse input (positive) terminal and 1 pulse input (negative) terminal

Other functionality

Display hold	Holds displayed values but not the clock. Measurement continues internally, and readings are applied to maximum, minimum, and average values.
Key lock function	Disables all key operation, except the power switch. Turned ON and OFF by pressing and holding the ESC key for at least 3 seconds.
Power supply display	AC adapter/battery
Remaining battery display	Displays the remaining battery life (in four stages).
Warning displays	<ul style="list-style-type: none"> • Over-range: Displays over-range (over). Calculation results are used as-is internally. • Peak over: Displays a warning. • Frequency error: When the measurement line frequency differs from the set frequency (50 Hz/60 Hz), displays an error message and changes the frequency setting.
Self-check function	Checks operation when the instrument is powered on and displays a message.

12.5 Calculation Formulas

Voltage and current RMS values

Wiring setting	Single-phase 2 wire	Single-phase 3 wire		Three-phase 3 wire		Three-phase 4 wire
Item	1P2W	1P3W	1P3W1U	3P3W2M	3P3W3M	3P4W
Voltage U [Vrms]	U_I	U_1 U_2	U_1	U_1 U_2 U_{12} $(U_{12s}=U_{1s}-U_{2s})$	$U_1 (U_{1s}=u_{1s}-u_{2s})$ $U_2 (U_{2s}=u_{2s}-u_{3s})$ $U_3 (U_{3s}=u_{3s}-u_{1s})$	U_1 U_2 U_3
	$U_c = \sqrt{\frac{1}{M} \sum_{s=0}^{M-1} (U_{cs})^2}$					
<ul style="list-style-type: none"> For 3P3W2M connections, it is assumed that $U_{1s} - U_{2s} - U_{12s} = 0$. For 3P3W3M connections, the phase voltage u is measured from the virtual neutral point and used to calculate the line-to-line voltage. 						
Current I [Arms]	I_1	I_1 I_2	I_1 I_2 I_{12} $(I_{12s}=-I_{1s}-I_{2s})$	I_1 I_2 I_3	I_1 I_2 I_3	I_1 I_2 I_3
	$I_c = \sqrt{\frac{1}{M} \sum_{s=0}^{M-1} (I_{cs})^2}$					
<ul style="list-style-type: none"> For 3P3W2M, it is assumed that $I_{1s} + I_{2s} + I_{12s} = 0$. 						

* Subscript c: measurement channel; M: number of sample points; s: sample point number

Active power

Wiring setting	Single-phase 2 wire	Single-phase 3 wire		Three-phase 3 wire		Three-phase 4 wire
Item	1P2W	1P3W	1P3W1U	3P3W2M	3P3W3M	3P4W
Active power P [W]	P_1	P_1 P_2	P_1 $P_2 = \frac{1}{M} \sum_{s=0}^{M-1} (-U_{1s} \times I_{2s})$	P_1 P_2	P_1 P_2 P_3	P_1 P_2 P_3
	$P_c = \frac{1}{M} \sum_{s=0}^{M-1} (U_{cs} \times I_{cs})$					
<ul style="list-style-type: none"> The active power P polarity symbols indicate the direction of current flow as either consumption (+P) or regeneration (-P). 						
$P = P_1 + P_2$						

* Subscript c: measurement channel; M: number of sample points; s: sample point number

Reactive power

Wiring setting	Single-phase 2 wire	Single-phase 3 wire		Three-phase 3 wire		Three-phase 4 wire	
Item	1P2W	1P3W	1P3W1U	3P3W2M	3P3W3M	3P4W	
Reactive power Q [var]	Q_1	Q_1 Q_2		Q_1 Q_2 Q_3			
	PF/Q/S (RMS calculation) $Q_c = \text{si} \sqrt{S_c^2 - P_c^2}$	$Q = \text{si} \sqrt{S^2 - P^2}$					
	<ul style="list-style-type: none"> When $S < P$ due to the effects of measurement error, unbalance, or other factors, $S = P$ and $Q = 0$. The component si indicates lag and lead. The sign of reactive power Q (fundamental wave reactive power) is used. Positive sign: Lag [Display indicates LAG, and output data is positive.] Negative sign: Lead [Display indicates LEAD, and output data is negative.] 						
	Q_1	Q_1 Q_2	Q_1 $Q_2 = U_{1(1)r} \times I_{2(1)i}$ $-U_{1(1)i} \times I_{2(1)r}$	Q_1 Q_2	Q_1 Q_2 Q_3		
	PF/Q/S (fundamental wave calculation) $Q_c = -U_{c(1)r} \times I_{c(1)i}$ $+U_{c(1)i} \times I_{c(1)r}$	$Q = Q_1 + Q_2$		$Q = Q_1 + Q_2 + Q_3$			
	<ul style="list-style-type: none"> This reactive power Q is defined as the fundamental wave reactive power. (1): Harmonic calculation fundamental wave (1st order) r: Post-FFT resistance component; i: post-FFT reactance component Positive sign: Lag [Display indicates LAG, and output data is positive.] Negative sign: Lead [Display indicates LEAD, and output data is negative.] 						

* Subscript c: measurement channel

Apparent power

Wiring setting	Single-phase 2 wire	Single-phase 3 wire		Three-phase 3 wire		Three-phase 4 wire	
Item	1P2W	1P3W	1P3W1U	3P3W2M	3P3W3M	3P4W	
Apparent power S [VA]	S_1	S_1 S_2	S_1 $S_2 = U_1 \times I_2$	S_1 S_2 S_3	$S_1 = u_1 \times I_1$ $S_2 = u_2 \times I_2$ $S_3 = u_3 \times I_3$	S_1 S_2 S_3	
	PF/Q/S (RMS calculation) $S_c = U_c \times I_c$	$S = S_1 + S_2$		$S =$ $\frac{\sqrt{3}}{3}(S_1 + S_2 + S_3)$	$S =$ $\frac{\sqrt{3}}{3}(U_1 I_1 + U_2 I_2 + U_3 I_3)$	$S = S_1 + S_2 + S_3$	
	• The phase voltage is used to calculate S_1 , S_2 , and S_3 for 3P3W3M connections. The line-to-line voltage is used to calculate total S .						
	S_1	S_1 S_2			S_1 S_2 S_3		
	PF/Q/S (fundamental wave calculation) $S_c = \sqrt{P_{c(1)}^2 + Q_{c(1)}^2}$	$S = \sqrt{P_{(1)}^2 + Q_{(1)}^2}$					
<ul style="list-style-type: none"> This reactive power S is defined as the fundamental wave reactive power. (1): Harmonic calculation fundamental wave (1st order) 							

* Subscript c: measurement channel

Power factor, Displacement power factor

Wiring setting	Single-phase 2 wire	Single-phase 3 wire		Three-phase 3 wire		Three-phase 4 wire
Item	1P2W	1P3W	1P3W1U	3P3W2M	3P3W3M	3P4W
Power factor PF	PF_1	PF_1 PF_2		PF_1 PF_2 PF_3		
	$PF_c = \text{si} \left \frac{P_c}{S_c} \right $	$PF = \text{si} \left \frac{P}{S} \right $				
PF/Q/S (RMS calculation)	<ul style="list-style-type: none"> The component si indicates lag and lead. The sign of reactive power Q (fundamental wave reactive power) is used. Positive sign: Lag [Display indicates LAG, and output data is positive.] Negative sign: Lead [Display indicates LEAD, and output data is negative.] When $S < P$ due to the effects of measurement error, unbalance, or other factors, $S = P$ and $PF = 1$. When $S = 0$, PF is determined as invalid data. 					

Power factor, Displacement power factor

Wiring setting	Single-phase 2 wire	Single-phase 3 wire		Three-phase 3 wire		Three- phase 4 wire
Item	1P2W	1P3W	1P3W1U	3P3W2M	3P3W3M	3P4W
Displacement power factor <i>DPF</i>	DPF_1	DPF_1 DPF_2		DPF_1 DPF_2 DPF_3		
<i>DPF</i>	$DPF_c = \text{si} \left \frac{P_{c(1)}}{S_{c(1)}} \right $			$DPF = \text{si} \left \frac{P_{(1)}}{S_{(1)}} \right $		
PF/Q/S (fundamental wave calculation)	<ul style="list-style-type: none"> The component si indicates lag and lead. The sign of reactive power Q (fundamental wave reactive power) is used. Positive sign: Lag [Display indicates LAG, and output data is positive.] Negative sign: Lead [Display indicates LEAD, and output data is negative.] (1): Harmonic calculation fundamental wave (1st order) When $S_{c(1)} = 0$, DPF is determined as invalid data. 					

* Subscript c: measurement channel

Electric energy, Energy cost

Wiring setting	Single-phase 2 wire	Single-phase 3 wire		Three-phase 3 wire		Three- phase 4 wire
Item	1P2W	1P3W	1P3W1U	3P3W2M	3P3W3M	3P4W
Active energy (consumption) <i>WP+</i> [Wh]	$WP+ = k \sum_1^h P (+)$ <ul style="list-style-type: none"> k: Calculation unit time [h]; h: measurement duration P(+): Only the consumption component of active power (positive component) is used. 					
Active energy (Regeneration) <i>WP-</i> [Wh]	$WP- = k \sum_1^h P (-)$ <ul style="list-style-type: none"> k: Calculation unit time [h]; h: measurement duration P(-): Only the regeneration component of active power (negative component) is used. 					
Reactive energy (Lag) <i>WQ_LAG</i> [varh]	$WQ_LAG = k \sum_1^h Q (LAG)$ <ul style="list-style-type: none"> k: Calculation unit time [h]; h: measurement duration Q(LAG): Only the lag component of reactive power is used. 					
Active energy (Lead) <i>WQ_LEAD</i> [varh]	$WQ_LEAD = k \sum_1^h Q (LEAD)$ <ul style="list-style-type: none"> k: Calculation unit time [h]; h: measurement duration Q(LEAD): Only the lead component of reactive power is used. 					
Energy cost <i>Ecost</i> [User-specified units]	$Ecost = WP+ \times rate$ <ul style="list-style-type: none"> <i>WP+</i>: Uses active energy consumption only. rate: Unit cost (User-specified setting from 0.00000 to 99999.9/kWh) 					

12.5 Calculation Formulas

Demand quantity (output data only; not displayed)

Wiring setting	Single-phase 2 wire	Single-phase 3 wire		Three-phase 3 wire		Three-phase 4 wire
Item	1P2W	1P3W	1P3W1U	3P3W2M	3P3W3M	3P4W
Active power demand quantity (consumption) $WP+dem$ [Wh]	$WP+dem = k \sum_1^h P(+)$ <ul style="list-style-type: none"> k: Calculation unit time [h]; h: interval duration P(+): Only the consumption component of active power (positive component) is used. 					
Active power demand quantity (Regeneration) $WP-dem$ [Wh]	$WP-dem = k \sum_1^h P(-)$ <ul style="list-style-type: none"> k: Calculation unit time [h]; h: interval duration P(-): Only the regeneration component of active power (negative component) is used. 					
Reactive power demand quantity (Lag) $WQLAGdem$ [varh]	$WQLAGdem = k \sum_1^h Q(LAG)$ <ul style="list-style-type: none"> k: Calculation unit time [h]; h: interval duration Q(LAG): Only the lag component of reactive power is used. 					
Reactive power demand quantity (Lead) $WQLEADdem$ [varh]	$WQLEADdem = k \sum_1^h Q(LEAD)$ <ul style="list-style-type: none"> k: Calculation unit time [h]; h: interval duration Q(LEAD): Only the lead component of reactive power is used. 					

Demand value, Pulse input

Wiring setting	Single-phase 2 wire	Single-phase 3 wire		Three-phase 3 wire		Three-phase 4 wire
Item	1P2W	1P3W	1P3W1U	3P3W2M	3P3W3M	3P4W
Active power demand value (consumption) P_{dem+} [W]	$P_{dem+} = \frac{1}{h} \sum_1^h P(+)$ <ul style="list-style-type: none"> h: Interval duration P(+): Only the consumption component of active power (positive component) is used. 					
Active power demand value (regeneration) P_{dem-} [W]	$P_{dem-} = \frac{1}{h} \sum_1^h P(-)$ <ul style="list-style-type: none"> h: Interval duration P(-): Only the regeneration component of active power (negative component) is used. 					
Reactive power demand value (Lag) Q_{dem_LAG} [var]	$Q_{dem_LAG} = \frac{1}{h} \sum_1^h Q(LAG)$ <ul style="list-style-type: none"> h: Interval duration Q(LAG): Only the lag component of reactive power is used. 					
Reactive power demand value (Lead) Q_{dem_LEAD} [var]	$Q_{dem_LEAD} = \frac{1}{h} \sum_1^h Q(LEAD)$ <ul style="list-style-type: none"> h: Interval duration Q(LEAD): Only the lead component of reactive power is used. 					
Power factor demand value PF_{dem} []	$PF_{dem} = \frac{P_{dem+}}{\sqrt{(P_{dem+})^2 + (Q_{dem_LAG})^2}}$					
Pulse input P_{in} [Unit: user-specified]	$P_{in} = \text{Pulse} \times S_c$ <ul style="list-style-type: none"> Pulse: Pulse input count value during the interval duration Sc: Scaling setting (user-specified, 0.001 to 100.000) 					

12.5 Calculation Formulas

Harmonic voltage, current, and power (PW3360-21 only)

Item	Wiring setting	Single-phase 3 wire		Three-phase 3 wire		Three-phase 4 wire
		1P2W	1P3W	1P3W1U	3P3W2M	3P3W3M
Voltage U_{ck} [Vrms]	U_{1k}	U_{1k}	U_{1k}	U_{1k}	U_{1k}	U_{1k}
	$U_{ck} = \sqrt{U_{ckr}^2 + U_{cki}^2}$	U_{2k}	U_{1k}	U_{1k}	U_{1k}	U_{2k}
<ul style="list-style-type: none"> When using 3P3W3M wiring, the phase voltage is used. Harmonic voltage content percentage (%): $U_{ck} = U_{ck}/U_{c1} \times 100$ (%) 						
Current I_{ck} [Arms]	I_{1k}	I_{1k}	I_{1k}	I_{1k}	I_{1k}	I_{1k}
	$I_{ck} = \sqrt{I_{ckr}^2 + I_{cki}^2}$	I_{2k}	I_{1k}	I_{2k}	I_{1k}	I_{2k}
<ul style="list-style-type: none"> Harmonic current content percentage (%): $I_{ck} = I_{ck}/I_{c1} \times 100$(%) 						
Active power P_{ck} [W]	P_{1k}	P_{1k}	P_{1k}	P_{1k}	P_{1k}	P_{1k}
	$P_{ck} = U_{ckr} \times I_{ckr} + U_{cki} \times I_{cki}$	P_{2k}	$P_{2k} = -U_{1kr} \times I_{2kr} - U_{1ki} \times I_{2ki}$	$P_{2k} =$	P_{1k}	P_{2k}
<ul style="list-style-type: none"> Harmonic power content percentage (%): $P_{ck} = P_{ck}/P_{c1} \times 100$(%) Although P_{1k} and P_{2k} values for 3P3W2M wiring are used in internal calculations, they are not displayed. 						
Reactive power Q_{ck} [var]	Q_{1k}	Q_{1k}	Q_{1k}	Q_{1k}	Q_{1k}	Q_{1k}
	$Q_{ck} = U_{ckr} \times I_{cki} - U_{cki} \times I_{ckr}$	Q_{2k}	$Q_{2k} = -U_{1kr} \times I_{2ki} + U_{1ki} \times I_{2kr}$	$Q_{2k} =$	Q_{1k}	Q_{2k}
<ul style="list-style-type: none"> Although Q_{ck} values are used in internal calculations, they are not displayed. 						

* Subscript c: measurement channel, k: order being analyzed; r: resistance after FFT; i: reactance after FFT

Harmonic phase angle (PW3360-21 only)

Item	Wiring setting	Single-phase 3 wire		Three-phase 3 wire		Three-phase 4 wire
	Single-phase 2 wire	1P3W	1P3W1U	3P3W2M	3P3W3M	3P4W
Voltage phase angle φU_{ck} (phase_Uc) [deg.]	φU_{1k}	φU_{1k} φU_{2k}	φU_{1k}	φU_{1k} φU_{2k}	φU_{1k} φU_{2k} φU_{3k}	φU_{1k} φU_{2k} φU_{3k}
	$\tan^{-1}\left(\frac{U_{ckr}}{-U_{cki}}\right)$					
<ul style="list-style-type: none"> The harmonic voltage phase angle is corrected and displayed using the U_1 fundamental wave as 0°. When using 3P3W3M wiring, the fundamental wave of the phase voltage u_1 is used as 0°. When $U_{ckr}=U_{cki}=0$, $\varphi U_{ck}=0^\circ$ 						
Current phase angle φI_{ck} (phase_Ic) [deg.]	φI_{1k}	φI_{1k} φI_{2k}		φI_{1k} φI_{2k} φI_{3k}		φI_{1k} φI_{2k} φI_{3k}
	$\tan^{-1}\left(\frac{I_{ckr}}{-I_{cki}}\right)$					
<ul style="list-style-type: none"> The harmonic current phase angle is corrected and displayed using the U_1 fundamental wave as 0°. When using current-only wiring, the phase angle is corrected and displayed using the I_1 fundamental wave as 0°. When $I_{ckr}=I_{cki}=0$, $\varphi I_{ck}=0^\circ$ 						
Power phase angle φP_{ck} (phase_Pc) [deg.]	φP_{1k}	φP_{1k} φP_{2k}		φP_{1k} φP_{2k} φP_{3k}		φP_{1k} φP_{2k} φP_{3k}
	$\tan^{-1}\left(\frac{Q_{ck}}{P_{ck}}\right)$					
When $P_{ck}=Q_{ck}=0$, $\varphi P_{ck}=0^\circ$						

* Subscript c: measurement channel, k: order being analyzed; r: resistance after FFT; i: reactance after FFT

12.5 Calculation Formulas

Total harmonic distortion (PW3360-21 only)

Item	Wiring setting	Single-phase 2 wire	Single-phase 3 wire		Three-phase 3 wire		Three-phase 4 wire
		1P2W	1P3W	1P3W1U	3P3W2M	3P3W3M	3P4W
Total harmonic distortion-F THD-F _{U_c} [%]	THD-F _{U₁}	$\frac{\sqrt{\sum_{k=2}^{40} (U_{ck})^2}}{U_{C1}} \times 100 \text{ (%)}$	THD-F _{U₁} THD-F _{U₂}	THD-F _{U₁}	THD-F _{U₁} THD-F _{U₂}		THD-F _{U₁} THD-F _{U₂} THD-F _{U₃}
	<ul style="list-style-type: none"> When using 3P3W3M wiring, the phase voltage is used. 						
Total harmonic distortion-F THD-F _{I_c} [%]	THD-F _{I₁}	$\frac{\sqrt{\sum_{k=2}^{40} (I_{ck})^2}}{I_{C1}} \times 100 \text{ (%)}$			THD-F _{I₁} THD-F _{I₂}		THD-F _{I₁} THD-F _{I₂} THD-F _{I₃}
Total harmonic distortion-R THD-R _{U_c} [%]	THD-R _{U₁}	$\frac{\sqrt{\sum_{k=2}^{40} (U_{ck})^2}}{\sqrt{\sum_{k=1}^{40} (U_{ck})^2}} \times 100 \text{ (%)}$	THD-R _{U₁} THD-R _{U₂}	THD-R _{U₁}	THD-R _{U₁} THD-R _{U₂}		THD-R _{U₁} THD-R _{U₂} THD-R _{U₃}
Total harmonic distortion-R THD-R _{I_c} [%]	THD-R _{I₁}	$\frac{\sqrt{\sum_{k=2}^{40} (I_{ck})^2}}{\sqrt{\sum_{k=1}^{40} (I_{ck})^2}} \times 100 \text{ (%)}$			THD-R _{I₁} THD-R _{I₂}		THD-R _{I₁} THD-R _{I₂} THD-R _{I₃}

* Subscript c: measurement channel, k: order being analyzed

12.6 Range Configuration and Accuracy by Clamp Sensor

- NOTE**
- The range-configuration table shows the full-scale display value of each measurement range.
 - Voltage measurements is indicated as 5 V to 1000 V. If a measurement is below 5 V, it will be displayed as the value zero.
 - Current measurements is indicated as 0.4% to 130% f.s. of the range. If a measurement is below 0.4% f.s., it will be displayed as the value zero.
 - Power measurement is indicated as 0% to 130% f.s. of the range. It will be displayed as the value zero when the voltage or current is zero.
 - The range configuration for apparent power (S) and reactive power (Q) is the same, except that the unit is changed to VA and var, respectively.
 - When the VT ratio and CT ratio are set, the ranges will be multiplied by (VT ratio x CT ratio) (when a power range falls below 1.0000 mW or exceeds 9.9999 GW and a current range falls less than 1 mA, a scaling error occurs and the setting is not accepted).

12.6 Range Configuration and Accuracy by Clamp Sensor

When the 9660, 9661, or 9695-03 is Used

Power ranges

Voltage	Wiring	Current range				
		5.0000 A	10.000 A	50.000 A	100.00 A	500.00 A
600.00 V	1P2W	3.0000 kW	6.0000 kW	30.000 kW	60.000 kW	300.00 kW
	1P3W 1P3W1U 3P3W2M 3P3W3M	6.0000 kW	12.000 kW	60.000 kW	120.00 kW	600.00 kW
	3P4W	9.0000 kW	18.000 kW	90.000 kW	180.00 kW	900.00 kW

*The 500.00 A range is only available with the 9661 Clamp on Sensor.

Combined accuracy

Current range	Model 9660 sensor Model 9695-03 sensor	Model 9661 sensor
500.00 A	-	±0.6%rdg.±0.11%f.s.
100.00 A	±0.6%rdg.±0.12%f.s.	±0.6%rdg.±0.15%f.s.
50.000 A	±0.6%rdg.±0.14%f.s.	±0.6%rdg.±0.2%f.s.
10.000 A	±0.6%rdg.±0.3%f.s.	±0.6%rdg.±0.6%f.s.
5.0000 A	±0.6%rdg.±0.5%f.s.	±0.6%rdg.±1.1%f.s.

When the 9669 is Used

Power ranges

Voltage	Wiring	Current range		
		100.00 A	200.00 A	1.0000 kA
600.00 V	1P2W	60.000 kW	120.00 kW	600.00 kW
	1P3W 1P3W1U 3P3W2M 3P3W3M	120.00 kW	240.00 kW	1.2000 MW
	3P4W	180.00 kW	360.00 kW	1.8000 MW

Combined accuracy

Current range	Model 9669 sensor
1.0000 kA	±1.3%rdg.±0.11%f.s.
200.00 A	±1.3%rdg.±0.15%f.s.
100.00 A	±1.3%rdg.±0.2%f.s.

12.6 Range Configuration and Accuracy by Clamp Sensor

When the 9694 or 9695-02 is used (CAT III, 300 V)

Power ranges

Voltage	Wiring	Current range				
		500.00 mA	1.0000 A	5.0000 A	10.000 A	50.000 A
600.00 V	1P2W	300.00W	600.00W	3.0000kW	6.0000kW	30.000kW
	1P3W 1P3W1U 3P3W2M 3P3W3M	600.00W	1.2000kW	6.0000kW	12.000kW	60.000kW
	3P4W	900.00W	1.8000kW	9.0000kW	18.000kW	90.000kW

*Accuracy is guaranteed for 500 mA to 5 A ranges (9694) and for 500 mA to 50 A ranges (Model 9695-02).

Combined accuracy

Current range	Model 9694 sensor	Model 9695-02 sensor
50.000 A	-	$\pm 0.6\% \text{rdg.} \pm 0.12\% \text{f.s.}$
10.000 A	-	$\pm 0.6\% \text{rdg.} \pm 0.2\% \text{f.s.}$
5.0000 A	$\pm 0.6\% \text{rdg.} \pm 0.12\% \text{f.s.}$	$\pm 0.6\% \text{rdg.} \pm 0.3\% \text{f.s.}$
1.0000 A	$\pm 0.6\% \text{rdg.} \pm 0.2\% \text{f.s.}$	$\pm 0.6\% \text{rdg.} \pm 1.1\% \text{f.s.}$
500.00 mA	$\pm 0.6\% \text{rdg.} \pm 0.3\% \text{f.s.}$	$\pm 0.6\% \text{rdg.} \pm 2.1\% \text{f.s.}$

When the CT9667 is Used

Power ranges

Voltage	Wiring	500A range			5000A range		
		50.000 A	100.00 A	500.00 A	500.00 A	1.0000 kA	5.0000 kA
600.00 V	1P2W	30.000 kW	100.00 A	300.00kW	300.00 kW	600.00 kW	3.0000MW
	1P3W 1P3W1U 3P3W2M 3P3W3M	60.000 kW	120.00 kW	600.00kW	600.00 kW	1.2000 MW	6.0000MW
	3P4W	90.000 kW	180.00 kW	900.00kW	900.00 kW	1.8000 MW	9.0000MW

Combined accuracy

Current range	Model CT9667 sensor 5000A range	Model CT9667 sensor 500A range
5.0000 kA	$\pm 2.3\% \text{rdg.} \pm 0.4\% \text{f.s.}$	-
1.0000 kA	$\pm 2.3\% \text{rdg.} \pm 1.6\% \text{f.s.}$	-
500.00 A	$\pm 2.3\% \text{rdg.} \pm 3.1\% \text{f.s.}$	$\pm 2.3\% \text{rdg.} \pm 0.4\% \text{f.s.}$
100.00 A	-	$\pm 2.3\% \text{rdg.} \pm 1.6\% \text{f.s.}$
50.000 A	-	$\pm 2.3\% \text{rdg.} \pm 3.1\% \text{f.s.}$

12.7 Model PW9003 Voltage Line Power Adapter

Input terminal	Banana input terminal Connect the L9438-53 voltage Cords (2) that come with the PW3360.
Output cord	Connect the two banana leads (connect to the PW3360's voltage input terminals and supply the measurement voltage) and one AC adapter connection cord (connect to the Z1006 AC Adapter that comes with the PW3360 and supply power).
Operating environment	Indoors, Pollution degree 2, altitude up to 2,000 m (6562-ft.)
Rated voltage	AC240 V
Rated current	AC3.15 A
Maximum rated voltage to earth	300 V Measurement Categories III (anticipated transient overvoltage 4000 V)
Dielectric strength (50 Hz /60 Hz, 60 minutes)	4.29 kVrms (1 mA sense current) Between power supply pins and case
Operating temperature and humidity	-10°C to 50°C (14°F to 122°F), 80%RH or less (non-condensating)
Storage temperature and humidity	-20°C to 60°C (-4°F to 140°F), 80%RH or less (non-condensating)
Dimensions	Case: Approx. 125W×50H×36D mm (4.92"W×1.97"H×1.42"D, excluding protruding parts) Cord length: PW3360 voltage input terminal connection side; Approx. 380 mm (14.96") AC adapter connection side; Approx. 380 mm (14.96")
Mass	Approx. 180 g (6.3 oz.)
Applicable standards	Safety EN61010 Pollution degree 2

Maintenance and Service

Chapter 13

13.1 Trouble Shooting

Replaceable Parts and Operating Lifetimes

Properties of some parts used in the instrument may deteriorate after a long-term use. The regular replacement of those parts is recommended to use the instrument properly for a long time. For the replacement of the parts, please contact your authorized Hioki distributor or reseller. The useful lives of the parts depend on the operating environment and frequency of use. Operation cannot necessarily be guaranteed for the following recommended replacement period of each part.

Part	Life	Remarks
Lithium battery	Approx. 10 years	The instrument contains a built-in backup lithium battery, which offers a service life of about ten years. If the date and time deviate substantially when the instrument is switched on, it is the time to replace that battery. Contact your authorized Hioki distributor or reseller.
Electrolytic Capacitors	Approx. 10 years	The service life of electrolytic capacitors varies with the operating environment. Requires periodic replacement.
LCD backlight (50% drop-off in brightness)	Approx. 50,000 hours	Requires periodic replacement.
Model 9459 Battery Pack	Approx. 1 year or approx. 500 charge/recharge cycles	Requires periodic replacement.
Model Z4001 SD Memory Card 2 GB	Data storage of approx. 10 years or approx. 2 million rewrites	The SD memory card service life varies with the manner in which it is are used. Requires periodic replacement.

The fuse is housed in the power unit of the instrument. If the power does not turn on, the fuse may be blown. If this occurs, a replacement or repair cannot be performed by customers. Please contact your authorized Hioki distributor or reseller.

If damage is suspected

If damage is suspected, check the "Before Having the Instrument Repaired" (p. 219) section before contacting your authorized Hioki distributor or reseller.

Calibrations

IMPORTANT

Periodic calibration is necessary in order to ensure that the instrument provides correct measurement results of the specified accuracy.

The calibration frequency varies depending on the status of the instrument or installation environment. We recommend that the calibration frequency is determined in accordance with the status of the instrument or installation environment and that you request that calibration be performed periodically.

Precautions when transporting the instrument

- When sending the instrument for repair, remove the battery pack and SD memory card carefully to prevent damage in transit. Include cushioning material so the instrument cannot move within the package.
- Include a description of existing damage. We do not take any responsibility for damage incurred during shipping.

Storage

NOTE To prevent battery pack deterioration when it will not be used for a long time, remove the battery pack from the instrument.

Before Having the Instrument Repaired

Before returning for repair

Symptom	Check Item, or Cause	Remedy and Reference
The display does not appear when you turn the power on.	If powering the instrument with the AC adapter <ul style="list-style-type: none"> • Are the power cord and AC adapter properly connected? 	Verify that the power cord or AC adapter is connected properly. See: 2.5, "Supplying the Power" (p. 36)
	If powering the instrument with the battery <ul style="list-style-type: none"> • Has the PW9002 Battery Set (9459 Battery Pack) been properly installed? • Has the battery pack been charged? 	Verify that the battery pack has been charged and installed. See: "Installing (replacing) the Battery Pack" (p. 27)
Keys do not work.	<ul style="list-style-type: none"> • Has the key lock been activated? 	Press and hold the ESC key for at least 3 seconds to cancel the key lock.
Voltage or current measured values are not being displayed.	<ul style="list-style-type: none"> • Are the voltage cords or clamp sensors connected improperly? • Are the input channels and display channels incorrect? • Has an appropriate current range been selected? 	Check the wirings and wiring settings. See: 3.3, "Connecting the Voltage Cords" (p. 52) to 3.9, "Verifying Correct Wiring (Wiring Check)" (p. 63)

13.1 Trouble Shooting

Symptom	Check Item, or Cause	Remedy and Reference
Measured values do not stabilize.	<ul style="list-style-type: none"> Is the frequency of the lines being measured 50 or 60 Hz? The instrument does not support 400 Hz frequency lines. 	The instrument can only be used with 50/60 Hz lines. Lines operating at 400 Hz cannot be measured.
	<ul style="list-style-type: none"> If the wiring setting is 1P2W/1P3W/3P3W/3P4W, is voltage input being supplied? The instrument may not be able to perform stable measurement without voltage input. 	If not measuring voltage, select the current-only wiring and set the frequency setting to the measurement line frequency (50/60 Hz). See: 4.3, "Changing Recording (Save) Settings" (p. 75)
Unable to charge the 9459 Battery Pack (the Charge LED does not light up).	<ul style="list-style-type: none"> Verify that the ambient temperature is within the range of 10°C to 40°C. 	The instrument's battery can be charged within the ambient temperature range of 10°C to 40°C. See: "Installing (replacing) the Battery Pack" (p. 27)
	<ul style="list-style-type: none"> Has the instrument been stored for an extended period of time with the battery pack installed? 	The battery pack may have degraded, signaling that it needs to be replaced. Please purchase a new battery pack. Contact your Hioki distributor for more information. If the instrument will not be used for one month or longer, remove the battery pack and store at -20°C to 30°C.
The battery pack can only be used for a short period of time.	<ul style="list-style-type: none"> The battery pack's capacity may have deteriorated due to degradation. 	See: "Installing (replacing) the Battery Pack" (p. 27)

If the cause of the issue remains unclear, reset the system. Doing so will initialize settings to their factory defaults.

See: 4.5, "Initializing the Instrument (System Reset)" (p. 86)

13.2 Cleaning

Instrument and the PW9003 Voltage Line Power Adapter

- To clean the instrument and the PW9003, wipe it gently with a soft cloth moistened with water or mild detergent. Never use solvents such as benzene, alcohol, acetone, ether, ketones, thinners or gasoline, as they can deform and discolor the case.
- Wipe the LCD gently with a soft, dry cloth.

Clamp Sensor

Measurements are degraded by dirt on the mating surfaces of the clamp-on sensor, so keep the surfaces clean by gently wiping with a soft cloth.

13.3 Error Indication

Error indications except system errors can be canceled out by pressing any key.

System error

Error display	Cause	Solution/more information
*** SYSTEM ERROR *** The internal programming of the PW3360 is corrupted and the instrument must be repaired.	A program failure has occurred.	The instrument needs to be repaired. Contact your authorized Hioki distributor or reseller.
*** SYSTEM ERROR *** The SDRAM of the PW3360 is corrupted and the instrument must be repaired.	A memory failure has occurred.	
*** SYSTEM ERROR *** The adjustment values of the PW3360 are corrupted and the instrument must be repaired.	An adjustment value failure has occurred.	
*** SYSTEM ERROR *** The display memory of the PW3360 is corrupted and the instrument must be repaired.	A display memory failure has occurred.	
*** SYSTEM ERROR *** BACKUP ERROR. The PW3360 must be returned to default factory condition. Initialize? YES: ENTER key	Backed up system variables are incorrect or contradictory.	Initialize and reconfigure the settings. If you experience backup errors frequently, the backup battery may have deteriorated. The instrument needs to be repaired. Contact your authorized Hioki distributor or reseller.

13.3 Error Indication

Error

Error display	Cause	Solution/more information
*** ERROR *** Invalid key	While the Quick Set is running, you cannot switch to the Measurement, Settings, File, or Wirings screen.	Press the F4 [STOP QS] key to exit the Quick Set and then perform your desired operation.
*** ERROR *** START avail. only in MEAS screen.	Recording can only be started on the Measurement screen.	Press the Start/Stop key on the Measurement screen to start recording.
*** ERROR *** STOP avail. only in MEAS screen.	Recording can only be stopped on the Measurement screen.	Press the Start/Stop key on the Measurement screen to stop recording.
*** ERROR *** Invalid setting value.	You attempted to configure the setting with a value that is outside the valid setting range.	Configure the setting with a value that falls within the valid setting range. See: Chapter 4, "Changing Settings" (p. 67)
*** ERROR *** Scaling error.	The VT and CT ratios were configured so that the power range exceeded 1 mW to 9.9999 GW.	Set the VT and CT ratios so that the power range falls within 1 mW to 9.9999 GW. See: 12.6, "Range Configuration and Accuracy by Clamp Sensor" (p. 213)
*** ERROR *** Only PW3360 folders can be opened.	You cannot move higher up in the folder hierarchy than the root on the SD memory card (by pressing the left arrow key).	Select a folder or file with the up and down arrow keys and switch folders by pressing the right arrow key or the Enter key. See: 8.1, "Viewing and Using the File Screen" (p. 118)

Operation error

Error display	Cause	Solution/more information
*** OPERATION ERROR *** This folder cannot be deleted.	You attempted to delete the [PW3360] basic folder.	The [PW3360] basic folder cannot be deleted. If you wish to delete it, you must do so on a computer.
*** OPERATION ERROR *** Cannot modify settings while in STANDBY.	You attempted to change a setting that cannot be changed while the instrument is in the recording standby state.	If you need to change the setting, cancel the recording standby state with the Start/Stop key on the Measurement screen.
*** OPERATION ERROR *** Cannot modify settings while recording is in progress.	You attempted to change a setting that cannot be changed during recording and measurement.	If you need to change the setting, stop the recording measurement with the Start/Stop key on the Measurement screen.

File error

Error display	Cause	Solution/more information
*** FILE ERROR *** Save failed.	The instrument was unable to save data due to a problem with the SD memory card.	Format the SD memory card. See: 8.8, "Formatting the SD Memory Card or Internal Memory" (p. 132)
	The instrument was unable to save data due to a problem with its internal memory.	Format the internal memory. See: 8.8, "Formatting the SD Memory Card or Internal Memory" (p. 132)
*** FILE ERROR *** Load failed.	The instrument was unable to load settings data due to a problem with the settings file.	Create a new settings file and load it. See: 8.4, "Saving Settings Files" (p. 127)
*** FILE ERROR *** File or folder could not be deleted.	The SD memory card is in the locked (write-protected) state, or the file or folder attribute is set to "read-only."	If the SD memory card is locked, unlock it. If the file or folder attribute is set to "read-only," change the attribute using a computer.
*** FILE ERROR *** The file with the same name exists.	The instrument was unable to copy data from its internal memory to the SD memory card because data with the same filename already existed on the SD memory card.	Delete the data with the same filename from the SD memory card or change the filename using a computer.
*** FILE ERROR *** Formatting failed.	An SD memory card error occurred, or the card was ejected, during formatting.	Reinsert the SD memory card and format it again. If unable to format the card, the card may be damaged and should be replaced.
	An internal memory error occurred.	The instrument needs to be repaired. Contact your authorized Hioki distributor or reseller.
*** FILE ERROR *** No settings file. Select a settings file.	The instrument was unable to load the settings because the selected file is not a settings file.	Select a settings file (extension of .SET).
*** FILE ERROR *** Maximum files reached. Additional files cannot be created.	The maximum number of files and folders that can be created was exceeded.	Switch SD memory cards. Alternately, make a backup of the SD memory card using a computer, delete unnecessary data on the card, and format it. See: 8.6, "Copying Internal Memory Files to the SD Memory Card" (p. 130) 8.7, "Deleting Folders and Files" (p. 131)

SD card error

Error display	Cause	Solution/more information
<p>*** SD CARD ERROR *** SD Card not found. Insert an SD Card.</p>	<p>Data cannot be saved to the SD memory card because no SD memory card has been inserted into the instrument.</p>	<p>Insert an SD memory card. See: 2.4, "Inserting (Removing) an SD Memory Card" (p. 33)</p>
<p>*** SD CARD ERROR *** SD Card is not formatted for this device.</p>	<p>The SD memory card has not been formatted with the dedicated SD format.</p>	<p>Format the card with the instrument. See: 8.8, "Formatting the SD Memory Card or Internal Memory" (p. 132)</p>
<p>*** SD CARD ERROR *** SD Card not compatible.</p>	<p>An unsupported card such as an SDXC memory card was inserted into the instrument.</p>	<p>Use the instrument's optional SD memory card.</p>
<p>*** SD CARD ERROR *** SD Card locked. Unlock the SD Card.</p>	<p>The SD memory card is in the locked (write-protected) state.</p>	<p>Unlock the SD memory card. See: 2.4, "Inserting (Removing) an SD Memory Card" (p. 33)</p>
<p>*** SD CARD ERROR *** Data has been backed up to internal memory.</p>	<p>Data will be saved to the instrument's internal memory if no SD memory card has been inserted or the SD memory card is full while performing recording and measurement with the save destination set to "SD card."</p>	<p>Insert an SD memory card or switch cards.</p>
<p>*** SD CARD ERROR *** SD Card is full. Delete files or reformat.</p>	<p>Data cannot be saved to the SD memory card because the card is full.</p>	<p>Switch SD memory cards. Alternately, make a backup of the SD memory card using a computer, delete unnecessary data on the card, and format it. See: 8.6, "Copying Internal Memory Files to the SD Memory Card" (p. 130) 8.7, "Deleting Folders and Files" (p. 131) 8.8, "Formatting the SD Memory Card or Internal Memory" (p. 132)</p>

Error display	Cause	Solution/more information
*** SD CARD ERROR *** Error while attempting to access the SD Card.	You attempted to access a corrupt file or a corrupt SD memory card. Alternately, the card was removed while it was being accessed.	Back up the SD memory card using a computer and format the card with the instrument. See: 8.8, "Formatting the SD Memory Card or Internal Memory" (p. 132)
*** SD CARD ERROR *** This is a read-only file.	The SD memory card is in the locked (write-protected) state, or the file or folder attribute is set to "read-only."	If the SD memory card is locked, unlock it. If the file or folder attribute is set to "read-only," change the attribute using a computer.

Internal memory error

Error display	Cause	Solution/more information
*** MEMORY ERROR *** Internal memory is full. Delete files.	The instrument's internal memory is full.	If performing recording and measurement, stop the instrument, back up the internal memory using a computer, and delete files from the internal memory or format it. See: 9.2, "Copying Data to a Computer (USB)" (p. 138) 8.7, "Deleting Folders and Files" (p. 131)
*** MEMORY ERROR *** Internal memory is corrupted. Please reformat.	The instrument's internal memory is corrupt.	Format the internal memory. See: 8.8, "Formatting the SD Memory Card or Internal Memory" (p. 132)

13.4 Disposing of the Instrument

When disposing of this instrument, remove the lithium battery and dispose of battery and instrument in accordance with local regulations.



WARNING

- To avoid electric shock, turn off the power switch and disconnect the cord and cables before removing the lithium battery.
- Battery may explode if mistreated. Do not short-circuit, recharge, disassemble or dispose of in fire.
- Keep batteries away from children to prevent accidental swallowing.

CALIFORNIA, USA ONLY

This product contains a CR Coin Lithium Battery which contains Perchlorate Material - special handling may apply.
See www.dtsc.ca.gov/hazardouswaste/perchlorate

Lithium Battery Removal Preparation items

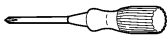

Phillips head screwdriver



Tweezers

1 Turn off the power switch.

2 If any cords are connected, for example voltage cords, clamp sensors, or the AC adapter, disconnect them.

If the PW9002 Battery Set (9459 Battery Pack) is installed, remove it.

See: "Installing (replacing) the Battery Pack" (p. 27)

- 3** Pressing with your fingers on the corners of the two protectors on the left and right sides of the instrument, remove them.

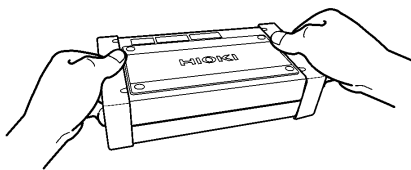

- 4** Using a Phillips head screwdriver, remove the four screws holding the lower case on the bottom of the instrument.

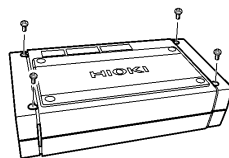

- 5** Remove the lower case.

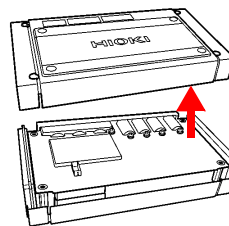

- 6** Remove the single screw holding the board in place and remove the board.

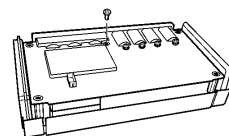

- 7** Insert a pair of tweezers between the battery holder and the battery and lift up to remove the battery.

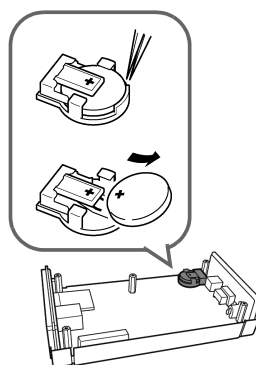

Appendix

Appendix1 How the Instrument Samples Data

The instrument samples each channel at 10.24 kHz. The three voltage channels and three current channels are switched at 61.44 kHz with a multiplexer (MUX), and two A/D converters (one for voltage and another for current) sample the channels. Since U1 and I1, U2 and I2, and U3 and I3 are sampled simultaneously, there is no phase difference between voltage and current readings for the same channel. Sampling between channels for voltage (U1, U2, and U3) and current (I1, I2, and I3) is shifted. The phase differences that result from this sampling shift are corrected internally, and the phase angle is displayed. However, since waveforms are not corrected for sampling shift, the waveforms for U1, U2, and U3 as well as I1, I2, and I3 will differ slightly if the same input is supplied to all three channels.

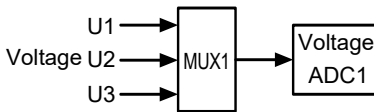

Channels are switched at 61.44 kHz.

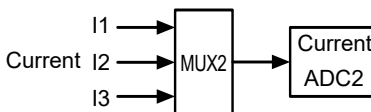

Appendix2 Three-phase 3-wire Measurement

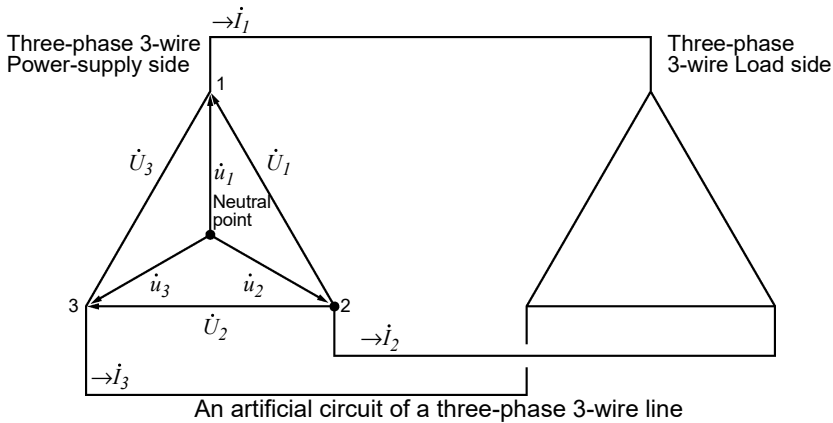

- $\vec{U}_1, \vec{U}_2, \vec{U}_3$: The vectors of line-to-line voltage
- $\vec{u}_1, \vec{u}_2, \vec{u}_3$: The vectors of phase to neutral voltage
- $\vec{I}_1, \vec{I}_2, \vec{I}_3$: The vectors of line (phase) current

3-phase/3-wire/3-wattmeter measurement (3P3W3M)

In 3-wattmeter measurement, three phase voltages ($\vec{u}_1, \vec{u}_2, \vec{u}_3$) and three line (phase) currents ($\vec{I}_1, \vec{I}_2, \vec{I}_3$) are measured. Because the lack of a neutral point in 3-phase, 3-wire lines makes it impossible to measure actual phase voltages, phase voltages are measured from a virtual neutral point.

The 3-phase active power P is calculated as the sum of all the phase active power values.

$$P = \vec{u}_1 \vec{I}_1 + \vec{u}_2 \vec{I}_2 + \vec{u}_3 \vec{I}_3 \quad (1)$$

3-phase/3-wire/2-wattmeter measurement (3P3W2M)

In 2-wattmeter measurement, two line-to-line voltages (\vec{U}_1, \vec{U}_2) and three line (phase) currents (\vec{I}_1, \vec{I}_3) are measured. The 3-phase active power P can be derived from two voltage and current values, as shown below:

$$\begin{aligned} P &= \vec{U}_1 \vec{I}_1 + \vec{U}_2 \vec{I}_3 \quad (\vec{U}_1 = \vec{u}_1 - \vec{u}_2, \vec{U}_2 = \vec{u}_3 - \vec{u}_2) \\ &= (\vec{u}_1 - \vec{u}_2) \vec{I}_1 + (\vec{u}_3 - \vec{u}_2) \vec{I}_3 \\ &= \vec{u}_1 \vec{I}_1 + \vec{u}_2 (-\vec{I}_1 - \vec{I}_3) + \vec{u}_3 \vec{I}_3 \\ &\quad (\text{because } \vec{I}_1 + \vec{I}_2 + \vec{I}_3 = 0 \text{ due to precondition of a closed circuit}) \\ &= \vec{u}_1 \vec{I}_1 + \vec{u}_2 \vec{I}_2 + \vec{u}_3 \vec{I}_3 \quad (2) \end{aligned}$$

Since equations (1) and (2) agree, it is possible to prove that 2-wattmeter measurement can be used to measure the power of a 3-phase, 3-wire line. Since the only special conditions are that the target be a closed circuit without leakage current, it is possible to calculate 3-phase power without regard to the balance or unbalance state of the electric circuit.

Appendix2 Three-phase 3-wire Measurement

Additionally, since the sum of the voltage and current vectors always equals 0 under these conditions, the instrument internally calculates the third voltage (\dot{U}_3) and current (\dot{I}_2) values as follows:

$$\dot{U}_3 = \dot{U}_1 - \dot{U}_2$$

$$\dot{I}_2 = -\dot{I}_1 - \dot{I}_3$$

Since the \dot{U}_3 , \dot{I}_2 values calculated internally are also applied to the 3-phase total reactive power Q, apparent power S, and power factor PF values, these values can also be calculated accurately in the event of an unbalanced state (PF/Q/S calculation selection: when using RMS calculation).

See: "PF/Q/S calculation" (p.72)

However, because the three phases are calculated from two power values in 2-wattmeter measurement, it is not possible to check the power balance for individual phases. If you wish to check the power balance for individual phases, use 3-wattmeter (3P3W3M) measurement.

Item		3P3W2M	Relative merits	3P3W3M	
Voltage	U1	\dot{U}_1	=	$\dot{U}_1 = \dot{u}_1 - \dot{u}_2$	
	U2	\dot{U}_2		$\dot{U}_2 = \dot{u}_2 - \dot{u}_3$	
	U3	$\dot{U}_3 = \dot{U}_1 - \dot{U}_2$		$\dot{U}_3 = \dot{u}_3 - \dot{u}_1$	
Current	I1	\dot{I}_1	=	\dot{I}_1	
	I2	\dot{I}_3		\dot{I}_2	
	I3	$\dot{I}_2 = -\dot{I}_1 - \dot{I}_3$		\dot{I}_3	
Active power	P1	$\dot{U}_1 \dot{I}_1$	<	$\dot{u}_1 \dot{i}_1$	It is possible to check the active power balance for individual phases.
	P2	$\dot{U}_2 \dot{I}_3$		$\dot{u}_2 \dot{i}_2$	
	P3	-		$\dot{u}_3 \dot{i}_3$	
	P	$\dot{U}_1 \dot{I}_1 + \dot{U}_2 \dot{I}_3$ $= \dot{u}_1 \dot{i}_1 + \dot{u}_2 \dot{i}_2 + \dot{u}_3 \dot{i}_3$ See equation (2).	=	$\dot{u}_1 \dot{i}_1 + \dot{u}_2 \dot{i}_2 + \dot{u}_3 \dot{i}_3$	
Apparent power (When the PF/Q/S calculation selection is set to RMS)	S1	$U_1 I_1$	<	$u_1 I_1$	Since calculations are based on the phase voltage and phase (line) current, it is possible to check the apparent power for individual phases.
	S2	$U_2 I_3$		$u_2 I_2$	
	S3	$U_3 I_2$		$u_3 I_3$	
	S	$\frac{\sqrt{3}}{3} (U_1 I_1 + U_2 I_3 + U_3 I_2)$	=	$\frac{\sqrt{3}}{3} (u_1 I_1 + u_2 I_2 + u_3 I_3)$	

NOTE

In 3P3W2M measurement, the instrument inputs the 3-phase line's T-phase current as each current's I2 parameter. For display purposes, the 3-phase line's T-phase current value is shown as the I2 current, and the 3-phase line's S-phase calculated value is shown as the I3 current.

Appendix2 Three-phase 3-wire Measurement

Differences in 3-phase/3-wire/3-wattmeter measurement (3P3W3M) calculations between the PW3360 and the 3169-20/21

This section describes differences in how the PW3660 Clamp on Power Logger and the 3169-20/21 Clamp on Power HiTester perform calculations during 3-phase/3-wire/3-wattmeter (3P3W3M) measurement.

As indicated in the following table, the apparent power and power factor values generated by the 3169-20/21 for each channel are not available for each phase because the instrument uses line-to-line voltages to calculate apparent power and power factor for each channel. By contrast, since the PW3660 uses phase voltages, the apparent power and power factor values for each channel are available for each phase. Consequently, it is possible to check balance for individual phases.

Item		Model PW3360(3P3W3M) When the PF/Q/S calculation selection is set to RMS (p.72)		Relative merits	Model 3169-20/21(3P3W3M) The reactive power meter method is not used.	
Voltage	U1	$\dot{U}_1 = \dot{u}_1 - \dot{u}_2$		=	$\dot{U}_1 = \dot{u}_1 - \dot{u}_2$	
	U2	$\dot{U}_2 = \dot{u}_2 - \dot{u}_3$			$\dot{U}_2 = \dot{u}_2 - \dot{u}_3$	
	U3	$\dot{U}_3 = \dot{u}_3 - \dot{u}_1$			$\dot{U}_3 = \dot{u}_3 - \dot{u}_1$	
Current	I1	\dot{I}_1		=	\dot{I}_1	
	I2	\dot{I}_2			\dot{I}_2	
	I3	\dot{I}_3			\dot{I}_3	
Active power	P1	$\dot{u}_1 \dot{I}_1$		=	$\dot{u}_1 \dot{I}_1$	
	P2	$\dot{u}_2 \dot{I}_2$			$\dot{u}_2 \dot{I}_2$	
	P3	$\dot{u}_3 \dot{I}_3$			$\dot{u}_3 \dot{I}_3$	
	P	P1+P2+P3			P1+P2+P3	
Apparent power	S1	$u_1 I_1$	Since calculations are based on the phase voltage and phase (line) current, it is possible to check the apparent power for each of the three phases.	>	$U_1 I_1$	Since calculations are based on the line-to-line voltage and line (phase) current, apparent power values are not generated for individual phases.
	S2	$u_2 I_2$			$U_2 I_2$	
	S3	$u_3 I_3$			$U_3 I_3$	
	S	$\frac{\sqrt{3}}{3} (U1I1+U2I2+U3I3)$		=	$\frac{\sqrt{3}}{3} (U1I1+U2I2+U3I3)$	
Power factor si: Indicates lag/lead.	PF1	si $\frac{P1}{U_1 I_1}$	Since calculations are based on the phase voltage and phase (line) current, it is possible to check the power factor for individual phases.	>	si $\frac{P1}{U_1 I_1}$	Since calculations are based on the line-to-line voltage and phase (line) current, power factor values are not generated for individual phases.
	PF2	si $\frac{P2}{U_2 I_2}$			si $\frac{P2}{U_2 I_2}$	
	PF3	si $\frac{P3}{U_3 I_3}$			si $\frac{P3}{U_3 I_3}$	
	PF	si $\frac{P}{S}$		=	si $\frac{P}{S}$	

Appendix3 Method for Calculating Active Power Accuracy

The accuracy of active power calculations can be calculated as follows, taking into account the phase accuracy:

Example measurement conditions

Wiring: 3-phase/3-wire/2-wattmeter measurement (3P3W2M)

Clamp sensor: Model 9661

Current range: 100 A (power range: 120 kW)

See: "12.6 Range Configuration and Accuracy by Clamp Sensor" (p.213)

Measured values: Active power of 30 kW, power factor lag 0.8

Accuracy

Clamp sensor combined accuracy (Model 9661 sensor, 100 A range): $\pm 0.6\%$ rdg. $\pm 0.15\%$ f.s.

Instrument phase accuracy: $\pm 0.3^\circ$

Model 9661 phase accuracy: $\pm 0.5^\circ$

See: "12.3 Detailed Measurement Specifications" (p.185)

"12.6 Range Configuration and Accuracy by Clamp Sensor" (p.213)

Model 9661 Instruction manual "Specifications" phase accuracy

Power factor accuracy based on phase accuracy

Phase accuracy (in combination with clamp sensor)

= Instrument phase accuracy ($\pm 0.3^\circ$) + Model 9661 phase accuracy ($\pm 0.5^\circ$) = $\pm 0.8^\circ$

Phase difference $\theta = \cos^{-1}(\text{power factor}) = \cos^{-1}0.8 = 36.87^\circ$

Power factor error range based on phase accuracy = $\cos(36.87^\circ \pm 0.8^\circ)$

= Min. 0.7915 to max. 0.8083

Power factor accuracy based on phase accuracy (minimum) = $\frac{0.7915 - 0.8}{0.8} \times 100\%$

= -1.06%, Use the worst value as the power factor accuracy.

Power factor accuracy based on phase accuracy (maximum) = $\frac{0.8083 - 0.8}{0.8} \times 100\%$
= +1.04%

→ Power factor accuracy based on phase accuracy: $\pm 1.06\%$ rdg.

Active power accuracy

Active power accuracy = Clamp sensor combined accuracy

+ power factor accuracy based on phase accuracy

= $\pm 0.6\%$ rdg. $\pm 0.15\%$ f.s. $\pm 1.06\%$ rdg.

= $\pm 1.66\%$ rdg. $\pm 0.15\%$ f.s.

Accuracy relative to measured values = active power 30kW $\times \pm 1.66\%$ rdg.

+120kW range $\times 0.15\%$ f.s.

= ± 0.678 kW

= ± 0.678 kW/30kW = $\pm 2.26\%$ rdg.

Appendix4 Terminology

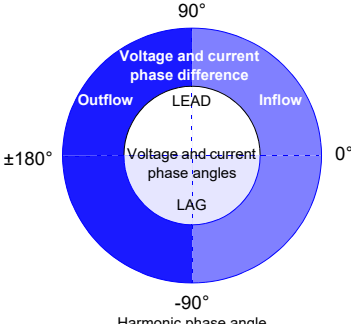
Active power	Power that is consumed doing work.
Active power demand value	The average active power used during a set period of interval time (usually 30 minutes).
Apparent power	The (vector) power obtained by combining active power and reactive power. As its name suggests, apparent power expresses the "visible" power and comprises the product of the voltage and current RMS values.
Binary data	All data other than text (character) data. Use binary data when analyzing data with the SF1001 Power Logger Viewer application.
Harmonics	A phenomenon caused by distortions in the voltage and current waveforms that affect many devices with power supplies using semiconductor control devices. In the analysis of non-sine waves, the term refers to one RMS value among the components with harmonic frequencies.
Harmonic content percentage (PW3360-21 only)	<p>The ratio of the K-order size to the size of the fundamental wave, expressed as a percentage using the following equation: $K\text{-order wave} / \text{fundamental wave} \times 100 [\%]$</p> <p>By observing this value, it is possible to ascertain the harmonic component content for individual orders. This metric provides a useful way to track the harmonic content percentage when monitoring a specific order.</p>
Harmonics phase angle (PW3360-21 only)	<p>The differences in phase of each harmonic order component and the phase of the fundamental wave component is expressed as an angle (°) and - indicates a LAG, whereas + indicates a LEAD.</p> <p>The phase angle of harmonic power is expressed by the power factor of each order of harmonic converted into an angle (°). When the harmonic-power phase angle is between -90° and +90° (the polarity of the harmonic active power is positive), the order of harmonic is flowing in toward the load (inflow). When the phase angle is between +90° and +180° or between -180° and -90° (the polarity of the harmonic active power is negative), that order of harmonic is flowing out from the load (outflow).</p>  <p style="text-align: center;">Harmonic phase angle</p>

IEC61000-4-7	An international standard governing measurement of harmonic current and harmonic voltage in power supply systems as well as harmonic current emitted by equipment. The standard specifies the performance of a standard instrument.
LAN	<p>LAN is the abbreviation of Local Area Network. The LAN was developed as a network for transferring data through a PC within a local area, such as an office, factory, or school.</p> <p>This device comes equipped with the LAN adapter Ethernet 10/100Base-T. Use a twisted-pair cable to connect this device to the hub (central computer) of your LAN. Communications using TCP/IP as the LAN interface protocol are supported.</p>
Power factor (PF/DPF)	<p>Power factor is the ratio of effective power to apparent power. The larger the absolute value of the power factor, the greater the proportion of effective power, which provides the power that is consumed, and the greater the efficiency. The maximum absolute value is 1. Conversely, the smaller the absolute value of the power factor, the greater the proportion of reactive power, which is not consumed, and the lower the efficiency. The minimum absolute value is 0. A positive value (LAG) indicates that the current phase is lagging the voltage. Inductive loads (such as motors) are characterized by lagging phase. A negative value (LEAD) indicates that the current phase is leading the voltage. Capacitive loads (such as capacitors) are characterized by leading phase. Sign is reversed harmonic phase angle, and the phase difference.</p> <p>The power factor (PF) is calculated using rms values that include harmonic components. Larger harmonic current components cause the power factor to deteriorate. By contrast, since the displacement power factor (DPF) calculates the ratio of effective power to apparent power from the fundamental voltage and fundamental current, no voltage or current harmonic component is included. This is the same measurement method used by reactive power meters installed at commercial-scale utility customers' facilities.</p> <p>Displacement power factor, or DPF, is typically used by the electric power system, although power factor, or PF, is sometimes used to measure equipment in order to evaluate efficiency.</p> <p>When a lagging phase caused by a large inductive load such as a motor results in a low displacement power factor, there are corrective measures that can be taken to improve the power factor, for example by adding a phase advance capacitor to the power system. Displacement power factor (DPF) measurements can be taken under such circumstances to verify the improvement made by the phase advance capacitor.</p>
Power factor demand value	<p>The power factor calculated using the active power demand value (consumption) and the reactive power demand value (lag) for the set interval time (usually 30 minutes).</p> $PF_{dem} = \frac{P_{dem}}{\sqrt{(P_{dem})^2 + (Q_{dem_LAG})^2}}$

Appendix4 Terminology

Reactive power	Power that does not perform actual work, resulting in power consumption as it travels between the load and the power supply. Reactive power is calculated by multiplying the active power by the sine of the phase difference ($\sin \theta$). It arises from inductive loads (deriving from inductance) and capacitive loads (deriving from capacitance), with reactive power derived from inductive loads known as lag reactive power and reactive power derived from capacitive loads known as lead reactive power.
Reactive power demand value	The average reactive power used during a set period of interval time (usually 30 minutes).
RMS value	The square root of the squares of 2048 sampling points in a 200 ms interval. The value includes harmonic components.
SD memory card	A type of flash memory card.
Text data	A file containing only data expressed using characters and character codes.
Total harmonic distortion factor (PW3360-21 only)	<p>THD-F: The ratio of the size of the total harmonic component to the size of the fundamental wave, expressed as a percentage using the following equation:</p> $\text{THD-F} = \frac{\sqrt{\sum(\text{from 2nd order})^2}}{\text{Fundamental waveform}} \times 100 [\%]$ <p>(for the PW3360, calculated to the 40th order) This value can be monitored to assess waveform distortion for each item, providing a yardstick that indicates the extent to which the total harmonic component is distorting the fundamental waveform. As a general rule, the total distortion factor for a high-voltage system should be 5% or less; it may be higher at the terminal point of the system.</p> <p>THD-R: The ratio of the size of the total harmonic component to the size of RMS values, expressed as a percentage using the following equation:</p> $\text{THD-R} = \frac{\sqrt{\sum(\text{from 2nd order})^2}}{\text{RMS values}} \times 100 [\%]$ <p>(for the PW3360, calculated to the 40th order) THD-F is typically used.</p>
USB	An interface that allows data to be sent to and received from a host controller (usually a computer) to which a device is connected with a USB cable. Consequently, functions are unable to communicate directly.

Index

Number

3169-20/21 A 4

A

AC adapter 36
 Active energy 92, 95
 Active power 63, 92, 94
 Alligator clip 2, 24, 53, 57
 Amount of space used 118
 Apparent power 72, 92, 94, A 6

B

Backlight 16, 83
 Battery 22, 27
 Battery pack 27
 Beep sound 83
 B-type grounding wire 59

C

Card reader 136
 Carrying case 30
 Charge 27
 Clamp sensor 9, 25, 45, 55, 70
 Clock 83
 Connection 45
 Consumption 95
 CT 45, 70
 Current 21
 Current input terminal 18, 56
 Current phase 66
 Current range 47, 51, 61, 70

D

Default 31, 87, 88
 Default gateway 154
 Demand 76, 96
 Demand quantity 150
 Demand value 150
 Displacement power factor 63, 72, 92, A 7
 DPF 63, 72, 92, A 7

E

Energy 92, 95
 Energy cost 73
 Enlarge 102
 Error indication 221
 Excel 143
 Exponential 152

F

Factory reset 31, 87
 Factory settings 88
 File 78, 117
 Folder 78, 117
 Format 33, 132
 Frequency 31, 69, 92
 Fundamental wave 72, 93
 Fundamental wave apparent power 72
 Fundamental wave reactive power 72

H

HARDCOPY 126
 Harmonic 93
 Harmonic content percentage A 6
 Harmonic graph 97
 Harmonic list 99
 Harmonics A 6
 Harmonics phase angle A 6
 Help 68
 HOLD 89
 HTTP server 21, 159

I

I only 48
 Indicators 21
 Inspection 32
 Internal memory 21, 117
 Internet browser 159
 Internet explorer 159
 Interval time 80, 108
 IP address 154

K

Key lock 16, 21

Index 2

Index

L

LAG	A 7
LAN	21
LAN cable	153
Language	31, 84
Lead	A 7
Leakage current	50, 59
Line current	48, A 2
Line-to-line voltage	48, A 2

M

MAC address	18, 154
Magnet Adapter	24, 53, 57
Mass storage	139
Measurement	89
Measurement categories	7
Measurement file	144
Measurement guide	2
Measurement is not possible	22, 151

O

Open collector	176
Over-range	22, 62, 182

P

Password	161
Patch Cord	54
Peak	21, 93, 182
PF	63, 72, 92, 94, A 7
Phase advance capacitor	66, A 7
Phase advancer	66
Phase angle of the fundamental wave ..	93
Phase difference	66
Phase name	84
Phase voltage	48, A 2
Power	92, 94
Power cord	36
Power factor	63, 72, 92, 94, A 7
Power factor demand value	151, A 7
Power Logger Viewer	140
Power outage	112
Power switch	43
PT	38, 45, 71
Pulse	171

Q

Quick Set	85, 113, 199
-----------------	--------------

R

Reactive power	72, 92, 94, A 8
Recording	105
Recording and measurement	105
Recording start	80, 105
Recording stop	81, 105, 109
Recording time	21
Regeneration	95
Removable disk	137, 139
RMS	72, 92, 93

S

Sampling	A 1
Save destination	75
Save interval	75
Save item	76
Screen color	84
Screen copy	16, 77, 117, 126
SD memory card	21, 33, 75, 117
Self-test	43
Serial number	18, 85
SET.LOAD	118, 119, 128, 129
Setting	67
Settings data	117
Settings files	127, 128
Spiral tube	2, 24, 25
Storage time	21, 75
Subnet mask	154
System	83
System reset	86

T

THD	74, 97, 99, A 8
Total harmonic distortion	74, 97, 99, A 8
Transporting	218
Trend graph	103

U

Unit cost	73
USB	21, 138
USB Drive	118, 139

V

Version	43, 85
Virtual neutral point	48, A 2
Voltage	92
Voltage cord	2, 24, 45
Voltage input terminal	18, 53

Voltage Line Power Adapter	38
Voltage phase	65
Voltage range	71
Voltage transformer	38
VT	38, 45, 71

W

Waveform	78
Waveforms	100
Wireless LAN	153
Wiring	69
Wiring check	63
Wiring diagram	47

Warranty Certificate

HIOKI

Model	Serial number	Warranty period Three (3) years from date of purchase (___ / ___)
-------	---------------	--

Customer name: _____

Customer address: _____

Important

- Please retain this warranty certificate. Duplicates cannot be reissued.
- Complete the certificate with the model number, serial number, and date of purchase, along with your name and address. The personal information you provide on this form will only be used to provide repair service and information about Hioki products and services.

This document certifies that the product has been inspected and verified to conform to Hioki's standards. Please contact the place of purchase in the event of a malfunction and provide this document, in which case Hioki will repair or replace the product subject to the warranty terms described below.

Warranty terms

1. The product is guaranteed to operate properly during the warranty period (three [3] years from the date of purchase).
If the date of purchase is unknown, the warranty period is defined as three (3) years from the date (month and year) of manufacture (as indicated by the first four digits of the serial number in YYYY format).
2. If the product came with an AC adapter, the adapter is warranted for one (1) year from the date of purchase.
3. The accuracy of measured values and other data generated by the product is guaranteed as described in the product specifications.
4. In the event that the product or AC adapter malfunctions during its respective warranty period due to a defect of workmanship or materials, Hioki will repair or replace the product or AC adapter free of charge.
5. The following malfunctions and issues are not covered by the warranty and as such are not subject to free repair or replacement:
 - 1. Malfunctions or damage of consumables, parts with a defined service life, etc.
 - 2. Malfunctions or damage of connectors, cables, etc.
 - 3. Malfunctions or damage caused by shipment, dropping, relocation, etc., after purchase of the product
 - 4. Malfunctions or damage caused by inappropriate handling that violates information found in the instruction manual or on precautionary labeling on the product itself
 - 5. Malfunctions or damage caused by a failure to perform maintenance or inspections as required by law or recommended in the instruction manual
 - 6. Malfunctions or damage caused by fire, storms or flooding, earthquakes, lightning, power anomalies (involving voltage, frequency, etc.), war or unrest, contamination with radiation, or other acts of God
 - 7. Damage that is limited to the product's appearance (cosmetic blemishes, deformation of enclosure shape, fading of color, etc.)
 - 8. Other malfunctions or damage for which Hioki is not responsible
6. The warranty will be considered invalidated in the following circumstances, in which case Hioki will be unable to perform service such as repair or calibration:
 - 1. If the product has been repaired or modified by a company, entity, or individual other than Hioki
 - 2. If the product has been embedded in another piece of equipment for use in a special application (aerospace, nuclear power, medical use, vehicle control, etc.) without Hioki's having received prior notice
7. If you experience a loss caused by use of the product and Hioki determines that it is responsible for the underlying issue, Hioki will provide compensation in an amount not to exceed the purchase price, with the following exceptions:
 - 1. Secondary damage arising from damage to a measured device or component that was caused by use of the product
 - 2. Damage arising from measurement results provided by the product
 - 3. Damage to a device other than the product that was sustained when connecting the device to the product (including via network connections)
8. Hioki reserves the right to decline to perform repair, calibration, or other service for products for which a certain amount of time has passed since their manufacture, products whose parts have been discontinued, and products that cannot be repaired due to unforeseen circumstances.

HIOKI E.E. CORPORATION

<http://www.hioki.com>

18-07 EN-3

HIOKI

www.hioki.com/



**All regional
contact
information**

HEADQUARTERS

81 Koizumi
Ueda, Nagano 386-1192 Japan

HIOKI EUROPE GmbH

Rudolf-Diesel-Strasse 5
65760 Eschborn, Germany
hioki@hioki.eu

2103 EN

Edited and published by HIOKI E.E. CORPORATION

Printed in Japan

- CE declarations of conformity can be downloaded from our website.
- Contents subject to change without notice.
- This document contains copyrighted content.
- It is prohibited to copy, reproduce, or modify the content of this document without permission.
- Company names, product names, etc. mentioned in this document are trademarks or registered trademarks of their respective companies.