

RM3545A-1 RM3545A-2

HIOKI

Instruction Manual

RESISTANCE METER

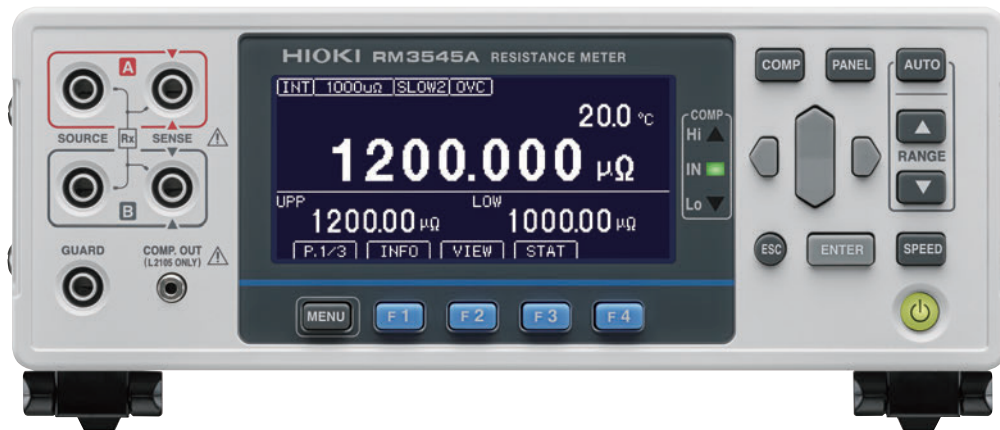

**Read carefully before use.
Keep for future reference.**



When using the instrument for the first time

- Safety Information ▶ p.7
- Part Names and Functions ▶ p.16
- Basic Measurements ▶ p.45



Troubleshooting

- Maintenance and Service ▶ p.299
- Error Displays ▶ p.312

EN



Using This Instruction Manual

To do this...

Refer to these sections in this manual.

Learn more about differences from the previous products and between the models

▶ Comparison with the Previous Products (the following page)

Review important information

▶ Safety Information (p.7)
Precautions for Use (p.8)

Start using the instrument right away

▶ Overview (p.13)

Learn more about instrument functions

▶ Search for the function in question in the following:
• Table of Contents (p.i)
• Customizing Measurement Conditions (p.63)
• Index (p.Index1)

Learn more about product specifications

▶ Specifications (p.263)

Troubleshoot a problem

▶ Troubleshooting (p.301)

Learn more about resistance measurement

▶ Appendix (p.319)

Learn more about communications commands

▶ Communications Command Instruction Manual (PDF)
The Instruction Manual can be downloaded from Hioki's website.
<https://www.hioki.com/global/support/download/>

Comparison with the Previous Products

The following table provides comparisons between the previous products (RM3545 series) and the current products (RM3545A-1, RM3545A-2).

Available: ✓, Not available: –

Specifications, functions	RM3545 series			RM3545A-1	RM3545A-2
	RM3545	RM3545-01	RM3545-02		
Minimum measurement range	10 mΩ			1000 μΩ	
Maximum resolution	10 nΩ			1 nΩ	
Measurement range	0.000 00 mΩ (10 mΩ range) to 1200.0 MΩ (1000 MΩ range), 12 ranges			0.000 μΩ (1000 μΩ range) to 1200.0 MΩ (1000 MΩ range), 13 ranges	
Measurement current	1 A, 100 mA, 10 mA, 1 mA, 500 μA, 100 μA, 50 μA, 10 μA, 5μA, 1μA, 1μA or less, 100 nA				
Offset voltage compensation	OVC				
Temperature correction	TC				
Maximum allowable route resistance (reference value) 1 A range	1.5 Ω			3.5 Ω (PR: On) 2.8 Ω (PR: Off)	
Pure resistance mode (PR)	–			1000 μΩ, 10 mΩ, 100 mΩ ranges	
Low-power mode (LP)	1000 mΩ, 10 Ω, 100 Ω, 1000 Ω ranges				
Interface	USB	✓			
	RS-232C	✓			
	LAN	–			✓
	GP-IB	–	✓	–	
EXT. I/O	✓				
Multiplexer	–		Max. 2*1	–	Max. 2*1
Fuse	F1.6AH/250 V (replaceable)				
Dimensions	Approx. 215W × 80H × 306.5D mm (8.46W × 3.15H × 12.07D in.)				
Weight	Approx. 2.5 kg (5.5 lbs)		Approx. 3.2 kg (7.1 lbs)	Approx. 2.7 kg (6.0 lbs)	Approx. 3.4 kg (7.5 lbs)

*1. 2-wire: Max. 21 channels/unit, 4-wire: Max. 10 channels/unit

Contents

Introduction.....	1	3.3	Setting the Measurement Speed	50
Verifying Package Contents	2	3.4	Connecting Measurement Leads to the Measurement Target	52
Options	3	3.5	Checking Measured Values	53
Symbols and Abbreviations.....	5	■	Switching the display	53
Safety Information	7	■	Confirming measurement faults	56
Precautions for Use.....	8	■	Holding measured values	61
1 Overview	13	4	Customizing Measurement Conditions	63
1.1 Product Overview	13	4.1	Switching to Low-power Mode (LP) ...	65
1.2 Features	13	4.2	Switching Measurement Currents (100 mΩ to 100 Ω range)	67
1.3 Part Names and Functions	16	4.3	Performing Zero Adjustment	69
1.4 Measurement Process	20	4.4	Stabilizing Measured Values (Averaging Function)	74
1.5 Screen Organization and Operation Overview	21	4.5	Correcting for the Effects of Temperature (Temperature Correction [TC])	76
2 Measurement Preparations	29	4.6	Correcting Measured Values and Displaying Physical Properties Other than Resistance Values (Scaling Function)	78
2.1 Pre-Operation Inspection	30	4.7	Changing the Number of Measured Value Digits	82
2.2 Connecting the Power Cord	31	4.8	Compensating for Thermal EMF Offset (OVC Function)	83
2.3 Connecting Measurement Leads	32	■	Offset voltage compensation (OVC) Function	83
2.4 Connecting Z2001 Temperature Sensor or Thermometer with Analog Output (When using the TC or ΔT)	34	4.9	Switching to Pure Resistance Mode (PR)	85
■ Connecting the Z2001 Temperature Sensor	34	4.10	Setting Pre-Measurement Delay (Delay Function)	86
■ Connecting an analog output thermometer	37	4.11	Checking for Poor or Improper Contact (Contact Check Function)	90
2.5 Installing the Multiplexer Unit	41	4.12	Improving Probe Contact (Contact Improvement Function)	92
2.6 Turning the Power On and Off	43	4.13	Maintaining Measurement Precision (Self-Calibration)	94
■ Turning on the instrument with the main power switch	43	4.14	Increasing the Precision of the 100 MΩ Range (100 MΩ Range High-precision Mode)	98
■ Turning off the instrument with the main power switch	43			
■ Canceling the standby state	43			
■ Placing the instrument in the standby state	44			
3 Basic Measurements	45			
3.1 Checking the Measurement Target	46			
3.2 Selecting the Measurement Range	48			

4.15 Judging Measured Values (Comparator Function)99

- Enabling and disabling the comparator function 101
- Decide according to upper/lower thresholds (ABS mode) 102
- Decide according to reference value and tolerance (REF% mode) 104
- Checking judgments using sound (judgment sound setting function) 106
- Checking judgments with the L2105 LED Comparator Attachment (option) 108

4.16 Classifying Measurement Results (BIN Measurement Function) 109

4.17 Performing Statistical Calculations on Measured Values 112

- Using statistical calculations 114
- Confirming, printing, and erasing calculation results 116

4.18 Performing Temperature Rise Test (Temperature Conversion Function [ΔT]) 118

5 Saving and Loading Panels (Saving and Loading Measurement Conditions) 121

5.1 Saving Measurement Conditions (Panel Save Function) 122

5.2 Loading Measurement Conditions (Panel Load Function) 123

- Preventing loading of zero adjustment values 124

5.3 Changing Panel Names 126

5.4 Deleting Panel Data 127

6 System Settings 129

6.1 Disabling and Enabling Key Operations 130

- Disabling key operations (key-lock function) 130
- Re-enabling key operations (key-lock cancel) 131

6.2 Enabling or Disabling the Key Beeper 132

6.3 Power Line Frequency Manual Setting 133

6.4 Adjusting Screen Contrast 134

6.5 Adjusting the Backlight 135

6.6 Setting the Clock 136

6.7 Initializing (Reset) 137

- Default settings 139

7 Multiplexer 145

7.1 About the Multiplexer 146

- Restrictions when using the multiplexer unit 148
- Connector type and pinouts 149
- About multiplexer wiring 151

7.2 Internal Circuitry 152

- Electrical specifications 153

7.3 Multiplexer Settings 154

- Configuring multiplexer settings 154
- Customizing channel pin allocation 158
- Setting basic measurement conditions and total judgment conditions for individual channels 162
- Customizing measurement conditions for individual channels 166

7.4 Measuring with the Multiplexer 167

- Measuring while switching channels manually 167
- Performing scan measurement 168

7.5 Zero adjustment (When a Multiplexer Unit Has Been Installed) 169

- Performing zero adjustment 169
- Canceling zero adjustment 170

7.6 Performing the Multiplexer Unit Test 172

7.7 Example Connections and Settings . 174

8 D/A Output 181

8.1 Connecting D/A Output 181

8.2 D/A Output Specifications 182

9	External Control (EXT. I/O)	185
9.1	External Input/Output Connector and Signals	187
■	Switching between current sink (NPN) and current source (PNP)	187
■	Connector type and signal pinouts	188
■	Signal descriptions	190
9.2	Timing Chart	196
■	From start of measurement to acquisition of judgment results	196
■	BCD signal timing	201
■	Zero adjustment timing	201
■	Self-calibration timing	202
■	Contact improvement timing	205
■	Panel load timing	206
■	Multiplexer timing	207
■	Output signal state at power-on	210
■	Acquisition process when using an external trigger	211
9.3	Internal Circuitry	213
■	Electrical specifications	215
■	Wiring diagram	215
9.4	External I/O Settings	217
■	Setting measurement start conditions (trigger source)	217
■	Setting the TRIG signal logic	219
■	Eliminating TRIG/PRINT signal chatter (filter function)	221
■	Setting EOM signal	223
■	Switching output modes (JUDGE mode/ BCD mode)	225
■	Over-range error output	226
9.5	Checking External Control	227
■	Performing an I/O test (EXT. I/O test function)	227
9.6	Supplied Connector Assembly	229
10	Communications (USB/RS-232C/LAN Interface)	231
10.1	Overview and Features	232
10.2	USB Interface	233
■	Configuring communications	233
■	Installing the USB driver	234
■	Connecting the USB cable	234
10.3	RS-232C Interface	235
■	Configuring communications	235
■	Connecting the RS-232C cable	237
10.4	LAN Interface	238
■	Configuration of communications	239
■	Configuring communications	241
■	Connecting the LAN cable	243
10.5	Controlling the Instrument with Commands and Acquiring Data	244
■	Remote and local states	244
■	Displaying communications commands (command monitor function)	245
■	Acquiring measured values at once (data memory function)	247
10.6	Outputting Measured Values to External Devices without Controlling the Instrument with Commands (Data Output Function)	248
11	Printing (Using an RS-232C Printer)	251
11.1	Connecting the Printer to the Instrument	251
11.2	Printing	253
■	Printing measured values and comparator judgments	253
■	Printing list of measurement conditions and settings	254
■	Printing statistical calculation results	257
12	Specifications	263
12.1	General Specifications	263
12.2	Input Specifications/Output Specifications/Measurement Specifications	264
■	Basic specifications	264
■	Accuracy specifications	270
■	About instrument accuracy	274
12.3	Function Specifications	275
12.4	Interface Specifications	286
12.5	Communications Interface Specifications	287
12.6	Z3003 Multiplexer Unit	293
■	General specifications	293
■	Measurement specifications	296

- About instrument accuracy 297
- Function 298
- Environment and safety specifications ... 298
- Included accessories 298

13 Maintenance and Service 299

- 13.1 Repair, Inspection, and Cleaning299
- 13.2 Troubleshooting301
 - Before Returning for Repair 301
 - Error displays 312
 - Message displays 314
- 13.3 Replacing the Measurement Circuit's Protective Fuse315
- 13.4 Disposing of the Instrument316
 - Removing the lithium battery 316

14 Appendix 319

- 14.1 Block Diagram319
- 14.2 Four-Terminal (Voltage-Drop) Method320
- 14.3 DC and AC Measurement321
- 14.4 Temperature Correction (TC) Function322
- 14.5 Temperature Conversion (ΔT) Function.....324
- 14.6 About Zero Adjustment.....325
- 14.7 Unstable Measured Values330
- 14.8 Using Multiple Units of the Instrument337
- 14.9 Mitigating Noise338
- 14.10 Effect of Thermal EMF.....342
- 14.11 Detecting the Location of a Short on a Printed Circuit Board344
- 14.12 Measuring Contact Resistance.....345
- 14.13 JEC 2137 Induction Machine-compliant Resistance Measurement.....347
- 14.14 Making Your Own Measurement Leads, Making Connections to the Multiplexer348
- 14.15 Checking Measurement Faults.....350
- 14.16 Using the Instrument with a Withstanding Voltage Tester351

- 14.17 Measurement Leads (Options) 352
- 14.18 Rack Mounting 354
- 14.19 Outline Drawing 356
- 14.20 Calibrations 357
- 14.21 Adjustment Procedure 362
- 14.22 Instrument Settings (Memo)..... 363

15 License Information 365



Index Index1

Introduction

Thank you for choosing the Hioki RM3545A-1, RM3545A-2 Resistance Meter. To ensure your ability to get the most out of this instrument over the long term, please read this manual carefully and keep it available for future reference.

RM3545A-2 is provided with multiplexer slots.

RM3545A-1, RM3545A-2 are referred to as “the instrument” or “the main body”.

 	These icons are displayed to indicate the functions are available for the respective models.
---	--

The latest edition of the instruction manual

The contents of this manual are subject to change, for example, as a result of product improvements or changes to specifications.

The latest edition can be downloaded from Hioki’s website.

<https://www.hioki.com/global/support/download/>



Product registration

Register this product in order to receive important product information.

<https://www.hioki.com/global/support/myhioki/registration/>



See the following manuals according to the applications.

Names of manuals	Description	Provided form
Instruction Manual (this manual)	This manual provides a product overview, operating procedures, descriptions of the functions, and specifications for the instrument.	PDF (for web download)
Startup Guide	This manual provides the information, basic operating procedures, and specifications (excerpt) required to use the instrument safely.	Print
Operating Precautions	This manual provides the information required to use the instrument safely. Please review the separate “Operating Precautions” before using the instrument.	Print
Communications Command Instruction Manual	This manual describes the communications commands in order to control the instrument.	PDF (for web download)

Target audience

This manual has been written for use by individuals who use the product or provide information about how to use the product.

In explaining how to use the product, it assumes electrical knowledge (equivalent of the knowledge possessed by a graduate of an electrical program at a technical high school).

Trademarks

Windows is a trademark of the Microsoft group of companies.

Verifying Package Contents

When you receive the instrument, please inspect it for any damage or other issues prior to use. If you find any damage or discover that the instrument does not perform as indicated in its specifications, please contact your authorized Hioki distributor or reseller.

Confirm that these contents are provided.

Main body

- RM3545A-1, RM3545A-2 Resistance Meter (RM3545A-2 is provided with multiplexer slots.)

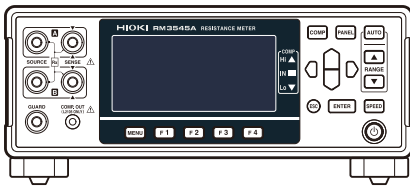

Included accessories

- Power cord (p.31)
- Z2001 Temperature Sensor
- EXT. I/O connector (male) (p.229)
- EXT. I/O connector cover
- Spare fuse (F1.6AH/250V)
- Startup Guide
- Operating Precautions (0990A905)

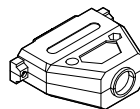
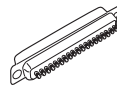
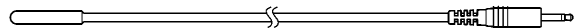

Options

The options listed below are available for the instrument. To purchase any of the options, contact your authorized Hioki distributor or reseller.

Options are subject to change. Check Hioki's website for the latest information.

For more information about the measurement leads, see "14.17 Measurement Leads (Options)" (p.352).

L2100 Pin Type Lead (for low resistance only*1)



L2104 4-Terminal Lead



L2101 Clip Type Lead



L2105 LED Comparator Attachment



L2102 Pin Type Lead



Z2001 Temperature Sensor



L2103 Pin Type Lead



Z3003 Multiplexer Unit
(RM3545A-2 only)



*1. "Low resistance" refers to the following ranges, all of which have a measurement current of at least 100 mA. Other ranges fall outside the scope of the accuracy guarantee.
1000 $\mu\Omega$ range (High, Low), 10 m Ω range (High, Low), 100 m Ω range (High, Low), 1000 m Ω range (High only)

Options

Z5038 0 ADJ Board



9642 LAN Cable



L9637 RS-232C Cable
(9-pin to 9-pin, 3.0 m, crossover cable, double shield)







L1002 USB Cable (A-B type)







Symbols and Abbreviations

Safety notations



In this manual, the risk seriousness and the hazard levels are classified as follows.

	Indicates an imminently hazardous situation that, if not avoided, will result in death or serious injury.
	Indicates a potentially hazardous situation that, if not avoided, could result in death or serious injury.
	Indicates a potentially hazardous situation that, if not avoided, could result in minor or moderate injury or potential risks of damage to the supported product (or to other property).
IMPORTANT	Indicates information or content that is particularly important from the standpoint of operating or maintaining the instrument.
	Indicates a prohibited action.
	Indicates an action that must be performed.

Symbols on the instrument

	Indicates the presence of a potential hazard. For more information about locations where this symbol appears on instrument components, see the “Precautions for Use” section (p.8), warning messages listed at the beginning of operating instructions, and the accompanying document entitled “Operating Precautions”.
	Indicates AC (Alternating Current).
	Indicates the ON side of the power switch.
	Indicates the OFF side of the power switch.
	Indicates a fuse.

Symbols for various standards

	Indicates that the product complies with standards imposed by EU directives.
	Indicates that the product is subject to the Directive on Waste Electrical and Electronic Equipment (WEEE) in EU member nations. Dispose of the product in accordance with local regulations.

Other symbols

(p.)	Indicates the page number to reference.
*	Indicates additional information is described below.
[]	Indicates the names of user interface elements on the screen.
SET (Bold characters)	Indicates the names of user interface elements on the screen.

Accuracy labeling

Instrument accuracy is expressed by defining a percentage of the reading, a percentage of full scale, or a limit value for errors in terms of digits.

Reading (display value)	Indicates the value displayed by the instrument. Limit values for reading errors are expressed as a percentage of the reading (“% rdg.”).
Full scale (measurement range value)	Indicates each measurement range’s value. This value does not indicate the maximum display value. The instrument can display measured values that exceed the measurement range value. Limit values for full-scale errors are expressed as a percentage of the full scale (“% f.s.”).
Digit (resolution)	Indicates the minimum display unit (in other words, the smallest digit that can have a value of 1) for a digital measuring instrument. Limit values for digit errors are expressed using digits.

See: “Example accuracy calculations” (p.274) (this instrument)

See: “Example accuracy calculations” (p.297) (when using Z3003)

Safety Information

This instrument is designed to conform to International Standard IEC 61010 and has been thoroughly tested for safety prior to shipment. However, using the instrument in a way not described in this manual may negate the provided safety features.

Before using the instrument, be sure to carefully read the following safety precautions.

DANGER



- **Familiarize yourself with the instructions and precautions in this manual before use.**

Failure to do so could cause improper use of the instrument, resulting in serious bodily injury or damage to the instrument.

WARNING



- **If you have not used any electrical measuring instruments before, you should be supervised by a technician who has experience in electrical measurement.**

Failure to do so could cause the operator to experience an electric shock. Moreover, it could cause serious events such as heat generation, fire, and an arc flash due to a short-circuit.

Precautions for Use

Be sure to follow the precautions listed below in order to use the instrument safely and in a manner that allows it to function effectively.

Use of the instrument should conform not only to its specifications, but also to the specifications of all accessories, options, and other equipment in use.

Instrument installation



- **Do not install the instrument in locations such as the following:**
 - In locations where it would be subject to direct sunlight or high temperatures
 - In locations where it would be exposed to corrosive or explosive gases
 - In locations where it would be exposed to powerful electromagnetic radiation or close to objects carrying an electric charge
 - Close to inductive heating devices (high-frequency inductive heating devices, IH cooktops, etc.)
 - In locations characterized by a large amount of mechanical vibration
 - In locations where it would be exposed to water, oil, chemicals, or solvents
 - In locations where it would be exposed to high humidity or condensation
 - In locations with an excessive amount of dust

The instrument may be damaged or malfunction, resulting in bodily injury.



- **Be sure to place the instrument with enough space provided around the instrument so that the power can be cut off by unplugging the power in an emergency.**



- **Do not place the instrument on an unstable stand or angled surface.**

Doing so could cause the instrument to fall or overturn, resulting in bodily injury or damage to the instrument.

- **Place the instrument with its bottom side.**

Failure to do so could increase the internal temperature, resulting in bodily injury, fire, or damage to the instrument.

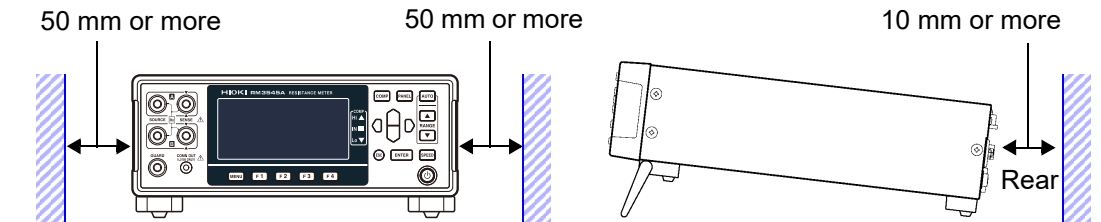

- The instrument can be used with the stand (p.19).
- This instrument can be rack mounted (p.354).

Handling the instrument



- Do not subject the product to vibration or mechanical shock while transporting or handling it.
- Do not drop the product.
- Do not apply voltage or current to measurement terminals, TEMP. terminal, COMP.OUT terminal, or D/A OUTPUT terminal.
Doing so could damage the product.

The instrument is classified as a Class A device under the EN 61326 standard.

Use of the instrument in a residential setting such as a neighborhood could interfere with reception of radio and television broadcasts.

If you encounter this issue, take steps as appropriate to address it.

Precautions for shipping

Store the instrument packaging material after opening the instrument. Use the original packaging when shipping the instrument.

Before measuring

⚠ WARNING

- **Do not apply voltage to the measurement terminals.**



Doing so could cause damage to the instrument or electric shock accidents.



- **Perform measurements after turning off the power to the measurement targets being measured.**

Doing so could cause an electrical hazard.

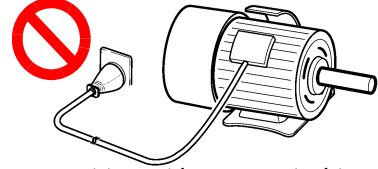

The measurement target is connected to a power supply.

⚠ CAUTION

- **Never attempt to measure at a point where voltage is present.**



Even if the power supply to the motor is turned off, while the motor is rotating inertially, high electromotive power is generated in terminals. When attempting to measure a transformer or motor immediately after voltage withstanding test, residual charge may damage the instrument.

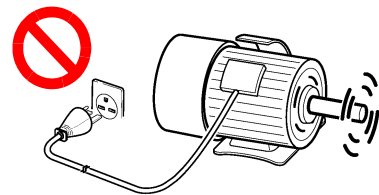

Rotating inertially

- **Never attempt to measure at a point where voltage is applied from a battery.**

The instrument cannot measure a part where a voltage is generated. Doing so could damage the product.

- **Never attempt to measure the internal resistance of a battery.**

The instrument will sustain damage.

To measure the internal resistance of a battery, use a Hioki battery tester, etc.

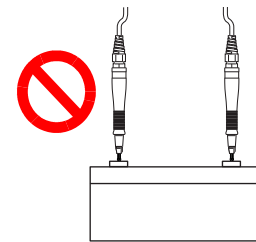

- **When the instrument is used in a way that connects to a withstanding voltage tester via switching relays, construct a testing line bearing the following in mind.**

See: "14.16 Using the Instrument with a Withstanding Voltage Tester" (p.351)

- The voltage withstanding specification of switching relays should include a safe margin over the withstanding testing voltage.
- During withstanding voltage testing, ground all of the instrument's terminals. Failure to do so could damage the instrument due to arc discharge in relay contacts.
- Perform resistance measurement first and the withstanding voltage test last. Failure to do so could damage the instrument due to residual charge.

3153 Automatic Insulation/Withstanding HiTester

Instrument

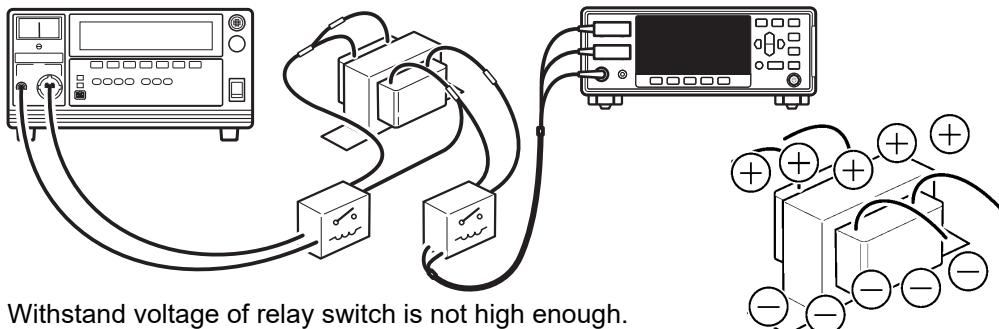

Withstand voltage of relay switch is not high enough.

Residual charge from voltage withstanding test is present.

IMPORTANT

- To obtain the guaranteed measurement accuracy, allow at least 60 minutes warm-up.
- When measuring devices such as power supply transformers with high inductance or open-type solenoid coils, measured value may be unstable. In such cases, try the following countermeasures.
 - Connect a film capacitor of about 1 μF between SOURCE A and SOURCE B.
 - Use the delay function (p.86) to set the pre-measurement delay.
- Make sure that the wiring connections for SOURCE A, SENSE A, SENSE B, and SOURCE B are isolated individually. Proper 4-terminal measurements cannot be performed and an error will occur if core and shield wires touch.
- The SOURCE terminal is protected by a fuse. If the fuse is tripped, the instrument will display **[Blown FUSE.]** and you will not be able to measure resistance values. If the fuse is tripped, replace the fuse.
See: “13.3 Replacing the Measurement Circuit’s Protective Fuse” (p.315)
- Since the instrument uses DC current for measurement, it may be affected by thermal EMF, resulting in a measurement error. If so, use the offset voltage compensation (OVC) function.
See: “4.8 Compensating for Thermal EMF Offset (OVC Function)” (p.83) and “14.10 Effect of Thermal EMF” (p.342)

1 Overview

1

1.1 Product Overview

The instrument uses the 4-terminal method to measure the following resistance values quickly and with a high degree of precision:

- Weld resistance in batteries, motors, and other devices
- Winding resistance in motors, transformers, and other devices
- Contact resistance in relays and switches
- Pattern resistance on printed circuit boards
- DC resistance of fuses, resistors, conductive rubber, and other materials

Since the instrument incorporates a temperature correction function, it is particularly well suited to the measurement of targets whose resistance values vary with temperature. It also provides features such as a comparator function, communications, external control, and a multiplexer^{*1}, allowing it to be used in a wide range of applications, including in development work and on production lines.

*1. The RM3545A-2 can be used for multiplexer-related control.

1.2 Features

High-performance specifications to meet advanced development and production needs

Broad measurement range: 1000 $\mu\Omega$ to 1000 M Ω

Maximum accuracy: 0.006% of reading + 0.001% of full scale

Maximum resolution: 1 n Ω

Low-resistance measurement of current detection resistors, reactors, welds, etc. is supported.

Up to 1 G Ω range

Discharge voltage of 20 mV or less

Low-power measurement can be used in testing under IEC 60512-2 and other contact standards.

Accuracy defined without zero adjustment

Route resistance^{*2} tolerance in low-resistance range: 2.6 Ω

Measurement cables can be extended easily, even when using the 1 A measurement current range.

*2. Route resistance is the total of all resistance components downstream from the instrument (wiring resistance + contact resistance).

Easy-to-use functions in research and development, on production lines, or in acceptance inspections



Graphical LCD
Operation is intuitive and easy to learn.

Easy configuration of comparator and panel load operation
Facilitates smooth setup changes on production lines.

Simple basic settings
Range and measurement speed can be set directly.

Guard terminal
You can reduce the effects of external noise by connecting the guard terminal.

LED comparator attachment (option)
Streamlines work by eliminating the need to look at the screen.

Judgment sounds with user-selectable patterns
Keeps you from mistaking audio from a nearby operator's instrument as your own.

Free power supply (100 V to 240 V) with automatic frequency switching
Allows the instrument to be easily moved to overseas production lines.

Extensive selection of interfaces
LAN, USB, RS-232C, EXT. I/O, and D/A output are included as standard

Support for a variety of temperature sensors
You can connect a radiation thermometer with analog output in addition to the included sensor.

Monitor and test functions
Provides robust support for line development by allowing you to check communications and EXT. I/O on the screen.

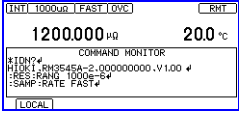

Example of command monitor screen

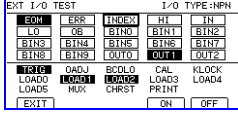

Example of EXT. I/O test screen

Multiplexer support to allow multipoint measurement and total judgments RM3545A-2



Measure up to 20 locations with 4-terminal measurement or 42 locations with 2-terminal measurement (when using two Z3003 units).

Multipoint measurement

Allows measurement of network resistors, steering switches, 3-phase motors, etc.

Total judgment

Outputs total judgment based on measurement results for tested locations.

Comparator judgments based on measurement results

Allows judgments to be based on comparisons with standard elements for measurement targets such as thermistors that are susceptible to the effects of temperature.

External instrument connectivity

Allows multipoint measurement, including for external measuring instruments such as LCR meters.

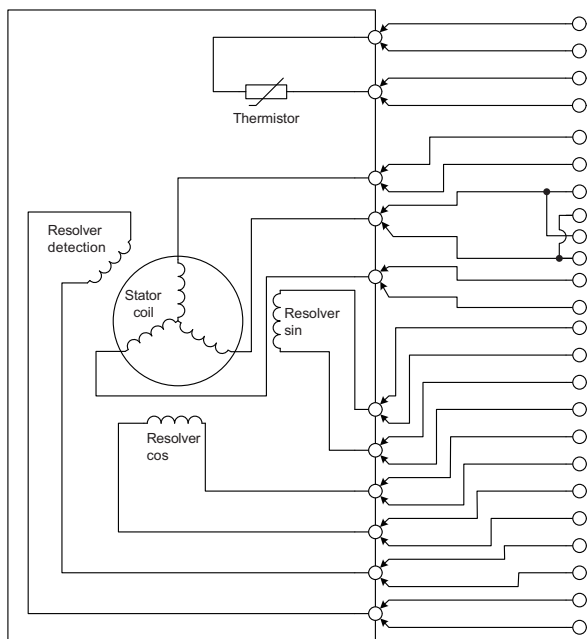

Z3003 Multiplexer Unit

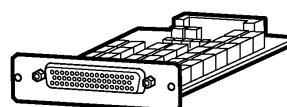

SW1001 Switch Mainframe

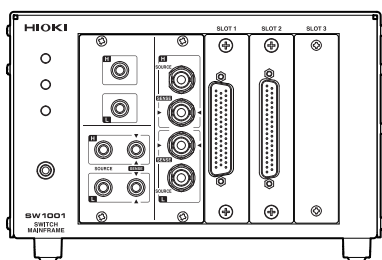

SW1002 Switch Mainframe

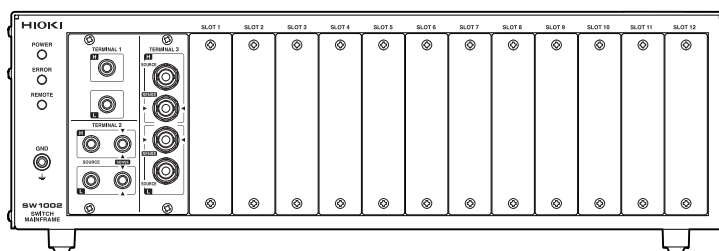





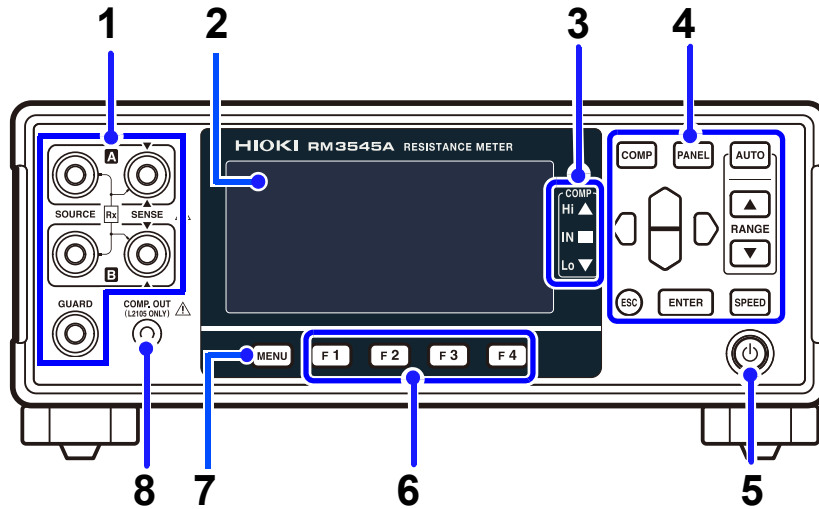



1.3 Part Names and Functions

Front



Number	Name	Description	See
1	Measurement terminals	Connect the measurement leads. <ul style="list-style-type: none"> • SOURCE A: Current detection terminal • SOURCE B: Current source terminal • SENSE A: Voltage detection terminal • SENSE B: Voltage detection terminal • GUARD: Guard terminal 	p.32
2	Display screen	Monochrome graphical LCD.	p.21
3	COMP indicator LEDs	Indicate the judgment result of the measured value when using the comparator function. <ul style="list-style-type: none"> Hi Upper limit value < measured value IN Pass (meets criteria) Lo Lower limit value > measured value 	p.99
4	Operation keys	See the following page.	p.17
5	STANDBY key	Initiates or cancels the standby state. <ul style="list-style-type: none"> Unlit: Power off (when no power supplied) Red light: Standby state (while power is supplied) Green light: Power on 	p.43
6	F keys (F1 to F4)	Selection of settings displayed on the screen.	—
7	MENU key	Displays the Settings screen or switches the pages.	—
8	COMP.OUT terminal	Connect the L2105 LED Comparator Attachment.	p.108

Operation keys

Key	Name	Description	See
	COMP key	Sets the comparator function.	p.99
	PANEL key	Saves or loads the settings. (Panel Save function, Panel Load function)	p.122
	AUTO key	Switches between the auto range and the manual range.	p.48
	RANGE key	Switches the measurement range when the manual range is selected.	
	Cursor key	Moves among items shown on the screen.	—
	ESC key	Cancels the settings displayed on the screen.	—
	ENTER key	Confirms the settings displayed on the screen.	—
		Allows manual measurement when using the external trigger [EXT] setting.	p.217
	SPEED key	Switches the measurement speed.	p.50

Rear

Example: The RM3545A-2 is shown.

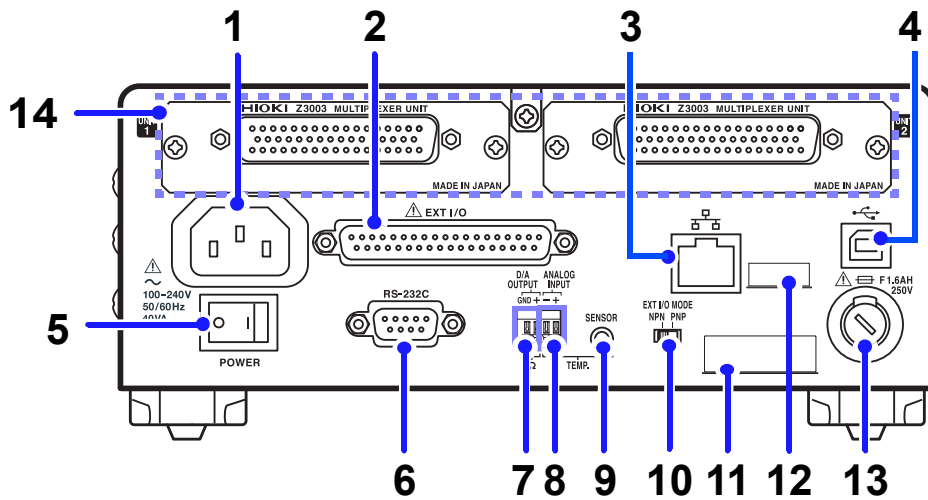

Number	Name	Description	See
1	Power inlet	Connect the included power cord.	p.31
2	EXT. I/O connector	Allows external control of the instrument.	p.185
3	LAN connector	Allows control of the instrument with a PC or PLC*1 through LAN communication (socket communication). The measurement data can be transferred to a PC.	p.238
4	USB connector	Allows control of the instrument with a PC or PLC*1 through USB communication (virtual COM port). The measurement data can be transferred to a PC.	p.233
5	Main power switch	Switches On/Off the main power supply of the instrument.	p.43
6	RS-232C connector	Allows control of the instrument with a PC or PLC*1 through RS-232C communication (serial communication). The measurement data can be transferred to a PC.	p.235
		Connect a printer to the instrument.	p.251
7	D/A OUTPUT terminal	Outputs a voltage level that correspond to the resistance value. Connect a device that can accept voltage input, for example, a Memory HiCorder.	p.181
8	TEMP.ANALOG INPUT terminal	Connect an analog output thermometer.	p.37
9	TEMP. SENSOR	Connect the Z2001 Temperature Sensor.	p.34
10	EXT. I/O MODE NPN/PNP switch	Allows you to change the type of PLC to be connected with the EXT. I/O connector. Left: Current sink (NPN) Right: Current source (PNP)	p.187

Number	Name	Description	See
11	Manufacturing number (serial number)	Composed of a 9-digit number. The two digits on the left represent the year of manufacture (the last two digits of the Western calendar year), and the following two digits represent the month of manufacture. Do not remove this label, as it is required for product support.	—
12	MAC address	MAC address of LAN	—
13	Fuse holder	For replacement of the fuse.	p.315
14	Multiplexer unit slot RM3545A-2	Install the Z3003 Multiplexer Unit. (Max. 2)	p.41

*1. Programmable controller

Bottom

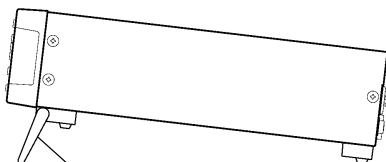
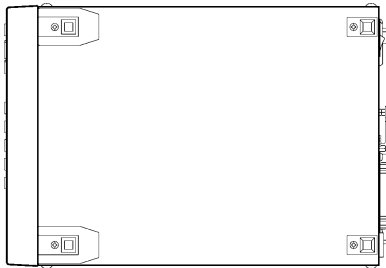

Stand

This instrument can be rack mounted.

Reference: Rack mounting (p.354)

When using the stand

Extend the legs all the way. Do not extend partially. Make sure to extend both legs of the stand.

With the stand closed

Be sure to close all the way, without stopping part-way.



CAUTION

- Do not subject the instrument to excessive force from above when the stands are extended.



Doing so could damage the stands.

1.4 Measurement Process

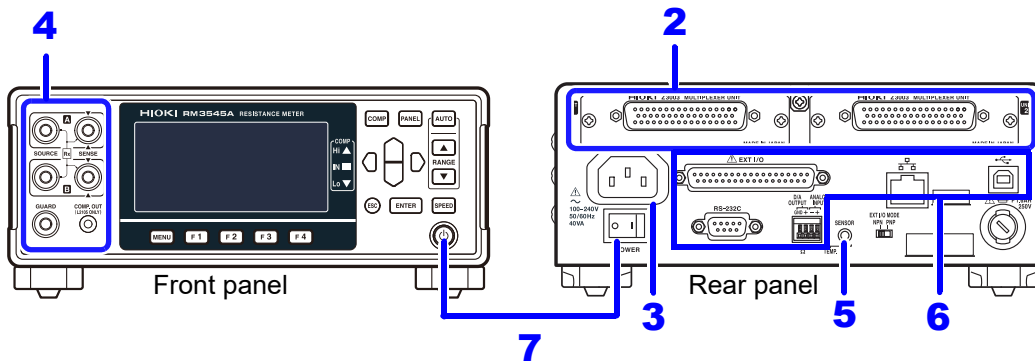

1 Inspect the instrument before the measurement (p.30)

2 Install a multiplexer unit (RM3545A-2 only; as necessary) (p.41)

3 Plug the power cord into the power outlet (p.31)

4 Connect measurement leads to the measurement terminals. (p.32)

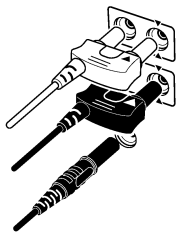

(Connect connectors to the Multiplexer Unit as necessary.)

5 Connect the temperature sensor or infrared thermometer (When using the temperature correction function or ΔT) (p.34)

6 Connect the external interface (as needed)

- Using the printer (p.251)
- Using USB, RS-232C, or LAN (p.231)
- Using the EXT. I/O (p.185)
- Using D/A Output (p.181)

7 Turn on the instrument and cancel the standby state (p.43)

Main power switch: Rear STANDBY key: Front

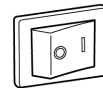

8 Check the measurement target (p.46)

9 Make instrument settings

- Measurement range (p.48)
- Measurement speed (p.50)
- Settings in accordance with the measurement target (p.63)
(Low-power mode, measurement currents, TC/ ΔT , OVC, pure resistance mode, contact check, etc.)

10 Perform zero adjustment (p.69) (as needed)

- Always perform zero adjustment in the 2-terminal measurement.
- Zero adjustment is not required for the four-terminal measurement.
- If the OVC function is set to on, the zero-point adjustment is included in the correction and zero adjustment is not required.

11 Connect the measurement leads to the measurement target (p.52)

12 When finished measuring, turn the power off (p.43)

1.5 Screen Organization and Operation Overview

The instrument's screen interface consists of a Measurement screen and various Settings screens. The screen examples in this guide appear reversed (black on white) for best visibility. However, the instrument screens can actually be displayed only as white characters on a black background.

Measurement screen layout

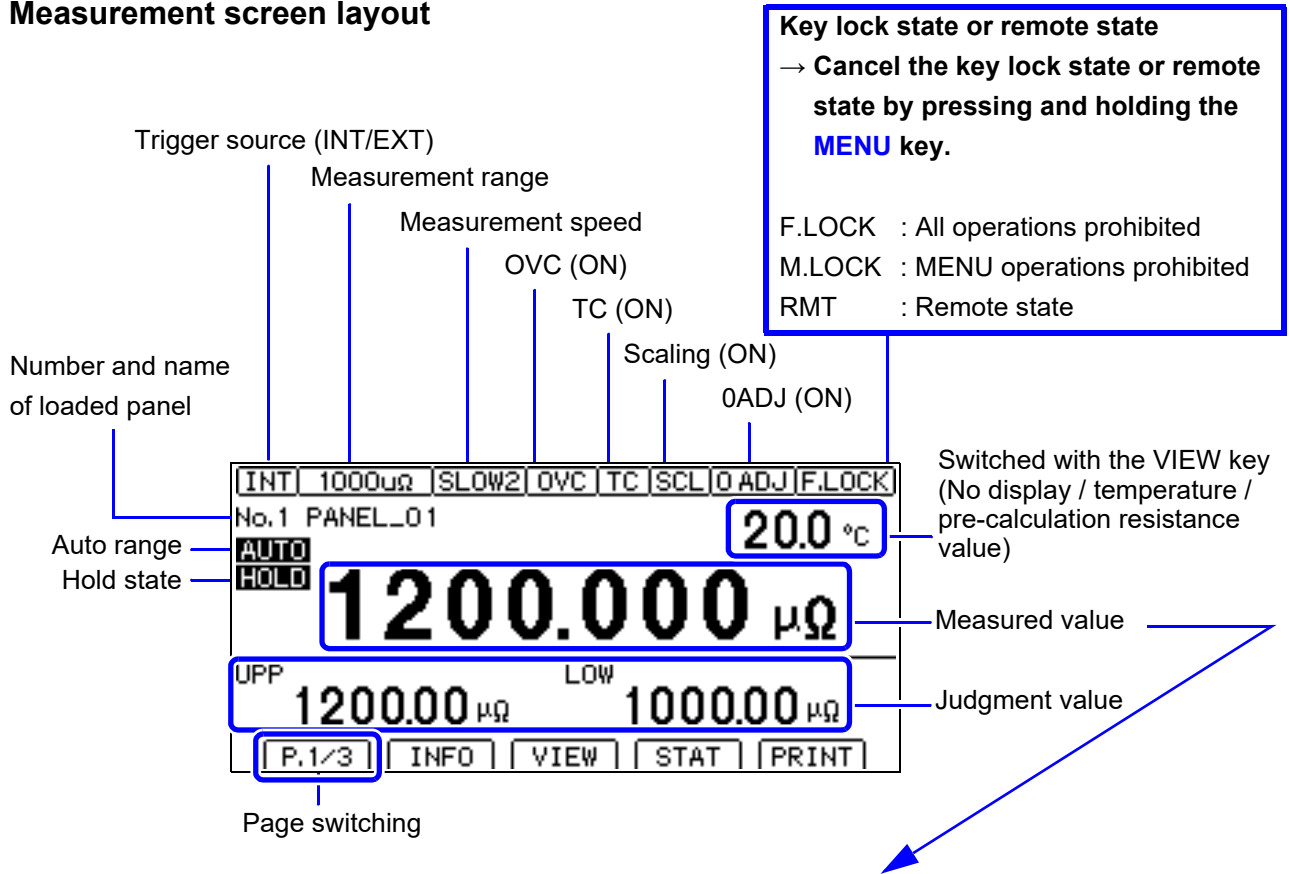

Display of information other than the measured values (for more information, see “Confirming measurement faults” (p.56))

Display	Description
+OvrRng -OvrRng	Over-range
CONTACT TERM.A CONTACT TERM.B	Contact error
-----	Not measured, or broken connection in measurement target*1

*1. To treat current faults (when the SOURCE wiring is open) as over-range events, change the current fault output mode setting. (p.60)

When the scan function is set to auto or step **RM3545A-2**

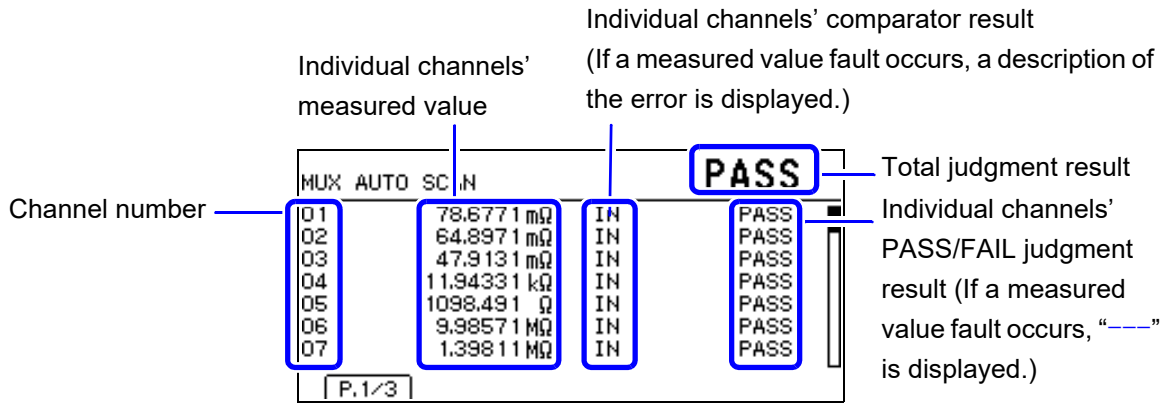

Overview of screen operation

(1) Measurement screen

Menu switching



P.3/3 is only displayed on the RM3545A-2.

(4) To Settings screens

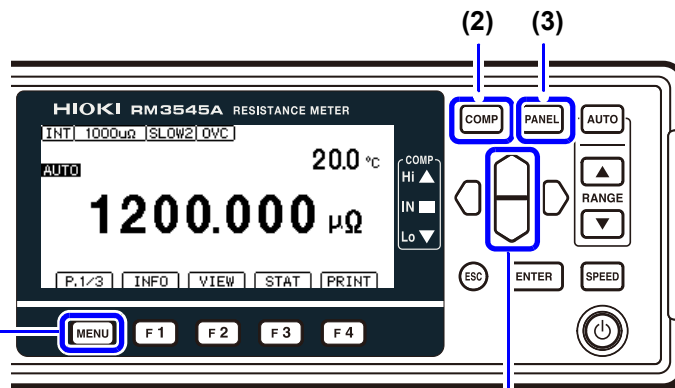

When the measurement terminal setting is MUX (multiplexer): Select the channel.

(2) Comparator Settings screen

- 1 Select the mode with an F key.
- 2 Change the range with .
- 3 Move among digits. Change values.
- 4 Accept the setting with the **ENTER** key or cancel with the **ESC** key.

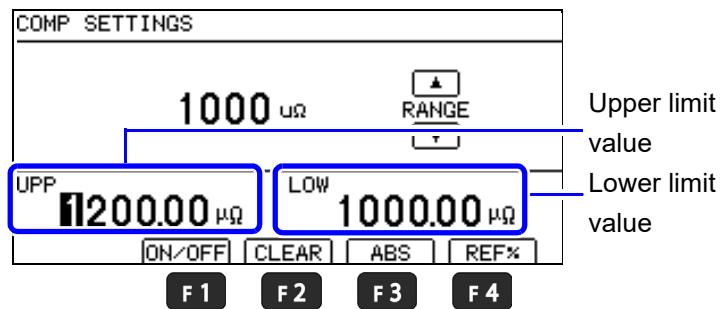

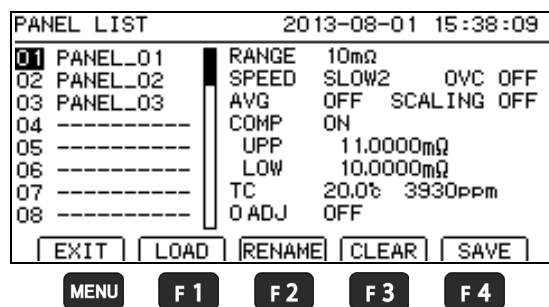

(3) Panel Save/Load screen

- 1 Select a panel number.
- 2 Perform action with an F key.
- 3 Return to the Measurement screen with the **MENU** key.



(4) Settings screen

- 1  **[MEAS] [SYS] [I/O] [IF] [BIN]**
[MUX1]*1 [MUX2]*1
 Move among tabs.
 *1. MUX1 or MUX2 is only displayed on the RM3545A-2.
- 2  Select a setting.  Move among settings.
- 3 Switch functions with an F key or set values.
- 4 Return to the Measurement screen with the **MENU** key.

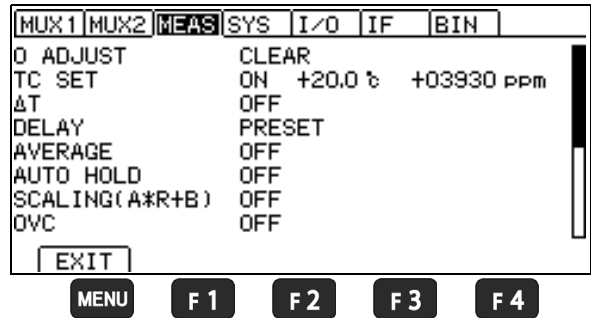



When the measurement terminal setting is MUX (multiplexer)

Set the measurement conditions by channel.

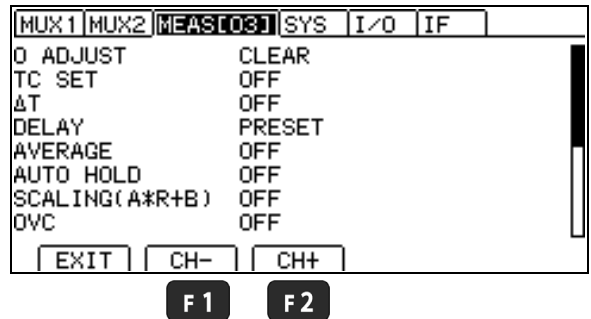
- F1 [CH-]**: Changes (decreases) the channel.
- F2 [CH+]**: Changes (increases) the channel.



< Setting values >

- 1 Make the value editable with the **F4** key.
- 2  Move among digits.  Change values.
- 3 Accept the setting with the **ENTER** key or cancel with the **ESC** key.

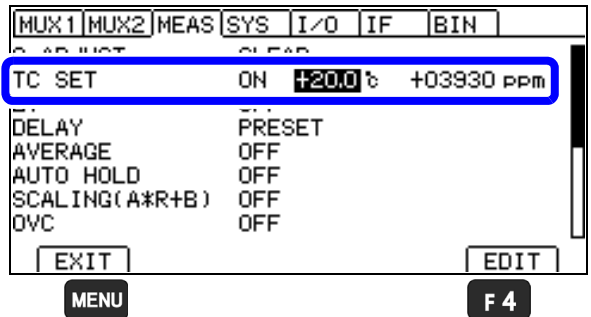

List of settings

RM3545A-1

Screen		Setting and key	Overview	See
Measurement screen		COMP	Comparator function	p.99
		PANEL	Saving and loading panels	—
		AUTO	Measurement ranges	p.48
		▲▼ (RANGE)		
		SPEED	Measurement speed	p.50
Measurement screen (P.1/2)		INFO (F1)	Display setting conditions	p.55
		VIEW (F2)	Switch measurement screen display	p.53
		STAT (F3)	Display statistical calculation results	p.112
		STOP (F3)	Stop scan	—
		PRINT (F4)	Printing	p.252
Measurement screen (P.2/2)		0 ADJ (F2)	Zero adjustment	p.69
		LOCK (F3)	Key lock	p.130
		SETTING (F4)	Switch to Settings screen	
Setting screen (SETTING)	Measurement Setting screen (MEAS)	0 ADJUST	Clear zero adjustment	p.72
		TC SET	Temperature correction	p.76
		ΔT	Temperature conversion	p.118
		R0, T0		
		k		
		DELAY	Delay	p.86
		AVERAGE	Averaging	p.74
		AUTO HOLD	Holding measured values	p.61
		SCALING(A*R+B)	Scaling	p.78
		A:		
		B:		
		UNIT:		
		OVC	Offset voltage compensation function (OVC)	p.83
		LOW POWER	Low-power mode (LP)	p.65
		PURE RESISTANCE	Pure resistance mode (PR)	p.85
		MEAS CURRENT	Current switching	p.67
		Ω DIGITS	Set the display digits	p.82
		CURR ERROR MODE	Current fault output format	p.60
		CONTACT CHECK	Contact check function	p.90
		CONTACT IMPRV	Contact improvement function	p.92
100MΩ PRECISION	100 MΩ range high-precision mode	p.98		

Screen	Setting and key	Overview	See	
Setting screen (SETTING)	System Setting screen (SYS)	STATISTICS	Statistical calculations function	p.114
		TEMP INPUT	Temperature sensor settings	p.34
		ANALOG SET1		
		ANALOG SET2		
		CALIBRATION	Self-calibration	p.94
		KEY CLICK	Set the operation sound	p.132
		COMP BEEP Hi	Judgment beeper setting	p.106
		IN		
		Lo		
		PANEL LOAD 0ADJ	Load zero adjustment values	p.124
		CONTRAST	Set the contrast	p.134
		BACK LIGHT	Set the contrast brightness	p.135
		POWER FREQ	Set the power frequency	p.133
		CLOCK	Clock settings	p.136
		RESET	Reset the instrument	p.137
		ADJUST	Adjust the instrument	p.362
	EXT. I/O Setting screen (I/O)	TRIG SOURCE	Trigger source	p.217
		TRIG EDGE	Set the trigger signal logic	p.219
		TRIG/PRINT FILT	Trigger/print filter function	p.221
		EOM MODE	EOM signal setting	p.223
		JUDGE/BCD MODE	EXT. I/O output mode	p.225
		OVRrng ERR OUT	Over-range error output	p.226
		EXT. I/O TEST	EXT. I/O test	p.227
	Communications Interface Setting screen (IF)	INTERFACE	Interface settings	p.232
		SPEED	Communications	p.231
		LAN		
		DATA OUT		
		CMD MONITOR		
		PRINT INTRVL	Printing	p.251
		PRINT COLUMN		
	STAT CLEAR			
	BIN Setting screen (BIN)	BIN	BIN measurement settings	p.109

RM3545A-2

Screen		Setting and key	Overview	See
Measurement screen		COMP	Comparator function	p.99
		PANEL	Saving and loading panels	—
		AUTO	Measurement ranges	p.48
		▲▼ (RANGE)		
		SPEED	Measurement speed	p.50
Measurement screen (P.1/3)		INFO (F1)	Display setting conditions	p.55
		VIEW (F2)	Switch measurement screen display	p.53
		STAT (F3)	Display statistical calculation results	p.112
		STOP (F3)	Stop scan	—
		PRINT (F4)	Printing	p.252
Measurement screen (P.2/3)		0 ADJ (F2)	Zero adjustment	p.69
		LOCK (F3)	Key lock	p.130
		SETTING (F4)	Switch to Settings screen	—
Measurement screen (P.3/3)		FRONT (F1)	Use of the multiplexer	p.157
		MUX (F2)	Use the front measurement terminals	
		SCANSET (F3)	Scan function	
Setting screen (SETTING)	Multiplexer Channel Settings screen (MUX1)	CH	Use of channels	p.159
		TERM A B	Channel terminals	
		INST	Measuring instruments for each channel	
		0 ALL	Scan channels Zero adjustment settings	p.169
		0 ADJ	Individual channels' zero adjustment status	
	Multiplexer Basic Measurement screen (MUX2)	SPD	Individual channels' measurement speed	p.163
		RANGE	Individual channels' range	
		UPP/REF	Individual channels' comparator settings	
		LOW/%		
PASS	Individual channels' PASS conditions			

Screen		Setting and key	Overview	See	
Setting screen (SETTING)	Measurement Setting screen (MEAS)*1	0 ADJUST	Clear zero adjustment	p.72	
		TC SET	Temperature correction	p.76	
		ΔT	Temperature conversion	p.118	
		R0, T0			
		k			
		DELAY	Delay	p.86	
		AVERAGE	Averaging	p.74	
		AUTO HOLD	Holding measured values	p.61	
		SCALING(A*R+B)	Scaling	p.78	
		A:			
		B:			
		UNIT:			
		OVC	Offset voltage compensation function (OVC)	p.83	
		LOW POWER	Low-power mode (LP)	p.65	
		PURE RESISTANCE	Pure resistance mode (PR)	p.85	
		MEAS CURRENT	Current switching	p.67	
		Ω DIGITS	Set the display digits	p.82	
		CURR ERROR MODE	Current fault output format	p.60	
		CONTACT CHECK	Contact check function	p.90	
		CONTACT IMPRV	Contact improvement function	p.92	
	100M Ω PRECISION	100 M Ω range high-precision mode	p.98		
	System Setting screen (SYS)	TERMINAL	Measurement terminal settings	p.145	
		WIRE	Multiplexer measurement method		
		SCAN MODE	Scan function		
		FAIL STOP	Stop at FAIL during scan		
		UNIT TEST	Z3003 unit test	p.172	
		STATISTICS	Statistical calculations function	p.114	
		TEMP INPUT	Temperature sensor settings	p.34	
		ANALOG SET1			
		ANALOG SET2			
		CALIBRATION	Self-calibration	p.94	
		KEY CLICK	Set the operation sound	p.132	
		COMP BEEP	Hi	Judgment beeper setting	p.106
			IN		
			Lo		
			PASS		
		FAIL			
PANEL LOAD 0ADJ		Load zero adjustment values	p.124		
CONTRAST		Set the contrast	p.134		
BACK LIGHT		Set the contrast brightness	p.135		
POWER FREQ		Set the power frequency	p.133		
CLOCK	Clock settings	p.136			
RESET	Reset the instrument	p.137			
ADJUST	Adjust the instrument	p.362			

1.5 Screen Organization and Operation Overview

Screen		Setting and key	Overview	See
Setting screen (SETTING)	EXT. I/O Setting screen (I/O)	TRIG SOURCE	Trigger source	p.217
		TRIG EDGE	Set the trigger signal logic	p.219
		TRIG/PRINT FILT	Trigger/print filter function	p.221
		EOM MODE	EOM signal setting	p.223
		JUDGE/BCD MODE	EXT. I/O output mode	p.225
		OVRNG ERR OUT	Over-range error output	p.226
		EXT. I/O TEST	EXT. I/O test	p.227
	Communications Interface Setting screen (IF)	INTERFACE	Interface settings	p.232
		SPEED	Communications	p.231
		LAN		
		DATA OUT		
		CMD MONITOR		
		PRINT INTRVL	Printing	p.251
	PRINT COLUMN			
	STAT CLEAR			
BIN Setting screen (BIN)	BIN	BIN measurement settings	p.109	

*1. When using the multiplexer, the selected channel number will be displayed next to "MEAS."

2 Measurement Preparations

For information about the rack mounting, see “14.18 Rack Mounting” (p.354).

This chapter describes preparations to be performed before starting measurements.

“2.1 Pre-Operation Inspection” (p.30)



“2.2 Connecting the Power Cord” (p.31)



“2.3 Connecting Measurement Leads” (p.32)



“2.4 Connecting Z2001 Temperature Sensor or Thermometer with Analog Output
(When using the TC or ΔT)” (p.34)



“2.5 Installing the Multiplexer Unit” (p.41)



“2.6 Turning the Power On and Off” (p.43)

2.1 Pre-Operation Inspection



■ Before use, verify that test lead insulation is not torn and that no metal is exposed.



■ Before use, inspect the instrument and verify that it's operating properly.

Using test leads or an instrument that is damaged could result in serious bodily injury. If you discover any damage, replace with a Hioki-specified part.

Inspection of included accessories and options

Inspection points	Remedy
The power cord insulation is not torn. Metal is not exposed on the power cord.	If damaged Do not use the instrument as electric shock or short-circuit accidents could result. Contact your authorized Hioki distributor or reseller.
The insulation on a measurement lead is not torn. Metal is not exposed on a measurement lead.	If damaged Using the instrument in such condition could cause an electric shock. Contact your authorized Hioki distributor or reseller for replacements.

Instrument inspection

Inspection points	Remedy
No evident damage to the instrument.	If damaged Request repair.
When turning power on The STANDBY key lights up in red or green.	If the key does not light up The power cord may be damaged, or the instrument may be damaged internally. Request repair.
After the completion of the self-test (when the model number is shown on the screen), the Measurement screen is displayed.	If an error indication occurs The instrument may be damaged internally. Request repair. See: "13.2 Troubleshooting" (p.301), "Error displays" (p.312)

2.2 Connecting the Power Cord

⚠ WARNING



- **Connect the power cord to a grounded, two-prong power outlet.**

Connecting the product to an ungrounded power outlet could cause the operator to experience an electric shock.

- **Ensure that the insulation on the cables are undamaged and that no bare conductors are improperly exposed before use.**

Any damage to the instrument leads to electric shock. Contact your authorized Hioki distributor or reseller.

⚠ CAUTION



- **Do not use a power supply that generates rectangular wave or pseudo-sine wave output (an uninterruptible power supply, DC/AC inverter, etc.) to power the instrument.**

Doing so could cause damage to the instrument, resulting in bodily injury.



- **When unplugging the power cord from the outlet or product, pull on the plug (not the cord).**

Failure to do so could cause a wire break in the power cord.

- **Before connecting the power cord, make sure the supply voltage to be used falls inside the voltage range indicated on the power connector of the instrument.**

Supplying a voltage that falls outside the specified range to the instrument could damage the instrument, causing bodily injury.

Turn off the instrument before connecting or disconnecting the power cord.

Rear

Power inlet

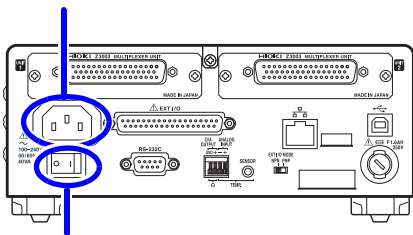

Main power switch

- 1 Confirm that the instrument's Main power switch (rear panel) is off (○).
- 2 Confirm that the mains supply voltage matches the instrument, and connect the power cord to the power inlet on the instrument.
- 3 Plug the power cord into the power outlet.

If power to the instrument is cut off with the power switch in the on position (by a circuit breaker, etc.), the instrument will start up when power is restored, without any need to press the STANDBY key.

2.3 Connecting Measurement Leads

Connect the optional measurement leads to the measurement terminals.

Reference: "Options" (p.3)

DANGER

- **Do not use cables whose insulation is damaged or whose metal portion is exposed.**



Doing so could cause serious bodily injury.

- **Do not short wires carrying a voltage with the tips of the test leads.**

Doing so could cause a short-circuit, resulting in serious bodily injury.

WARNING

- **When using the instrument while connected to test leads, use the lower of the ratings indicated on the instrument and on the test leads.**



Using the product to make measurements that exceed either rating could cause the operator to experience an electric shock.



- **Cut off power to measurement lines before connecting them to measurement terminals.**

Failure to do so this can cause electric shock or a short-circuit.

CAUTION

- **Do not step on cords or allow them to become caught between other objects.**

Doing so may damage insulation, resulting in bodily injury.



- **Do not bend, pull on, or twist cables, including where they connect, with excessive force.**

Failure to do so could cause a wire break in cables.

- **Do not touch the tips of pin-type lead.**

Since the ends of the pin type lead are sharp, doing so could cause injury to the operator.



- **When disconnecting the connector, pull on the connector (not the cord).**

Failure to do so could cause a wire break in cables.

IMPORTANT

- When using this instrument, it is recommended to use Hioki-specified test leads. Using a lead other than the specified part could result in issues such as incomplete contact, preventing accurate measurement.
- When making your own measurement leads or extending a measurement lead, see "14.14 Making Your Own Measurement Leads, Making Connections to the Multiplexer" (p.348).

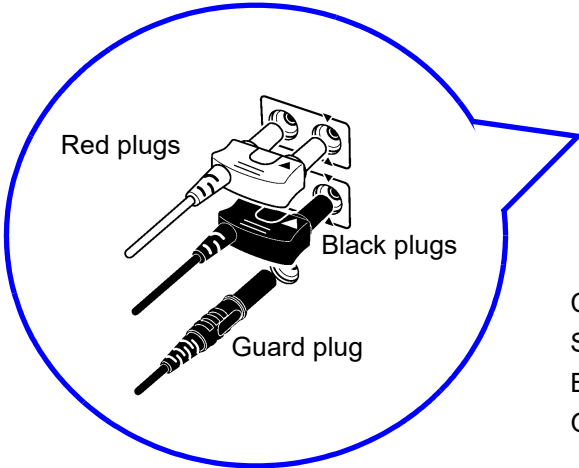

Connect the red plugs to the SOURCE A and SENSE A terminals, the black plugs to the SOURCE B and SENSE B terminals, and the guard plug to the GUARD terminal.

Measurement leads

(Example: When using the L2101 Clip Type Lead)

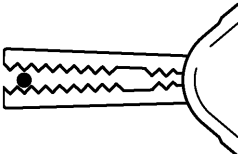
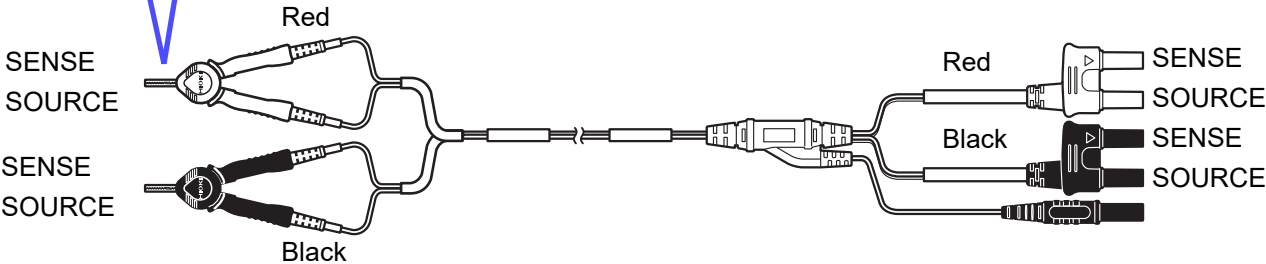
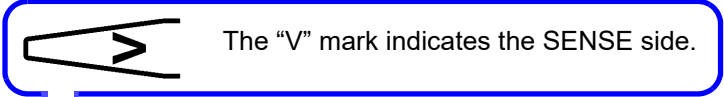

When clipping a small-gauge wire
(Clip with the tip of the alligator clips.)

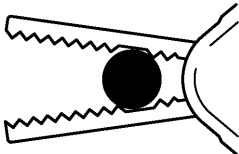

When clipping a large-gauge wire
(Clip with the back of the alligator clips, where there are no teeth.)

2.4 Connecting Z2001 Temperature Sensor or Thermometer with Analog Output (When using the TC or ΔT)

Connecting the Z2001 Temperature Sensor

CAUTION

- **Do not apply high-voltage pulses or static electricity to the temperature sensor.**

Applying a voltage pulse or static electricity could damage the sensor.



- **Do not apply excessive force to the tip of the temperature sensor or forcibly bend the lead.**

Doing so could damage the temperature sensor.

- **Do not use the temperature sensor in environments where it would be exposed to large amounts of dust or direct contact with water.**

The temperature sensor does not have a dust-proof or waterproof design. The sensor could be damaged if dust or water gets inside it.



- **Ensure that the temperature sensor's grip and compensating lead wire do not exceed the specified temperature range.**

Doing so could damage the temperature sensor.

- **Seat connectors securely.**

Failure to do so could damage the instrument or prevent it from performing to specifications.

- **Turn off the instrument's main power switch before connecting the temperature sensor.**

Failure to do so could damage the instrument or the temperature sensor.

IMPORTANT

- Connect the temperature sensor by inserting the plug all the way into the TEMP.SENSOR terminal. A loose connection can cause a large error component in measured values.
- If the part of the temperature sensor that connects to the instrument becomes dirty, wipe it clean. The presence of dirt may affect temperature measured values by increasing the contact resistance.
- Exercise care so that the temperature sensor connector does not become disconnected. (If the sensor is disconnected, it will not be possible to perform temperature correction or temperature conversion.)
- When connecting the temperature sensor, do not connect anything to the TEMP.ANALOG INPUT terminal. Doing so may cause erroneous measured values to be displayed.
- Allow the measurement target for which temperature correction is being performed and the temperature sensor to adjust to the ambient temperature prior to measurement (for more than 10 minutes). Failure to do so will result in a large error component.
- Handling of the temperature sensor with bare hands may cause the sensor to pick up inductive noise, resulting in unstable measured values.
- The temperature sensor is designed for use in applications in which ambient temperature is measured. It is not possible to accurately measure the temperature of the measurement target itself by placing the sensor in contact with the surface of the target. Use of an infrared thermometer to perform correction is appropriate when there is a large temperature difference between the ambient environment and the measurement target.

2.4 Connecting Z2001 Temperature Sensor or Thermometer with Analog Output (When using the TC or ΔT)

Rear

TEMP.SENSOR terminal

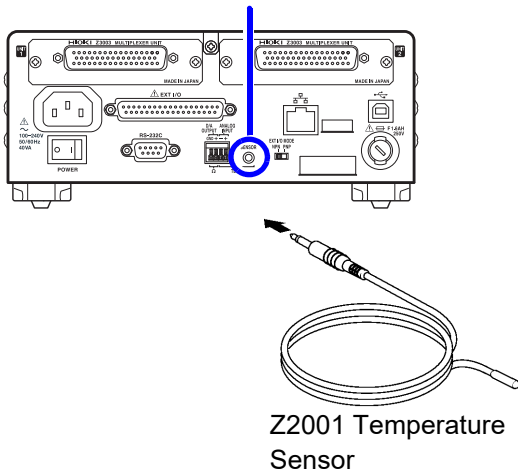

- 1** Confirm that the instrument's main power switch (rear panel) is off (○).
- 2** Connect the Z2001 Temperature Sensor into the TEMP.SENSOR terminal on the rear panel.

IMPORTANT

- Connect the temperature sensor by inserting the plug all the way.
- Do not connect anything to the TEMP.ANALOG INPUT terminal.

- 3** Place the tip of the temperature sensor near the measurement target.
- 4** Configure temperature measurement.

2

2.4 Connecting Z2001 Temperature Sensor or Thermometer with Analog Output (When using the TC or ΔT)

After turning on the instrument, check whether the temperature measurement settings are correct. Change if necessary.

1 Open the Measurement Setting screen.

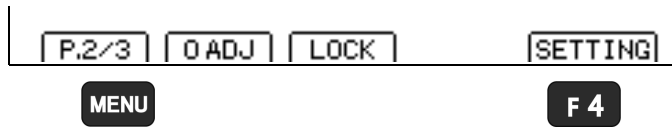

1 **MENU** Switch the function menu to P.2/3.

2 **F 4** The Settings screen appears.

2 Open the System Setting screen.

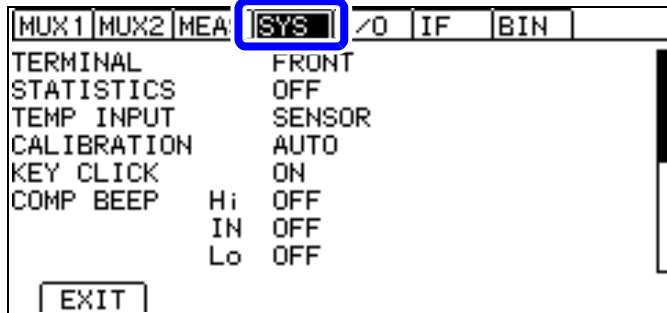

Move the cursor to the **[SYS]** tab with the left and right cursor keys.

3 Select **[TEMP INPUT]** and press **F 3** **[SENSOR]**.

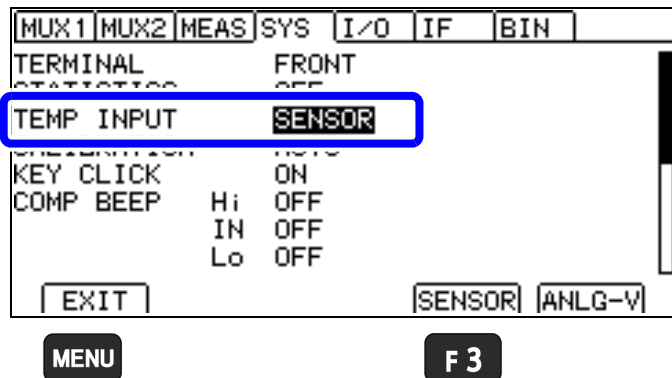

1 Selection

2
F 3 Thermistor sensor (Z2001)

MENU Return to the Measurement screen.

Connecting an analog output thermometer

To measure temperature, connect the analog output thermometer to the instrument.

WARNING



- **Since the temperature measurement circuit is grounded, connect the TEMP.ANALOG INPUT terminal on the rear panel with the analog output thermometer isolated from the ground.**

Failure to do so could cause the operator to experience an electric shock or damage the instrument.

CAUTION



- **Do not input a voltage outside the range from 0 V to 2 V (between terminal contacts) using the analog output thermometer.**

Doing so could damage the product.



- **Seat connectors securely.**

Failure to do so could damage the instrument or prevent it from performing to specifications.

- **Before connecting a thermometer to the instrument, confirm that any power to the instrument and thermometer is turned OFF.**

Doing so could damage the product.

IMPORTANT

- When using a thermometer that generates 4 mA to 20 mA of output, connect a shunt resistor of about 50 Ω between the positive (+) and negative (-) terminals of the thermometer and convert the output to a voltage prior to connecting it to the TEMP. ANALOG INPUT terminal on the rear of the instrument. With a 50 Ω resistor connected, the reference voltage (V_1 , V_2) settings are 0.20 V (V_1) and 1.00 V (V_2).
- When connecting the thermometer, do not connect anything to the TEMP.SENSOR terminal. Doing so may cause erroneous measured values to be displayed.

2.4 Connecting Z2001 Temperature Sensor or Thermometer with Analog Output (When using the TC or ΔT)

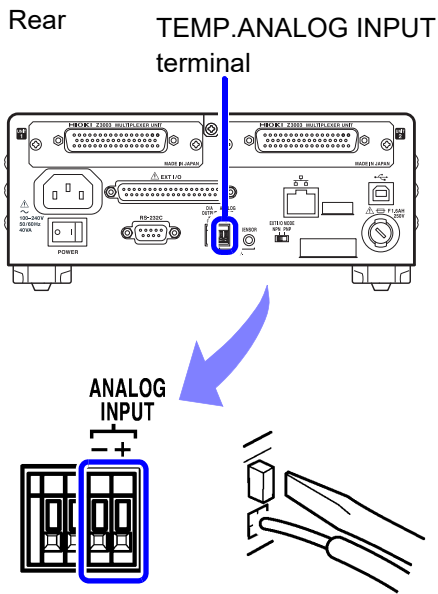

- 1** Confirm that the instrument's main power switch (rear panel) is off (○).
- 2** Connect the thermometer's analog output connector to the TEMP.ANALOG INPUT terminal on the rear panel, using a cable.

IMPORTANT

- Insert the thermometer's analog output connector securely all the way into the terminal block.
- Do not connect anything to the TEMP.SENSOR terminal.

- 3** Configure temperature measurement.

Compatible wire type:	Single wire AWG22 ($\varnothing 0.65$ mm) Stranded wire AWG22 (0.32 mm ²) Strand diameter $\varnothing 0.12$ mm or more
Compatible wires:	Single wire AWG28 ($\varnothing 0.32$ mm) to AWG22 ($\varnothing 0.65$ mm) Stranded wire AWG28 (0.08 mm ²) to AWG22 (0.32 mm ²) Strand diameter $\varnothing 0.12$ mm or more
Standard bare wire length:	9 mm to 10 mm

2.4 Connecting Z2001 Temperature Sensor or Thermometer with Analog Output (When using the TC or ΔT)

After turning on the instrument, check whether the temperature measurement settings are correct. Change if necessary.

1 Open the Settings screen.

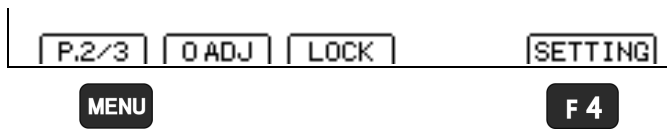

1 **MENU** Switch the function menu to P.2/3.

2 **F 4** The Settings screen appears.

2

2 Open the System Setting screen.

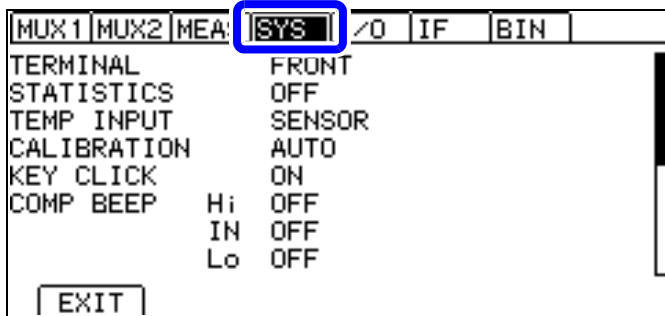

Move the cursor to the **[SYS]** tab with the left and right cursor keys.

3 Select TEMP INPUT and press **F 4** (ANLG-V).

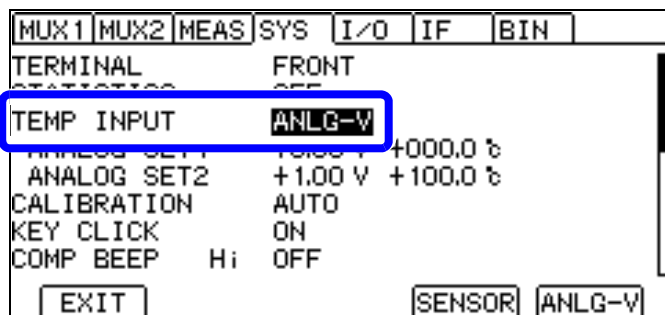

1  Selection

2 **F 4** Analog input

F 4

4 Set two reference voltages and the corresponding reference temperatures.

(Set reference voltages V_1 and V_2 and reference temperatures T_1 and T_2 by following Steps **1** to **3**.)

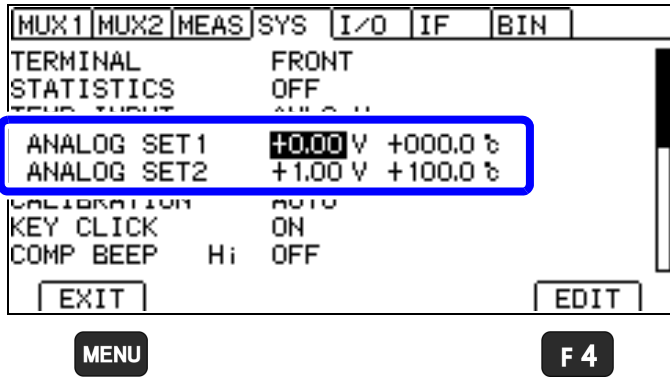

1 Move the cursor to the setting you wish to configure. Make the value editable with the **F4** key.

2 Move among digits. Change values. Move the cursor to the digit you wish to set with the left and right cursor keys. Change the value with the up and down cursor keys.

3 **ENTER** Accept
(**ESC** Cancel)

Setting range reference voltage (V_1, V_2): 00.00 to 02.00 V (default V_1 : 0 V, V_2 : 1 V)

Reference temperature (T_1, T_2): -99.9 to 999.9°C (default T_1 : 0°C, T_2 : 100°C)

MENU Return to the Measurement screen.

The displayed value is calculated by the following expression.

$$\frac{T_2 - T_1}{V_2 - V_1} \times (\text{Input voltage}) + \frac{T_1 V_2 - T_2 V_1}{V_2 - V_1}$$

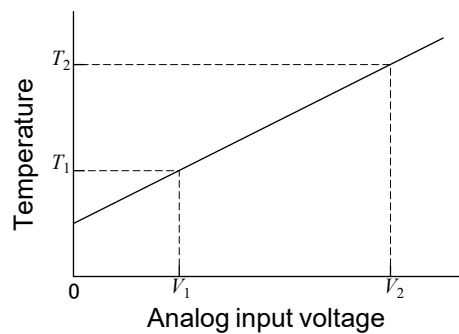

2.5 Installing the Multiplexer Unit

To use multiplexing capability, you must first install the Z3003 Multiplexer Unit.

WARNING



- **Turn off the product and disconnect any cables before inserting or removing any multiplexer unit.**

Failure to do so could cause the operator to experience an electric shock or damage the instrument or multiplexer unit.

- **When connecting a measurement target with electromotive force (a battery or power supply), take steps to protect against short-circuits.**

Failure to do so could cause damage to the instrument or measurement targets or cause fire.

- **If not connecting a multiplexer unit, attach the blank panel.**

Failure to do so could cause the operator to experience an electric shock or damage the instrument.

CAUTION



- **Do not connect the multiplexer unit directly with a dielectric strength tester or insulation resistance tester.**

The Z3003 Multiplexer Unit's maximum allowable voltage for contacts is ± 60 V DC, or 30 V AC rms and 42.4 V AC peak. Supplying a voltage that exceeds the maximum allowable voltage could damage the instrument.



- **Once you have inserted the multiplexer unit, tighten the screws securely.**

- **Seat connectors securely.**

Failure to do so could damage the multiplexer unit or prevent it from performing to specifications.

- **When inserting in the unit, hold the metal plate.**

Directly touching the board may cause damage of the unit or accuracy deteriorations in the higher resistance ranges due to the influence of static electricity. Taking countermeasures against static electricity (using antistatic devices such as a wrist strap) as well as wearing antistatic gloves are recommended.

- **When not using the multiplexer unit, store it using the packaging materials in which it was delivered.**

Failure to do so could damage the multiplexer unit.

2.5 Installing the Multiplexer Unit

Rear

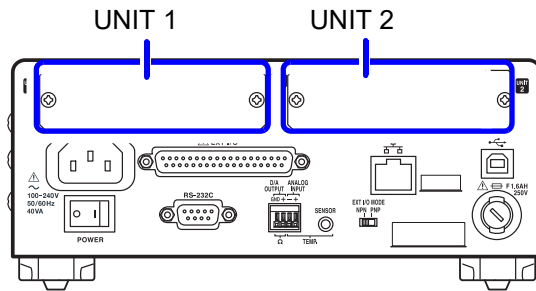

When using only one Multiplexer Unit, it can be installed as either UNIT 1 or UNIT 2.

Required tools: Phillips screwdriver

- 1** Turn off the instrument's main power switch and disconnect the cords and leads.
- 2** Remove the two screws with a Phillips head screwdriver and remove the blank panel.
- 3** With attention to the orientation of the Multiplexer Unit, insert it firmly all the way in. Insert the unit after aligning it with the guide rail. Do not directly touch the board.

Taking countermeasures against static electricity (using antistatic devices such as a wrist strap) as well as wearing antistatic gloves are recommended.

- 4** Using the Phillips screwdriver, tighten the two Multiplexer Unit mounting screws.

Configure the settings so that they match the unit number used.

See: "Customizing channel pin allocation" (p.158)

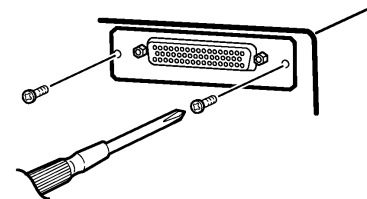
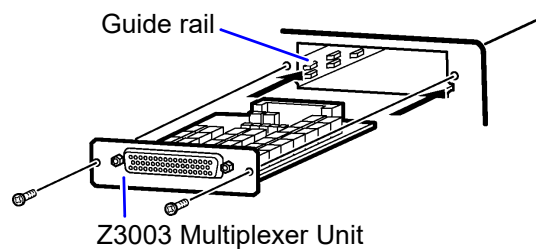
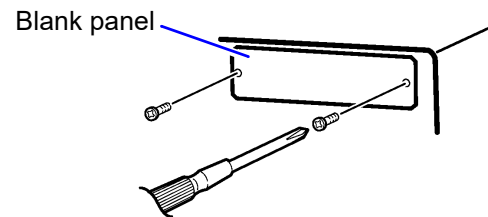

Removing a Multiplexer Unit

After turning off the instrument's main power switch and disconnecting all cords and leads, remove the Multiplexer Unit by reversing the above procedure and then attach the blank panel.

2.6 Turning the Power On and Off

Turning on the instrument with the main power switch

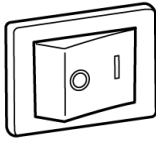

Power on |

Turn on (|) the main power switch on the rear of the instrument. If the main power switch was turned off while the instrument was not in the standby state, the standby state will be automatically canceled when the main power switch is turned on.

2

Turning off the instrument with the main power switch

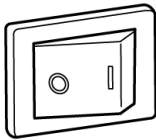

Power off ○

Turn off (○) the main power switch on the rear of the instrument.

Canceling the standby state

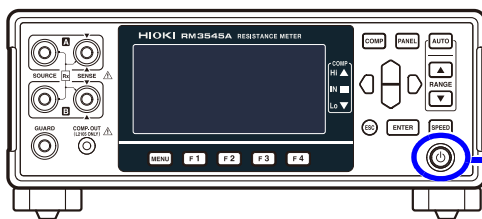

Press the STANDBY key
(the STANDBY key will change from red to green).

2.6 Turning the Power On and Off

After the standby state is canceled, a self-test (instrument diagnostic routine) is performed. During the self-test, the following information is displayed while the hardware is verified.

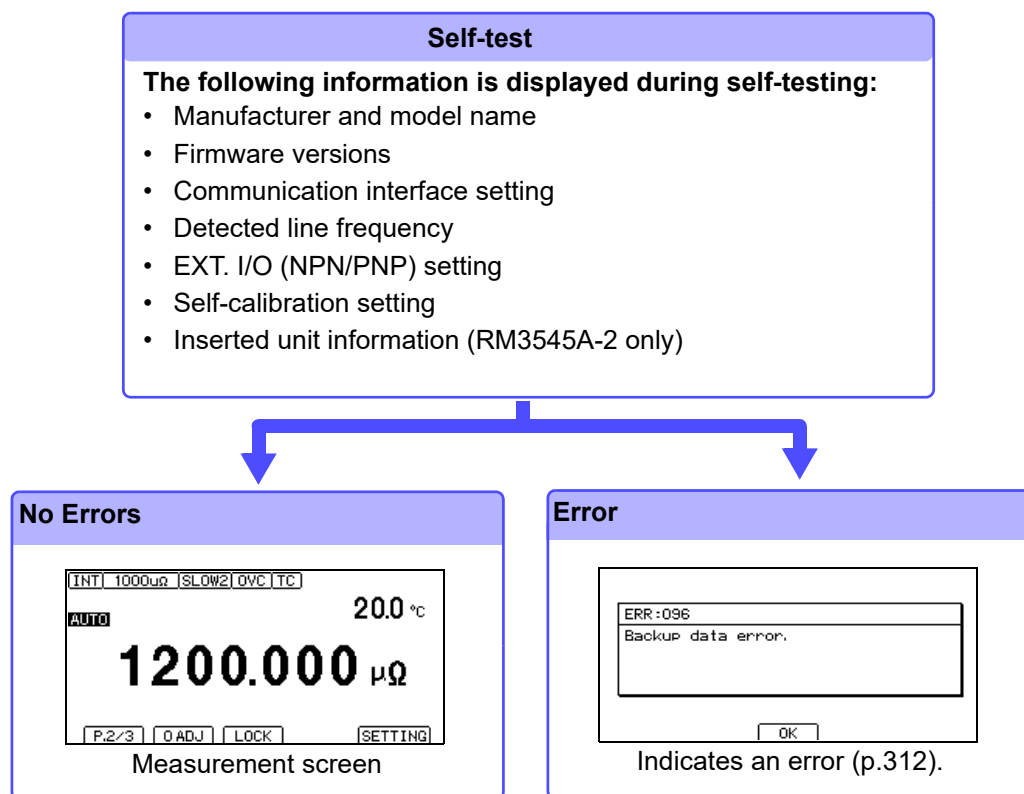

IMPORTANT

The Z3003 Multiplexer Unit test is not performed during the self-test on startup.

See: “7.6 Performing the Multiplexer Unit Test” (p.172)

Before starting measurement

To obtain precise high-accuracy measurements, provide about 60 minutes warm-up after turning power on. The SOURCE terminal is protected by a fuse. If the fuse is tripped, the instrument will display **[Blown FUSE.]** and you will not be able to measure resistance values. In this case, replace the fuse.

See: “13.3 Replacing the Measurement Circuit’s Protective Fuse” (p.315)

Measurement settings are recalled from when the power was previously turned off (settings backup).

Placing the instrument in the standby state

Press the **STANDBY** key (press for one second).
(The **STANDBY** key will change from green to red.)

Disconnect the power cord from the outlet to extinguish the **STANDBY** key light.
When power is turned on again, operation resumes with the same state as when last turned off.

If power to the instrument is cut off with the power switch in the on position (by a circuit breaker, etc.), the instrument will start up when power is restored, without any need to press the **STANDBY** key.

3 Basic Measurements

Before making measurements, read “Before measuring” (p.10) carefully.

This chapter explains basic operating procedures for the instrument.

“3.1 Checking the Measurement Target” (p.46)



“3.2 Selecting the Measurement Range” (p.48)



“3.3 Setting the Measurement Speed” (p.50)



“3.4 Connecting Measurement Leads to the Measurement Target” (p.52)









“3.5 Checking Measured Values” (p.53)

To customize measurement conditions, see “4 Customizing Measurement Conditions” (p.63).

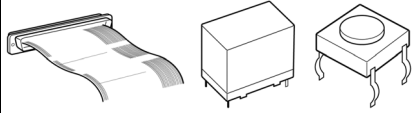
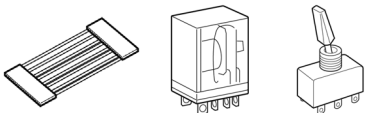
3.1 Checking the Measurement Target

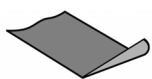
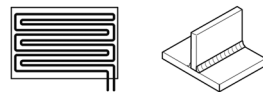
To carry out proper resistance measurement, change the measurement conditions appropriately according to the measurement target. Before starting measurement, use the examples recommended in the following table to configure the instrument.

Measurement target	Recommended settings (Bold indicates a change from the factory default.)					
	Low-power mode (p.65)	Measurement current (p.67)	TC (p.76) ΔT (p.118)	OVC (p.83)	Contact check (p.90)	Pure resistance mode (p.85)
Weld resistance Tab welding of battery cells, bus bar welds in battery packs, welds in automotive batteries, welds in inverters 	Off	High	TC	On	On	On
Motors, solenoids, choke coils, transformers 	Off	High	TC	Off	On	Off
Signal contacts Wire harnesses, connectors, relay contacts, switches 	On	-	TC	On	Off *3	-
Power contacts Wire harnesses, connectors, relay contacts, switches 	Off	High	TC	On	On	On
Fuses, resistors 	Off	Low *1	-	On	On	Off
Conductive paint, conductive rubber 	Off	High	-	Off	Off	Off
Other, standard resistance measurement Heaters, electrical wires 	Off	High	*2	On	On	Off

Measurement target	Recommended settings (Bold indicates a change from the factory default.)					
	Low-power mode (p.65)	Measurement current (p.67)	TC (p.76) ΔT (p.118)	OVC (p.83)	Contact check (p.90)	Pure resistance mode (p.85)
Temperature-rise test Motors, choke coils, transformers 	Off	High	ΔT	Off	On	Off

3

- *1. When there is sufficient margin with regard to the rated power, select High.
- *2. When the measurement target significantly depends on temperature, use the temperature correction function.
- *3. When there is sufficient margin with regard to the allowable applied voltage, select on.

IMPORTANT

When measuring a commercial power supply transformer using an external trigger, measurement cannot be performed using the delay setting preset. Either make the delay adequately long or measure using the internal trigger (p.86).

3.2 Selecting the Measurement Range

Select the measurement range. Auto-ranging (the AUTO range) can also be selected.

Manual range setting



Select the range to use. ([AUTO] off)



The decimal point location and unit indicator change each time you press the button.

Auto-ranging



Press this while a manual range is selected. ([AUTO] lights)

The optimum measurement range is automatically selected.

Switching from auto-ranging to manual range selection

Press  again. The range can now be changed manually.

IMPORTANT

- When the comparator function and BIN measurement function are turned on, the range cannot be changed from fixed (it cannot be switched to auto-ranging). To change the range, turn off the comparator function and BIN measurement function or change the range from within the comparator settings and BIN number settings.
- When measuring certain motor, transformer or coil components, the auto range setting may not stabilize. In such cases, either select the range manually or lengthen the delay time.
See: “4.10 Setting Pre-Measurement Delay (Delay Function)” (p.86)
- The measurement target power is given by the resistance value \times (measurement current)² if the measured value is within the measurement range. If the measurement range is exceeded, the power may reach a maximum value that is given by (open voltage \times measurement current). Check the measurement range before connecting the measurement target. When using a High measurement current, resistance ranges of 100 Ω and lower may cause a large amount of power to be applied to the measurement target. In particular, a maximum power of about 2 W may be applied to the target at ranges of 100 m Ω and lower (ranges that result in a measurement current of 1 A). Check the measurement range and current switching before connecting the measurement target.
See: “4.2 Switching Measurement Currents (100 m Ω to 100 Ω range)” (p.67)
- When measuring delicate samples, make measurements with the low-power mode on.
See: “4.1 Switching to Low-power Mode (LP)” (p.65)
- Refer to “Measurement accuracy” (p.271) for information on each range measurement accuracy.

Continued on next page

IMPORTANT

- When using the INT trigger source, current will stop when a contact error occurs (when not connected to the measurement target). By contrast, if the contact check function is disabled while using the INT trigger source, the maximum open voltage will be applied across the terminals when the measurement target is not connected. Consequently, a rush current will flow at the moment the instrument is connected to the measurement target.

(For example, when measuring pure resistance with the 1 A measurement current range, the instrument will reach a maximum current of 6 A with a maximum convergence time of 2 ms.)

The inrush current will vary with the range. When measuring easily damaged elements, either turn on the contact check or use a range that results in a low measurement current. However, if there is chatter even when the contact check is enabled, it will not be possible to completely prevent a rush current.

- When set to 2-wire with the multiplexer, ranges of 10 Ω and lower cannot be used.

3.3 Setting the Measurement Speed

The measurement speed can be set to the following 4 levels.

[FAST], [MED] (MEDIUM), [SLOW1], or [SLOW2]

The [MED] (medium), [SLOW1] and [SLOW2] settings offer increased measurement precision compared to the [FAST] setting as well as greater resistance to the effects of the external environment.

Setting	FAST	MED	SLOW1	SLOW2
Measurement speed	Fast ← → Slow			
Measured value stability	Low ← → High			

If the setup is excessively susceptible to the effects of the external environment, shield the measurement target and measurement leads adequately and twist the cables together.

See: “14.9 Mitigating Noise” (p.338)

SPEED Each time you press this, the measurement speed is changed.

A self-calibration that lasts about 5 ms is performed between measurements. To shorten the measurement interval, set the self-calibration to “manual”.

See: “4.13 Maintaining Measurement Precision (Self-Calibration)” (p.94)

Integration time (Unit: ms) (detected voltage data acquisition time)

LP	Range	FAST		MEDIUM		SLOW1	SLOW2
		50 Hz	60 Hz	50 Hz	60 Hz		
OFF	1000 kΩ or less	0.3* ¹		20.0	16.7	100	200
	10 MΩ or more	20.0	16.7	20.0	16.7	100	200
ON	All ranges	20.0	16.7	40.0	33.3	200	300

*1. When using the MUX measurement terminals, the integration time is 1.0 ms in the 1000 μΩ range or 10 mΩ range.

See: “12.2 Input Specifications/Output Specifications/Measurement Specifications” (p.264)

- When OVC is on, integration is performed twice. When LP is on, OVC is fixed to on.
- When using the SLOW2 measurement speed with LP on, the instrument will perform averaging with two iterations internally even if the averaging function is set to off.

Shortest measurement times when using the INT trigger source with continuous measurement on (free-run)

LP: Off (unit: ms), tolerance: $\pm 10\% \pm 0.2$ ms

Range	FAST		MEDIUM		SLOW1	SLOW2
	50 Hz	60 Hz	50 Hz	60 Hz		
1000 k Ω or less	1.0* ¹		20.7	17.4	101	201
10 M Ω or more	20.7	17.4	20.7	17.4	101	201

*1. When using the MUX measurement terminals, the integration time is 1.7 ms in the 1000 $\mu\Omega$ range or 10 m Ω range.

LP: On (unit: ms), tolerance: $\pm 10\% \pm 0.2$ ms, only with OVC on

Range	FAST		MEDIUM		SLOW1	SLOW2
	50 Hz	60 Hz	50 Hz	60 Hz		
LP1000 m Ω	71	65	111	98	431	631
LP10 Ω	111	105	151	138	471	671
LP100 Ω	111	105	151	138	471	671
LP1000 Ω	113	107	153	140	473	673

Shortest conditions

Delay: 0 ms, OVC: Off, Averaging: Off, Self-calibration: MANUAL,

Contact improvement: Off, Scaling: Off

Measured value display switching: none

3.4 Connecting Measurement Leads to the Measurement Target

Before connecting the leads, read “Before measuring” (p.10) carefully.

Example with L2100

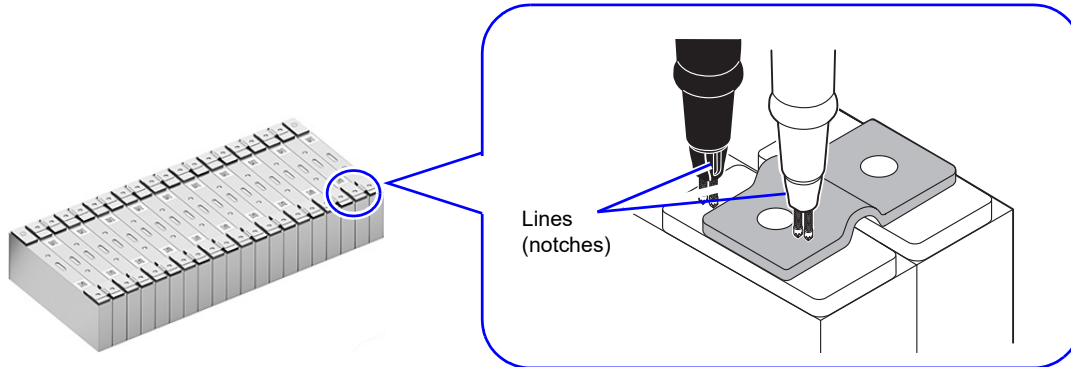

Connect the leads so that the lines (notches) on their bases face inward to each other.

Example with L2101

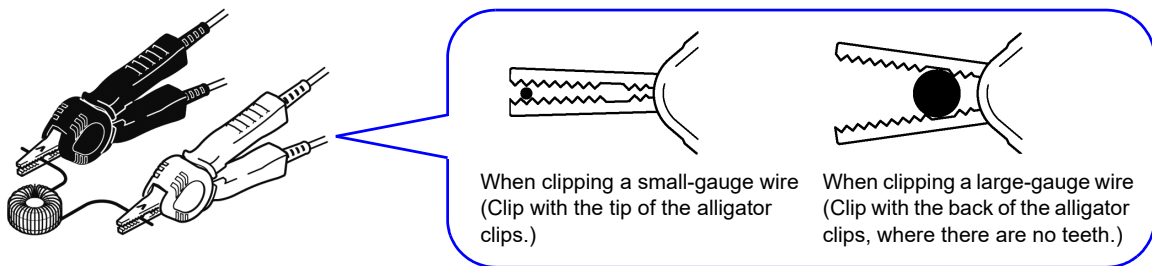

Example with L2102

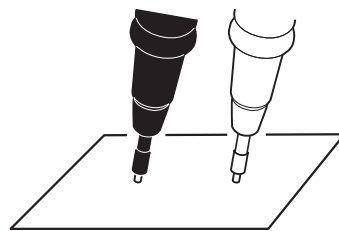

Place leads in contact with target.

Example with L2104

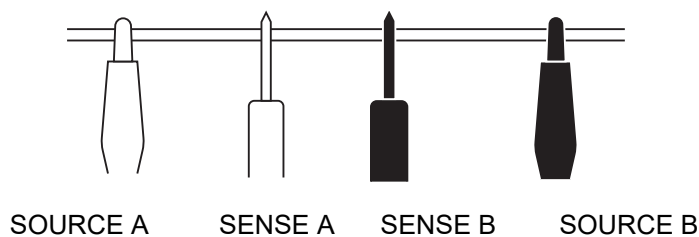

The SENSE terminals are placed to the inside of the SOURCE terminals.

3.5 Checking Measured Values

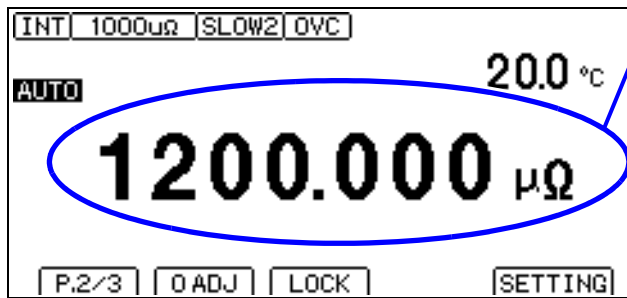

The resistance value will be displayed.

- If the display does not indicate the measured value, see “Confirming measurement faults” (p.56).
- To convert the value into a parameter other than resistance, see below.

See: “4.18 Performing Temperature Rise Test (Temperature Conversion Function [ΔT])” (p.118)

See: “4.6 Correcting Measured Values and Displaying Physical Properties Other than Resistance Values (Scaling Function)” (p.78)

3

When measuring close to 0 Ω, measured values may turn negative. If measured values turn negative otherwise, check the following items:

- Are the SOURCE or SENSE wires connected backwards?
→ Rewire correctly.
- Has the contact resistance decreased since you performed zero adjustment?
→ Perform zero adjustment again.
- Is the scaling calculation result negative?
→ Change the scaling settings.

Switching the display

You can change what information is shown on the Measurement screen.

Displaying temperature and pre-calculation measured values

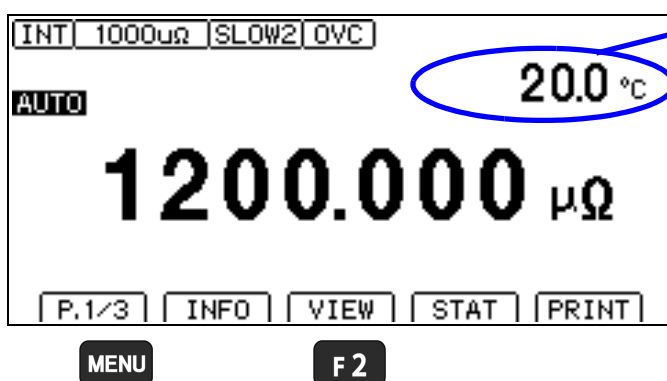

You can switch this part of the display to show nothing, the temperature, or the pre-calculation measured value.

See: “Example displays” (p.54)

1 **MENU** Switch the function menu to P.1/3.

2 **F2** **[VIEW]** Switch the Measurement screen.

Example displays

Display of pre-calculation measured values varies with the settings.

(No display)

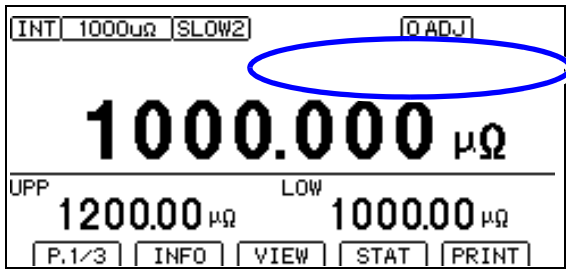

(Temperature display)

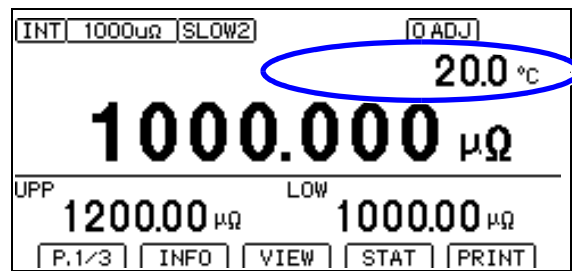

(Value before TC calculation: With TC ON)

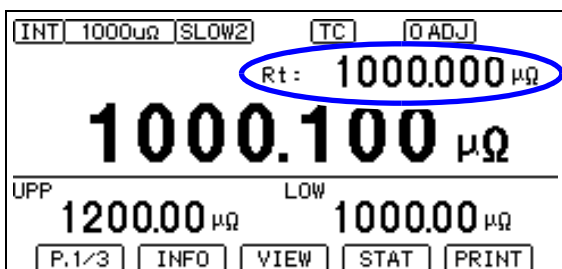

Rt: Resistance measured value before TC calculation

(Value before scaling calculation : With scaling ON)

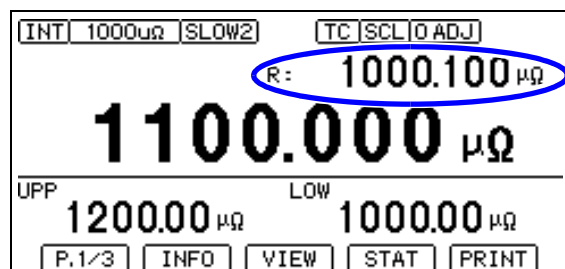

R: Resistance measured value before scaling

(Value before REF% calculation: With REF% comparator setting and scaling OFF)

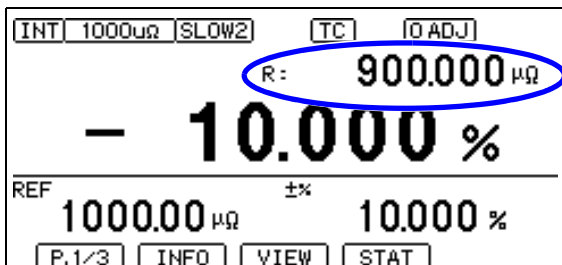

R: Resistance measured value (before relative calculation)

(Value before REF% calculation: With REF% comparator setting and scaling ON)

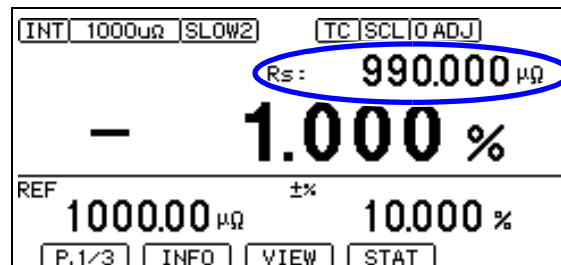

RS: Resistance measured value after scaling (before relative calculation)

Displaying a list of model and measurement conditions

- 1 Display the measurement conditions.

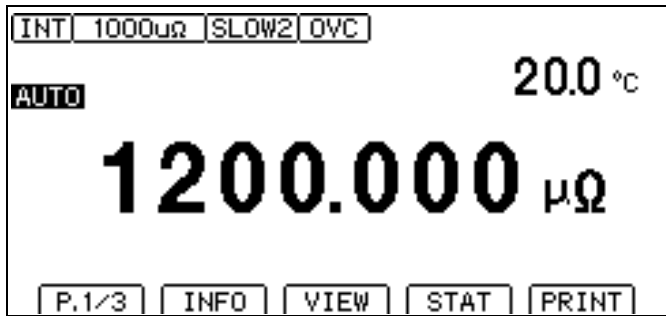

- 1 **MENU** Switch the function menu to P.1/3.

- 2 **F1** **[INFO]** Display measurement conditions.

3

- 2 Check the measurement conditions.

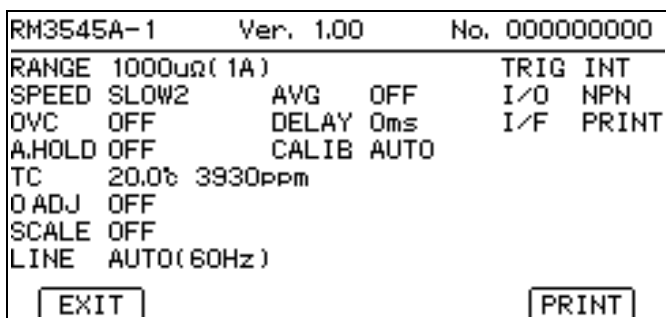

If the interface type has been set to “printer”, you can print settings with

F4.

- MENU** Return to the Measurement screen.

IMPORTANT

When the scan function is set to auto or step, the list of measurement conditions and settings cannot be displayed.

Confirming measurement faults

When a measurement is not performed correctly, a measurement fault indicator appears and a ERR signal of the EXT. I/O is output (no ERR signal is output for over-range or unmeasured events). Operation when a current fault occurs can be changed with the settings.

See: "14.15 Checking Measurement Faults" (p.350)

Over-range

<p>Display</p> <p>+OvrRng</p> <p>-OvrRng</p>	<p>This fault is displayed in the following two instances.</p> <p>(1) Appears when the measured value is outside of the measurement or display range. See: "Over-range detection function" (p.58)</p> <p>(2) Appears when a measurement fault occurs (when the current fault mode setting is "Over-range"). When no measurement current flows from the SOURCE B terminal to the SOURCE A terminal See: "Current fault detection function" (p.58)</p> <p>Similarly, if the measurement range is exceeded in temperature measurement, [OvrRng] is displayed. The comparator result is Hi when [+OvrRng] is displayed, and Lo when [-OvrRng] is displayed. No ERR signal is output.</p>
--	---

Contact error

See: "Block Diagram" (p.319)

<p>Display</p> <p>CONTACT TERM.A/B - - - - -</p>	<p>(When the scan function is set to auto or step, [CONTACT A] or [CONTACT B] will be displayed. When the communications monitor function is on, [CA] or [CB] will be displayed.)</p>
--	---

The resistance between the SENSE A and SOURCE A probe contacts, and between the SENSE B and SOURCE B probe contacts, are measured and an error is displayed if the result is about 50 Ω or greater. If this error persists, probe wear or cable failure may be the cause. When the resistance value between the SENSE and SOURCE is high, for example when the measurement target is conductive paint or conductive rubber, you will not be able to perform measurement due to the continuous error state. In this case, turn off the contact check function.

See: "4.11 Checking for Poor or Improper Contact (Contact Check Function)" (p.90)

Current fault or measurement not performed

<p>Display</p> <p>- - - - -</p>	<p>This fault is displayed in the following two instances. If [- - - - -] is displayed, a comparator judgment will not be made.</p> <p>(1) Appears when a measurement fault occurs (when the current fault mode setting is "Current fault"). When no measurement current flows from the SOURCE B terminal to the SOURCE A terminal See: "Current fault detection function" (p.58)</p> <p>(2) This fault is displayed when no measurement has been performed since the measurement conditions were changed.</p>
---------------------------------	---

Multiplexer channel error

Display SW.ERR	A multiplexer relay hot-switching prevention function error has occurred. The relay cannot be switched because the current from the measurement target has not decreased. Increase the delay setting since the measurement circuit may be being influenced by back EMF from a transformer or other device. Do not apply any current or voltage to the measurement terminals. See: "4.10 Setting Pre-Measurement Delay (Delay Function)" (p.86)
Display NO UNIT	No multiplexer unit was detected. Verify that the unit has been inserted. Do not allocate units that have not been inserted to channels.

3

Temperature sensor not connected

Display ---- °C	Temperature measurement cannot be performed because the temperature sensor has not been connected. There is no need to connect the temperature sensor when not using temperature correction or ΔT. Switch the display if you do not wish to display the temperature. See: "Switching the display" (p.53)
--------------------	---

Example displays: Display and output when the probes are open or when the measurement target is open

Display and output during current fault detection		Current fault mode setting (p.60)	
		Current fault	Over-range
Contact Check Results	Normal (No error)	Display: ----- COMP indicator: No judgment EXT. I/O: ERR signal output	Display: +OvrRng COMP indicator: Hi EXT. I/O: No ERR signal output, HI signal output
	Fault (Error)	Display: [CONTACT TERM.A] or [CONTACT TERM.B] COMP indicator: No judgment EXT. I/O: ERR signal output	

Measurement fault detection order

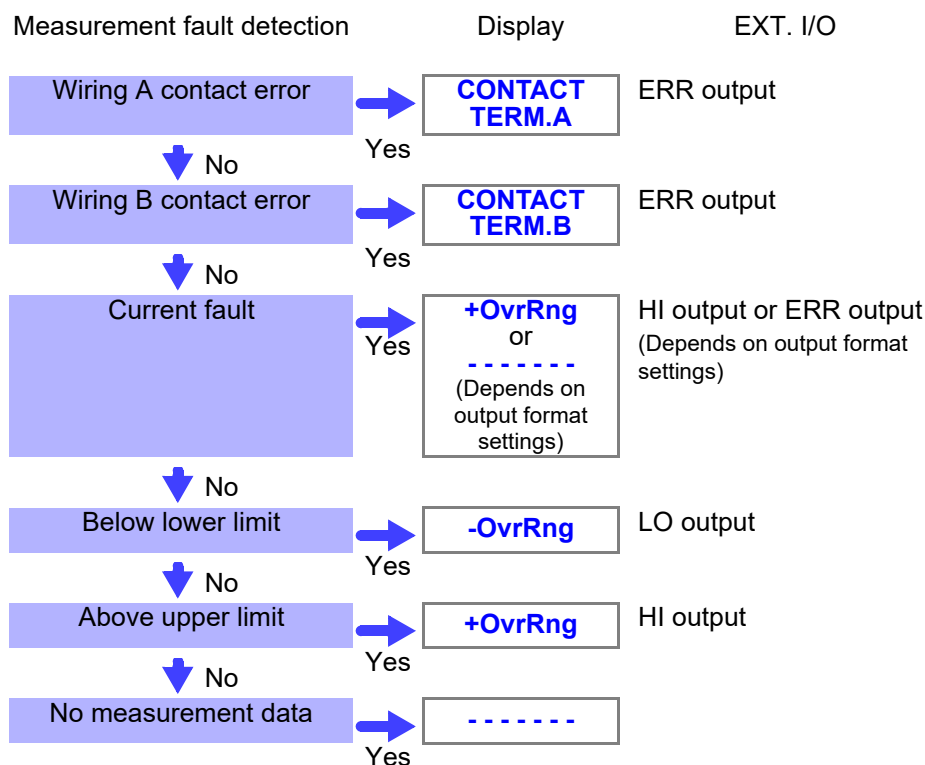

IMPORTANT

Measurement fault detection proceeds in the order shown at the left, ending with display of the first detected error.

Over-range detection function

Examples of over-range faults

Over-range detection	Measurement example
The measured value is outside of the measurement range.	Attempting to measure 13 kΩ with the 10 kΩ range selected.
The relative tolerance (%) display of the measured value exceeds the display range (999.999%).	Measuring 500 Ω (+2400%) with a reference value of 20 Ω.
The zero adjusted value is outside of the display range.	Performing zero adjustment after connecting 0.5 Ω with the 1 Ω range → Measuring 0.1 Ω yields a -0.4 Ω reading, exceeding the display range.
During measurement, input voltage exceeded the A/D converter input range.	Measuring a large resistance value in an electrically noisy environment.
Current did not flow normally to the measurement target. (When the current fault mode setting is set to “Over-range output” only)	<ul style="list-style-type: none"> • When the measurement target yields an open FAIL result. • When either the SOURCE A or SOURCE B terminal suffers from poor contact. <p>To display [- - - - -] when a current fault occurs, set the current fault mode setting to “Current fault”. (p.60)</p>

Current fault detection function

Example of current fault

- SOURCE A or SOURCE B probe open
- Broken measurement target (open work)
- SOURCE A or SOURCE B cable break, poor connection

IMPORTANT

SOURCE route resistance in excess of the specified values may cause a current fault, making measurement impossible. Regarding the reference values for route resistance that will result in a current fault, see “Reference values for route resistance (wiring resistance + contact resistance) that will result in a current fault” (p.59).

When using current 1 A range, keep the route resistance low.

Reference values for route resistance (wiring resistance + contact resistance) that will result in a current fault

LP: Off

Range	100 MΩ range High-precision mode	Current switching	Measurement current	SOURCE B-SOURCE A (Other than measurement target)
1000 μΩ	–	High	1 A	2.6 Ω
10 mΩ	–	High	1 A	2.6 Ω
100 mΩ	–	High	1 A	2.6 Ω
100 mΩ	–	Low	100 mA	15 Ω
1000 mΩ	–	High	100 mA	15 Ω
1000 mΩ	–	Low	10 mA	150 Ω
10 Ω	–	High	10 mA	150 Ω
10 Ω	–	Low	1 mA	1 kΩ
100 Ω	–	High	10 mA	100 Ω
100 Ω	–	Low	1 mA	1 kΩ
1000 Ω	–	–	1 mA	500 Ω
10 kΩ	–	–	1 mA	500 Ω
100 kΩ	–	–	100 μA	1 kΩ
1000 kΩ	–	–	10 μA	1 kΩ
10 MΩ	–	–	1 μA	1 kΩ
100 MΩ	ON	–	100 nA	1 kΩ
100 MΩ	OFF	–	1 μA or less	1 kΩ
1000 MΩ	OFF	–	1 μA or less	1 kΩ

PR: On

Range	Current switching	Measurement current	SOURCE B-SOURCE A (Other than measurement target)*1
PR1000 μΩ	High	1 A	3.5 Ω
PR10 mΩ	High	1 A	3.5 Ω
PR100 mΩ	–	1 A	3.5 Ω

LP: On

Range	Measurement current	SOURCE B-SOURCE A (Other than measurement target)*1
LP1000 mΩ	1 mA	2 Ω
LP10 Ω	500 μA	5 Ω
LP100 Ω	50 μA	50 Ω
LP1000 Ω	5 μA	500 Ω

*1. When using the Z3003 Multiplexer Unit, ensure that the total of the unit's internal route resistance (including relays) and the route resistance from the connector to the measurement target does not exceed the values in the above table.

You can verify that the unit's internal route resistance is 1 Ω or less using the unit test.

See: "7.6 Performing the Multiplexer Unit Test" (p.172)

Setting the measurement method for an open target (current fault mode setting)

This section describes how to configure instrument operation when current fault output is detected.

When set to current fault, a break in the measurement target wiring is determined to be an error, and no comparator judgment is made. When set to over-range, a break in the measurement lead or other open state is determined to be an over-range event, and a comparator judgment of Hi results. Choose the setting that best suits your application.

IMPORTANT

The current fault mode setting applies to all channels (when using the Z3003).

1 Open the Settings screen.

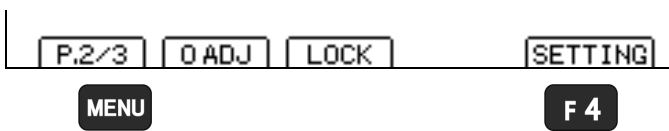

1 **MENU** Switch the function menu to P.2/3.

2 **F 4** The Settings screen appears.

2 Open the Measurement Setting screen.

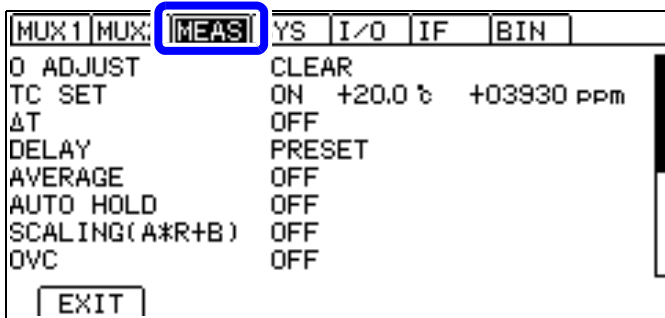

Move the cursor to the **[MEAS]** tab with the left and right cursor keys.

3 Select the desired current fault mode.

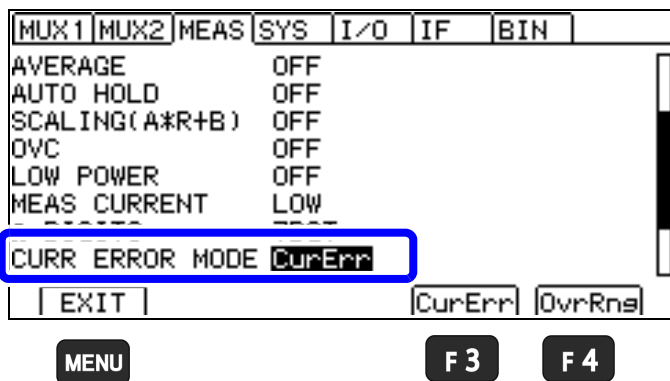

1  Selection

2 **F 3** Current fault (default)

F 4 Over-range

MENU Return to the Measurement screen.

Holding measured values

The auto-hold function provides a convenient way to check measured values. Once the measured value stabilizes, the beeper will sound, and the value will be automatically held.

IMPORTANT

The auto-hold function setting applies to all channels (when using the Z3003).

1 Open the Settings screen.

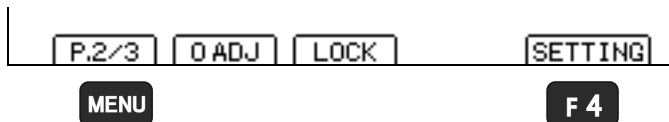

1 **MENU** Switch the function menu to P.2/3.

2 **F 4** The Settings screen appears.

2 Open the Measurement Setting screen.

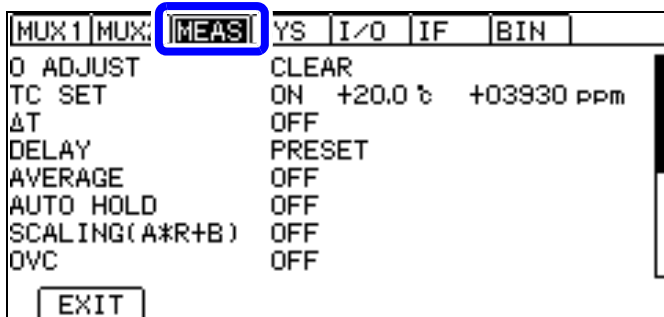

Move the cursor to the **[MEAS]** tab with the left and right cursor keys.

3 Enable the auto-hold function.

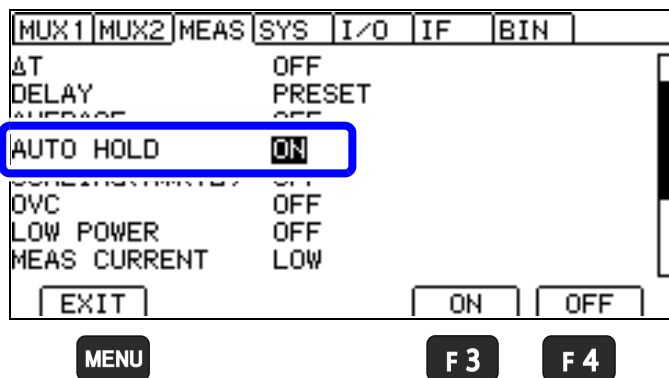

1 Selection

2 **F 3** ON

F 4 OFF (default)

MENU Return to the Measurement screen.

While the measured value is being held, the **[HOLD]** indicator will light up.

Canceling auto-hold operation

Hold operation is automatically canceled when the measurement leads are removed from the measurement target and then brought into contact with the measurement target again. You can also cancel hold operation by pressing **[ESC]** or changing the range and measurement speed. When hold operation is canceled, the **[HOLD]** indicator will go out.

4 Customizing Measurement Conditions

This chapter explains functionality employed to make more advanced, more accurate measurements. The following table lists functions and example uses:

Example uses	Function	See
Extend tolerance for route resistance (wiring resistance + contact resistance)	Switching Measurement Currents (Expanded route resistance tolerance mode)	p.67
Shorten measurement time (if measurement target is resistance component only)	Pure Resistance Mode (PR)	p.85
When you wish to convert resistance values based on a reference temperature	Temperature Correction (TC)	p.76
When you wish to increase the measurement precision	Zero Adjustment	p.69
	Offset Voltage Compensation (OVC)	p.83
	100 MΩ Range High-precision Mode	p.98
When you wish to change the number of display digits	Changing the Number of Measured Value Digits	p.82
When you wish to cancel surplus resistance from 2-terminal wiring	Zero Adjustment	p.69
When you wish to correct for the effects of thermoelectric force	Zero Adjustment	p.69
	Offset Voltage Compensation (OVC)	p.83
When you wish to correct measured values	Scaling Function	p.78
When you wish to stabilize measurement	Averaging Function	p.74
	Delay Function	p.86
When you wish to speed up auto-ranging	Delay Function	p.86
When you wish to limit the open voltage	Low-Power Mode (LP)	p.65
When you wish to limit the current	Low-Power Mode (LP)	p.65
	Switching Measurement Currents	p.67
When you wish to perform measurement while minimizing the effect on the contact surface state	Low-Power Mode (LP)	p.65
When you wish to detect contact defects and measurement cable breaks	Contact Check Function	p.90

Example uses	Function	See
When you wish to convert readings into a physical property other than resistance (for example, length)	Scaling Function	p.78
When you wish to improve probe and switching relay contact	Contact Improvement Function	p.92
When you wish to perform measurement as quickly as possible and perform self-calibration during instrument downtime	Self-Calibration Function	p.94
Judge measured values	Comparator Function	p.99
Classify measurement results	BIN Measurement Function	p.109
Perform statistical calculations on measured values	Statistical Calculations Function	p.112
Perform temperature rise test	Temperature Conversion Function (ΔT)	p.118

4.1 Switching to Low-power Mode (LP)

In the low-power mode, the open-circuit terminal voltage is limited to 20 mV to allow measurement with an extremely low current.

When measuring signal contacts (wire harnesses, connectors, relay contacts, or switches), the low-power mode can be used to minimize the effect on the contact state.

When you measure signal contacts with the low-power mode off, the oxide film on the contact is more readily damaged. If the contact's oxide film is damaged, it will tend to produce lower resistance values.

By contrast, the oxide film on power contacts (high-current contacts) is eliminated during use. When such contacts are measured with the low-power mode on, it is not possible to break down the oxide film, resulting in higher measured values.

See: "3.1 Checking the Measurement Target" (p.46)

See: "14.12 Measuring Contact Resistance" (p.345)

Ranges, measurement currents, and open voltages that can be used with the low-power mode on

Range	Max. measurement range	Measurement current	Open voltage
LP1000 mΩ	1200.00 mΩ	1 mA	20 mV max.
LP10 Ω	12.0000 Ω	500 μA	
LP100 Ω	120.000 Ω	50 μA	
LP1000 Ω	1200.00 Ω	5 μA	

IMPORTANT

- Because the detection voltage decreases when the low-power mode is on, measurement is more susceptible to external noise. If measured values fail to stabilize, take steps to address the noise, referring to "14.7 Unstable Measured Values" (p.330). The following four steps are particularly effective in this situation:
 - Shield the measurement cable (connect the shielding to the instrument's GUARD terminal).
 - Twist the measurement cables together.
 - Shield the measurement target (connect the shielding to the instrument's GUARD terminal).
 - Decrease the measurement speed or use the averaging function.
- Since the effects of thermal EMF are eliminated when the low-power mode is on, the instrument will be automatically set to OVC on. If the measurement target has a large reactance component, it will be necessary to increase the delay.
 - See: "4.8 Compensating for Thermal EMF Offset (OVC Function)" (p.83)
 - See: "4.10 Setting Pre-Measurement Delay (Delay Function)" (p.86)
- When using the SLOW2 measurement speed with low-power mode on, the instrument will perform averaging with two iterations internally even if the averaging function is set to off. If the averaging function is on, the instrument will perform averaging using the set number of iterations.
- When low-power mode is set to on, the contact improvement function is set to off.
- When low-power mode is set to on, the contact check default setting is off.

1 Open the Settings screen.

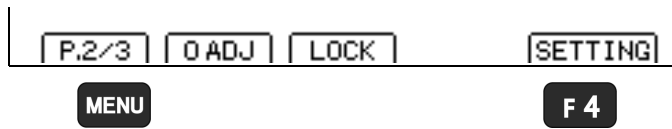

1 **MENU** Switch the function menu to P.2/3.

2 **F 4** The Settings screen appears.

2 Open the Measurement Setting screen.

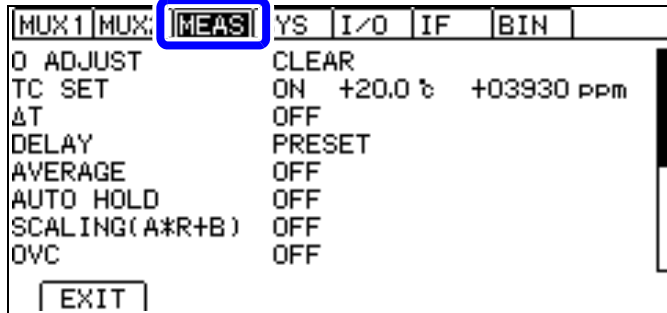

Move the cursor to the **[MEAS]** tab with the left and right cursor keys.

3 Select the low-power mode, as needed.

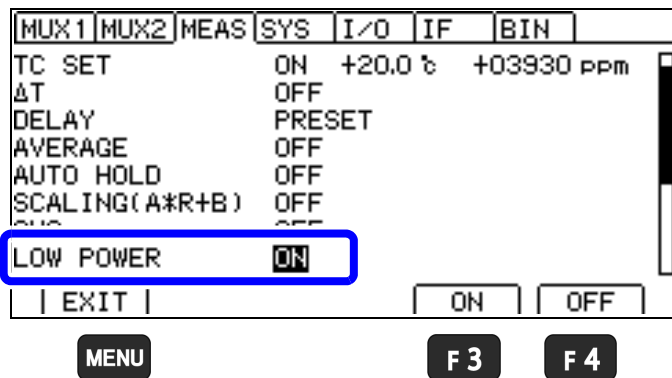

1  Selection

2
F 3 Low-power mode
F 4 Normal resistance measurement (default)

MENU Return to the Measurement screen.

4.2 Switching Measurement Currents (100 mΩ to 100 Ω range)

For ranges from 100 mΩ to 100 Ω, the measurement current can be switched (to either high or low). Please choose the most appropriate range for the measurement target.

See: “3.1 Checking the Measurement Target” (p.46)

Power equivalent to the resistance value \times (measurement current)² will be applied to the measurement target. If there are any of the following concerns, depending on the level of the measurement current, set the measurement current to low.

- The measurement target may melt (such as a fuse or inflator).
- The measurement target may heat up, causing a change in resistance.
- The measurement target may be magnetized, causing a change in inductance.

The route resistance tolerance for wiring cables and probes can be increased by reducing the measurement current (by using the low setting).

For more information about wiring resistance tolerance values for each range, see “Reference values for route resistance (wiring resistance + contact resistance) that will result in a current fault” (p.59).

Measurement current setting	High		Low	
	Measurement current	Maximum power in measurement range	Measurement current	Maximum power in measurement range
1000 μΩ	1 A	1.2 mW	–	–
10 mΩ	1 A	12 mW	–	–
100 mΩ	1 A	120 mW	100 mA	1.2 mW
1000 mΩ	100 mA	12 mW	10 mA	120 μW
10 Ω	10 mA	1.2 mW	1 mA	12 μW
100 Ω	10 mA	12 mW	1 mA	120 μW
1000 Ω	1 mA	1.2 mW	–	–
10 kΩ	1 mA	12 mW	–	–
100 kΩ	100 μA	1.2 mW	–	–
1000 kΩ	10 μA	120 μW	–	–
10 MΩ	1 μA	12 μW	–	–
100 MΩ (high-precision mode: On)	100 nA	1.2 μW	–	–
100 MΩ, 1000 MΩ (high-precision mode: Off)	1 μA or less	1.3 μW	–	–

IMPORTANT

Because the detection voltage decreases when the measurement current is low, measurement is more susceptible to external noise. If measured values fail to stabilize, take steps to address the noise, referring to “14.7 Unstable Measured Values” (p.330). The following four steps are particularly effective in this situation:

- Shield the measurement cable (connect the shielding to the instrument’s GUARD terminal).
- Twist the measurement cables together.
- Shield the measurement target (connect the shielding to the instrument’s GUARD terminal).
- Decrease the measurement speed or use the averaging function.

1 Open the Settings screen.

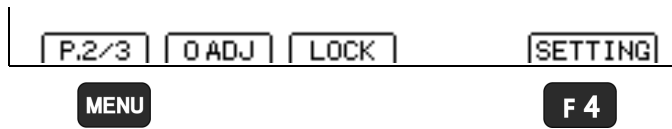

1 **MENU** Switch the function menu to P.2/3.

2 **F 4** The Settings screen appears.

2 Open the Measurement Setting screen.

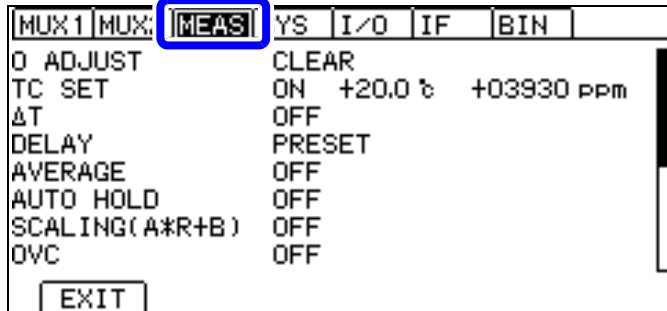

Move the cursor to the **[MEAS]** tab with the left and right cursor keys.

3 Select the 100 mΩ range measurement current.

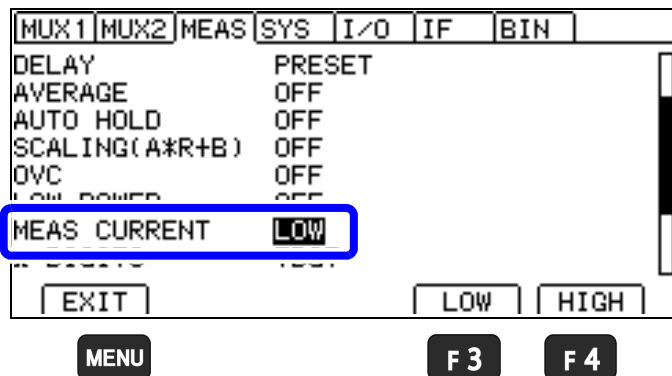

1  Selection

2
F 3 LOW
F 4 HIGH (default)

MENU Return to the Measurement screen.

IMPORTANT

- When the measurement current is switched, zero adjustment will be initialized. Perform zero adjustment again.
- When using the INT trigger source, current will stop when a contact error occurs (when not connected to the measurement target). By contrast, if the contact check function is disabled while using the INT trigger source, the maximum open voltage will be applied across the terminals when the measurement target is not connected. Consequently, a rush current will flow at the moment the instrument is connected to the target.

(For example, when measuring pure resistance with the 1 A measurement current range, the instrument will reach a maximum current of 6 A with a maximum convergence time of 2 ms.)

The inrush current will vary with the range. When measuring easily damaged elements, either turn on the contact check or use a range that results in a low measurement current. However, if there is chatter even when the contact check is enabled, it will not be possible to completely prevent a rush current.

4.3 Performing Zero Adjustment

Perform zero adjustment in the following circumstances:

- When you wish to increase the measurement precision
→ For some ranges, there may be a component added to the accuracy if zero adjustment is not performed.
See: "Measurement accuracy" (p.271)
- The measured value is not cleared due to thermal EMF or other factors.
→ The measured value will be adjusted to zero. *1
- Four-terminal connection (called Kelvin connection) is difficult.
→It subtracts the route resistance of two-terminal wiring.

*1. Thermal EMF can also be canceled by using OVC (p.83).

For more information about how to perform zero adjustment properly, see: "14.6 About Zero Adjustment" (p.325).

Before zero adjustment

- Zero adjustment cannot be performed for 100 MΩ and greater ranges.
- Execute zero adjustment when the ambient temperature has changed, or when a measurement lead is replaced after zero adjustment was performed.
- Zero adjustment should be executed in each range to be used. Perform zero adjustment for the current range only when setting the range manually or for all ranges when using auto-ranging.
- When zero adjustment is executed with auto-ranging, correct zero adjustment may not be possible if the delay time is too short. In this case, execute zero adjustment with a manually set range.
See: "3.2 Selecting the Measurement Range" (p.48)
See: "4.10 Setting Pre-Measurement Delay (Delay Function)" (p.86)
- Zero adjustment values are retained internally even when the instrument is turned off. They are also saved with panels. You can also elect not to load zero adjustment values from panels.
See: "5.1 Saving Measurement Conditions (Panel Save Function)" (p.122)
"5.2 Loading Measurement Conditions (Panel Load Function)" (p.123)
- Zero adjustment can be performed even when the EXT. I/O 0ADJ signal is ON (when shorted with the EXT. I/O connector's ISO_COM pin).
- When switching the offset voltage correction (OVC) function, measurement current, or low-power mode, zero adjustment will be canceled automatically. If necessary, repeat the zero adjustment process.
- Although resistance of -1% of full scale to 50% of full scale can be canceled in each range, try to keep the canceled resistance to 1% of full scale.

LP	full scale
OFF	1,000,000 digits
ON	100,000 digits

- If a resistance that is smaller than the resistance value when zero adjustment was performed is measured, the measured value will be negative.

Example: If you perform zero adjustment after connecting 50 mΩ in the 100 mΩ range.

→If you measure 30 mΩ, -20 mΩ will be displayed.

- When using the multiplexer, zero adjustment can be performed by scanning all channels.
See: "7.5 Zero adjustment (When a Multiplexer Unit Has Been Installed)" (p.169)

Allow the instrument to warm up for 60 minutes before performing zero adjustment.

Performing zero adjustment

1 Short the measurement leads together.

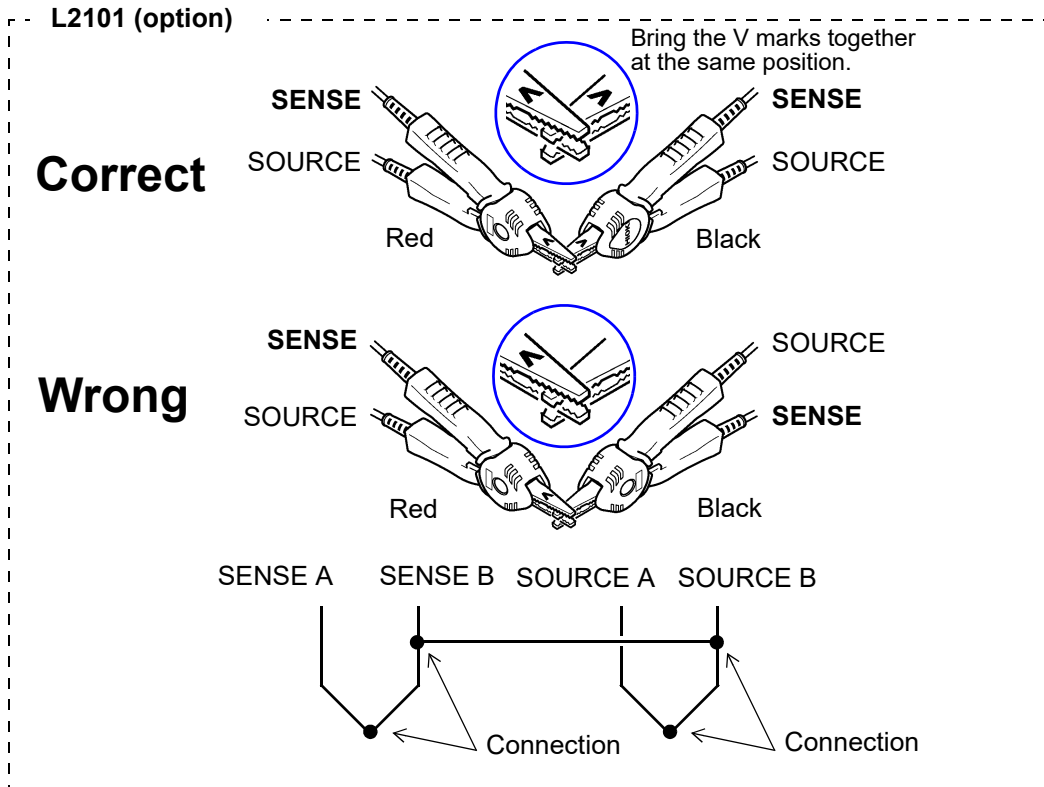

L2102, L2103 (options)

Zero adjustment cannot be performed with L2102 or L2103. Perform zero adjustment using the suitable test lead that can perform zero adjustment, such as L2101 Clip Type Lead (option) and then switch to the pin type lead to perform measurement.

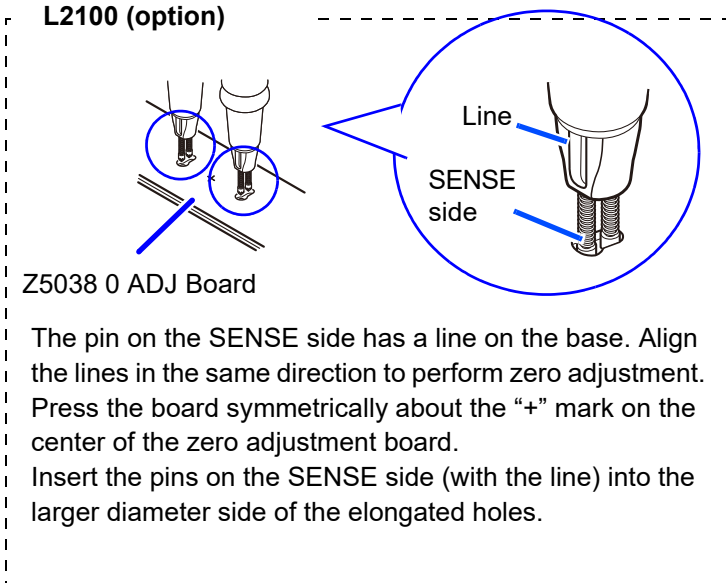
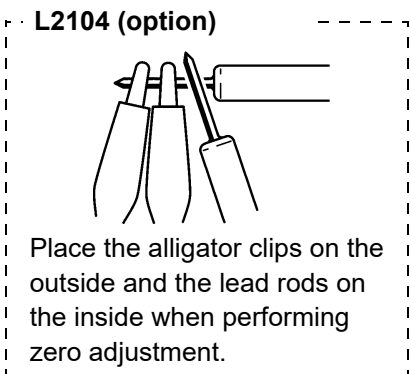

2 Verify that the measured value is within $\pm 1\%$ of full scale.

If the measured value is 50% of full scale or less in each range, zero adjustment can be performed, but a warning will be issued when it is greater than 1% of full scale (p.72).

If no measured value is displayed, verify whether the measurement leads have been wired properly.

Proper wiring

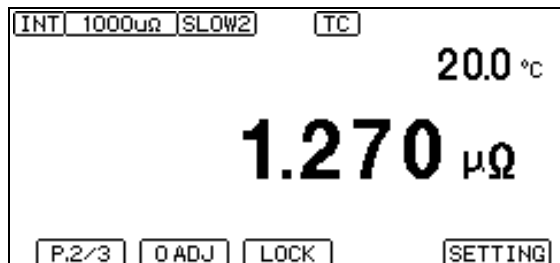

Improper wiring

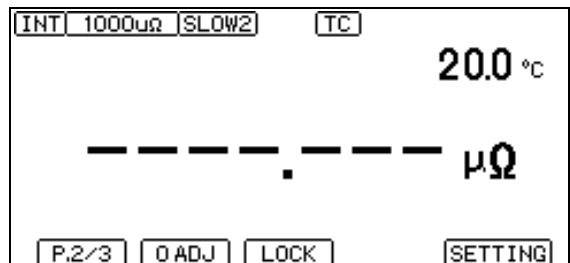

3 Performing zero adjustment



MENU

F 1

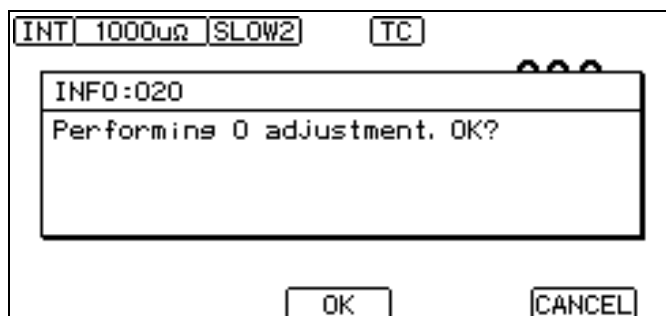

F 2

F 4

- 1 **MENU** Switch the function menu to P.2/3.
- 2 **F 1** Display the confirmation message for performing zero-adjustment.
- 3 **F 2** Perform zero adjustment and return to the Measurement screen.
F 4 Cancel zero adjustment and return to the Measurement screen.

4

Zero adjustment faults

If zero adjustment fails, the following error message appears.

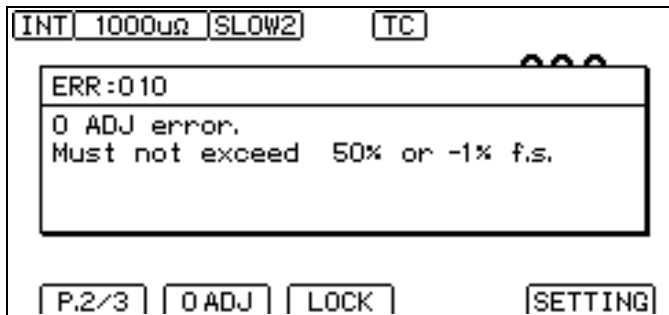

Before attempting zero adjustment again, confirm the following:

- Verify that the measured value is -1% of full scale to 50% of full scale in each range.
- When using measurement leads that you made, reduce the route resistance.
- Confirm that the measurement leads connections are correct.

See: “Current fault detection function” (p.58)

IMPORTANT

- If zero adjustment fails for auto-ranging, zero adjustment will be canceled for all ranges.
- If zero adjustment fails for a manually set range, zero adjustment will be canceled for the current range.

Canceling zero adjustment

Cancels zero adjustment for all ranges.

- 1 Open the Settings screen.

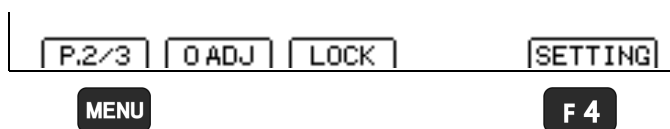

- 1 **MENU** Switch the function menu to P.2/3.

- 2 **F 4** The Settings screen appears.

- 2 Open the Measurement Setting screen.

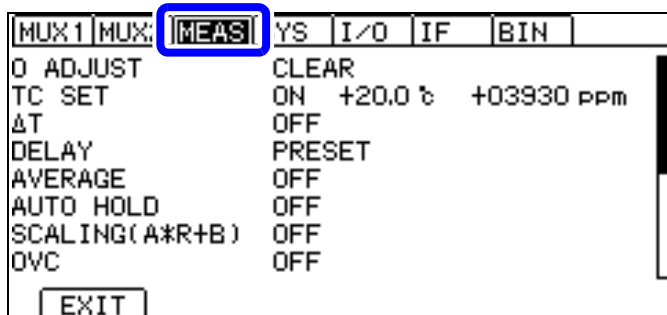

Move the cursor to the **[MEAS]** tab with the left and right cursor keys.

3 Select 0 ADJUST and press the **F4** key.

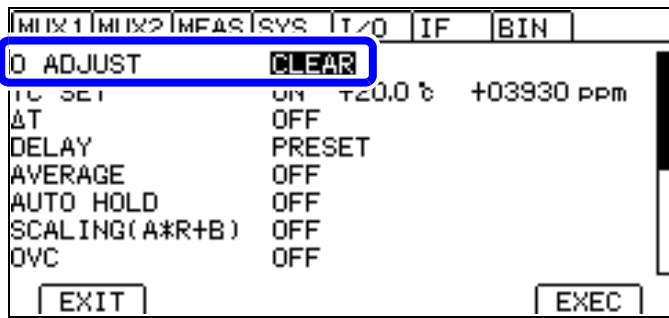

F4

1 Selection

2
F4 Cancel zero adjustment.
The confirmation message is displayed.

4 Confirm the message and cancel zero adjustment.

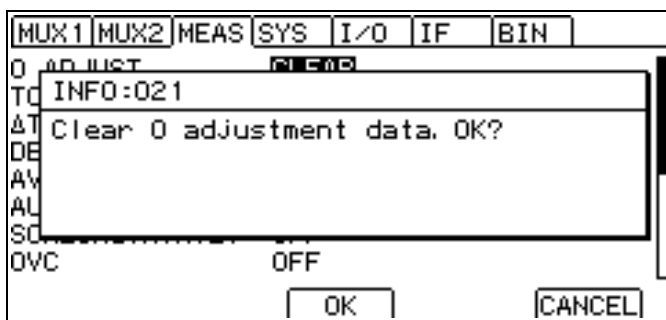

MENU

F2

F4

F2 Canceling zero adjustment
The message is displayed and zero-adjustment is canceled.

F4 Cancel zero adjustment and return to the previous screen.

MENU Return to the Measurement screen.

4

4.4 Stabilizing Measured Values (Averaging Function)

The averaging function averages multiple measured values and displays the results. It can be used to reduce variation in measured values.

For internal trigger measurement (Free-Run), a moving average is calculated.

For external trigger measurement (and **:READ?** command operation) (Non-Free-Run), a mean average is used.

For more information about communications commands, see the Communications Command Instruction Manual. The Instruction Manual can be downloaded from Hioki's website.

<https://www.hioki.com/global/support/download/>

Average (of measurements D1 to D6) with Averaging Samples set to 2.

	1st Sample	2nd Sample	3rd Sample
Free-Run (Moving Avg.)	$(D1+D2)/2$	$(D2+D3)/2$	$(D3+D4)/2$
Non-Free-Run (Mean Avg.)	$(D1+D2)/2$	$(D3+D4)/2$	$(D5+D6)/2$

When using the SLOW2 measurement speed with low-power resistance measurement on, the instrument will perform averaging with two iterations internally even if the averaging function is set to off. If the averaging function is on, the instrument will perform averaging using the set number of iterations.

1 Open the Settings screen.

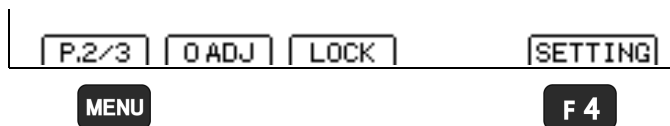

1 **MENU** Switch the function menu to P.2/3.

2 **F4** The Settings screen appears.

2 Open the Measurement Setting screen.

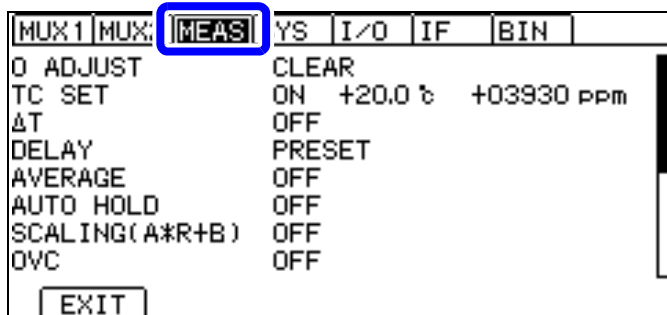

Move the cursor to the **[MEAS]** tab with the left and right cursor keys.

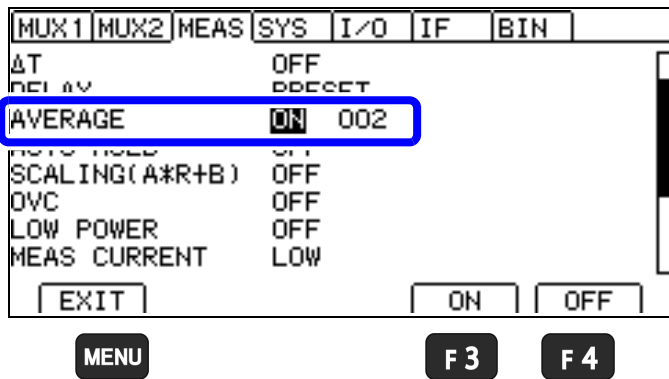
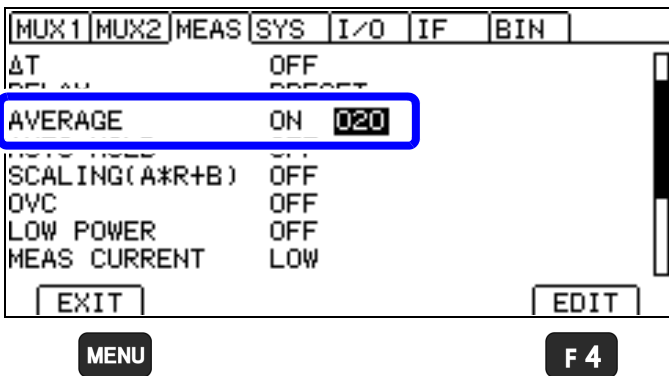
3 Enable (disable) the averaging function.**1** Selection**2****F 3** Enables the averaging function**F 4** Disables the averaging function (default)**MENU** Return to the Measurement screen.**4** Set the number of averaging iterations.

Setting range: 2 to 100 times (default: 2 times)

1 Move the cursor to the setting you wish to configure. Make the value editable with the **F 4** key.**2**

Move among digits. Change values.

Move the cursor to the digit you wish to set with the left and right cursor keys. Change the value with the up and down cursor keys.

3**ENTER** Accept**(ESC)** Cancel**MENU** Return to the Measurement screen.

4.5 Correcting for the Effects of Temperature (Temperature Correction [TC])

Temperature correction converts resistance values to resistance values at standard temperature and displays the result.

For more information about the principle of temperature correction, see “14.4 Temperature Correction (TC) Function” (p.322).

To perform temperature correction, connect the temperature sensor or thermometer with analog output to the TEMP. terminal on the rear of the instrument.

See: “2.4 Connecting Z2001 Temperature Sensor or Thermometer with Analog Output (When using the TC or ΔT)” (p.34)

See: “3.1 Checking the Measurement Target” (p.46)

IMPORTANT
Setting ΔT to on causes TC to be turned off automatically.

1 Open the Settings screen.

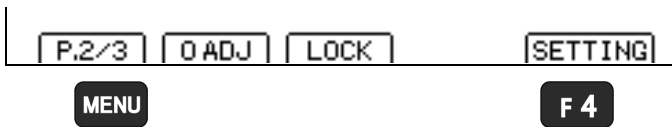

1 **MENU** Switch the function menu to P.2/3.

2 **F 4** The Settings screen appears.

2 Open the Measurement Setting screen.

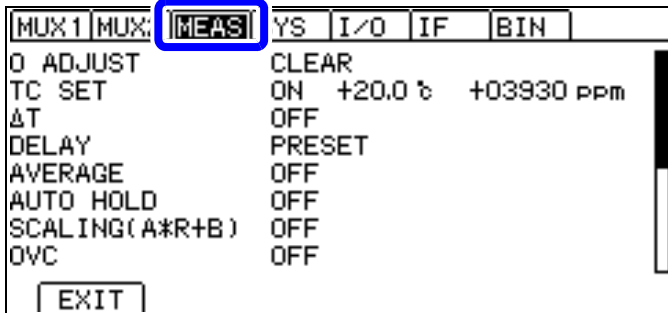

Move the cursor to the **[MEAS]** tab with the left and right cursor keys.

3 Enable (disable) the temperature correction function. (TC)

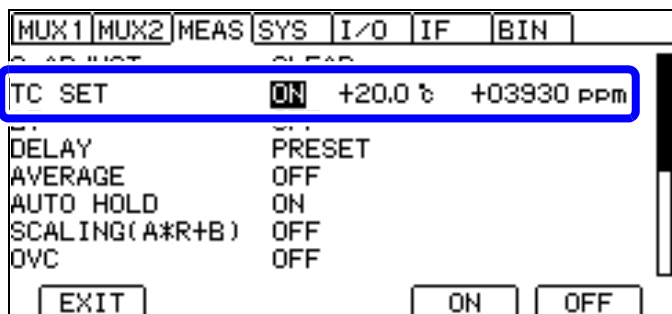

MENU

F 3

F 4

1 Selection

2 **F 3** Enables the TC function

F 4 Disables the TC function (default)

MENU Return to the Measurement screen.

4 Set the reference temperature and temperature coefficient.

(Set the reference temperature and temperature coefficient by following steps **1** through **3** for each.)

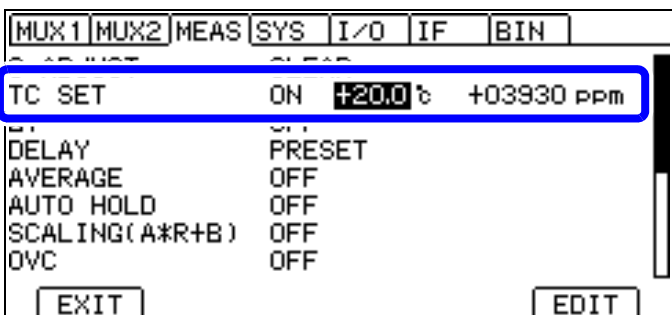

MENU

F 4

1 Move the cursor to the setting you wish to configure. Make the value editable with the **F 4** key.

2 Move among digits. Change values. Move the cursor to the digit you wish to set with the left and right cursor keys. Change the value with the up and down cursor keys.

3 **ENTER** Accept
(**ESC** Cancel)

MENU Return to the Measurement screen.

Setting range Reference temperature : -10.0 to 99.9°C (default: 20°C)
Temperature coefficient : -99999 to 99999 ppm/°C (default: 3930 ppm/°C)

4.6 Correcting Measured Values and Displaying Physical Properties Other than Resistance Values (Scaling Function)

This function applies a correction to measured values. It can be used to cancel the effects of the probing position or differences between measuring instruments, or to apply a user-specified offset as an alternative to zero adjustment.

In addition, units can be specified, allowing it to be used to convert measured values to physical properties other than resistance (for example, length).

Scaling is performed by means of the following equations:

$$R_S = A \times R + B$$

R_S : Value after scaling

R : Measured value after zero adjustment and temperature correction

A : Gain coefficient Setting range: $0.200\ 0 \times 10^{-3}$ to $1.999\ 9 \times 10^3$

B : Offset Setting range: 0 to $\pm 9 \times 10^9$ (maximum resolution: 1 n Ω)

Displayed and sent/received measured values as well as the printer output format vary with the gain coefficient.

Display format

Low-power mode (LP): Off

Range	Gain coefficient						
	(0.2000 to 1.9999) $\times 10^{-3}$	(0.2000 to 1.9999) $\times 10^{-2}$	(0.2000 to 1.9999) $\times 10^{-1}$	(0.2000 to 1.9999) $\times 1(10^0)$	(0.2000 to 1.9999) $\times 10(10^1)$	(0.2000 to 1.9999) $\times 10^2$	(0.2000 to 1.9999) $\times 10^3$
1000 $\mu\Omega$	0.000 000 μ	00.000 00 μ	000.000 0 μ	0000.000 μ	00.000 00 m	000.000 0 m	0000.000 m
10 m Ω	00.000 μ	000.000 μ	0000.000 μ	00.000 00 m	000.000 0 m	0000.000 m	00.000 00
100 m Ω	000.000 μ	0000.000 μ	00.000 00 m	000.000 0 m	0000.000 m	00.000 00	000.000 0
1000 m Ω	0000.000 μ	00.000 00 m	000.000 0 m	0000.000 m	00.000 00	000.000 0	0000.000
10 Ω	00.000 00 m	000.000 0 m	0000.000 m	00.000 00	000.000 0	0000.000	00.000 00 k
100 Ω	000.000 0 m	0000.000 m	00.000 00	000.000 0	0000.000	00.000 00 k	000.000 0 k
1000 Ω	0000.000 m	00.000 00	000.000 0	0000.000	00.000 00 k	000.000 0 k	0000.000 k
10 k Ω	00.000 00	000.000 0	0000.000	00.000 00 k	000.000 0 k	0000.000 k	00.000 00 M
100 k Ω	000.000 0	0000.000	00.000 00 k	000.000 0 k	0000.000 k	00.000 00 M	000.000 0 M
1000 k Ω	0000.000	00.000 00 k	000.000 0 k	0000.000 k	00.000 00 M	000.000 0 M	0000.000 M
10 M Ω	00.000 00 k	000.000 0 k	0000.000 k	00.000 00 M	000.000 0 M	0000.000 M	00.000 00 G
100 M Ω *1	000.000 0 k	0000.000 k	00.000 00 M	000.000 0 M	0000.000 M	00.000 00 G	000.000 0 G
1000 M Ω	0000.0 k	00.000 M	000.00 M	0000.0 M	00.000 G	000.00 G	0000.0 G

*1. When high-precision mode is off in the 100 M Ω range, 5 digits are displayed.

Pure resistance mode (PR): On

Range	Gain coefficient						
	(0.2000 to 1.9999) $\times 10^{-3}$	(0.2000 to 1.9999) $\times 10^{-2}$	(0.2000 to 1.9999) $\times 10^{-1}$	(0.2000 to 1.9999) $\times 1(10^0)$	(0.2000 to 1.9999) $\times 10(10^1)$	(0.2000 to 1.9999) $\times 10^2$	(0.2000 to 1.9999) $\times 10^3$
PR1000 $\mu\Omega$	0.000 000 μ	00.000 00 μ	000.000 0 μ	0000.000 μ	00.000 00 m	000.000 0 m	0000.000 m
PR10 m Ω	00.000 μ	000.000 μ	0000.000 μ	00.000 00 m	000.000 0 m	0000.000 m	00.000 00
PR100 m Ω	000.000 μ	0000.000 μ	00.000 00 m	000.000 0 m	0000.000 m	00.000 00	000.000 0

Low-power mode (LP): On

Range	Gain coefficient						
	(0.2000 to 1.9999) $\times 10^{-3}$	(0.2000 to 1.9999) $\times 10^{-2}$	(0.2000 to 1.9999) $\times 10^{-1}$	(0.2000 to 1.9999) $\times 1 (10^0)$	(0.2000 to 1.9999) $\times 10 (10^1)$	(0.2000 to 1.9999) $\times 10^2$	(0.2000 to 1.9999) $\times 10^3$
LP1000 m Ω	0000.00 μ	00.000 0 m	000.000 m	0000.00 m	00.000 0	000.000	0000.00
LP10 Ω	00.000 0 m	000.000 m	0000.00 m	00.000 0	000.000	0000.00	00.000 0 k
LP100 Ω	000.000 m	0000.00 m	00.000 0	000.000	0000.00	00.000 0 k	000.000 k
LP1000 Ω	0000.00 m	00.000 0	000.000	0000.00	00.000 0 k	000.000 k	0000.00 k

1 Open the Settings screen.

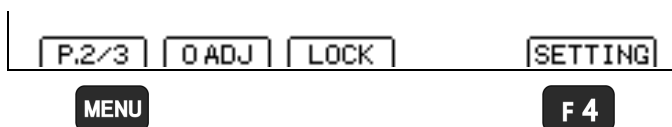

1 **MENU** Switch the function menu to P.2/3.

2 **F 4** The Settings screen appears.

4

2 Open the Measurement Setting screen.

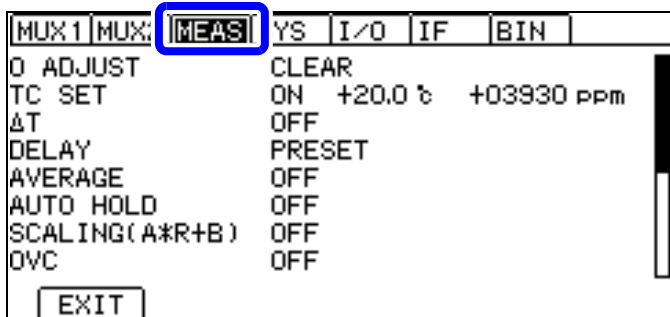

Move the cursor to the **[MEAS]** tab with the left and right cursor keys.

3 Enable (disable) the scaling function.

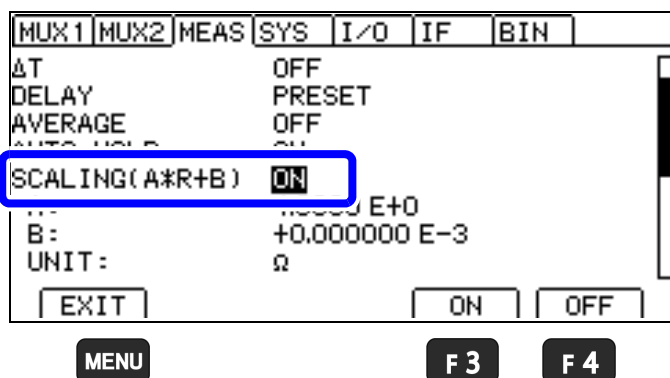

1 Selection

2 **F 3** Enables the scaling function

F 4 Disables the scaling function (default)

MENU Return to the Measurement screen.

4 Set the gain coefficient.

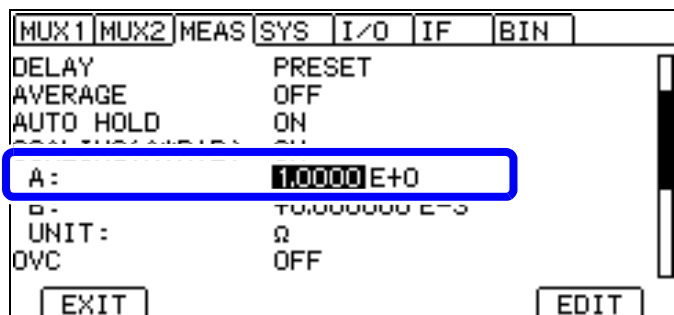

F4

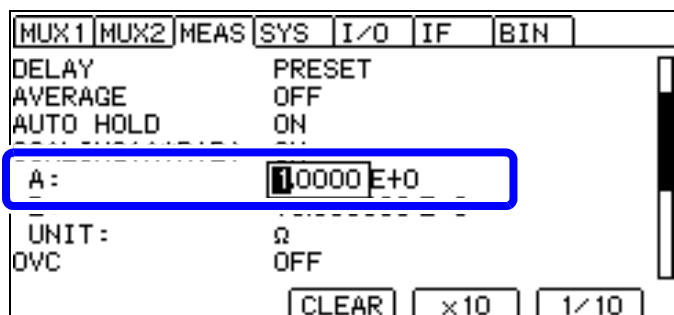

F2

F3

F4

Setting range: 0.2000×10^{-3} to 1.9999×10^3

5 Set the offset.

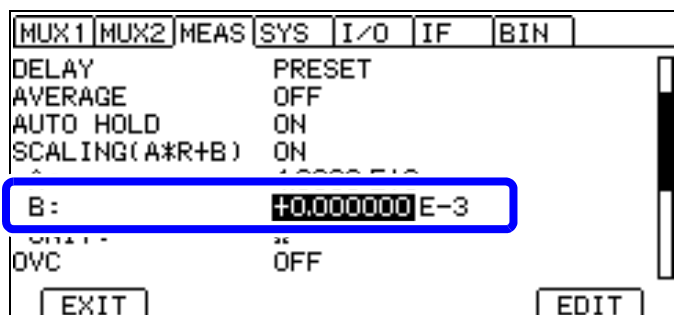

F4

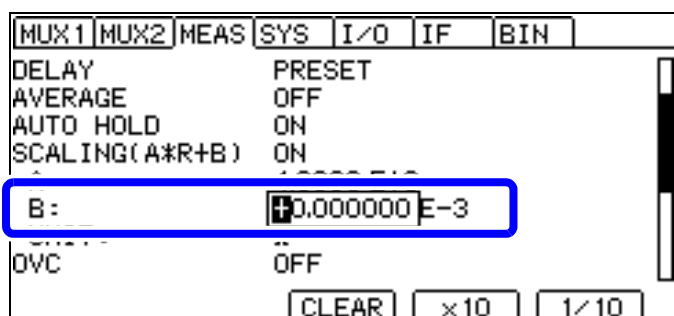

F2

F3

F4

Setting range: 0 to $\pm 9 \times 10^9$ (maximum resolution: 1 n Ω , default: 0)



1 Move the cursor to the setting you wish to configure. Make the value editable with the **F4** key.

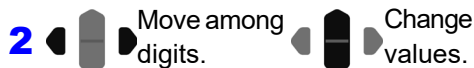

2 Move among digits. Move the cursor to the digit you wish to set with the left and right cursor keys. Change the value with the up and down cursor keys.

F3 Multiply by 10.

F4 Multiply by 1/10.

F2 Clear value.

It is not possible to set the exponent (E+3, etc.) directly. Use **F3** and **F4** to multiply by 10 or 1/10 as necessary.

3 **ENTER** Accept

(**ESC**) Cancel)



1 Move the cursor to the setting you wish to configure. Make the value editable with the **F4** key.

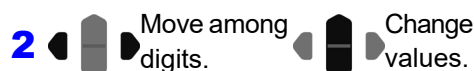

2 Move among digits. Move the cursor to the digit you wish to set with the left and right cursor keys. Change the value with the up and down cursor keys.

F3 Multiply by 10.

F4 Multiply by 1/10.

F2 Clear value.

It is not possible to set the exponent (E+3, etc.) directly. Use **F3** and **F4** to multiply by 10 or 1/10 as necessary.

3 **ENTER** Accept

(**ESC**) Cancel)

6 Set the units for the displayed measured values.

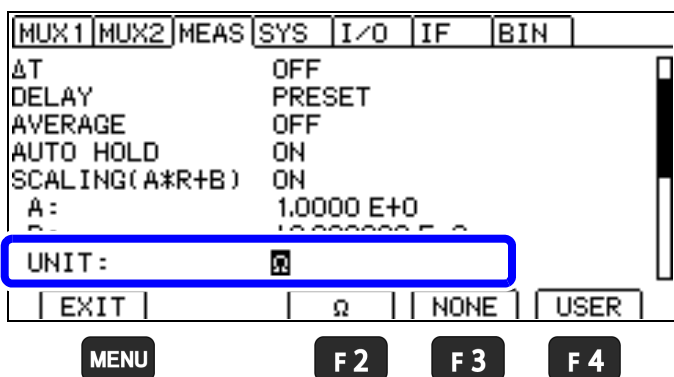

- 1** Selection
- 2**
 - F 2** Use Ω as the unit. (default)
 - F 3** Eliminate the unit.
 - F 4** Use a user-defined unit.
- MENU** Return to the Measurement screen.

7 Edit the unit as desired.

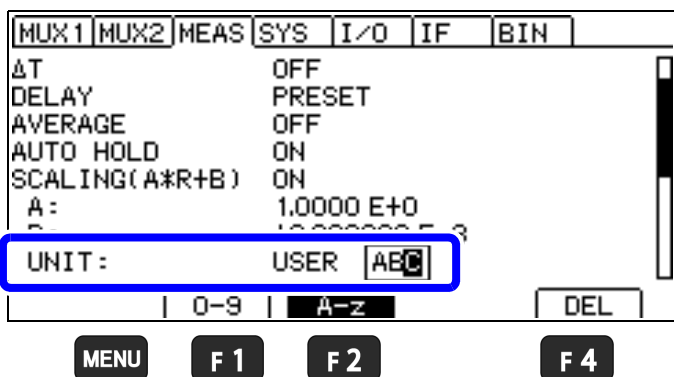

- 1** Make the value editable with the **F 4** key.
 - Move among digits.
 - Change the character.
 Move the cursor to the digit you wish to edit with the left and right cursor keys. Change the character with the up and down cursor keys.
 - F 1** Enter a number from 0 to 9
 - F 2** Enter a letter from A to z
 - F 4** Delete 1 character.
- 2** **ENTER** Accept
(**ESC**) Cancel
- MENU** Return to the Measurement screen.

IMPORTANT

Scaling calculation is performed on measured values after zero adjustment calculation. Consequently, measured values may not equal zero even after zero adjustment.

- If the calculation result exceeds the display range, the measured value will not be displayed at full scale.
Example: If you set an offset of 90 Ω for the 10 Ω range
→ Values in excess of 10 Ω will be displayed as OvrRng.
- If the calculation result is negative, the displayed value will be negative.
Example: If you set an offset of -50 m Ω for the 100 m Ω range
→ If you measure 30 m Ω , -20 m Ω will be displayed.

4.7 Changing the Number of Measured Value Digits

IMPORTANT

The number of measured value digits setting applies to all channels. (when using the Z3003)

1 Open the Settings screen.

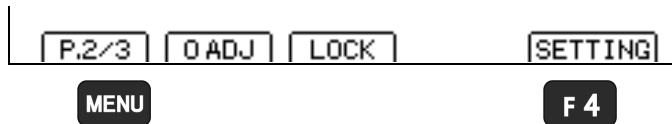

1 **MENU** Switch the function menu to P.2/3.

2 **F 4** The Settings screen appears.

2 Open the Measurement Setting screen.

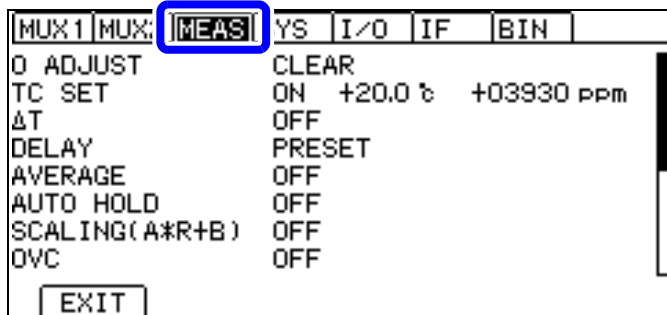

Move the cursor to the **[MEAS]** tab with the left and right cursor keys.

3 Select the number of measurement digits.

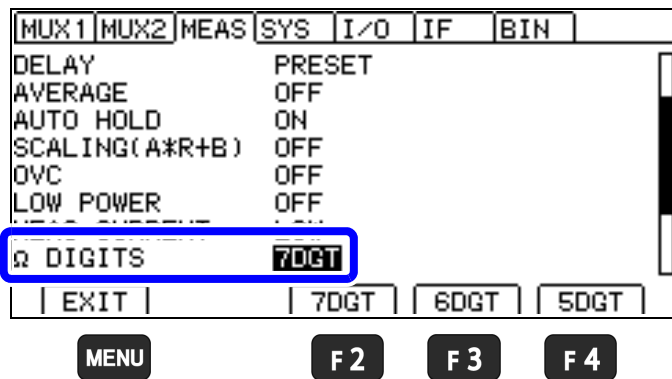

1  Selection

2
F 2 7 digits (1,000,000 digit) (default)

F 3 6 digits (100,000 digit)

F 4 5 digits (10,000 digit)

MENU Return to the Measurement screen.

- If the number of full scale digits is less than the setting, the number of full scale digits will be used. For more information about of full scale, see “Basic specifications” (p.264).
- Changing the number of digits will not change the number of digits for measured values acquired with communications commands.

4.8 Compensating for Thermal EMF Offset (OVC Function)

This function automatically compensates for offset voltage resulting from thermal emf or internal instrument bias.

See: “14.10 Effect of Thermal EMF” (p.342)

“3.1 Checking the Measurement Target” (p.46)

Offset voltage compensation (OVC) Function

The following value is known to be a true resistance value from R_P , the value measured with current flowing in the positive direction, and R_N , the value measured with current flowing in the negative direction.

$$\frac{R_P - R_N}{2}$$

- When low-power mode is disabled.
From the 10 mΩ range to the 1000 Ω range, the OVC function can be turned on.
From the 10 kΩ range to 1000 MΩ range, the OVC function cannot be used.
In the 1000 μΩ range, the OVC function is automatically turned on. This function cannot be disabled.
- When the low-power mode is on
The OVC function is automatically turned on for all ranges. This function cannot be disabled.

1 Open the Settings screen.

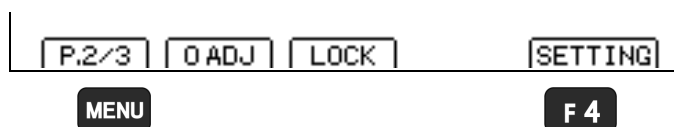

1 **MENU** Switch the function menu to P.2/3.

2 **F 4** The Settings screen appears.

2 Open the Measurement Setting screen.

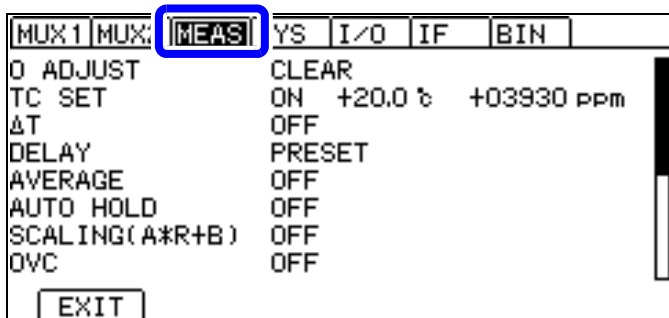

Move the cursor to the **[MEAS]** tab with the left and right cursor keys.

3 Enable (disable) the offset voltage compensation (OVC) function.

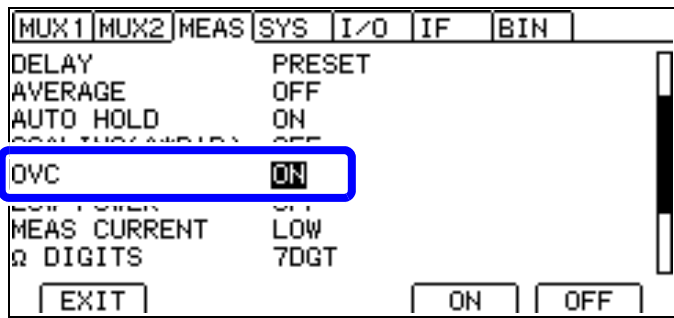

1 Selection

2
F 3 ON

F 4 OFF (default)

MENU

F 3

F 4

MENU

Return to the Measurement screen.

IMPORTANT

- If the measurement target has a high inductance, it will be necessary to increase the delay time. (p.86)
Start with a long delay time and then gradually shorten it while watching the measured value.
- When using the zero adjustment function, be sure to perform zero adjustment after disabling the offset voltage correction function.
- Zero adjustment does not need to be performed after enabling the offset voltage correction function.
- When offset voltage compensation is enabled (**[OVC]** lit) measurement time is increased. (p.265)

4.9 Switching to Pure Resistance Mode (PR)

For purely resistive measurement targets that have no inductance component, measurement times can be shortened by using pure resistance mode.

1 Open the Settings screen.

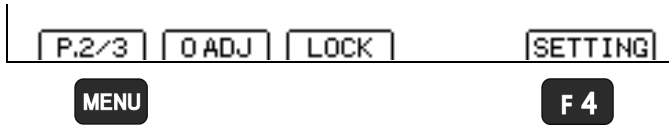

1 **MENU** Switch the function menu to P.2/3.

2 **F 4** The Settings screen appears.

2 Open the Measurement Setting screen.

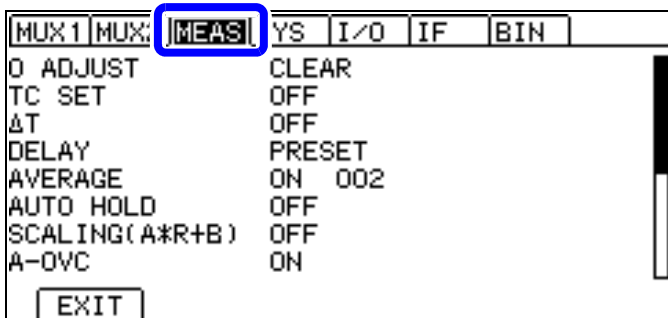

Move the cursor to the **[MEAS]** tab with the left and right cursor keys.

3 Enable (disable) the pure resistance mode.

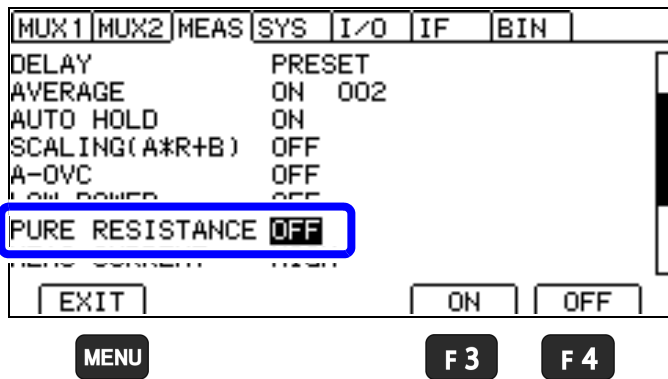

1 Selection

2
F 3 ON
F 4 OFF (default)

MENU Return to the Measurement screen.

IMPORTANT

If the measurement target contains the inductance component, the measurement becomes unstable. In such cases, disable the pure resistance mode or extend the delay.

4.10 Setting Pre-Measurement Delay (Delay Function)

This function adjusts the time for measurement to stabilize by inserting a waiting period after use of the OVC or the auto range function to change the measurement current. When this function is used, the instrument waits for its internal circuitry to stabilize before starting measurement, even if the measurement target has a high reactance component.

If the measurement target, for example, is an inductor that takes longer to stabilize after applying a measurement current, and it cannot be measured with the initial delay (default), adjust the delay. Set the delay time to approximately ten times the following calculation so that the reactance component (inductance or capacitance) does not affect the measurement.

$$t = - \frac{L}{R} \ln \left(1 - \frac{IR}{V_O} \right)$$

L : Inductance of measurement target
 R : Resistance of measurement target + test leads + contacts
 I : Measurement current (see: "Measurement accuracy" (p.271))
 V_O : Open-terminal voltage (see: "Measurement accuracy" (p.271))

The delay setting can be selected from a preset (internal fixed value) or user-set value.

Preset (internal fixed value)

Value depends on the range and offset voltage correction function.

LP: Off and PR: Off (unit: ms)

LP: On

Range	Measurement current	Delay		100 MΩ range High-precision mode
		OVC: OFF	OVC: ON	
1000 μΩ	High	–	38	–
10 mΩ	High	38	13	
100 mΩ	High	130	13	
	Low	20	1	
1000 mΩ	High	38	1	
	Low	4	2	
10 Ω	High	20	2	
	Low	5	2	
100 Ω	High	130	1	
	Low	20	2	
1000 Ω	–	130	1	
10 kΩ		180	–	
100 kΩ		95		
1000 kΩ		10		
10 MΩ		1		
100 MΩ		500		
		1		Off
1000 MΩ		1	Off	

Delay
1

PR: On

Delay
1

User-set value

Setting range: 0 to 9999 ms

The set value is used for all ranges.

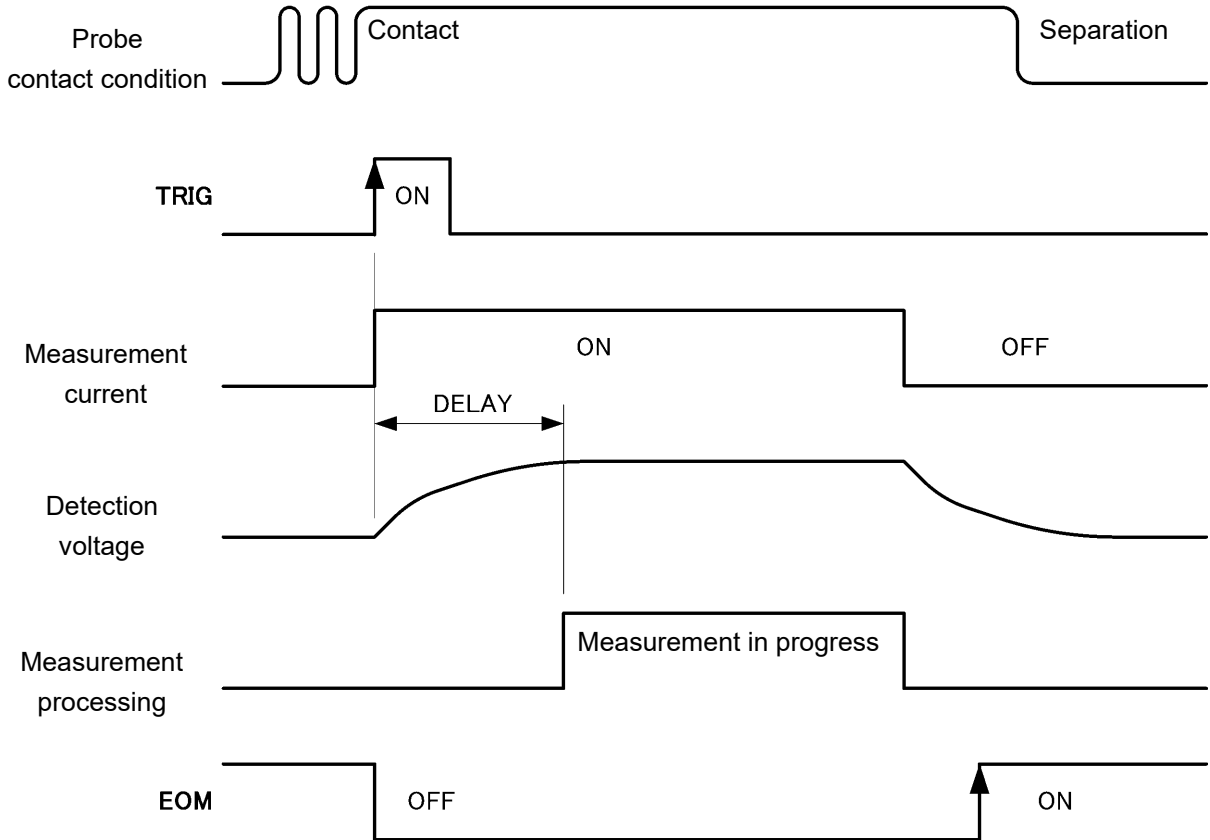
Delay timing chart

4

IMPORTANT

- The preset value is set assuming about 10 mH of inductance (1 mH in the PR mode) and varies with each measurement range.
- When using the EXT trigger source, the measurement current will not be stopped for measurement ranges of 10 k Ω and greater (continuous application).

Setting the delay time

Set the delay so that reactance component (inductance or capacitance) does not affect measurements. Start with a long delay time and then gradually shorten it while watching the measured value.

- 1 Open the Settings screen.

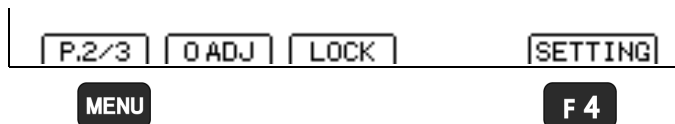

- 1 **MENU** Switch the function menu to P.2/3.

- 2 **F 4** The Settings screen appears.

- 2 Open the Measurement Setting screen.

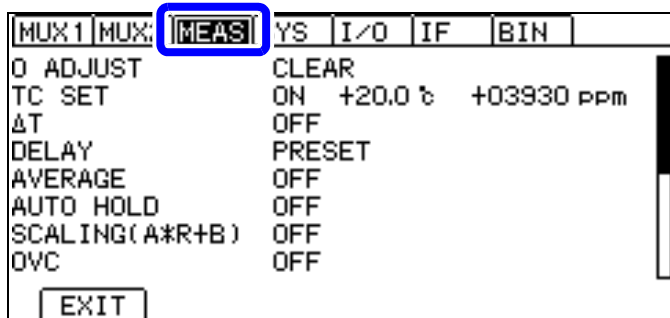

Move the cursor to the **[MEAS]** tab with the left and right cursor keys.

- 3 Select whether to use the preset (default) or a user-set value.

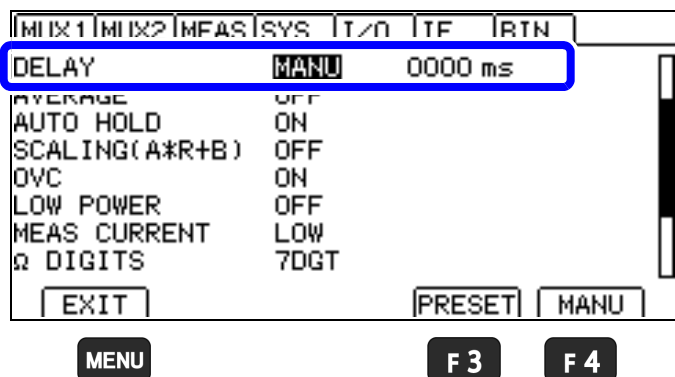

- 1  Selection

- 2 **F 3** Preset (internal fixed value)

- F 4** User-set

- MENU** Return to the Measurement screen.

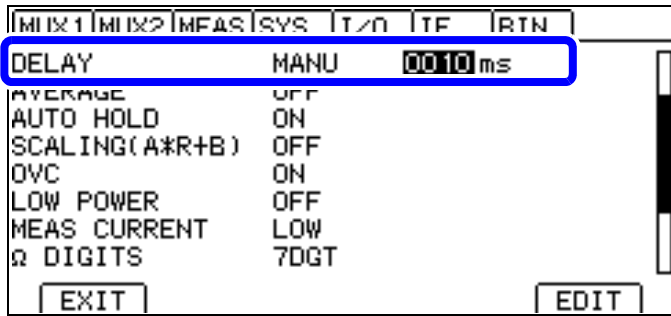
4 Set DELAY.**F4**

Setting range: 0 ms (default) to 9999 ms



1 Move the cursor to the setting you wish to configure. Make the value editable with the **F4** key.



2 Move among digits. Change values.

Move the cursor to the digit you wish to set with the left and right cursor keys. Change the value with the up and down cursor keys.

3 **ENTER** Accept

(**ESC**) Cancel

MENU Return to the Measurement screen.

4

4.11 Checking for Poor or Improper Contact (Contact Check Function)

This function detects poor contact between the probes and measurement target, and broken measurement cables.

The instrument continuously monitors the resistance between **SOURCE A** and **SENSE A**, and between **SOURCE B** and **SENSE B**, starting before the integration period (response time) and continuing while measurement is in process. If either resistance value exceeds a threshold, a contact error is deemed to have occurred.

When a contact error occurs, **[CONTACT TERM.A]** or **[CONTACT TERM.B]** error message appears. No comparator judgment is applied to the measured value.

When these error messages appear, check the probe contacts, and check for broken measurement cables. When the resistance value between the **SENSE** and **SOURCE** is high, for example when the measurement target is conductive paint or conductive rubber, you will not be able to perform measurement due to the continuous error state. In this case, turn off the contact check function.

If the error is not cleared by shorting the tips of a known-good measurement cable, the instrument requires repair.

See: “3.5 Checking Measured Values” (p.53), “14.15 Checking Measurement Faults” (p.350)

IMPORTANT

- The contact check threshold is about 50 Ω . Because the threshold depends on the measurement target, connection cables, measurement range, and other factors, it may not reach 50 Ω . Additionally, if the source resistance value alone is large, a current fault may occur without a contact error. (p.56)
- Turning the setting off with the 100 M Ω or greater range will cause the contact check function to operate continuously.
- When set to 2-wire with the multiplexer, the contact check function will be turned off.
- During low-resistance measurement, poor contact of the **SOURCE A** or **SOURCE B** probe may be detected as an over-range measurement.
- When contact checking is disabled, measured values may be displayed even when a probe is not contacting the measurement target.
- When the contact check is disabled, the measured value error component may increase when the contact resistance increases.
- When using the **INT** trigger source, current will stop when a contact error occurs (when not connected to the measurement target). By contrast, if the contact check function is disabled while using the **INT** trigger source, the maximum open voltage will be applied across the terminals when the measurement target is not connected. Consequently, a rush current will flow at the moment the instrument is connected to the measurement target.

(For example, when measuring pure resistance with the 1 A measurement current range, the instrument will reach a maximum current of 6 A with a maximum convergence time of 2 ms.)

The inrush current will vary with the range. When measuring easily damaged elements, either turn on the contact check or use a range that results in a low measurement current. However, if there is chatter even when the contact check is enabled, it will not be possible to completely prevent a rush current.

- Routing measurement cables together with power lines, signal lines, or measurement cables for other devices may result in a contact error.
- In the low-power mode, the contact check default setting is off. Turning on the contact check function will cause the open-circuit terminal voltage to change to 300 mV.

1 Open the Settings screen.

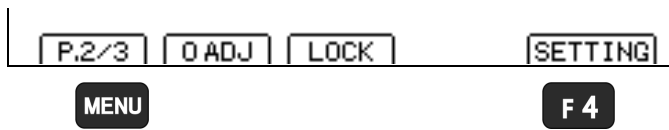

1 **MENU** Switch the function menu to P.2/3.

2 **F 4** The Settings screen appears.

2 Open the Measurement Setting screen.

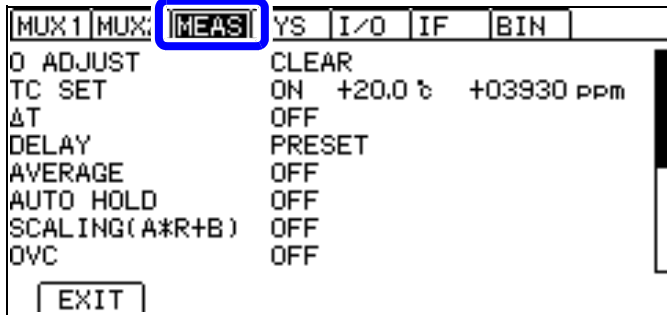

Move the cursor to the **[MEAS]** tab with the left and right cursor keys.

4

3 Enable the Contact Check function.

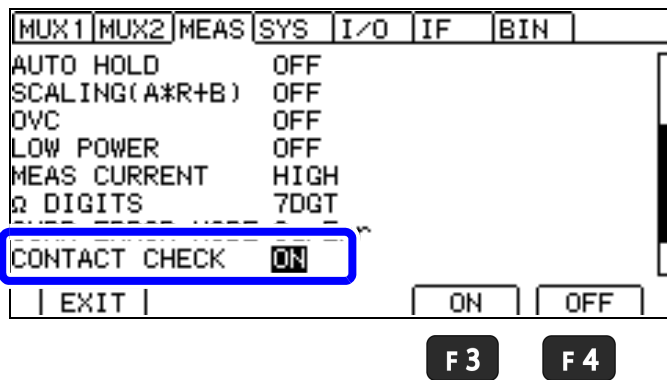

1 Selection

2 **F 3** Enables the contact check function (default setting when low-power mode is set to off)

F 4 Disables the contact check function (default setting when low-power mode is set to on)

MENU Return to the Measurement screen.

4.12 Improving Probe Contact (Contact Improvement Function)

Probe contacts can be improved by applying current from the SENSE A terminal to the SENSE B terminal before measurement.

CAUTION



■ The contact improvement function applies voltage to the sample. Be careful when measuring samples with susceptible characteristics (magnetoresistive elements, signal relays, EMI filters, etc.).

Such characteristics of the measurement target may be affected by the use of the function.

The maximum contact improvement current is 10 mA, and the maximum applied voltage is 5 V.

When low-power mode is set to on, the contact improvement function is set to off.

Using the contact improvement function causes the time until measurement completion to be lengthened by 0.2 ms.

Timing chart (contact improvement function)

The measurement currents when OVC is disabled are shown.

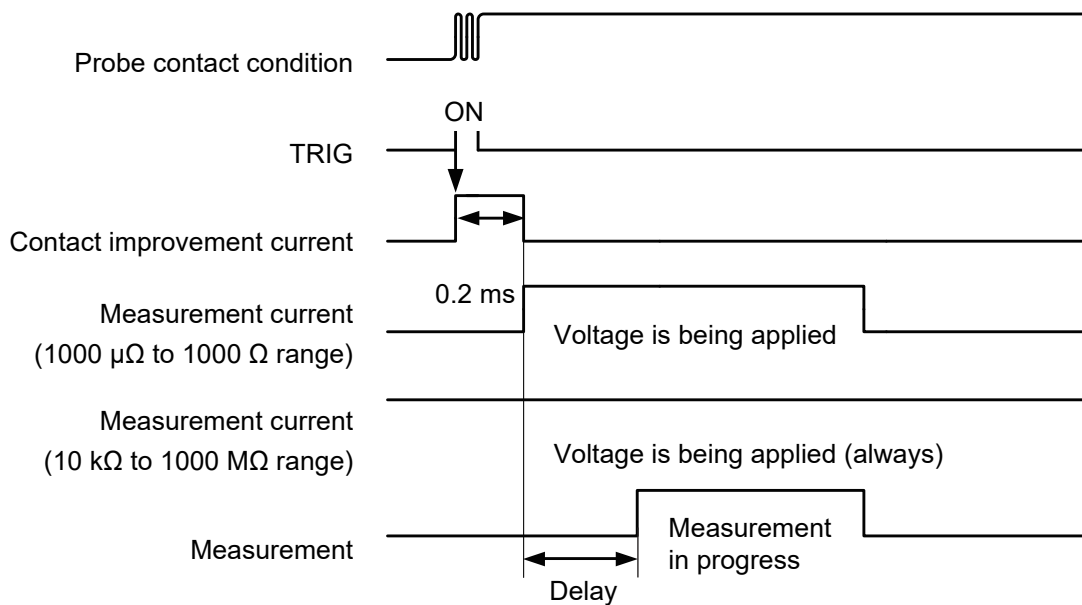

1 Open the Settings screen.

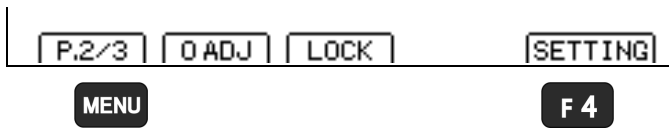

1 **MENU** Switch the function menu to P.2/3.

2 **F 4** The Settings screen appears.

2 Open the Measurement Setting screen.

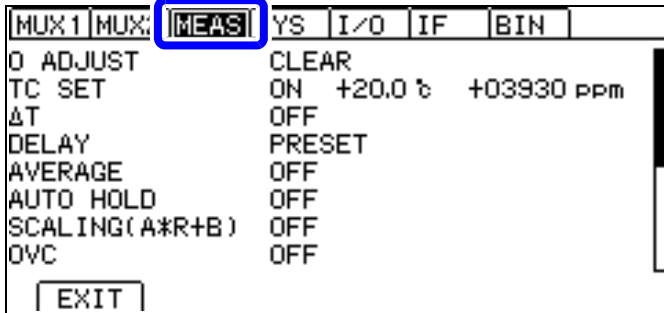

Move the cursor to the **[MEAS]** tab with the left and right cursor keys.

4

3 Enable (disable) the contact improvement function.

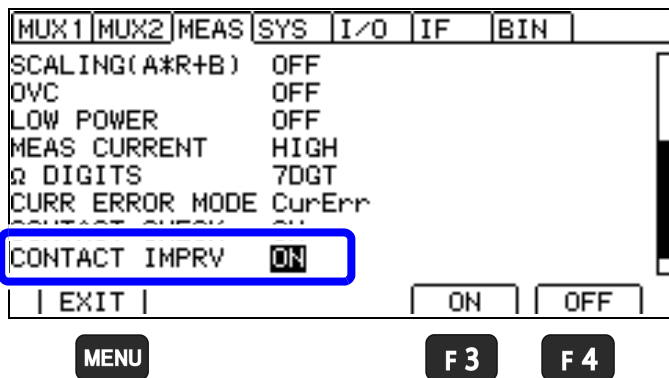

1 Selection

2

F 3 Enables the contact improvement function

F 4 Disables the contact improvement function (default)

MENU Return to the Measurement screen.

4.13 Maintaining Measurement Precision (Self-Calibration)

The instrument corrects the circuitry's internal offset voltage and gain drift as a form of self-calibration in order to maintain its measurement precision.

You can select between two self-calibration function execution methods.

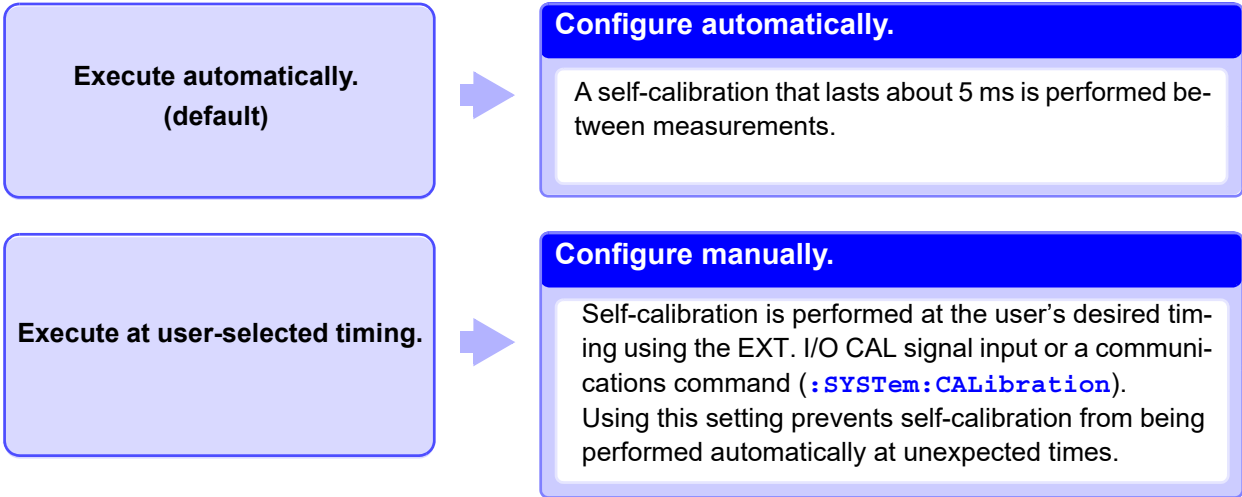

Self-calibration timing and intervals

Setting	Calibration timing	Measurement hold interval (calibration interval)
Auto *1	After measurement	5 ms
Manual	During execution	400 ms

*1. When using the auto setting

When using the auto setting, self-calibration is performed for 5 ms once every second during TRIG standby operation.

In the event the TRIG signal is received during a 5 ms self-calibration, the self-calibration is canceled, and measurement will start after 0.5 ms. If you are concerned about variation in measurement times, please use the manual setting.

1 Open the Settings screen.

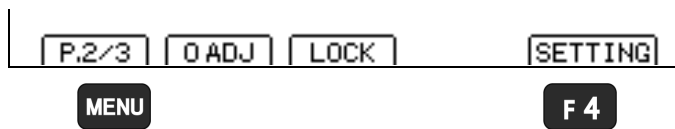

1 **MENU** Switch the function menu to P.2/3.

2 **F 4** The Settings screen appears.

2 Open the System Setting screen.

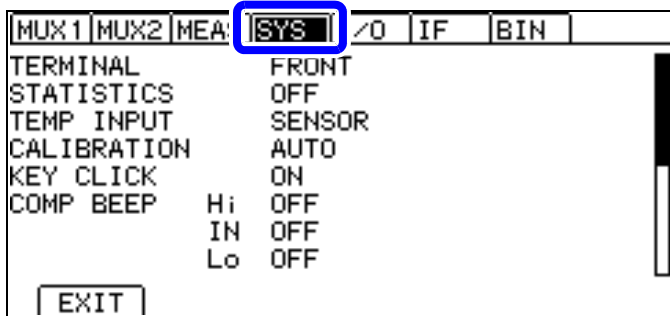

Move the cursor to the [SYS] tab with the left and right cursor keys.

3 Configure self-calibration operation.

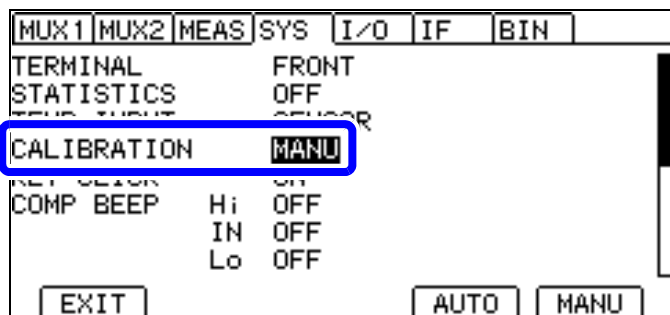

1 Selection

2 **F3** Configure automatically (default).

F4 Configure manually.

F3

F4

MENU Return to the Measurement screen.

4

IMPORTANT

When self-calibration operation is set to manual, be sure to perform self-calibration if the temperature of the environment in which the instrument is operating changes by 2 degrees or more. Accuracy cannot be guaranteed if self-calibration is not performed.

Even if the temperature variation in the operating environment is less than 2 degrees, self-calibration should be performed at a 30-minute interval.

Auto setting operation

Self-calibration starts immediately after measurement completes and is finished in 5 ms. One TRIG signal received during self-calibration is held, and measurement will start after the self-calibration completes.

If there is at least 5 ms of extra time in the measurement interval

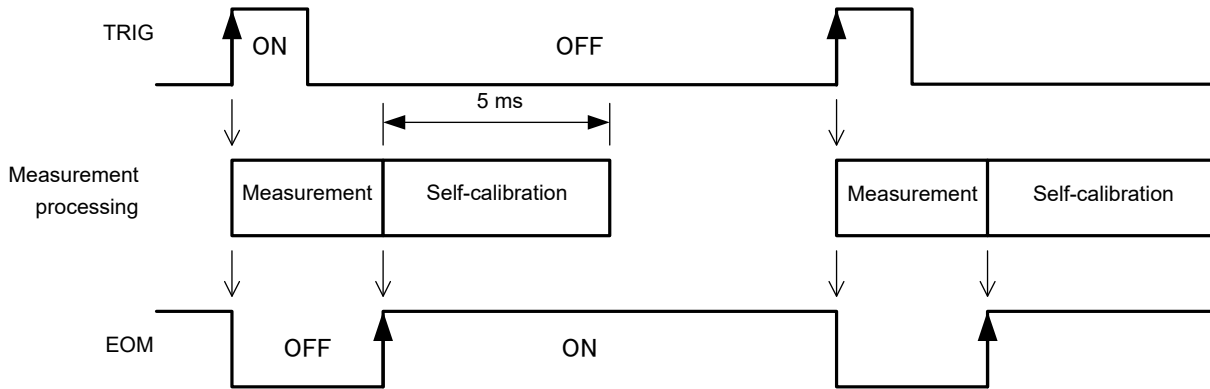

If the TRIG signal is received during self-calibration

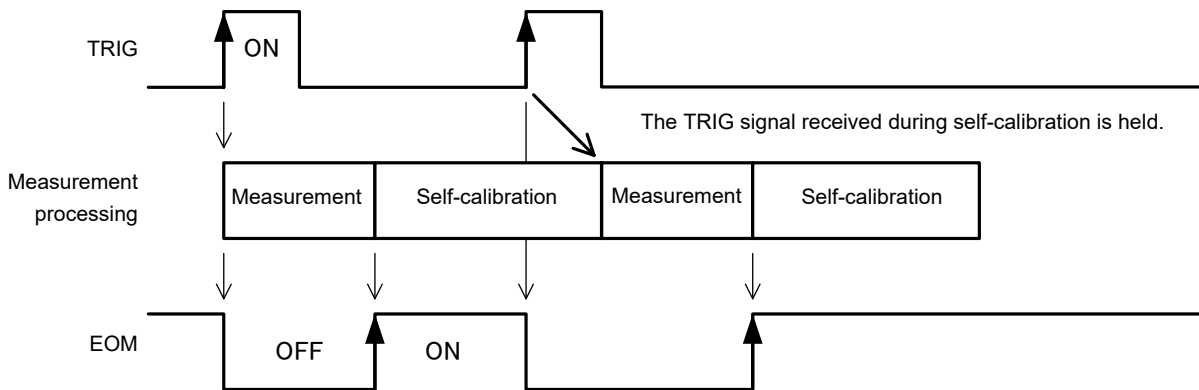

Additionally, self-calibration is performed once every second during TRIG standby operation. In the event the TRIG signal is received during self-calibration, the self-calibration is canceled, and measurement will start after 0.5 ms.

IMPORTANT

- During auto-scan operation, self-calibration starts only after scanning completes. Self-calibration will not be performed after each channel is measured.
- A 400 ms self-calibration is performed immediately after switching from MANUAL to AUTO. Do not input the TRIG signal during that interval.

Manual setting operation

Self-calibration starts immediately when the CAL signal is input.

If the TRIG signal is input during self-calibration, self-calibration will continue. In this case, the TRIG signal will be accepted, the EOM signal will turn off, and measurement will start after self-calibration completes.

If the CAL signal is received during measurement, the CAL signal will be accepted, and self-calibration will start after measurement completes.

Method of normal use

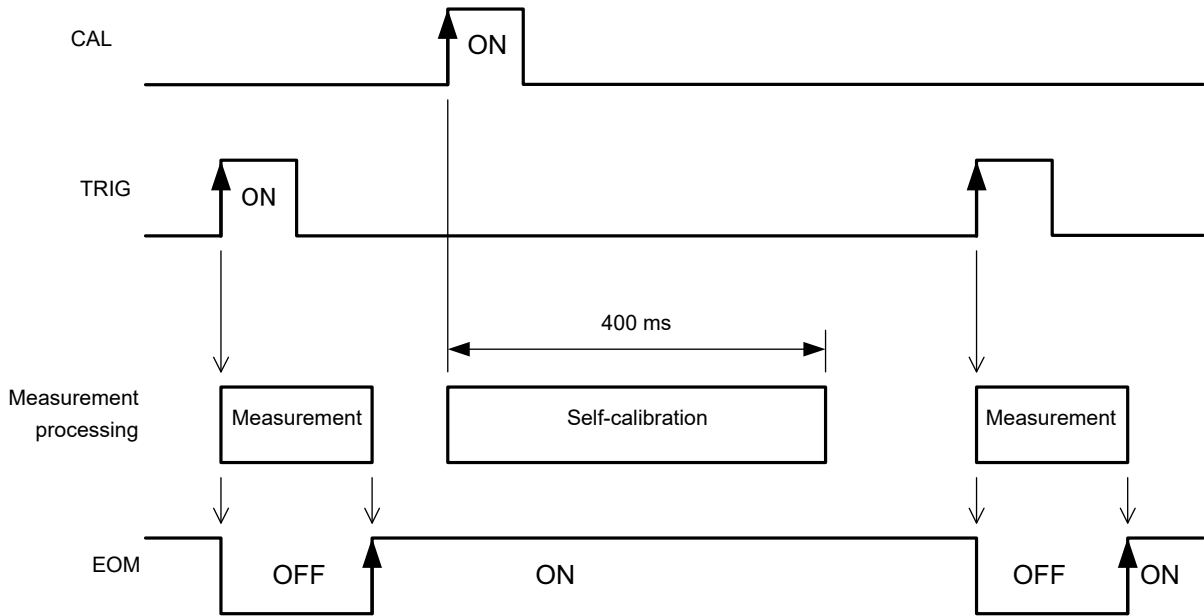

If the TRIG signal is received during self-calibration

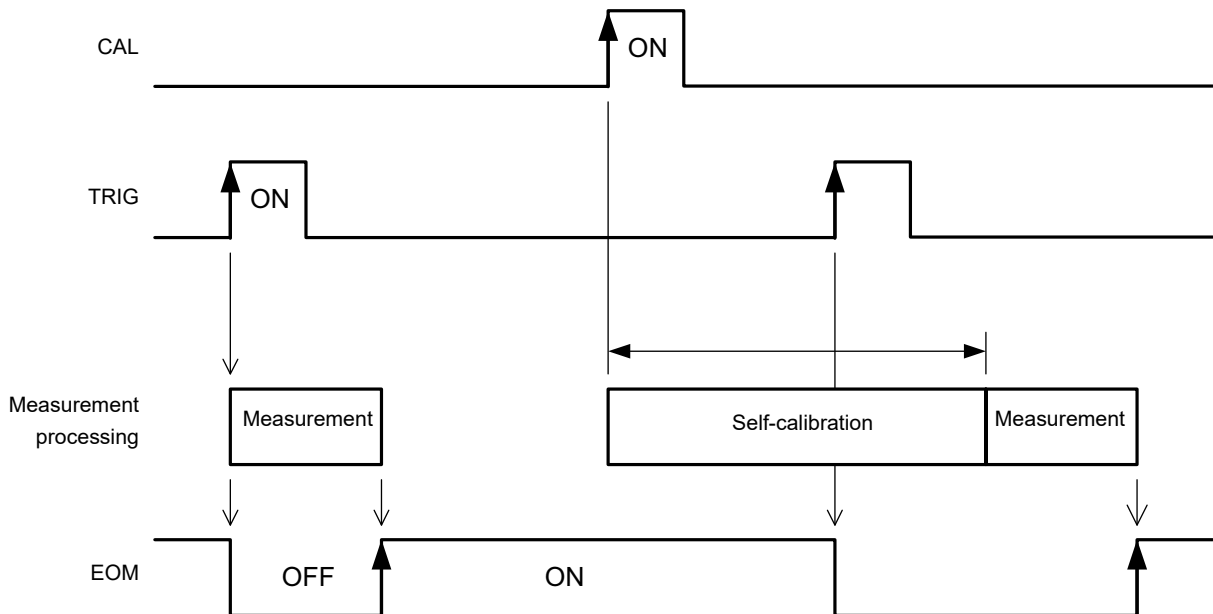

4.14 Increasing the Precision of the 100 MΩ Range (100 MΩ Range High-precision Mode)

The precision of the 100 MΩ range can be increased.

However, turning on high-precision mode has the following effects:

- The 1000 MΩ range will be unavailable for use.
- More time will be required for measured values to stabilize. To adjust the time required until values stabilize, set a delay.

See: “4.10 Setting Pre-Measurement Delay (Delay Function)” (p.86)

1 Open the Settings screen.

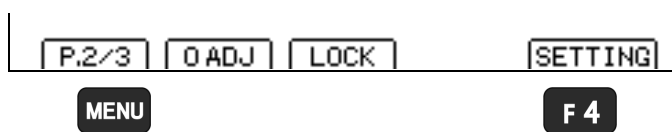

1 **MENU** Switch the function menu to P.2/3.

2 **F 4** The Settings screen appears.

2 Open the Measurement Setting screen.

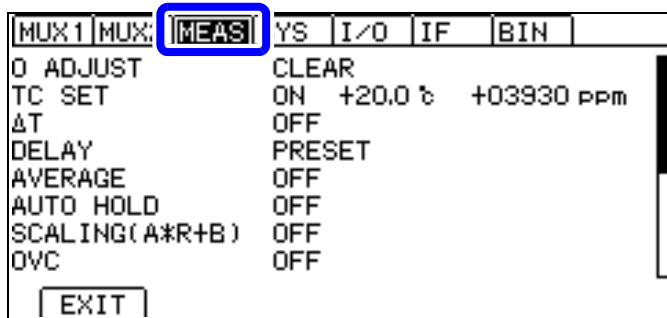

Move the cursor to the **[MEAS]** tab with the left and right cursor keys.

3 Enable (disable) the 100 MΩ range high-precision mode.

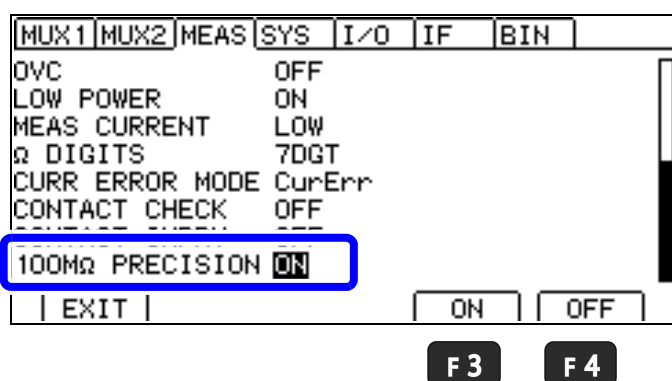

1  Selection

2 **F 3** Enables the high-precision mode

F 4 Disables the high-precision mode

MENU Return to the Measurement screen.

4.15 Judging Measured Values (Comparator Function)

The comparator function provides the following capabilities:

- **Displaying judgment results on the instrument (COMP lamp Hi/ IN/ Lo)**

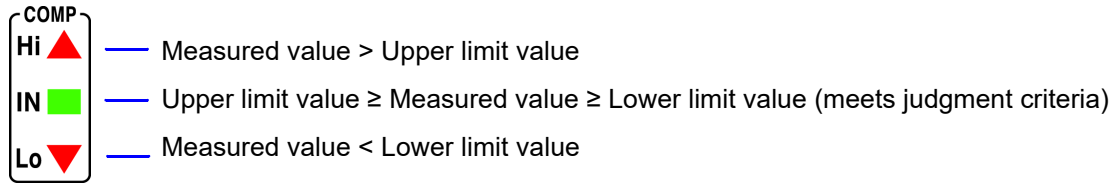

- **Sounding the beeper**

(By default, the beeper is disabled.)

See: "Checking judgments using sound (judgment sound setting function)" (p.106)

- **Displaying judgment results closer at hand**

The L2105 LED Comparator Attachment is an option.

See: "Checking judgments with the L2105 LED Comparator Attachment (option)" (p.108)

- **Outputting judgment results to external equipment**

See: "9 External Control (EXT. I/O)" (p.185)

- **Making a total judgment**

See: "Total judgments" (p.162)

The comparator judgment mode can be set as one of the following 2 options.

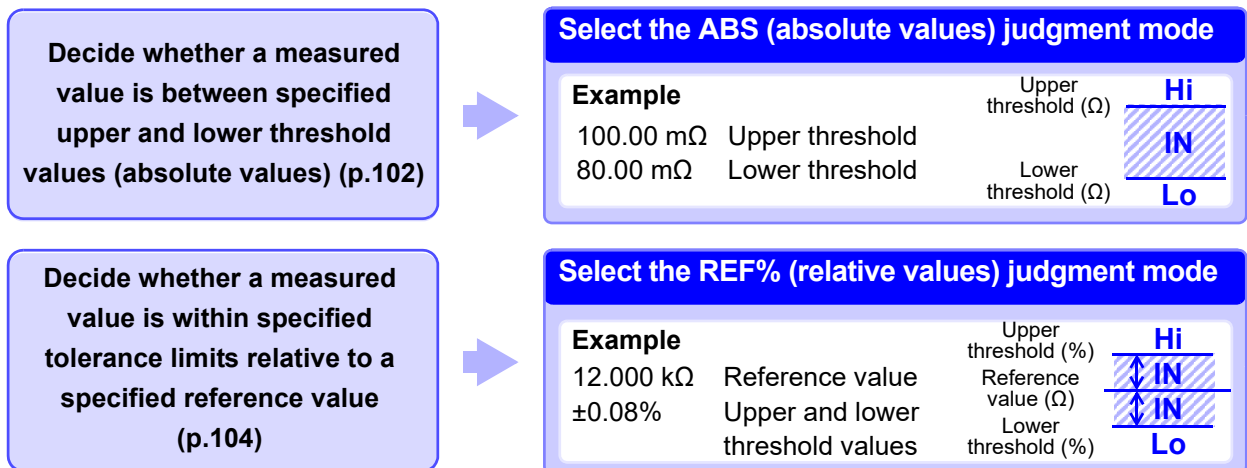

Before using the comparator function

- The comparator judgment indicator will function as follows for over-range events ([OvrRng] display) and measurement faults ([CONTACT TERM] display or [- - - - -] display):
See: "Confirming measurement faults" (p.56)

Measured value display	Comparator Judgment (COMP) Indicator
+OvrRng	Hi
-OvrRng	Lo
CONTACT TERM or - - - - -	Off (no judgment)

- If power is turned off during comparator setting, changes to settings are lost as they revert to their previous values. To accept the settings, press  .

Enabling and disabling the comparator function

The comparator function is disabled by default.

When the function is disabled, comparator settings are ignored.

- 1 Open the Comparator Settings screen.

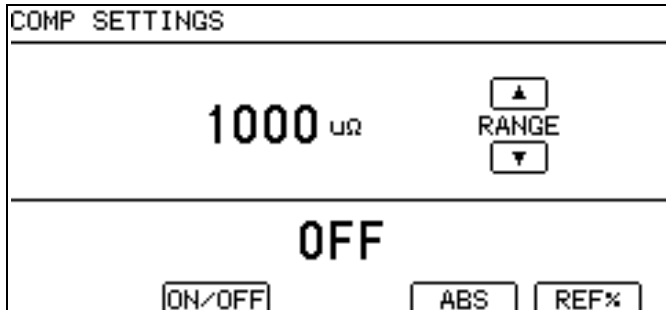

COMP The Comparator Settings screen appears.

- 2 Enable or disable the comparator function.

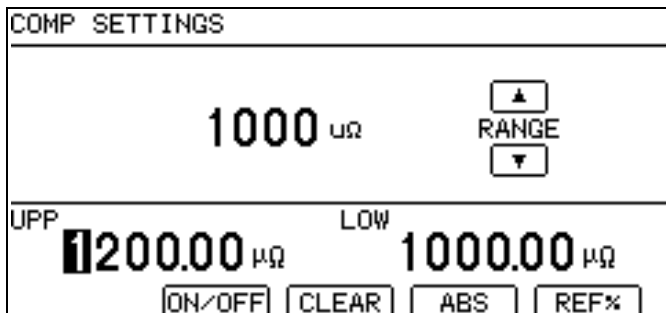

F1 Switch the comparator function ON or OFF.

- 3 Return to the Measurement screen.

ENTER

When the comparator function is off

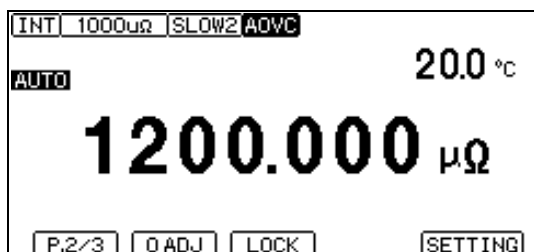

When the comparator function is on

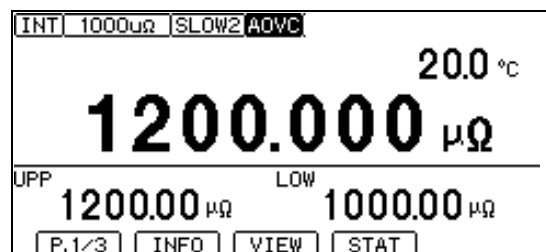

Comparator judgments are indicated only when the comparator function is enabled.

IMPORTANT

- Turning on the ΔT or BIN measurement function causes the comparator function to automatically turn off.
- The range cannot be changed while using the comparator function. To change the range, do so with the and keys on the Comparator Settings screen. To use auto-ranging, turn off the comparator function.

Decide according to upper/lower thresholds (ABS mode)

Setting example: Upper threshold 12 mΩ, lower threshold 10 mΩ

To abort the setting process, press **ESC**. Settings are abandoned and the display returns to the previous screen.

1 Open the absolute value threshold setting screen.

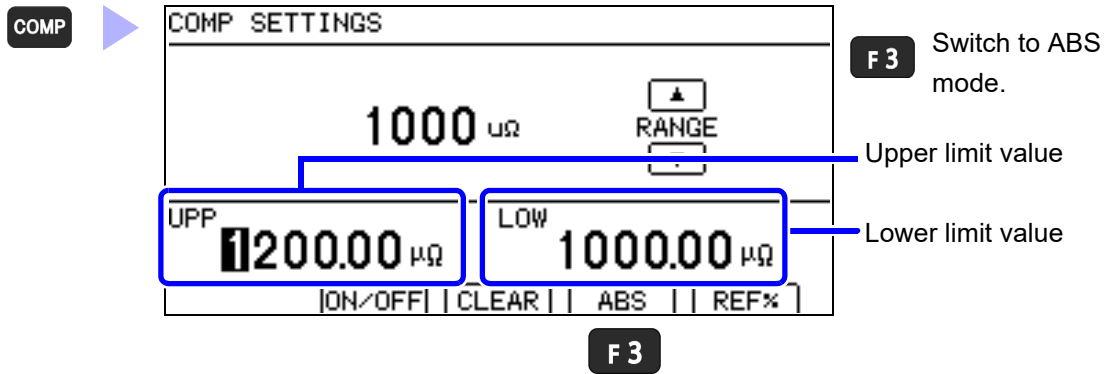

2 Set the range.

- Select the range to use.
- The decimal point location and unit indicator change each time you press the button.

3 Set the upper limit value.

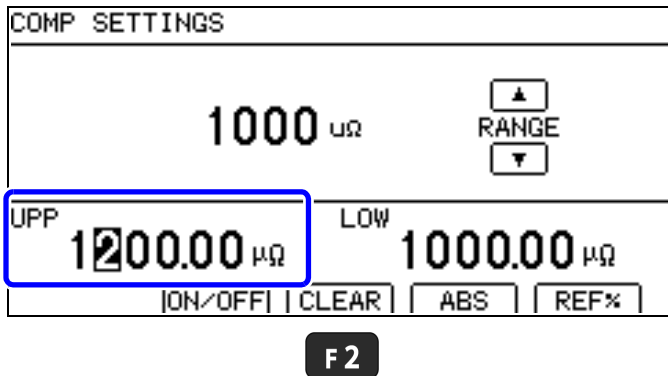

Move among digits.

Change values.

Move the cursor to the digit you wish to set with the left and right cursor keys. Change the value with the up and down cursor keys.

To reset numerical values

Press **F2** to clear the upper limit value. The upper limit value will be reset to 0.

4 Set the lower limit value in the same way.

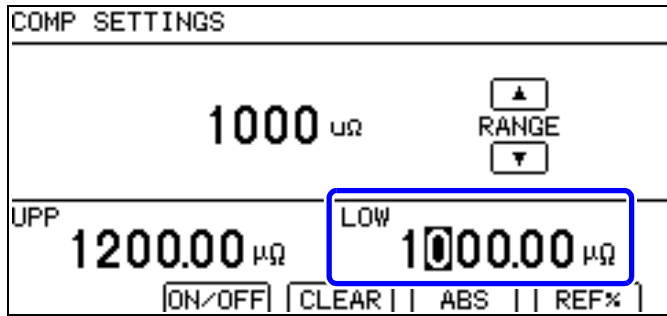

5 Accept the settings and return to the Measurement screen.

ENTER

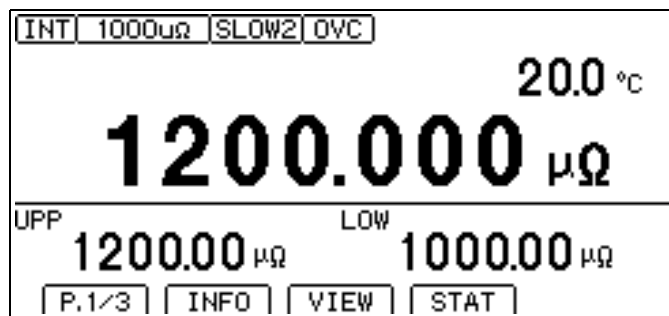

4

Decide according to reference value and tolerance (REF% mode)

When REF% mode is enabled, the measured value will be displayed as an absolute value (%).

$$\text{Relative value (tolerance)} = \left(\frac{\text{Measured value}}{\text{Reference value}} - 1 \right) \times 100 (\%) \quad \text{Display range: } -999.999\% \text{ to } +99.999\%$$



Example setting: Set a reference value of 10 mΩ with ±1% allowable range.

To abort the setting process, press **ESC**. Settings are abandoned and the display returns to the previous screen.

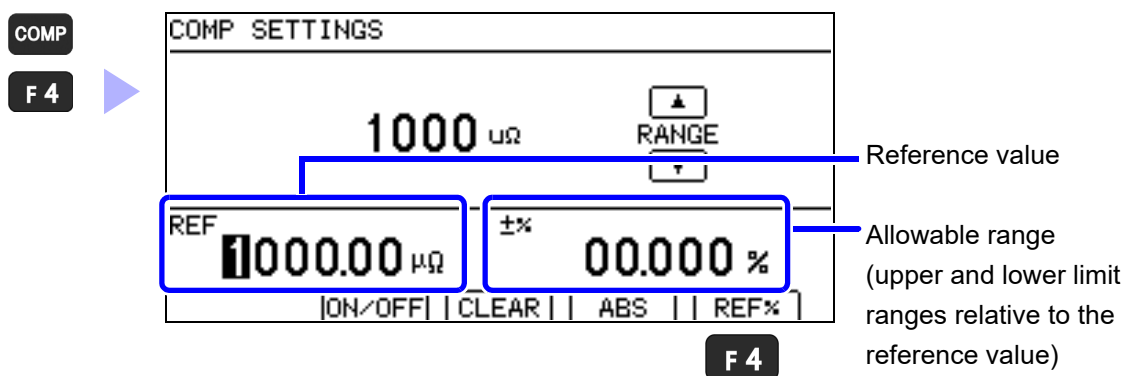
1 Open the relative tolerance setting screen.





2 Set the range.

-  Select the range to use.
-  The decimal point location and unit indicator change each time you press the button.

3 Set the reference value.

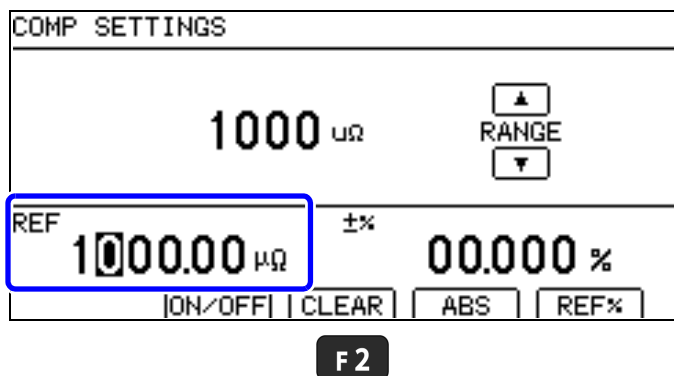
Pressing an inoperative key during setting sounds a low-pitch beep (when the key beeper is enabled).



 Move among digits.
 Change values.
 Move the cursor to the digit you wish to set with the left and right cursor keys. Change the value with the up and down cursor keys.

To reset numerical values



Press **F2** to clear the reference value. The reference value will be reset to 0.

When using REF% mode and the multiplexer, the CH1 measurement results can be used as the reference value by pressing **F2** on MENU P.2/2.

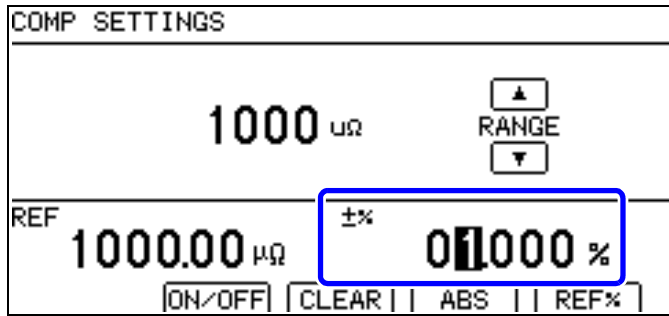
4 Set the allowable range (upper and lower limit values).



F2

 Move among digits.
  Change values.

Move the cursor to the digit you wish to set with the left and right cursor keys. Change the value with the up and down cursor keys.

To reset numerical values

Press **F2** to clear the upper and lower limit values. The upper and lower limit values will be reset to 0.

5 Accept the settings and return to the Measurement screen.

ENTER

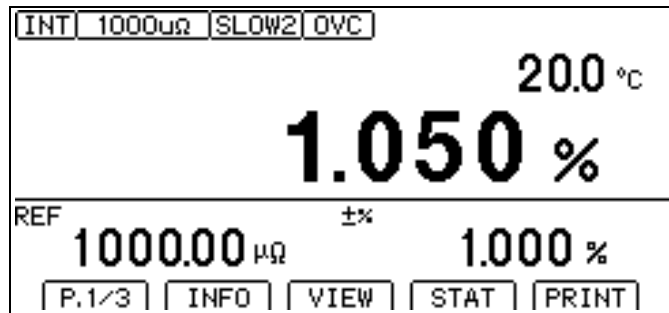

4

Checking judgments using sound (judgment sound setting function)

The comparator judgment beeper can be enabled and disabled.
The judgment beeper is disabled (off) by default.

Separate judgment tones can be set for Hi, IN, and Lo judgments.

When using the multiplexer, separate judgment tones can be set for PASS and FAIL judgments when the scan function is set to auto or step.

1 Open the Settings screen.

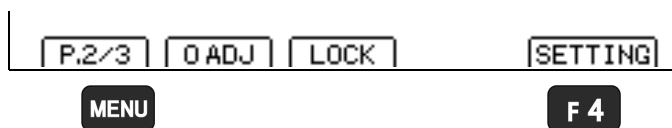

1 **MENU** Switch the function menu to P.2/3.

2 **F 4** The Settings screen appears.

2 Open the System Setting screen.

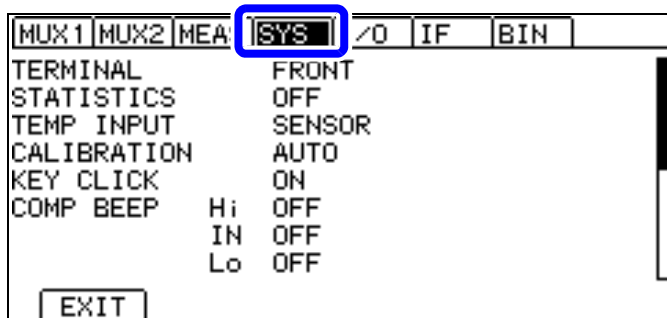

Move the cursor to the **[SYS]** tab with the left and right cursor keys.

3 Select the sound you desire for Hi judgments.

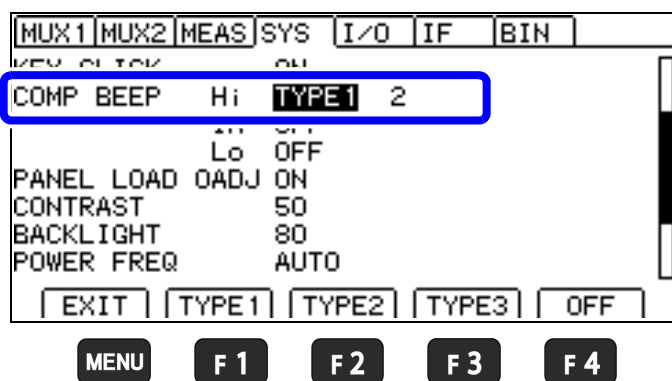

1  Selection

2 **F 1** to **F 3**
Select the sound you desire.

F 4

Disable the beeper. (default)

MENU Return to the Measurement screen.

4 Select the number of times to sound the beeper for Hi judgments.

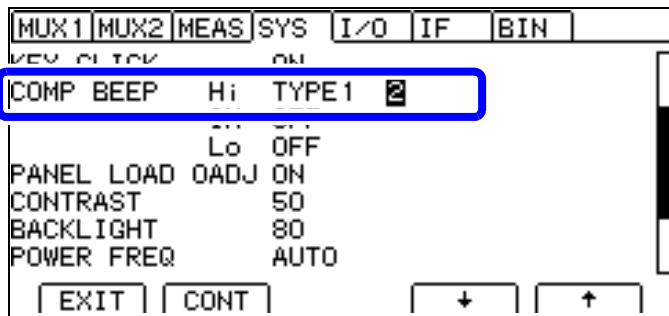

MENU

F 1

F 3

F 4

Setting range: 1 to 5 times, continuous



Move the cursor to the setting you wish to configure.

F 1

To sound the beeper continuously

To set the number of beeps:

F 3

F 4

Change the number of beeps.

MENU

Return to the Measurement screen.

4

5 Repeat this process to configure the settings for the IN and Lo judgments.

IMPORTANT

The volume cannot be adjusted.

Checking judgments with the L2105 LED Comparator Attachment (option)

By connecting the L2105 LED Comparator Attachment to the COMP.OUT terminal, you can check judgment results easily at a distance from the instrument.

The indicator will turn green for IN judgments and red for Hi and Lo judgments.

CAUTION



- **Do not over-tighten the cable tie.**
Doing so may damage the measurement leads.

- **Do not twist or pull on cables.**
- **Do not bend cables near the lamp excessively in order to connect them.**
Doing so could damage the cable conductor or insulation.



- **Turn off the instrument before connecting the L2105 LED Comparator Attachment.**
Failure to do so could damage the instrument or L2105.
- **Only connect the L2105 LED Comparator Attachment to the COMP.OUT terminal.**
The COMP.OUT terminal is provided exclusively for use with the L2105. Connecting anything other than the L2105 could damage the instrument.
- **Seat connectors securely.**
Failure to do so could prevent the instrument from performing to specifications.

Attaching the L2105 LED Comparator Attachment

Position the LED Comparator Attachment where you wish.

Example: Using a tie band and two of the spiral wrappers that came with the L2105, attach the LED Comparator Attachment to a measurement lead.

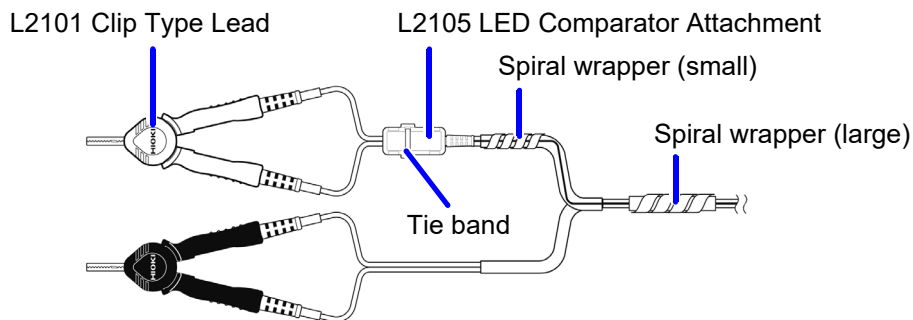

Connecting the LED Comparator Attachment to the Instrument

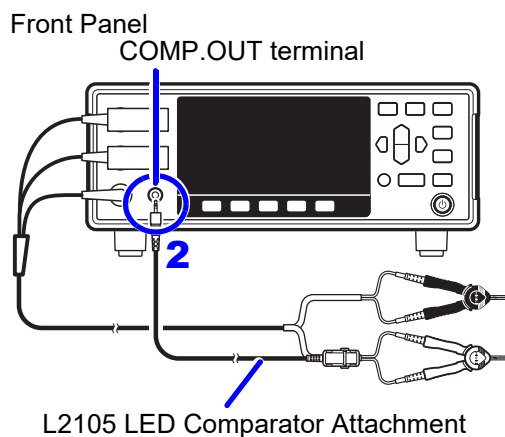

- 1** Confirm that the instrument's Main power switch (rear panel) is off (○).
- 2** Plug the L2105 LED Comparator Attachment into the COMP.OUT terminal on the front panel.

IMPORTANT



Insert the comparator attachment securely all the way into the terminal.

4.16 Classifying Measurement Results (BIN Measurement Function)

BIN measurement compares a measured value with up to ten sets of upper and lower thresholds (BIN 0 to BIN 9) in one operation, and display the results. Measured values that do not fall in any BIN are judged to be OB (out-of-bin). Judgment results are also output at the EXT. I/O terminal.

See: "Connector type and signal pinouts" (p.188)

IMPORTANT

- When the BIN measurement function is on, the comparator cannot be turned on.
- Turning on ΔT or setting the measurement terminal to multiplexer automatically turns off the BIN measurement function.
- The range cannot be changed while using the BIN measurement function. To change the range, do so with the  and  keys on the BIN Number Settings screen. Turn off the BIN measurement function when using auto-ranging.

4

1 Open the Settings screen.

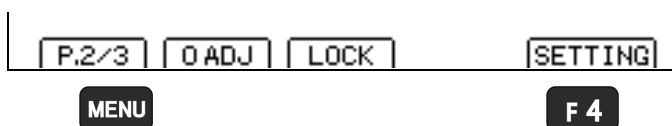

1  Switch the function menu to P.2/3.

2  The Settings screen appears.

2 Open the BIN Setting screen.

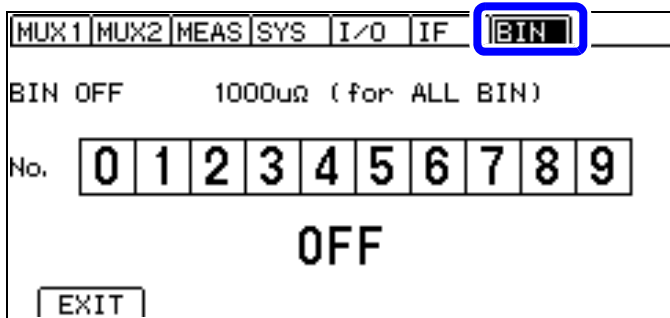

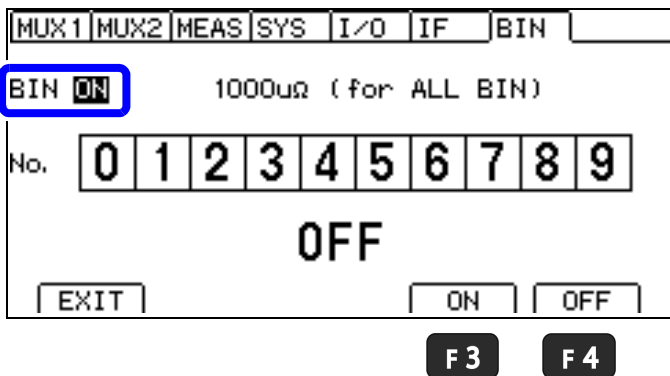

Move the cursor to the [BIN] tab with the left and right cursor keys.

3 Enable (disable) the BIN function.



1  Selection

2  Enables the BIN function.

 Disables the BIN function. (default)

4 Set the BIN number.

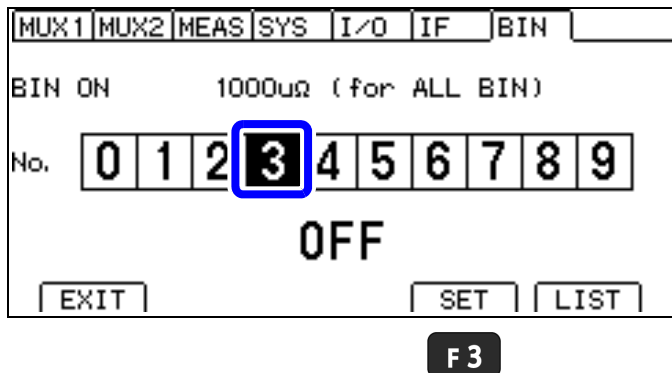

1 Selection

2

Select a BIN number with the left and right cursor keys.

3 Set the selected BIN number.

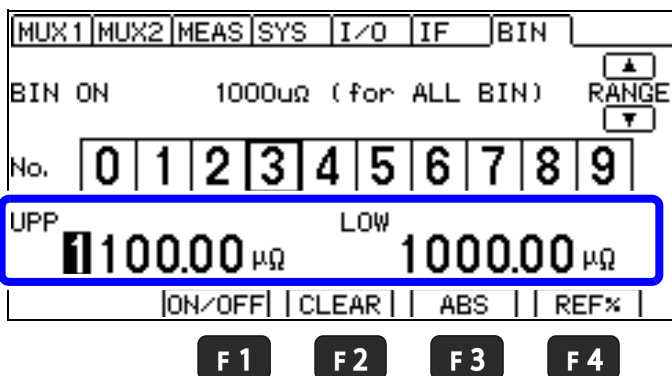

4 Move among digits. Change values.

Move the cursor to the digit you wish to set with the left and right cursor keys. Change the value with the up and down cursor keys.

F1 Enable or disable comparator.

F2 Clears the setting for the highlighted parameter.

F3 Sets the judgment mode to ABS (UPP, LOW).

F4 Set the judgment mode to REF%.

Range switching
(The range setting applies to all BIN numbers.)

5 Accept

(Cancel)

Return to the previous screen.

You can also display a list of set BIN numbers.

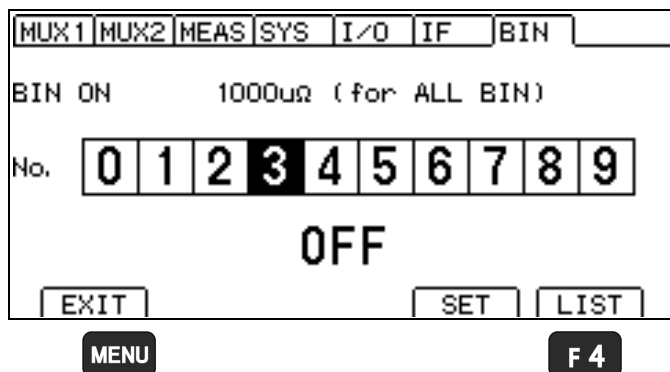

F4 BIN setting list display

MENU Return to the Measurement screen.

BIN setting list display

MUX1	MUX2	MEAS	SYS	I/O	IF	BIN
BIN0	UPP	1200.00 $\mu\Omega$		LOW		1170.00 $\mu\Omega$
BIN1	UPP	1170.00 $\mu\Omega$		LOW		1150.00 $\mu\Omega$
BIN2	UPP	1150.00 $\mu\Omega$		LOW		1100.00 $\mu\Omega$
BIN3	UPP	1100.00 $\mu\Omega$		LOW		1000.00 $\mu\Omega$
BIN4	OFF					
BIN5	OFF					
BIN6	OFF					
BIN7	OFF					
EXIT						

Measurement screen: when the BIN function is ON

INT	1000 $\mu\Omega$	SLOW2	OVC						
								20.0	$^{\circ}\text{C}$
								1130.120	$\mu\Omega$
BIN	0	1	2	3					OB
	P.1/3	INFO	VIEW	STAT					PRINT

The BIN number with the IN judgment will be shown in reverse video.

4

4.17 Performing Statistical Calculations on Measured Values

Statistical calculations can be performed on up to 30,000 measured values, with results displayed. Printing is also available (p.257).

Calculation types: average, maximum and minimum values, population standard deviation, sample standard deviation, process compatibility indices

Maximum value	$X_{\max} = \text{MAX}(x_1, \dots, x_n)$
Minimum value	$X_{\min} = \text{MIN}(x_1, \dots, x_n)$
Average	$\bar{x} = \frac{\sum x}{n}$
Population standard deviation	$\sigma_n = \sqrt{\frac{\sum x^2 - n\bar{x}^2}{n}}$
Standard deviation of sample	$\sigma_{n-1} = \sqrt{\frac{\sum x^2 - n\bar{x}^2}{n-1}}$
Process capability index*1 (dispersion)	$C_p = \frac{ UPP-LOW }{6\sigma_{n-1}}$
Process capability index*1 (bias)	$C_{pk} = \frac{ UPP-LOW - UPP + LOW - 2\bar{x} }{6\sigma_{n-1}}$

In these formulas, n represents the number of valid data samples.

*1. Process capability index

- The process capability indices represent the quality achievement capability created by a process, which is the breadth of the dispersion and bias of the process' quality. Generally, depending on the values of C_p and C_{pk} , process capability is evaluated as follows:

Process capability

- $C_p, C_{pk} > 1.33$ Ideal
- $1.33 \geq C_p, C_{pk} > 1.00$ Adequate
- $1.00 \geq C_p, C_{pk}$ Inadequate

- UPP and LOW are the upper and lower thresholds of the comparator.
- When the BIN function is on, the process capability index will not be calculated.

IMPORTANT

- Internally, statistical calculations are processed by the floating point method, which involves fractional numbers in the displayed digits or below in calculations.
- When only one valid data sample exists, standard deviation of sample and process capability indices are not displayed.
- When $\sigma_{n-1} = 0$, C_p and C_{pk} are 99.99.
- The upper limit of C_p and C_{pk} is 99.99. If C_p or C_{pk} exceeds 99.99, the value 99.99 is displayed.
- Negative values of C_{pk} are handled as $C_{pk} = 0$.
- If statistical calculation is turned off and then back on without first clearing calculation results, calculation resumes from the point when it was turned off.
- Measurement speed is restricted when statistical calculation is enabled.
- Turning on ΔT or setting the measurement terminal to multiplexer automatically turns off the statistical calculation function.

Deleting statistical calculation results

Stored data is automatically erased at the following times:

- when changing measurement conditions (low-power mode, measurement current, OVC, 100 M Ω range high-precision mode, TC, non-offset scaling settings)
- when changing comparator settings (p.99)
- when changing BIN measurement function settings (p.109)
- when printing the statistical calculations (p.257)
(you can select whether to delete results after printing (p.258))
- upon system reset (p.137)
- when turning off the instrument

Using statistical calculations

Turning on the statistical calculation function causes statistics to be calculated based on the EXT. I/O TRIG signal. The timing at which statistics are calculated for measured values varies with the trigger source setting.

- With external [EXT] triggering : If the TRIG signal is input, one measurement is performed and subjected to statistical calculation.
- With internal [INT] triggering : If the TRIG signal is input, statistics will be calculated using the last updated measured value.
When using the auto-hold function, statistics will be calculated using the held measured value.

Operation is the same in the following cases (except when using auto-hold):

- when pressing **ENTER**
- when a *TRG command is sent.

When the EXT. I/O PRINT signal is input, operation varies with the trigger source.

- When using an external trigger [EXT] : The most recent measurement results are printed.
- When using the internal trigger [INT] : Statistics are calculated using the last updated measured value and printed after the PRINT signal is input.
- The same operation can be accomplished by pressing **F4 [PRINT]** on the **MENU [P.1/3]** display.

1 Open the Settings screen.

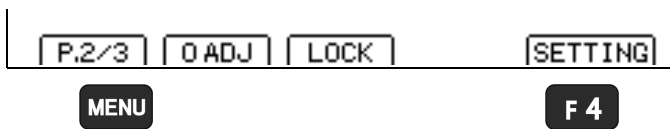

1 **MENU** Switch the function menu to P.2/3.

2 **F4** The Settings screen appears.

2 Open the System Setting screen.

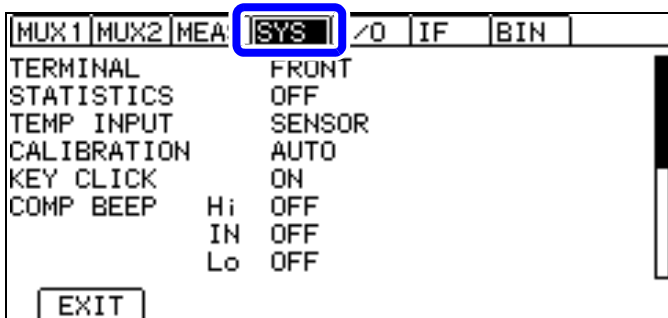

Move the cursor to the [SYS] tab with the left and right cursor keys.

3 Enable the statistical calculation function.

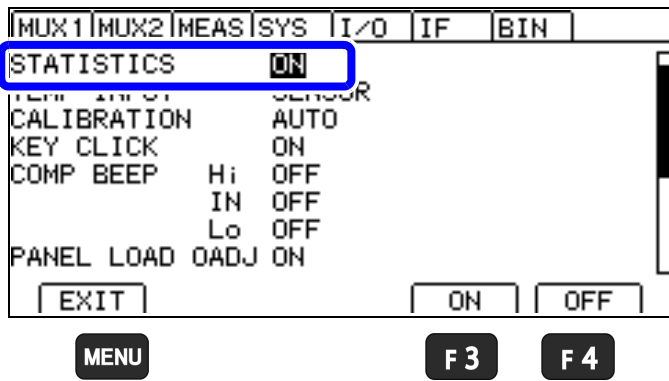

1 Selection

2
F3 Enable statistical calculation
F4 Disable statistical calculation (default)

MENU Return to the Measurement screen.

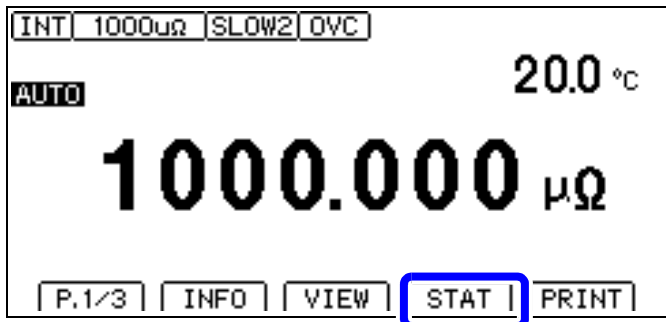

When statistical calculation is ON, **F3 [STAT]** will be displayed when the **MENU [P.1/3]** display is active.

See: Confirm calculation results (p.116)

4

Confirming, printing, and erasing calculation results

Statistical calculation results are displayed on the screen.

Additionally, results can be printed using an RS-232C printer. Once statistical calculation results have been printed, the data can be automatically deleted.

Before printing, select the **[PRINT]** interface setting.

See: “11 Printing (Using an RS-232C Printer)” (p.251)

The number of valid samples can be confirmed on the Calculation Results screen.

- When the number of valid samples is zero, no calculation results are displayed.
- When only one valid data sample exists, no standard deviation or process capability indices are displayed.

1 Open the Calculation Results screen.

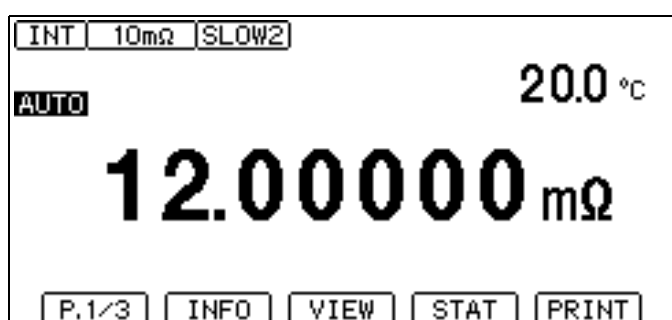

MENU

F3

1 MENU Switch the function menu to P.1/3.

2 F3 Displays the Calculation Results screen (if statistical calculation is on).

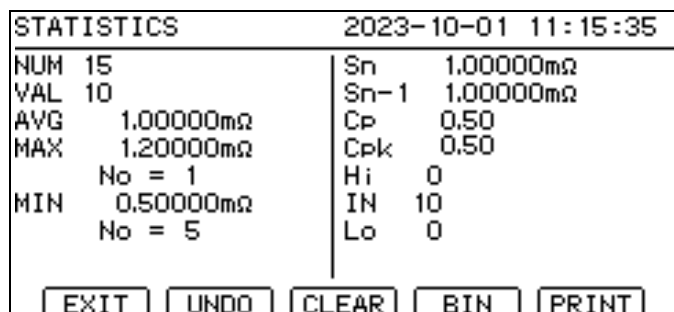

[NUM] Total data count

[VAL] Number of valid measured values (error-free data)

[AVG] Average

[MAX] Maximum value

[MIN] Minimum value

[Sn] Population standard deviation

[Sn-1] Standard deviation of sample

[Cp] Process capability index (dispersion)

[Cpk] Process capability index (bias)

(When the comparator function is on)

[Hi] Number of comparator Hi settings

[IN] Number of comparator IN settings

[Lo] Number of comparator Lo settings

(When the BIN function is on)

[BIN] BIN setting range and IN judgment count

Switching statistical/BIN results

F3

F3

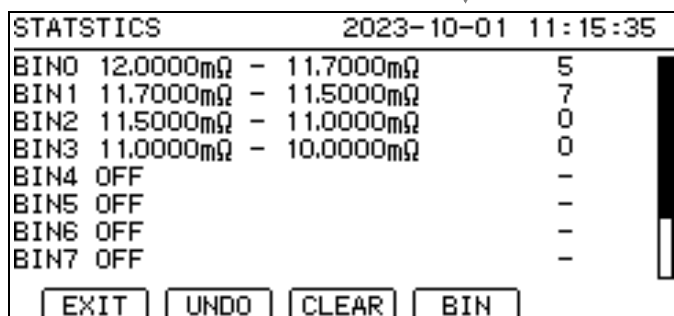

2 To print

For more information about printing, see “11 Printing (Using an RS-232C Printer)” (p.251).

STATISTICS	
NUM 15	Sn 1.00000mΩ
VAL 10	Sn-1 1.00000mΩ
AVG 1.00000mΩ	Cp 0.50
MAX 1.20000mΩ	Cpk 0.50
No = 1	Hi 0
MIN 0.50000mΩ	IN 10
No = 5	Lo 0
<div style="display: flex; justify-content: space-around; border-top: 1px solid black;"> EXIT UNDO CLEAR BIN PRINT </div>	

F 4

Output to the printer.

“Example Printouts” (p.259)

F 4

To erase

STATISTICS	
NUM 15	Sn 1.00000mΩ
VAL 10	Sn-1 1.00000mΩ
AVG 1.00000mΩ	Cp 0.50
MAX 1.20000mΩ	Cpk 0.50
No = 1	Hi 0
MIN 0.50000mΩ	IN 10
No = 5	Lo 0
<div style="display: flex; justify-content: space-around; border-top: 1px solid black;"> EXIT UNDO CLEAR BIN PRINT </div>	

F 1

Erases the last measurement and calculation result (executes only once).

F 2

Erases all measured values and statistical calculation results.

F 1

F 2

4

4.18 Performing Temperature Rise Test (Temperature Conversion Function $[\Delta T]$)

The temperature conversion principle is used to derive temperature increase over time. This functionality allows the temperature during normal stops and other data to be estimated.

See: “14.5 Temperature Conversion (ΔT) Function” (p.324)

To perform temperature conversion, connect the Z2001 Temperature Sensor to the TEMP. terminal on the rear of the instrument. Before connecting the sensor, read the following.

See: “Connecting the Z2001 Temperature Sensor” (p.34)

“Connecting an analog output thermometer” (p.37)

“3.1 Checking the Measurement Target” (p.46)

IMPORTANT
 When ΔT is set to ON, the comparator function cannot be turned ON.
 When TC, the BIN measurement function, or the statistical calculation function is set to on, ΔT is automatically set to off.

Example temperature rise test

- (1) After the motor and coil are stabilized at room temperature, measure the resistance (R_1) and instrument ambient temperature (t_1), and then input these values to the instrument. (p.119)
- (2) Disconnect the test lead from the measurement target.
- (3) After turning off the power, reconnect the test lead to the measurement target and then measure the temperature rise value (Δt_1 to Δt_n) at the preset intervals.
- (4) Draw a line by connecting the collected temperature data (Δt_1 to Δt_n), and estimate the maximum temperature rise value (Δt).

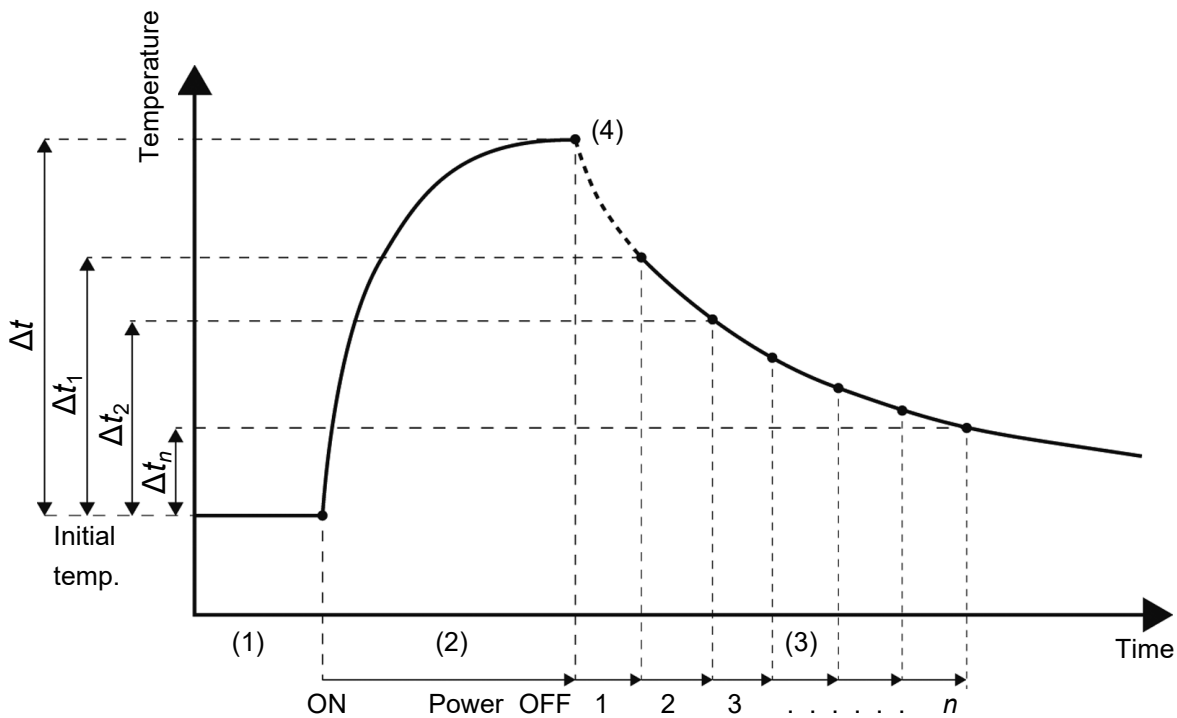

1 Open the Settings screen.



MENU

F 4

1 **MENU** Switch the function menu to P.2/3.

2 **F 4** The Settings screen appears.

2 Open the Measurement Setting screen.

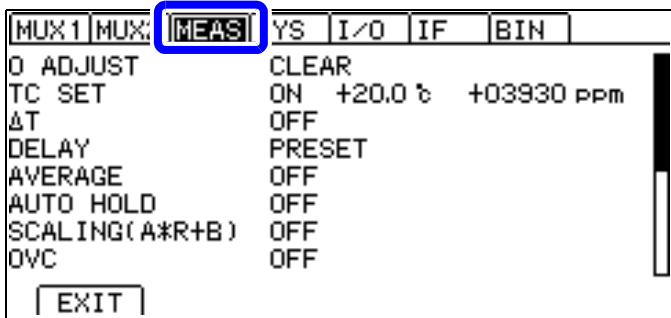

Move the cursor to the **[MEAS]** tab with the left and right cursor keys.

4

3 Enable the temperature conversion function. (ΔT)

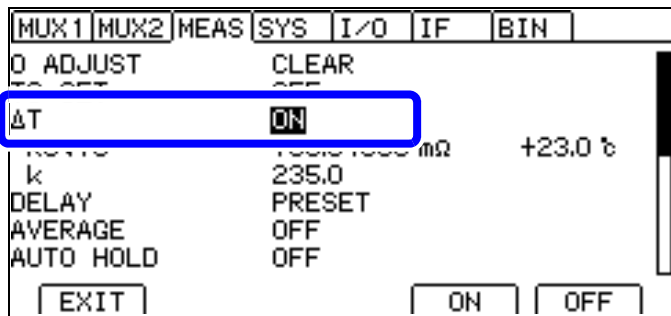

MENU

F 3

F 4

1 Selection

2
F 3 Enables the function
F 4 Disables the function (default)

MENU Return to the Measurement screen.

4 Set the initial resistance and initial temperature.

Set the initial resistance and initial temperature in Steps **1** through **3**.

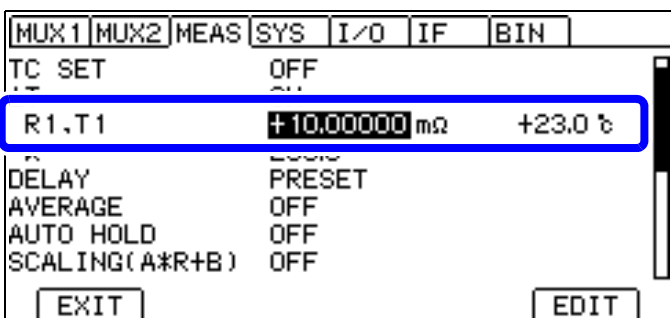

F 4

1 Move the cursor to the setting you wish to configure. Make the value editable with the **F 4** key.

2 Move among digits. Change values. Move the cursor to the digit you wish to set with the left and right cursor keys. Change the value with the up and down cursor keys.

3 **ENTER** Accept
 (**ESC**) Cancel

Setting range Initial resistance : 0.001 μΩ to 9000.000 MΩ (default: 1.0000 Ω)
 Initial temp. : -10.0 to 99.9°C (default: 23.0°C)

The initial resistance value range varies with the scaling setting.

5 Set the reciprocal (k) of the temperature coefficient at 0°C.

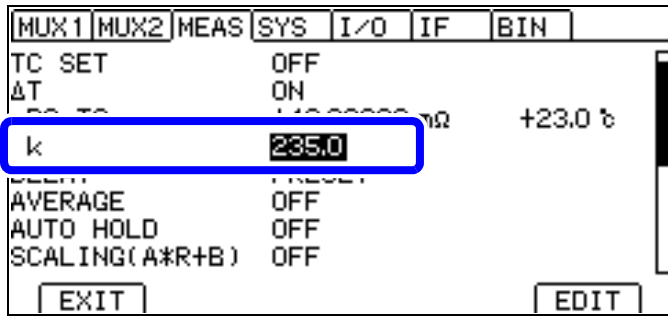

Setting range : -999.9 to 999.9 (default: 235.0)

1 Move the cursor to the setting you wish to configure. Make the value editable with the **F 4** key.

2 Move among digits. Change values. Move the cursor to the digit you wish to set with the left and right cursor keys. Change the value with the up and down cursor keys.

3 **ENTER** Accept
 (**ESC** Cancel)

MENU Return to the Measurement screen.

Guideline for k

IEC 60034 recommends the following:

- Copper: $k = 235$
- Aluminum: $k = 225$

See: "14.5 Temperature Conversion (ΔT) Function" (p.324)

5 Saving and Loading Panels

(Saving and Loading Measurement Conditions)

The panel save function allows you to save the current measurement conditions to the internal memory of the instrument.

- When the multiplexer is not being used: Max. 30 panels (Panels 1 to 30)
- When the multiplexer is being used: Max. 8 panels (Panels 31 to 38)

The settings of the saved panels are retained even if the instrument is turned off.

About the multiplexer settings, see “Multiplexer Settings” (p.154).

The saved measurement conditions can be loaded using the Panel Load function.

The panels can be loaded using the following methods.

- Key operation  Key
- Communications command `:SYSTem:PANel:LOAD <Table No>`
- EXT. I/O `LOAD0 to LOAD5`

Settings that can be saved with the Panel Save function

- Panel name
- Save time and date
- Resistance range
- 100 MΩ range high-precision mode
- Low-power mode (LP)
- Pure resistance mode (PR)
- Switching of measurement currents
- Measurement speed
- Zero adjustment (Loading of these values can be disabled.) (p.124)
- Averaging
- Delay
- Temperature Correction (TC)
- Offset voltage compensation (OVC)
- Scaling
- Self-calibration setting
- Contact improvement
- Contact check
- Comparator
- BIN settings
- Judgment beeper
- Auto hold
- Temperature conversion (ΔT)
- Statistical calculations settings
- Multiplexer settings (including channels)

5.1 Saving Measurement Conditions (Panel Save Function)

Panel Save function saves the current measurement conditions to the internal memory of the instrument. The multiplexer setting determines the panel numbers to be saved.

- When the multiplexer is not being used: Panel 1 to 30
- When the multiplexer is being used: Panel 31 to 38

1 Open the Panel List screen.

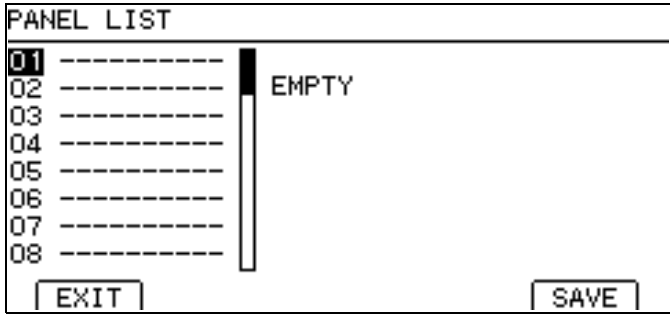

PANEL The Panel List screen appears.

2 Save the measurement conditions.

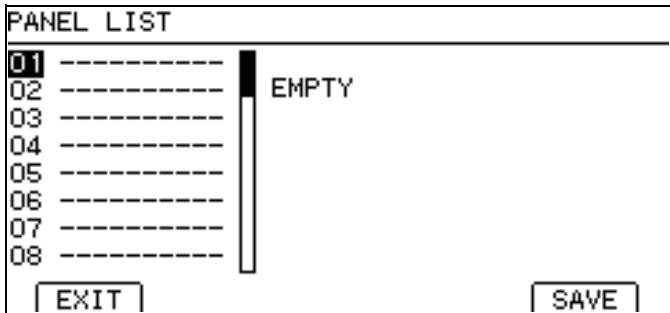

F 4

1 Selection

2 **F 4** Save the conditions.

3 Enter the panel name.

(If you enter the number of a previously saved panel, a warning message will be displayed.)

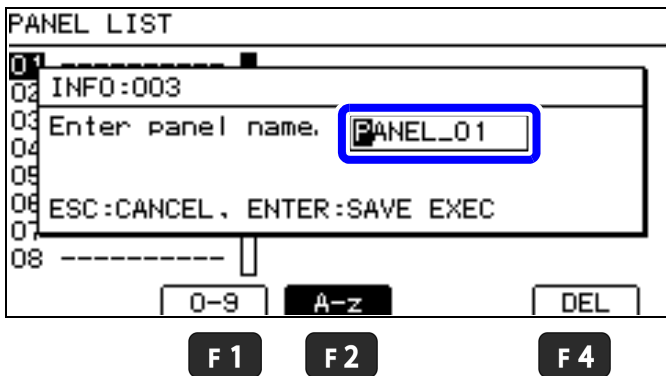

1 Move among characters Change characters

Move the cursor to the character you wish to set with the left and right cursor keys.

Change the character with the up and down cursor keys.

F 1 Enter a number from 0 to 9.

F 2 Enter a letter from A to z, or an underbar character (_).

F 4 Delete 1 character.

2 **ENTER** Accept

(**ESC** Cancel)

5.2 Loading Measurement Conditions (Panel Load Function)

Panel Load function loads the measurement conditions saved in the internal memory of the instrument.

The panel load operation can be performed with the key operation, communications commands, or EXT. I/O.

The zero adjustment values are also loaded with the panel load operation.

By changing the setting, you can perform the panel load operation without loading the zero adjustment values.

See: "Preventing loading of zero adjustment values" (p.124)

1 Open the Panel List screen.

PANEL LIST		2023-03-01 11:15:35	
01	PANEL_01	RANGE	1000 $\mu\Omega$
02	PANEL_02	SPEED	SLOW2 A-OVC ON
03	PANEL_03	AVG	2 SCALING OFF
04	-----	COMP	ON
05	-----	UPP	1200.00 $\mu\Omega$
06	-----	LOW	1000.00 $\mu\Omega$
07	-----	TC	20.0 $\%$ 3930ppm
08	-----	O ADJ	OFF
<div style="display: flex; justify-content: space-around;"> EXIT LOAD RENAME CLEAR SAVE </div>			

PANEL The Panel List screen appears.

2 Select a panel number.

PANEL LIST		2023-03-01 11:15:35	
01	PANEL_01	RANGE	1000 $\mu\Omega$
02	PANEL_02	SPEED	SLOW2 A-OVC ON
03	PANEL_03	AVG	2 SCALING OFF
04	-----	COMP	ON
05	-----	UPP	1200.00 $\mu\Omega$
06	-----	LOW	1000.00 $\mu\Omega$
07	-----	TC	20.0 $\%$ 3930ppm
08	-----	O ADJ	OFF
<div style="display: flex; justify-content: space-around;"> EXIT LOAD RENAME CLEAR SAVE </div>			

Data saved for selected panel

1   Selection

2 **F1** Load the panel.
(You can also load the panel with the **ENTER** key.)

F1

5

3 A confirmation message will be displayed. Confirm and return to the Measurement screen.

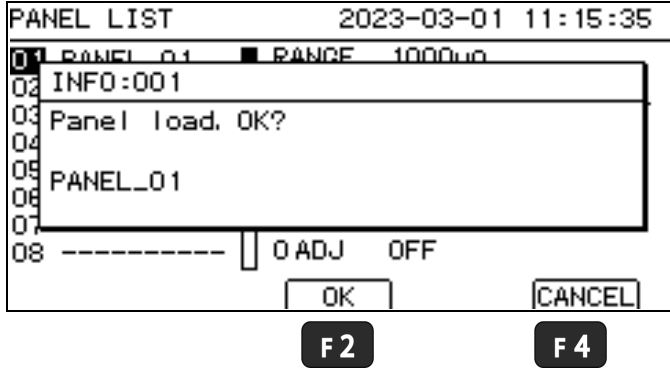

F2 Load the panel and switch to the Measurement screen (you can also do this with the **ENTER** key).

F4 Cancel the operation and return to the previous screen. (you can also do this with the **ESC** key)

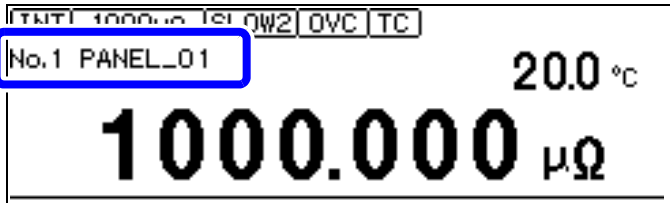

The name of the loaded panel will be displayed on the Measurement screen.

IMPORTANT

- Panels can also be loaded with the EXT. I/O LOAD0 to LOAD5 control and communications commands.
See: "9 External Control (EXT. I/O)"; "Input signals" (p.190)
For more information about communications commands, see the Communications Command Instruction Manual. The Instruction Manual can be downloaded from Hioki's website.
<https://www.hioki.com/global/support/download/>
- If measurement conditions are changed after being loaded, the panel name will no longer be displayed.

Preventing loading of zero adjustment values

By default, zero adjustment values are also loaded along with panel data. The following procedure can be used to prevent loading of zero adjustment values.

1 Open the Settings screen.

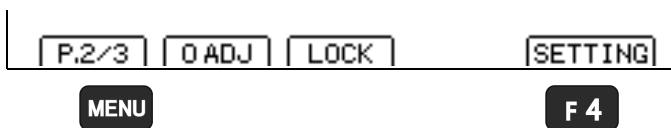

1 **MENU** Switch the function menu to P.2/3.

2 **F4** The Settings screen appears.

2 Open the System Setting screen.

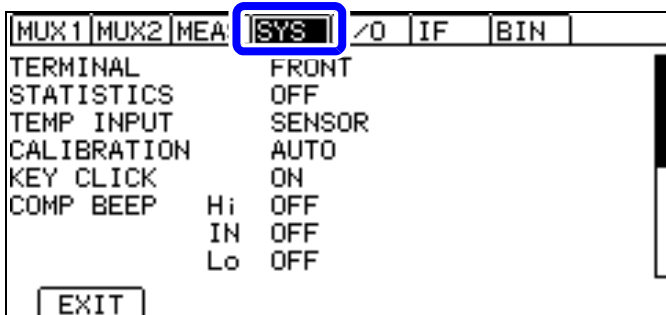

Move the cursor to the **[SYS]** tab with the left and right cursor keys.

3 Select whether to load zero adjustment values.

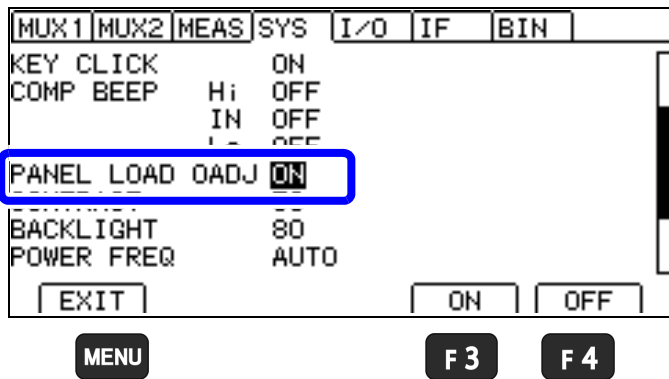

1 Selection

2
F3 When a panel is loaded, change zero adjustment values to the values in effect when the panel was saved. (default)

F4 Do not change zero adjustment values, even when panel data is loaded.

MENU Return to the Measurement screen.

5

5.3 Changing Panel Names

- 1 Open the Panel List screen.

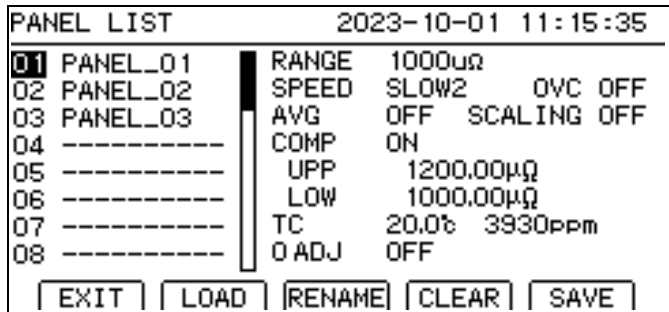

PANEL The Panel List screen appears.

- 2 Select a panel number.

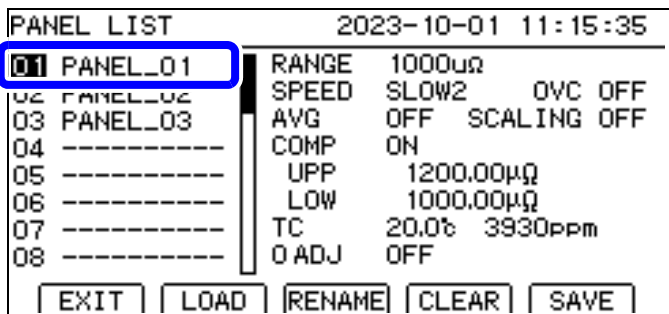

1 Selection

2 **F2** Edit the panel name.

F2

- 3 Edit the panel name.

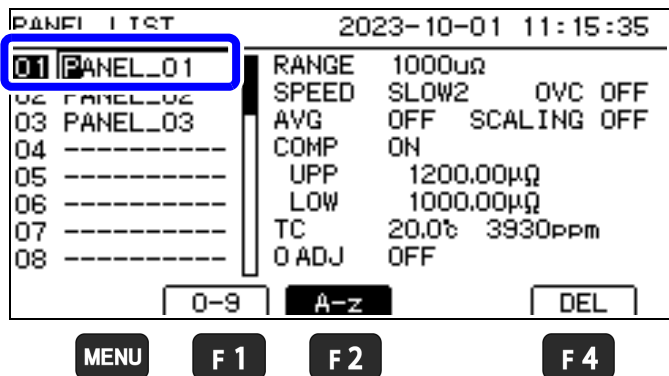

1 Move among characters
Change characters
Move the cursor to the character you wish to set with the left and right cursor keys.

Change the character with the up and down cursor keys.

F1 Enter a number from 0 to 9.

F2 Enter a letter from A to z, or an underbar character (_).

F4 Delete 1 character.

2 **ENTER** Accept

(**ESC**) Cancel

MENU Return to the Measurement screen.

5.4 Deleting Panel Data

- 1 Open the Panel List screen.

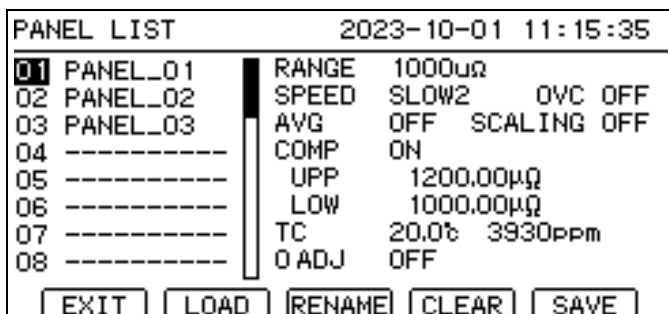

PANEL The Panel List screen appears.

- 2 Select a panel number.

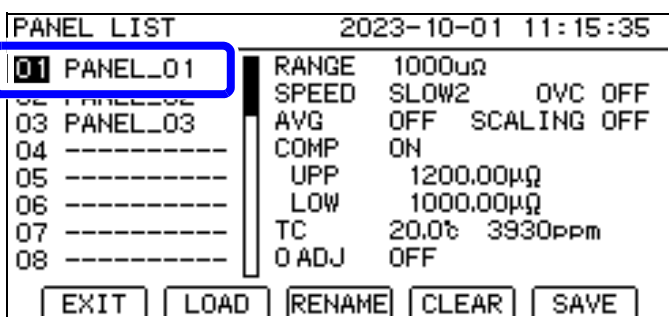

F3

1 Selection

2 **F3** Delete the panel.

- 3 A confirmation message will be displayed. Confirm and return to the Measurement screen.

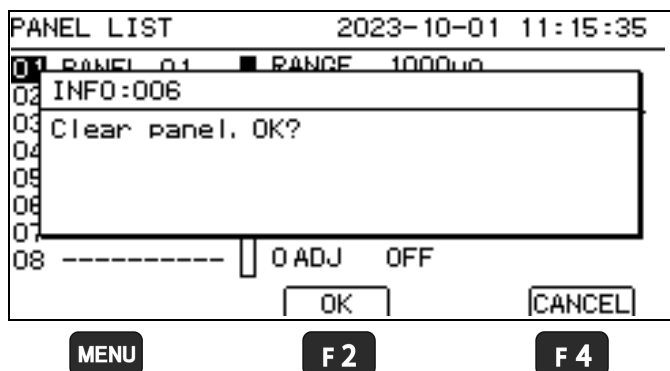

F2 Delete the panel and switch to the previous screen (can also be performed with **ENTER**)

F4 Cancel the operation and return to the previous screen. (you can also do this with the **ESC** key)

MENU Return to the Measurement screen.

IMPORTANT

Once a panel's data is deleted, it cannot be restored (the delete operation cannot be undone).

6 System Settings

This chapter describes system settings.

“6.1 Disabling and Enabling Key Operations” (p.130)

“6.2 Enabling or Disabling the Key Beeper” (p.132)

“6.3 Power Line Frequency Manual Setting” (p.133)

“6.4 Adjusting Screen Contrast” (p.134)

“6.5 Adjusting the Backlight” (p.135)

“6.6 Setting the Clock” (p.136)

“6.7 Initializing (Reset)” (p.137)

6.1 Disabling and Enabling Key Operations

Disabling key operations (key-lock function)

Activate the key-lock function to disable the instrument's front panel key operations.

Three key-lock levels are available to suit specific purposes.

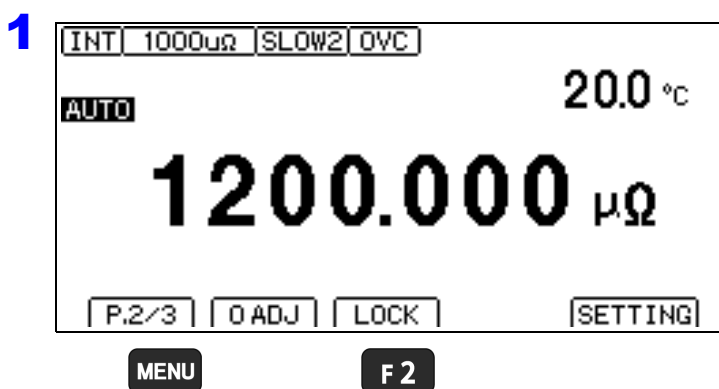
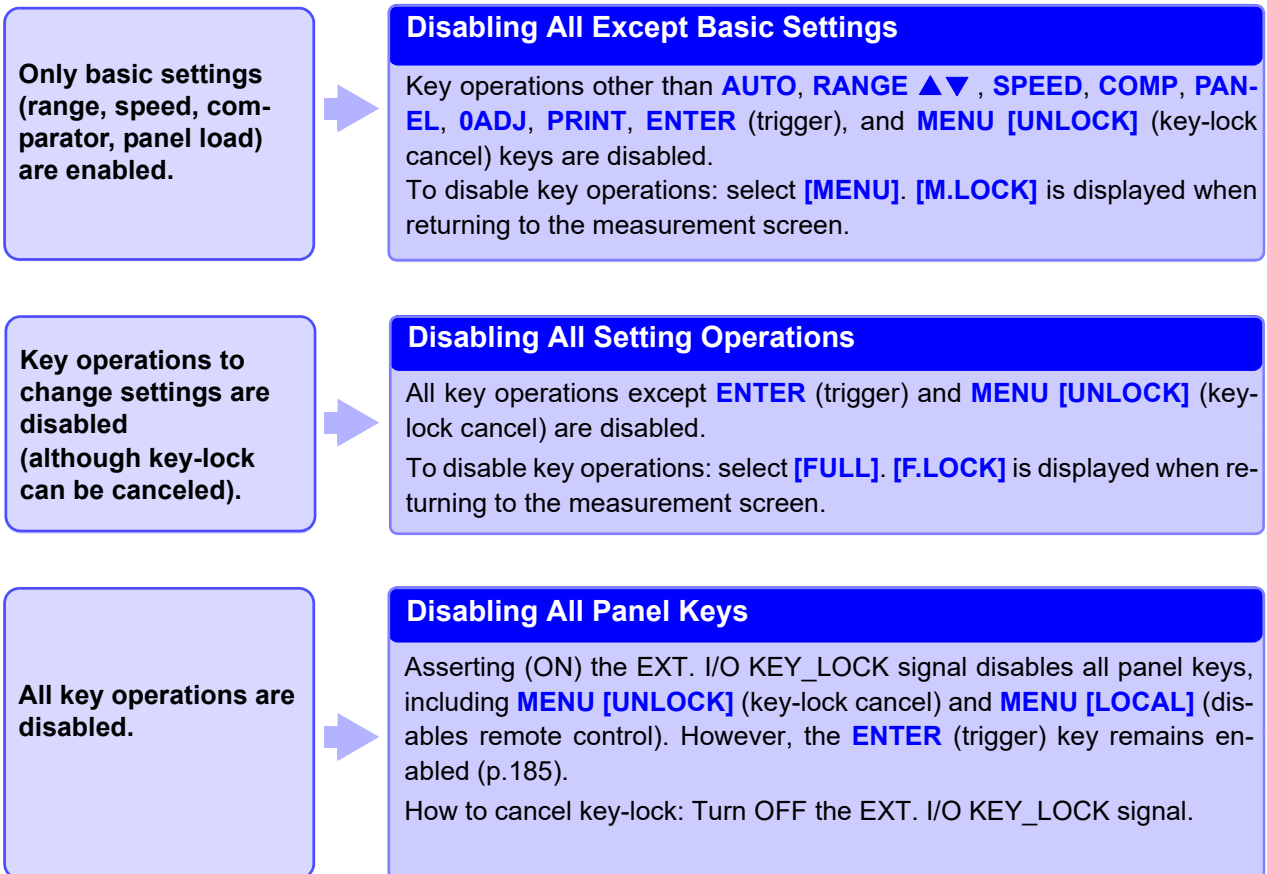

- 1** **MENU** Switch the function menu to P.2/3.
- 2** **F2** Display the Key Lock Selection screen.

2 Enable or disable key operations.

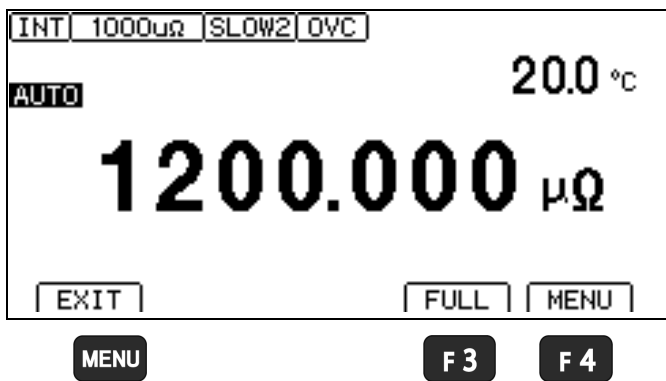

F3 Disable all except key-lock cancel and return to the Measurement screen.

F4 Disable all except key-lock cancel and basic settings change and return to the Measurement screen.

MENU Return to the Measurement screen.

[UNLOCK] is displayed.

(Key-lock operation triggered by the EXT. I/O KEY_LOCK signal is not displayed.)

Re-enabling key operations (key-lock cancel)

Key-lock can be canceled only when [UNLOCK] is displayed.

Press and hold **MENU** [UNLOCK] for one second.

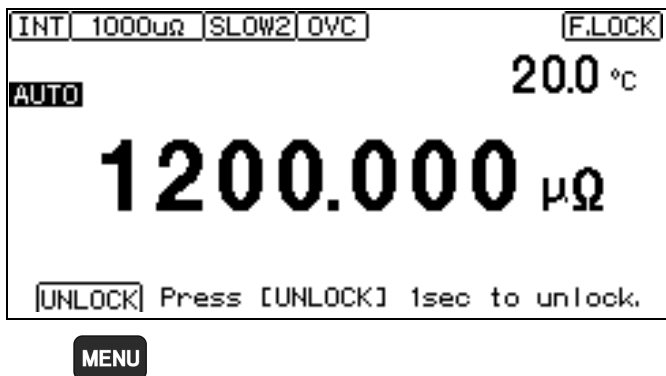

6

IMPORTANT

When the EXT. I/O KEY_LOCK signal is ON, the key-lock cannot be canceled with the key operation of the instrument. Turn OFF the KEY_LOCK signal.

See: "KEY_LOCK" (p.190) in "Signal descriptions".

6.2 Enabling or Disabling the Key Beeper

The key beeper sound can be enabled and disabled.

The key beeper is enabled (on) by default.

1 Open the Settings screen.

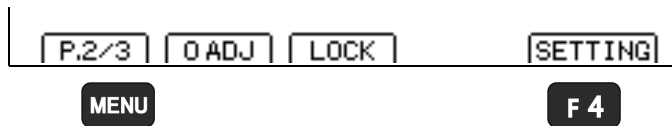

1 **MENU** Switch the function menu to P.2/3.

2 **F4** The Settings screen appears.

2 Open the System Setting screen.

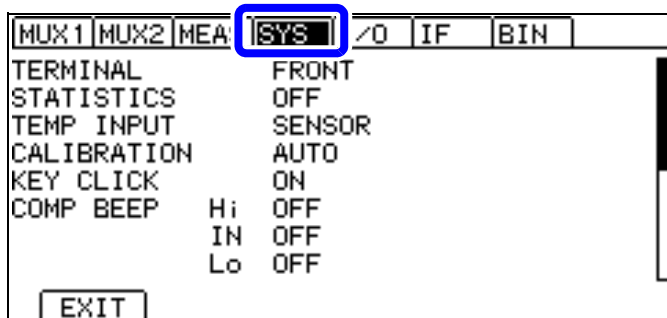

Move the cursor to the **[SYS]** tab with the left and right cursor keys.

3 Select whether to enable or disable the key beeper.

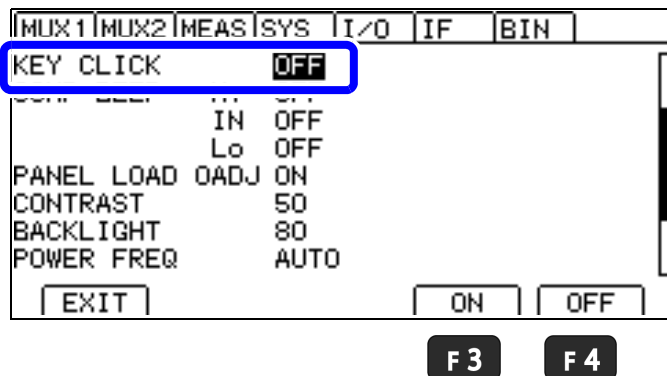

1  Selection

2 **F3** Enables the beeper (default)

F4 Disables the beeper

MENU Return to the Measurement screen.

To disable the key beeper, error beep, and auto-hold beep, turn off the instrument and then turn it back on while holding down the **F1** and **ENTER** keys. **[(ERR, AUTO HOLD)]** will be displayed as the **[KEY CLICK]** setting, and the error beep and auto-hold beep will be set to the same setting as the key beeper.

6.3 Power Line Frequency Manual Setting

With the default setting (AUTO), the instrument attempts to automatically detect the line frequency, but manual setting is also available.

IMPORTANT

- Unless the line frequency is set correctly, measured values may be unstable. An error message appears if line noise is high enough to prevent correct frequency detection. (ERR: 097 (p.312)) In that case, set the instrument's line frequency manually.
- When the automatic setting ([AUTO]) is selected, the line frequency is automatically set to 50 Hz or 60 Hz when the instrument is turned on or reset. However, automatic detection is not available when the line frequency changes after turning power on or resetting. If the actual line frequency deviates from 50 Hz or 60 Hz, select the closest frequency. Example: If the actual line frequency is 50.8 Hz, select the 50 Hz setting. If the actual line frequency is 59.3 Hz, select the 60 Hz setting.

1 Open the Settings screen.

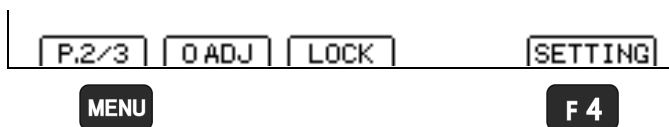

1 **MENU** Switch the function menu to P.2/3.

2 **F 4** The Settings screen appears.

2 Open the System Setting screen.

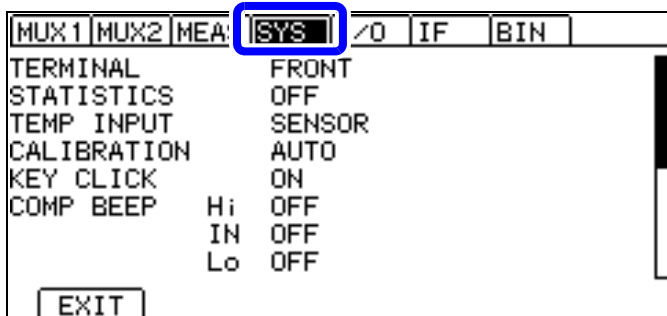

Move the cursor to the **[SYS]** tab with the left and right cursor keys.

3 Select the line frequency being used.

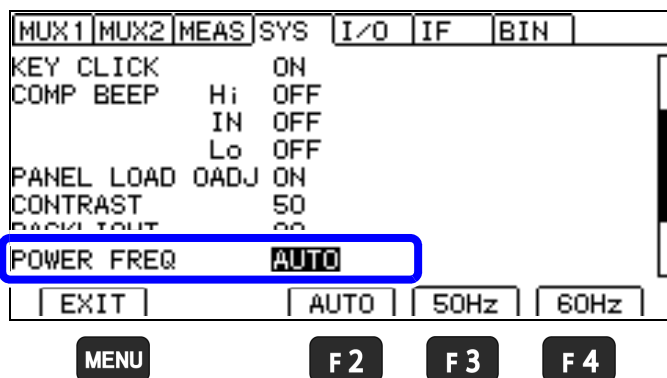

1 Selection

2 **F 2** Automatically detect local line frequency (default)

F 3 When the line frequency is 50 Hz

F 4 When the line frequency is 60 Hz

MENU Return to the Measurement screen.

6.4 Adjusting Screen Contrast

The screen may become hard to see when ambient temperature changes. In this case, adjust the contrast.

1 Open the Settings screen.

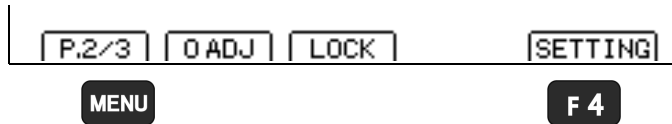

1 **MENU** Switch the function menu to P.2/3.

2 **F 4** The Settings screen appears.

2 Open the System Setting screen.

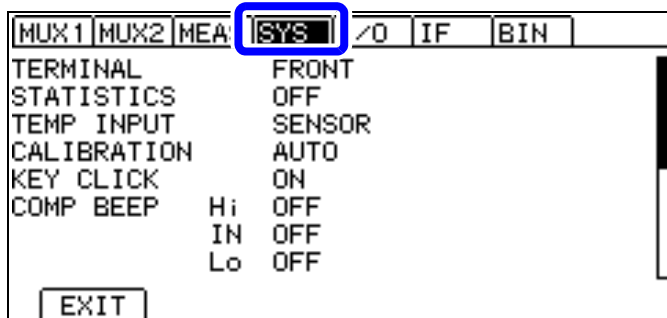

Move the cursor to the **[SYS]** tab with the left and right cursor keys.

3 Adjust the contrast.

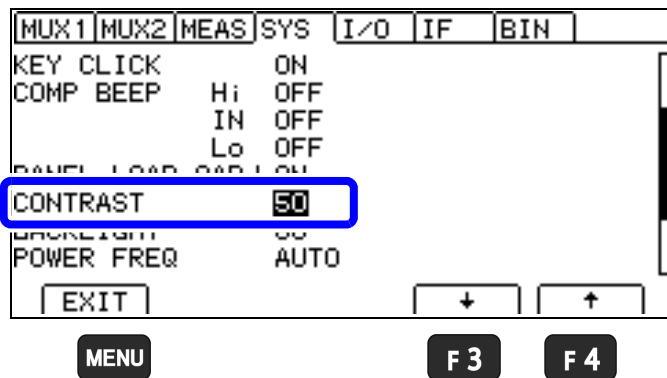

1  Selection

2 **F 3** Decrease the contrast.

F 4 Increase the contrast.

Setting range: 0 to 100%, 5% step
(Default setting: 50%)

MENU Return to the Measurement screen.

6.5 Adjusting the Backlight

Adjust backlight brightness to suit ambient illumination.

IMPORTANT

- When the [TRG: EXT] external triggering is selected, backlight brightness is automatically reduced after non-operation for one minute.
To keep the backlight brightness constant, turn off the instrument and then turn it back on again while holding down the **F1** and **ENTER** keys.
- The display may be hard to see when brightness is set too low (near 0%).

1 Open the Settings screen.

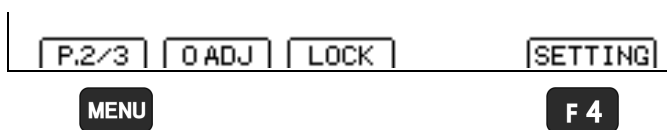

1 **MENU** Switch the function menu to P.2/3.

2 **F 4** The Settings screen appears.

2 Open the System Setting screen.

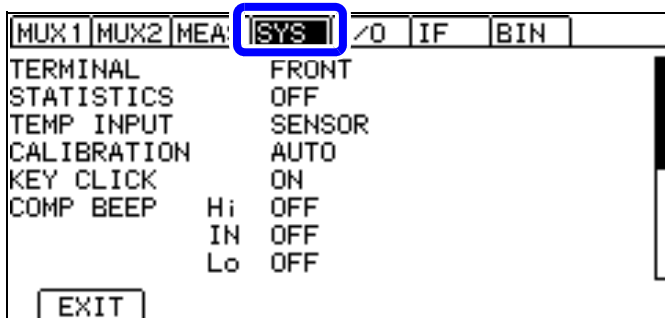

Move the cursor to the **[SYS]** tab with the left and right cursor keys.

3 Adjust the backlight.

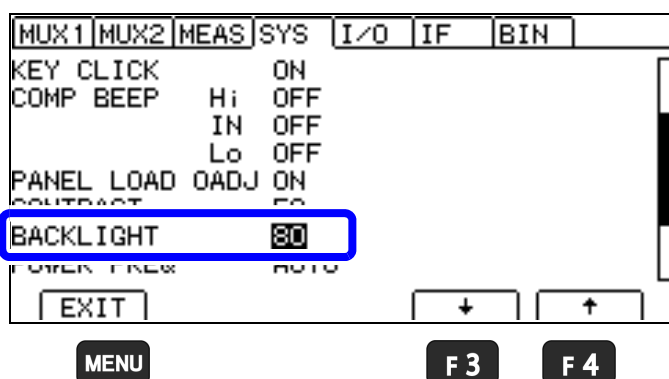

1 Selection

2 **F 3** Decrease the backlight brightness.

F 4 Increase the backlight brightness.

Setting range: 0 to 100%, 5% step
(Default setting: 80%)

MENU Return to the Measurement screen.

6.6 Setting the Clock

To record and print the correct time when using statistical calculations (p.112), the clock needs to be set correctly.

The time of printing is also output when printing statistical calculation results.

1 Open the Settings screen.

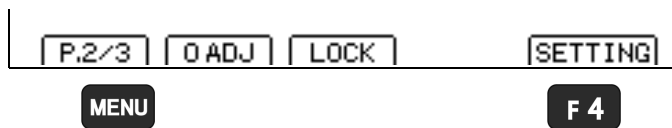

1 **MENU** Switch the function menu to P.2/3.

2 **F4** The Settings screen appears.

2 Open the System Setting screen.

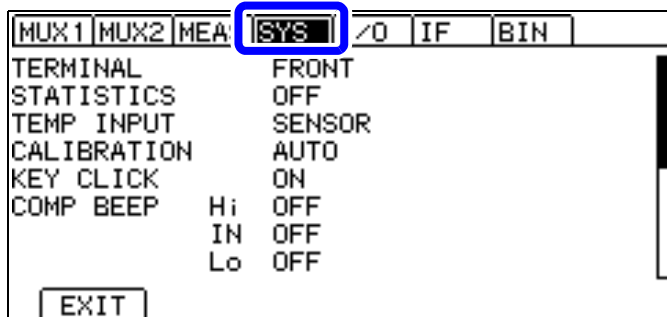

Move the cursor to the **[SYS]** tab with the left and right cursor keys.

3 Set the date and time.

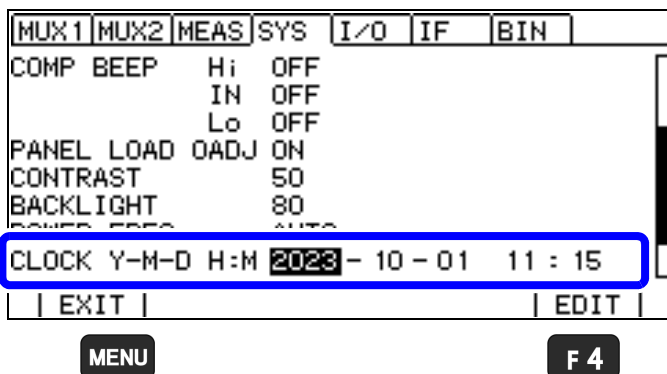

1 Move the cursor to the setting you wish to configure. Make the value editable with the **F4** key.

2 Move among digits. Change values.

Move the cursor to the digit you wish to set with the left and right cursor keys. Change the value with the up and down cursor keys.

3 **ENTER** Accept

(**ESC** Cancel)

Enter the last two digits of the year, and the month, day, hour and minutes in that order.

MENU Return to the Measurement screen.

6.7 Initializing (Reset)

Three reset functions are available.

For more information about communications commands, see the Communications Command Instruction Manual. The Instruction Manual can be downloaded from Hioki's website.

<https://www.hioki.com/global/support/download/>

1. Reset: Returns measurement conditions (except the panel data) to factory defaults.

The instrument can be reset by three methods.

- Reset from the System setting screen.
- Turn on the instrument while holding down **ESC** and **ENTER**.
- Reset by remote control command.
 - ***RST** command (Interface settings are not initialized.)

2. System reset: Returns all measurement conditions and the panel save data to factory defaults.

The instrument can be system reset by three methods.

- System reset from the System setting screen
- Turn on the instrument while holding down **ESC**, **ENTER**, and **▶**.
- Reset by remote control command
 - :**SYSTem:RESet** command (Interface settings are not initialized.)

3. Multiplexer channel reset: Initializes the multiplexer channel settings to the factory defaults.

The instrument's multiplexer channels can be reset by two methods.

- System reset from the System setting screen
- Reset by remote control command
 - [**:SENSe:**] **CHReset** command

This procedure describes reset from the System setting screen.

1 Open the Settings screen.

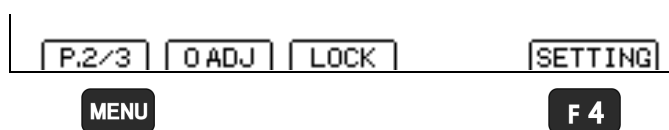

- 1 **MENU** Switch the function menu to P.2/3.

- 2 **F4** The Settings screen appears.

2 Open the System Setting screen.

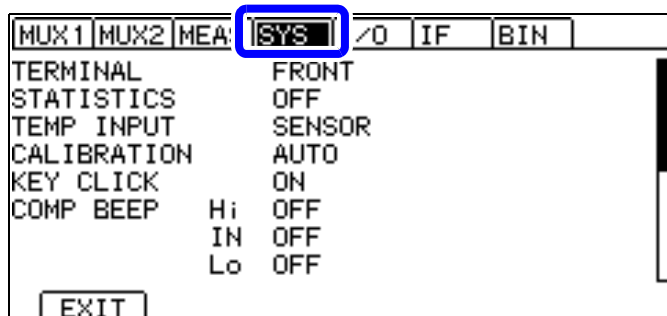

Move the cursor to the **[SYS]** tab with the left and right cursor keys.

3 Select RESET.

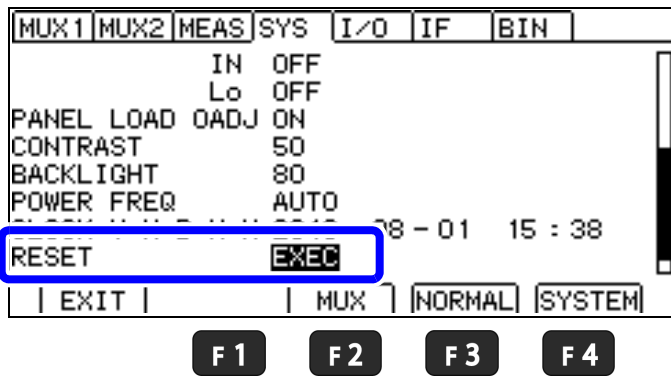

- 1** Selection
- 2** **F2** Perform a multiplexer channel reset.
- F3** Perform a reset.
- F4** Perform a system reset.

The confirmation message is displayed.

4 Select whether to initialize the instrument.

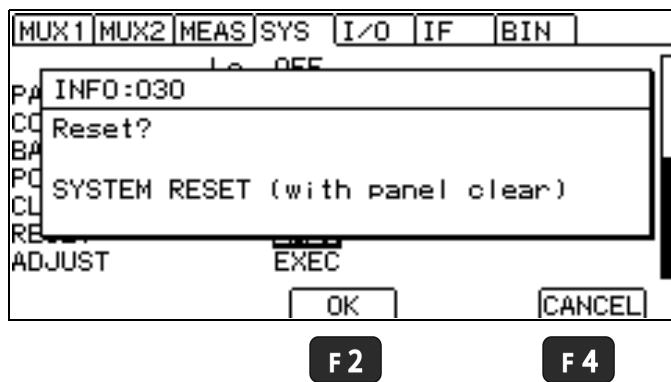

- F2** Execute
- F4** Cancel the operation

The Measurement screen is displayed when system reset finishes.

Default settings

RM3545A-1

Reset: ✓, Do not reset: –

Screen		Setting and key	Default settings	Multiplexer channel reset	See	
Measurement screen		COMP	OFF	✓	p.101	
		AUTO	AUTO	✓	p.48	
		▲▼ (RANGE)		✓		
		SPEED	SLOW2	✓	p.50	
Measurement screen (P.1/2)		VIEW (F2)	OFF	–	p.53	
Measurement screen (P.2/2)		0 ADJ (F2)	OFF	✓	p.69	
		LOCK (F3)	OFF	–	p.130	
Setting screen (SETTING)	Measurement Setting screen (MEAS)	TC SET	OFF	✓	p.76	
		ΔT	OFF	✓	p.118	
		DELAY	PRESET	✓	p.86	
		AVERAGE	OFF	✓	p.74	
		AUTO HOLD	OFF	–	p.61	
		SCALING(A*R+B)	OFF	✓	p.78	
		OVC	OFF	✓	p.83	
		LOW POWER	OFF	✓	p.65	
		PURE RESISTANCE	OFF	✓	p.85	
		MEAS CURRENT	HIGH	✓	p.67	
		Ω DIGITS	7DGT	–	p.82	
		CURR ERROR MODE	CurErr	–	p.60	
		CONTACT CHECK	ON	✓	p.90	
		CONTACT IMPRV	OFF	✓	p.92	
	100MΩ PRECISION	OFF	✓	p.98		
	System Setting screen (SYS)	STATISTICS	OFF	–	p.114	
		TEMP INPUT	SENSOR	–	p.34	
		CALIBRATION	AUTO	–	p.94	
		KEY CLICK	ON	–	p.132	
		COMP BEEP	Hi	OFF	–	p.106
			IN	OFF	–	
			Lo	OFF	–	
			PASS	OFF	–	
			FAIL	OFF	–	
			PANEL LOAD 0ADJ	ON	–	p.124
			CONTRAST	50	–	p.134
			BACK LIGHT	80	–	p.135
		POWER FREQ	AUTO	–	p.133	

Reset: ✓, Do not reset: –

Screen		Setting and key	Default settings	Multiplexer channel reset	See
Setting screen (SETTING)	EXT. I/O Setting screen (I/O)	TRIG SOURCE	INT	–	p.217
		TRIG EDGE	OFF→ON (ON edge)	–	p.219
		TRIG/PRINT FILT	OFF	–	p.221
		EOM MODE	HOLD	–	p.223
		JUDGE/BCD MODE	JUDGE	–	p.225
		OVRNRNG ERR OUT	OFF	–	p.226
	Communications Interface Setting screen (IF)	INTERFACE	RS232C	–	p.232
		SPEED	9600bps	–	p.235
		DATA OUT	OFF	–	p.248
		CMD MONITOR	OFF	–	p.245
	BIN Setting screen (BIN)	BIN	OFF	–	p.109

RM3545A-2

Reset: ✓, Do not reset: –

Screen		Setting and key	Default settings	Multiplexer channel reset	See
Measurement screen		COMP	OFF	✓	p.101
		AUTO	AUTO	✓	p.48
		▲▼ (RANGE)		✓	
		SPEED	SLOW2	✓	p.50
Measurement screen (P.1/3)		VIEW (F2)	OFF	–	p.53
Measurement screen (P.2/3)		0 ADJ (F2)	OFF	✓	p.69
		LOCK (F3)	OFF	–	p.130
Measurement screen (P.3/3)		FRONT (F1)	FRONT	–	p.157
		MUX (F2)		–	
		SCANSET (F3)	OFF	–	
Setting screen (SETTING)	Multiplexer Channel Settings screen (MUX1)	CH	OFF	✓	p.159
		TERM		✓	
		INST	Product model	✓	
		0ALL	ON	✓	p.169
		0ADJ	–	✓	
	Multiplexer Basic Measurement screen (MUX2)	SPD	SLOW2	✓	p.163
		RANGE	AUTO	✓	
		UPP/REF	OFF	✓	
		LOW%	OFF	✓	
		PASS	IN	✓	
	Measurement Setting screen (MEAS)* ¹	TC SET	OFF	✓	p.76
		ΔT	OFF	✓	p.118
		DELAY	PRESET	✓	p.86
		AVERAGE	OFF	✓	p.74
		AUTO HOLD	OFF	–	p.61
		SCALING(A*R+B)	OFF	✓	p.78
		OVC	OFF	✓	p.83
		LOW POWER	OFF	✓	p.65
		PURE RESISTANCE	OFF	✓	p.85
		MEAS CURRENT	HIGH	✓	p.67
Ω DIGITS		7DGT	–	p.82	
CURR ERROR MODE		CurErr	–	p.60	
CONTACT CHECK		ON	✓	p.90	
CONTACT IMPRV		OFF	✓	p.92	
100MΩ PRECISION		OFF	✓	p.98	

Reset: ✓, Do not reset: –

Screen		Setting and key	Default settings	Multiplexer channel reset	See	
Setting screen (SETTING)	System Setting screen (SYS)	TERMINAL	FRONT	–	p.154	
		STATISTICS	OFF	–	p.114	
		TEMP INPUT	SENSOR	–	p.34	
		CALIBRATION	AUTO	–	p.94	
		KEY CLICK	ON	–	p.132	
		COMP BEEP	Hi	OFF	–	p.106
			IN	OFF	–	
			Lo	OFF	–	
			PASS	OFF	–	
			FAIL	OFF	–	
		PANEL LOAD 0ADJ	ON	–	p.124	
		CONTRAST	50	–	p.134	
		BACK LIGHT	80	–	p.135	
		POWER FREQ	AUTO	–	p.133	
	EXT. I/O Setting screen (I/O)	TRIG SOURCE	INT	–	p.217	
		TRIG EDGE	OFF→ON (ON edge)	–	p.219	
		TRIG/PRINT FILT	OFF	–	p.221	
		EOM MODE	HOLD	–	p.223	
		JUDGE/BCD MODE	JUDGE	–	p.225	
		OVERRNG ERR OUT	OFF	–	p.226	
	Communications Interface Setting screen (IF)	INTERFACE	RS232C	–	p.232	
		SPEED	9600bps	–	p.235	
		DATA OUT	OFF	–	p.248	
CMD MONITOR		OFF	–	p.245		
BIN Setting screen (BIN)	BIN	OFF	–	p.109		

*1. When using the multiplexer, the selected channel number will be displayed next to “MEAS”.

Channel default values for the multiplexer

4-wire

CH		UNIT	TERM A	TERM B
1	Enabled	1	TERM A1	TERM B1
2	Disabled	1	TERM A2	TERM B2
:	:	:	:	:
10	Disabled	1	TERM A10	TERM B10
11	Disabled	2	TERM A1	TERM B1
12	Disabled	2	TERM A2	TERM B2
:	:	:	:	:
20	Disabled	2	TERM A10	TERM B10
21	Disabled	1	TERM A1	TERM B1
22	Disabled	1	TERM A1	TERM B1
:	:	:	:	:
42	Disabled	1	TERM A1	TERM B1

2-wire

CH		UNIT	TERM A	TERM B
1	Enabled	1	TERM A1	TERM B1
2	Disabled	1	TERM A2	TERM B2
:	:	:	:	:
21	Disabled	1	TERM A21	TERM B21
22	Disabled	2	TERM A1	TERM B1
23	Disabled	2	TERM A2	TERM B2
:	:	:	:	:
42	Disabled	2	TERM A21	TERM B21

7 Multiplexer RM3545A-2

By using the RM3545A-2 in combination with the Z3003 Multiplexer Unit, it is possible to conduct measurements by switching among up to 20 locations (4-wire) or up to 42 locations (2-wire).

When installing the multiplexer unit, be sure to read “2.5 Installing the Multiplexer Unit” (p.41).

IMPORTANT

- The Z3003 Multiplexer Unit’s contacts use mechanical relays. Since mechanical relays have a finite service life, programs should be created so as to minimize the switching of contacts.

Particularly when set to 2-wire, the frequency of contact switching when switching from TERM An (TERM Bn) to Am (TERM Bm) can be minimized by switching such that n and m are both odd numbers or both even numbers, rather than switching such that n is odd and m is even, or vice versa (4-wire/2-wire relay switching can be reduced).

See: “7.2 Internal Circuitry” (p.152)

Example 1: TERM A1/B1 → TERM A2/B2 → TERM A3/B3 → TERM A4/B4

Example 2: TERM A1/B1 → TERM A3/B3 → TERM A2/B2 → TERM A4/B4

Example 2 requires less contact switching than Example 1.

Contact service life reference value

4-wire: 50 million cycles. 2-wire: 5 million cycles.

- The unit test function performs short and open tests by shorting the measurement terminals. Short test measures each pin’s round-trip route resistance in the 2-terminal resistance measurement state and generates a PASS result if the value is 1 Ω or less. When using a measurement current of 1 A, it may not be possible to conduct measurement due to an inability to achieve the 1 A measurement current, even if the unit test yields a PASS result. If you encounter a current fault ([-----] or [OvrRng] display), reduce the route resistance. (p.58)

7.1 About the Multiplexer

Up to two units of the Z3003 Multiplexer Unit can be installed on the RM3545A-2.

Number of locations that can be measured

Number of units	2-wire	4-wire
1 unit	21 locations	10 locations
2 units	42 locations	20 locations

Benefits of using the multiplexer unit

- Wirings connecting with a variety of measurement targets can be simplified because the A and B terminals of each channel can be individually assigned with user-specified terminals.
See: "7.7 Example Connections and Settings" (p.174)
Example: 3-phase motor with Δ wiring or Y wiring
Series elements such as a network resistor
Independent elements
- Different measurement conditions can be set for each channel.
See: "7.3 Multiplexer Settings" (p.154)
- Batch zero adjustment can be performed for the desired channels.
See: "7.5 Zero adjustment (When a Multiplexer Unit Has Been Installed)" (p.169)
- Judgments can be made using measured values as references.
See: "Setting basic measurement conditions and total judgment conditions for individual channels" (p.162)
- Up to 42 channels can be registered.
- Up to eight setting panels (panel number: 31 to 38) can be saved, apart from measurement conditions for which the multiplexer is not used (when using the measurement terminals on the front of the instrument).
- You can choose from the following three scan methods. Choose the setting that best suits your application.
 - (1) Scan function: Off
 - (2) Scan function: Step
 - (3) Scan function: Auto

Scan function	OFF	Step	Auto
Overview	<p>The measurement location can be changed freely.</p> <p>Example uses</p> <ul style="list-style-type: none"> Using the multiplexer manually Repeating measurement for particular channels only Switching channels using external control 	<p>The measurement location is switched according to a previously set order.</p> <p>A single TRIG signal causes one channel to be measured.</p> <p>Example uses</p> <ul style="list-style-type: none"> Controlling the measurement target during testing, for example with switches Changing operation based on each channel's measurement results 	<p>The measurement location is switched according to a previously set order.</p> <p>A single TRIG signal causes all channels to be measured.</p> <p>Example uses</p> <ul style="list-style-type: none"> Performing scanning at the fastest possible speed when controlling the measurement target during testing is not necessary, for example for 3-phase motor windings or network resistors
Measurement screen			
Trigger source	Internal [INT] / External [EXT]	External [EXT] only	External [EXT] only
Channel switching	Up/down cursor operation, commands, LOAD signal	Automatic switching based on the trigger (channel by channel)	Automatic switching based on the trigger (all channels)
TRIG operation			
Acquisition of each channel's measured value and judgment results	Display, Communications commands, EXT. I/O	Display, Communications commands, EXT. I/O	Display, Communications commands
Total judgment	No	Yes	Yes



Process up to multiplexer use

Advance preparations

- 1** **Connect the measurement cables to the multiplexer's connector.**
See: "Connector type and pinouts" (p.149)
- 2** **Enable the multiplexer and set the scan function.**
See: "Configuring multiplexer settings" (p.154)
- 3** **Set channel pin allocation.**
See: "Customizing channel pin allocation" (p.158)
- 4** **Set the measurement conditions for each channel.**
See: "Customizing measurement conditions for individual channels" (p.166)



Zero adjustment

- 5** **Set zero adjustment.**
See: "7.5 Zero adjustment (When a Multiplexer Unit Has Been Installed)" (p.169)
- 6** **Connect each channel to 0 Ω.**
- 7** **Zero adjustment will be performed.**



Measurement

- 8** **Connect and measure the measurement target.**
See: "7.4 Measuring with the Multiplexer" (p.167)

About multiplexer EXT. I/O control, see "9 External Control (EXT. I/O)" (p.185).

For more information about multiplexer command control, see the Communications Command Instruction Manual. The Instruction Manual can be downloaded from Hioki's website.

<https://www.hioki.com/global/support/download/>

Restrictions when using the multiplexer unit

- When setting the measurement terminal to MUX (multiplexer)
The measurement terminals on the front of the instrument will not be available for use, but connected internally to Z3003's switches. Do not connect the measurement leads to the measurement terminals on the front of the instrument.
The BIN measurement function and statistical calculation function will be turned off automatically.
The data memory function cannot be used.
- When the multiplexer's measurement method is set to 2-wire
Ranges of 10 Ω and lower will not be available for use.
The contact check function will be disabled.
- Relay hot switching prevention function
Because back EMF remains when measuring a target such as a transformer, the relay hot switching prevention function will operate to keep processing from switching to the next channel until the back EMF has decreased.
To expedite the switching, specify a high-resistance range or lower the measurement current, for example, by using the low current switching setting.
See: "3.2 Selecting the Measurement Range" (p.48),
"4.2 Switching Measurement Currents (100 mΩ to 100 Ω range)" (p.67)

Connector type and pinouts

Pinouts (Connector: D-SUB 50 pin receptacle)

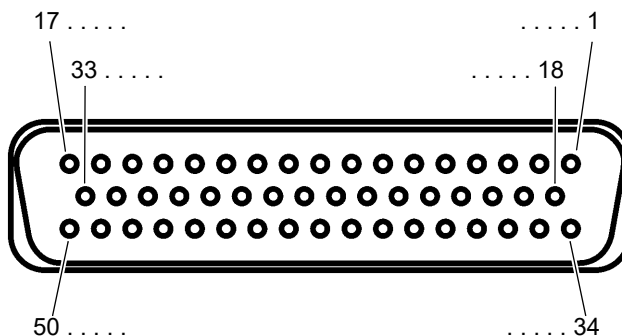
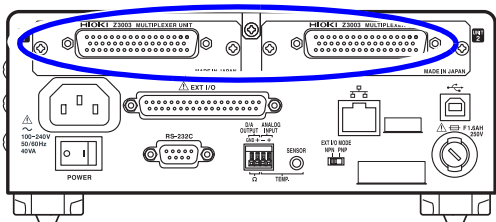

Connector (instrument side)

- 50-pin D-sub, 3-row type female with #4-40 screws
 - Compatible wire (max.)
Single wire: AWG22 equivalent
Stranded wire: AWG24 equivalent
- See: "14.14 Making Your Own Measurement Leads, Making Connections to the Multiplexer" (p.348)

Multiplexer connector (instrument side)

Compatible connector:

- DD-50P-ULR (solder type)
Japan Aviation Electronics Industry Ltd.

Pin assignments vary with the measurement method (4-wire/2-wire).

See: "Configuring multiplexer settings" (p.154)

4-wire

No.	Pin name		No.	Pin name		No.	Pin name	
1	-	-	18	TERM B5	SOURCE	34	TERM B9	SOURCE
2	TERM B1	SOURCE	19		SENSE	35		SENSE
3		SENSE	20	TERM A5	SOURCE	36	TERM A9	SOURCE
4	TERM A1	SOURCE	21		SENSE	37		SENSE
5		SENSE	22	TERM B6	SOURCE	38	TERM B10	SOURCE
6	TERM B2	SOURCE	23		SENSE	39		SENSE
7		SENSE	24	TERM A6	SOURCE	40	TERM A10	SOURCE
8	TERM A2	SOURCE	25		SENSE	41		SENSE
9		SENSE	26	TERM B7	SOURCE	42	-	-
10	TERM B3	SOURCE	27		SENSE	43	GUARD	
11		SENSE	28	TERM A7	SOURCE	44	GUARD	
12	TERM A3	SOURCE	29		SENSE	45	EX SOURCE B (EX Cur Hi)	
13		SENSE	30	TERM B8	SOURCE	46	EX SENSE B (EX Pot Hi)	
14	TERM B4	SOURCE	31		SENSE	47	EX SENSE A (EX Pot Lo)	
15		SENSE	32	TERM A8	SOURCE	48	EX SOURCE A (EX Cur Lo)	
16	TERM A4	SOURCE	33		SENSE	49	EX GUARD	
17		SENSE			50	EARTH		

2-wire

No.	Pin name	No.	Pin name	No.	Pin name
1	TERM A1	18	TERM B9	34	TERM B17
2	TERM B1	19	TERM B10	35	TERM B18
3	TERM B2	20	TERM A10	36	TERM A18
4	TERM A2	21	TERM A11	37	TERM A19
5	TERM A3	22	TERM B11	38	TERM B19
6	TERM B3	23	TERM B12	39	TERM B20
7	TERM B4	24	TERM A12	40	TERM A20
8	TERM A4	25	TERM A13	41	TERM A21
9	TERM A5	26	TERM B13	42	TERM B21
10	TERM B5	27	TERM B14	43	GUARD
11	TERM B6	28	TERM A14	44	GUARD
12	TERM A6	29	TERM A15	45	EX B (EX Hi)
13	TERM A7	30	TERM B15	46	EX B (EX Hi)
14	TERM B7	31	TERM B16	47	EX A (EX Lo)
15	TERM B8	32	TERM A16	48	EX A (EX Lo)
16	TERM A8	33	TERM A17	49	EX GUARD
17	TERM A9			50	EARTH

About multiplexer wiring

- Connect the multiplexer and measurement target as shown in the following diagram. See “7.7 Example Connections and Settings” (p.174) for specific examples of connections.

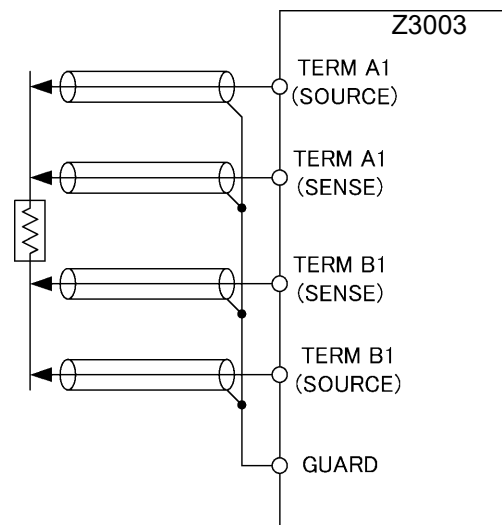

- Use shielded wires in the cables connected to the multiplexer connectors. Failure to do so may cause measured values to be unstable due to the effects of noise.
- Connect cable shielding to the GUARD pin.
See: “14.14 Making Your Own Measurement Leads, Making Connections to the Multiplexer” (p.348)

IMPORTANT

If two or more targets are connected simultaneously with one combination of SOURCE and SENSE terminals, 4-terminal measurement will not be performed properly. Connect only one target with one combination of terminals.

7

Example of incorrect wiring

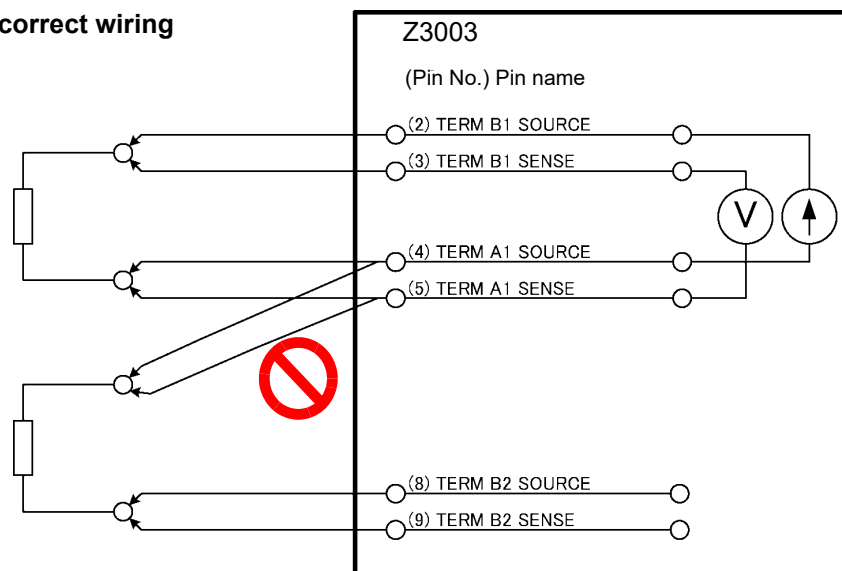

IMPORTANT

Connections and measurements cannot span different multiplexer units.
Example of unsupported measurement: Between Unit 1 TERM 1 and Unit 2 TERM 1

7.2 Internal Circuitry

- The Z3003 Multiplexer Unit enables the instrument to measure resistances connected with user-specified pins, assigning them to each of the A and B terminals.
- Each measurement terminal has built-in protection against coil back-EMF.
- Each terminal incorporates a built-in, protective fuse (rated current: 1.6 A). (Fuses cannot be replaced by the customer.) If the fuse trips due to over-input, measurement will no longer be possible. If this occurs, request repair of the instrument.
- The Z3003 Multiplexer Unit stores the number of relay switching cycles. This information can be accessed when performing the unit test with key operation or using commands, and it should be used to gauge maintenance timing.
- The unit test function performs short and open tests by shorting the measurement terminals. Short test measures a specific pin's round-trip route resistance and generates a PASS result if the value is 1 Ω or less.
- For more information about multiplexer command control, see the Communications Command Instruction Manual. The Instruction Manual can be downloaded from Hioki's website. <https://www.hioki.com/global/support/download/>

RM3545A-2

Z3003

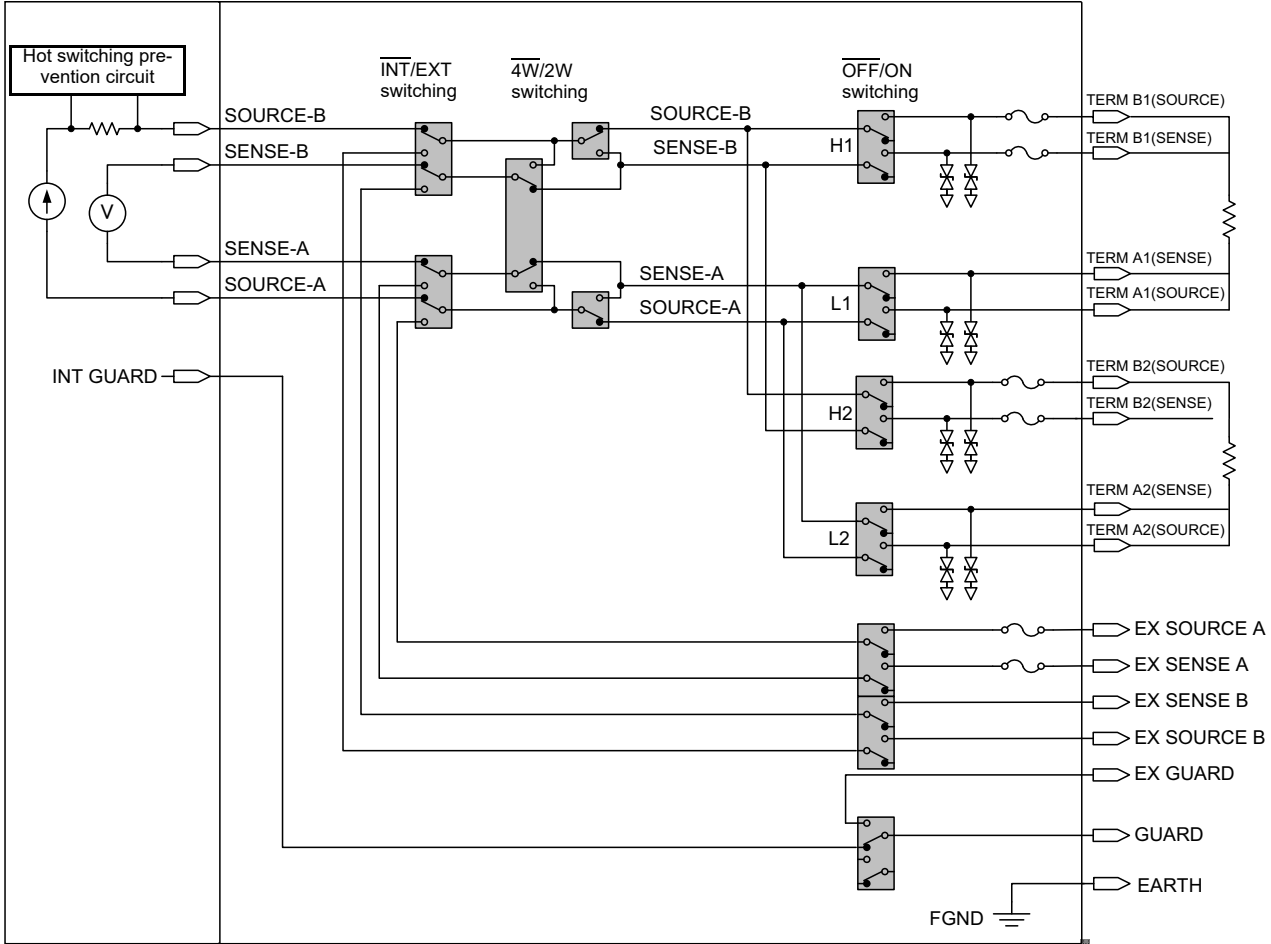

Electrical specifications

See: "12.6 Z3003 Multiplexer Unit" (p.293)

(1) Measurement targets (wiring order is user-selected)

4-wire	10 locations (when using two Z3003 units, 20 locations)
2-wire	21 locations (when using two Z3003 units, 42 locations)

(2) Measurable range

Measurement current	Instrument with Z3003: 1 A DC or less Externally connected device: 1 A DC or less, 100 mA AC or less
Measurement frequency	Externally connected device: DC, 10 Hz to 1 kHz

(3) Contact specifications

Contact type	Mechanical relay
Maximum allowable voltage	± 60 V DC, or 30 V AC rms and 42.4 V AC peak
Maximum allowable power	30 W (DC) (Resistance load)
Contact service life	4-wire: 50 million cycles. 2-wire: 5 million cycles (reference value)

7.3 Multiplexer Settings

In addition to instrument key operation and communications commands, a sample application software is available for configuring multiplexer settings.

The sample application software is available for download from Hioki's website.

<https://www.hioki.com/global/support/download/software/>

Configuring multiplexer settings

This section describes how to configure overall multiplexer operation.

The measurement terminal and scan function settings can also be configured from the Measurement screen.

See: "When changing the measurement terminal setting or scan function setting on the Measurement screen" (p.157)

If you wish to initialize the multiplexer channel settings

See: "6.7 Initializing (Reset)" (p.137)

IMPORTANT

- It is not possible to switch to the multiplexer if measurement leads are connected to the measurement terminals on the front of the instrument ([ERR:60] will be displayed). To use the multiplexer, be sure to disconnect any measurement leads.
- When switching from the multiplexer to the measurement terminals on the front of the instrument, the channel measurement conditions are retained. However, when switching from the measurement terminals on the front of the instrument to the multiplexer, the channel measurement conditions are switched.

1 Open the Settings screen.

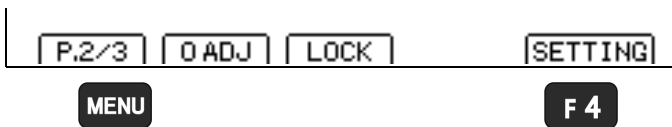

1 **MENU** Switch the function menu to P.2/3.

2 **F 4** The Settings screen appears.

2 Open the System Setting screen.

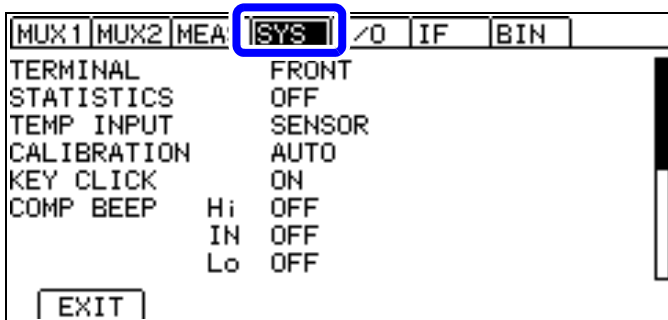

Move the cursor to the [SYS] tab with the left and right cursor keys.

3 Set the measurement terminals.

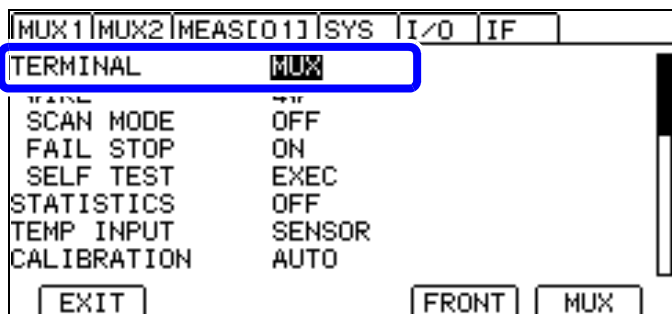

F3 **F4**

1 Selection

2
F3 Make measurements using the front measurement terminals (do not use the multiplexer). (default)

F4 Use the multiplexer.

4 Select the measurement method.

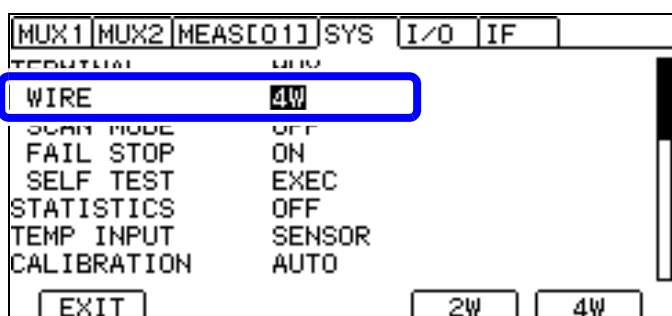

F3 **F4**

1 Selection

2
F3 2-wire (default)

F4 4-wire

IMPORTANT

When the measurement method is switched, the multiplexer channel settings will be initialized (i.e., a multiplexer channel reset will be performed). Always finalize the measurement method before allocating pins or performing zero adjustment.

5 Set the scan function.

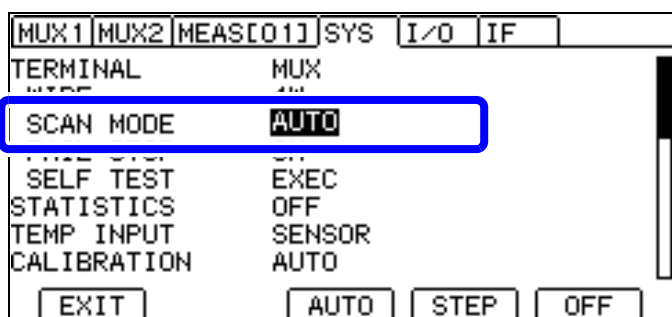

F2 **F3** **F4**

1 Selection

2
F2 Use auto-scan (measure all channels at each TRIG signal). (default)

F3 Use step scan (measure 1 channel at each TRIG signal).

F4 Do not scan.

IMPORTANT

When the scan function is set to auto or step, external trigger operation will be used regardless of the trigger source setting.

7

6 Select FAIL stop operation.

This setting is valid only when the scan function is on.

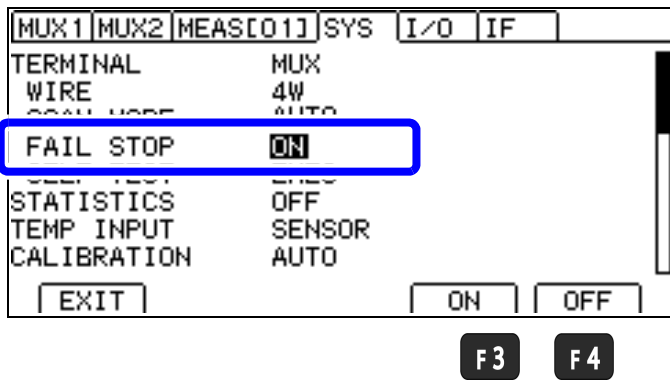

1 ◀ ▶ Selection

2

F3 Stop scanning when any channel yields a FAIL judgment.

F4 Do not stop scanning even if a channel yields a FAIL judgment. (default)

MENU Return to the Measurement screen.

When changing the measurement terminal setting or scan function setting on the Measurement screen

1 Set the measurement terminals.

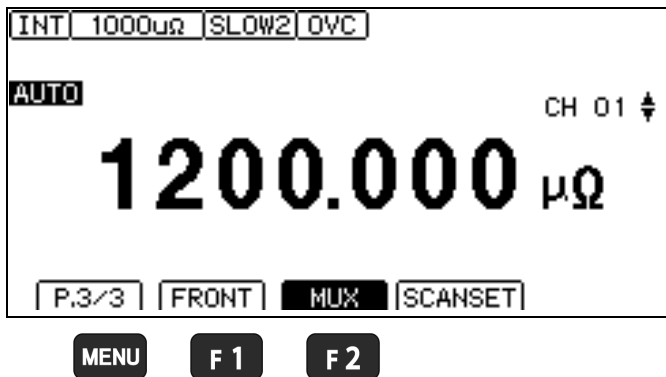

- 1 **MENU** Switch the function menu to P.3/3.
- 2 **F1** Make measurements using the front measurement terminals (do not use the multiplexer). (default)
- F2** Use the multiplexer.

2 Set the scan function.

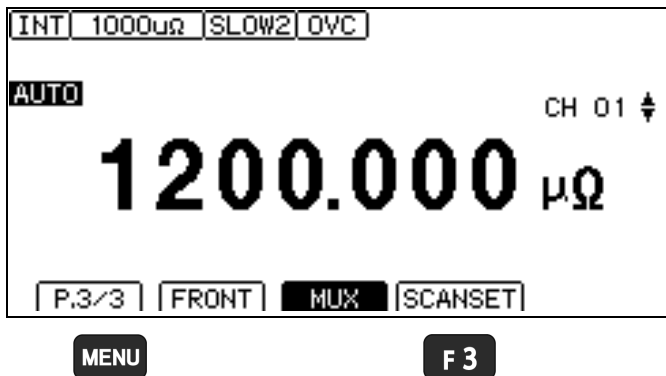

- 1 **MENU** Switch the function menu to P.3/3.
- 2 **F3** Scan Function Selection screen



- F2** Use auto-scan (measure all channels at each TRIG signal) (default).
- F3** Use step scan (measure 1 channel at each TRIG signal).
- F4** Do not scan.

Customizing channel pin allocation

The Multiplexer Unit can measure the resistance between user-specified pin pairs by changing the channel pin allocation. Pin allocation can be set for up to 42 channels.

If you wish to initialize the multiplexer channel settings

See: “6.7 Initializing (Reset)” (p.137)

Channel default settings

4-wire

CH		UNIT	TERM A	TERM B
1	Enabled	1	TERM A1	TERM B1
2	Disabled	1	TERM A2	TERM B2
:	:	:	:	:
10	Disabled	1	TERM A10	TERM B10
11	Disabled	2	TERM A1	TERM B1
12	Disabled	2	TERM A2	TERM B2
:	:	:	:	:
20	Disabled	2	TERM A10	TERM B10
21	Disabled	1	TERM A1	TERM B1
22	Disabled	1	TERM A1	TERM B1
:	:	:	:	:
42	Disabled	1	TERM A1	TERM B1

2-wire

CH		UNIT	TERM A	TERM B
1	Enabled	1	TERM A1	TERM B1
2	Disabled	1	TERM A2	TERM B2
:	:	:	:	:
21	Disabled	1	TERM A21	TERM B21
22	Disabled	2	TERM A1	TERM B1
23	Disabled	2	TERM A2	TERM B2
:	:	:	:	:
42	Disabled	2	TERM A21	TERM B21

See: “7.7 Example Connections and Settings” (p.174)

Setting the connection and measurement method for individual channels

- 1 Open the Settings screen.

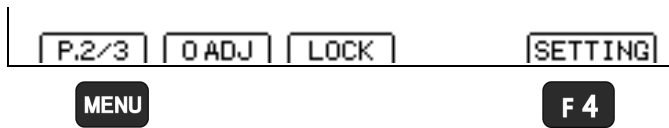

- 1 **MENU** Switch the function menu to P.2/3.
- 2 **F 4** The Settings screen appears.

- 2 Open the Multiplexer Channel Settings screen.

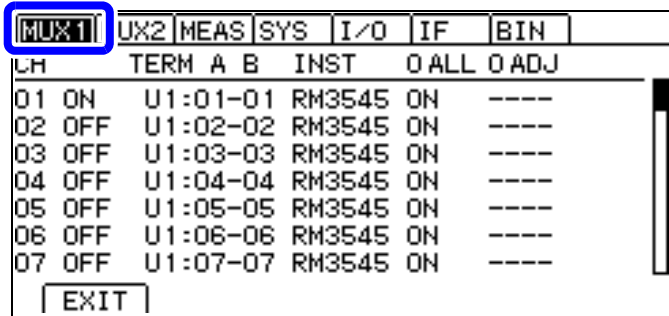

Move the cursor to the **[MUX1]** tab with the left and right cursor keys.

- 3 Move to the channel you wish to set.

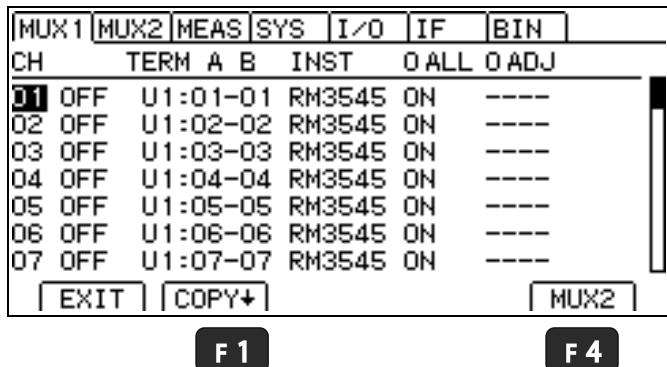

Select the channel to set.

<Hint>

You can copy the settings for the selected channel to the next channel with the **F 1** key. (Only the settings shown on the screen will be copied. However, unit and pin settings will not be copied.)

You can return to the **[MUX2]** tab with the **F 4** key.

4 Set the channels being used to on.

MUX1	MUX2	MEAS	SYS	I/O	IF	BIN
CH	TERM	A B	INST	O ALL	O ADJ	
01	ON	U1:01-01	RM3545	ON	----	
02	OFF	U1:02-02	RM3545	ON	----	
03	OFF	U1:03-03	RM3545	ON	----	
04	OFF	U1:04-04	RM3545	ON	----	
05	OFF	U1:05-05	RM3545	ON	----	
06	OFF	U1:06-06	RM3545	ON	----	
07	OFF	U1:07-07	RM3545	ON	----	

- 1 Move to the CH settings.
- 2 **F3** Use the channel.
F4 Do not use the channel.

F3 **F4**

Channels that have been set to OFF cannot be selected on the Measurement screen. Additionally, since channels set to off are ignored in scanning, they cannot be measured.

5 Select the unit to which the measurement target will be connected.

MUX1	MUX2	MEAS	SYS	I/O	IF	BIN
CH	TERM	A B	INST	O ALL	O ADJ	
01	ON	U1 :01-01	RM3545	ON	----	
02	OFF	U1:02-02	RM3545	ON	----	
03	OFF	U1:03-03	RM3545	ON	----	
04	OFF	U1:04-04	RM3545	ON	----	
05	OFF	U1:05-05	RM3545	ON	----	
06	OFF	U1:06-06	RM3545	ON	----	
07	OFF	U1:07-07	RM3545	ON	----	

- 1 Move to unit selection.
- 2 **F3** Multiplexer unit 1
F4 Multiplexer unit 2

F3 **F4**

6 Select the pin to which the measurement target will be connected.

MUX1	MUX2	MEAS	SYS	I/O	IF	BIN
CH	TERM	A B	INST	O ALL	O ADJ	
01	ON	U1: 01 -01	RM3545	ON	----	
02	OFF	U1:02-02	RM3545	ON	----	
03	OFF	U1:03-03	RM3545	ON	----	
04	OFF	U1:04-04	RM3545	ON	----	
05	OFF	U1:05-05	RM3545	ON	----	
06	OFF	U1:06-06	RM3545	ON	----	
07	OFF	U1:07-07	RM3545	ON	----	

- 1 Move to **[TERM A]** (current detection side) selection.
- 2 **F3** Set the terminal number.
F4

F3 **F4**

MUX1	MUX2	MEAS	SYS	I/O	IF	BIN
CH	TERM	A B	INST	O ALL	O ADJ	
01	ON	U1:01- 01	RM3545	ON	----	
02	OFF	U1:02-02	RM3545	ON	----	
03	OFF	U1:03-03	RM3545	ON	----	
04	OFF	U1:04-04	RM3545	ON	----	
05	OFF	U1:05-05	RM3545	ON	----	
06	OFF	U1:06-06	RM3545	ON	----	
07	OFF	U1:07-07	RM3545	ON	----	



- 1 Move to **[TERM B]** (current application side) selection.
- 2 **F3** Set the terminal number.
F4

F3 **F4**

7 Set the measuring instrument for each channel.

MUX1	MUX2	MEAS	SYS	I/O	IF	BIN
CH	TERM	A	B	INST	O ALL	O ADJ
01	ON	U1:01-01		RM3545	ON	----
02	OFF	U1:02-02		RM3545	ON	----
03	OFF	U1:03-03		RM3545	ON	----
04	OFF	U1:04-04		RM3545	ON	----
05	OFF	U1:05-05		RM3545	ON	----
06	OFF	U1:06-06		RM3545	ON	----
07	OFF	U1:07-07		RM3545	ON	----
EXIT				RM3545	EXT	

MENU
F 3
F 4

1   Move to [INST] selection.

2

F 3 Measure resistance using the instrument.

F 4 Measure using an externally connected device.

MENU Return to the Measurement screen.

8 Repeat Steps 3 through 7 above to configure other channels' settings.

IMPORTANT

When the scan function is set to AUTO, channels that are set to an externally connected device will be ignored.

Setting basic measurement conditions and total judgment conditions for individual channels

Basic measurement conditions for individual channels can be set in list form.

Total judgments

After performing scan measurement, a total judgment is made based on the judgment results (comparator judgments) for individual channels.

If the judgment results for all channels satisfy the PASS conditions that have been set on a channel-by-channel basis, the total judgment result will be **[PASS]**, and the EXT. I/O output T_PASS signal will turn on. In the event of a measurement fault, a **[-----]** (judgment not possible) judgment will result, and the EXT. I/O T_ERR signal will turn on. A **[FAIL]** judgment results, and the EXT. I/O T_FAIL signal will turn on if the judgment is neither **[PASS]** nor **[-----]**.

PASS condition	Description
OFF	Results in an unconditional PASS judgment. Results in a PASS judgment even if a measurement fault occurs.
IN	Results in a PASS judgment when the channel's judgment result is IN. (default)
HI	Results in a PASS judgment when the channel's judgment result is HI.
LO	Results in a PASS judgment when the channel's judgment result is LO.
HI/LO	Results in a PASS judgment when the channel's judgment result is either HI or LO.
ALL	Results in a PASS judgment when the channel's judgment result is HI, LO, or IN. Does not result in a PASS judgment if a measurement fault occurs.

Total judgment result	Judgment criterion	EXT. I/O output
PASS	If all channels' judgment results satisfy the PASS conditions	T_PASS
FAIL	If even one channel's judgment result fails to satisfy the PASS conditions	T_FAIL
----- (judgment not possible)	If any of the channels yields a measurement fault or error (takes precedence over FAIL judgments)	T_ERR

IMPORTANT

- Total judgments are not made when scan mode is off.
- Channels for which the measuring instrument is set to EXT (external device) are not included in total judgments.

When the comparator judgment method is REF%, the channel 1 measured value can be used as the reference value. (p.164)

If you wish to initialize the multiplexer channel settings

See: "6.7 Initializing (Reset)" (p.137)

Setting basic measurement conditions

- 1 Open the Settings screen.

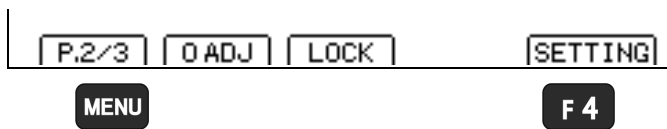

- 1 **MENU** Switch the function menu to P.2/3.

- 2 **F 4** The Settings screen appears.

- 2 Open the Multiplexer Basic Measurement screen.

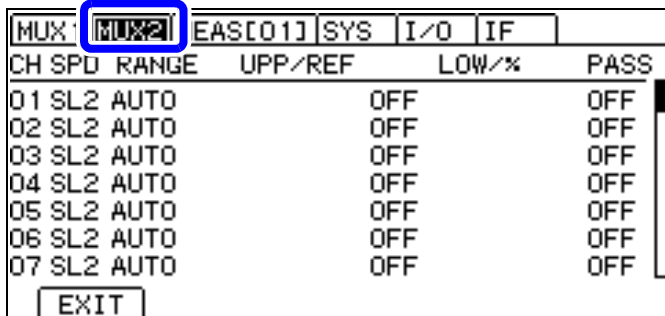

Move the cursor to the **[MUX2]** tab with the left and right cursor keys.

- 3 Move to the channel you wish to set.

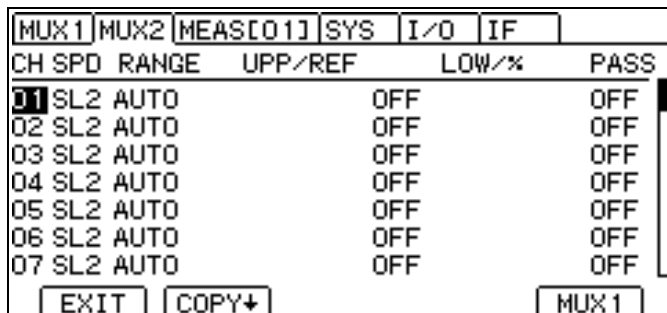

Select the channel to set.

F 1

F 4

<Hint>

You can copy the settings for the selected channel to the next channel with the **F 1** key. (All settings shown on the screen as well as those on the **[MEAS]** tab will be copied.)

You can return to the **[MUX1]** tab with the **F 4** key.

- 4 Set the measurement speed.

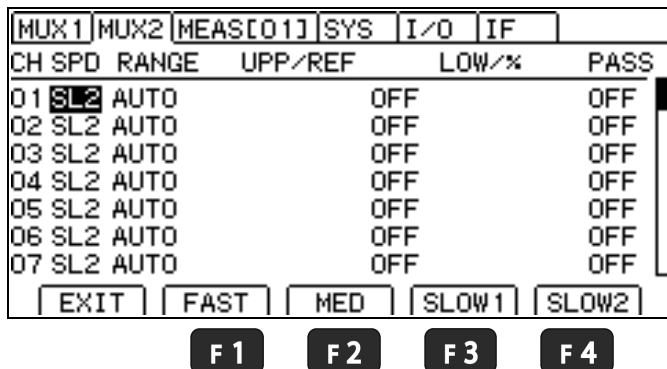

1 Move to the SPD (SPEED) parameter.



2 Set the measurement speed to FAST.



Set the measurement speed to MEDIUM.



Set the measurement speed to SLOW1.



Set the measurement speed to SLOW2.

F 1

F 2

F 3

F 4

5 Set the measurement range.

MUX1	MUX2	MEAS[01]	SYS	I/O	IF
CH	SPD	RANGE	UPP/REF	LOW/%	PASS
01	SL2	1000uΩ	OFF		OFF
02	SL2	AUTO	OFF		OFF
03	SL2	AUTO	OFF		OFF
04	SL2	AUTO	OFF		OFF
05	SL2	AUTO	OFF		OFF
06	SL2	AUTO	OFF		OFF
07	SL2	AUTO	OFF		OFF

EXIT AUTO + +
F2 F3 F4

- 1  Move to the **[RANGE]** parameter.
- 2 F2 Set to auto-ranging.
- 3 F3 F4 Select the range you wish to use.

IMPORTANT
 When auto-ranging is selected, the comparator settings cannot be set to on. To use the comparator, set the measurement range first.

6 Set the comparator.

1. Determine the judgment method.

MUX1	MUX2	MEAS[01]	SYS	I/O	IF
CH	SPD	RANGE	UPP/REF	LOW/%	PASS
01	SL2	1000uΩ	1000.00 uΩ	0000.00 uΩ	IN
02	SL2	1000uΩ	1000.00 uΩ	00.000 %	IN
03	SL2	1000uΩ	1000.00 uΩ	0000.00 uΩ	IN
04	SL2	1000uΩ	1000.00 uΩ	0000.00 uΩ	IN
05	SL2	1000uΩ	1000.00 uΩ	0000.00 uΩ	IN
06	SL2	1000uΩ	1000.00 uΩ	0000.00 uΩ	IN
07	SL2	1000uΩ	1000.00 uΩ	0000.00 uΩ	IN

P.1/2 ON/OFF ABS REF% EDIT
MENU F1 F2 F3 F4

- 1  Move to the UPP/REF parameter.
- 2 F1 Enable or disable comparator.
F2 Set the judgment mode to ABS (UPP, LOW).
F3 Set the judgment mode to REF%.
- 3 F4 Make the value editable.

You can use the CH1 measurement result as the reference value for CH2 and subsequent channels in REF% mode by pressing F2 on MENU P.2/2.

MUX1	MUX2	MEAS[01]	SYS	I/O	IF
CH	SPD	RANGE	UPP/REF	LOW/%	PASS
01	SL2	1000uΩ	1000.00 uΩ	0000.00 uΩ	IN
02	SL2	1000uΩ	1000.00 uΩ	00.000 %	IN
03	SL2	1000uΩ	1000.00 uΩ	0000.00 uΩ	IN
04	SL2	1000uΩ	1000.00 uΩ	0000.00 uΩ	IN
05	SL2	1000uΩ	1000.00 uΩ	0000.00 uΩ	IN
06	SL2	1000uΩ	1000.00 uΩ	0000.00 uΩ	IN
07	SL2	1000uΩ	1000.00 uΩ	0000.00 uΩ	IN

P.2/2 NUM CH1
MENU F2

- 1 MENU Switch the function menu to P.2/2.
- 2 F2 Set the reference value to the CH1 judgment result.

MUX1	MUX2	MEAS[01]	SYS	I/O	IF
CH	SPD	RANGE	UPP/REF	LOW/%	PASS
01	SL2	1000uΩ	1000.00 uΩ	0000.00 uΩ	IN
02	SL2	1000uΩ	CH1	00.000 %	IN
03	SL2	1000uΩ	1000.00 uΩ	0000.00 uΩ	IN
04	SL2	1000uΩ	1000.00 uΩ	0000.00 uΩ	IN
05	SL2	1000uΩ	1000.00 uΩ	0000.00 uΩ	IN
06	SL2	1000uΩ	1000.00 uΩ	0000.00 uΩ	IN
07	SL2	1000uΩ	1000.00 uΩ	0000.00 uΩ	IN

P.2/2 NUM CH1

The CH2 reference value has been set to the CH1 judgment result.

2. Set the upper limit value or reference value.

MUX1	MUX2	MEAS[01]	SYS	I/O	IF
CH	SPD	RANGE	UPP/REF	LOW/%	PASS
01	SL2	1000 $\mu\Omega$	1000.00 $\mu\Omega$	0000.00 $\mu\Omega$	IN
02	SL2	1000 $\mu\Omega$	1000.00 $\mu\Omega$	00.000 %	IN
03	SL2	1000 $\mu\Omega$	1000.00 $\mu\Omega$	0000.00 $\mu\Omega$	IN
04	SL2	1000 $\mu\Omega$	1000.00 $\mu\Omega$	0000.00 $\mu\Omega$	IN
05	SL2	1000 $\mu\Omega$	1000.00 $\mu\Omega$	0000.00 $\mu\Omega$	IN
06	SL2	1000 $\mu\Omega$	1000.00 $\mu\Omega$	0000.00 $\mu\Omega$	IN
07	SL2	1000 $\mu\Omega$	1000.00 $\mu\Omega$	0000.00 $\mu\Omega$	IN

F2

- 1 Move among digits. Change values.
Move the cursor to the digit you wish to set with the left and right cursor keys. Change the value with the up and down cursor keys.
- 2 **ENTER** Accept
(**ESC**) Cancel

To Reset Numerical Values

Press **F2** to clear the value. The value will be reset to 0.

3. Set the lower limit value or allowable range.

Move to the LOW/ \pm % parameter with the left and right cursor keys and set the lower limit value or absolute value in the same manner.

7 Set the PASS condition (when the scan function is set to auto or step only).

MUX1	MUX2	MEAS[01]	SYS	I/O	IF
CH	SPD	RANGE	UPP/REF	LOW/%	PASS
01	SL2	1000 $\mu\Omega$	1000.00 $\mu\Omega$	0000.00 $\mu\Omega$	IN
02	SL2	1000 $\mu\Omega$	1000.00 $\mu\Omega$	00.000 %	IN
03	SL2	1000 $\mu\Omega$	1000.00 $\mu\Omega$	0000.00 $\mu\Omega$	IN
04	SL2	1000 $\mu\Omega$	1000.00 $\mu\Omega$	0000.00 $\mu\Omega$	IN
05	SL2	1000 $\mu\Omega$	1000.00 $\mu\Omega$	0000.00 $\mu\Omega$	IN
06	SL2	1000 $\mu\Omega$	1000.00 $\mu\Omega$	0000.00 $\mu\Omega$	IN
07	SL2	1000 $\mu\Omega$	1000.00 $\mu\Omega$	0000.00 $\mu\Omega$	IN

MENU

F1

F3

F4

- 1 Move the cursor to the PASS CONDITION parameter.
- 2 **F1** Set the PASS condition to OFF.
- F3** **F4** Select the PASS condition.
- MENU** Return to the Measurement screen.

7

Customizing measurement conditions for individual channels

Set the measurement conditions for each channel.

See: "Customizing channel pin allocation" (p.158)

If you wish to initialize the multiplexer channel settings

See: "6.7 Initializing (Reset)" (p.137)

1 Open the Settings screen.

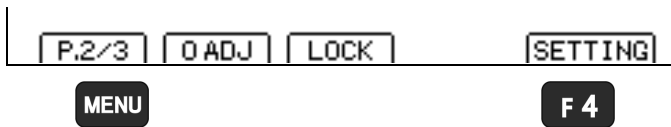

1 **MENU** Switch the function menu to P.2/3.

2 **F4** The Settings screen appears.

2 Open the Measurement Setting screen.

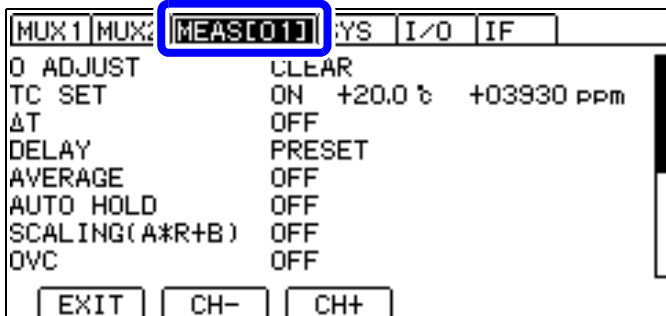

Move the cursor to the **[MEAS]** tab with the left and right cursor keys.

3 Select the channel for which to set measurement conditions.

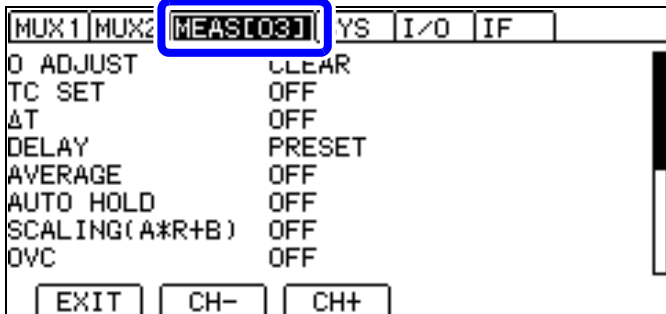

1 **F1** CH-:
Changes (decreases) the channel.

2 **F2** CH+:
Changes (increases) the channel.



4 Set the measurement conditions.

<Hint>

The channel can be changed for each setting with the **▲** **▼** keys.

Measurement conditions can be copied to the next channel. (See: p.163)

MENU Return to the Measurement screen.

7.4 Measuring with the Multiplexer

Measuring while switching channels manually

This section describes how to perform measurement while changing channels manually.

Configure these settings beforehand, while seeing “Configuring multiplexer settings” (p.154) and “Customizing measurement conditions for individual channels” (p.166).

1 Turn off the scan function.

See: “Configuring multiplexer settings” (p.154)

2 Change channels manually.

Measurement will be performed after applying the measurement conditions for the selected channel.

You can also change the measurement range, speed, and comparator settings directly from the Measurement screen.

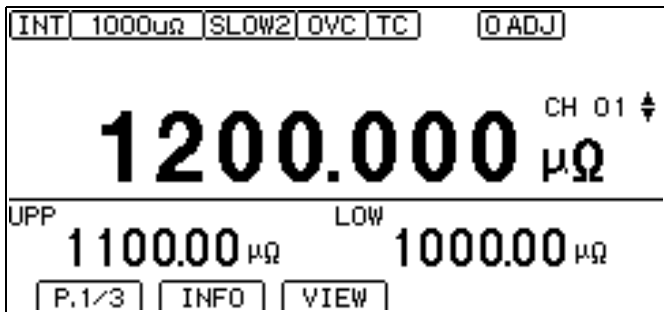

Select the channel.

With the exception of channel operations, functionality is the same as measurement using the terminals on the front of the instrument.

Performing scan measurement

This section describes how to measure channels in successive order.

Configure these settings beforehand, while seeing “Configuring multiplexer settings” (p.154) and “Customizing measurement conditions for individual channels” (p.166).

- 1 Set the scan function to either auto or step.**
See: “Configuring multiplexer settings” (p.154)

IMPORTANT

When the scan function is set to step, you will need to input the trigger for each channel. When the scan function is set to auto, you can measure all channels with a single trigger input.

Input the external trigger to perform measurement. (Trigger input: EXT. I/O TRIG signal, ENTER (trigger) key, *TRG command)

IMPORTANT

- When the scan function is set to auto or step, the trigger source will be set to an external trigger ([EXT]).
- When the scan function is auto or step, the range, comparator, and speed cannot be changed on the Measurement screen. Instead, these settings must be changed on the Settings screen.
- When the scan function is set to AUTO, channels that are set to an externally connected device will be ignored.

The measurement results will be displayed.

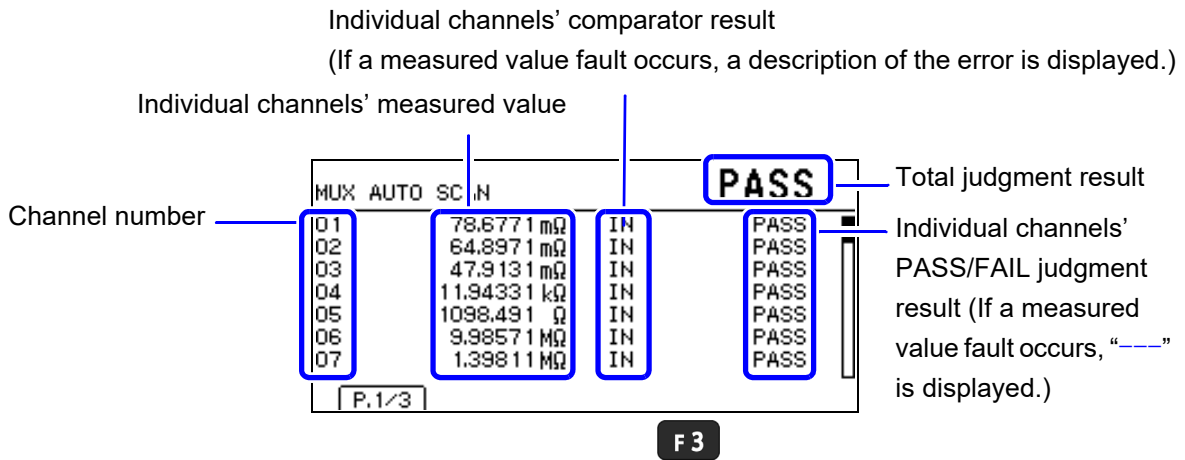

Scan measurement can be stopped by pressing **F3** [STOP] during scanning.

- When the scan function is set to auto
Scan measurement will stop midway through the scan.
- When the scan function is set to step
If there is a scan in progress, it will return to the first channel.

IMPORTANT

During scan measurement, only the Standby and **F3** [STOP] keys can be used.

7.5 Zero adjustment (When a Multiplexer Unit Has Been Installed)

Performing zero adjustment

Performing scanning zero adjustment (when the scan function is set to auto or step only)

Zero adjustment will be performed for all selected channels. If there is a large number of enabled channels, this operation may take several dozens of seconds. However, the measurement time can be shortened by using a manual measurement range.

- 1 Open the Settings screen.
(If you already finished configuring settings, proceed to Step 4.)

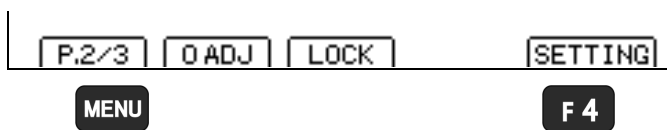

- 1 **MENU** Switch the function menu to P.2/3.
- 2 **F 4** The Settings screen appears.

- 2 Open the Multiplexer Channel Settings screen.

The screenshot shows a table with columns: MUX1, MUX2, MEAS, SYS, I/O, IF, BIN. The 'MUX1' tab is selected and highlighted with a blue box. Below the table is an 'EXIT' button.

CH	TERM	A	B	INST	O ALL	O ADJ
01	ON	U1:01-01	RM3545	ON	----	
02	OFF	U1:02-02	RM3545	ON	----	
03	OFF	U1:03-03	RM3545	ON	----	
04	OFF	U1:04-04	RM3545	ON	----	
05	OFF	U1:05-05	RM3545	ON	----	
06	OFF	U1:06-06	RM3545	ON	----	
07	OFF	U1:07-07	RM3545	ON	----	



Move the cursor to the **[MUX1]** tab with the left and right cursor keys.

- 3 Set the channels for which you wish to perform zero adjustment.

The screenshot shows the same table as in Step 2, but with the 'O ALL' column highlighted. Below the table are two buttons: 'F 3' and 'F 4'.

CH	TERM	A	B	INST	O ALL	O ADJ
01	ON	U1:01-01	RM3545	ON	ON	----
02	OFF	U1:02-02	RM3545	ON	ON	----
03	OFF	U1:03-03	RM3545	ON	ON	----
04	OFF	U1:04-04	RM3545	ON	ON	----
05	OFF	U1:05-05	RM3545	ON	ON	----
06	OFF	U1:06-06	RM3545	ON	ON	----
07	OFF	U1:07-07	RM3545	ON	ON	----

- 1 Select the channel to set.
- 2 Move to the **[O ALL]** parameter.
- 3 **F 3** Perform zero adjustment.
F 4 Do not perform zero adjustment.

The **[O ADJ]** column will indicate **[DONE]** for channels for which zero adjustment has already been performed.

The **[O ADJ]** column will indicate **[--]** for channels for which zero adjustment has not yet been performed.

- 4 Connect each channel to 0 Ω .
See: "14.6 About Zero Adjustment" (p.325)
- 5 **F 4** Perform zero adjustment.
See: "4.3 Performing Zero Adjustment" (p.69)

IMPORTANT

Zero adjustment cannot be performed for channels for which the measuring instrument is set to an externally connected device.

Canceling zero adjustment

Zero adjustment can be canceled from either the Multiplexer Channel Settings screen or the Measurement Settings screen.

Canceling zero adjustment from the Multiplexer Channel Settings screen

- 1 Open the Settings screen.

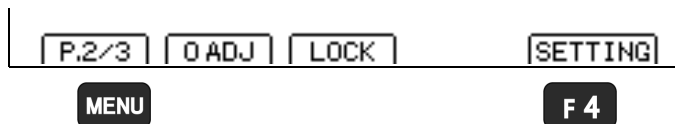

- 1 **MENU** Switch the function menu to P.2/3.

- 2 **F 4** The Settings screen appears.

- 2 Open the Multiplexer Channel Settings screen.

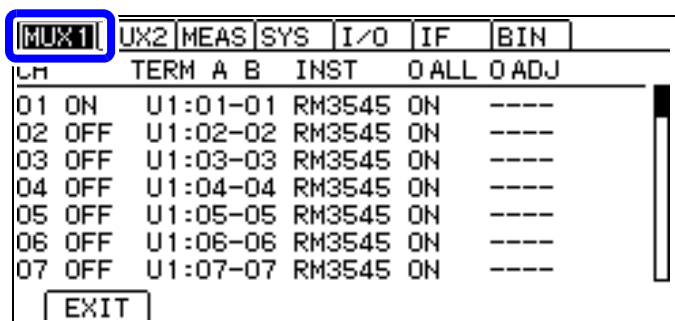

Move the cursor to the **[MUX1]** tab with the left and right cursor keys.

- 3 Set the channels for which you wish to cancel zero adjustment and then press **F 1**.

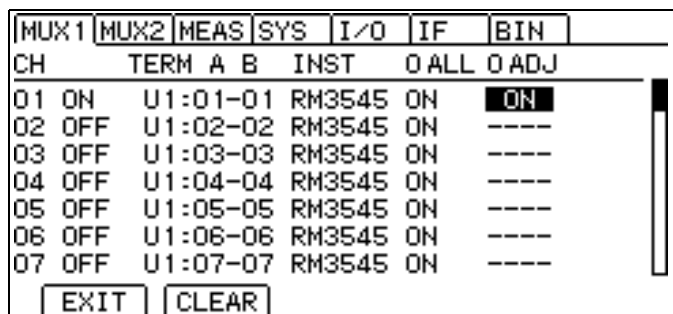

- 1 Select the channel to set.

- 2 Move to the **[O ADJ]** parameter.

[DONE] will be indicated for channels for which zero adjustment has already been performed, while **[---]** will be indicated for channels for which zero adjustment has not been performed.

- 3 **F 1** Canceling zero adjustment
The confirmation message is displayed.

- 4 Confirm the message and select **F 2 [OK]**.
The message is displayed and zero adjustment is canceled.

MENU Return to the Measurement screen.

Canceling zero adjustment from the Measurement Setting screen

- 1 Open the Settings screen.

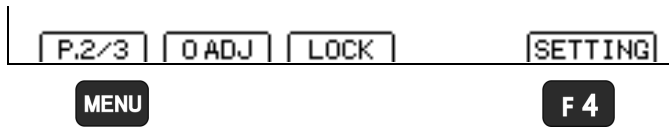

- 1 **MENU** Switch the function menu to P.2/3.

- 2 **F4** The Settings screen appears.

- 2 Open the Measurement Setting screen.

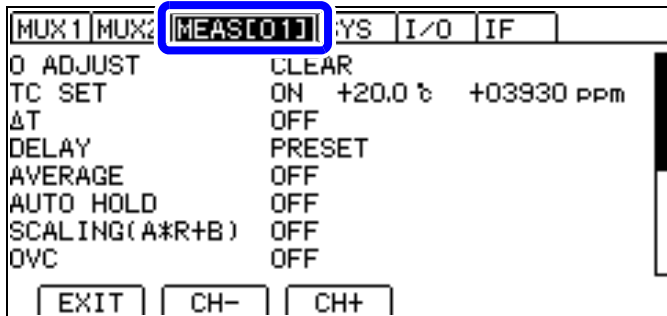

Move the cursor to the **[MEAS]** tab with the left and right cursor keys.

- 3 Select 0 ADJUST and select a channel for which you want to cancel zero adjustment.

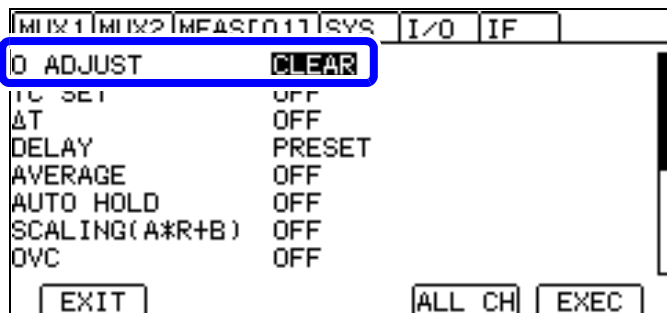

- 1 Selection

- 2 **F3** Cancel zero adjustment for all channels.

- 2 **F4** Cancel zero adjustment for the selected channel.

The confirmation message is displayed.

- 4 Confirm the message and select **F2 [OK]**.
The message is displayed and zero adjustment is canceled.

MENU Return to the Measurement screen.

7.6 Performing the Multiplexer Unit Test

This section describes how to verify proper Multiplexer Unit operation.

IMPORTANT
Do not connect the measurement leads to the measurement terminals on the front of the instrument.

1 Open the Settings screen.

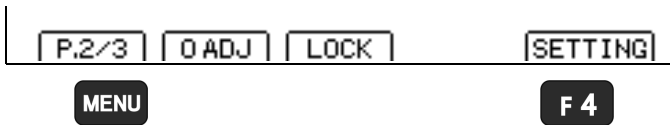

1 **MENU** Switch the function menu to P.2/3.

2 **F 4** The Settings screen appears.

2 Open the System Setting screen.

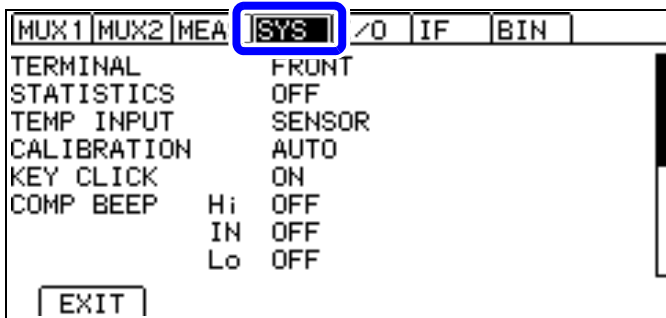

Move the cursor to the **[SYS]** tab with the left and right cursor keys.

3 Perform the unit test.

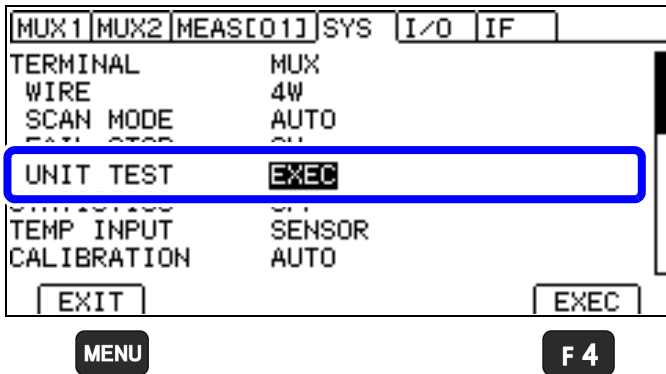

1 Select **[UNIT TEST]**.
(UNIT TEST is displayed only when **[TERMINAL]** is set to **[MUX]**.)

2 Short pins 1 through 42
See: "Connection when performing the unit test" (p.173)

3 **F 4** Perform the self-test.
After the confirmation message and the number of relay switching cycles are displayed, a short-circuit resistance value check will be performed, and the results will be displayed.

Example test results

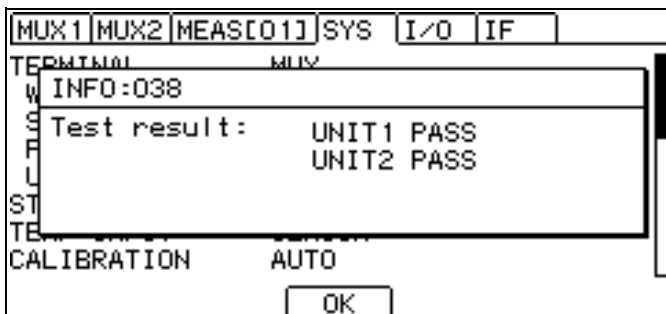

If the display shows **[Blown FUSE.]**, the measurement circuit's protective fuse has been tripped. Replace the fuse.

See: "13.3 Replacing the Measurement Circuit's Protective Fuse" (p.315)

MENU Return to the Measurement screen.

Connection when performing the unit test

When performing the unit test, short all the pins numbered 1 to 42.

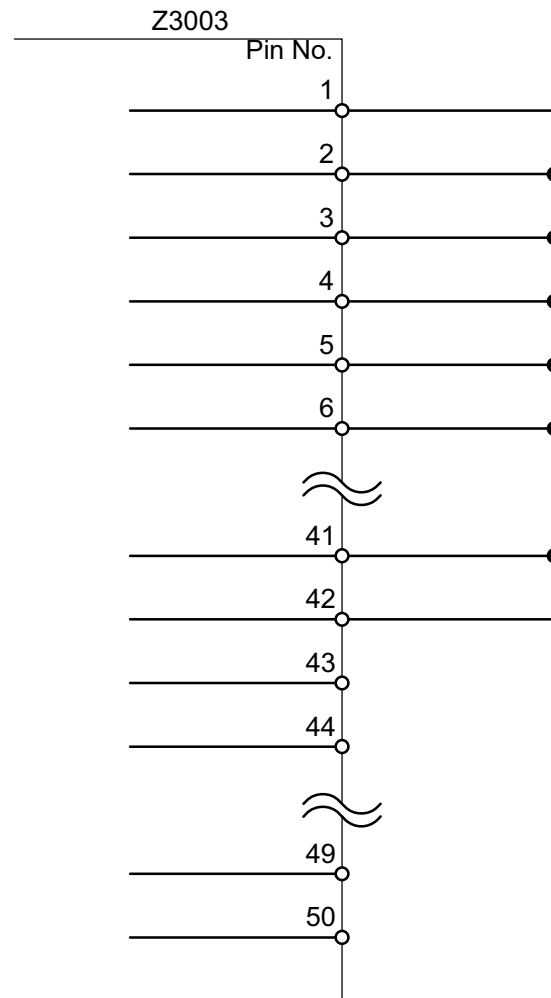

IMPORTANT

- The resistance of the shorted wiring is included in the test. Short the pins at points that are close to each pin so that wirings are as short as possible.
- Do not short the pins Number 43 and 44 with the others. Since they are the guard terminals, the test will not be performed properly if they are shorted with the others.

7.7 Example Connections and Settings

Example cable assembly (wire harness) settings

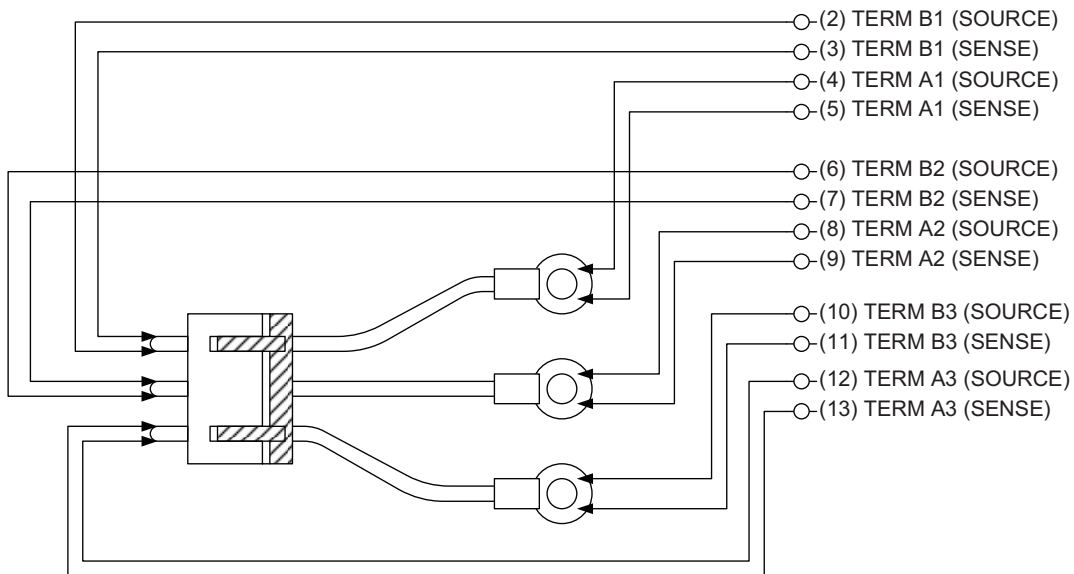

MUX settings

CH	INST.	UNIT	TERM A	TERM B
1	RM3545	UNIT1	1	1
2	RM3545	UNIT1	2	2
3	RM3545	UNIT1	3	3

Example battery terminal weld settings

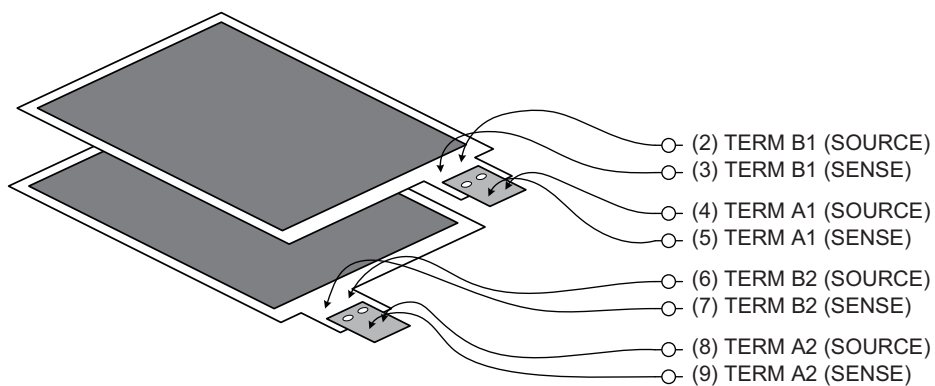

MUX settings

CH	INST.	UNIT	TERM A	TERM B
1	RM3545	UNIT1	1	1
2	RM3545	UNIT1	2	2

Example settings for multiple battery terminal welds

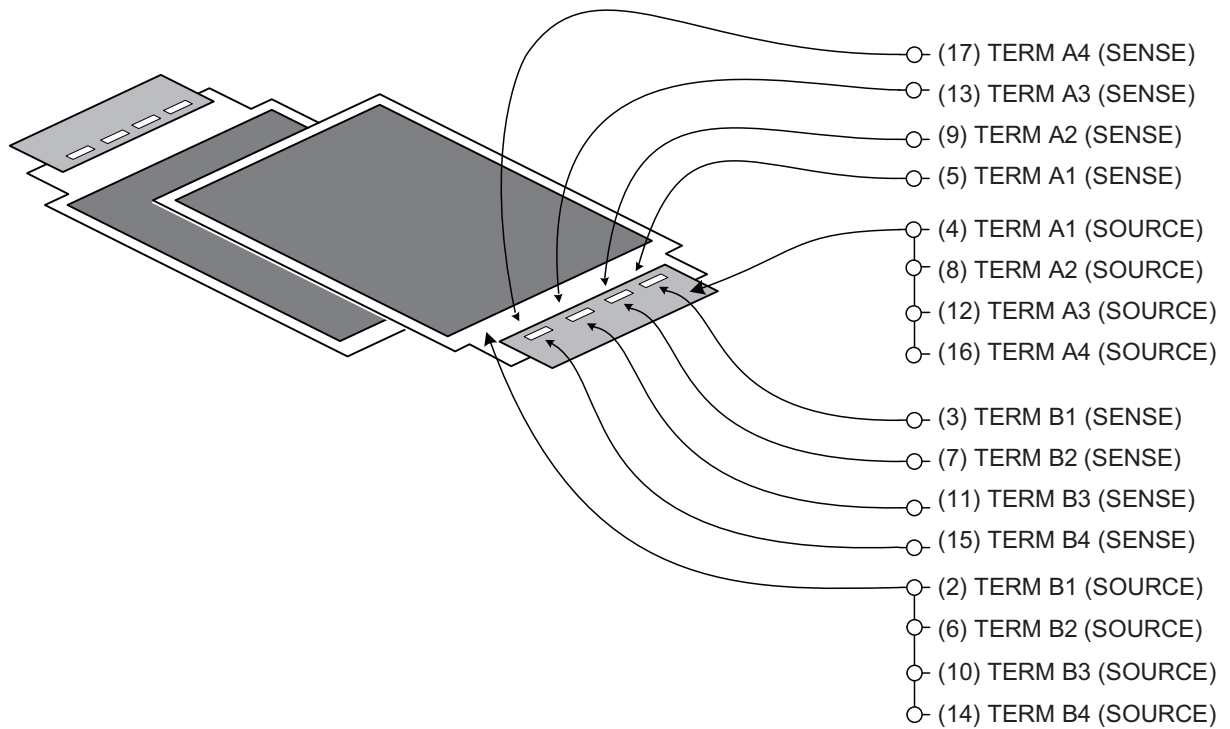

MUX settings

CH	INST.	UNIT	TERM A	TERM B
1	RM3545	UNIT1	1	1
2	RM3545	UNIT1	2	2
3	RM3545	UNIT1	3	3
4	RM3545	UNIT1	4	4

Example settings for a measurement target with high temperature dependence

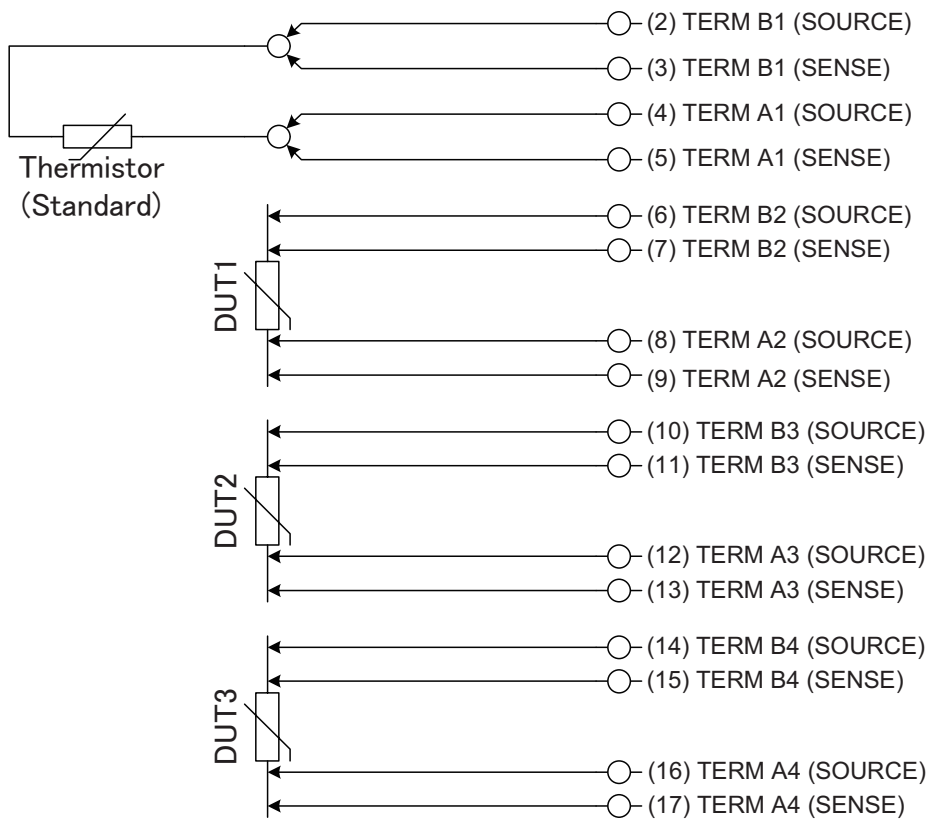

Using channel 1 (thermistor) measurement results as the comparator reference value

MUX settings

CH	INST.	UNIT	TERM A	TERM B
1	RM3545	UNIT1	1	1
2	RM3545	UNIT1	2	2
3	RM3545	UNIT1	3	3
4	RM3545	UNIT1	4	4

MEAS setting

MEAS tab	COMP	REF	%
MEAS[01]	OFF		
MEAS[02]	REF%	CH01	5.0
MEAS[03]	REF%	CH01	5.0
MEAS[04]	REF%	CH01	5.0

Example network resistor settings

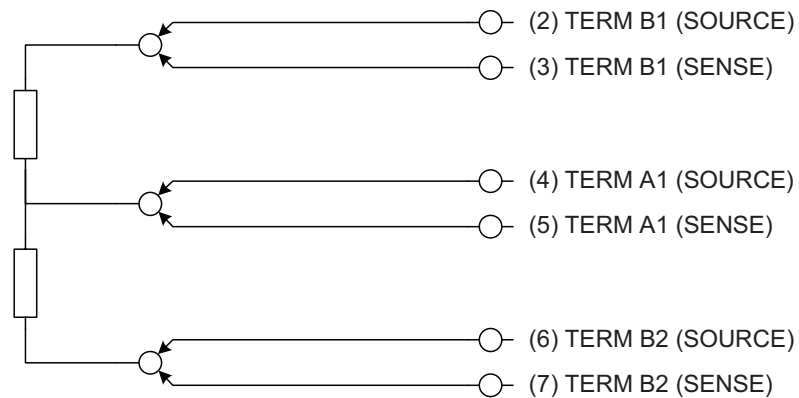

MUX settings

CH	INST.	UNIT	TERM A	TERM B
1	RM3545	UNIT1	1	1
2	RM3545	UNIT1	1	2

Example steering switch settings

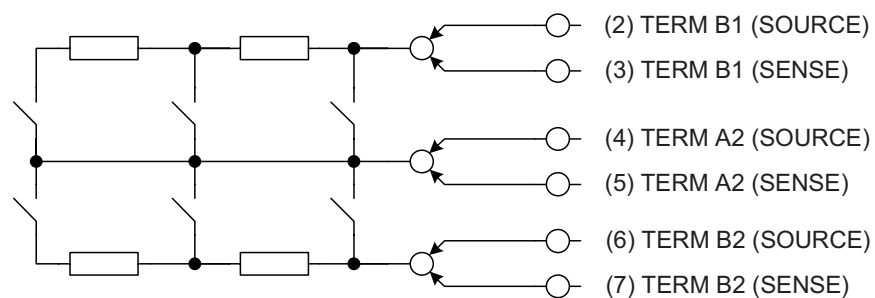

MUX settings

CH	INST.	UNIT	TERM A	TERM B
1	RM3545	UNIT1	2	1
2	RM3545	UNIT1	2	1
3	RM3545	UNIT1	2	1
4	RM3545	UNIT1	2	2
5	RM3545	UNIT1	2	2
6	RM3545	UNIT1	2	2

(A step scan is used, with switches being toggled on and off between channels.)

Example power switch settings

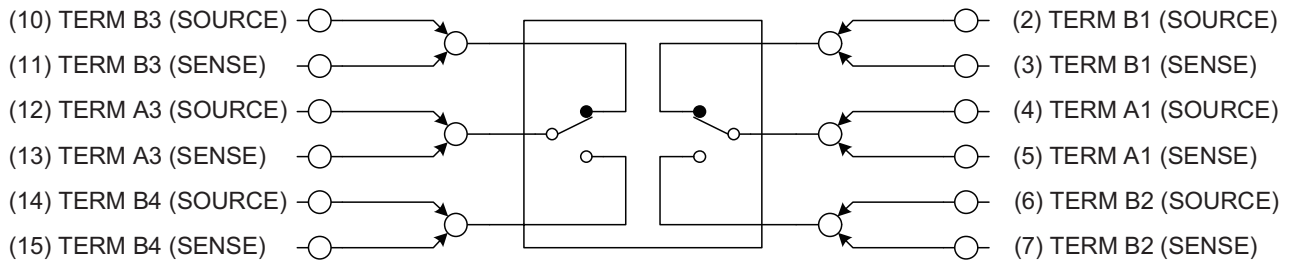

MUX settings

CH	INST.	UNIT	TERM A	TERM B
1	RM3545	UNIT1	1	1
2	RM3545	UNIT1	1	2
3	RM3545	UNIT1	1	1
4	RM3545	UNIT1	1	2
5	RM3545	UNIT1	3	3
6	RM3545	UNIT1	3	4
7	RM3545	UNIT1	3	3
8	RM3545	UNIT1	3	4

(A step scan is used, with switches being switched between channels 2 and 3 and between channels 6 and 7. Open resistance measurement is performed for channels 2, 3, 6, and 7 using the 1000 MΩ range.)

Example motor settings

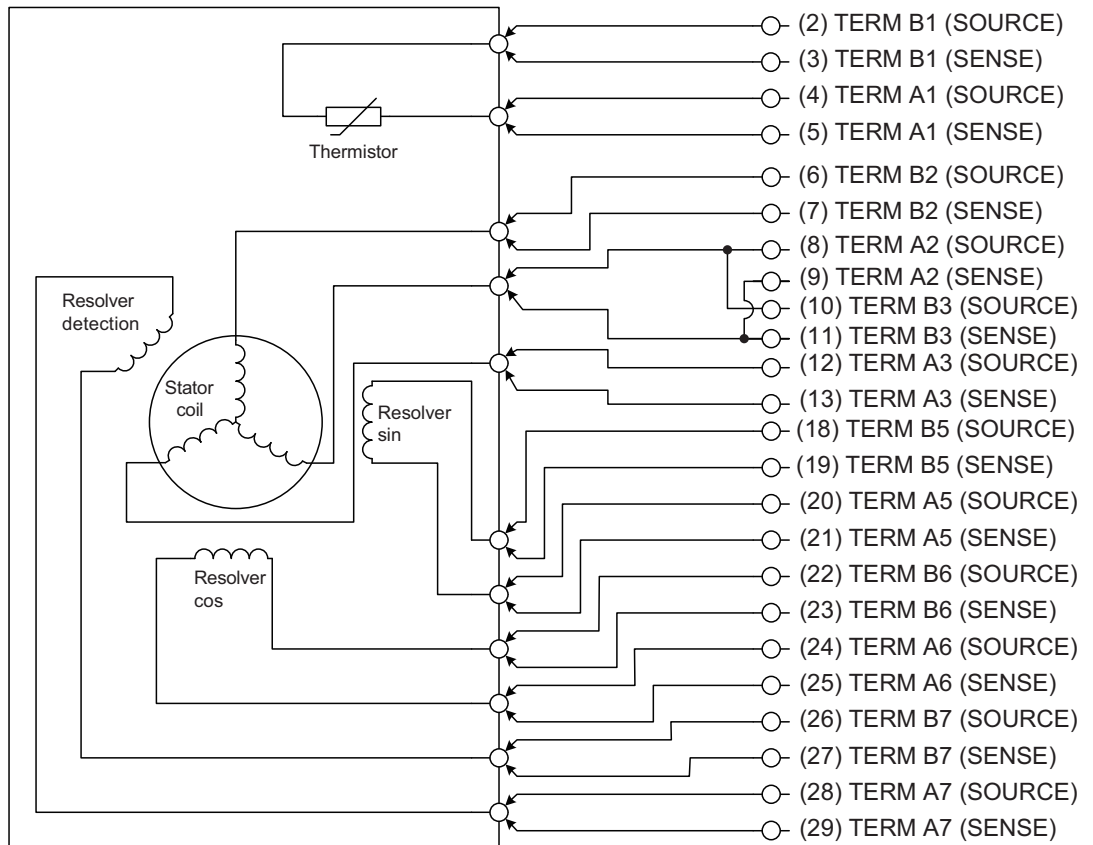

MUX settings

CH	INST.	UNIT	TERM A	TERM B
1	RM3545	UNIT1	1	1
2	RM3545	UNIT1	2	2
3	RM3545	UNIT1	3	3
4	RM3545	UNIT1	3	2
5	RM3545	UNIT1	5	5
6	RM3545	UNIT1	6	6
7	RM3545	UNIT1	7	7

Connecting an external device

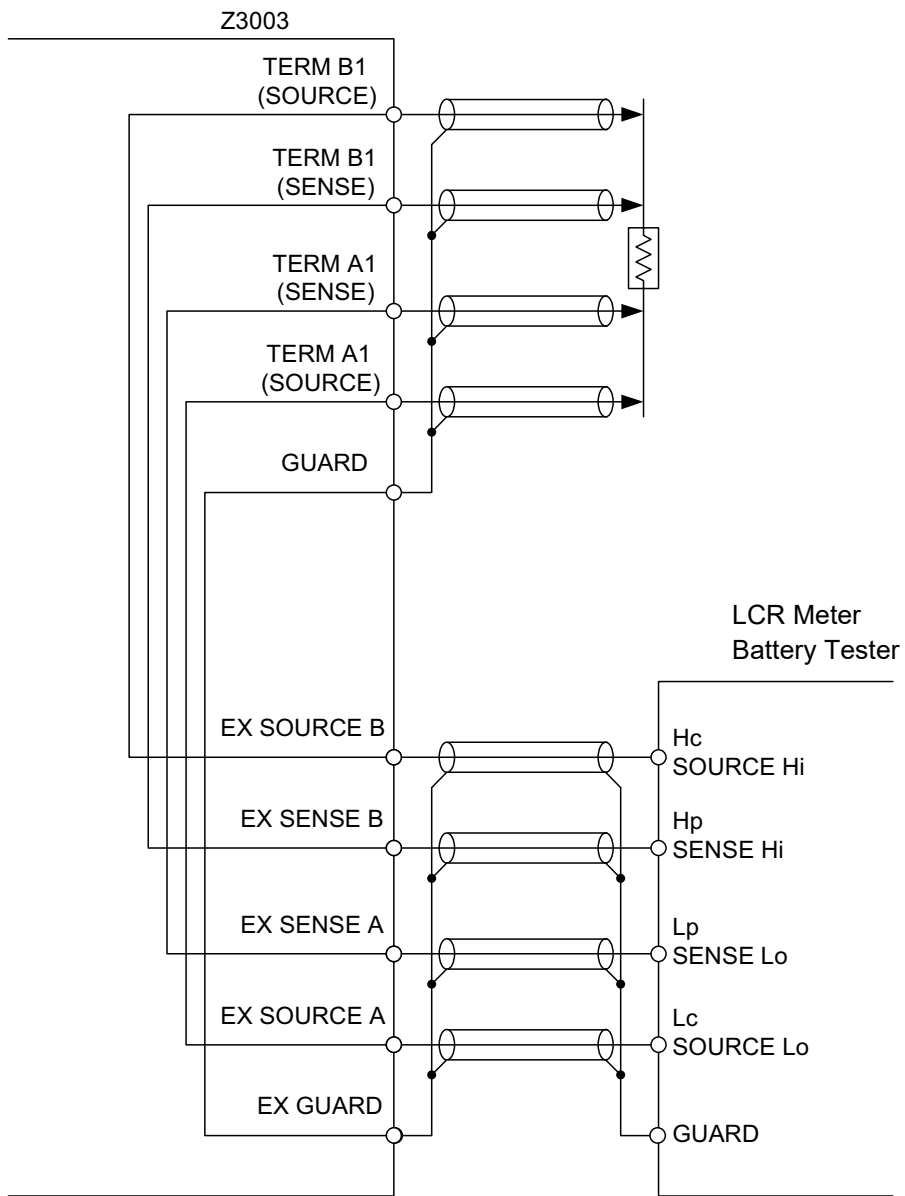

You can switch channels via the front panel, communications, or EXT. I/O when using an external device, too.

8 D/A Output

The RM3545, RM3545-01 and RM3545-02 are capable of generating D/A output for resistance measured values.

By connecting D/A output to a logger or other device, it is possible to easily record variations in resistance values.

8.1 Connecting D/A Output

⚠ WARNING



- Before connecting a device to the D/A output terminal, turn off the main power switches on the instrument and the device being connected, and disconnect the measurement leads from the measurement target.

Failure to do so could cause the operator to experience an electric shock or damage the device.

⚠ CAUTION



- Connect a device with a rated voltage of 5.5 V or more to the D/A output.

The maximum output voltage that can be generated from the D/A output is 5 V. If the rated voltage of the device being connected is less than 5.5 V, the connected device could be damaged.

IMPORTANT

The D/A output terminal is grounded. To reduce accuracy errors, connect a device isolated from the ground circuit to the D/A output.

This section describes how to connect cables to the D/A OUTPUT terminal on the instrument's rear panel.

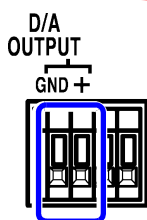
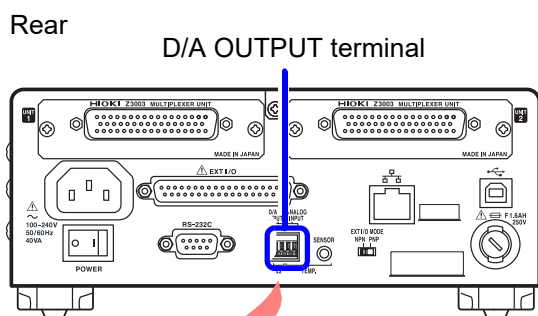

- Compatible wire type : Single wire AWG22 ($\varnothing 0.65$ mm)
Stranded wire AWG22 (0.32 mm²)
Strand diameter $\varnothing 0.12$ mm or more
- Compatible wires : Single wire AWG28 ($\varnothing 0.32$ mm) to AWG22 ($\varnothing 0.65$ mm)
Stranded wire AWG28 (0.08 mm²) to AWG22 (0.32 mm²)
Strand diameter $\varnothing 0.12$ mm or more
- Standard bare wire length : 9 mm to 10 mm

- 1 Push down on the button with a flat-head screwdriver or similar tool.
- 2 Insert the wire into the connection port while holding the button down.
- 3 Release the button to lock the wire in place. A similar procedure can be used to remove the lead.

8.2 D/A Output Specifications

Output	Resistance measured value (display value after zero adjustment and temperature correction but before scaling and ΔT calculation)
Output voltage	0 V DC (corresponds to 0 digit) to 1.5 V DC* ¹ If a measured value fault occurs, 1.5 V; if the measured value is negative, 0 V *1. For a 1,200,000 digits display, corresponds to 1.2 V (1,200,000 digits). For a 120,000 digits display, corresponds to 1.2 V (120,000 digits). For a 12,000 digits display, corresponds to 1.2 V (12,000 digits). For a display in excess of 1.5 V, fixed at 1.5 V.
Maximum output voltage	5 V
Output impedance	1 k Ω
Number of bits	12 bit
Output accuracy	Resistance measurement accuracy $\pm 0.2\%$ of full scale (temperature coefficient $\pm 0.02\%$ of full scale/ $^{\circ}\text{C}$)
Response time	Measurement time + Max. 1 ms Shortest 2.0 ms (tolerance: $\pm 10\% \pm 0.2$ ms) Shortest conditions Trigger source INT, LP: Off, 1000 k Ω or lower range, Measurement speed: FAST, Delay: 0 ms, Self-calibration: MANUAL

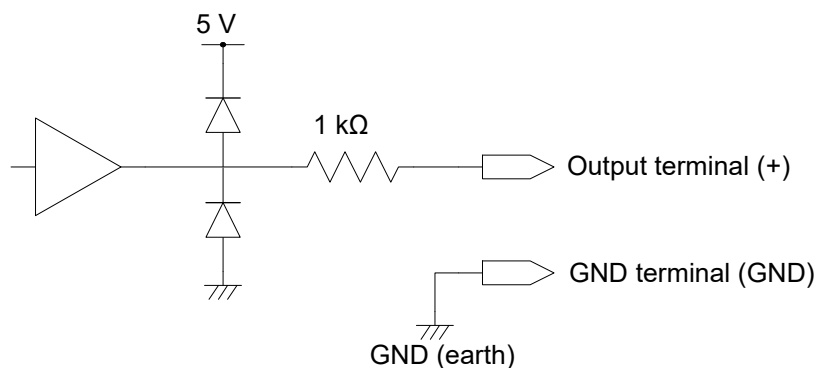

IMPORTANT

- The D/A output's GND pin is connected to the protected earth (to the metallic part of the case).
- The instrument has an output impedance of 1 k Ω . Connected devices must have an input impedance of at least 10 M Ω . (The output voltage is divided by the output resistance and input impedance. For instance, an input impedance of 1 M Ω decreases the output voltage by 0.1%.)
- Connecting a cable may result in external noise. Implement a lowpass filter or other measures as needed in the connected device.
- The output voltage is updated at the resistance measurement sampling timing.
- Output voltage waveforms are stepped (since the output circuit response is extremely fast compared to the update period).
- When using auto-ranging, the same resistance value may result in 1/10 or 10 times the output voltage due to range switching. It is recommend to set the range manually.
- Output is set to 0 V when changing settings (range switching, etc.) or when the instrument is turned off. Additionally, an unstable voltage that is less than or equal to the maximum output voltage is output momentarily when the main power switch on the rear of the instrument is turned on.
- To maximize the D/A output response time, set the measurement speed to FAST and self-calibration to manual.

See: "3.3 Setting the Measurement Speed" (p.50), "4.13 Maintaining Measurement Precision (Self-Calibration)" (p.94)

9 External Control (EXT. I/O)

The EXT. I/O connector on the rear of the instrument supports external control by providing output of the EOM and comparator judgment signals, and accepting input of TRIG and KEY_LOCK signals. All signals are isolated from the measurement circuit and ground (I/O common pins are shared). Input circuit can be switched to accommodate either current sink output (NPN) or current source output (PNP).

Confirm input and output ratings, understand the safety precautions for connecting a control system, and use accordingly.

DANGER



- Do not apply voltage (current) to the EXT. I/O connector that exceeds the maximum input voltage (current).

Doing so could cause damage to the instrument, resulting in serious bodily injury.

WARNING



- Do not supply external power to the instrument's EXT. I/O connector.

External power cannot be supplied to the instrument's EXT. I/O connector. The ISO_5V pin of the EXT. I/O connector is a 5 V (NPN)/ -5 V (PNP) power output terminal. Doing so could damage the product.



- When connecting a device to the instrument's EXT. I/O connector, use screws to secure the connector.

During operation, a connector becoming dislocated and contacting another conductive object could cause an electric shock.

- Follow the steps below before wiring the EXT. I/O connector.

1. Turn off the instrument and the device being connected.
2. Remove any static electricity charged on your body.
3. Confirm that the signals do not exceed the rating for the external I/O.
4. Properly isolate the instrument and the device being connected.

CAUTION



- Do not short ISO_5V and ISO_COM.

Doing so could damage the instrument.



- When connecting a relay coil to the output connector of the EXT. I/O terminal, connect diodes for absorbing the back EMF.

Doing so could damage the instrument.

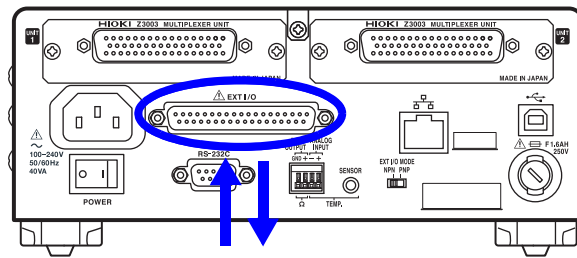

Signal input/output

Check the controller's I/O specifications.



Set the instrument's NPN/PNP switch. (p.187)



Connect the instrument's EXT. I/O connector to the controller. (p.188)



Make instrument settings. (p.217)

9.1 External Input/Output Connector and Signals

Switching between current sink (NPN) and current source (PNP)

The NPN/PNP switch allows you to change the type of programmable logic controller (PLC) that is supported. The instrument ships with the switch set to the NPN position.

See: "9.3 Internal Circuitry" (p.213)



- Turn off the instrument before turning the NPN/PNP switch.
- Configure the NPN/PNP setting to accommodate the externally connected device. Failure to do so could damage the device connected to the EXT. I/O connector.



	NPN/PNP switch setting	
	NPN	PNP
Input circuit	Supports sink output.	Supports source output.
Output circuit	Non-polar	Non-polar
ISO_5V output	+5 V output	-5V output

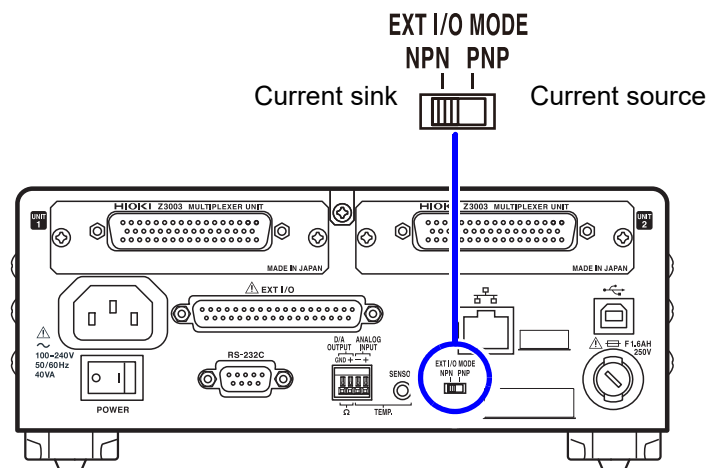

Connector type and signal pinouts

Use of EXT. I/O enables the following control functionality:

- Measurement start (TRIG) → Measurement end (EOM, INDEX)
 - Acquisition of judgment results (HI, IN, LO, ERR, T_ERR, T_PASS, T_FAIL) (T_PASS, T_FAIL, and T_ERR are used only when the scan function is set to auto or step.)
- Measurement start (TRIG) → Measurement end (EOM, INDEX)
 - Acquisition of measured values (BCD_LOW, BCDm-n, RNG_OUTn)
- Panel load (LOAD0 to LOAD5, TRIG)
- Multiplexer channel specification (MUX, LOAD0 to 5, TRIG)
- General-purpose I/O (IN0, IN1, OUT0, OUT1, OUT2)

The functionality described in “Performing an I/O test (EXT. I/O test function)” (p.227) provides a convenient way to check EXT. I/O operation.

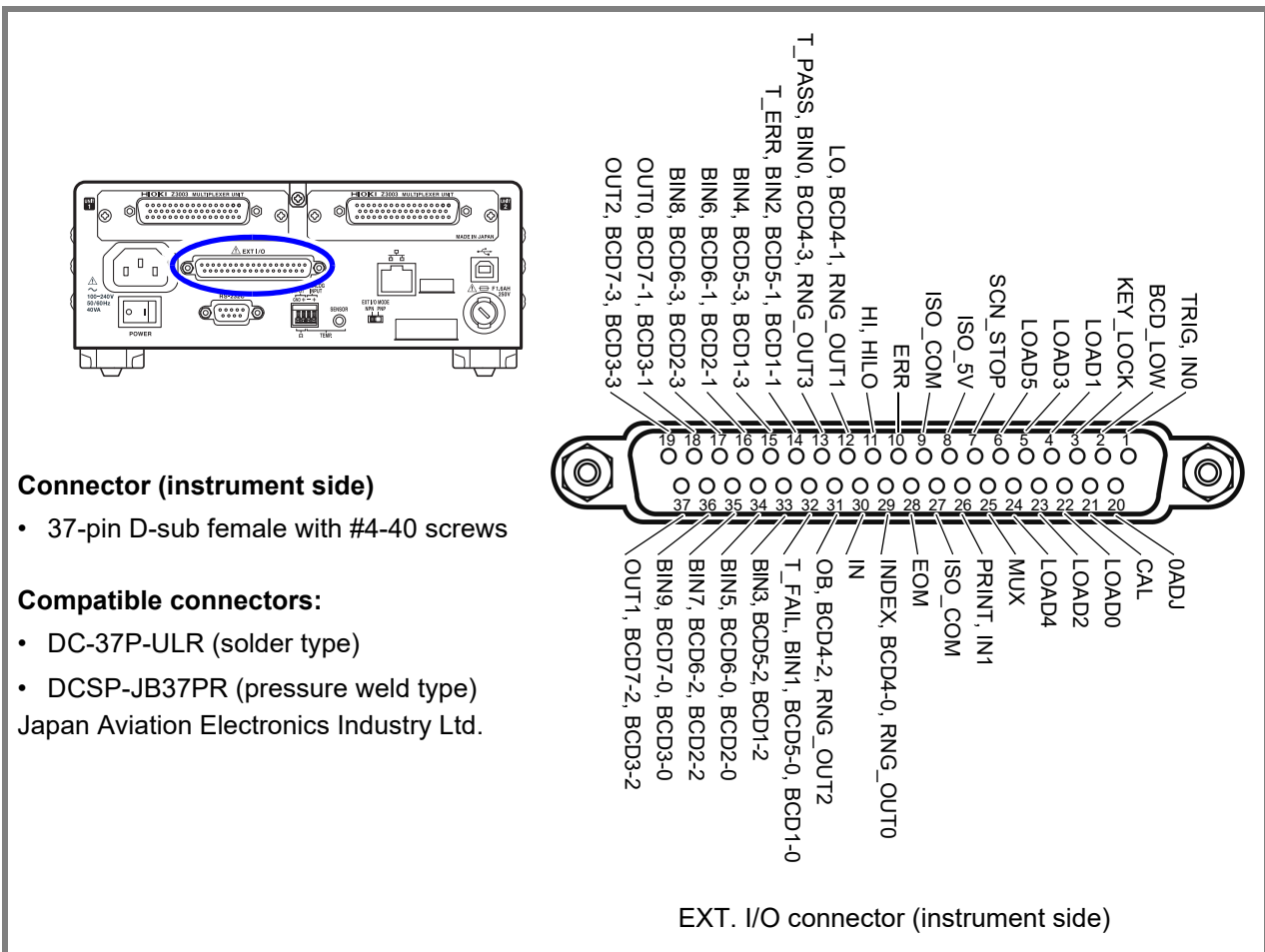

Pin	Signal name	I/O	Function	Logic	Pin	Signal name	I/O	Function	Logic
1	TRIG, IN0	IN	External trigger General-purpose input	Edge	20	0ADJ	IN	Zero adjustment	Edge
2	BCD_LOW	IN	BCD Lower byte output	Level	21	CAL	IN	Self-calibration execution	Edge
3	KEY_LOCK	IN	Key lock	Level	22	LOAD0	IN	Panel load, chan- nel specification	Level
4	LOAD1	IN	Panel load, chan- nel specification	Level	23	LOAD2	IN	Panel load, chan- nel specification	Level
5	LOAD3	IN	Panel load, chan- nel specification	Level	24	LOAD4	IN	Panel load, chan- nel specification	Level
6	LOAD5	IN	Panel load, chan- nel specification	Level	25	MUX	IN	Multiplexer selection	Level
7	SCN_STOP	IN	Scan stop	Edge	26	PRINT, IN1	IN	Measured value printing General-pur- pose input	Edge
8	ISO_5V	-	Isolated power supply +5 V (-5 V) output	-	27	ISO_COM	-	Isolated power supply Common	-
9	ISO_COM	-	Isolated power supply Common	-	28	EOM	OUT	End of measure- ment	Level
10	ERR	OUT	Measurement fault	Level	29	INDEX, BCD4-0, RNG_OUT0	OUT	Analog measure- ment finished BCD	Level
11	HI, HILO	OUT	Comparator judg- ment	Level	30	IN	OUT	Comparator judg- ment	Level
12	LO, BCD4-1, RNG_OUT1	OUT	Comparator judg- ment BCD	Level	31	OB, BCD4-2, RNG_OUT2	OUT	BIN judgment BCD	Level
13	T_PASS, BIN0, BCD4-3, RNG_OUT3	OUT	Total judgment BIN judgment BCD	Level	32	T_FAIL, BIN1, BCD5-0, BCD1-0	OUT	Total judgment BIN judgment BCD	Level
14	T_ERR, BIN2, BCD5-1, BCD1-1	OUT	Total judgment BIN judgment BCD	Level	33	OVR_IN- PUT,BIN3, BCD5-2, BCD1-2	OUT	BIN judgment BCD	Level
15	BIN4, BCD5-3, BCD1-3	OUT	BIN judgment BCD	Level	34	BIN5, BCD6-0, BCD2-0	OUT	BIN judgment BCD	Level
16	BIN6, BCD6-1, BCD2-1	OUT	BIN judgment BCD	Level	35	BIN7, BCD6-2, BCD2-2	OUT	BIN judgment BCD	Level
17	BIN8, BCD6-3, BCD2-3	OUT	BIN judgment BCD	Level	36	BIN9, BCD7-0, BCD3-0	OUT	BIN judgment BCD	Level
18	OUT0, BCD7-1, BCD3-1	OUT	General-purpose output BCD	Level	37	OUT1, BCD7-2, BCD3-2	OUT	General-pur- pose output BCD	Level
19	OUT2, BCD7-3, BCD3-3	OUT	General-purpose output BCD	Level					

IMPORTANT

- Only the RM3545A-2 can be used for multiplexer-related control.
- The 0ADJ signal should be asserted (on) for at least 10 ms.
- The connector's frame is connected to the instrument's rear panel (metal portions) as well as the power inlet's protective ground terminal.
- When switching the panel load or multiplexer channel using a command or key operation, fix pins 4 to 6 and 22 to 24 to on or off.

Signal descriptions

(1) Isolated power supply

Pin	Signal name	NPN/PNP switch setting	
		NPN	PNP
8	ISO_5V	Isolated power supply +5 V	Isolated power supply -5V
9, 27	ISO_COM	Isolated common signal ground	

(2) Input signals

TRIG	<p>The TRIG signal operates at either the on or off edge. On or off edge triggering can be selected on the EXT. I/O Setting screen (default: On edge).</p> <ul style="list-style-type: none"> • When external triggering [EXT] is enabled The TRIG signal causes one measurement to be performed. • When internal triggering [INT] is enabled The TRIG signal does not trigger measurement. <p>A wait is necessary to allow the measured value to stabilize after switching ranges or loading a panel. The wait time varies with the measurement target.</p> <p>After TRIG signal input, statistical calculations for the most recently updated measured value (p.112) and data memory (p.247) are performed. Trigger input can also be performed using the ENTER (trigger) key or the *TRG command.</p>	<p>p.219</p> <p>p.86</p>
0ADJ	<p>When the 0ADJ signal is switched from off to on, one zero adjustment operation will be performed at the signal edge. <u>To avoid malfunction, this signal should be asserted (on) for at least 10 ms.</u></p> <p>The ERR signal turns on when zero adjustment fails.</p>	p.69
PRINT	<p>Asserting the PRINT signal prints the current measured value.</p>	p.253
CAL	<p>When the CAL signal is changed from off to on while using the manual self-calibration setting, self-calibration will start at that edge. The signal will be disabled when using auto self-calibration.</p> <p>The time required for self-calibration is approximately 400 ms.</p> <p>If asserted during measurement, executes after the end of measurement.</p>	p.94
KEY_LOCK	<p>While the KEY_LOCK signal is held on, all front panel keys (except STANDBY key and ENTER [trigger] key) are disabled. Key unlock and remote control cancellation operations are also disabled.</p>	p.130

MUX	The function of the LOAD signal (pins 4, 5, 6, 22, 23, 24) changes depending on the MUX signal.	p.194
SCN_STOP	<p>Serves as the channel reset signal. This signal is enabled only when the scan function is set to auto or step.</p> <p>When the scan function is set to auto: A scan stop reservation is made when the SCN_STOP signal changes to on, and scanning is stopped at the completion of measurement. Measurement starts from the initial channel the next time the TRIG signal turns on. To prevent erroneous operation, hold the on state for at least 5 ms.</p> <p>When the scan function is set to step: When the SCN_STOP function changes to on while the instrument is in the TRIG signal standby state, the initial channel is measured the next time the TRIG signal turns on. To prevent erroneous operation, hold the on state for at least 5 ms.</p>	p.154
BCD_LOW	When used with the BCD output setting, turning the BCD_LOW signal off causes the higher digits to be output. Turn the BCD_LOW signal ON causes the lower digits and range information to be output.	p.193
LOAD0 to LOAD5	<p>Selecting the panel number to load and the multiplexer channel and then inputting the TRIG signal causes the instrument to load the selected panel and channel number, switch to the channel, and perform measurement. LOAD0 is the LSB, and LOAD5 is the MSB. For more information, see “(4) Signal correspondence chart” (p.194).</p> <p>If LOAD0 to LOAD5 are the same as the previous load operation when the TRIG signal is input, measurement will be performed once if using external triggering, but the panel load operation and channel switching operation will not be performed.</p> <p>If any of the LOAD signals changes to the enabled state and there are no changes for an interval of 10 ms, the panel load operation or channel switching operation will be performed even if the TRIG signal is not input. Do not change the LOAD0 to 5 signals until load operation and channel switching operation are complete.</p> <p>LOAD signals are also enabled when controlling the instrument via communications (remotely). All key operation is disabled when the LOAD signal for a valid panel number and channel number is on.</p> <p>When loading panels or switching channels using commands or key operation, fix pins 4 to 6 as well as 22 to 24 to either on or off.</p> <p>When the scan function is set to auto or step, the channel cannot be changed with the LOAD0 to LOAD5 signals.</p> <p>If you attempt to switch to the multiplexer while measurement leads are connected to the measurement terminals on the front of the instrument, the ERR signal will turn on, and you will not be able to make the switch. Disconnect the measurement leads and switch the LOAD signal again.</p>	p.194
IN0, IN1	<p>The input state can be monitored by using the <code>:IO:INPut?</code> command, using these pins as general-purpose input pins.</p> <p>See: Communications Command Instruction Manual*1.</p>	

*1. The Instruction Manual can be downloaded from Hioki's website.

<https://www.hioki.com/global/support/download/>

(3) Output signals

EOM	This signal indicates the end of measurement and zero adjustment. At this point in time, the comparator judgment results and the ERR, BCD and BIN signals have been finalized.	p.223
INDEX	This signal indicates that A/D conversion in the measurement circuit is finished. When the asserted (on) state occurs, the measurement target can be removed.	
ERR	This signal indicates that a measurement fault has occurred (except out-of-range detection). It is updated simultaneously with the EOM signal. At this time, comparator judgment outputs are all de-asserted (off).	p.56
HI, IN, LO	These are the comparator judgment output signals.	
HILO	When using BCD output, pin 11 outputs the result of an OR operation applied to the Hi and Lo judgments.	
T_PASS, T_FAIL, T_ERR	These are the total judgment results. They are valid only when the scan function is set to auto or step.	p.162
BCDm-n	When using BCD output, this signal outputs n bits of digit m. (When BCD1-x is the lowermost digit, BCDx-0 is the LSB.) When the measured value display is “OvrRng”, “CONTACT TERM”, or “-----”, all digits of BCD output will be 9. When the measured value display is a negative value, all digits of BCD output will be 0. When the lower limit value has been set to 0 and a negative measured value is encountered, the LO signal will be output in accordance with the display screen result. However, when using the comparator's REF% mode, an unsigned value equivalent to the absolute value being displayed (i.e., an absolute value) will be output.	p.195
OB, BIN0 to BIN9	When BIN output has been configured, the BIN judgment results will be output from pins 13 to 17 and pins 31 to 36. When the results do not correspond to BIN0 to BIN9, OB will turn on.	
OUT0 to OUT2	When the output mode is judgment mode, pins 18, 19 and 37 can be used as general-purpose output pins. The output signals can be controlled with the :IO:OUT-Put command. See: Communications Command Instruction Manual*1.	p.225
RNG_OUT0 to RNG_OUT3	When BCD_LOW is turned ON when using BCD output, range information can be acquired from pins 12, 13, 29, and 31.	p.195

*1. The Instruction Manual can be downloaded from Hioki's website.

<https://www.hioki.com/global/support/download/>

IMPORTANT

- When not displaying the Measurement screen and while error messages (except Setting Monitor errors) are being displayed, input signals are disabled.
- EXT. I/O input and output signals are not usable while changing measurement settings.

JUDGE mode and BCD mode

Output signals operate under either JUDGE mode or BCD mode.

JUDGE mode: Outputs the total judgment or the BIN judgment (p.109).

BCD*1 mode: Outputs a binary representation of the displayed measured value from the EXT. I/O terminal.

The JUDGE mode output signals vary depending on whether the multiplexer is being used. In BCD mode, signals are used for both the upper and lower digits (and range information).

See: "Switching output modes (JUDGE mode/ BCD mode)" (p.225)

*1. Binary coded decimal

Pin functions in JUDGE mode

When the multiplexer is not being used

Pin	Function	Pin	Function
9	ISO_COM	28	EOM
10	ERR	29	INDEX
11	HI	30	IN
12	LO	31	OB
13	BIN0	32	BIN1
14	BIN2	33	BIN3
15	BIN4	34	BIN5
16	BIN6	35	BIN7
17	BIN8	36	BIN9
18	OUT0	37	OUT1
19	OUT2		

When the multiplexer is being used

Pin	Function	Pin	Function
9	ISO_COM	28	EOM
10	ERR	29	INDEX
11	HI	30	IN
12	LO	31	-
13	T_PASS	32	T_FAIL
14	T_ERR	33	-
15	-	34	-
16	-	35	-
17	-	36	-
18	OUT0	37	OUT1
19	OUT2		

Pin functions in BCD mode

When used with the BCD output setting, turning the BCD_LOW signal off causes the higher digits to be output. Turn the BCD_LOW signal on causes the lower digits and range information to be output. (p.188) (p.191)

Pin	BCD_LOW		Pin	BCD_LOW	
	OFF	ON		OFF	ON
9	ISO_COM		28	EOM	
10	ERR		29	BCD4-0	RNG_OUT0
11	HILO		30	IN	
12	BCD4-1	RNG_OUT1	31	BCD4-2	RNG_OUT2
13	BCD4-3	RNG_OUT3	32	BCD5-0	BCD1-0
14	BCD5-1	BCD1-1	33	BCD5-2	BCD1-2
15	BCD5-3	BCD1-3	34	BCD6-0	BCD2-0
16	BCD6-1	BCD2-1	35	BCD6-2	BCD2-2
17	BCD6-3	BCD2-3	36	BCD7-0	BCD3-0
18	BCD7-1	BCD3-1	37	BCD7-2	BCD3-2
19	BCD7-3	BCD3-3			

Relation between BCD signals and display

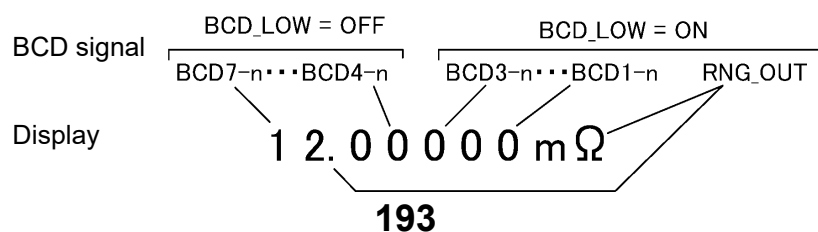

(4) Signal correspondence chart

LOAD0 to LOAD5

LOAD5	LOAD4	LOAD3	LOAD2	LOAD1	LOAD0	MUX signal OFF	MUX signal ON
OFF	OFF	OFF	OFF	OFF	OFF	-	-
OFF	OFF	OFF	OFF	OFF	ON	Panel 1	Channel 1
OFF	OFF	OFF	OFF	ON	OFF	Panel 2	Channel 2
OFF	OFF	OFF	OFF	ON	ON	Panel 3	Channel 3
OFF	OFF	OFF	ON	OFF	OFF	Panel 4	Channel 4
OFF	OFF	OFF	ON	OFF	ON	Panel 5	Channel 5
OFF	OFF	OFF	ON	ON	OFF	Panel 6	Channel 6
OFF	OFF	OFF	ON	ON	ON	Panel 7	Channel 7
OFF	OFF	ON	OFF	OFF	OFF	Panel 8	Channel 8
OFF	OFF	ON	OFF	OFF	ON	Panel 9	Channel 9
OFF	OFF	ON	OFF	ON	OFF	Panel 10	Channel 10
OFF	OFF	ON	OFF	ON	ON	Panel 11	Channel 11
OFF	OFF	ON	ON	OFF	OFF	Panel 12	Channel 12
OFF	OFF	ON	ON	OFF	ON	Panel 13	Channel 13
OFF	OFF	ON	ON	ON	OFF	Panel 14	Channel 14
OFF	OFF	ON	ON	ON	ON	Panel 15	Channel 15
OFF	ON	OFF	OFF	OFF	OFF	Panel 16	Channel 16
OFF	ON	OFF	OFF	OFF	ON	Panel 17	Channel 17
OFF	ON	OFF	OFF	ON	OFF	Panel 18	Channel 18
OFF	ON	OFF	OFF	ON	ON	Panel 19	Channel 19
OFF	ON	OFF	ON	OFF	OFF	Panel 20	Channel 20
OFF	ON	OFF	ON	OFF	ON	Panel 21	Channel 21
OFF	ON	OFF	ON	ON	OFF	Panel 22	Channel 22
OFF	ON	OFF	ON	ON	ON	Panel 23	Channel 23
OFF	ON	ON	OFF	OFF	OFF	Panel 24	Channel 24
OFF	ON	ON	OFF	OFF	ON	Panel 25	Channel 25
OFF	ON	ON	OFF	ON	OFF	Panel 26	Channel 26
OFF	ON	ON	OFF	ON	ON	Panel 27	Channel 27
OFF	ON	ON	ON	OFF	OFF	Panel 28	Channel 28
OFF	ON	ON	ON	OFF	ON	Panel 29	Channel 29
OFF	ON	ON	ON	ON	OFF	Panel 30	Channel 30
OFF	ON	ON	ON	ON	ON	-	Channel 31
ON	OFF	OFF	OFF	OFF	OFF	-	Channel 32
ON	OFF	OFF	OFF	OFF	ON	-	Channel 33
ON	OFF	OFF	OFF	ON	OFF	-	Channel 34
ON	OFF	OFF	OFF	ON	ON	-	Channel 35
ON	OFF	OFF	ON	OFF	OFF	-	Channel 36
ON	OFF	OFF	ON	OFF	ON	-	Channel 37
ON	OFF	OFF	ON	ON	OFF	-	Channel 38
ON	OFF	OFF	ON	ON	ON	-	Channel 39
ON	OFF	ON	OFF	OFF	OFF	-	Channel 40
ON	OFF	ON	OFF	OFF	ON	-	Channel 41
ON	OFF	ON	OFF	ON	OFF	-	Channel 42
ON	OFF	ON	OFF	ON	ON	-	-
ON	OFF	ON	ON	OFF	OFF	-	-
ON	OFF	ON	ON	OFF	ON	-	-
ON	OFF	ON	ON	ON	OFF	-	-
ON	OFF	ON	ON	ON	ON	-	-
ON	ON	OFF	OFF	OFF	OFF	-	-
ON	ON	OFF	OFF	OFF	ON	-	Panel 31
ON	ON	OFF	OFF	ON	OFF	-	Panel 32
ON	ON	OFF	OFF	ON	ON	-	Panel 33
ON	ON	OFF	ON	OFF	OFF	-	Panel 34

LOAD5	LOAD4	LOAD3	LOAD2	LOAD1	LOAD0	MUX signal OFF	MUX signal ON
ON	ON	OFF	ON	OFF	ON	-	Panel 35
ON	ON	OFF	ON	ON	OFF	-	Panel 36
ON	ON	OFF	ON	ON	ON	-	Panel 37
ON	ON	ON	OFF	OFF	OFF	-	Panel 38
ON	ON	ON	OFF	OFF	ON	-	-
ON	ON	ON	OFF	ON	OFF	-	-
ON	ON	ON	OFF	ON	ON	-	-
ON	ON	ON	ON	OFF	OFF	-	-
ON	ON	ON	ON	OFF	ON	-	-
ON	ON	ON	ON	ON	OFF	-	-
ON	ON	ON	ON	ON	ON	-	-

RNG_OUT0 to RNG_OUT3 (when the BCD_LOW signal is ON)

RNG_OUT3	RNG_OUT2	RNG_OUT1	RNG_OUT0	Range
OFF	OFF	OFF	OFF	1000 $\mu\Omega$
				PR 1000 $\mu\Omega$
OFF	OFF	OFF	ON	10 m Ω
				PR 10 m Ω
OFF	OFF	ON	OFF	100 m Ω
				PR 100 m Ω
OFF	OFF	ON	ON	1000 m Ω
				LP 1000 m Ω
OFF	ON	OFF	OFF	10 Ω
				LP 10 Ω
OFF	ON	OFF	ON	100 Ω
				LP 100 Ω
OFF	ON	ON	OFF	1000 Ω
				LP 1000 Ω
OFF	ON	ON	ON	10 k Ω
ON	OFF	OFF	OFF	100 k Ω
ON	OFF	OFF	ON	1000 k Ω
ON	OFF	ON	OFF	10 M Ω
ON	OFF	ON	ON	100 M Ω
ON	ON	OFF	OFF	1000 M Ω

BCDm-0 to BCDm-3

BCDm-3	BCDm-2	BCDm-1	BCDm-0	Measured value
OFF	OFF	OFF	OFF	0
OFF	OFF	OFF	ON	1
OFF	OFF	ON	OFF	2
OFF	OFF	ON	ON	3
OFF	ON	OFF	OFF	4
OFF	ON	OFF	ON	5
OFF	ON	ON	OFF	6
OFF	ON	ON	ON	7
ON	OFF	OFF	OFF	8
ON	OFF	OFF	ON	9

9.2 Timing Chart

Each signal level indicates the On/Off state of a contact. When using the current source (PNP) setting, the level is the same as the EXT. I/O terminal voltage level. When using the current sink (NPN) setting, the high and low voltage levels are reversed.

From start of measurement to acquisition of judgment results

(1) External trigger [EXT] setting (EOM output timing setting: HOLD)

When OVC is OFF

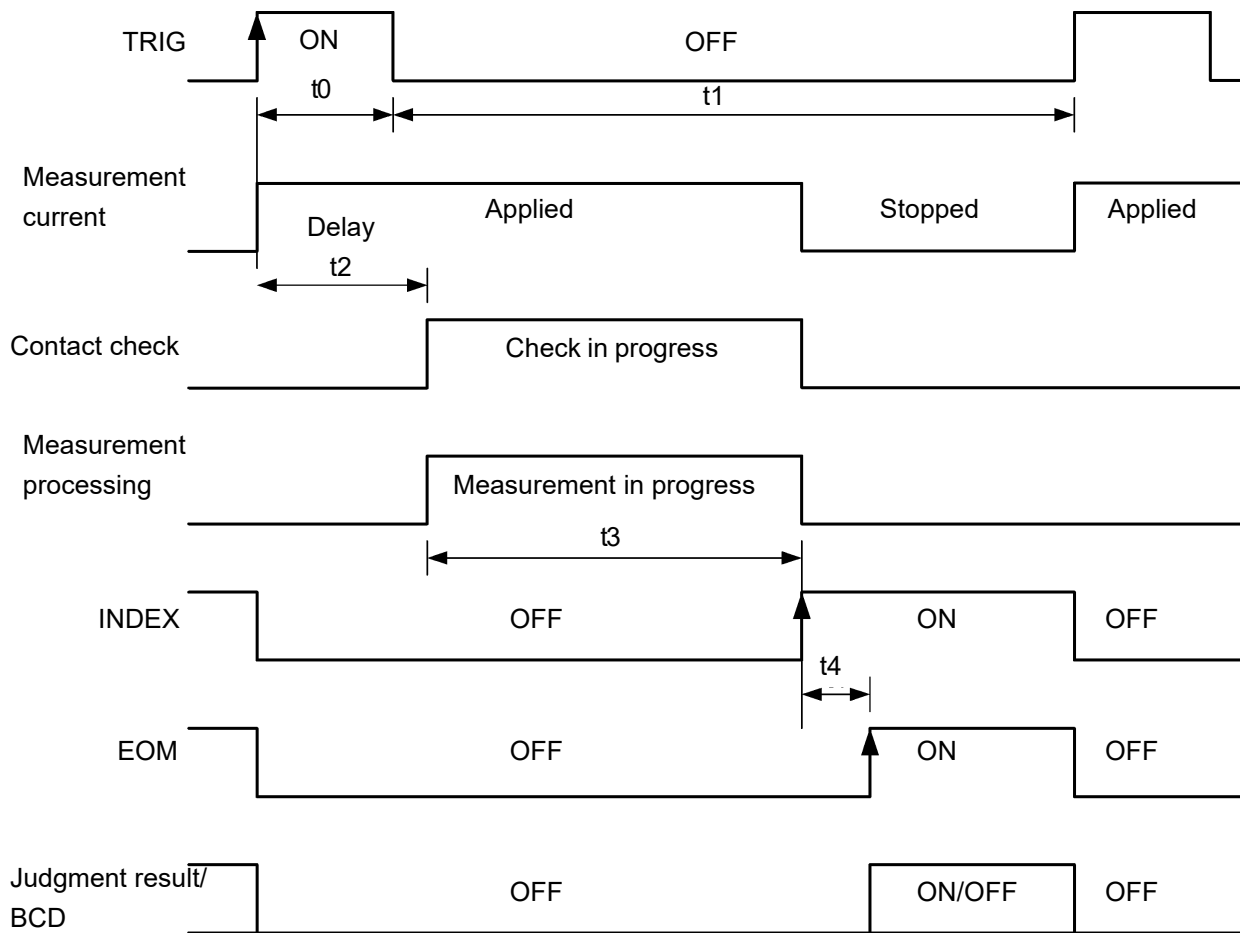

Judgment result /BCD: HI, IN, LO, ERR, BCDm-n, RNG_OUT0 to 3

When OVC is ON

The  portion of the chart is repeated for each averaging iteration.

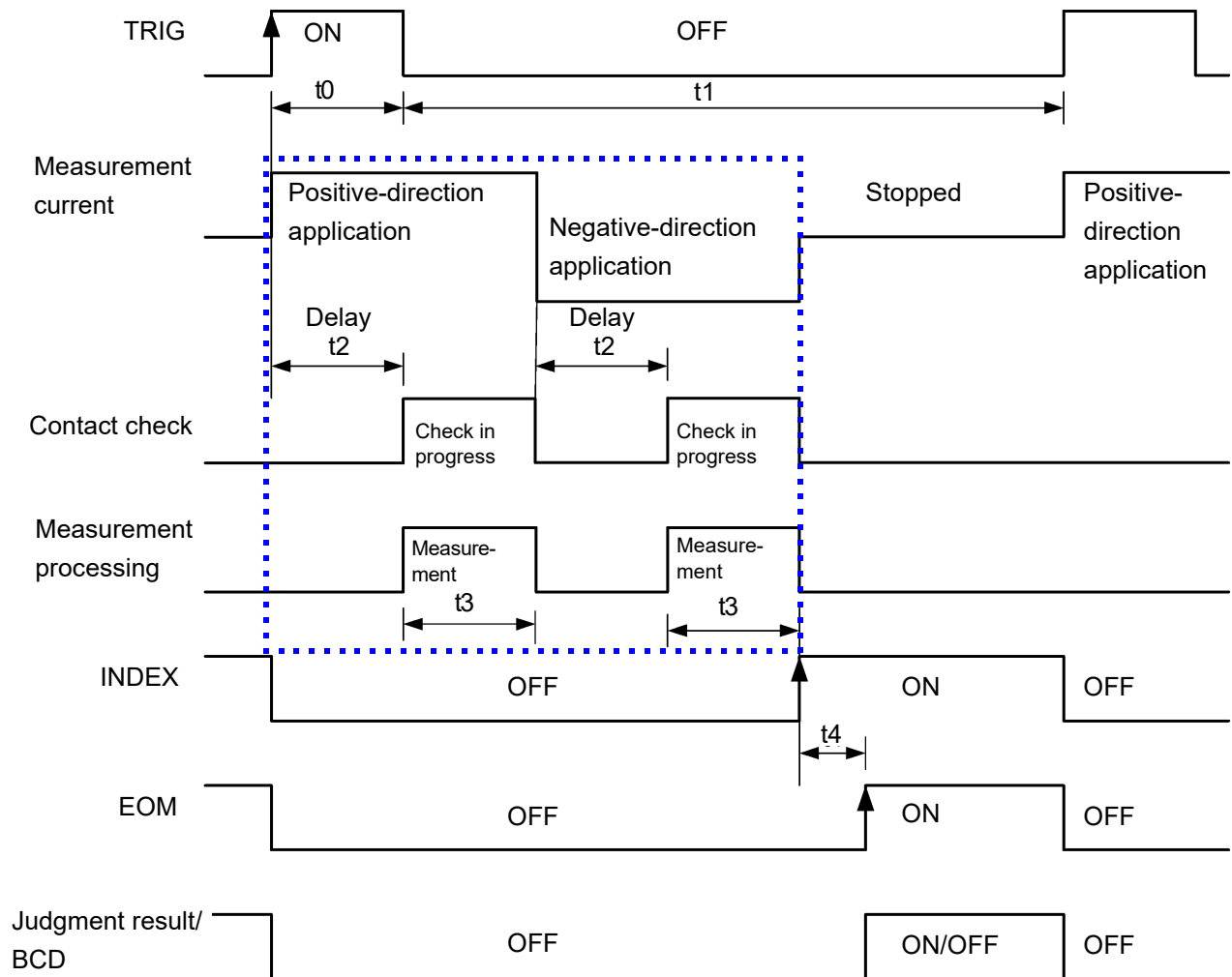

Judgment result /BCD: HI, IN, LO, ERR, BCDm-n, RNG_OUT0 to 3

IMPORTANT

- The measurement current will not be stopped for measurement ranges of 10 kΩ and greater (continuous application).
- If the TRIG signal is input during measurement (while the EOM signal is off), a single hold based on the TRIG signal will result. As soon as the EOM signal turns on, the measurement that had been on hold will start. The TRIG signal is held during self-calibration.
See: "Self-calibration timing" (p.202)
- When changing settings such as measurement range, allow processing time (100 ms) before applying a TRIG signal.
- When not displaying the Measurement screen or while error messages are being displayed, input signals are disabled.
- The judgment result and BCD output are finalized before the EOM signal changes to on. However, if the controller's input circuit response is slow, it may be necessary to insert wait processing after the EOM signal's changing to on is detected until the judgment results are acquired.

(2) External trigger [EXT] setting (EOM output timing setting: PULSE)

The EOM signal turns on at the end of measurement and then reverts to the OFF state once the time (t_5) that has been set as the EOM pulse width elapses.

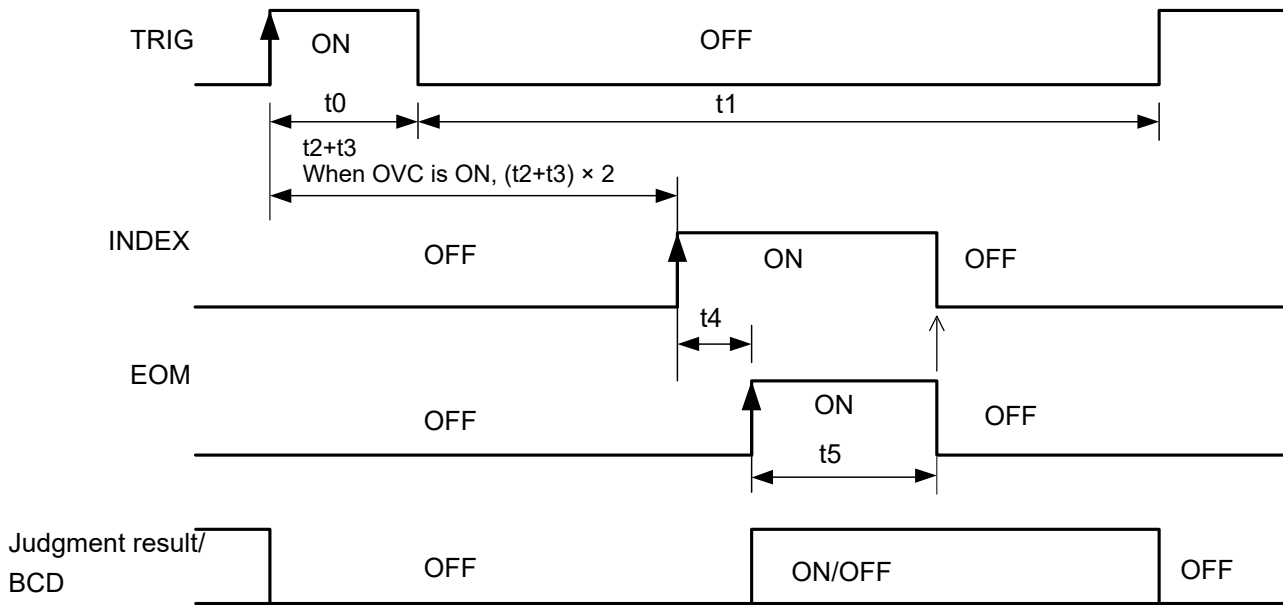

Judgment result /BCD: HI, IN, LO, ERR, BCDm-n, RNG_OUT0 to 3

See: "Setting EOM signal" (p.223)

When the TRIG signal is input while the EOM signal is on, the EOM signal will turn off once measurement processing is started in response to the TRIG signal.

(3) Internal trigger [INT] setting

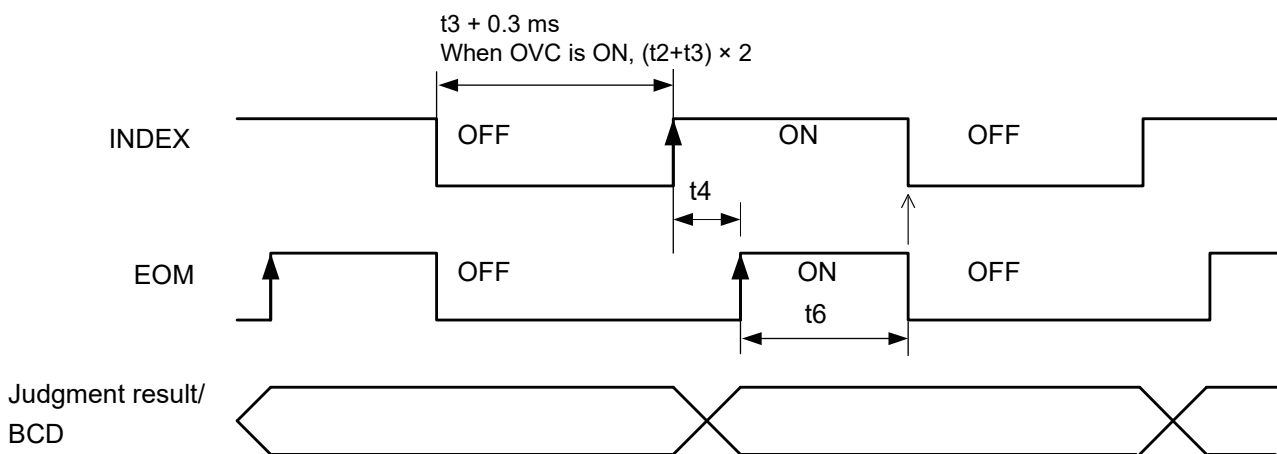

Judgment result /BCD: HI, IN, LO, ERR, BCDm-n, RNG_OUT0 to 3

When using the internal trigger [INT] setting, the EOM signal consists of pulse output with a width of 5 ms. However, EOM will be held at on while ERR is on. The judgment result and ERR signals do not turn off at the start of measurement.

IMPORTANT
 Setting self-calibration to MANUAL results in the fastest measurement.
 The t_6 interval will be 0 ms, and the EOM signal will remain off.

Timing Chart Interval Descriptions

Interval	Description	Time	Remarks
t0	Trigger Pulse Asserted (ON)	0.1 ms or more	ON/ OFF-edge selectable
t1	Trigger Pulse Asserted (OFF)	1 ms or more	
t2	Delay	0 to 9999 ms	Setting-dependent
t3	Acquisition processing time	Integration time + Internal wait time (See reference values on the following page.)	
t4	Calculation time	0.1 ms	Calculation time is longer when memory storage and statistical calculations are enabled.
t5	EOM pulse width	1 ms to 100 ms	Setting-dependent
t6	EOM pulse width with internal trigger	5 ms	Cannot be changed.

The measurement time (from trigger input to EOM on) can be calculated as follows:

- When OVC is off

$$td + (t2 + t3) \times na + t4$$

- When OVC is on

$$td + (t2 + t3 + t2 + t3) \times na + t4$$

td : Trigger detection time (On edge: max. 0.1 ms; Off edge: max. 0.3 ms)

na : Number of average iterations (however, during free-run*¹ operation with the INT trigger source, 1 iteration)

Note that when using the SLOW2 measurement speed with low-power resistance measurement on, the instrument will perform averaging with two iterations internally even if the averaging function is set to off. If the averaging function is on, the instrument will perform averaging using the set number of iterations.

Measurement times may vary depending on the self-calibration timing.

See: "Self-calibration timing" (p.202)

- *1. When not using the **INITiate:CONTinuous OFF** or **READ?** command

For more information about commands, see the Communications Command Instruction Manual.

The Instruction Manual can be downloaded from Hioki's website.

<https://www.hioki.com/global/support/download/>

Integration time reference values (unit: ms)

LP	Range	FAST		MEDIUM		SLOW1	SLOW2
		50 Hz	60 Hz	50 Hz	60 Hz		
OFF	1000 kΩ or less	0.3*1		20.0	16.7	100	200
	10 MΩ or more	20.0	16.7	20.0	16.7	100	200
ON	All ranges	20.0	16.7	40.0	33.3	200	300

*1. When using the MUX measurement terminals, the integration time is 1.0 ms in the 1000 μΩ range and 10 mΩ range.

Internal wait time (unit: ms) (Processing time before and after integration measurement) reference values

- When the trigger source is set to INT and OVC is off

Time
0.4

- Other

LP: Off and PR: Off

Range	Measurement current	Time	100 MΩ range High-precision mode	
1000 μΩ	High	40	-	
10 mΩ	High	40		
100 mΩ	High	40		
	Low	2.4		
1000 mΩ	High	2.6		
	Low	1.6		
10 Ω	High	1.8		
	Low	2.1		
100 Ω	High	1.9		
	Low	2.4		
1000 Ω	-	2.4		
10 kΩ		6.0		
100 kΩ		16		
1000 kΩ		130		
10 MΩ		500		
100 MΩ		1300		ON
		320		OFF
1000 MΩ		340	OFF	

PR: On

Range	Measurement current	Time
PR1000 μΩ	High	20
PR10 mΩ	High	20
PR100 mΩ	-	20

LP: On

Range	Time
LP1000 mΩ	15
LP10 Ω	35
LP100 Ω	35
LP1000 Ω	36

BCD signal timing

BCDm-n signal transition time based on the BCD_LOW signal

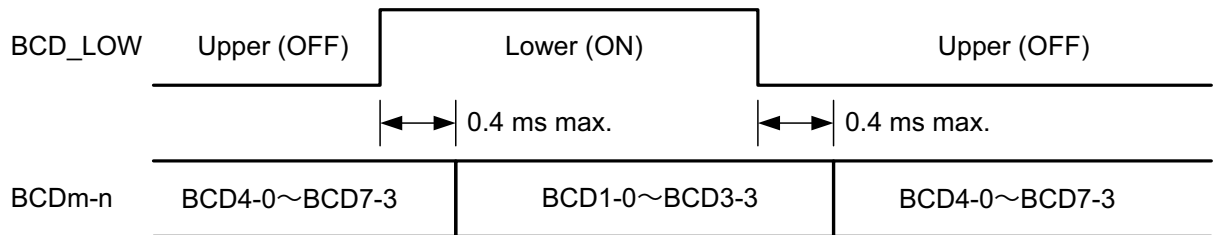

If the response of the input circuit in the controller is slow, inserting more than 0.4 ms of wait processing may be required after the BCD_LOW signal is controlled.

Zero adjustment timing

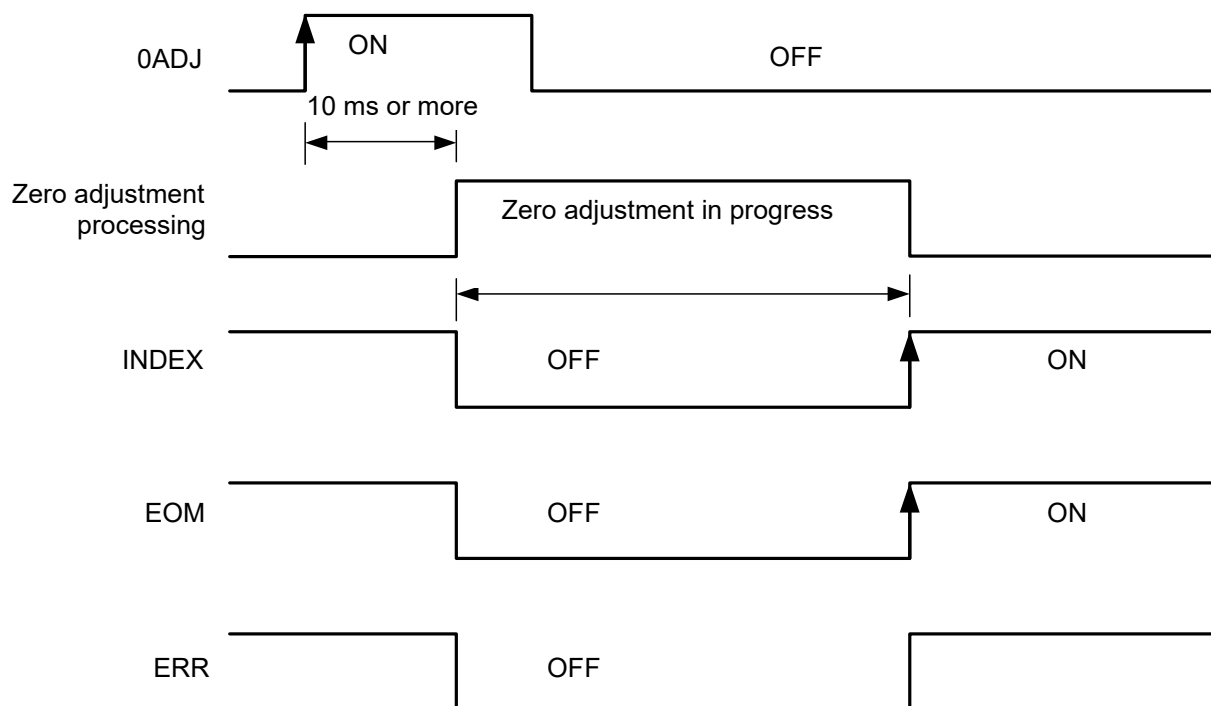

- For pulse EOM output, the EOM signal turns off when the pulse width time elapses.
- When using the internal trigger [INT] setting, the EOM signal consists of pulse output with a width of 5 ms. The ERR signals do not turn off at the start of measurement. They are updated at the completion of the next measurement.
- When not using the multiplexer, the zero adjustment time is approximately 600 ms when using a manually set range and approximately 4 s when using auto-ranging. When performing scanning zero adjustment while using the multiplexer, the zero adjustment time will elapse for each channel.

Self-calibration timing

For information about the self-calibration function, see p.94.

To maintain measurement precision, the instrument self-calibrates to compensate for internal circuit offset voltage and gain drift.

You can select between two self-calibration function execution methods.

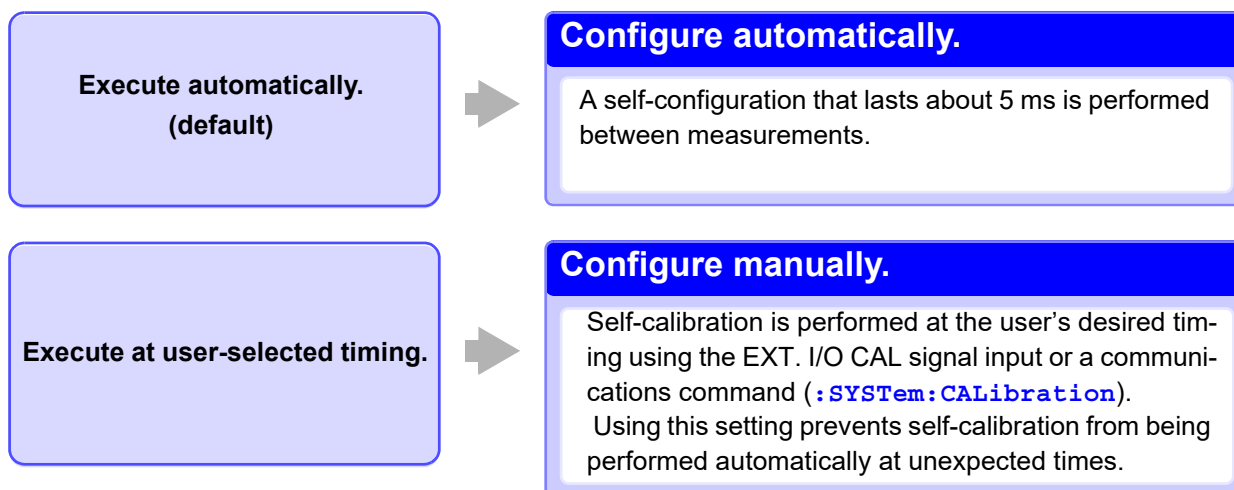

Self-calibration timing and intervals

Setting	Calibration timing	Measurement hold interval (calibration interval)
Auto* ¹	After measurement	5 ms
Manual	During execution	400 ms

*1. When using the auto setting

When using the auto setting, self-calibration is performed for 5 ms once every second during TRIG standby operation. In the event the TRIG signal is received during a 5 ms self-calibration, the self-calibration is canceled, and measurement will start after 0.5 ms. If you are concerned about variation in measurement times, please use the manual setting.

Auto setting operation

Self-calibration starts immediately after measurement completes and is finished in 5 ms. One TRIG signal received during self-calibration is held, and measurement will start after the self-calibration completes.

If there is at least 5 ms of extra time in the measurement interval

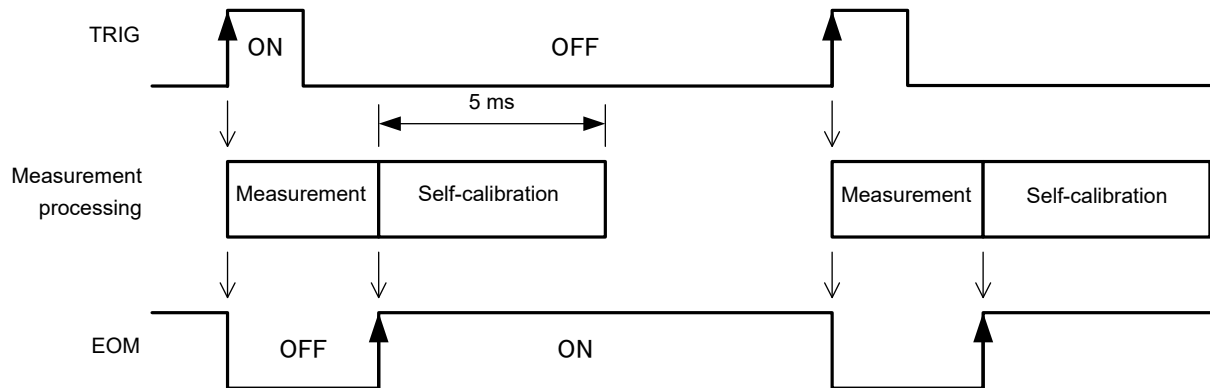

If the TRIG signal is received during self-calibration

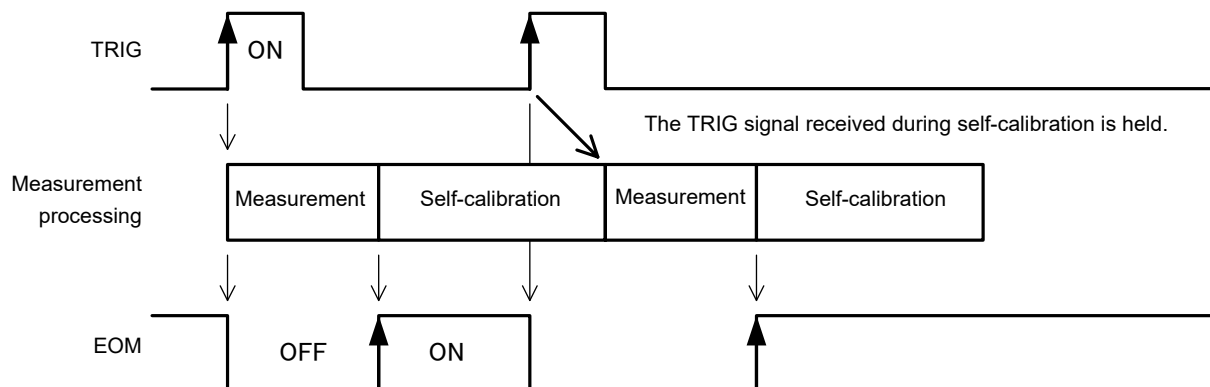

IMPORTANT

- During auto-scan operation, self-calibration starts only after scanning completes. Self-calibration will not be performed after each channel is measured.
- A 400 ms self-calibration is performed immediately after switching from MANUAL to AUTO. Do not input the TRIG signal during that interval.

Manual setting operation

Self-calibration starts immediately when the CAL signal is input.

If the TRIG signal is input during self-calibration, self-calibration will continue. In this case, the TRIG signal will be accepted, the EOM signal will turn off, and measurement will start after self-calibration completes.

If the CAL signal is received during measurement, the CAL signal will be accepted, and self-calibration will start after measurement completes.

Method of normal use

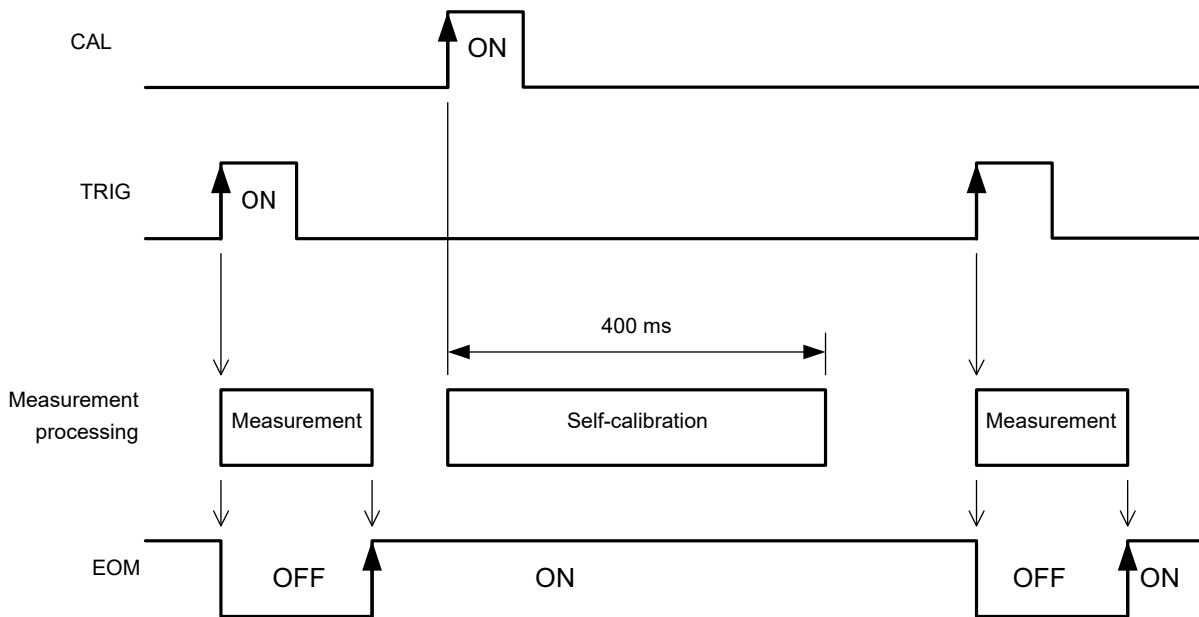

If the TRIG signal is received during self-calibration

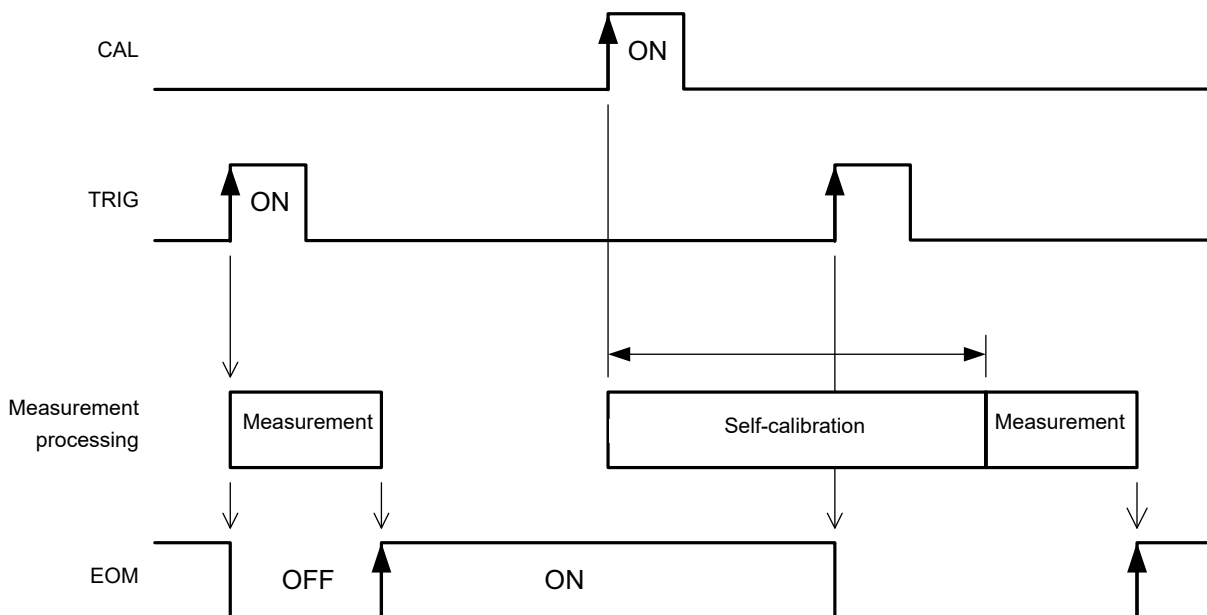

Contact improvement timing

For more information about the contact improvement function and timing charts (contact improvement current), see p.92.

Probe contacts can be improved by applying current between the sense terminals before measurement.

The maximum contact improvement current is 10 mA, and the maximum applied voltage is 5 V.

When low-power mode is set to on, the contact improvement function is set to off.

Using the contact improvement function causes the time until measurement completion to be lengthened by 0.2 ms.

Panel load timing

When using the multiplexer, set the MUX signal to on.

(1) When using the TRIG signal

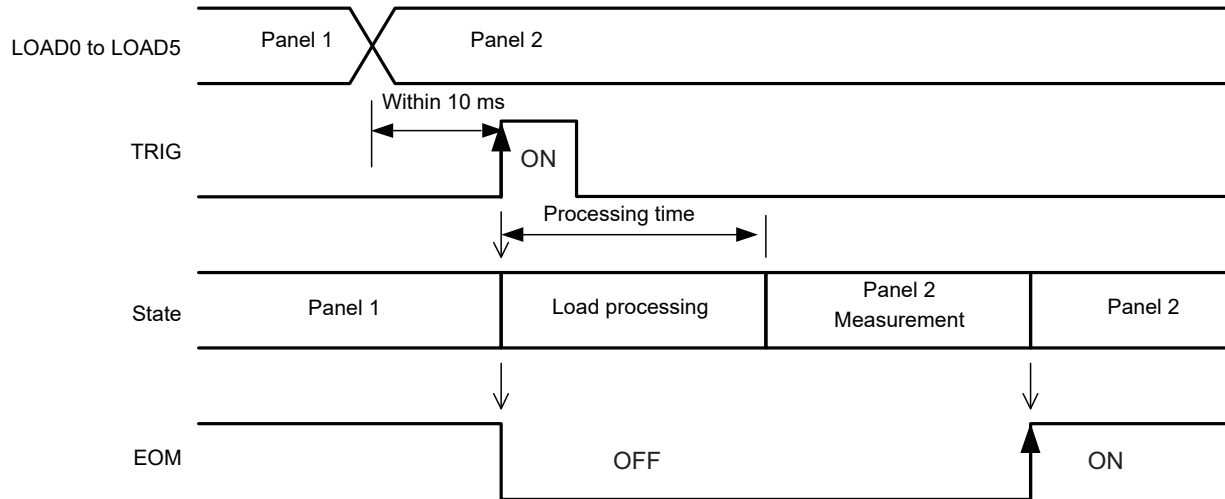

(2) When not using the TRIG signal

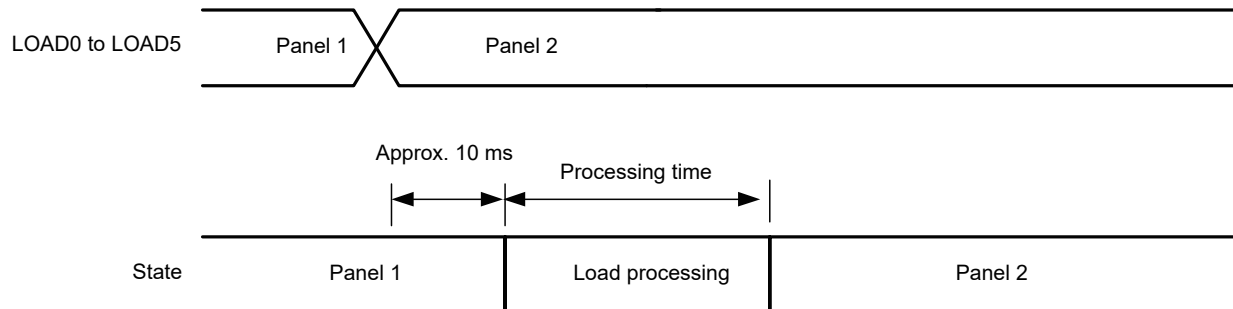

Processing time

Panel 1 to 30	Approx. 100 ms
Panel 31 to 38	Approx. 200 ms

Multiplexer timing

See: "7.3 Multiplexer Settings" (p.154)

(1) Scan function: Off

To switch channels, set the MUX signal to on.

When using the TRIG signal

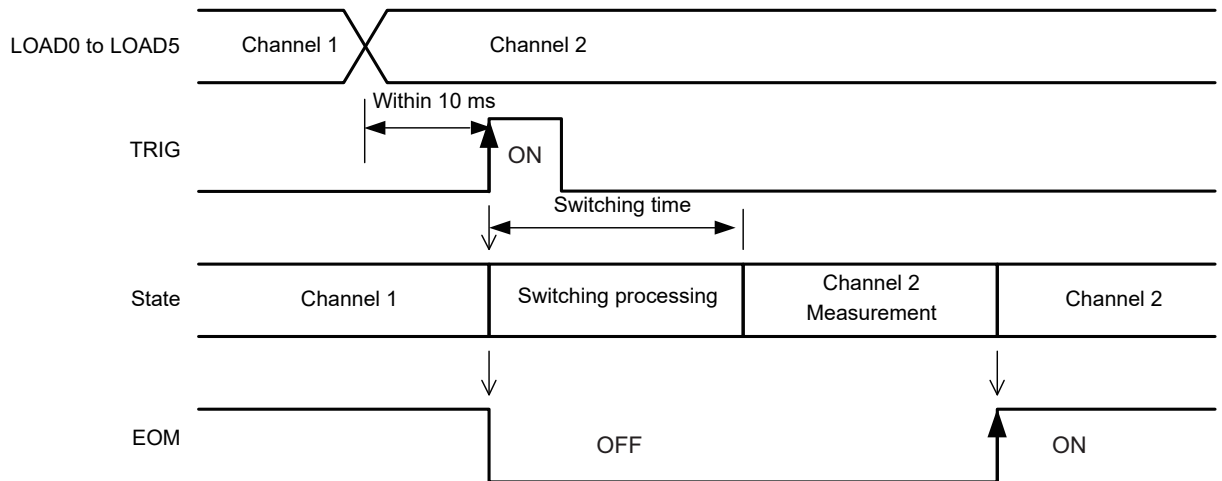

When not using the TRIG signal

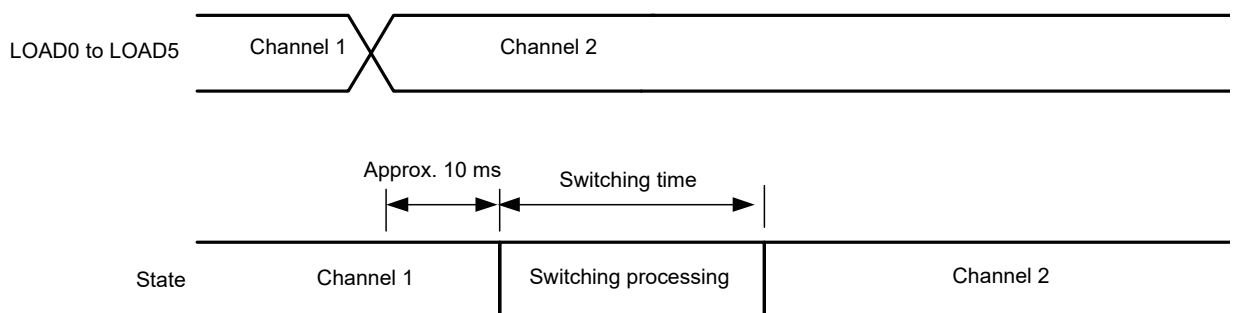

IMPORTANT

Channels can be changed when the scan function is off. When the scan function is set to auto or step, channels cannot be changed for external input signals.

When you attempt to switch to the multiplexer while measurement leads are connected to the measurement terminals on the front of the instrument, the ERR signal will turn on, and you will not be able to make the switch. Disconnect the measurement leads and switch the LOAD signal again.

(2) Scan function: Auto

Measurement is performed while switching all channels after one trigger input.

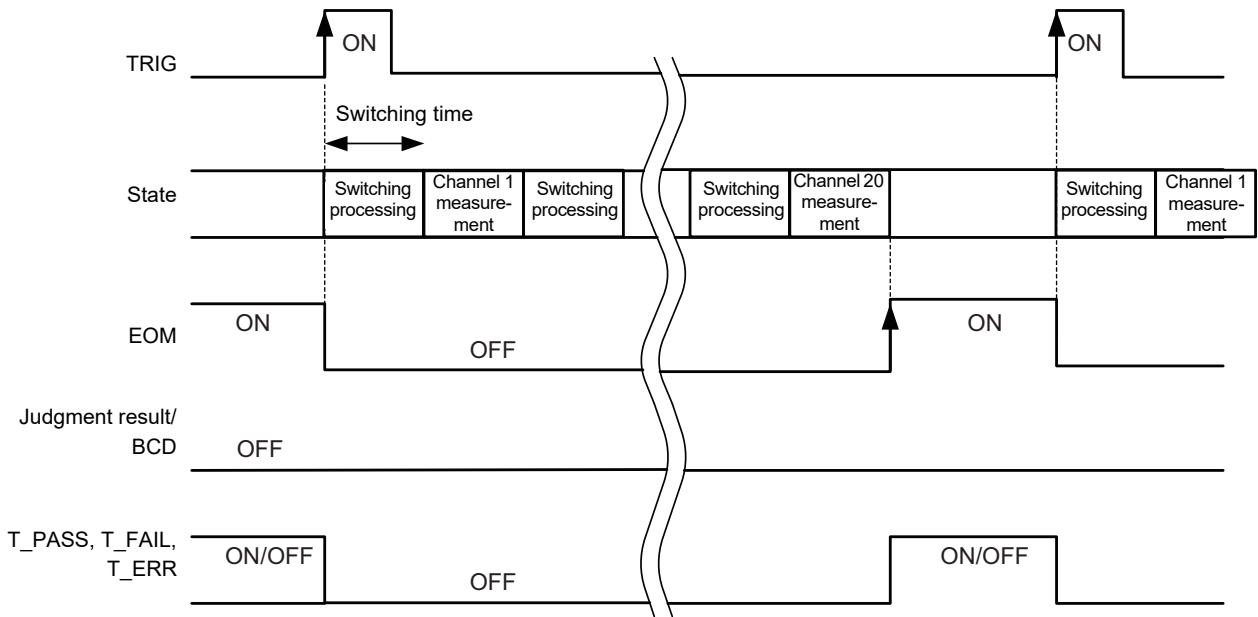

Judgment result/ BCD: HI, IN, LO, ERR, PASS, FAIL, BCDm-n, RNG_OUT0 to 3
 In this example, channels 1 through 20 have been set to ON.

IMPORTANT

- The channel judgment result (HI, IN, LO, ERR) signals and BCD signal are not output. Only the total judgment result (T_PASS, T_FAIL, T_ERR) signals are output.
- The INDEX signal does not turn on for each channel. It turns on after the completion of scanning.
- During scanning, the TRIG, CAL, and 0ADJ signals are ignored without being held.

SCN_STOP operation

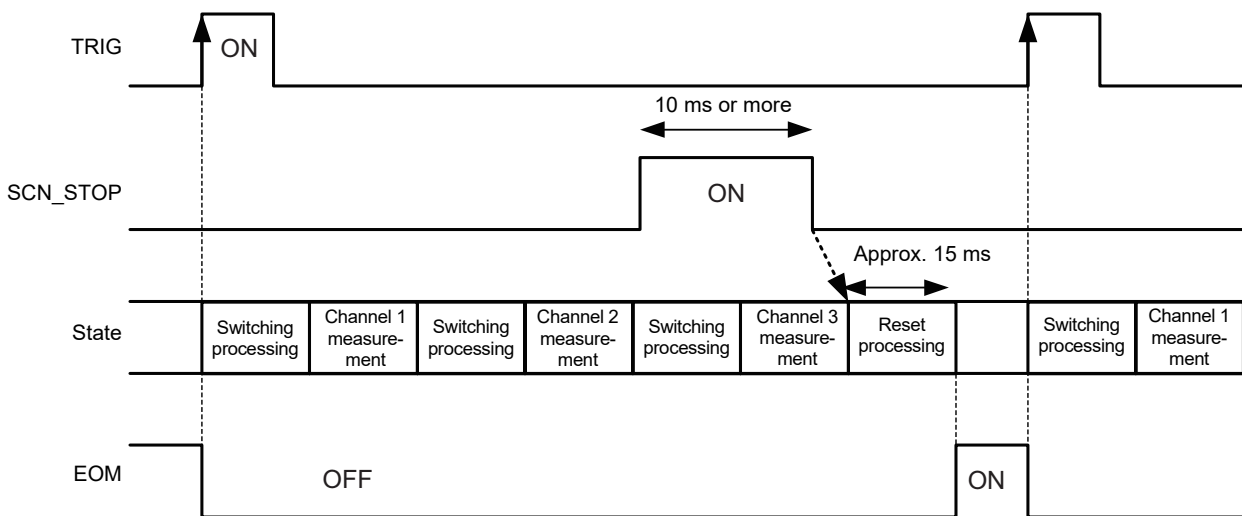

(3) Scan function: Step

After the trigger, processing switches to the next channel and measurement is performed. The total judgment (T_PASS, T_FAIL, T_ERR) signals are only output once measurement of the last channel is complete.

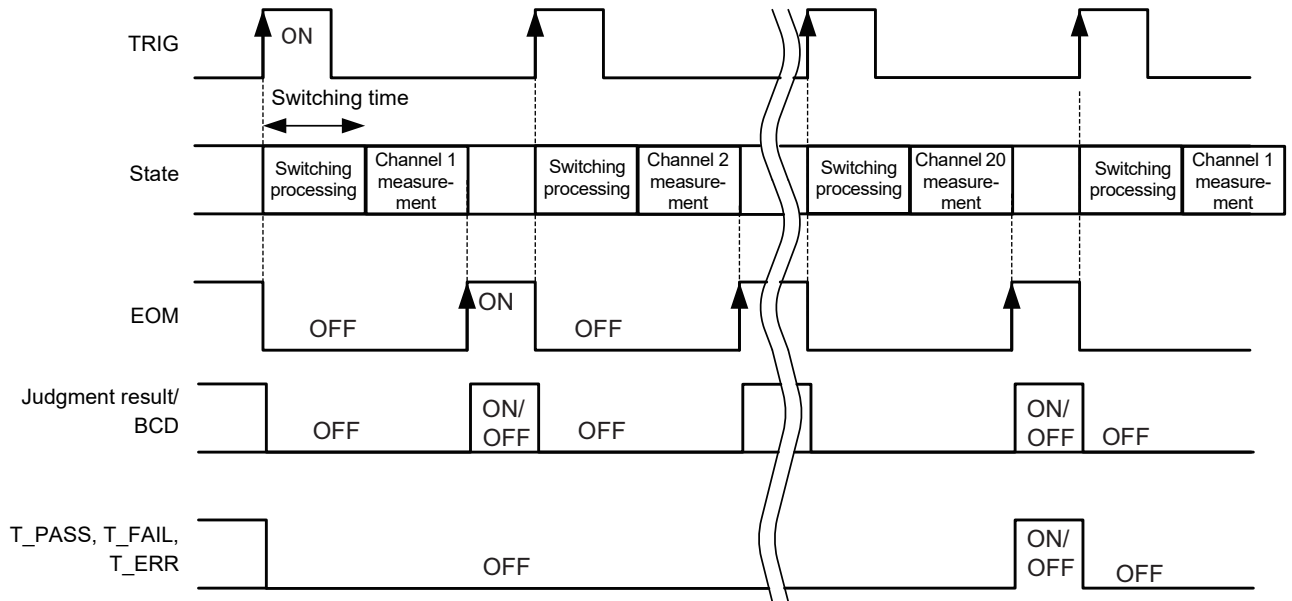

Judgment result/ BCD: HI, IN, LO, ERR, PASS, FAIL, BCDm-n, RNG_OUT0 to 3
 In this example, channels 1 through 20 have been set to ON.

IMPORTANT

- Once the TRIG signal turns on after measurement of all channels is complete, measurement will start again with the first channel.
- During scanning, the TRIG, CAL, and 0ADJ signals are ignored without being held.
- For channels for which an externally connected device is selected, EOM will turn on after switching processing completes.

SCN_STOP operation

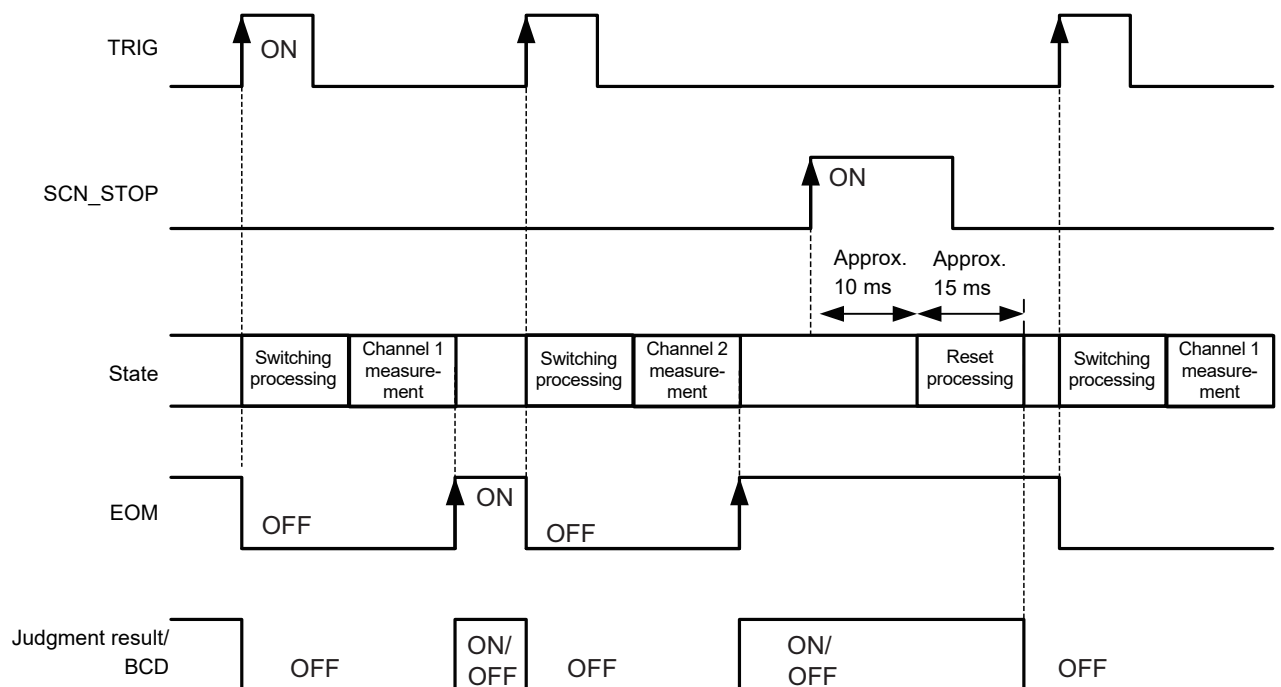

Channel switching time

Without range or low-power mode switching	Approx. 30 ms
With range or low-power mode switching	Approx. 50 ms

IMPORTANT

When there is back EMF, for example due to a transformer, the relay hot-switching prevention function will increase the duration of switching processing. The hot-switching prevention function will be canceled after the back EMF has dissipated or after a maximum of (1 s + the set delay time) has elapsed. For more information about the measurement time, see “From start of measurement to acquisition of judgment results” (p.196).

Output signal state at power-on

When transitioning from the Startup screen to the Measurement screen after turning on the instrument's power, the EOM and INDEX signals will turn on.

When using pulse EOM output, the signals will remain off.

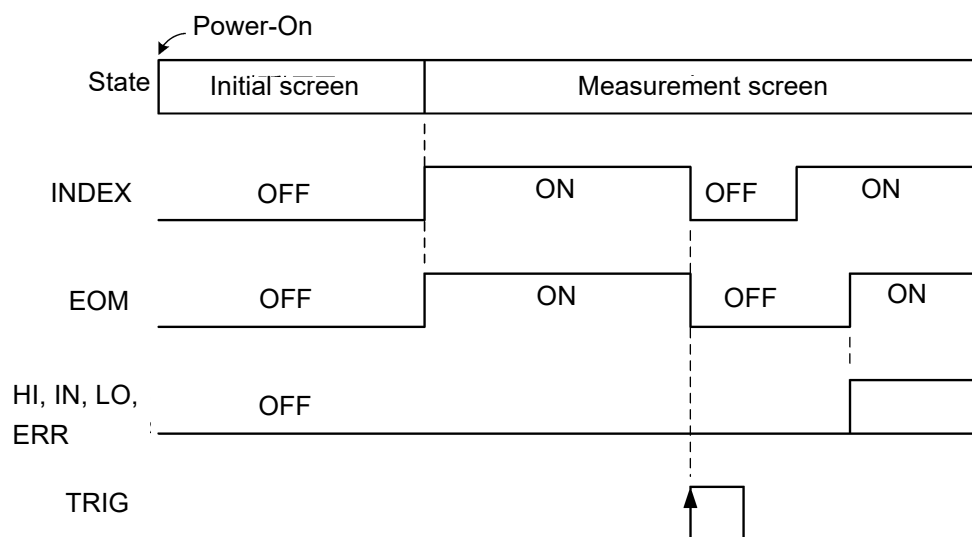

The chart depicts operation when the trigger source is set to EXT while using hold EOM output.

Acquisition process when using an external trigger

This section describes the process from measurement start to acquisition of judgment results or measured values when using an external trigger.

The instrument outputs the EOM signal immediately once the judgment result (HI, IN, LO, ERR, T_PASS, T_FAIL, T_ERR) has been finalized. If the response of the input circuit in the controller is slow, inserting wait processing may be required after the EOM signal switching to on is detected until a judgment result is acquired.

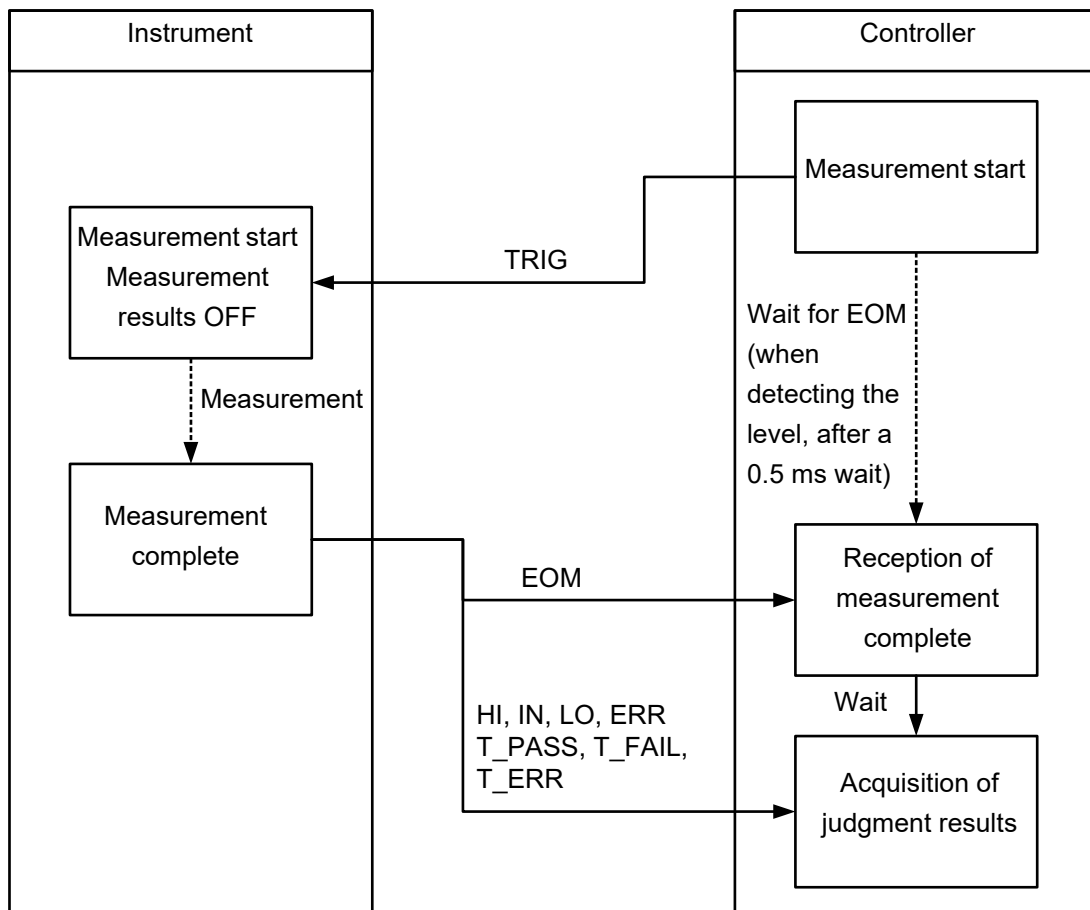

Measured value (BCD) acquisition processing when using an external trigger

For BCD output, the upper and lower digits must be acquired separately. The upper and lower digits can be acquired in any order. In the following example, the upper digits are acquired first. If the response of the input circuit in the controller is slow, inserting wait processing after the EOM signal switching to on is detected until a measurement value (in the BCD format) is acquired. In addition, inserting more than 0.4 ms of wait processing after the BCD_LOW signal is controlled.

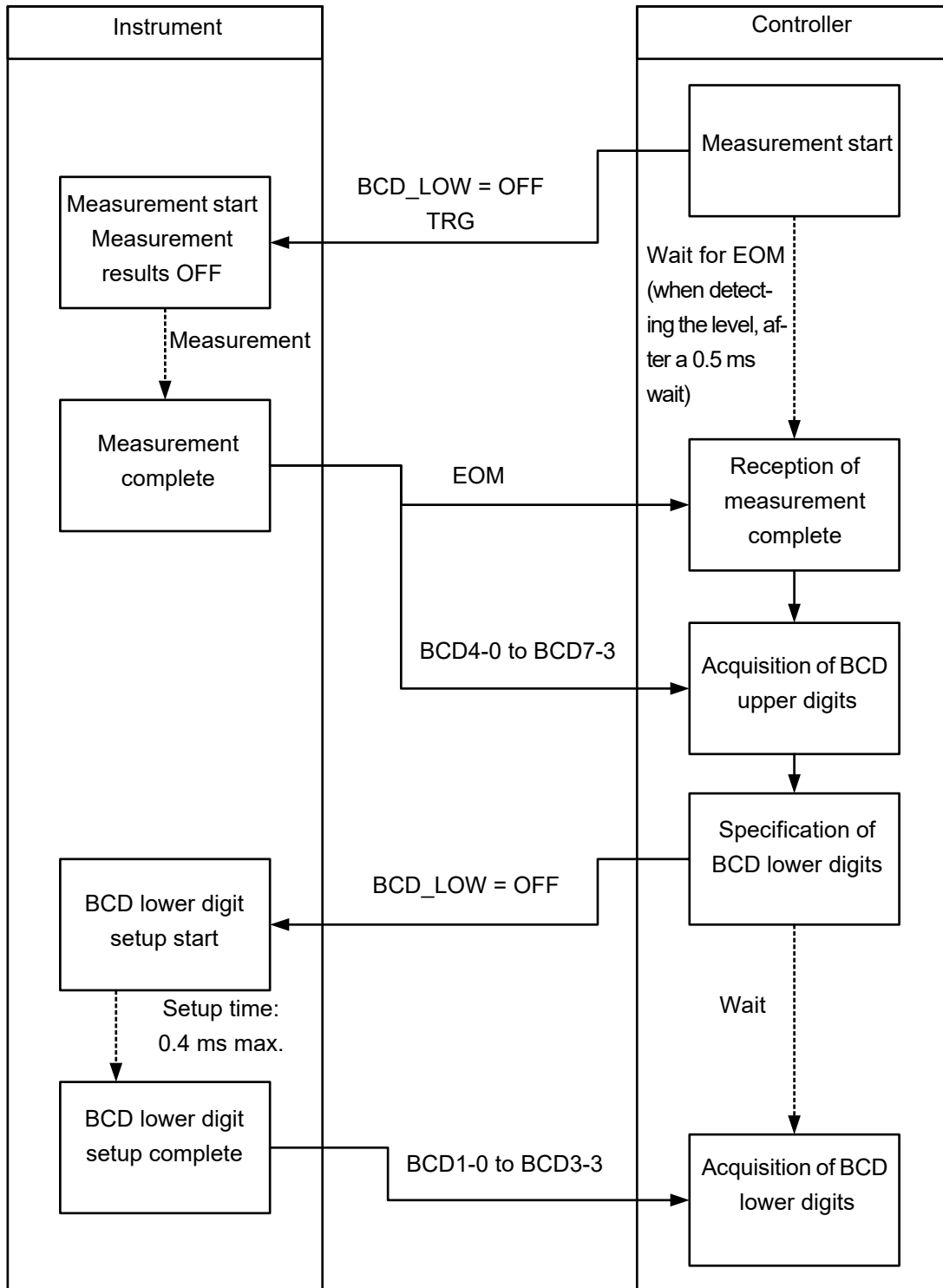

9.3 Internal Circuitry

NPN settings

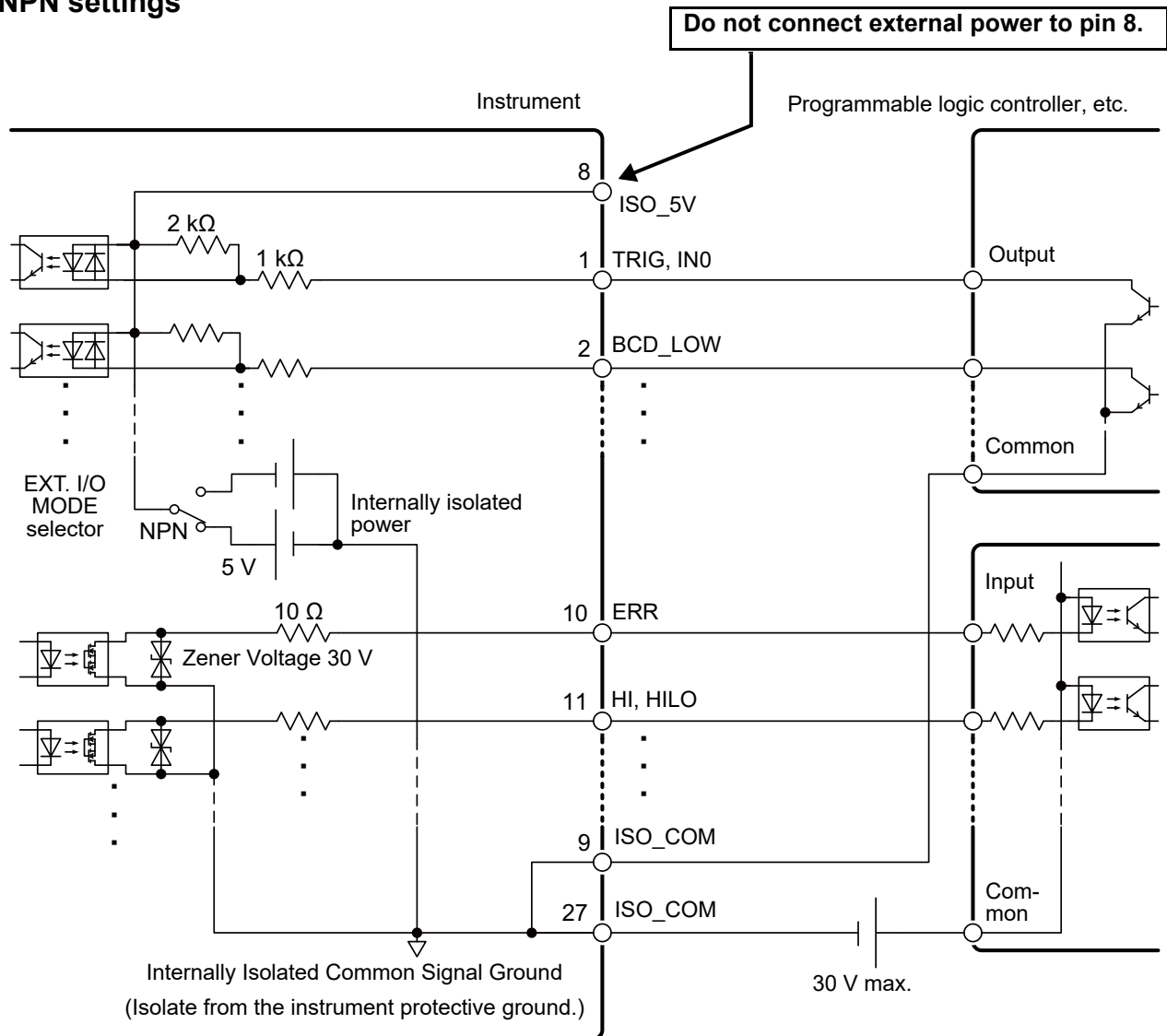

IMPORTANT

- Use ISO_COM as the common pin for input and output signals.
- If a high current will flow to common wiring, branch the output signal common wiring and input signal common wiring from a point lying close to the ISO_COM pin.

PNP settings

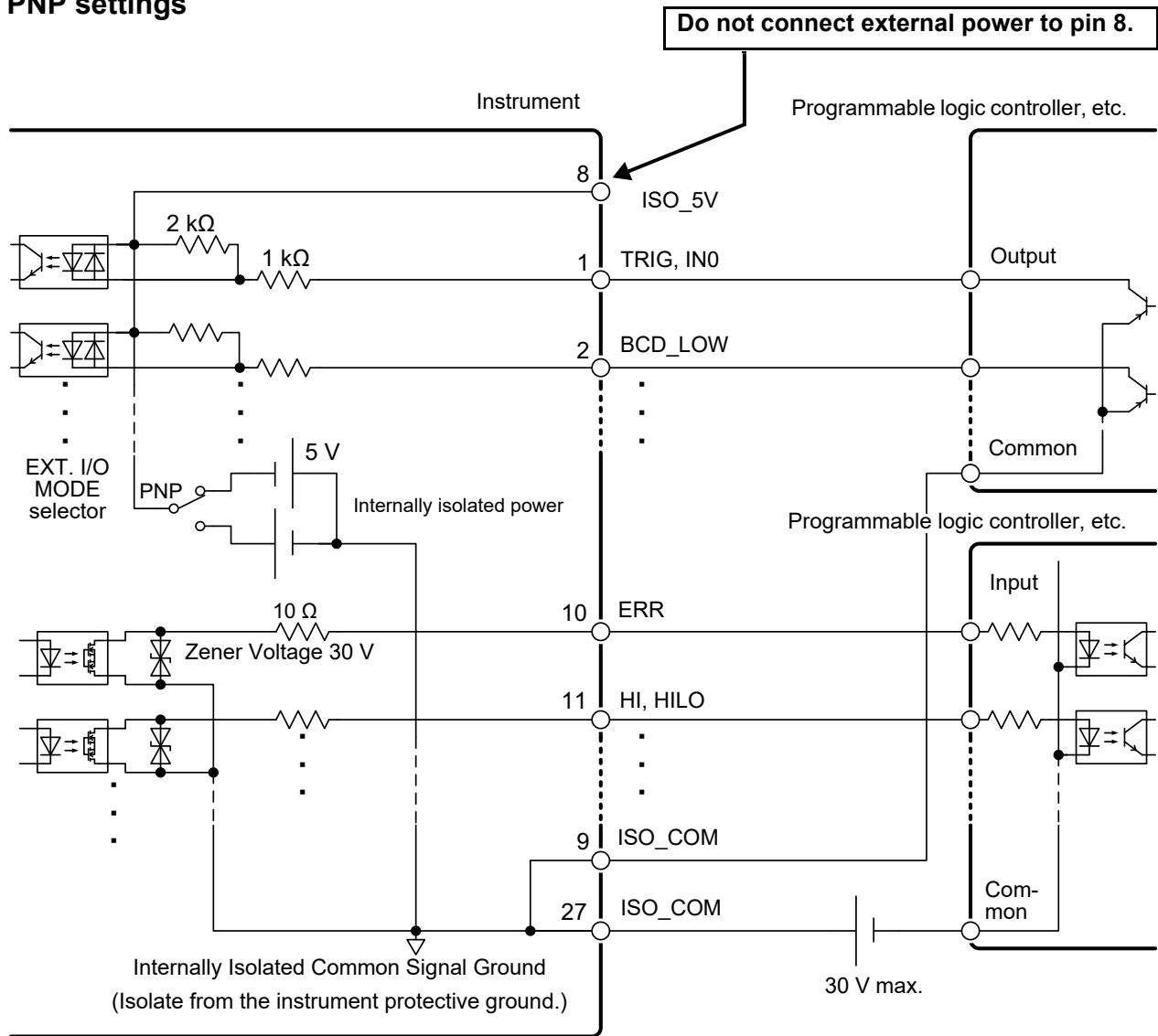

IMPORTANT

Use ISO_COM as the common pin for input and output signals.

Electrical specifications

Input signals	Input type	Photocoupler-isolated no-voltage contact input (Current sink/source output compatible)
	Input asserted (ON)	Residual voltage: 1 V or less (Input ON current: 4 mA [reference value])
	Input asserted (OFF)	Open (shutoff current: 100 μ A or less)
Output signals	Output type	Photocoupler-isolated open-drain output (non-polar)
	Maximum load voltage	30 V DC
	Maximum output current	50 mA/channel
	Residual voltage	1 V or less (load current: 50 mA) / 0.5 V or less (load current: 10 mA)
Internally isolated power output	Output voltage	Sink output: 5.0 V \pm 10%, source output: -5.0 V \pm 10%
	Maximum output current	100 mA
	External power input	None
	Isolation	Floating from protective ground potential and measurement circuit
	Insulation rating	Line to ground voltage 50 V DC, or 30 V AC rms and 42.4 V AC peak or less

Wiring diagram

Input circuit connection examples

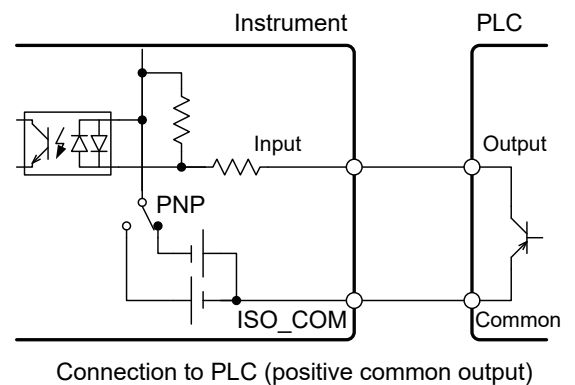
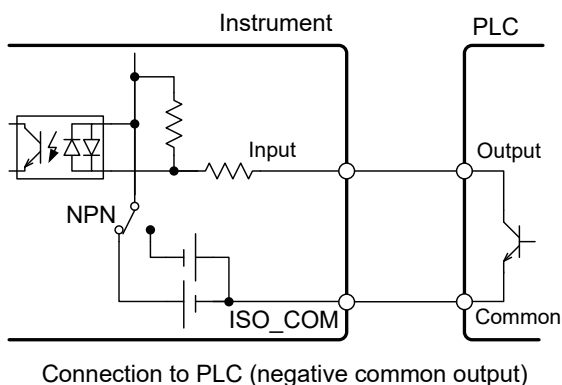
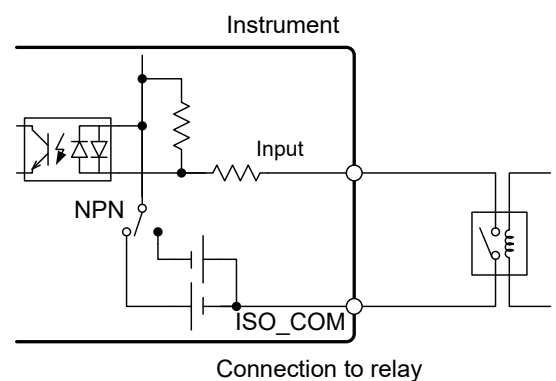
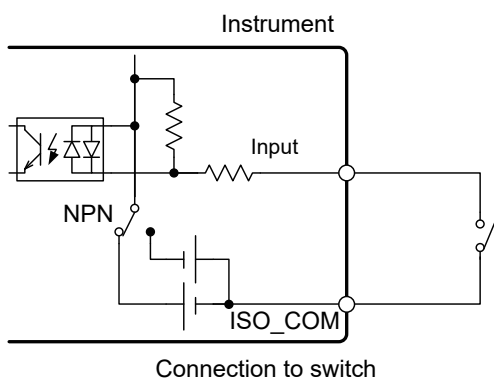

Output circuit connection examples

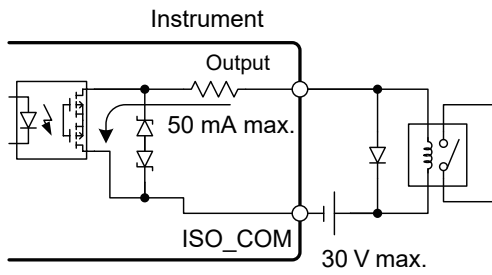

Connection to relay

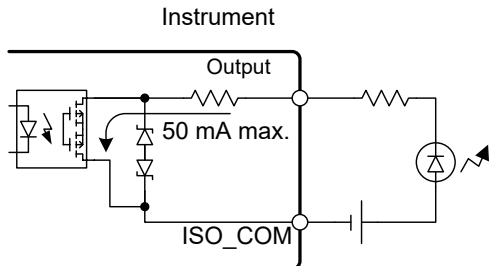

Connection to LED

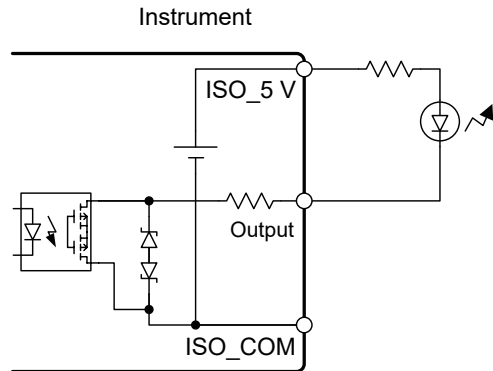

Connection to LED (using ISO_5 V)

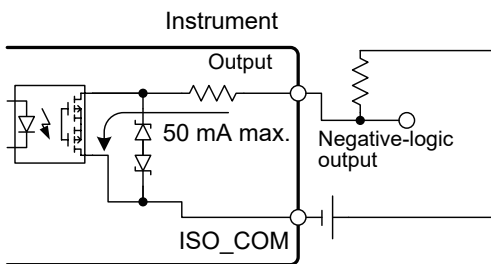

Negative-logic output

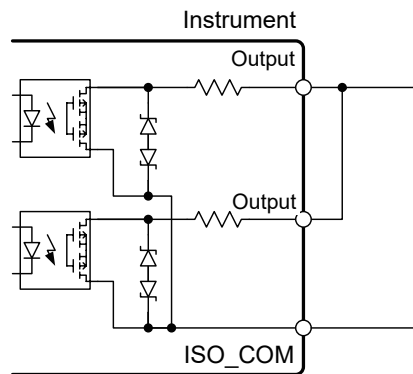

Wired or

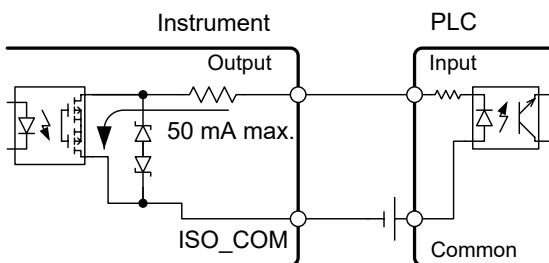

Connection to PLC (positive common output)

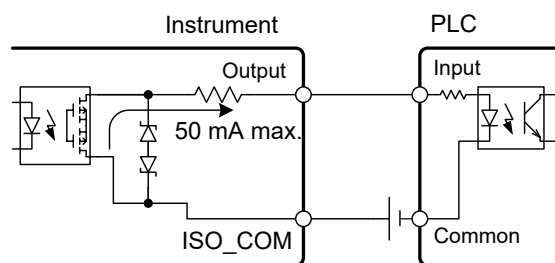

Connection to PLC (negative common output)

9.4 External I/O Settings

The following external I/O settings are provided:

Input settings

- Setting measurement start conditions (trigger source) (p.217)
- Setting the TRIG signal logic (p.219)
- Eliminating TRIG/PRINT signal chatter (filter function) (p.221)

Output settings

- Setting EOM signal (p.223)
- Switching output modes (JUDGE mode/ BCD mode) (p.225)
- Over-range error output (p.226)

Setting measurement start conditions (trigger source)

Measurements can be started in two ways.

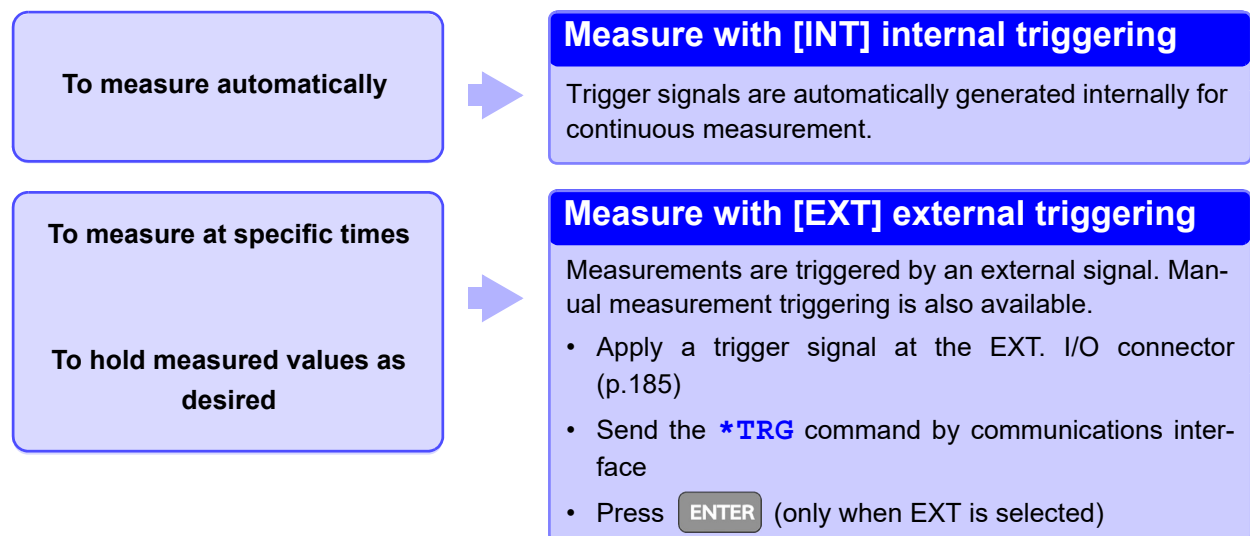

IMPORTANT

- When internal triggering is enabled, the EXT. I/O TRIG signal and the ***TRG** command are ignored (except for memory storage and statistical calculations).
- To measure samples such as inductors that require time to settle, adjust delay time. Start with a long delay, and gradually shorten it while watching for the measured value to settle.
See: "4.10 Setting Pre-Measurement Delay (Delay Function)" (p.86)

Switching the trigger source

- 1 Open the Settings screen.

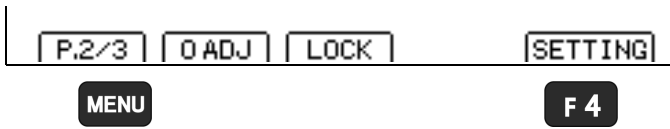

- 1 **MENU** Switch the function menu to P.2/3.

- 2 **F 4** The Settings screen appears.

- 2 Open the EXT. I/O Setting screen.

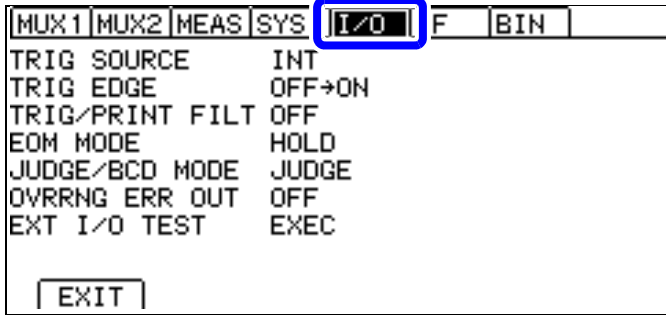

Move the cursor to the **[I/O]** tab with the left and right cursor keys.

- 3 Select the trigger source.

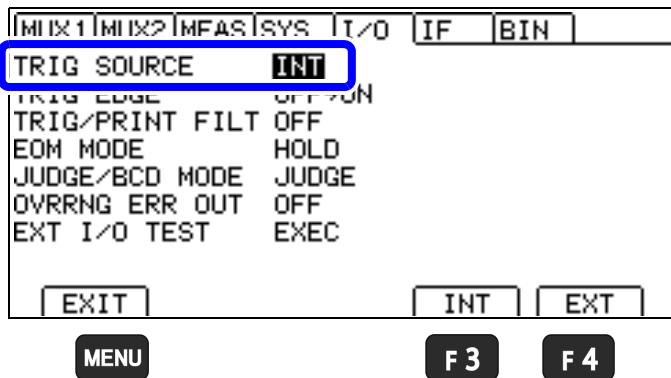

- 1  Selection

- 2 **F 3** **[INT]** Internal trigger (default)

- F 4** **[EXT]** External trigger

- MENU** Return to the Measurement screen.

Continuous measurement (**: INITIATE:CONTINUOUS ON**) is the normal trigger state when using key operation from the front panel. Selecting the internal (**[INT]**) trigger source activates continuous triggering (“free-run”). When external (**[EXT]**) triggering is selected, each external trigger event initiates one measurement.

Continuous measurement can be disabled by sending the **: INITIATE:CONTINUOUS OFF** command via RS-232C or USB. When continuous measurement is disabled, trigger acceptance is controlled only by the controller (computer or PLC).

For more information about trigger commands, see the Communications Command Instruction Manual. The Instruction Manual can be downloaded from Hioki’s website.

<https://www.hioki.com/global/support/download/>

Setting the TRIG signal logic

Select the on or off edge as the logic at which the TRIG signal is enabled.

When using the off edge, measurement times will be increased by approximately 0.2 ms.

1 Open the Settings screen.

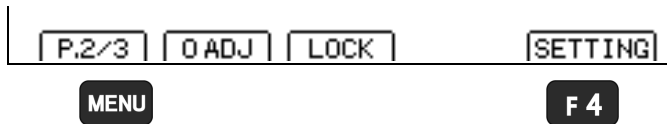

1 **MENU** Switch the function menu to P.2/3.

2 **F4** The Settings screen appears.

2 Open the EXT. I/O Setting screen.

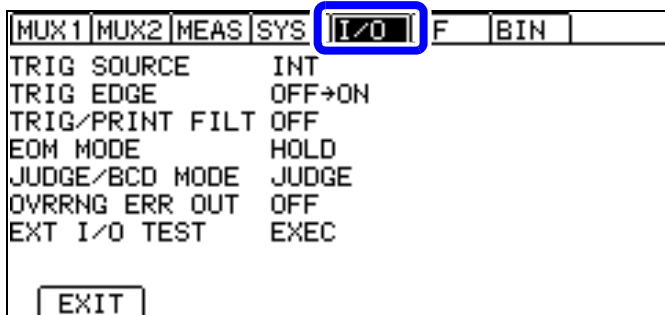

Move the cursor to the **[I/O]** tab with the left and right cursor keys.

3 Select the trigger conditions.

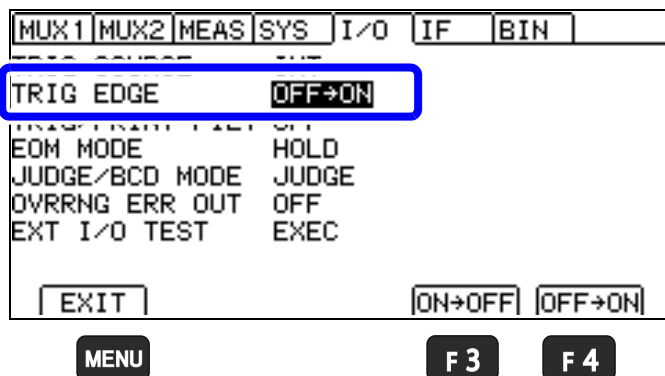

1 Selection

2
F3 **[ON → OFF]**
Start measurement at the OFF edge.

F4 **[OFF → ON]**
ON edge (default)

MENU Return to the Measurement screen.

On edge and off edge operation

- On edge

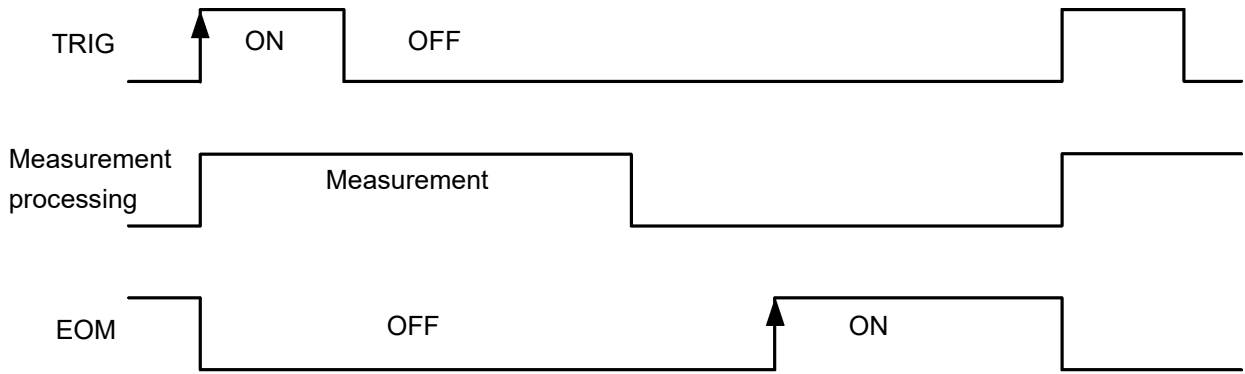

- Off edge

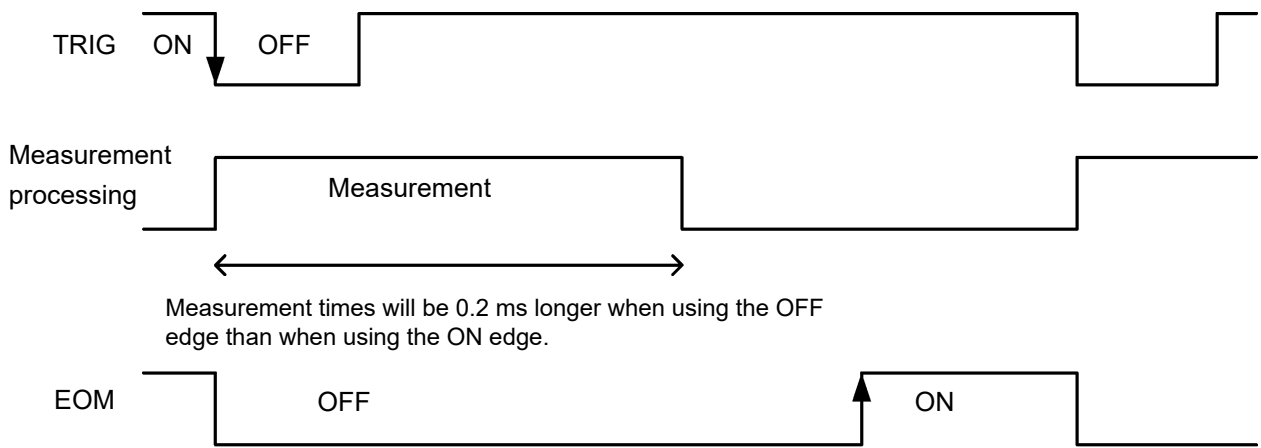

Eliminating TRIG/PRINT signal chatter (filter function)

The filter function, which eliminates chatter, is useful when connecting a foot switch or similar device to the TRIG/PRINT signal.

1 Open the Settings screen.

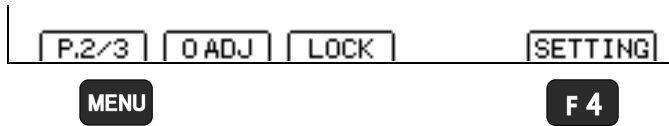

1 **MENU** Switch the function menu to P.2/3.

2 **F 4** The Settings screen appears.

2 Open the EXT. I/O Setting screen.

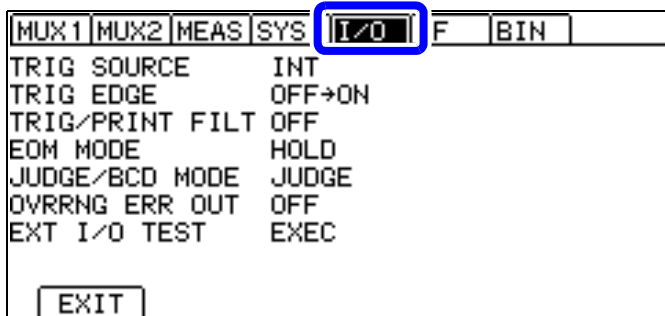

Move the cursor to the **[I/O]** tab with the left and right cursor keys.

3 Select the filter function.

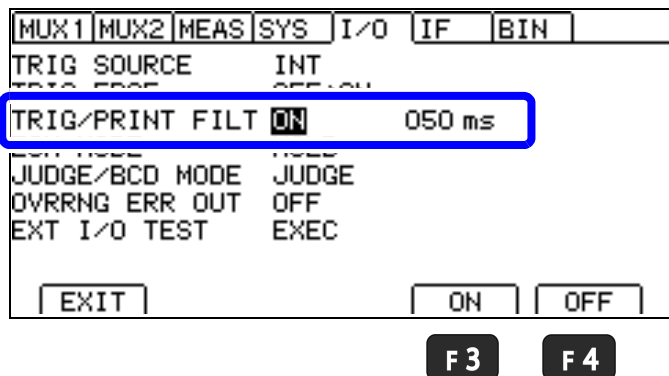

1  Selection

2 **F 3** ON

F 4 OFF (default)

4 Set the response time.

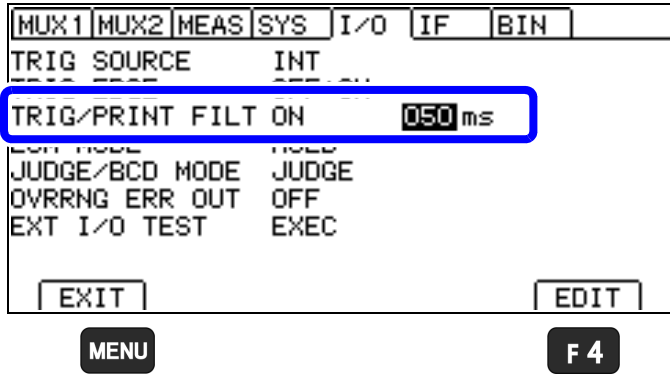

1 Move the cursor to the setting you wish to configure. Make the value editable with the **F4** key.

2 Move among digits. Change values. Move the cursor to the digit you wish to set with the left and right cursor keys. Change the value with the up and down cursor keys.

3 **ENTER** Accept
(**ESC** Cancel)

Setting range: 50 ms to 500 ms (default: 50 ms)

MENU Return to the Measurement screen.

Filter function (TRIG signal example)

- Using the On edge

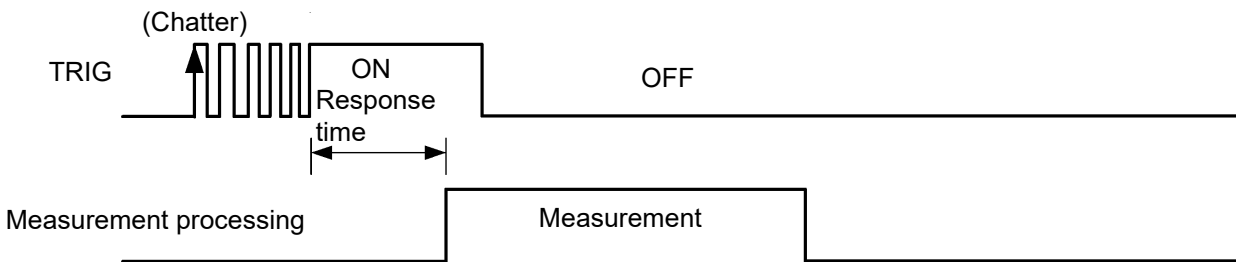

- Using the Off edge

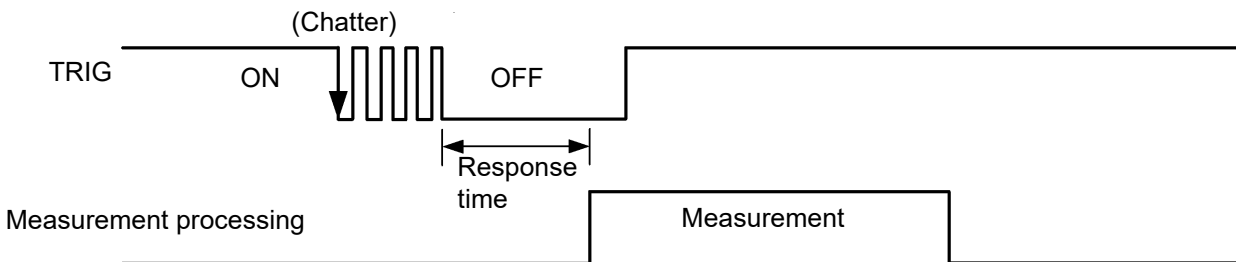

Hold the input signal until the response time elapses.

Setting EOM signal

You can select whether to hold EOM signal output until the next trigger is input or output a user-specified pulse width.

IMPORTANT

When using the internal trigger [INT], the EOM pulse width is fixed at 5 ms, regardless of the settings.

1 Open the Settings screen.

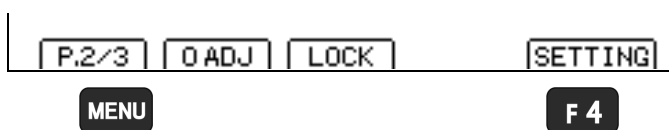

1 **MENU** Switch the function menu to P.2/3.

2 **F 4** The Settings screen appears.

2 Open the EXT. I/O Setting screen.

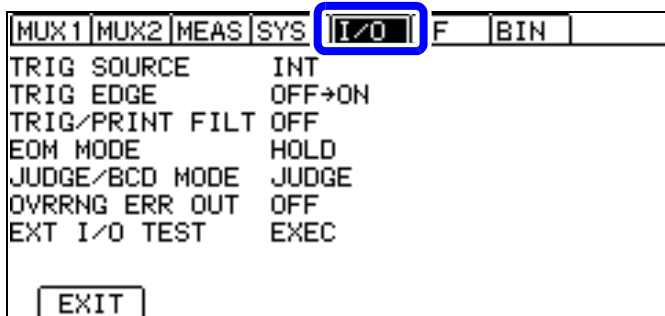

Move the cursor to the [I/O] tab with the left and right cursor keys.

3 Select the EOM signal output type.

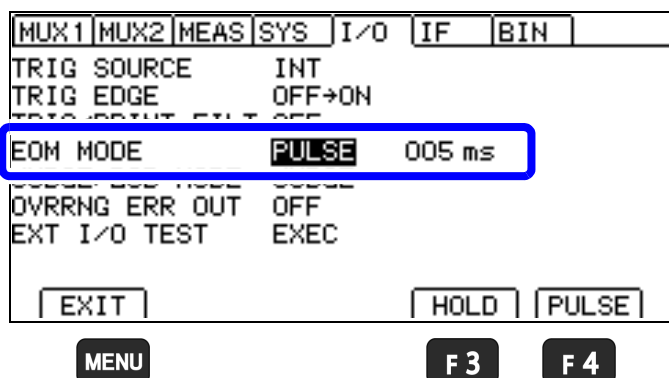

1 Selection

2 **F 3** The EOM signal remains asserted after end-of-measurement (default)

F 4 The specified pulse is output after end-of-measurement.

MENU Return to the Measurement screen.

4 (When PULSE is selected)

Select the pulse width.

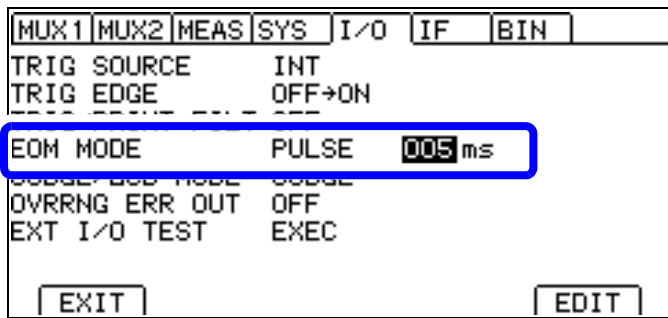

MENU

F4

Setting range: 1 ms to 100 ms (default: 5 ms)



1

Move the cursor to the setting you wish to configure. Make the value editable with the **F4** key.



2

Move among digits.  Change values.

Move the cursor to the digit you wish to set with the left and right cursor keys. Change the value with the up and down cursor keys.



3

ENTER Accept



(**ESC**) Cancel)



MENU Return to the Measurement screen.

Switching output modes (JUDGE mode/ BCD mode)

- 1 Open the Settings screen.

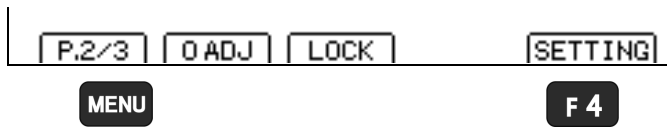

- 1 **MENU** Switch the function menu to P.2/3.

- 2 **F4** The Settings screen appears.

- 2 Open the EXT. I/O Setting screen.

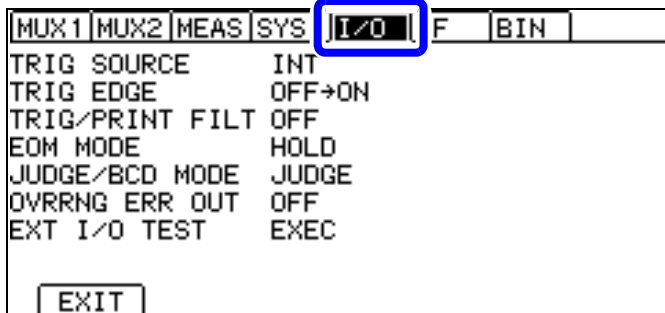

Move the cursor to the **[I/O]** tab with the left and right cursor keys.

- 3 Select the output mode.

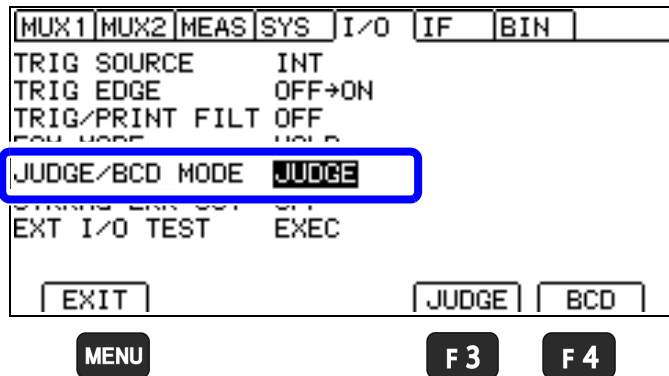

- 1 Selection

- 2 **F3** Judgment mode (default)

- F4** BCD mode

- MENU** Return to the Measurement screen.

Over-range error output

When the measurement value falls outside the range or a constant current fault occurs (current fault mode: over-range), an ERR signal of the EXT. I/O output is output.

1 Open the Settings screen.

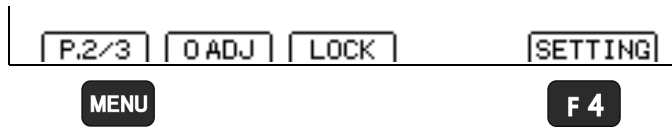

1 **MENU** Switch the function menu to P.2/3.

2 **F 4** The Settings screen appears.

2 Open the EXT. I/O Setting screen.

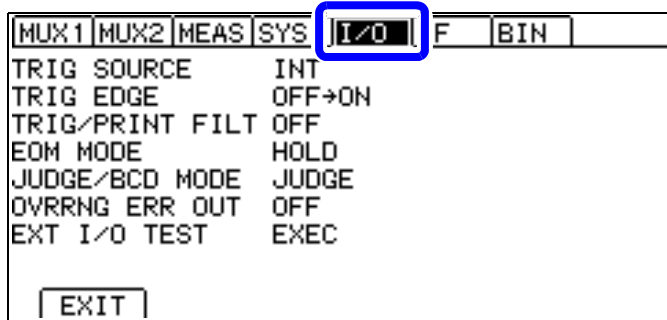

Move the cursor to the **[I/O]** tab with the left and right cursor keys.

3 Turn [OVERRNG ERR OUT] ON.

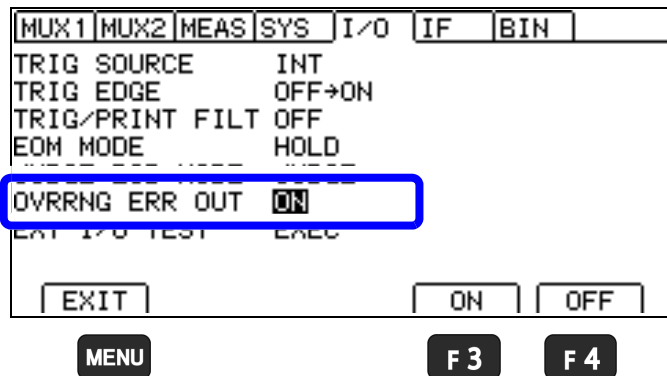

1  Selection

2
F 3 ON
F 4 OFF (default)

MENU Return to the Measurement screen.

9.5 Checking External Control

Performing an I/O test (EXT. I/O test function)

In addition to switching output signals on and off manually, you can view the input signal state on the screen.

- 1 Open the Settings screen.

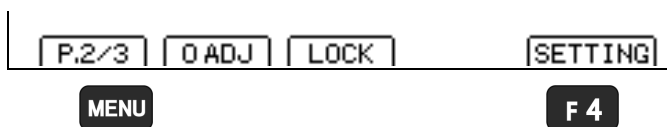

- 1 **MENU** Switch the function menu to P.2/3.

- 2 **F 4** The Settings screen appears.

- 2 Open the EXT. I/O Setting screen.

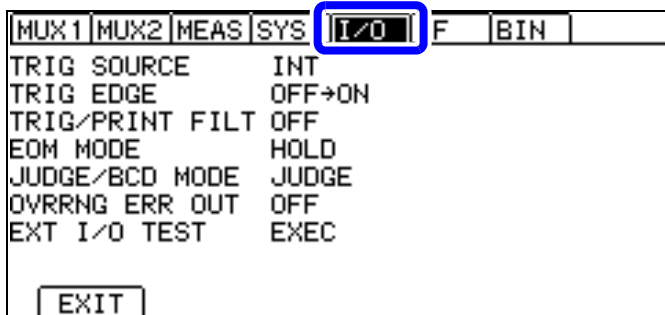

Move the cursor to the **[I/O]** tab with the left and right cursor keys.

- 3 Open the EXT. I/O Test screen.

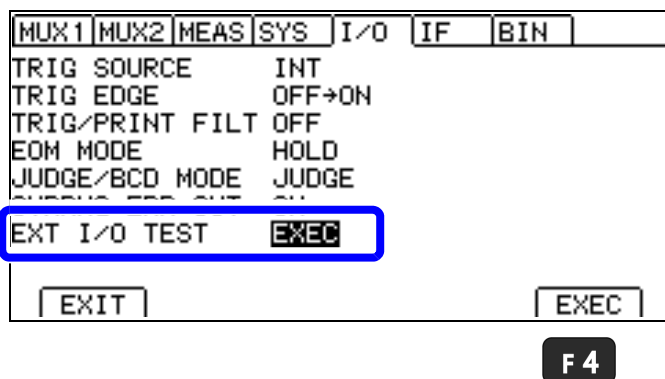

- 1 Selection

- 2 **F 4** Open the Test screen.

4 Perform the EXT. I/O test.

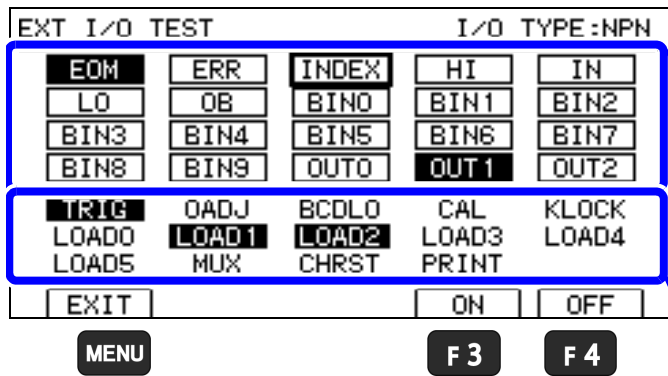

Output signals

Allows you to perform signal operations.
(ON: Reverse video; OFF: Normal display)

: Select signal.

F3 : Turn signal ON

F4 : Turn signal OFF.

Input signals

Displays the signal state.
(ON: Reverse video; OFF: Normal display)

MENU Return to the EXT. I/O Setting screen.

9.6 Supplied Connector Assembly

The EXT. I/O connector and shell are supplied with the instrument. Assemble as shown below.

IMPORTANT

- Use shielded cables to connect a PLC to the EXT. I/O connector. Using non-shielded conductors could result in system errors from electrical noise.
- Connect the shield to the ISO_COM pin of the EXT. I/O connector.

Required tools:

- Screwdriver
- Shielded wiring
- Soldering iron

Included accessories

• A Cover	2
• B Screw (+/-) #4-40UNC (16.9 mm overall length)	2
• C Screw (+/-) #4-40UNC (12.6 mm overall length)	2
• D Screw (-) #4-40UNC (15.0 mm overall length)	2
• E Nut #4-40UNC	2
• F Cable Clamps	2
• G Saddle Washers (shell protection)	2
• H Connector	1

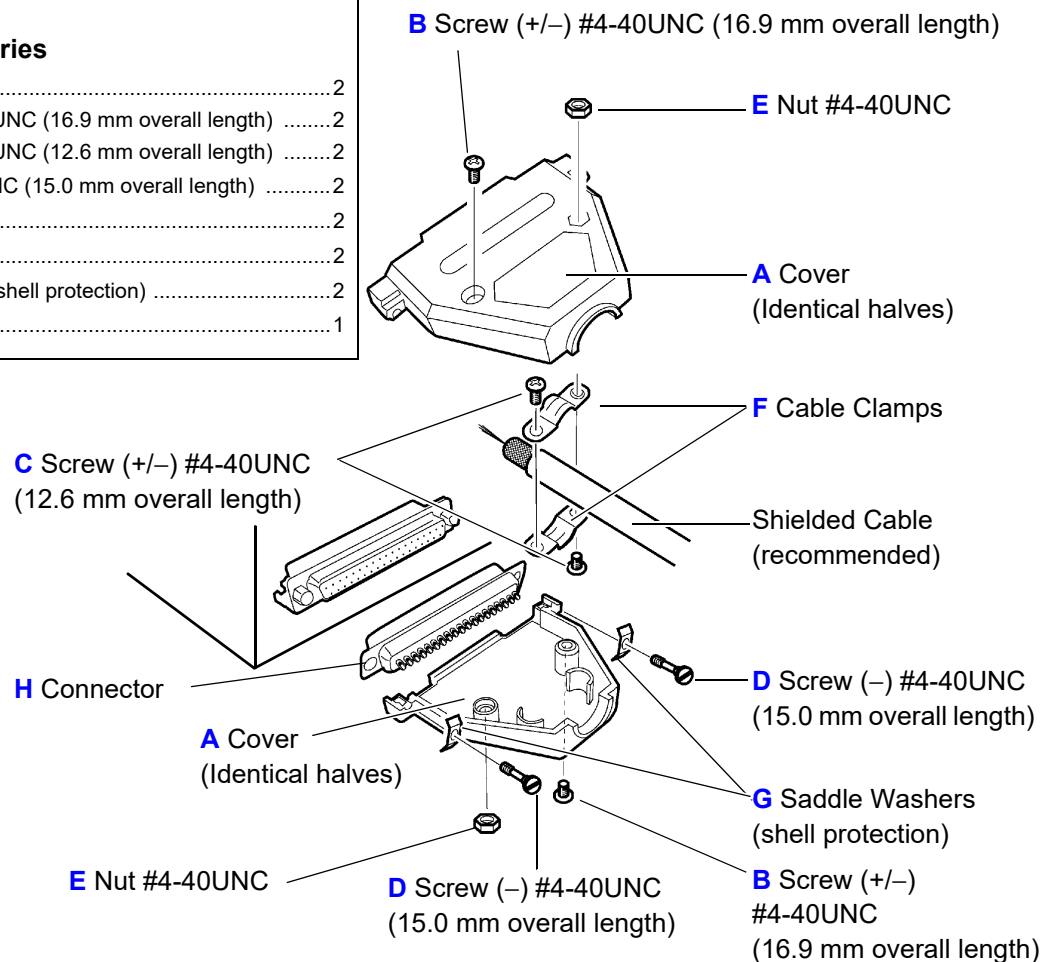

Assembly Sequence

1. Solder the (shielded) cable wires to the supplied EXT. I/O connector (H) pins.
2. Affix the cable clamps (F) on the cable with screws (C).
3. Position the cable clamps (F) to fit properly inside the cover (A).
4. Insert screws (D) through the saddle washers (G).
5. In one half of cover (A), place connector (H), clamps (F), saddle washers (G) and screws (D).
6. Place the other half of cover (A) on top.
7. Affix the halves of the cover (A) together with screws (B) and nuts (E).
Be careful not to overtighten the screws, which could damage the covers.

10 Communications

(USB/RS-232C/LAN Interface)

WARNING



- **Turn off all devices before connecting or disconnecting interface connectors.**

Failure to do so could cause the operator to experience an electric shock.

CAUTION



- **Do not disconnect the data cable during communications.**

Doing so could damage the instrument or the PC.



- **Seat connectors securely.**

Failure to do so could damage the instrument or prevent it from performing to specifications.

- **Use the same ground for the product and computer.**

If potential difference exists between the grounds of the instrument and the controller, connecting the data cable could damage the instrument or the PC or result in malfunctions.

- **Once you've connected the cables, tighten the screws on the connectors.**

Failure to do so could result in incorrect data transfer.

10.1 Overview and Features

The RS-232C, LAN, and USB interfaces can be used to control the instrument and acquire data. You must select one communications interface for use. Communications control using different interfaces cannot be performed simultaneously.

For the specifications, see “Communications Interface Specifications” (p.287).

See the section that’s relevant to your goal.

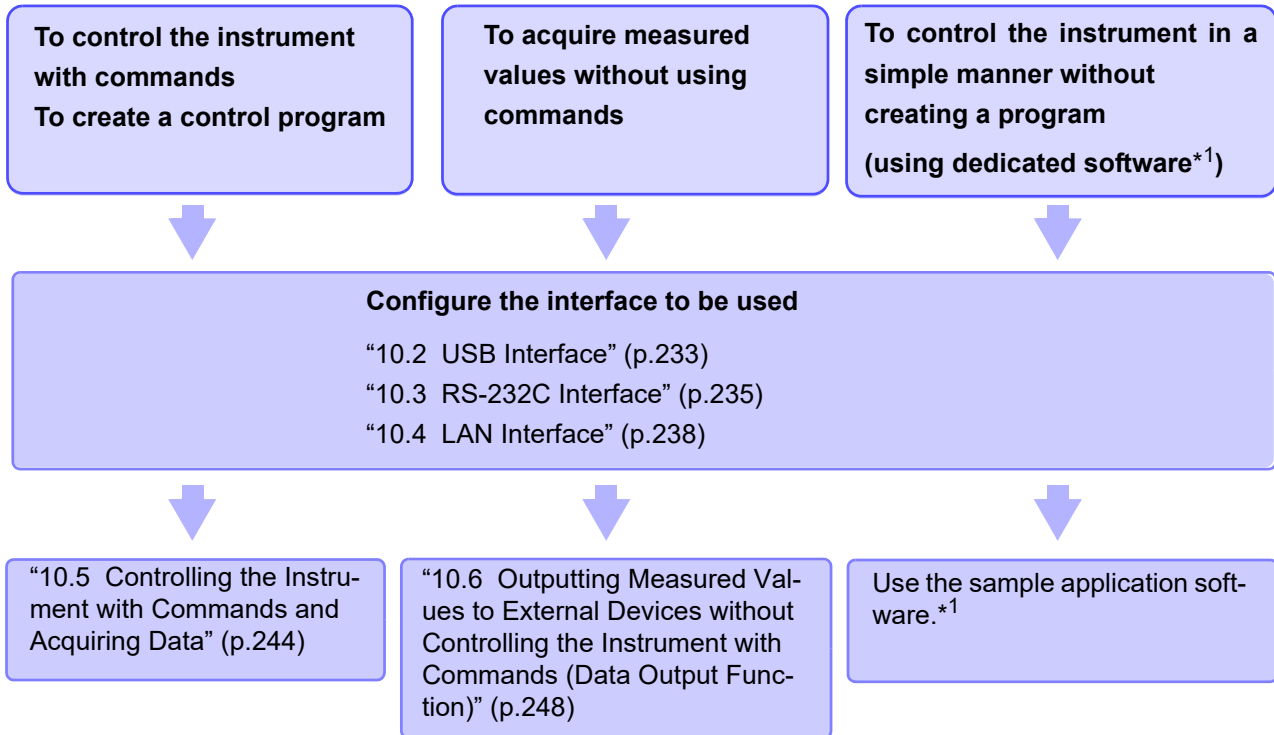

*1. The sample application software is available for download from Hioki’s website.

<https://www.hioki.com/global/support/download/software/>

Communications times

- There may be a display processing lag depending on the frequency and nature of any communications processing performed.
- Time spent transferring data must be added when communicating with a controller.

LAN and USB transfer times vary with the controller.

RS-232C transfer times can be approximated with the following formula, where the transfer speed (baud rate) is N bps using 1 stop bit, 8 data bits, no parity, and 1 stop bit, for a total of 10 bits:

$$\text{Transfer time } T \text{ (1 character/sec)} = \text{Baud rate } N \text{ (bps)} / 10 \text{ (bits)}$$

Since measured values are 11 characters in length, the transfer time for 1 piece of data is 11/T.

Example: For a 9600 bps connection, 11 (9600 / 10) = Approximately 11 ms

- For more information about command execution times, see the Communications Command Instruction Manual. The Instruction Manual can be downloaded from Hioki’s website.

<https://www.hioki.com/global/support/download/>

10.2 USB Interface

Configuring communications

- 1 Open the Settings screen.

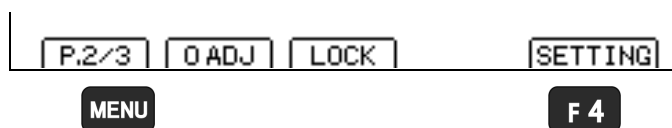

- 1 **MENU** Switch the function menu to P.2/3.

- 2 **F 4** The Settings screen appears.

- 2 Open the Communications Interface Setting screen.

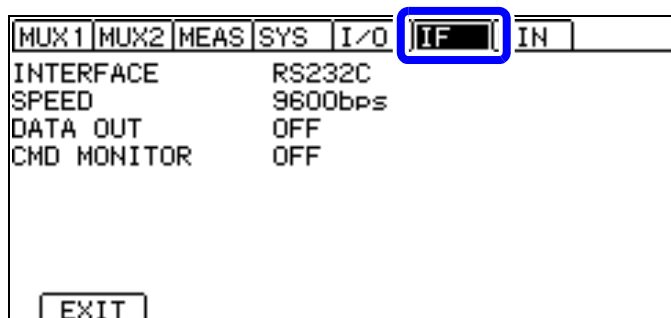

Move the cursor to the **[IF]** tab with the left and right cursor keys.

- 3 Select the interface type.

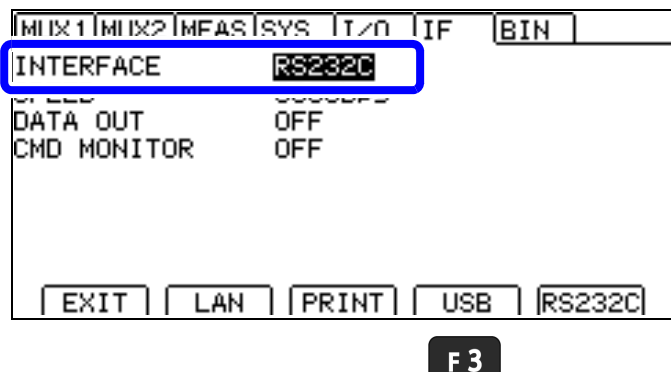

- 1 Selection

- 2 **F 3** USB Interface

- 4 Select the USB connection mode.

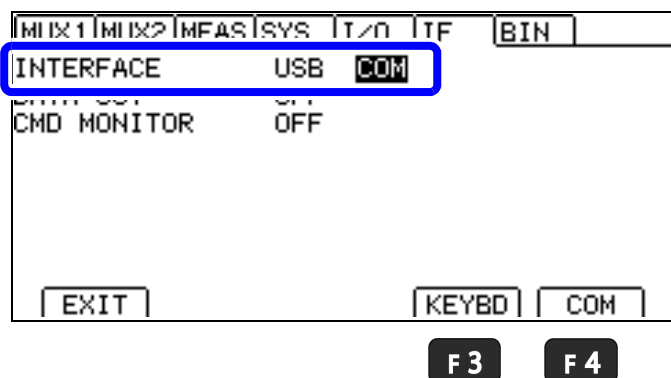

- 1 Move the cursor to the setting you wish to configure.

- 2 **F 3** USB keyboard mode (p.248)
F 4 COM mode (default)

- MENU** Return to the Measurement screen.

IMPORTANT

- USB keyboard mode is provided for data output use only. When using commands, set the connection to COM mode.
- There is no need to install the USB driver in USB keyboard mode.

Installing the USB driver

When the instrument is connected to a computer, the USB driver is automatically installed. Since the OS standard driver is installed, it is not necessary to install another driver.

There is no need to install the driver when using the USB keyboard Class method.

Installation procedure

- 1** Log in to a user account on the PC with administrator privileges (for example, “**administrator**”).
- 2** Connect the instrument and computer using a USB cable.

The USB driver is automatically installed.

After the installation is completed, the instrument is recognized.

- For Windows 10 or Windows11, **[USB Serial Port (COMx)]** is displayed at the device manager port (COM and LPT) when the USB is properly recognized. The COM number varies depending on the environment.
- Even if an instrument with a different serial number is connected, there may be a notification that a new device has been detected.

Connecting the USB cable

Connect the USB cable to the instrument’s USB terminal.

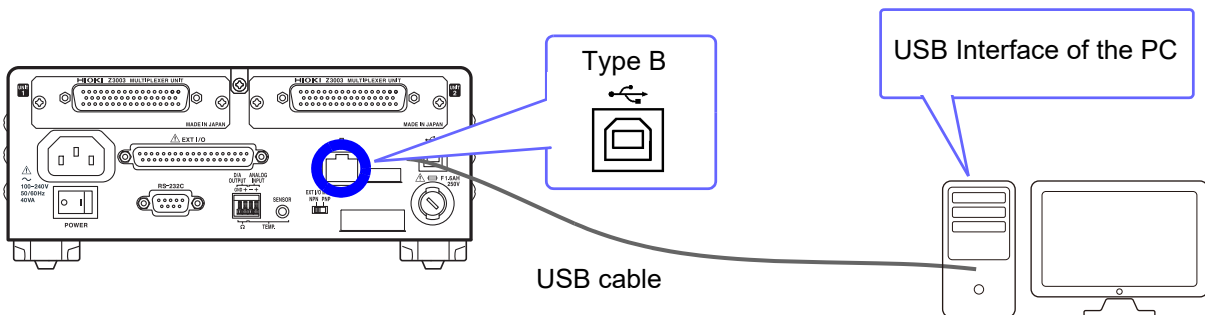

10.3 RS-232C Interface

The RS-232C interface can be used to control the instrument. Set the same communication speed for the controller and the instrument.

Configuring communications

- 1 Open the Settings screen.

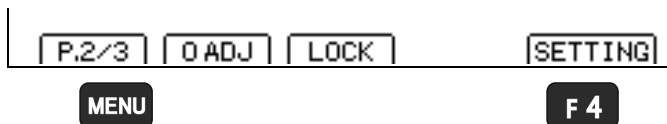

- 1 **MENU** Switch the function menu to P.2/3.

- 2 **F 4** The Settings screen appears.

- 2 Open the Communications Interface Setting screen.

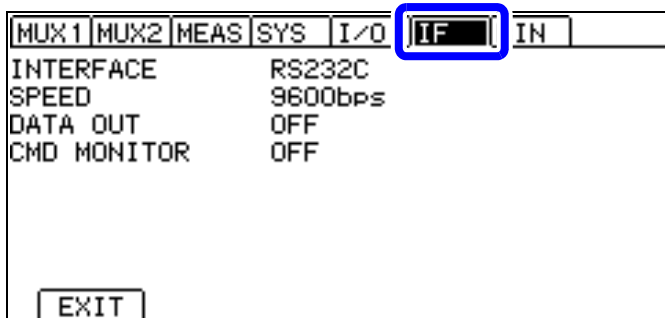

Move the cursor to the **[IF]** tab with the left and right cursor keys.

- 3 Select the interface type.

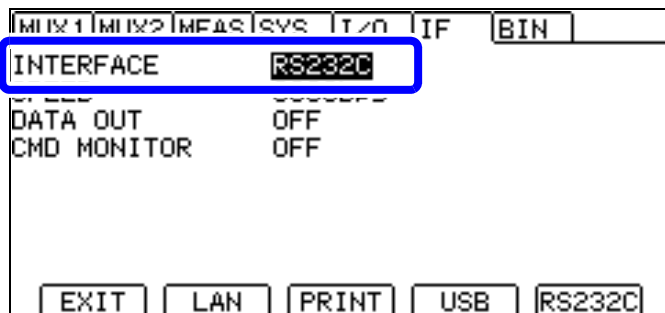

- 1 Selection

- 2 **F 4** RS-232C Interface

F 4

4 Select the interface transfer rate (baud rate).

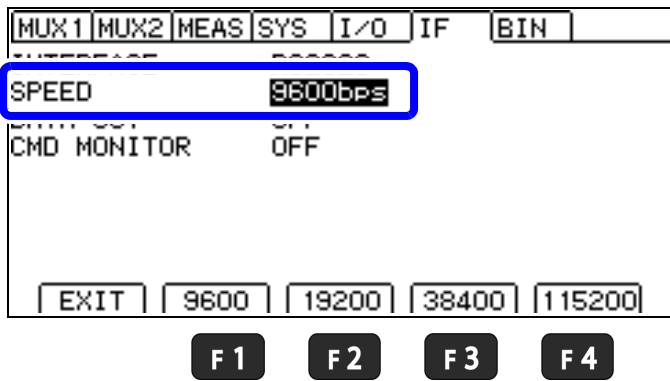

1 ◀ ▶ Selection

2

- F1** 9600 (bps) (default)
- F2** 19200 (bps)
- F3** 38400 (bps)
- F4** 115200 (bps)

5 Select whether to enable or disable the Auto-Exporting function (DATA OUT) (p.248).

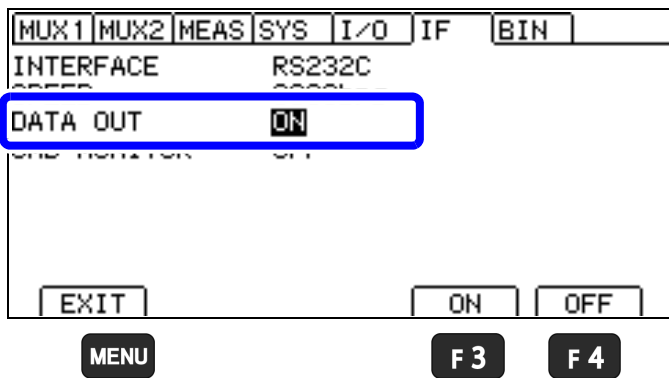

1 ◀ ▶ Selection

2

- F3** Enable auto-exporting
- F4** Disable auto-exporting (default)

MENU Return to the Measurement screen.

IMPORTANT

- Some transmission speed (baud rate) settings may not be usable with some PCs due to a large error component. In this case, switch to a slower setting.
- To control the instrument with commands, set the Auto-Exporting function (DATA OUT) to **[OFF]**. If the function is set to **[ON]**, the response of the measured values may be duplicated or commands may not be accepted.

Configuring the controller (PC, PLC, etc.)

Be sure to make set up the controller as shown below.

- Asynchronous communication
- Transmission speed: 9600 bps, 19200 bps, 38400 bps, 115200 bps (set to match the instrument setting)
- Stop bit: 1
- Data length: 8
- Parity checking: None
- Flow control: None

Connecting the RS-232C cable

Connect the RS-232C cable to the RS-232C connector. When connecting the cable, be sure to tighten the connector in place with screws.

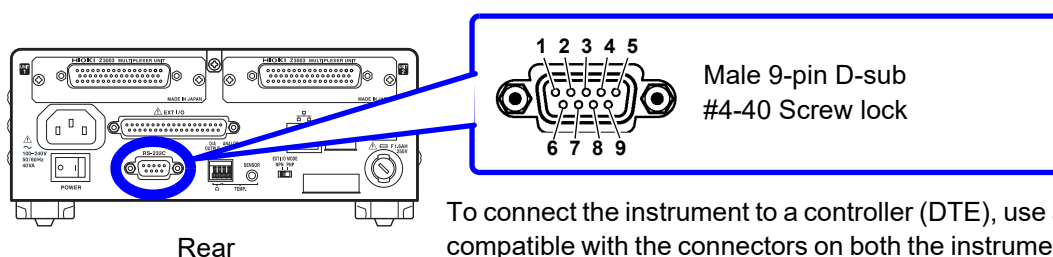

Rear

To connect the instrument to a controller (DTE), use a crossover cable compatible with the connectors on both the instrument and the controller.

The I/O connector is a DTE (Data Terminal Equipment) configuration. This instrument uses only pins 2, 3, and 5. The other pins are unconnected.

Pin Number	Signal name			Mutual connection circuit name	Remarks
	Code	Addr.	JIS		
1	DCD	CF	CD	Carrier Detect	Not used
2	RxD	BB	RD	Receive Data	
3	TxD	BA	SD	Transmit Data	
4	DTR	CD	ER	Data Terminal Ready	ON level (+5 V to +9 V, constant)
5	GND	AB	SG	Signal Ground	
6	DSR	CC	DR	Data Set Ready	Not used
7	RTS	CA	RS	Request to Send	ON level (+5 V to +9 V, constant)
8	CTS	CB	CS	Clear to Send	Not used
9	RI	CE	CI	Ring Indicator	Not used

Connecting the PC to the Instrument

Use a crossover cable with female 9-pin D-sub connectors.

Crossover Wiring

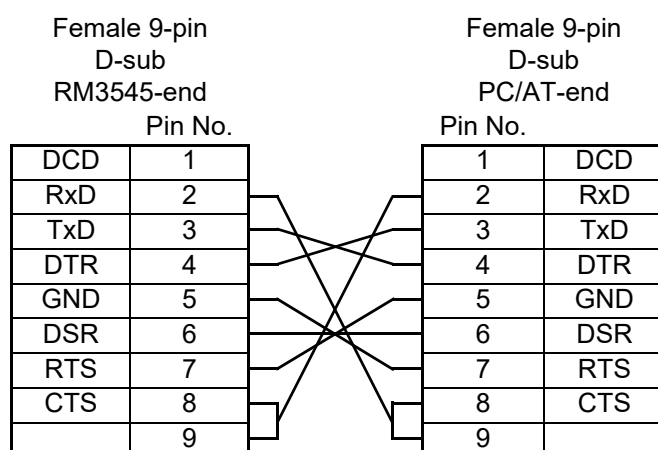

Recommended cable: Hioki L9637 RS-232C Cable (3.0 m)

10.4 LAN Interface

The instrument is equipped with an Ethernet 100BASE-TX interface. The instrument can be controlled with a PC and other devices by connecting the instrument to a network via a LAN cable supporting 10BASE-T or 100BASE-TX.

Connecting the instrument and PC via a network

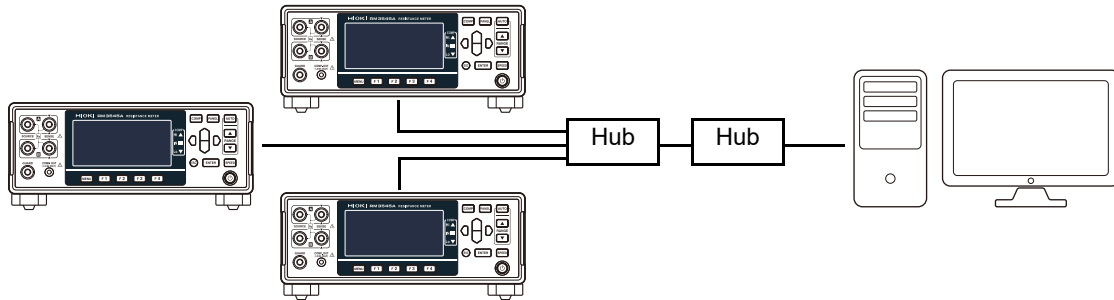

Set different IP addresses for different devices.

Connecting the instrument to a single PC

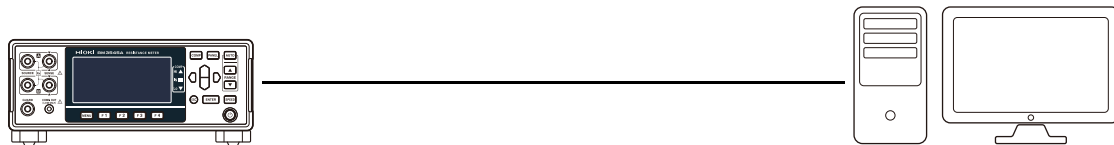

The instrument can be controlled with communications commands by creating a program with a TCP connection to the communications command port.

Configuration of communications

Information to be confirmed before configuration

The detailed settings of the instrument and external devices depend on whether the instrument is connected to an existing network or a new network is formed with the instrument and a PC.

Connecting the instrument to an existing network

The following settings must be assigned in advance by the network system administrator (department). Ensure that the settings are not in conflict with other devices.

<ul style="list-style-type: none"> • Address settings for the instrument <ul style="list-style-type: none"> IP address: _____:_____:_____:_____ Subnet mask: _____:_____:_____:_____ • Gateway <ul style="list-style-type: none"> Using gateway: Yes/No IP address (when using gateway): _____:_____:_____:_____ (Set to 0.0.0.0 if not using gateway) • Port number for communications commands: _____ (Default setting: 23)
--

Forming a new network with the instrument and a PC

(Using the instrument on a local network not externally connected)

If no administrator is present or you are entrusted with the settings, the following settings are recommended.

Example settings

IP address	Assign consecutive numbers as follows.
PC:	192.168.0.1
Instrument first unit:	192.168.0.2
Instrument second unit:	192.168.0.3
Instrument third unit:	192.168.0.4
	↓
Subnet mask:	255.255.255.0
Gateway:	OFF
Communications command port number:	23

Settings

IP address	This address is used to identify each device connected on the network. Ensure that the address is not in conflict with other devices.
Subnet mask	This setting is used to divide an IP address into an address part indicating the network and an address part indicating the devices. Set the same value as the subnet mask of the devices within the same network.
Default gateway IP address	<p>For network connection</p> <p>If the PC to be used (communicating device) is on a network different from the network to which the instrument is connected, set the IP address of the default gateway.</p> <p>If the PC is on the same network as the instrument, generally set the same value as the IP address of the default gateway address of the PC setting.</p> <p>Connecting the instrument and PC on a one-to-one basis, without using a gateway</p> <p>Set the IP address of the default gateway to 0.0.0.0.</p>
Communications command port number	Set the TCP/IP port number to be used for the connection.

Configuring communications

- 1 Open the Settings screen.

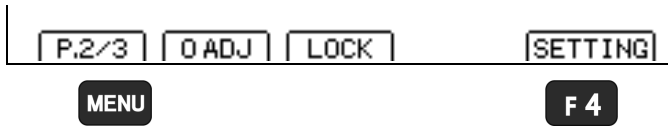

- 1 **MENU** Switch the function menu to P.2/3.

- 2 **F4** The Settings screen appears.

- 2 Open the Communications Interface Setting screen.

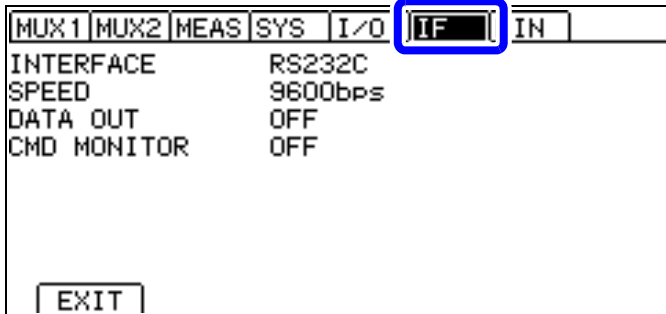

Move the cursor to the **[IF]** tab with the left and right cursor keys.

- 3 Select the interface type.

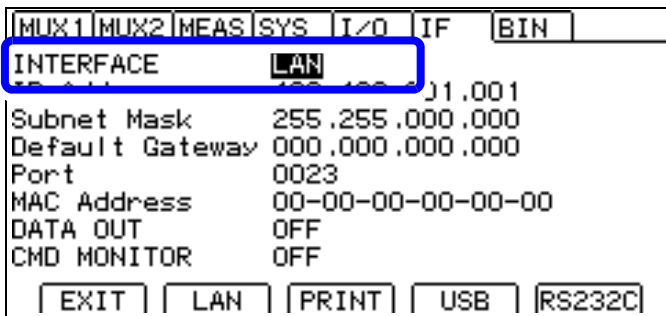

F1

- 1 Selection

- 2 **F1** LAN Interface

- 4 Set the IP address.

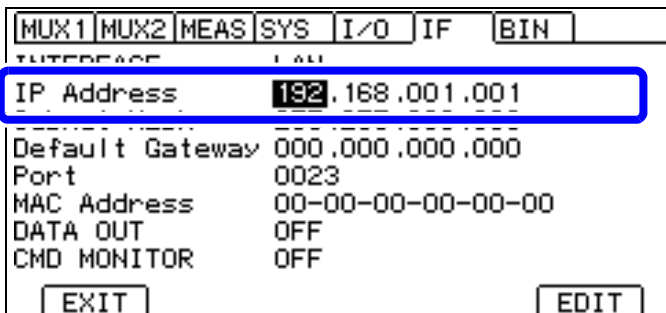

F4

- 1

Move the cursor to the setting you wish to configure. Make the value editable with the **F4** key.

- 2 Move among digits. Change values.
Move the cursor to the digit you wish to set with the left and right cursor keys. Change the value with the up and down cursor keys.

- 3 **ENTER** Accept
(**ESC**) Cancel)

Setting range: 000.000.000.000 to 255.255.255.255
(default: 192.168.001.001)

5 Set the subnet mask.

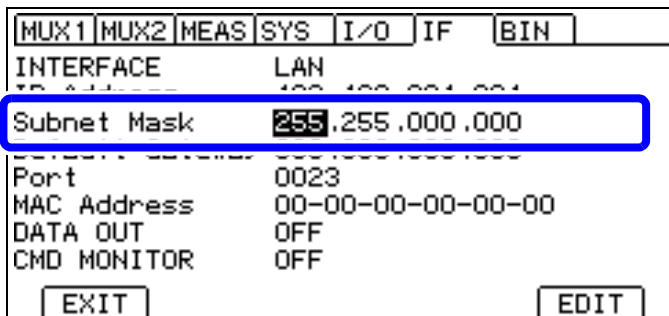

F 4

Setting range: 000.000.000.000 to 255.255.255.255
(default: 255.255.000.000)

6 Set the default gateway.

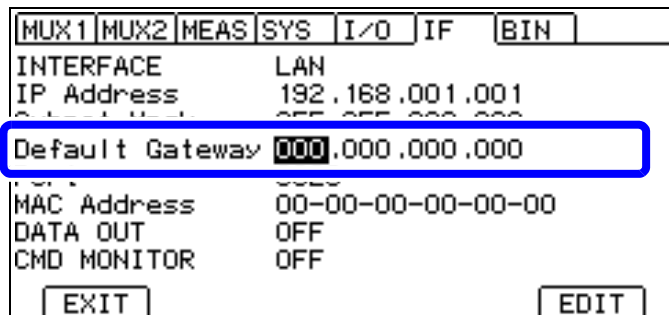

F 4

Setting range: 000.000.000.000 to 255.255.255.255
(default: 000.000.000.000 (OFF))

7 Set the communications command port.

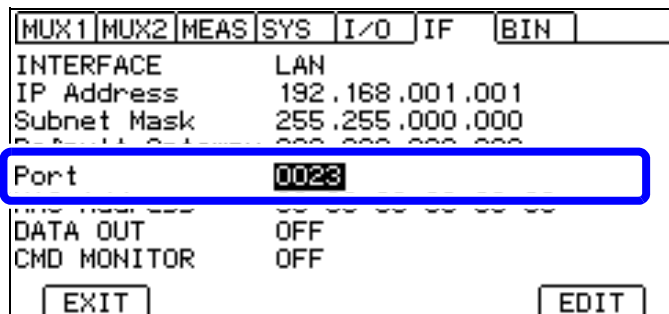

MENU

F 4

Setting range: 11 to 65535 (except 80)
(default: 23)



1 Move the cursor to the setting you wish to configure. Make the value editable with the **F 4** key.

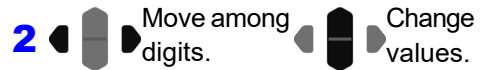

2 Move among digits. Change values. Move the cursor to the digit you wish to set with the left and right cursor keys. Change the value with the up and down cursor keys.

3 **ENTER** Accept
(**ESC** Cancel)



1 Move the cursor to the setting you wish to configure. Make the value editable with the **F 4** key.

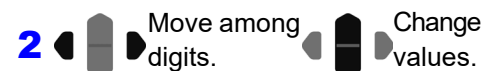

2 Move among digits. Change values. Move the cursor to the digit you wish to set with the left and right cursor keys. Change the value with the up and down cursor keys.

3 **ENTER** Accept
(**ESC** Cancel)



1 Move the cursor to the setting you wish to configure. Make the value editable with the **F 4** key.

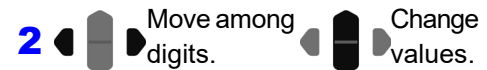

2 Move among digits. Change values. Move the cursor to the digit you wish to set with the left and right cursor keys. Change the value with the up and down cursor keys.

3 **ENTER** Accept
(**ESC** Cancel)

8 Select whether to enable or disable the Auto-Exporting function (DATA OUT) (p.248).

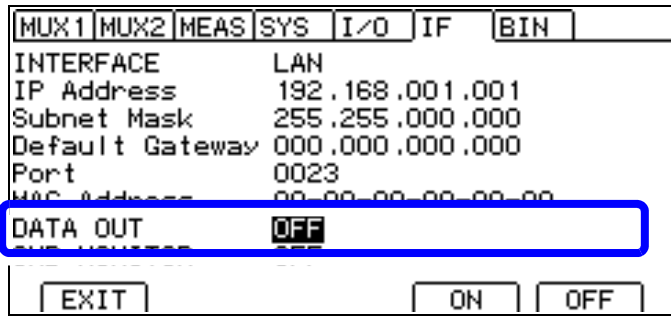

- 1 Selection
- 2 ON
 OFF (default)

MENU

F 3

F 4

MENU

Return to the Measurement screen.

IMPORTANT

To control the instrument with commands, set the Data Output function (DATA OUT) to **[OFF]** (p.236). If the function is set to **[ON]**, the response of the measured values may be duplicated or commands may not be accepted.

Connecting the LAN cable

Connect a LAN cable to the instrument's LAN connector.

CAUTION

■ If routing a LAN cable outdoors or over more than 30 m, attach a LAN surge protector other suitable protective device.



Failure to do so could cause damage to the product due to increased susceptibility to the effects of induced lightning.

Recommended cable: LAN cable supporting 100BASE-TX or 10BASE-T (both straight and crossover cables can be used)

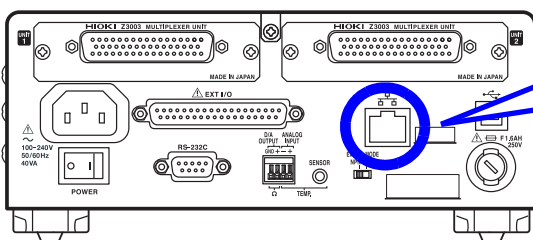

Rear

Green LED
On: Linking
Blinking: Communicating



Orange LED
Off: 10BASE-T
On: 100BASE-TX

If the green LED does not light up even when the instrument is connected to the LAN, the instrument or connected devices may be malfunctioning or the LAN cable may be broken.

10.5 Controlling the Instrument with Commands and Acquiring Data

For more information about communications commands and query notation (from the communications message reference), see the Communications Command Instruction Manual. The Instruction Manual can be downloaded from Hioki's website.

<https://www.hioki.com/global/support/download/>

When creating programs, the command monitor function (p.245) can be used to display commands and their associated responses on the Measurement screen.

IMPORTANT

- When the interface setting is set to the printer, proper command operation is not guaranteed. Do not send commands.
- To control the instrument with commands, set the Data Output function (DATA OUT) to **[OFF]** (p.236). If the function is set to **[ON]**, the response of the measured values may be duplicated or commands may not be accepted.

Remote and local states

During remote control operation, **[RMT]** appears on the Measurement screen, and all except the **MENU** key are disabled.

MENU Pressing **[LOCAL]** disables remote control and re-enables the operating keys.

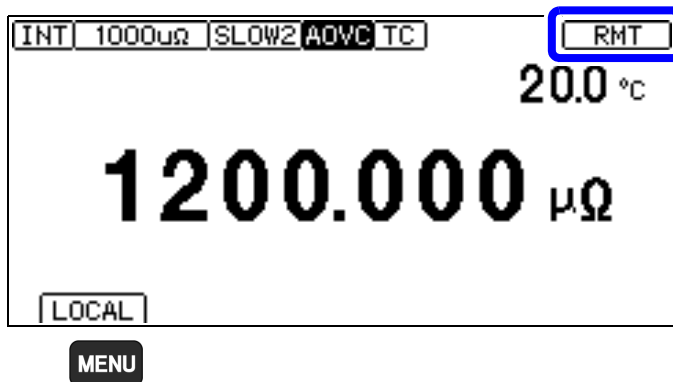

Displaying communications commands (command monitor function)

The command monitor function can be used to display responses to communications commands and queries on the instrument's screen.

1 Open the Settings screen.

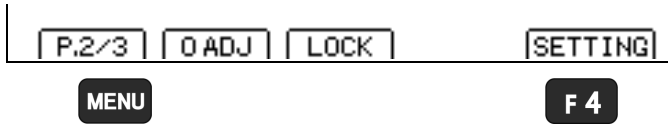

1 **MENU** Switch the function menu to P.2/3.

2 **F 4** The Settings screen appears.

2 Open the Communications Interface Setting screen.

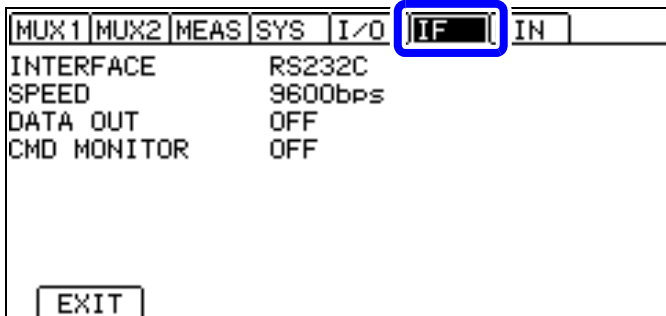

Move the cursor to the **[IF]** tab with the left and right cursor keys.

3 Enable or disable the command monitor function.

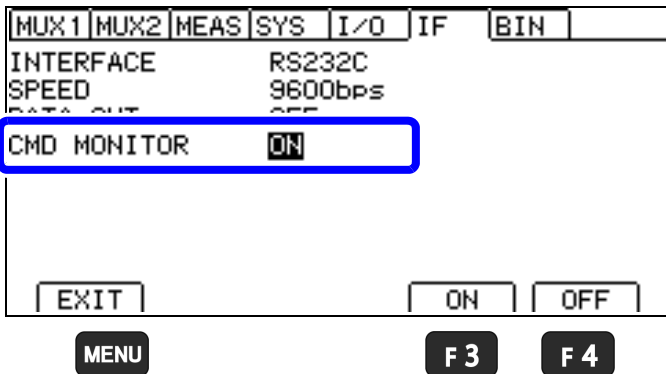

1 Selection

2 **F 3** ON
F 4 OFF (default)

MENU Return to the Measurement screen.

4 Command and queries will be displayed on the bottom of the Measurement screen.

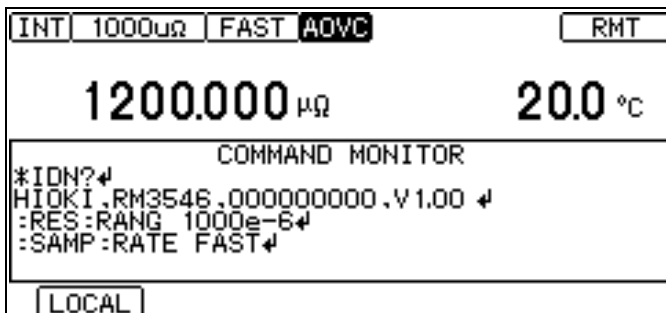

Messages displayed in the command monitor and their meanings

If an error occurs during command execution, the following information will be displayed:

- Command error (improper command, improper argument format, etc.)

> **#CMD ERROR**

- Argument out of range

> **#PARAM ERROR**

- Execution error

> **#EXE ERROR**

The approximately location of the error will also be shown.

- Argument error (-1 is out of range)

> **:RES:RANG -1**

> **# ^ PARAM ERROR**

- Spelling error (for example, using "RENGE" instead of "RANGE")

> **:RES:RENGE 100**

> **# ^ CMD ERROR**

IMPORTANT

- If an illegal character code is received, the character code will be shown in hexadecimal notation enclosed in angle brackets (< >).

For example, the character 0xFF would be displayed as **<FF>**, and 0x00 would be displayed as **<00>**.

If all you see is hexadecimal characters like this when using the RS-232C interface, check the communications conditions or try using a lower communications speed.

- When using the RS-232C interface

If an RS-232C error occurs, the following information will be displayed:

```

Overrun error (signal lost) ..... #Overrun Error
Break signal received ..... #Break Error
Parity error ..... #Parity Error
Framing error ..... #Framing Error

```

If any of these messages is displayed, check the communications conditions or try using a lower communications speed.

- The error position may shift, for example when sending a series of consecutive commands.

Acquiring measured values at once (data memory function)

Operation slows when measured values are acquired after each measurement. To avoid this delay, up to 50 measured values can be stored in memory and acquired at once later.

Measured values are stored in memory as follows:

- Every time a measurement is performed by external (EXT) triggering
- When a trigger is applied during internally (INT) triggered measurement

The following three storage methods are available:

- Store upon receiving an EXT. I/O TRIG signal (p.185)
- Store upon receiving a *TRG command
- Pressing the  key.

IMPORTANT

- This function can only be enabled by communications command. The data memory function should be enabled by communications command beforehand. This setting is not available from the front panel key operation.
- Stored memory data cannot be viewed on the instrument's screen. Use communications commands to export stored data.
- Once 50 measured values have been stored, new measured values cannot be stored until the memory is cleared.
- When the multiplexer measurement terminals are selected, the data memory function is automatically turned off.

For more information about commands, see the Communications Command Instruction Manual. The Instruction Manual can be downloaded from Hioki's website.

<https://www.hioki.com/global/support/download/>

Stored data is automatically erased at the following times:

- when changing measurement conditions (range, low-power mode, pure resistance mode, measurement current, OVC, 100 MΩ range high-precision mode, TC)
- when changing memory function settings
- when the comparator is set (p.99)
- when changing BIN measurement function settings (p.109)
- when ΔT is set (p.118)
- upon system reset (p.137)
- when turning off the instrument

10.6 Outputting Measured Values to External Devices without Controlling the Instrument with Commands (Data Output Function)

The measured value can be output to external devices via the communications interface without controlling the instrument with commands.

The following two types of the Data Output function are available.

(1) Auto-Exporting Function (DATA OUT): RS-232C, LAN, USB (COM mode)

Data is output to serial communications (COM, RS-232C communication) verification software or to a receiving program created by the user.

When the external triggering is enabled: Once the measurement completes, the instrument can send the data automatically.

When the internal triggering is enabled: When **ENTER** is pressed or the EXT. I/O TRIG signal is input, the instrument sends the data.

When the automatic send (DATA OUT) function is enabled

	TRIG settings	
	INT	EXT
When ENTER key depressed Or TRIG signal input received	Most recent measured value output	Measurement performed once and measured value after measurement completes output
When measured value held with auto hold function enabled	Held measured value output	-

Setting method:

Step **5** of “Configuring communications” in “RS-232C Interface” (p.236)

Step **8** of “Configuring Communications” in “LAN Interface” (p.243)

Step **4** of “Configuring Communications” in “USB Interface” (p.233)

(2) USB Keyboard Mode: USB (KEYBD)

Data is written to a text editor or spreadsheet application as if it were being typed on a keyboard.

Be sure to launch the text editor or spreadsheet application and position the cursor where you wish the data to be written before outputting the data. Improper placement of the cursor will cause the data to be overwritten at that point. Be sure to set the input mode of the PC to single-byte characters.

When **ENTER** is pressed or the EXT. I/O TRIG signal is input, the instrument sends the data.

The data can be output only if the internal triggering is enabled.

	TRIG settings	
	INT	EXT
When ENTER key depressed Or TRIG signal input received	Most recent measured value output	-
When measured value held with auto hold function enabled	Held measured value output	-

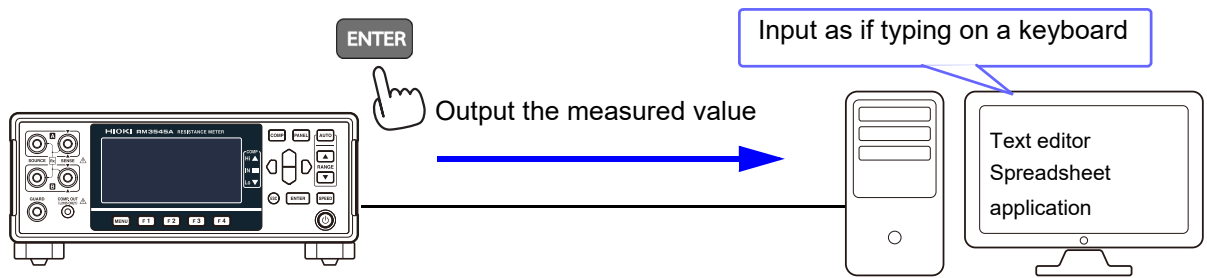

Setting method:

This method can be used when the trigger source is set to **[INT]** (internal triggering) and the USB interface is set to **[KEYBD]** (USB keyboard).

Step **3** in “10.4 External I/O Settings” (p.218)

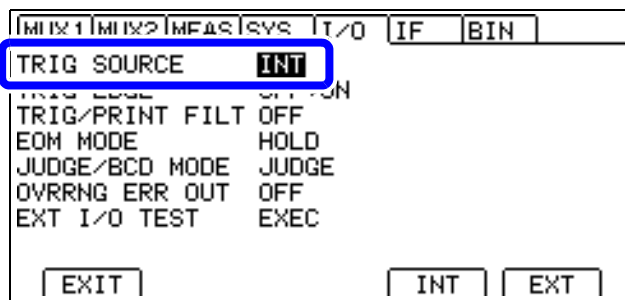

Step **4** of “Configuring communications” in “USB Interface” (p.233)

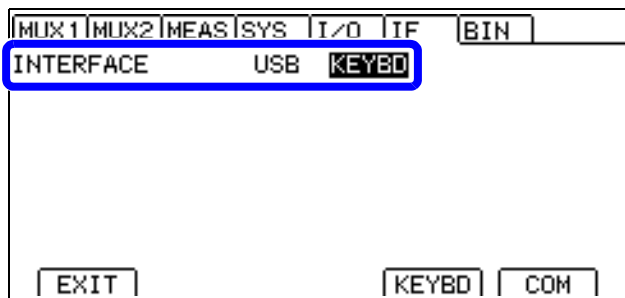

IMPORTANT

This function cannot be used when the scan function is set to auto or step while using the MUX measurement terminals.

Output data format

Measured value format when scaling is off

(The measured value format varies depending on scaling. (p.78))

Changing the number of digits in the measured value will not change the format. Undisplayed digits have a value of 0.

- Resistance value (Absolute value display, unit: Ω)

Low-power mode	Measurement range	Measured value	±OvrRng	Measurement fault
OFF	1000 μΩ	±0000.000E-06	±1000.000E+17	+1000.000E+27
	10 mΩ	±00.00000E-03	±10.00000E+19	+10.00000E+29
	100 mΩ	±000.00000E-03	±100.00000E+18	+100.00000E+28
	1000 mΩ	±0000.000E-03	±1000.000E+17	+1000.000E+27
	10 Ω	±00.00000E+00	±10.00000E+19	+10.00000E+29
	100 Ω	±000.00000E+00	±100.00000E+18	+100.00000E+28
	1000 Ω	±0000.000E+00	±1000.000E+17	+1000.000E+27
	10 kΩ	±00.00000E+03	±10.00000E+19	+10.00000E+29
	100 kΩ	±000.00000E+03	±100.00000E+18	+100.00000E+28
	1000 kΩ	±0000.000E+03	±1000.000E+17	+1000.000E+27
	10 MΩ	±00.00000E+06	±10.00000E+19	+10.00000E+29
	100 MΩ	±000.00000E+06	±100.00000E+18	+100.00000E+28
	1000 MΩ	±0000.000E+06	±1000.000E+17	+1000.000E+27
ON	1000 mΩ	±0000.00E-03	±1000.00E+17	+1000.00E+27
	10 Ω	±00.0000E+00	±10.0000E+19	+10.0000E+29
	100 Ω	±000.000E+00	±100.0000E+18	+100.000E+28
	1000 Ω	±0000.00E+00	±1000.00E+17	+1000.00E+27

- Resistance value (Relative value display, unit: %)

Measured value	±OvrRng	Measurement fault
±000.000E+00	±100.000E+18	+100.000E+28

- Temperature, temperature conversion display (unit: °C)

Measured value	±OvrRng	Measurement fault
±000.0E+00	±100.0E+18	+100.0E+28

For positive measured values, a space (ASCII 20H) represents the “+” sign.

When ±OvrRng is displayed, values are ±1E+20. When a measured value fault occurs, values are +1E+30.

Preparing connected equipment (PC or PLC)

When outputting data with the COM port

Place the equipment in the receive standby state. If connecting the instrument to a PC, launch the application software and place it in the receive standby state.

11 Printing

(Using an RS-232C Printer)

Connecting the Printer
to the Instrument

Make instrument
settings. (p.252)

Make printer
settings

Printing (p.253)

- Measured values and comparator judgments
- List of measurement conditions and settings
- Statistical calculation results

11.1 Connecting the Printer to the Instrument



WARNING

- Before connecting a printer, turn off the instrument and the printer.
- Connect the printer cable securely.



Connecting the cable while either device is powered on could cause the operator to experience an electric shock or damage the instrument or printer. Touching other conductive parts when the cable is disconnected could cause a short-circuit or bodily injury.

Printer

The requirements for a printer to be connected to the instrument are as follows.

Confirm compatibility and make the appropriate settings on the printer before connecting it to the instrument.

See: "Instrument Settings" (p.252)

- Interface RS-232C
- Characters per line At least 48
- Communication speed 9600 bps (default setting)/ 19,200 bps/ 38,400 bps/ 115,200 bps
- Data bits 8 bit
- Parity checking None
- Stop bit 1 bit
- Flow control None
- Control codes Must be able to print plain text directly.
- Message terminator (delimiter) CR+LF

Instrument Settings

- 1 Open the Settings screen.

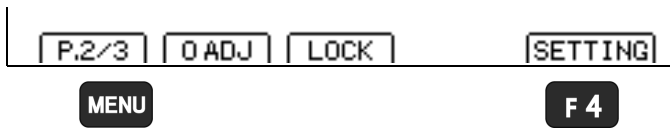

- 1 **MENU** Switch the function menu to P.2/3.

- 2 **F 4** The Settings screen appears.

- 2 Open the Communications Interface Setting screen.

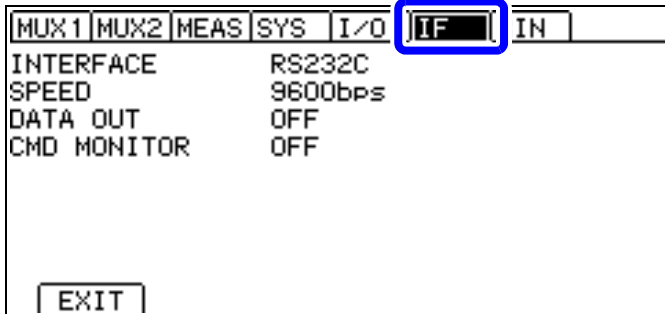

Move the cursor to the **[IF]** tab with the left and right cursor keys.

- 3 Select PRINT as the interface type.



- 1  Selection

- 2 **F 2** To use the printer

MENU Return to the Measurement screen.

11.2 Printing

Before printing

Verify that the instrument settings (p.252) are correct.

Printing measured values and comparator judgments

Printing by key operation

Pressing **F4** on Measurement screen P.1/3 causes the current measured value to be printed.

When the temperature is not being displayed, only the resistance value will be printed. When the temperature is being displayed, both the resistance value and the temperature will be printed.

See: "Switching the display" (p.53)

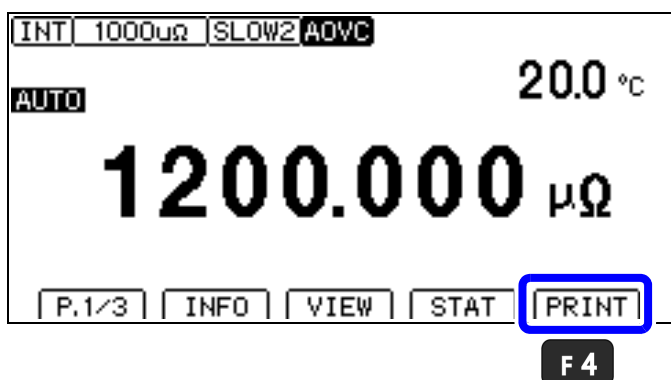

Printing by external control

When the instrument's EXT. I/O connector's PRINT signal is turned ON (by shorting it with the EXT. I/O connector's ISO_COM pin), you can print measured values and judgment results.

- To print continuously for each measurement, connect the EOM signal to the PRINT signal and set the instrument to use the internal trigger.
- To print after the completion of trigger-based measurement using an external trigger, connect the EXT. I/O EOM signal to the PRINT signal.
- When using the internal trigger setting with the statistical calculation function ON, statistical calculation will be performed with the latest updated measured value when the PRINT signal is turned ON.

Printing list of measurement conditions and settings

Press **F1** [INFO] on the Measurement screen P.1/3 to display a list of settings first, and then press **F4** [PRINT] to print a list of measurement conditions and settings.

See: “Displaying a list of model and measurement conditions” (p.55)

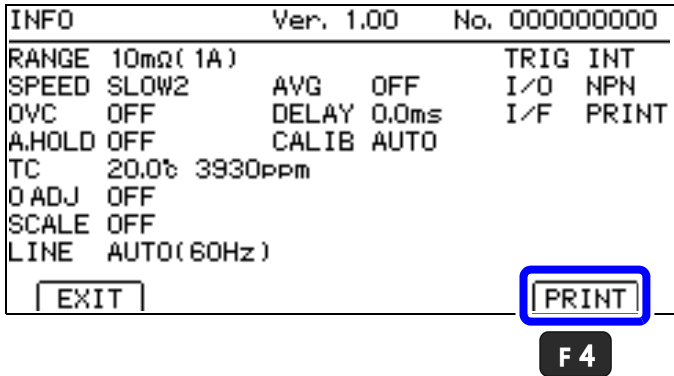

Changing the number of columns printed per row

Normally a row consists of one column, but you can also print three columns per row. When printing three columns per row, the temperature and interval time are not printed.

- 1 Open the Settings screen.

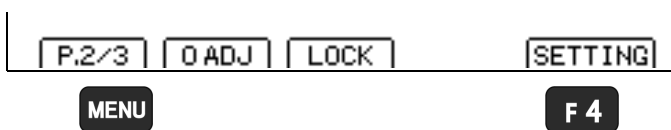

- 1 **MENU** Switch the function menu to P.2/3.

- 2 Open the Communications Interface Setting screen.

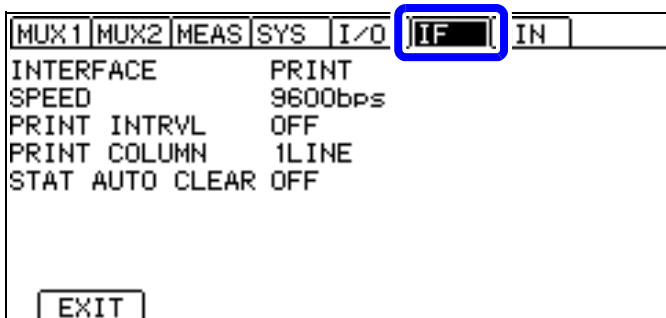

- 2 **F4** The Settings screen appears.



Move the cursor to the [IF] tab with the left and right cursor keys.

- 3 Select the number of print columns.

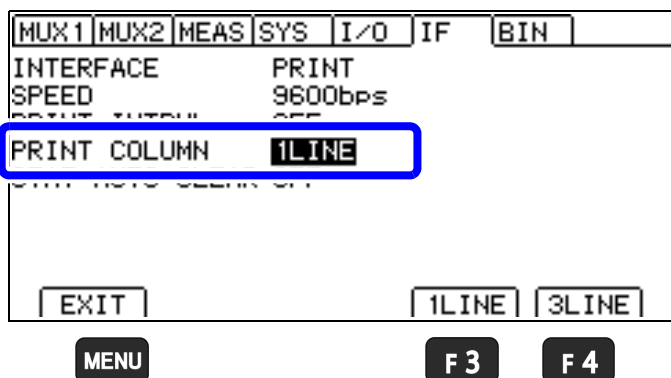

- 1 Selection

- 2 **F3** 1 column (default)
F4 3 columns

MENU Return to the Measurement screen.

Interval printing

You can automatically print measured values at a fixed time interval.

- 1 Open the Settings screen.

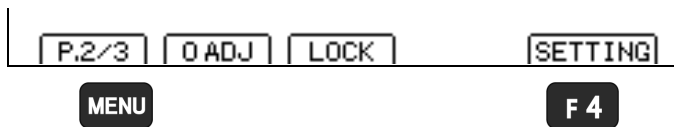

- 1 **MENU** Switch the function menu to P.2/3.

- 2 **F4** The Settings screen appears.

- 2 Open the Communications Interface Setting screen.

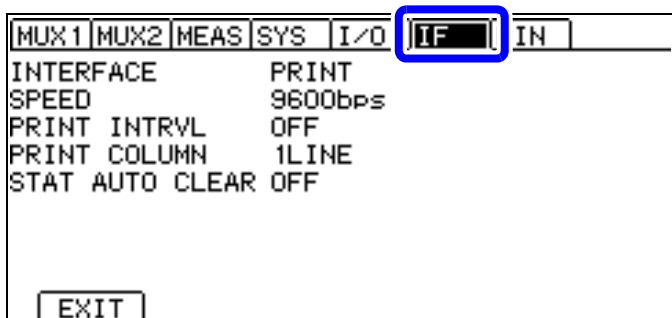

Move the cursor to the **[IF]** tab with the left and right cursor keys.

- 3 Enable the interval function.

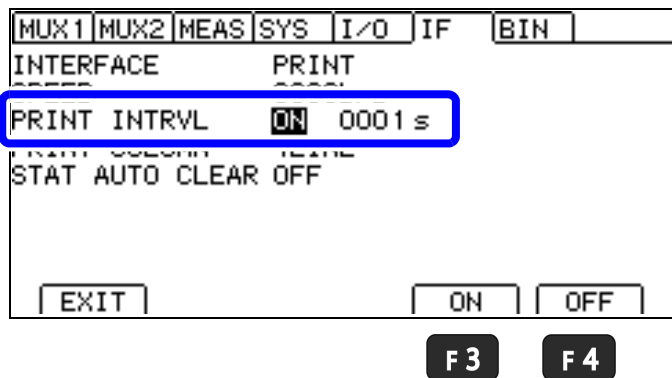

- 1 Selection

- 2 **F3** ON

- 2 **F4** OFF (default)

4 Set the interval.

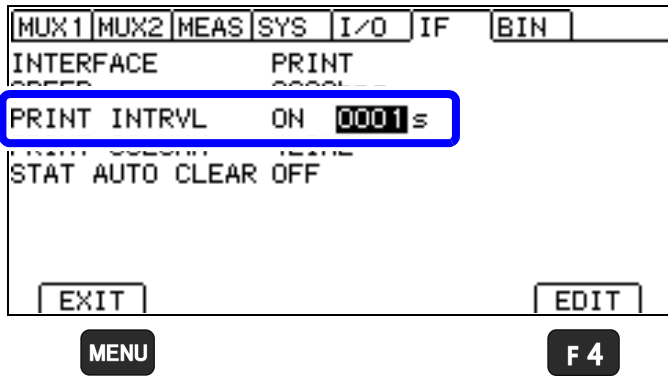

Setting range: 0 to 3600 seconds
(Using a setting of 0 sec. disables automatic printing.)

1 Move the cursor to the setting you wish to configure. Make the value editable with the **F4** key.

2 Move among digits. Change values. Move the cursor to the digit you wish to set with the left and right cursor keys. Change the value with the up and down cursor keys.

3 **ENTER** Accept
(**ESC** Cancel)

MENU Return to the Measurement screen.

Interval printing operation

- 1** Interval printing starts with the **F4** **[PRINT]** key or EXT. I/O PRINT signal input.
- 2** Every time the set interval elapses, the elapsed time (in hours:minutes:seconds format)*1 and measured value are printed.

Note that when **ENTER** or EXT. I/O TRIG signal is input, the elapsed time and measured value at that point in time are displayed.
- 3** Interval printing stops when the **F4** **[PRINT]** key or PRINT signal input is received again.

*1. When the elapsed time reaches 100 hours, it is reset to 00:00:00 and starts counting from 0 again.

Example: 99 hours 59 minutes 50 seconds elapsed: 99:59:50
100 hours 2 minutes 30 seconds elapsed: 00:02:30

IMPORTANT

- Since measurement conditions and measured values will be mixed together when measurement conditions are printed during interval printing, avoid printing settings while interval printing is in progress.
- Interval printing cannot be used when the multiplexer's scan function is set to auto or step.

Printing statistical calculation results

Statistical calculation results can be printed when statistical calculation is enabled (ON). To print, select PRINT on the screen.

To enable statistical calculation:

See: "4.17 Performing Statistical Calculations on Measured Values" (p.112)

(When statistical calculation is enabled)



F3

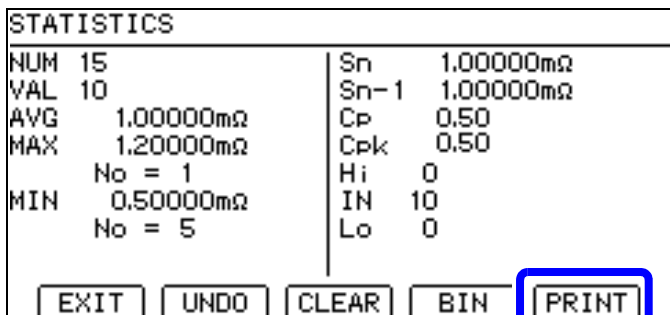

F4

If no valid data exists, only the data count is printed. When only one valid data sample exists, standard deviation of sample and process capability indices cannot be printed.

Clearing statistical calculation results after each is printed

You can clear statistical calculation results automatically after each is printed.

- 1 Open the Settings screen.

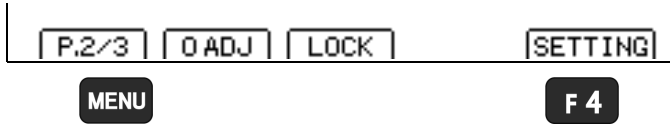

- 1 **MENU** Switch the function menu to P.2/3.

- 2 **F 4** The Settings screen appears.

- 2 Open the Communications Interface Setting screen.

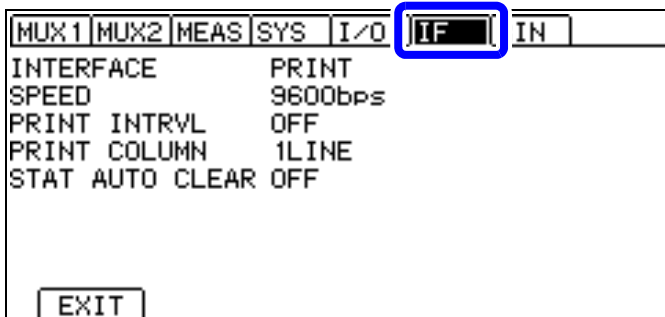

Move the cursor to the **[IF]** tab with the left and right cursor keys.

- 3 Enable the statistical calculation clear function.

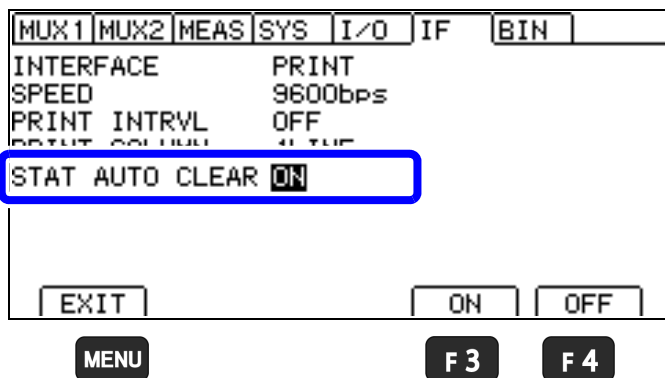

- 1  Selection

- 2 **F 3** Turn ON the statistical calculation clear function.

- F 4** Turn OFF the statistical calculation clear function. (default)

- MENU** Return to the Measurement screen.

Example Printouts

◆ Resistance measured value, relative value, and temperature measured value (printing one column per row)

- Resistance measured value and temperature measured value

```
2023-10-01 14:24:02 99.9758mOhm
2023-10-01 14:25:54 9.9756mOhm
2023-10-01 14:27:02 -0.0058mOhm, ----
2023-10-01 14:28:02 99.9758kOhm, 25.0 C
2023-10-01 14:29:02 99.9758MOhm, +OvrRng
2023-10-01 14:30:02 +OvrRng
2023-10-01 14:48:40 -----
```

- Comparator (ABS)

```
2023-10-01 14:49:02 99.9758mOhm Hi , 25.0 C
2023-10-01 14:50:02 10.9008mOhm IN
2023-10-01 14:51:02 9.9758mOhm Lo
```

- Comparator (REF%)

```
2023-10-01 14:52:11 10.000 % Hi
2023-10-01 14:53:11 -0.010 % IN
2023-10-01 14:55:11 -100.000 % Lo
```

- BIN ON

```
2023-10-01 14:56:31 5.0007mOhm 01
2023-10-01 14:57:25 10.0005mOhm OB
```

- ΔT ON

```
2023-10-01 14:58:52 175.6 C
```

◆ Resistance measured value (printing three columns per row)

```
10.0004mOhm, 10.0006mOhm, 0.0004mOhm
```

◆ Interval printing

```
00:00:00 10.0004mOhm
00:00:01 10.0011mOhm
00:00:02 10.0001mOhm
00:00:03 10.0005mOhm
00:00:04 10.0000mOhm
00:00:05 10.0005mOhm
```

◆ Multiplexer scan results **RM3545A-2**

```
2023-10-01 14:00:11 Total judge FAIL
01 99.9758MOhm Hi FAIL
02 9.9758MOhm IN PASS
03 100.9758MOhm Lo PASS
```

Do not print results during scanning.

◆ **List of measurement conditions and settings**

```

MODEL  RM3545A-2
NO.    000000000
VER.   1.00
RANGE  10mOhm(1A)
SPEED  FAST
AVG    10
OVC    ON
DELAY  10ms
A.HOLD OFF
CALIB  AUTO
TC     OFF
0 ADJ  OFF
SCALE  OFF
LINE   AUTO(60Hz)
TRIG   INT
I/O    NPN
I/F    PRINT

```

◆ **Statistical calculation results (comparator)**

```

DATE - TIME  2023-10-01 14:01:11
NUMBER      11
VALID       10
AVERAGE    1200.160mOhm
MAX         1200.200mOhm (No = 9)
MIN         1200.130mOhm (No = 1)
Sn          0.00020mOhm
Sn-1        0.00028mOhm
Cp          0.19
Cpk         0.03
COMP Hi     4
COMP IN     6
COMP Lo     0

```

The “Valid” statistical calculation result indicates the number (count) of data samples not subject to errors such as measurement faults.

◆ **Statistical calculation results (BIN)**

```

DATE - TIME  2023-10-01 14:01:11
NUMBER      11
VALID       10
AVERAGE    1200.160mOhm
MAX         1200.200mOhm (No = 9)
MIN         1200.130mOhm (No = 1)
Sn          0.00020mOhm
Sn-1       0.00028mOhm
BIN0 10.000mOhm - 0.000mOhm 3
BIN1 20.000mOhm - 10.000mOhm 1
BIN2 30.000mOhm - 20.000mOhm 3
BIN3 40.000mOhm - 30.000mOhm 2
BIN4 50.000mOhm - 40.000mOhm 3
BIN5 60.000mOhm - 50.000mOhm 10
BIN6 70.000mOhm - 60.000mOhm 2
BIN7 80.000mOhm - 70.000mOhm 2
BIN8 90.000mOhm - 80.000mOhm 3
BIN9 100.000mOhm - 90.000mOhm 3
Out of BIN                                5

```

The “Valid” statistical calculation result indicates the number (count) of data samples not subject to errors such as measurement faults.

12 Specifications

12.1 General Specifications

Operating environment	Indoor use, pollution degree 2, altitude up to 2000 m (6562 ft.)	
Operating temperature and humidity range	0°C to 40°C (32°F to 104°F), 80% RH or less (non-condensing)	
Storage temperature and humidity range	-10°C to 50°C (14°F to 122°F), 80% RH or less (non-condensing)	
Standards	Safety EN 61010 EMC EN 61326 Class A	
Power supply	Rated supply voltage	Commercial power supply 100 V to 240 V AC (Voltage fluctuations of ±10% from the rated supply voltage are taken into account)
	Rated power-supply frequency	50 Hz/60 Hz
	Anticipated transient overvoltage	2500 V
	Maximum rated power	40 VA
	Normal power consumption (reference value)	16 W (measurement current 1 A, LCD on)
Backup battery life	Approx. 10 years (reference value at 23°C)	
Interfaces	LAN, USB, RS-232C	
Dimensions	Approx. 215W × 80H × 306.5D mm (8.46W × 3.15H × 12.07D in.)(except protruding parts)	
Weight	Approx. 2.7 kg (6.0 lbs) (RM3545A-1) Approx. 3.4 kg (7.5 lbs) (RM3545A-2)	
Product warranty duration	3 years	
Fuse	F1.6AH 250 V (installed inside the main body, replaceable)	
Included accessories	See: p.2	
Options	See: p.3	

12.2 Input Specifications/Output Specifications/Measurement Specifications

Basic specifications

Measurement items Resistance, temperature

Measurement range
Resistance

LP*1	PR*2	100 MΩ range High-precision	Measuring range and full scale	Number of ranges
OFF	-	OFF	000.000 μΩ (1000 μΩ range) to 1200.0 MΩ (1000 MΩ range) 10 MΩ range or less: full scale = 1,000,000 digits 100 MΩ range or greater: full scale = 10,000 digits	13
		ON	000.000 μΩ (1000 μΩ range) to 120.000 0 MΩ (100 MΩ range) Full scale = 1,000,000 digits	12
ON	OFF	-	0.00 mΩ (1000 mΩ range) to 1200.00 Ω (1000 Ω range) Full scale = 100,000 digits	4

*1. Low-power mode

*2. Pure resistance mode

Temperature: -10.0°C to 99.9°C

Measurement signal Constant current

Measurement method DC four-terminal method

Measurement current 1 A,
100 mA, 10 mA, 1 mA,
500 μA, 100 μA, 50 μA, 10 μA, 5 μA, 1 μA, 1 μA or less,
100 nA
Depends on the measurement ranges
See: "Measurement accuracy" (p.271)

Measurement terminals

Banana terminals	
SOURCE A terminal	Current detection terminal
SOURCE B terminal	Current source terminal
SENSE A terminal	Voltage detection terminal
SENSE B terminal	Voltage detection terminal
GUARD terminal	Guard terminal

Measurement time**Resistance measurement (tolerance: $\pm 10\%$ ± 0.2 ms)**

- (1) When using the internal trigger source with continuous measurement on (free-run): Time of 1 measurement when the measurement target is connected

Calculation formulas

	OVC*1
OFF	$(D + E1) \times N + F + G$
ON	$(C + D + E2) \times 2 \times N + F + G$

- (2) When using an external trigger source or with continuous measurement off (non-free-run): From trigger input until EOM turns on

Calculation formulas

	OVC*1
OFF	$A + B + (C + D + E2) \times N + F$
ON	$A + B + (C + D + E2) \times 2 \times N + F$

*1. In the 1000 $\mu\Omega$ range or when LP is on, OVC is fixed to on.

Calculate the measurement time with (1) and (2) by substituting the following values of *A* to *G* and *N* into the calculation formulas.

A: Trigger detection time (unit: ms) *B*: Contact improvement time (unit: ms) *C*: Delay setting (unit: ms)

TRIG logic setting	Time	Contact improvement function	Time	Time
ON edge	0.1	OFF	0.0	Varies with setting.
OFF edge	0.3	ON	0.2	

D: Integration time (unit: ms) (detected voltage data acquisition time)

LP	Range	FAST		MEDIUM		SLOW1	SLOW2
		50 Hz	60 Hz	50 Hz	60 Hz		
OFF	1000 k Ω or less	0.3*2		20.0	16.7	100	200
	10 M Ω or more	20.0	16.7	20.0	16.7	100	200
ON	All ranges	20.0	16.7	40.0	33.3	200	300

*2. When using the MUX measurement terminals, the integration time is 1.0 ms in the 1000 $\mu\Omega$ range and 10 m Ω range.

E1: Internal wait time 1 (unit: ms) (Processing time before and after integration measurement)

Time
0.4

E2: Internal wait time 2 (unit: ms) (Processing time before and after integration measurement)

LP: OFF and PR: Off

Range	Measurement current	Time	100 MΩ Range High-precision mode
1000 μΩ	High	40	-
10 mΩ	High	40	
100 mΩ	High	40	
	Low	2.4	
1000 mΩ	High	2.6	
	Low	1.6	
10 Ω	High	1.8	
	Low	2.1	
100 Ω	High	1.9	
	Low	2.4	
1000 Ω	-	2.4	
10 kΩ		6.0	
100 kΩ		16	
1000 kΩ		130	
10 MΩ		500	
100 MΩ		1300	
		320	OFF
1000 MΩ		340	OFF

PR: On

Range	Measurement current	Time
PR1000 μΩ	High	20
PR10 mΩ	High	20
PR100 mΩ	-	20

LP: On

Range	Time
LP1000 mΩ	15
LP10 Ω	35
LP100 Ω	35
LP1000 Ω	36

F: Calculation time (unit: ms)

Setting	Time
Statistical calculation: OFF Scaling: OFF Measured value display switching: None	0.1

G: Self-calibration time (unit: ms)

Self-calibration setting	Time
Auto	5.0
Manual	0.0

N: Number of averaging iterations

Trigger source, continuous measurement	Number of iterations
When using the INT trigger source with continuous measurement on (free-run)	1* ¹ (Moving Avg.)
When using an EXT trigger source or with continuous measurement off (non-free-run)	Varies with setting. * ²

*1. Calculate with N = 1, irrespective of the set number of average iterations.

*2. When using the SLOW2 measurement speed with LP on, calculate with N = 2 even if the averaging is set to off.

- (3) Shortest measurement times when using the INT trigger source with continuous measurement on (free-run)
(unit: ms)

LP: Off (tolerance: $\pm 10\%$ ± 0.2 ms)

Range	FAST		MEDIUM		SLOW1	SLOW2
	50 Hz	60 Hz	50 Hz	60 Hz		
1000 k Ω or less	1.0* ¹		20.7	17.4	101	201
10 M Ω or more	20.7	17.4	20.7	17.4	101	201

*1. When using the MUX measurement terminals, the shortest measurement time is 1.7 ms in the 1000 $\mu\Omega$ range and 10 m Ω range.

LP: On (tolerance: $\pm 10\%$ ± 0.2 ms, only with OVC is on)

Range	FAST		MEDIUM		SLOW1	SLOW2
	50 Hz	60 Hz	50 Hz	60 Hz		
LP1000 m Ω	71	65	111	98	431	631
LP10 Ω	111	105	151	138	471	671
LP100 Ω	111	105	151	138	471	671
LP1000 Ω	113	107	153	140	473	673

Shortest conditions

Delay: 0 ms, OVC: Off, Self-calibration: MANUAL,

Contact improvement: Off, Scaling: Off

Measured value display switching: none

12.2 Input Specifications/Output Specifications/Measurement Specifications

- (4) Shortest measurement times when using the EXT trigger source or when continuous measurement off (non-free-run) (unit: ms)

LP: Off and PR: Off (tolerance: $\pm 10\% \pm 0.2$ ms)

Range	Measurement current	OVC	FAST		MEDIUM		SLOW1	SLOW2	100 M Ω range High-precision mode
			50 Hz	60 Hz	50 Hz	60 Hz			
1000 $\mu\Omega$	High	OFF	-		-		-	-	-
		ON	81		121	114	281	481	
10 m Ω	High	OFF	41		61	58	141	241	
		ON	82		121	115	281	481	
100 m Ω	High	OFF	41		61	58	141	241	
		ON	81		121	114	281	481	
	Low	OFF	2.9		23	20	103	203	
		ON	5.6		45	39	205	405	
1000 m Ω	High	OFF	3.1		23	20	103	203	
		ON	6.0		46	39	206	406	
	Low	OFF	2.1		22	19	102	202	
		ON	4.0		44	37	204	404	
10 Ω	High	OFF	2.3		22	19	102	202	
		ON	4.4		44	38	204	404	
	Low	OFF	2.6		23	19	103	203	
		ON	5.0		45	38	205	405	
100 Ω	High	OFF	2.4		23	19	103	203	
		ON	4.6		44	38	204	404	
	Low	OFF	2.9		23	20	103	203	
		ON	5.6		45	39	205	405	
1000 Ω	-	OFF	2.9		23	20	103	203	
		ON	5.6		45	39	205	405	
10 k Ω			7.0		27	23	107	207	
100 k Ω			17		37	33	117	217	
1000 k Ω			131		151	147	231	331	
10 M Ω			521	517	521	517	601	701	
100 M Ω			1321	1317	1321	1317	1401	1501	ON
			341	337	341	337	421	521	OFF
1000 M Ω			361	357	361	357	441	541	OFF

■ **LP: ON** (tolerance: $\pm 10\% \pm 0.2$ ms, only with OVC is on)

Range	FAST		MEDIUM		SLOW1	SLOW2
	50 Hz	60 Hz	50 Hz	60 Hz		
LP1000 m Ω	71	65	111	98	431	1262
LP10 Ω	111	105	151	138	471	1342
LP100 Ω	111	105	151	138	471	1342
LP1000 Ω	113	107	153	140	473	1346

■ **PR: On** (tolerance: $\pm 10\% \pm 0.2$ ms)

Range	Measurement current	OVC	FAST		MEDIUM		SLOW1	SLOW2
			50 Hz	60 Hz	50 Hz	60 Hz		
PR 1000 $\mu\Omega$	High	OFF	-	-	-	-	-	-
		ON	41	81	74	241	441	
PR10 m Ω	High	OFF	21	41	37	121	221	
		ON	41	81	74	241	441	
PR100 m Ω	--	OFF	21	41	37	121	221	
		ON	41	81	74	241	441	

Shortest conditions

Delay: 0 ms, TRIG logic setting: On, Self-calibration: MANUAL,

Contact improvement: Off, Scaling: Off, Measured value display switching: none

If LP is set to On

OVC is fixed to On, if measurement speed is set to SLOW2, averaging is fixed to 2 times

Resistance D/A Output (response time: measurement time + max. 1 ms)	Shortest Shortest conditions	2.0 ms (tolerance: $\pm 10\% \pm 0.2$ ms) Trigger source INT, LP: Off, 1000 k Ω or lower range, Measurement speed: FAST, Delay: 0 ms, Self-calibration: MANUAL
Temperature measurement (thermistor sensor)	2 s ± 0.2 s	
Temperature measurement (analog input)	50 ms ± 5 ms, no moving average	

Accuracy specifications

Accuracy guarantee conditions	<p>Accuracy guarantee duration 1 year</p> <p>Accuracy guarantee temperature and humidity range 23°C ±5°C (73.4°F ±41°F), 80% RH or less</p> <p>Accuracy specifications conditions Self-calibration function set to AUTO (Self-calibration function set to MANUAL, temperature fluctuations after self-calibration within ±2°C and interval within 30 min.)</p> <p>Temperature coefficient Add (±1/10 of measurement accuracy per °C) from 0°C to 18°C and from 28°C to 40°C.</p> <p>Warm-up time At least 60 minutes (When the instrument warms up for less than 60 minutes, measurement accuracy will be twice the value indicated in the accuracy table.)</p>
Effect of radiated radio-frequency electromagnetic field	<p>At 10 V/m</p> <p>10 MΩ range or less: 8% of full scale</p> <p>100 MΩ range or greater: 20% of full scale</p>
Effect of conducted radio-frequency electromagnetic field	<p>5% of full scale at 10 V</p>
Effects of external magnetic field	<p>3% of full scale at 30 A/m</p>

Measurement accuracy

Resistance measurement

LP: Off and PR: Off

Range	Max. measurement range*1	Measurement current *3		OVC	Measurement accuracy ±(% of reading + % of full scale)*2				Additional accuracy without OADJ (% f.s.)*2	Max. open-terminal voltage	100 MΩ Range High-precision mode
					FAST	MED	SLOW1	SLOW2			
1000 μΩ	1200.000 μΩ	High	1 A	OFF	-				-	8.0 V*4 (20 V)*6	-
				ON	0.045+0.075	0.045+0.020	0.045+0.010	-			
10 mΩ	12.000 00 mΩ	High	1 A	OFF	0.045+0.050	0.045+0.020	0.045+0.020	0.020			
				ON	0.045+0.015	0.045+0.002	0.045+0.001	-			
100 mΩ	120.000 0 mΩ	High	1 A	OFF	0.045+0.010	0.045+0.010	0.045+0.010	0.002			
				ON	0.045+0.003	0.045+0.001	0.045+0.001	-			
		Low	100 mA	OFF	0.014+0.050	0.014+0.020	0.014+0.020	0.020			
				ON	0.014+0.015	0.014+0.002	0.014+0.001	-			
1000 mΩ	1200.000 mΩ	High	100 mA	OFF	0.012+0.010	0.012+0.008		0.002			
				ON	0.012+0.003	0.012+0.001		-			
		Low	10 mA	OFF	0.008+0.050	0.008+0.020		0.020			
				ON	0.008+0.015	0.008+0.002		-			
10 Ω	12.000 00 Ω	High	10 mA	OFF	0.008+0.010	0.008+0.008		0.002			
				ON	0.008+0.003	0.008+0.001		-			
		Low	1 mA	OFF	0.008+0.050	0.008+0.020		0.020			
				ON	0.008+0.015	0.008+0.002		-			
100 Ω	120.000 0 Ω	High	10 mA	OFF	0.007+0.005	0.007+0.002	0.007+0.001	-			
				ON	0.007+0.005	0.007+0.001	0.007+0.001	-			
		Low	1 mA	OFF	0.008+0.010	0.008+0.010		0.002			
				ON	0.008+0.003	0.008+0.001		-			
1000 Ω	1200.000 Ω	-	-	OFF	0.007+0.005	0.006+0.002	0.006+0.001	-			
10 kΩ	12.000 00 kΩ			1 mA	ON	0.007+0.005	0.006+0.001	0.006+0.001	-		
					100 kΩ	100 μA	OFF	0.008+0.005	0.007+0.002	0.007+0.001	-
1000 kΩ	1200.000 kΩ			10 μA			ON	0.008+0.005	0.007+0.002	0.007+0.001	-
					10 MΩ	12.000 00 MΩ	1 μA	OFF	0.015+0.005	0.008+0.002	0.008+0.001
100 MΩ	120.000 0 MΩ			100 nA				ON	0.030+0.005	0.030+0.002	0.030+0.001
					1000 MΩ	1200.0 MΩ	1 μA or less	OFF	0.200+0.005	0.200+0.002	0.200+0.001
ON	10.00 MΩ or less: 0.50 + 0.02 10.01 MΩ or more: 1.00 + 0.02			-							
OFF	100.0 MΩ or less: 1.00 + 0.02 100.1 MΩ or more: 10.00 + 0.02			-							

PR: On

Range	Max. measurement range*1	Measurement current *3		OVC	Measurement accuracy ±(% of reading + % of full scale)*2				Additional accuracy without 0ADJ (% f.s.)*2	Max. open-terminal voltage	100 MΩ Range High-precision mode
		Switching			FAST	MED	SLOW1	SLOW2			
PR1000 μΩ	1200.000 μΩ	High	1 A	OFF	-				-	8.0 V*4 (20 V)*6	-
				ON	0.045+0.075	0.045+0.020	0.045+0.010				
PR10 mΩ	12.000 00 mΩ	High	1 A	OFF	0.045+0.050	0.045+0.020	0.045+0.020	0.020			
				ON	0.045+0.015	0.045+0.002	0.045+0.001	-			
PR100 mΩ	120.000 0 mΩ	-	1 A	OFF	0.045+0.010	0.045+0.010	0.045+0.010	0.002			
				ON	0.045+0.003	0.045+0.001	0.045+0.001	-			

LP: On

Range	Max. measurement range*1	Measurement accuracy ±(% of reading + % of full scale)*2				Measurement current *3	Max. open-terminal voltage
		FAST	MED	SLOW1	SLOW2		
LP1000 mΩ	1200.00 mΩ	0.200+0.100	0.200 +0.010	0.200+0.005	0.200+0.003	1 mA	20 mV*5
LP10 Ω	12.000 0 Ω	0.200+0.050	0.200+0.005	0.200+0.003	0.200+0.002	500 μA	
LP100 Ω	120.000 Ω	0.200+0.050	0.200+0.005	0.200+0.003	0.200+0.002	50 μA	
LP1000 Ω	1200.00 Ω	0.200+0.050	0.200+0.005	0.200+0.003	0.200+0.002	5 μA	

*1. -10% of full scale on the negative side
 The maximum display range is 9,999,999 digits or 9 GΩ.
 (If the maximum measurement range is exceeded, the over-range display will be shown even if the value is less than or equal to the maximum display range.)

*2.

- LP: Off:
 0.001% of full scale = 10 digits.
 However, if the 100 MΩ range high-precision setting is OFF in the 100 MΩ range or greater, 0.01% of full scale = 1 digit.
- LP: On:
 0.001% of full scale = 1 digit
- Measurement accuracy is the accuracy after zero adjustment. When not performing zero adjustment, the value indicated under [Additional accuracy without 0ADJ] is added.
- For the 1000 μΩ range and LP, only when OVC is on
- During temperature correction, the following value is added to the resistance measurement accuracy reading error:

$$\frac{-\alpha_{t_0}\Delta t}{1 + \alpha_{t_0} \times (t + \Delta t - t_0)} \times 100 (\%)$$

t_0 : Reference temperature (°C)
 t : Current ambient temperature (°C)
 Δt : Temperature measurement accuracy
 α_{t_0} : Temperature coefficient (1/°C) at t_0

- *3. Measurement current accuracy is $\pm 5\%$
- When using the 1000 Ω range or lower with an EXT trigger source or with continuous measurement off (non-free-run), the measurement current is only applied from the start of measurement (TRIG = ON) to the end of measurement (INDEX = ON). The measurement current is stopped at all other times.
If using the 10 k Ω or greater range, the measurement current will be applied continuously regardless of the trigger source setting.
 - When using the INT trigger source with continuous measurement on (free-run), the measurement current is stopped while the contact check indicates an error.
- *4. When using an external trigger source or when continuous measurement is off (non-free-run), the open voltage is limited to 20 mV or less from 7 ms after the completion of measurement (INDEX = ON) until the start of the next measurement (TRIG = ON).
- *5. When the contact check function is off (when the contact check function is on, 300 mV)
- *6. A transient voltage condition lasting 1 ms or less occurs if the probe is moved out of contact with the measurement target while current is being applied.

Resistance D/A Output	Resistance measurement accuracy $\pm 0.2\%$ of full scale (temperature coefficient $\pm 0.02\%$ of full scale/ $^{\circ}\text{C}$)	
Temperature measurement (thermistor sensor)	$\pm 0.2^{\circ}\text{C}$	
	Combined accuracy with Z2001 Temperature Sensor (t : measurement temperature [$^{\circ}\text{C}$])	
	Accuracy	Temperature range
	$\pm(0.55 + 0.009 \times t - 10)^{\circ}\text{C}$	-10.0°C to 9.9°C
	$\pm 0.50^{\circ}\text{C}$	10.0°C to 30.0°C
$\pm(0.55 + 0.012 \times t - 30)^{\circ}\text{C}$	30.1°C to 59.9°C	
$\pm(0.92 + 0.021 \times t - 60)^{\circ}\text{C}$	60.0°C to 99.9°C	
Temperature measurement (analog input)	$\pm 1\%$ of reading ± 3 mV Temperature accuracy conversion method: $1\% \times (T_R - T_{0V}) + 0.3\% \times (T_{1V} - T_{0V})$ T_{1V} : temperature at 1 V input T_{0V} : temperature at 0 V input T_R : ambient temperature Add temperature coefficient ($\pm 0.1\%$ of reading ± 0.3 mV/ $^{\circ}\text{C}$) to above accuracy for ambient temperature ranges 0°C to 18°C and 28°C to 40°C . Accuracy guarantee range : 0 V to 2 V Maximum allowable voltage : 2.5 V Detected resolution : 1 mV or less Display range : -99.9°C to 999.9°C	
Calculation order	Zero adjustment \rightarrow Temperature correction \rightarrow Scaling	

About instrument accuracy

See: "Accuracy labeling" (p.6)

Example accuracy calculations

(Digits in excess of display range are truncated.)

• Resistance measurement accuracy

Measurement conditions: 100 mΩ range, low current, OVC off, no zero adjustment, SLOW1, 30 mΩ measurement target

Resistance measurement accuracy: $\pm(0.014\%$ of reading + 0.020% of full scale),

Additional accuracy without 0ADJ: $\pm 0.020\%$ of full scale

$$\pm(0.014\% \times 30 \text{ m}\Omega + [0.02\% + 0.02\%] \times 100 \text{ m}\Omega) = \pm 0.0442 \text{ m}\Omega$$

• Temperature measurement accuracy

Measurement conditions: Thermistor temperature sensor, measurement temperature of 35°C

Temperature measurement accuracy: $\pm(0.55 + 0.012 \times |t - 30|)$

$$\pm(0.55 + 0.012 \times |35-30|) = \pm 0.610^\circ\text{C} \text{ (Truncate digits in excess of display range: } 0.6^\circ\text{C)}$$

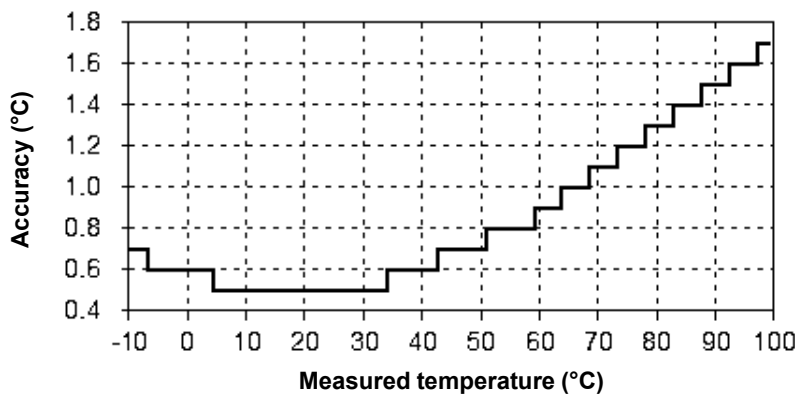

• Temperature correction additional accuracy

Measurement conditions: Temperature coefficient of 3930 ppm/°C, standard temperature of 20°C, measurement temperature of 35°C

Additional error:
$$\frac{-\alpha_{t_0}\Delta t}{1 + \alpha_{t_0} \times (t + \Delta t - t_0)} \times 100 (\%)$$

$$\frac{-0.393\% \times (\pm 0.6)}{1 + 0.393\% \times (35 \pm 0.6 - 20)} = +0.222\% \text{ of reading, } -0.223\% \text{ of reading}$$

12.3 Function Specifications

(1) Resistance range switching

Mode	AUTO, MANUAL (Automatically set to manual if the comparator or BIN function is turned on.)
Measurement range	LP Off: 1000 $\mu\Omega$, 10 m Ω , 100 m Ω , 1000 m Ω , 10 Ω , 100 Ω , 1000 Ω , 10 k Ω , 100 k Ω , 1000 k Ω , 10 M Ω , 100 M Ω , 1000 M Ω LP On: 1000 m Ω , 10 Ω , 100 Ω , 1000 Ω <ul style="list-style-type: none"> With the 100 MΩ range high-precision setting on, the 1000 MΩ range cannot be used. When using the MUX measurement terminal setting with the 2-wire measurement method, the 10 Ω and lower ranges cannot be used.
Default setting	Mode: AUTO, Measurement range: 1000 M Ω

(2) 100 M Ω range high-precision mode

Setting	ON/OFF
Default setting	OFF

(3) Number of measurement digits selection

Setting	7 digits, 6 digits, 5 digits (If the number of full scale digits is less than the setting, the number of full scale digits will be used.)
Default setting	7 digits

(4) Pure resistance mode (PR)

Operation	Measurement of resistance only to increase path resistance tolerances and shorten wait times (1000 $\mu\Omega$ to 100 m Ω range [1 A range only]).									
	<table border="1"> <thead> <tr> <th rowspan="2">Range</th> <th>Measurement current</th> </tr> <tr> <th>High</th> </tr> </thead> <tbody> <tr> <td>PR100 $\mu\Omega$</td> <td>1 A</td> </tr> <tr> <td>PR10 mΩ</td> <td>1 A</td> </tr> <tr> <td>PR100 mΩ</td> <td>1 A</td> </tr> </tbody> </table>	Range	Measurement current	High	PR100 $\mu\Omega$	1 A	PR10 m Ω	1 A	PR100 m Ω	1 A
Range	Measurement current									
	High									
PR100 $\mu\Omega$	1 A									
PR10 m Ω	1 A									
PR100 m Ω	1 A									
Setting	ON/OFF									
Default setting	OFF									

(5) Low-power mode (LP)

No tolerance to voltage application in LP mode

Operation	Low-power measurement is performed by limiting the measurement current and open voltage. (1000 m Ω to 1000 Ω range)
Setting	ON/OFF (with OVC ON when LP is ON and the contact improvement function fixed to OFF)

Default setting	OFF
------------------------	-----

(6) Switching Measurement Currents

Operation	The measurement current is limited during measurement. (1000 $\mu\Omega$ to 100 Ω range)
------------------	---

Setting	Measurement current: High/Low
----------------	-------------------------------

Range	Measurement current	
	High	Low
1000 $\mu\Omega$	1 A	-
PR1000 $\mu\Omega$		
10 m Ω	1 A	-
PR10 m Ω		
100 m Ω	1 A	100 mA
PR100 m Ω		-
1000 m Ω	100 mA	10 mA
10 Ω	10 mA	1 mA
100 Ω	10 mA	1 mA

Default setting	High
------------------------	------

(7) Measurement speed setting

Setting	FAST, MED, SLOW1, SLOW2
----------------	-------------------------

Default setting	SLOW2
------------------------	-------

(8) Set the power frequency

Operation	Selects the line voltage frequency
------------------	------------------------------------

Setting	AUTO (50 Hz or 60 Hz, auto-detect), 50 Hz, 60 Hz
----------------	--

Default setting	AUTO (auto-detect upon power on and resetting)
------------------------	--

(9) Zero adjustment

Operation	Cancels the internal offset voltage and the surplus resistance.
------------------	---

Setting	ON/OFF (clear): For each range Scan zero adjustment ON/OFF: For each channel (RM3545A-2 only)
----------------	--

Adjustment range	Within $\pm 50\%$ of full scale for each range (warning message displayed when in excess of $\pm 1\%$ of full scale for each range) Zero adjustment cannot be used at 100 M Ω or above (it is forcibly turned off).
-------------------------	---

Default setting	Zero adjustment: OFF, Scan zero adjustment: ON
------------------------	--

(10) Averaging

Operation	<p>A moving average is used when using the INT trigger source with continuous measurement on (free-run). A mean average is used when using an EXT trigger source or with continuous measurement off (non-free-run).</p> <table border="1" style="width: 100%; border-collapse: collapse;"> <thead> <tr> <th style="background-color: #d9e1f2;">Moving average</th> <th style="background-color: #d9e1f2;">Mean average</th> </tr> </thead> <tbody> <tr> <td style="text-align: center;"> $R_{\text{avg}(n)} = \frac{1}{A} \sum_{k=n}^{n+A-1} R_k$ </td> <td style="text-align: center;"> $R_{\text{avg}(n)} = \frac{1}{A} \sum_{k=(n-1)A+1}^{nA} R_k$ </td> </tr> </tbody> </table> <p>R_{avg}: Average, A: Number of averaging iterations, n: Number of measurements, R_k: Measured value No. k</p>	Moving average	Mean average	$R_{\text{avg}(n)} = \frac{1}{A} \sum_{k=n}^{n+A-1} R_k$	$R_{\text{avg}(n)} = \frac{1}{A} \sum_{k=(n-1)A+1}^{nA} R_k$
Moving average	Mean average				
$R_{\text{avg}(n)} = \frac{1}{A} \sum_{k=n}^{n+A-1} R_k$	$R_{\text{avg}(n)} = \frac{1}{A} \sum_{k=(n-1)A+1}^{nA} R_k$				
Setting	ON/OFF (When using the SLOW2 measurement speed with low-power resistance measurement on, the instrument will performing averaging with two iterations internally even if the averaging function is set to off.)				
Number of averaging iterations	2 to 100 times				
Default setting	OFF				

(11) Delay setting

Operation	Adjusts the time for measurement to stabilize by inserting a waiting period after using the OVC or the auto-range function to change the measurement current or after the TRIG signal.
Setting	Preset (internal fixed value)/ user-set (set value)
Preset	Starts integration after an internally fixed time (varies by range).
User setting	Start integration after the set time (applies to all ranges).
Delay setting range	0 ms to 9999 ms
Default setting	Preset/ 0 ms

Preset delay value (internal fixed) (unit: ms)

LP: Off and PR: Off

Range	Measurement current	Delay		100 MΩ Range High-precision mode	
		OVC: OFF	OVC: ON		
1000 μΩ	High	-	38	-	
10 mΩ	High	38	13		
100 mΩ	High	130	13		
	Low	20	1		
1000 mΩ	High	38	1		
	Low	4	2		
10 Ω	High	20	2		
	Low	5	2		
100 Ω	High	130	1		
	Low	20	2		
1000 Ω	-	130	1		
10 kΩ		180	-		
100 kΩ		95			
1000 kΩ		10			
10 MΩ		1			
100 MΩ		500			-
		1		OFF	
1000 MΩ		1		OFF	

LP: On

Delay
1

PR: On

Delay
1

(12) Temperature measurement settings

Temperature sensor type	Thermistor sensor, analog input
Analog input formula	$t = \frac{T_2 - T_1}{V_2 - V_1} v + \frac{T_1 V_2 - T_2 V_1}{V_2 - V_1}$ <p> t: Displayed value (°C) v: Input voltage (V) V_1: Reference voltage 1 (V) Setting range: 0.00 V to 2.00 V T_1: Reference temperature 1 (°C) Setting range: -99.9°C to 999.9°C V_2: Reference voltage 2 (V) Setting range: 0.00 V to 2.00 V T_2: Reference temperature 2 (°C) Setting range: -99.9°C to 999.9°C </p>
Default setting	Sensor type: Thermistor sensor, V_1 : 0 V, T_1 : 0°C, V_2 : 1 V, T_2 : 100°C

(13) Temperature correction function (TC)

Operation	Temperature correction converts resistance values to resistance values at standard temperature and displays the result. (When ΔT is on, TC is automatically turned off.)
Formula	$R_{t_0} = \frac{R_t}{1 + \alpha_{t_0}(t - t_0)}$ <p> R_t: Measured resistance value (Ω) R_{t_0}: Corrected resistance value (Ω) t_0: Reference temperature (°C) Setting range: -10.0°C to 99.9°C t: Current ambient temperature (°C) α_{t_0}: Temperature coefficient (1/°C) at t_0 Setting range: -99,999 ppm/°C to 99,999 ppm/°C </p>
Setting	ON/OFF (When ΔT is on, TC is automatically turned off.)
Default setting	OFF, t_0 : 20°C, α_{t_0} : 3930 ppm/°C

(14) Offset voltage compensation

OVC: Offset voltage compensation

Operation	Reverses measurement current polarity to eliminate offset voltage effects
Applicable range	LP Off : 0 $\mu\Omega$ range to 1000 Ω range LP On : All ranges
Setting	ON/OFF (When low-power is on, OVC is fixed to on.)
Default setting	OFF

(15) Scaling

Operation	Measured values are corrected with the linear function $R_S = A \times R + B$ R_S : Value after scaling A : Gain coefficient Setting range: $0.200\ 0 \times 10^{-3}$ to $1.999\ 9 \times 10^3$ R : Measured value after zero adjustment and temperature correction B : Offset Setting range: 0 to $\pm 9 \times 10^9$ (maximum resolution: 1 n Ω)
Setting	ON/OFF
Display format	See: p.78 (When 9 G is exceeded, the over-range display is shown.)
Unit	Ω , none, user-selected 3 characters (Except SI prefix)
Default setting	OFF, A : 1.0000×1 , B : 0, Unit: Ω

(16) Self-calibration

Operation	Compensates for offset voltage and gain of measurement circuit.
Setting	AUTO, MANUAL
Compensation timing	AUTO : At power-on, after measured value, during TRIG standby (every 1 s) MANUAL : During EXT. I/O CAL signal input, when executing the calibration command
Self-calibration time	At power-on, when switching to auto, and during manual execution: 400 ms Auto: 5 ms (moving average)
Default setting	AUTO

(17) Contact improvement function

Operation	A voltage is applied between the SENSE A and SENSE B terminals after TRIG signal input, and a contact improvement current is allowed to flow for 0.2 ms.
Setting	OFF/ON (When LP is on, the contact improvement function is fixed to off.)
Default setting	OFF
Applied voltage	Max. 5 V
Contact improvement current	Max. 10 mA (flowing to the measurement target)

(18) Measurement fault detection**■ Over-range detection**

Operation	Indicates under- or over-range values in the following conditions: <ul style="list-style-type: none"> • Measured value is outside of the measurement range • Measured value is outside of the A/D converter input range • Calculation result exceeded the number of display digits
------------------	---

■ Contact check

Operation	Checks the connections between SOURCE A and SENSE A, and between SOURCE B and SENSE B terminals.
Setting	ON/OFF (When using the MUX measurement terminal setting with the 2-wire measurement method, fixed to off. When using the 100 M Ω or greater range, the setting is fixed to ON.)
Threshold	50 Ω (reference value)
Default setting	ON (When LP is off), OFF (When LP is on)

■ Current fault detection

Operation	Detects faults in which the stipulated measurement current cannot be applied. No cancellation function.
------------------	---

Current fault mode setting Current fault (ERR signal output), Over-range (HI signal output)

Display and output during current fault detection

		Current fault mode setting		
		Current fault	Over-range	
			Without error output	With error output
Contact check	Normal (No error)	Current fault display ERR signal output	Over-range display HI signal output	Over-range display HI signal output ERR signal output
	Fault (Error)	Contact error display ERR signal output		

Default setting Current fault (ERR signal output)

Reference values for route resistance (wiring resistance + contact resistance) that will result in a current fault See: p.59

(19) Comparator

Operation	Compares setting and measured values
Setting	ON/OFF (fixed range when the comparator function is on; the comparator function is automatically turned off when the ΔT and BIN functions are on)
Judgment method	ABS mode, REF% mode
Default setting	OFF, ABS mode
Judgment	Judgment is based on the digit value (up to display digit) Hi: Measured value > Upper limit value IN: Upper limit value ≥ Measured value ≥ Lower limit value Lo: Lower limit value > measured value

Total judgment **RM3545A-2**

Operation	When using the MUX measurement terminal setting with the scan function set to AUTO or STEP, a PASS/FAIL judgment is made for each channel, and a total judgment is determined.
PASS/FAIL judgment (for each scan channel)	PASS: When the comparator judgment satisfies the PASS conditions FAIL: When the comparator judgment does not satisfy the PASS conditions
PASS conditions	PASS: When all channels are PASS or when the PASS condition is OFF FAIL: When any channel is FAIL OFF, Hi, IN, Lo, Hi or Lo, ALL (for each scan channel)
Default setting	IN

ABS mode

Upper/Lower limit ranges	0000.00 μΩ to 9000.00 MΩ*1
Default setting	0000.00 μΩ

REF% mode

Display	Absolute value display and relative value display $(\text{Relative value}) = \left\{ \frac{(\text{Measured value})}{(\text{Reference value})} - 1 \right\} \times 100[\%]$
Relative value display range	-999.999% to 999.999%
Reference value range	0000.00 μΩ to 9000.00 MΩ*1 When using the MUX measurement terminal setting, the measurement results for scan channel 1 can be used as the reference value. (RM3545A-2 only)
Upper/Lower limit ranges	0.000% to ±99.999%
Default setting	Reference value: 0000.01 μΩ, Upper/Lower limit ranges: 0.000%

*1. When set using the instrument's keys, the input range will reflect the range and scaling coefficient with a maximum resolution of 1 nΩ and a maximum value of 9 GΩ.

(20) BIN

Operation	Compares setting and measured values and displays the result.
Setting	ON/OFF (When the BIN function is on, the range and comparator functions are fixed to off. When ΔT is on while using the MUX measurement terminal setting, the BIN function is automatically turned off.)
Judgment method	ABS mode, REF% mode
Display	Absolute value (resistance value) display only
BIN number	0 to 9
Default setting	OFF
Judgment	Judgment is based on the digit value (up to display digits). Hi: Measured value > Upper limit value IN: Upper limit value \geq Measured value \geq Lower limit value Lo: Lower limit value > measured value
ABS mode	
Upper/Lower limit ranges	0000.0 0 $\mu\Omega$ to 9000.00 M Ω * ¹
Default setting	0000.0 0 $\mu\Omega$
REF% mode	
Reference value range	0000.0 1 $\mu\Omega$ to 9000.00 M Ω * ¹
Upper/Lower limit ranges	0.000% to $\pm 99.999\%$
Default setting	Reference value: 0000.0 1 $\mu\Omega$, Upper/Lower limit ranges: 0.000%

*1. When set using the instrument's keys, the input range will reflect the range and scaling coefficient with a maximum resolution of 1 n Ω and a maximum value of 9 G Ω .

(21) Judgment beeper setting

Operation	Sounds a beeper based on the comparator judgment result or total judgment. (Set separately for HiIN/Lo and for PASS/FAIL when using the MUX measurement terminals.)
Settings	Tones: type 1, type 2, type 3, OFF
Number of beeps	1 to 5 times, continuous
Default setting	OFF, 2 times

(22) Auto hold

Operation	Holds measured values automatically (only when using the measurement terminals on the front of the instrument with the INT trigger source and continuous measurement on [free-run]). The hold is canceled when the measurement leads are removed from the target and the next measurement performed, or when the  key is pressed.
Setting	ON/OFF
Default setting	OFF

(23) Temperature conversion (ΔT)

Operation	Utilizing the temperature-dependent nature of resistance, the temperature conversion function converts resistance measurements for display as temperatures.
Formula	$\Delta t = \frac{R_2}{R_1}(k + t_1) - (k + t_2)$ <p> Δt: Temperature increase ($^{\circ}\text{C}$) t_1: Winding temp. ($^{\circ}\text{C}$, cool state) when measuring initial resistance R_1 Setting range: -10.0°C to 99.9°C t_2: Ambient temp. ($^{\circ}\text{C}$) at final measurement R_1: Winding resistance (Ω) at temp. t_1 (cool state) Setting range: $0.001 \mu\Omega$ to $9000.000 \text{M}\Omega^{*1}$ R_2: Winding resistance (Ω) at final measurement k: Reciprocal ($^{\circ}\text{C}$) of temp. coefficient of conductor material at 0°C Setting range: -999.9 to 999.9 </p> <p>*1. When set using the instrument's keys, the input range will reflect the range and scaling coefficient with a maximum resolution of $1 \text{n}\Omega$ and a maximum value of $9 \text{G}\Omega$.</p>
ΔT display range	-9999.9°C to 9999.9°C
Setting	ON/OFF (When the ΔT function is on, the comparator functions are fixed to off. ΔT is automatically turned off when TC, the statistical calculation function, and the BIN function are on.)
Default setting	OFF, t_1 : 23.0°C , R_1 : $1.000 \text{0 } \Omega$, k : 235.0

(24) Statistical calculation

Operation	Statistical calculations are performed on measured values.
Setting	ON/OFF (The statistical calculation function is automatically turned off when ΔT is on while using the MUX measurement terminal setting.)
Maximum number of data points	30,000
Calculations	<p>Total data count, Number of valid data samples, Mean, Minimum value (index no.), Maximum value (index no.), Standard deviation of sample, Population standard deviation</p> <ul style="list-style-type: none"> When the comparator function is ON Count for each comparator judgment, Process capability indices (dispersion, bias) When the BIN function is ON Count for each BIN number, OUT (Hi or Lo) count for all BIN numbers, invalid BIN count
Clearing calculations	Clear all data, clear 1 data point (to revert to data immediately before measurement)
Default setting	OFF

(25) Panel Save, Panel Load

Operation	Saves and loads measurement conditions using user-specified panel numbers.
Number of panels	When using the measurement terminals on the front of the instrument: 30; when using the MUX measurement terminal setting: 8
Panel names	10 characters (letters or numbers)
Saved data	Save time and date, resistance range, 100 M Ω high-precision mode, low-power mode (LP), pure resistance mode (PR), switching measurement currents, measurement speed, zero adjustment, average, delay, temperature correction (TC), offset voltage compensation (OVC), scaling, self-calibration setting, contact improvement, contact check, comparator, BIN setting, judgment beeper, Auto Hold, temperature conversion (ΔT), statistical calculations setting, multiplexer setting (for all channels)
Loading of zero adjustment values	ON/OFF
Default setting	ON

(26) Clock

Operation	Auto calendar, auto leap year, 24-hour clock
Accuracy	Approx. ± 4 minutes/ month
Default setting	2023-10-01 (yyyy-mm-dd), 00:00

(27) Reset the instrument■ **Reset the instrument**

Operation	Resets settings (except panel data) to factory defaults
------------------	---

■ **System reset**

Operation	Reverts all settings, including panel data, to their default values.
------------------	--

■ **Multiplexer channel reset** **RM3545A-2**

Operation	Returns the multiplexer channel settings to the factory defaults.
------------------	---

(28) Self-test■ **Self-test at startup**

Operation	ROM/RAM check, measurement circuit protective fuse check
------------------	--

■ **Z3003 unit test** **RM3545A-2**

Operation	Each pin's round-trip route resistance value is measured with all the A and B terminals shorted while in the 2-terminal resistance measurement state, and the number of contacts is displayed.
Judgment criterion	Short test: FAIL when the resistance measurement is 1 Ω or more in the shorted state Open test: FAIL when no measurement fault is detected in the open state

12.4 Interface Specifications

(1) Display

LCD type	Monochrome graphical LCD 240 × 110
Backlight	White LED Brightness adjustment range: 0% to 100% (5% increments), Default setting: 80% When EXT is being used as the trigger source, the backlight dims after a period of no operation. Brightness recovers upon front panel key operation.
Contrast	Adjustment range: 0% to 100% (5% increments), Default setting: 50%
Measured value display switching	The following display modes are provided in addition to the normal measured value display: No display/ temperature/ pre-calculation resistance value (TC, scaling, REF%, ΔT)

(2) Key

COMP, PANEL, ▼, ▲, ►, ◀, MENU, F1, F2, F3, F4, ESC, ENTER, AUTO, ▼, ▲ (range), ⏻ (standby), SPEED

■ Key lock

Operation	Disables operation of unneeded keys. Can be canceled using a communication command.
Setting	OFF/menu lock/full lock Menu lock : Disables all keys other than the keys listed below and the key used to cancel key lock [UNLOCK] . COMP, PANEL, AUTO, ▼, ▲ (range), SPEED, 0ADJ, PRINT, STAT, STOP All-key lock : Disables all except the key used to cancel key lock [UNLOCK] . All front panel keys are disabled when the KEY_LOCK signal is received.
Default setting	OFF

■ Key operation sound setting

Setting	ON/OFF
Default setting	ON

12.5 Communications Interface Specifications

Interface types	LAN, RS-232C, PRINTER, USB
Default setting	RS-232C

(1) LAN

Applicable standard	IEEE802.3
Transfer method	10BASE-T,100BASE-TX auto-detect, Half/Full Duplex, Auto MDI-X
Protocol	TCP/IP
Connector	RJ-45
Communication contents	Configuring settings and acquiring measured values with communications commands
IP address	xxx.xxx.xxx.xxx (xxx: 0 to 255)
Subnet mask	xxx.xxx.xxx.xxx (xxx: 0 to 255)
Default gateway	xxx.xxx.xxx.xxx (xxx: 0 to 255)
Communications command port	11 to 65535 (except 80)
Message terminator (delimiter)	Receiving: CR+LF, CR, LF Transmitting: CR+LF
Default	IP address: 0.0.0.0, Subnet mask: 255.255.255.0, Default gateway: OFF (0.0.0.0), Communications command port: 23

(2) RS-232C

Communication contents	Remote control, measured value output (export)
Transfer method	Communications: Full duplex Synchronization: Start-stop synchronization
Transmission speed	9600 bps (default setting), 19200 bps, 38400 bps, 115200 bps
Data length	8 bits
Stop bit	1
Parity bit	None
Handshaking	No X-flow, no hardware flow
Protocol	Non-procedure
Message terminator (delimiter)	Receiving: CR+LF, CR, LF Transmitting: CR+LF
Connector	Male 9-pin D-sub, with #4-40 Screw lock

(3) USB

Communication contents	Remote control, measured value output (export)
Connector	Series B receptacle
Electrical specifications	USB2.0 (Full Speed)
Class (mode)	CDC Class (COM mode), HID Class (USB keyboard mode)
Message terminator (delimiter)	Receiving: CR+LF, CR, LF Transmitting: CR+LF
Default setting	COM mode

(4) Printer

Operation	Prints data when the PRINT signal is input or when the print key is pressed.
Compatible printers	Interface: RS-232C, no. of characters per line: 48 (single-byte) or more Communication speed: 9600 bps, 19200 bps, 38400 bps, 115200 bps Data length: 8 bits, Parity: none, Stop bit: 1 bit, Flow control: none, Message terminator (delimiter) CR+LF Must be able to print control codes or plain text directly.
Printing contents	Resistance measured values, temperature measured values, judgment results, measurement conditions, statistical results
Interval	ON/OFF
Interval time	0 s to 3600 s
Statistical calculations clear	ON/OFF
Number of columns printed per row	1 column, 3 columns
Default setting	Interval: OFF, Interval time: 1 s, Statistical calculations clear: OFF, Number of columns printed per row: 1 column

(5) Communications functionality

Remote function	During communications via USB, RS-232C, or LAN, all front panel key operations are disabled. Remote operation is canceled as follows: <ul style="list-style-type: none"> • LOCAL key, Reset, At power-on • Via USB, RS-232C, or LAN : SYSTem:LOCa1 command
Command monitor function	Displays the send/receive status of commands and queries. Setting: ON/OFF
Data output function	During INT trigger source operation, measured values are output at TRIG signal or ENTER key input. During EXT trigger source operation, measured values are automatically output each time measurement completes. (USB keyboard mode is available during INT trigger source use only.) Setting: ON/OFF
Memory function	Measured values stored in the instrument's memory are sent at once. (The memory function is automatically turned off when using the MUX measurement terminal setting.) Number of memory units: 50 (volatile memory, no backup) Setting: ON/OFF
Default setting	Command monitor function: OFF, Data output: OFF, Memory function: OFF

(6) EXT. I/O

Connector	Female 37-pin D-sub, with #4-40 Screw lock
------------------	--

■ Input

Electrical specifications	Input type	Photocoupler-isolated no-voltage contact input (current sink/source output compatible)
	Input asserted (ON)	Residual voltage: 1 V or less (Input ON current: 4 mA [reference value])
	Input asserted (OFF)	Open (shutoff current: 100 μA or less)
	Response time	ON edge: Max. 0.1 ms, OFF edge: Max. 1.0 ms
Input signals	TRIG (IN0), CAL, KEY_LOCK, 0ADJ, PRINT (IN1), MUX, SCN_STOP, LOAD0 to LOAD5, BCD_LOW (Valid only with BCD mode output)	

■ Output

Electrical specifications	Output type	Photocoupler-isolated open-drain output (non-polar)
	Maximum load voltage	30 V DC
	Residual voltage	1 V or less (load current: 50 mA) 0.5 V or less (load current: 10 mA)
	Maximum output current	50 mA/channel
Output signals	Output mode switching: JUDGE mode, BCD mode JUDGE mode EOM, ERR, INDEX, HI, IN, LO, T_ERR, T_PASS, T_FAIL, BIN0 to BIN9, OB, OUT0 to OUT2, OVER_INPUT BCD mode EOM, ERR, IN, HILO When BCD_LOW is ON: BCD1 to BCD3 × 4 digits, RNG_OUT0 to RNG_OUT3 When BCD_LOW is OFF: BCD4 to BCD7 × 4 digits Default setting JUDGE mode	

■ Trigger source setting function

Setting	INT (Internal), EXT (External) (Only the EXT setting is available when the measurement pin setting is MUX (multiplexer) and the scan function is set to auto or step mode.)
Default setting	INT (Internal)

■ TRIG/PRINT filter function

Setting	ON/OFF
Operation	During the response time, signal processing is performed only while the input signal is held in the on state.
Response time	50 ms to 500 ms
Default setting	OFF, 50 ms

■ TRIG logic setting

Setting	OFF edge/ ON edge
Default setting	ON edge

■ EOM output timing setting

Setting	HOLD/PULSE
Operation	When using an EXT trigger source with the HOLD setting, the on state is held until the next TRIG signal or 0ADJ signal is input. When using an EXT trigger source with the PULSE setting, the off state is held after the pulse width setting has elapsed. When using the INT trigger source, EOM output is fixed to pulse output with a width of 5 ms (when using auto self-calibration) or no EOM output is generated (when using manual self-calibration), regardless of the EOM output timing setting.
Pulse width	1 ms to 100 ms
Default setting	HOLD, 5 ms

■ EXT. I/O test function

Operation	Displays the EXT. I/O input signal state and generates output signals as desired.
------------------	---

■ Service power supply output

Output voltage	For sink output: 5.0 V \pm 10% For source output: -5.0 V \pm 10%, 100 mA max.
Isolation	Floating from protective ground potential and measurement circuit
Insulation rating	Line to ground voltage 50 V DC, or 30 V AC rms and 42.4 V AC peak or less

(7) Multiplexer RM3545A-2

See: "7 Multiplexer" (p.145)

Number of installed units	Max. 2				
Measurement terminal settings	<p>Front terminals/ MUX (multiplexer) (When using the MUX setting, the memory function is fixed to off. If the statistical calculation function or BIN function is set to on, the measurement terminal setting will be automatically set to the front terminals.) When using the MUX setting, the measurement leads cannot be connected to the front measurement terminals.</p>				
Supported unit	Z3003				
Z3003 control specifications					
Measurement method	<p>2-wire/ 4-wire (When using 2-wire, the minimum measurement range is the 100 Ω range, and the contact check is fixed to the OFF setting.)</p>				
Scan function	<p>OFF/ Auto (measure all channels at each TRIG signal)/ Step (measure 1 channel at each TRIG signal) When the scan function is set to auto or step, the trigger source is fixed to EXT. FAIL stop ON/ OFF</p>				
Channel settings	<p>The A and B terminals of each channel can be individually assigned to user-specified terminals. The measurement current will flow from the B terminal to the A terminal. Channel : Enable/ disable A terminal: 10 terminals (4-wire) or 21 terminals (2-wire) per unit as specified by the user B terminal: 10 terminals (4-wire) or 21 terminals (2-wire) per unit as specified by the user Measuring instrument selection: Instrument measurement / external device measurement</p> <p>The following measurement conditions can be set by channel. Resistance range, 100 MΩ range high-precision mode, low-power mode (LP), switching measurement currents, measurement speed, zero adjustment, average, delay, temperature correction (TC), offset voltage compensation (OVC), pure resistance mode (PR), scaling, contact improvement, contact check, comparator, temperature conversion (ΔT)</p>				
Relay hot switching prevention function	The current between current-generating terminals (between SOURCE terminals) is monitored and relay switching is controlled so that it does not occur until the current falls below a certain level.				
Contact cycle count recording function	<table> <tr> <td>Contacts to be recorded</td> <td>All</td> </tr> <tr> <td>Maximum recordable number</td> <td>999,999,999 times</td> </tr> </table>	Contacts to be recorded	All	Maximum recordable number	999,999,999 times
Contacts to be recorded	All				
Maximum recordable number	999,999,999 times				
Number of channels that can be set	42				
Switching time	30 ms (reference value, not including measurement time and range switching time)				

Default setting

Measurement method: 4-wire, Scan function: Auto, FAIL stop: OFF, channel default settings as follows (default measurement conditions)

4-wire

Channel number	Channel	Unit	A terminal	B terminal
1	Enabled	1	TERM A1	TERM B1
2 to 10	Disabled	1	TERM A2 to TERM A10	TERM B2 to TERM B10
11 to 20	Disabled	2	TERM A1 to TERM A10	TERM B1 to TERM B10
21 to 42	Disabled	1	TERM A1	TERM B1

2-wire

Channel number	Channel	Unit	A terminal	B terminal
1	Enabled	1	TERM A1	TERM B1
2 to 21	Disabled	1	TERM A2 to TERM A21	TERM B2 to TERM B21
22 to 42	Disabled	2	TERM A1 to TERM A21	TERM B1 to TERM B21

(8) D/A output

Output	Resistance measured value (display value after zero adjustment and temperature correction but before scaling and ΔT calculation)
Output voltage	0 V DC (corresponds to 0 digits) to 1.5 V DC *1 If a measured value fault occurs, 1.5 V; if the measured value is negative, 0 V *1. 1,200,000 digits display corresponds to 1.2 V (1,200,000 digits) 120,000 digits display corresponds to 1.2 V (120,000 digits) 12,000 digits display corresponds to 1.2 V (12,000 digits) For a display in excess of 1.5 V, fixed at 1.5 V.
Maximum output voltage	5 V
Output impedance	1 k Ω
Number of bits	12 bit

(9) L2105 LED Comparator Attachment output

Output	Comparator judgment output (two outputs: Hi and Lo/IN)
Output terminal	3-pole earphone terminal ($\varnothing 2.5$ mm)
Output voltage	5 V ± 0.2 V DC, 20 mA

12.6 Z3003 Multiplexer Unit

General specifications

(1) Measurement targets (wiring order is user-selected)

4-wire	10 locations (when using two Z3003 units, 20 locations)
2-wire	21 locations (when using two Z3003 units, 42 locations)

(2) Multiplexer I/O (direction of current application is fixed)

Measurement terminal (4-wire)	<p>TERM A1 terminal to TERM A10 terminal, TERM B1 terminal to TERM B10 terminal (TERM terminal: combinations of the following terminals SOURCE terminal: Current source terminal, SENSE terminal: Voltage detection terminal) EX SOURCE A, EX SOURCE B : External device connection terminal (current) EX SENSE A, EX SENSE B : External device connection terminal (voltage)</p>
Measurement terminal (2-wire)	<p>TERM A1 terminal to TERM A21 terminal, TERM B1 terminal to TERM B21 terminal EX A, EX B: External device connection terminal</p>
Shielding terminal	<p>GUARD terminal: Guard terminal EARTH terminal: Function ground terminal EX GUARD: External device guard terminal</p>
Connector	D-SUB 50 pin receptacle

(3) Pinouts

4-wire

No.	Pin name	No.	No.	Pin name	No.	Pin name
1	-	-	18	TERM B5	34	TERM B9
2	TERM B1	SOURCE	19		35	SENSE
3		SENSE	20	TERM A5	36	TERM A9
4	TERM A1	SOURCE	21		37	
5		SENSE	22	TERM B6	38	TERM B10
6	TERM B2	SOURCE	23		39	
7		SENSE	24	TERM A6	40	TERM A10
8	TERM A2	SOURCE	25		41	
9		SENSE	26	TERM B7	42	-
10	TERM B3	SOURCE	27		43	GUARD
11		SENSE	28	TERM A7	44	GUARD
12	TERM A3	SOURCE	29		45	EX SOURCE B (EX Cur Hi)
13		SENSE	30	TERM B8	46	EX SENSE B (EX Pot Hi)
14	TERM B4	SOURCE	31		47	EX SENSE A (EX Pot Lo)
15		SENSE	32	TERM A8	48	EX SOURCE A (EX Cur Lo)
16	TERM A4	SOURCE	33		49	EX GUARD
17		SENSE			50	EARTH

2-wire

No.	Pin name	No.	Pin name	No.	Pin name
1	TERM A1	18	TERM B9	34	TERM B17
2	TERM B1	19	TERM B10	35	TERM B18
3	TERM B2	20	TERM A10	36	TERM A18
4	TERM A2	21	TERM A11	37	TERM A19
5	TERM A3	22	TERM B11	38	TERM B19
6	TERM B3	23	TERM B12	39	TERM B20
7	TERM B4	24	TERM A12	40	TERM A20
8	TERM A4	25	TERM A13	41	TERM A21
9	TERM A5	26	TERM B13	42	TERM B21
10	TERM B5	27	TERM B14	43	GUARD
11	TERM B6	28	TERM A14	44	GUARD
12	TERM A6	29	TERM A15	45	EX B (EX Hi)
13	TERM A7	30	TERM B15	46	EX B (EX Hi)
14	TERM B7	31	TERM B16	47	EX A (EX Lo)
15	TERM B8	32	TERM A16	48	EX A (EX Lo)
16	TERM A8	33	TERM A17	49	EX GUARD
17	TERM A9			50	EARTH

(4) Measurable range

Measurement current	Instrument with Z3003: 1 A DC or less Externally connected device: 1 A DC or less, 100 mA AC or less
Measurement frequency	Externally connected device: DC, 10 Hz to 1 kHz

(5) Contact specifications

Contact type	Mechanical relay
Maximum allowable voltage	± 60 V DC, or 30 V AC rms and 42.4 V AC peak
Maximum allowable power	30 W (DC) (Resistance load)
Contact service life	4-wire: 50 million cycles. 2-wire: 5 million cycles (reference value)

Measurement specifications

(1) Conditions of guaranteed accuracy

Warm-up time	Same as instrument with the Z3003.
Accuracy guarantee temperature and humidity range	23°C ±5°C (73.4°F ±41°F), 80%RH or less
Accuracy guarantee duration	1 year
Accuracy specifications conditions	When using a 2-wire setup, accuracy is guaranteed only after zero adjustment.
Temperature coefficient	From 0°C to 18°C and 28°C to 40°C, add a temperature coefficient of ±(1/10 of additional accuracy)/°C.

(2) Additional accuracy (Add the following error components to the instrument's measurement accuracy.)

Effects of leak current	<p>Add a reading error as follows depending on the measurement current (when using guarding) (With humidity of less than 70% RH. If the humidity is greater than or equal to 70% RH, add the following reading error × 5.):</p> $\frac{1 \times 10^{-9} \text{ (A)}}{I_{\text{MEAS}} \text{ (A)}} \times 100 \text{ (\% of reading)}$ <p>I_{MEAS}: Measurement current</p>
Effect of measurement speed	<p>Add the full scale error component as follows when the integration time is not a whole-number multiple of the power supply cycle:</p> $A_{\text{fs}} \times 0.5 \text{ (\% of full scale)}$ <p>A_{fs}: full scale error component for instrument with the Z3003</p>
Effect of offset voltage	<p>Add the following resistance to the error when OVC is OFF</p> $\frac{10 \times 10^{-6} \text{ (V)}}{I_{\text{MEAS}} \text{ (A)}} \text{ (\Omega)}$ <p>I_{MEAS} : Measurement current</p>
Effect of offset resistance fluctuations	<p>When using a 2-wire setup, add the following resistance to the error component. 0.1 (Ω)</p>

(3) Internal offset resistance

Internal measurement circuit resistance value	0.5 Ω (default)
--	-----------------

About instrument accuracy

See: "Measurement accuracy" (p.271)

Example accuracy calculations

(Digits in excess of display range are truncated.)

• Resistance measurement accuracy when using the Z3003

RM3545A measurement conditions:

100 k Ω range, measurement current of 100 μ A, OVC off, 0ADJ on, FAST, measurement target of 30 k Ω

Resistance measurement accuracy $\pm(0.008\%$ of reading $+0.005\%$ of full scale)

The accuracy error component is calculated first, and then the total error component is calculated.

(1) Calculating the accuracy error component

- Effects of leak current

The effects of leak current are determined based on the ratio of leak current to measurement current.

The result is added to the reading error.

$$\text{Additional error: } A = (1 \times 10^{-9}) / (100 \times 10^{-6}) \times 100 = 0.001\% \text{ of reading}$$

- Effect of measurement speed (During FAST measurement, the integration time is not a whole-number multiple of the power supply cycle.)

If the integration time is not a whole-number multiple of the power supply cycle, the effects of commercial power noise will be more pronounced.

$$\text{Additional error: } B = 0.005 \times 0.5 = 0.0025\% \text{ of full scale}$$

- Effect of offset voltage

The relay and connector thermoelectric force is observed as a measured value offset.

When using with OVC on, there is no need to add this.

$$\text{Additional error: } C = (10 \times 10^{-6}) / (100 \times 10^{-6}) = 0.1 \Omega$$

- Effect of offset resistance fluctuations

During 2-wire operation, results are affected by fluctuations in the internal offset resistance.

$$\text{Additional error: } D = +0.1 \Omega$$

(2) Calculating the total error component

$$\text{4-wire: } E = \pm\{(0.008 + A)\% \times 30 \text{ k}\Omega + (0.005 + B)\% \times 100 \text{ k}\Omega + C\} = \pm 10.3$$

$$\text{2-wire: } E + D = +10.4 \Omega, -10.3 \Omega$$

Function

(1) Contact cycle count recording function

A contact cycle count of up to 999,999,999 can be recorded using control from the instrument with the Z3003.

(2) Unit test

By shorting all the pins numbered 1 to 42, each measurement pin's round-trip route resistance value in the 2-terminal resistance measurement state can be checked using control from the instrument with the Z3003.

(3) Relay hot switching prevention monitor function

The current flowing between the current generation terminals (SOURCE terminals) can be monitored using control from the instrument with the Z3003.

Environment and safety specifications

Operating environment	Indoor use, pollution degree 2, altitude up to 2000 m (6562 ft.)
Storage temperature and humidity range	-10°C to 50°C (14°F to 122°F), 80%RH or less (non-condensing)
Operating temperature and humidity range	0°C to 40°C (32°F to 104°F), 80%RH or less (non-condensing)
Standards	
Safety	EN61010
EMC	EN 61326 Class A Effect of radiated radio-frequency electromagnetic field: 5% of full scale at 10 V/m (added to the effect on the instrument with the Z3003) Effect of conducted radio-frequency electromagnetic field: 5% of full scale at 3 V (added to the effect on the instrument with the Z3003)
Dimensions	Approx. 92W × 24.5H × 182D mm (3.62W × 0.96H × 7.17D in.) (excluding protrusions)
Weight	Approx. 180 g (6.3 oz.)
Product warranty duration	3 years Relay: Not covered by the warranty

Included accessories

Instruction Manual	1
D-SUB 50-pin connector	1 (pin header, solder cup)

13 Maintenance and Service

13.1 Repair, Inspection, and Cleaning



WARNING

■ Do not attempt to modify, disassemble, or try to repair the instrument.



Doing so could cause serious bodily injury or fire.

Replaceable parts and service lives

Properties of some parts used in the instrument may deteriorate after a long-term use.

The regular replacement of those parts is recommended to use the instrument properly for a long time.

To order replacements, please contact your Hioki distributor.

The useful lives of the parts depend on the operating environment and frequency of use. These parts are not guaranteed to operate throughout the period defined by the recommended replacement interval.

Parts Name	Recommended Replacement Period	Note and Condition
Electrolytic Capacitors	Approx. 10 years	A PCB on which a part concerned is mounted must be replaced.
Backlight of LCD (Half-life of Brightness)	Approx. 50,000 hours	
Battery for Memory Backup	Approx. 10 years	When turning on the instrument, if the clock is not substantially accurate, the battery should be replaced.
Relay	Approx. 50 million cycles	
Relay (Z3003 Multiplexer Unit)	Approx. 50 million cycles	4-wire
	Approx. 5 million cycles	2-wire

Calibration

The calibration frequency varies depending on the status of the instrument or installation environment. It is recommended to determine a calibration period based on those factors and to have the instrument regularly calibrated by Hioki.

Backing up data

When repairing or calibrating the instrument, we may initialize it or update it to the latest software version.

It is recommended to back up (save/write) data such as the settings and measurement data before requesting service.

Transporting

 **CAUTION**

Observe the following when shipping the instrument.



- **Remove accessories and options from the instrument.**
- **Attach a description of the malfunction.**
- **Use the packaging in which the instrument was initially delivered and then pack that in an additional box.**

Failure to do so could cause damage during shipment.

Cleaning

 **CAUTION**

- **If the instrument becomes dirty, wipe the instrument clean with a soft cloth moistened with water or a neutral detergent.**



Never use solvents such as benzene, alcohol, acetone, ether, ketone, thinners or gasoline. Doing so could deform and discolor the instrument.

Wipe the LCD gently with a soft, dry cloth.

13.2 Troubleshooting

If damage is suspected, read the “Before Returning for Repair” section to remedy the problem. If this does not help you, contacting your authorized Hioki distributor or reseller.

Filling out “Inquiry Sheet” at the end of this manual provides a convenient way to submit your questions.

Before Returning for Repair

General issues

No.	Issue	Items to check	Possible causes → Solutions	See	
1-1	The instrument cannot be turned on. (The display shows nothing.)	Color of the STANDBY key	Green	The display settings have not been configured correctly. →Adjust the backlight brightness and contrast.	p.135 p.134
			Red	The instrument is in the standby state. →Press the STANDBY key.	p.43
			None (Off)	The instrument is not receiving power. →Check the continuity of the power cord. →Verify that a circuit breaker has not been tripped. →Turn on the main power switch (on the back of the instrument).	p.43
				The supply voltage or frequency is incorrect. →Check the power supply ratings (100 V to 240 V, 50/60 Hz).	p.263
1-2	The keys are unresponsive.	Display	[LOCK]	The key lock function is active. →Cancel the key lock function. →Turn OFF the EXT. I/O KEY_LOCK signal.	p.131
			[RMT]	The instrument is in the remote state. →Cancel the remote state.	p.244
			Panel name is shown.	A panel load operation has been triggered by the EXT. I/O. →Turn off the EXT. I/O's LOAD signal.	p.91
			[LOCK] or [RMT], and no panel name display	Certain functions cannot be used simultaneously. →See the list of functional limitations.	p.310
1-3	The instrument's comparator lamp will not turn on.	Measured values	Displayed	The comparator function is OFF. →Turn ON the comparator function.	p.101
			Not displayed (Display other than value)	If the measured value is not being displayed, no judgment will be made, and the lamp will not turn on.	–
1-4	The LED Comparator Attachment will not turn on.	Instrument's comparator lamp	On	The attachment is not properly connected. →Connect the LED Comparator Attachment properly to the COMP.OUT terminal.	p.108
				There is a broken connection. →Replace the LED Comparator Attachment.	–
			Off	See No. 1-3 above, “The instrument's comparator lamp will not turn on.”	p.301

No.	Issue	Items to check	Possible causes → Solutions	See
1-5	The beeper is not audible.	Key beeper is disabled	The function is off. →Turn on the function.	p.132
		Judgment beeper is disabled	The function is off. →Turn on the function.	p.106
1-6	You wish to change the beeper volume.	The instrument's beeper volume cannot be changed.	-	-

Measurement issues

No	Issue	Items to check	Possible causes → Solutions	See
2-1	Measured values are unstable.	Noise may be affecting measurement.		See 14.9 (1) (2). p.338 p.340
		Measurement leads	Clip-type leads	See 14.7 (3). p.331
			Wiring becomes two-terminal wiring in middle.	See 14.7 (12). p.336
		Measurement target	Wide or thick	See 14.7 (4). p.332
			Temperature is unstable (just manufactured, just opened, being held by hand, etc.).	See 14.7 (5). p.332
			Low heat capacity	See 14.7 (6). p.333
			Transformer, motor, choke coil, solenoid	See 14.7 (9) (10) and 14.9 (1). p.334 p.334 p.338
		TC	ON	The temperature sensor is not appropriately positioned. →Move the temperature sensor closer to the measurement target. →Position the temperature sensor so that it is not exposed to wind. →If the response to the measurement target's temperature change is slower than the temperature sensor's response, increase the response time by covering the temperature sensor with something. The temperature sensor's response time is about 10 minutes (reference value). p.11
			OFF	The measurement target's resistance value is changing due to the temperature, for example because the room temperature has not stabilized. →Turn ON temperature correction (TC). p.76
		OVC	OFF	The measurement is affected by thermal EMF. →Turn ON the OVC function. p.83
Using multiplexer unit to perform scan measurement		Delay is inadequate. → Set the delay longer. p.86 p.334		

No	Issue	Items to check		Possible causes → Solutions	See
2-2	Measured values differ from expected values. (A negative value is shown.)	Zero adjustment	ON	Zero adjustment is not accurate. →Perform zero adjustment again.	p.69 p.53
			OFF	Values are being affected by route resistance or thermoelectric power due to two-terminal measurement. →Perform zero adjustment.	p.69
		Scaling function	ON	The offset setting is incorrect. →Turn scaling off, or reconfigure the setting properly.	p.78 p.53
		Measurement leads		The measurement leads are not connected properly. →Check the connections.	p.52 p.53
		See No. 2-1 above.			
2-3	No measured value is displayed. (Concerning the display of measured value faults, see also p.56.)	Measured values	[- - - - -]	There is a break in the measurement leads. →Replace the measurement leads.	p.32
				The contact resistance is too high (for user-made leads). →Increase the contact pressure. →Clean or replace the probe tips. →Use a range with a low measurement current or set the measurement current to low.	p.58 p.67
				The route resistance is too high (for user-made leads). →Make the wiring thicker and shorter. →Use a range with a low measurement current or set the measurement current to low.	p.58 p.67
			[CONTACT TERM.A], [CONTACT TERM.B]	The probe is worn. There is a break in the measurement leads. →Replace the measurement leads.	p.32
				The probe is not coming into contact with the measurement target. →Place the probe in proper contact with the target.	-
				The resistance value between the SENSE and SOURCE is high because the measurement target is conductive paint, conductive rubber, or a similar material. →Turn the contact check function off.	p.90
			[OvrRng]	The measurement range is low. →Select a high-resistance range or use auto-ranging.	p.48
			[SW.ERR ERR:061]	A multiplexer relay hot-switching prevention function error has occurred. →The relay cannot be switched because the current from the measurement target has not decreased. Increase the delay setting since the measurement circuit may be being influenced by back EMF from a transformer or other device. Do not apply any current or voltage to the measurement terminals.	p.56

No	Issue	Items to check		Possible causes → Solutions	See
2-3	No measured value is displayed. (Concerning the display of measured value faults, see also p.56.)	Measured values	[NO UNIT]	No multiplexer unit has been inserted. →Insert the unit properly. Do not allocate units that have not been inserted to channels.	p.41
			Nothing is shown.	Auto-ranging is not selecting a range. →See No. 2-4 below.	p.304
			No measured value is shown, even if the measurement leads are shorted.	The fuse may have tripped. →Cycle the instrument's power and then perform the self-test to check whether the fuse has tripped. →When using the multiplexer, if the measured value is not displayed after replacing the measurement fuse, the multiplexer unit's fuse may have tripped. Request repair. The measurement and guard terminals may be shorted. →Check whether the measurement leads are damaged.	p.44
2-4	Auto-ranging is not selecting a range. (The range is not appropriate.)	Measurement target is a transformer or motor.		Auto-ranging is not able to select a range for measurement targets that have high inductance. →Use a fixed range.	p.48
		Noise may be affecting measurement.		See 14.9 (1) (2).	p.338
2-5	It is impossible to perform zero-adjustment.	Measured values before zero adjustment exceed -1% to 50% of each range full-scale, or a measurement fault has occurred.		There is a problem with the wiring. →Repeat zero adjustment with the correct wiring. Since zero adjustment cannot be performed if the resistance value is too high, for example with a user-made cable, work to minimize the route resistance.	p.325
2-6	The auto-hold function is not working (hold operation is not being canceled).	Measured values	Are unstable.	See No. 2-1 above, "Measured values are unstable."	p.302
			Do not change.	An appropriate range has not been selected. →Select an appropriate range or use auto-ranging.	p.48
2-7	Measured temperature is displayed incorrectly.	Temperature sensor and thermometer connection		The temperature sensor or thermometer is not properly connected. →Connect the temperature sensor by inserting the plug all the way. The settings have been improperly configured. →Check the settings. A temperature sensor other than that specified is used. →9451 Temperature Probe is not supported.	p.34 p.37

EXT. I/O issues

The EXT. I/O test (p.227) function can be used to more easily check operation.

No	Issue	Items to check	Possible causes → Solutions	See
3-1	The instrument is not operating at all.	The IN and OUT values displayed on the instrument's EXT. I/O test do not agree with the controller.	The wiring is incorrect. <ul style="list-style-type: none"> • The connector is loose. • The pin number is incorrect. • The ISO-COM terminal is not connected properly. • The NPN/PNP setting is not configured correctly. • Contact (or open collector) control is not enabled (voltage control is being used). • No power is being supplied to the controller. (Power does not need to be supplied to the instrument.) → Check EXT. I/O (p.185) again.	p.185
3-2	The trigger has not activated.	The trigger source is set to the internal trigger (INT).	If the internal trigger setting is being used, the TRIG signal will not serve as a trigger. →Select the external trigger setting.	p.217
		The TRIG ON time is less than 0.1 ms.	The TRIG on time is too short. →Ensure that the on time is at least 0.1 ms.	-
		The TRIG OFF time is shorter than 1 ms.	The TRIG off time is too short. →Ensure that the off time is at least 1 ms.	-
		The TRIG/PRINT signal filter function is ON.	A longer signal control time is required. →Increase the signal on time. →Turn off the filter function.	p.221
		The <code>:INIT:CONT</code> command is OFF.	The instrument is not in the trigger wait state. →Send the <code>:INIT</code> or <code>:READ?</code> command.	-
3-3	Unable to print.	The interface is not set to the printer.	Set the interface to the printer.	p.252
		The TRIG/PRINT signal filter function is ON.	A longer signal control time is required. →Turn off the function.	p.221
3-4	Unable to load panel.	No panel has been saved using the panel number that you are trying to load.	The instrument cannot load a panel that has not been saved. →Change the LOAD signal or resave the panel before the LOAD signal is asserted.	p.194
3-5	The channels cannot be switched with the LOAD signal.	The channel numbers have not been set. The channels have been disabled. The scan function has been turned off.	The scan settings have been improperly configured. →Configure the scan settings correctly.	p.154

No	Issue	Items to check		Possible causes → Solutions	See
3-6	EOM is not being output.	The measured value is not being updated.		See No. 3-2 above.	p.305
		EOM signal logic		The EOM signal turns on when measurement completes.	-
		EOM signal setting	Pulse	The pulse width is too narrow, and the EOM signal is not being read while it is on. →Increase the EOM signal's pulse width setting or set the EOM signal setting to "hold."	p.223
Hold	The measurement time is too short, and the interval during which the EOM signal is off cannot be detected. →Change the EOM signal setting to "pulse."		p.223		
3-7	The Hi, IN and Lo signals are not being output.	The instrument's comparator lamp is off.		See No. 1-3 above.	p.301
		The output mode is set to BCD.		Change to judgment mode (in BCD mode, the result of a logical OR operation applied to Hi and Lo is output from one signal line).	p.225
3-8	T_PASS, T_FAIL, The T_ERR signal is not being output.	The scan function is off. Measurement of all channels has not completed.		The scan settings have been improperly configured. →Check the scan settings.	p.154
3-9	The BCD signal is not being output.	The output mode is set to JUDGE.		Change to BCD mode.	p.225
		The BCD_LOW signal is not being controlled.		Control the BCD_LOW signal (failure to do so will cause only the upper digits to be output).	p.191
3-10	The RANGE_OUT signal is not being output.	The BCD_LOW signal is not being controlled.		Control the BCD_LOW signal (failure to do so will cause the RANGE_OUT signal not to be output).	p.191
3-11	The multiplexer channels cannot be switched with the LOAD signal.	The MUX signal is not on.		Turn on the MUX signal.	p.191

Communications issues

The communications monitor (p.245) function can be used to more easily check operation.

No	Issue	Items to check		Possible causes → Solutions	See
4-1	The instrument is not responding at all.	Display	[RMT] is not being displayed.	No connection has been established. →Check whether the connector has been connected. →Check whether the interface settings have been configured properly. →(USB) Install the driver on the control device. →(RS-232C) Use a cross cable. →(USB, RS-232C) Check the COM port number on the control device. →(RS-232C) Use the same communications speed for the instrument and the control device. →(LAN) Check that the IP address does not overlap with that of other network instruments. The initial IP address for the instrument is "192.168.1.1".	p.232

No	Issue	Items to check		Possible causes → Solutions	See
4-2	An error is being encountered.	Display	Command error	The command isn't being recognized as a valid instruction. →Check the spelling of the command (space: x20H). →Do not append a question mark to commands that are not queries. →(RS-232C) Use the same communications speed for the instrument and the control device.	-
				The input buffer (256 bytes) is full. →Insert a dummy query after sending several lines of commands. Example: Send " *OPC? " → Receive " 1 "	-
			Execution error	Receive 1 The command string is correct, but the instrument is not able to execute it. Example <ul style="list-style-type: none"> When set during scanning The data portion was spelled incorrectly. ":SAMP:RATE SLOW3" →Check the specifications of the command(s) in question.	-
				The input buffer (256 bytes) is full. →Insert a dummy query after sending several lines of commands. Example: Send " *OPC? " → Receive " 1 "	-
4-3	The instrument fails to respond to queries.	On the command monitor	No response	The :TRIG:SOUR EXT setting is being used, and the instrument is waiting for the trigger after :READ? transmission. →Check the command specifications.	-
			Response	There is a mistake in the program. →Check the receive portion of the program.	-
4-4	Unable to switch the multiplexer channel. Unable to load multiplexer.	Measurement leads are connected to the measurement terminals on the front of the instrument.		Do not connect measurement leads to the measurement terminals on the front of the instrument when using the multiplexer.	p.154

Printer issues

No	Issue	Possible causes	Solutions	See
5-1	No data is being printed.	The instrument and printer are not connected properly.	<ul style="list-style-type: none"> • Check whether the connector has been connected. • Check whether the interface settings have been configured properly. • If using the PRINT signal, see No. 3-3 above. 	p.251 p.305
5-2	Printed text is garbled		The printer and instrument settings do not match. →Check the printer settings again.	-

Multiplexer issues

No	Issue	Display	Possible causes → Solutions	See
6-1	It is not possible to switch to the multiplexer inputs.	[ERR:60]	Measurement leads are connected to the measurement terminals on the front of the instrument. →Do not connect any measurement leads to the measurement terminals on the front of the instrument. If [ERR:60] is displayed even though no measurement leads are connected, turn off the instrument and remove the Z3003. If [ERR:60] is not displayed after removing the Z3003, the Z3003 could be broken. Request repair.	p.154
6-2	Channels cannot be switched by operating the instrument's keys.	[CH] is not being displayed.	The front terminals are being used as the measurement terminals. →Set the measurement terminals to MUX.	p.154
		Scan display (list display)	The scan function is set to auto or step. →Set the scan function to off in order to switch channels with key operation. The set unit number and the unit number in which the Z3003 is installed differ. →Check the settings and the unit on the back of the instrument.	p.154 p.41
		[RMT]	The instrument is in remote mode, in which it is controlled by communications functionality. →Operate the instrument after canceling remote mode.	p.244
6-3	Channels cannot be switched with EXT. I/O.	-	The MUX signal is not on. →Turn on the MUX signal.	p.191
6-4	Measured values are unstable.	-	See No. 2-1 above.	p.302
6-5	The measured value differs from the expected resistance value.	-	The wrong channel is being measured. →Check the current channel and the channel setting.	p.158
		-	The wiring is shorted. →Exercise care to avoid shorted wires.	-
		-	The route resistance is too high. →For 2-wire connection, the route resistance affects the measured value directly. Perform zero adjustment.	p.169
		-	Measurement leads are connected to the measurement terminals on the front of the instrument. →Do not connect measurement leads to the measurement terminals on the front of the instrument when using the multiplexer.	p.148

No	Issue	Display	Possible causes → Solutions	See
6-6	No measured value is displayed.	-	The wrong channel is being measured. →Check the current channel and the channel setting.	p.158
		[NO UNIT]	The set unit number and the unit number in which the Z3003 is installed differ. →Check the settings and rear of the unit.	p.154 p.41
			The connected device is set to an external device. →Set the connected device to the RM3545.	p.161
		-	The relays are worn. →Perform the multiplexer unit test. If it yields a FAIL result, request repair of the Z3003.	p.172 p.299
		-	The wiring is shorted. →Check the wiring.	-
		-	See No. 2-3 above.	p.303
6-7	Zero adjustment values are not being applied.	-	Zero adjustment has not been performed for each channel. →Check whether zero adjustment has been performed for each channel on the Multiplexer Basic Measurement screen. Zero adjustment is performed separately for the front terminals and for each channel, so you will need to perform it for each channel (scanning zero adjustment can also be performed).	p.169
		-	The route resistance is too high. (Measured values before zero adjustment exceed -1% to 50% of each range full-scale, or a measurement fault has occurred.) →Zero adjustment cannot be performed when the route resistance is too high. Modify your setup so that the route resistance is less than 50% of the measurement target.	p.325
6-8	Zero adjustment cannot be performed.	-	The connected device is set to an external device. →Zero adjustment cannot be performed for channels whose connected device is an external device. Set the connected device to the RM3545.	-
		-	The route resistance is too high. (Measured values before zero adjustment exceed -1% to 50% of each range full-scale, or a measurement fault has occurred.) →Zero adjustment cannot be performed when the route resistance is too high. Modify your setup so that the route resistance is less than 50% of the measurement target.	p.325
6-9	The unit test generates a FAIL result.	-	<ul style="list-style-type: none"> The relays are worn. The fuse in the unit is blown out. → Request repair of the Z3003.	p.299
6-10	Switching is too slow.	-	The relay hot switching prevention function is being triggered because back EMF is remaining when measuring a transformer. →Use a high-resistance range or lower the measurement current, for example by using the low current switching setting.	p.148

List of functional limitations

✓: Compatible, - : Incompatible

	COMP	TC	ΔT	BIN	MUX	STAT	AUTO RANGE, RANGE change
COMP		✓	-	-	✓	✓	-
TC	✓		-	✓	✓	✓	✓
ΔT	-	-		-	✓	-	✓
BIN	-	✓	-		-	✓	-
MUX	✓	✓	✓	-		-	✓
STAT	✓	✓	-	✓	-		✓
AUTO RANGE, RANGE change	-	✓	✓	-	✓	✓	

- When low-power mode is on, OVC will be fixed to on and contact improvement will be fixed to off. During SLOW2 operation, two-iteration averaging is used even if the averaging function is off.
- When the multiplex scan function is set to auto or step, the trigger source is automatically set to EXT. In addition, the communications function's memory function will not be available for use.
- When using the multiplexer in 2-wire mode, the contact check function is disabled. In addition, the ranges of 1000 mΩ and less will not be available for use.

External Control (EXT. I/O) Q&A

Common Questions	Answers
How do I connect external trigger input?	Connect the TRIG signal to an ISO_COM pin using a switch or open-collector output.
Which pins are common ground for input and output signals?	The ISO_COM pins.
Are the common (signal ground) pins shared by both inputs and outputs?	Use ISO_COM as the common pin for input and output signals. The ISO_COM pin serves as the shared common pin.
How do I confirm output signals?	Confirm voltage waveforms with an oscilloscope. To do this, the output pins such as EOM and comparator judgment outputs need to be pulled up (through several k Ω).
How do I troubleshoot input (control) signal issues?	For example, if TRIG signal does not operate properly, bypass the PLC and short the TRIG pin directly to an ISO_COM pin. Be careful to avoid power shorts.
Are the comparator judgment signals retained during measurement (or can they be off)?	When using the external trigger [EXT] setting, the state is determined at the end of measurement, and is off once at the start of measurement. When using the internal trigger [INT] setting, judgment results are held during measurement.
What situations cause measurement faults to occur?	An error is displayed in the following cases: <ul style="list-style-type: none"> • A probe is not connected • A contact is unstable • A probe or measurement target is dirty or corroded • Measurement target resistance is much higher than the measurement range
Is a connector or flat cable for connection provided?	A solder-type connector is supplied. The cable must be prepared at the user's side.
Is direct connection to a PLC possible?	If the PLC's outputs are relays or open collectors and the PLC's input circuit supports contact input, it can be connected directly. Before connecting, confirm that voltage and current ratings will not be exceeded.
Can EXT. I/O be used at the same time as RS-232C or other communications?	After setting up communications, it is possible to control measurement with the TRIG signal while acquiring measurement data via a communications interface.
How should external power be connected?	The instrument's ISO_5V EXT I/O terminal is a power supply output terminal. Do not connect the ISO_5V terminal to an external power supply such as a PLC.
Can free-running measured values be acquired using a footswitch?	Measured values can be acquired using the sample application software. The sample application software is available for download from Hioki's website. https://www.hioki.com/global/support/download/software/

Error displays

When an error is displayed on the LCD screen, repair is necessary. Contact your authorized Hioki distributor or reseller.

Display		Description	Remedy
+OvrRng/-OvrRng		Over-range (p.56)	Select the appropriate range.
CONTACT TERM.A (CONTACT A, CA)		Measurement terminal A-side wiring contact error (p.56)	Check for cable breakage and worn out probes.
CONTACT TERM.B (CONTACT B, CB)		Measurement terminal B-side wiring contact error (p.56)	Check for cable breakage and worn out probes.
SW.ERR		See ERR:061 (p.313).	
NO UNIT		No multiplexer unit has been inserted.	Insert the unit properly. Do not allocate units that have not been inserted to channels.
ERR:001	LOW limit is higher than UPP limit.	Cannot set because the lower limit value is larger than the upper limit value.	Set an upper limit value that is larger than the lower limit value. (p.102)
ERR:002	REF setting is zero.	Cannot set because the reference value setting is zero.	Set a reference value that is larger than zero. (p.104)
ERR:003	Cannot switch ranges. (comparator or bin is ON)	Cannot switch ranges when the comparator or BIN is ON.	<ul style="list-style-type: none"> Set the range after turning the comparator or BIN off. Select the range to use on the Comparator Settings screen or BIN Number Settings screen. (p.99)(p.110)
ERR:004	Cannot turn auto-ranging ON. (comparator or bin is ON)	Cannot turn auto-ranging ON while the comparator or BIN is ON.	Turn off the comparator. (p.101) (p.109)
ERR:010	0 ADJ error. Must not exceed 50% or -1% f.s.	Out of zero adjustment range. The reading must be within -1% to 50% of range full-scale.	Check the zero adjustment procedure (p.69).
ERR:011	Temp. sensor error. Cannot calculate.	Cannot perform calculations due to a temperature sensor or thermometer error.	Check the temperature sensor or thermometer.
ERR:012	Comparator is invalid. (Delta T or BIN is ON)	The comparator cannot be turned on while the ΔT or BIN function is on.	Turn off the ΔT and BIN functions.
ERR:013	0 ADJ is invalid. (Must be lower than 10MΩ range)	Zero adjustment can be performed only for the 10 M Ω or lower ranges.	Zero adjustment cannot be performed for 100 M Ω and greater ranges.
ERR:020	Undo not available.	Statistics functions allow only one undo operation.	—
ERR:030	Command error.	Command Error.	Check for incorrect commands.
ERR:031	Execution error. (Parameter error)	Execution Error. The parameter value is out of range.	Check whether the parameter range is correct.
ERR:032	Execution error.	Execution Error.	Check whether any command has resulted in execution error conditions.
ERR:060	Cannot enable MUX function. Disconnect cable from front terminal.	Unable to use MUX.	When using MUX, disconnect the measurement leads from the terminals on the front of the instrument.

Display		Description	Remedy
ERR:061	MUX switching error.	A multiplexer relay hot-switching prevention function error has occurred.	The relay cannot be switched because the current from the measurement target has not decreased. Increase the delay setting since the measurement circuit may be being influenced by back EMF from a transformer or other device. Do not apply any current or voltage to the measurement terminals.
ERR:090	ROM check sum error.	Program ROM checksum error	The instrument is malfunctioning. Request repair.
ERR:091	RAM error.	CPU RAM error	The instrument is malfunctioning. Request repair.
ERR:092	Memory access failed. Main power off, restart after 10s.	A communications error occurred while attempting to access the memory.	Turn off the main power switch, wait at least 10 seconds, and turn it back on.
ERR:093	Memory read/write error.	Memory read/write test error	The instrument is malfunctioning. Request repair.
ERR:095	Adjustment data error.	Adjustment data error	The instrument is malfunctioning. Request repair.
ERR:096	Backup data error.	Settings backup error	Settings were reinitialized. Reconfigure measurement conditions and other settings.
ERR:097	Power line detection error. Select power line cycle.	Power frequency detection error	Set the frequency to match that of the power being supplied to the instrument.
ERR:098	Blown FUSE or measurement lead is broken.	The fuse has been tripped.	Replace the fuse. (p.315) If the fuse is not blown out, the measurement and guard terminals may be shorted. Disconnect the measurement leads and check whether or not the error occurs. If the error still occurs, request repair of the instrument. Furthermore, be sure to use a Hioki-specified fuse for replacement. Specified fuse: F1.6AH/250 V (non-arcing) 20 mm × 5 mm dia.
ERR:099	Clock is not set. Reset? (13-01-01 00:00:00) Press F2"	The clock is not set, so pressing F2 [OK] displays the initialized time 13-01-01 00: 00: 00.	The backup battery needs to be replaced. Contact your authorized Hioki distributor or reseller.
ERR:100	MUX unit error.	The MUX unit experienced an error.	The instrument is malfunctioning. Request repair of the instrument.

Message displays

The following table lists LCD messages and associated solutions.

Display		Description→Remedy
INFO:001	Panel load. OK?	Panel data will be loaded. Continue?
INFO:002	Panel loading...	Panel data is being loaded.
INFO:003	Enter panel name. ESC: CANCEL, ENTER: SAVE EXEC	Enter a name for the panel being saved. Cancel the save operation with the ESC key or save the panel with the ENTER key.
INFO:004	Enter panel name. Panel is used, will be overwritten. ESC: CANCEL, ENTER: SAVE EXEC	Enter a name for the panel being saved. The specified name already exists and will be overwritten if you proceed. Cancel the save operation with the ESC key or save the panel with the ENTER key.
INFO:005	Panel saving...	Panel data is being saved.
INFO:006	Clear panel. OK?	Panel data will be cleared. Continue?
INFO:007	Panel clearing...	Panel data is being cleared.
INFO:008	Printing...	Printing in progress.
INFO:010	Start interval print.	Interval printing started.
INFO:011	Stop interval print.	Interval printing stopped.
INFO:020	Performing 0 adjustment. OK?	Zero adjustment will be performed. Continue?
INFO:021	Clear 0 adjustment data. OK?	Zero adjustment values will be cleared. Continue?
INFO:022	Cleared 0 adjustment data.	Zero adjustment data was cleared.
INFO:023	0 ADJ warning. Adjust within 1% f.s.	Zero adjustment data values are large. (Warning) →It is recommended that values be within 1% of range full-scale.
INFO:025	Undo statistical calculations.	One statistical calculation was undone.
INFO:026	Self-calibrating...	Self-calibration measurement in progress.
INFO:030	Reset? NORMAL RESET (without panel clear) / SYSTEM RESET (with panel clear) / MUX RESET (only CH settings)	The instrument will be initialized.
INFO:035	MUX CH settings will be reset. Change setting?	The MUX channel settings will be initialized when switching between 4-terminal and 2-terminal measurement.
INFO:036	0 adjusting...	Zero adjustment is being performed with MUX scanning.
INFO:037	Short-circuit pin No.1 to No.42, OK?	To perform the unit test, short all the pins numbered 1 to 42.
INFO:038	Testing MUX units...	The multiplexer unit test is being performed. →The results will be displayed after the test is complete.
INFO:040	Enter password for Adjustment Mode.	Enter the password for adjustment mode. →The Adjustment screen is used in repairs and adjustment carried out by Hioki. It is not available for use by end-users.
INFO:041	Password is wrong.	The adjustment mode password is incorrect. Please enter the correct password.
INFO:080	Self-calibration is set to "manual".	Self-calibration measurement is set to MANU.

13.3 Replacing the Measurement Circuit's Protective Fuse

RM3545A-1 RM3545A-2

⚠ WARNING



- Use only fuses of the designated type, characteristics, rated current, and voltage.

Specified fuse: F1.6AH/250V (non-arcing) 20 mm × 5 mm dia.

- Do not use any other fuse (particularly not a fuse with a higher rated current).
- Do not use the product with the fuse holder's terminals shorted.

Doing so could cause damage to the instrument, resulting in bodily injury.

- Before replacing the fuse, turn off the instrument's main power switch and disconnect the cords and leads from the measurement target.

Failure to do so could cause the operator to experience an electric shock.

IMPORTANT

Inserting the fuse holder without first placing a replacement fuse into it may make it difficult to remove the fuse holder. Be sure to load a replacement fuse before inserting the holder.

Rear

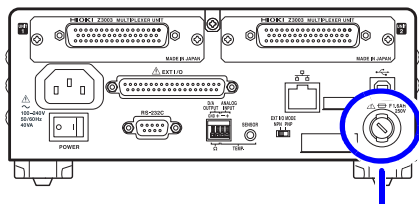

Fuse holder

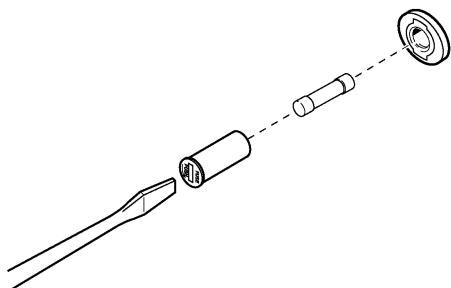

- 1 Confirm that the instrument's main power switch (rear panel) is off (○), and disconnect the power cord.
- 2 Unlock the fastener on the fuse holder on the rear panel using a slotted screwdriver, and remove the fuse holder.
- 3 Replace the fuse with a rated fuse.
- 4 Reset the fuse holder.

13.4 Disposing of the Instrument

The instrument uses a lithium battery for back-up power to the clock.

When disposing of this instrument, remove the lithium battery and dispose of battery and instrument in accordance with local regulations.

Removing the lithium battery



- Before removing the lithium battery, turn off the instrument's main power switch and disconnect the cords and leads from the measurement target.



Failure to do so could cause the operator to experience an electric shock.

- Store the removed lithium battery out of reach of children.

Failure to do so could allow children to accidentally ingest battery.

Required tools:

- One Phillips screwdriver (No.1)
- One wire cutter (to remove the lithium battery)

RM3545A-1

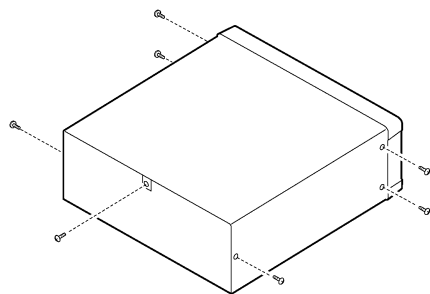

(Overhead view)

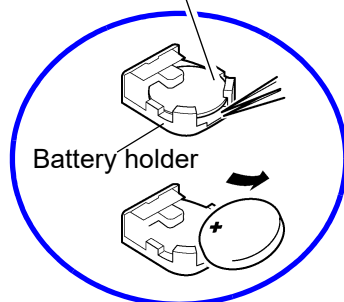
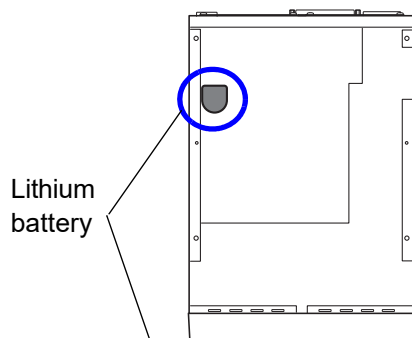

- 1 Confirm that the instrument's main power switch is off.
Disconnect the cables and power cord.
- 2 Remove the six screws from the sides and one screw from the rear.
- 3 Remove the cover.
- 4 Insert the tweezers between the battery and battery holder as shown in the diagram below and lift up the battery.



- Do not short + and -.
Doing so may cause sparks.

CALIFORNIA, USA ONLY

Perchlorate Material - special handling may apply.

See <https://dtsc.ca.gov/perchlorate/>

RM3545A-2

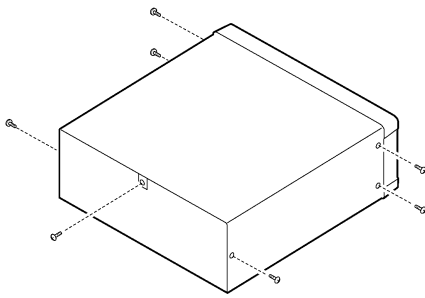

- 1** Verify that the power is off, and remove the Multiplexer Unit, connection cables and power cord.
- 2** Remove the six screws from the sides and one screw from the rear.

- 3** Remove the cover.

(Overhead view)

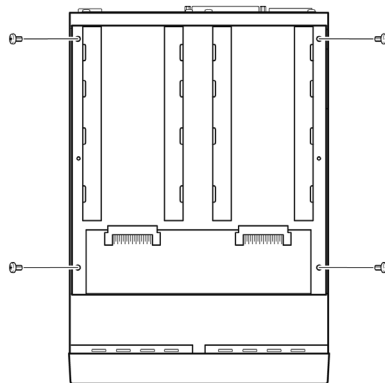

- 4** Remove the four screws and then remove the Multiplexer Unit frame.

- 5** Insert the tweezers between the battery and battery holder as shown in the diagram below and lift up the battery.

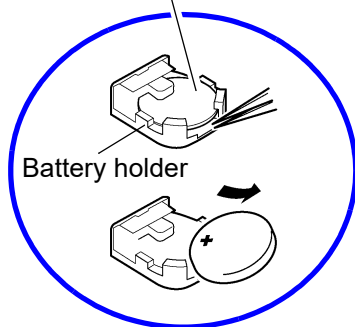
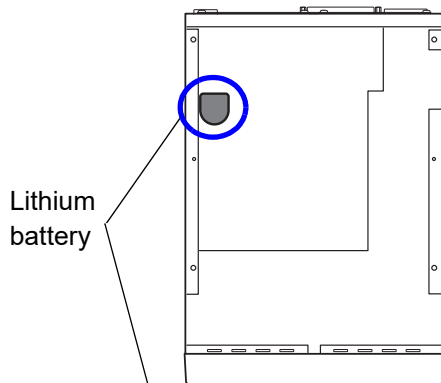

CAUTION

- Do not short + and –.
Doing so may cause sparks.

CALIFORNIA, USA ONLY

Perchlorate Material - special handling may apply.

See <https://dtsc.ca.gov/perchlorate/>

14 Appendix

14.1 Block Diagram

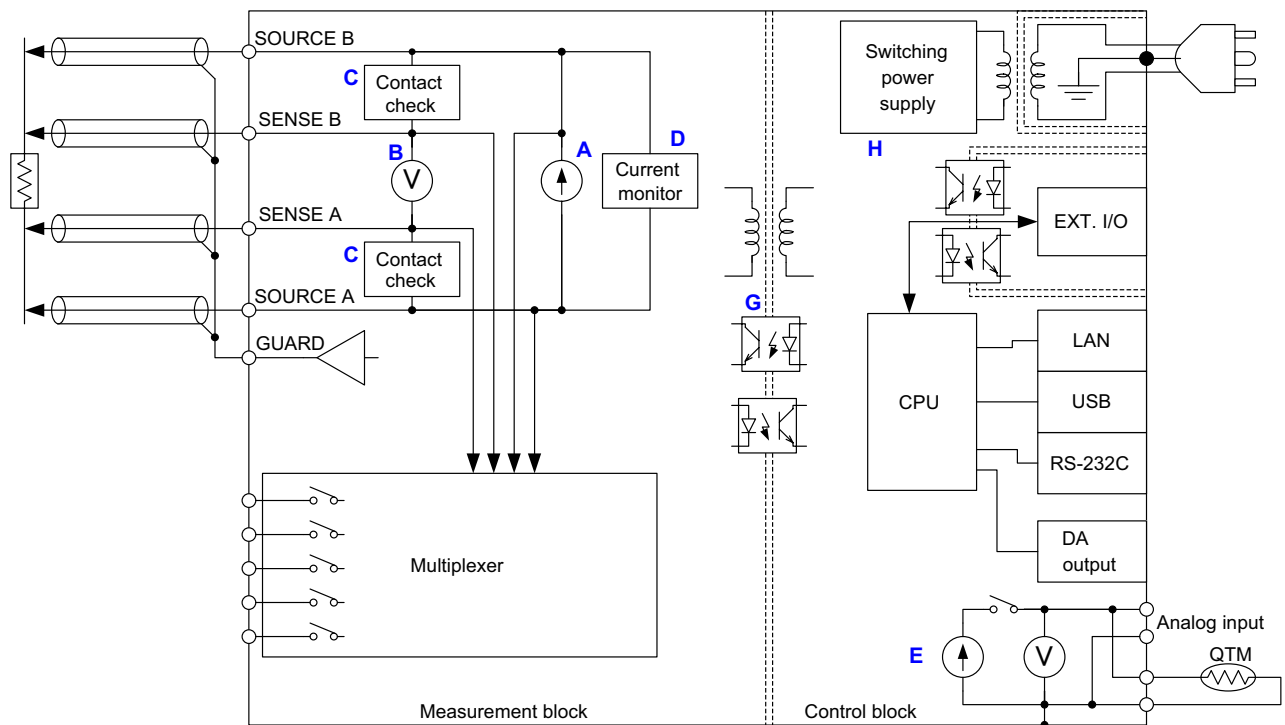

- Constant current (determined by the measurement range) is applied from the SOURCE B terminals to the SOURCE A terminals while voltage is measured between the SENSE B and SENSE A terminals. The resistance value is obtained by dividing the measured voltage by the constant current flow. (A, B)
- The effects of large offset voltages such as from thermal EMF can be reduced by current flowing in the positive and negative directions. (A)
- The low-noise voltmeter can perform stable measurement, even with an integration time of 0.3 ms. (B)
- When measurement starts, the contact check circuit and constant current monitor are activated to monitor for fault conditions while measuring. (C, D)
- The instrument incorporates a built-in temperature measurement circuit that can be used to correct resistance measured values according to the temperature when measuring a target that exhibits a high level of temperature dependence.
By separating the temperature measurement circuit from the constant current source, it is possible to connect thermometers with analog output. (E)
- The high-speed CPU provides ultra-high-speed measurements and fast system response. (F)
- Immunity from electrical noise is provided by isolation between the Measurement and Control blocks. (G)
- The auto-ranging 100-to-240 V switching power supply can provide stable measurements even in poor power quality environments. (H)

14.2 Four-Terminal (Voltage-Drop) Method

The resistance of the wiring connecting the measuring instrument and probes and the contact resistance that occurs between probes and the measurement target may prevent low resistance values from being measured at a high level of precision.

Route resistance varies greatly depending on the thickness and length of the wire. Cables used in resistance measurement may, for example, exhibit resistance of 90 mΩ/m (for No. 24 AWG {0.2 sq} wiring) or 24 mΩ/m (for No. 18 AWG {0.75 sq} wiring).

Contact resistance varies with probe wear, contact pressure, and measurement current. With good contact, resistance values are generally on the order of several milliohms but may reach as high as several ohms on occasion.

The four-terminal method is used to facilitate reliable measurement of low resistance values.

With two-terminal measurements (Fig. 1), the resistance of the test leads is included in the measurement target's resistance, resulting in measurement errors.

The four-terminal method (Fig. 2) consists of current source terminals (SOURCE A, SOURCE B) to provide constant current, and voltage detection terminals (SENSE A, SENSE B) to detect voltage drop.

Little current flows to the voltage detection terminal lead lines that are connected to the measurement target due to the voltmeter's high input impedance. Consequently, measurement can be performed accurately without being affected by the measurement lead resistance or contact resistance.

The instrument voltmeter's input impedance: 10 GΩ or more (reference value)

Two-terminal measurement method

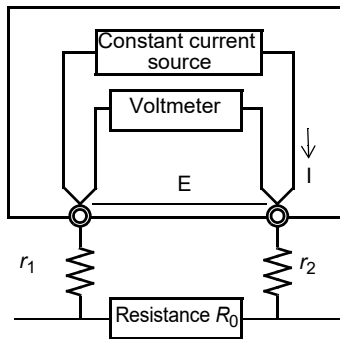

Figure 1.

Current I flows through measurement target resistance R_0 as well as route resistances r_1 and r_2 . Therefore, the voltage to be measured is obtained by $E = I(r_1 + R_0 + r_2)$, which includes route resistances r_1 and r_2 .

Four-terminal measurement method

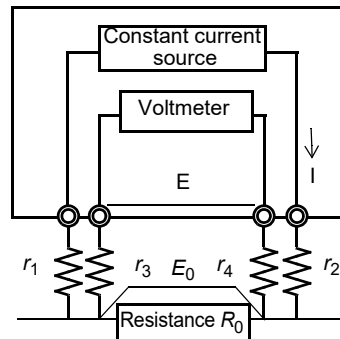

Figure 2.

Current I flows from r_2 through target resistance R_0 and through r_1 . The high input impedance of the voltmeter allow only negligible current flow through r_3 and r_4 . So the voltage drop across r_3 and r_4 is practically nil, and voltage E across the measurement terminals and voltage E_0 across measurement target resistance R_0 are essentially equal, allowing measurement target resistance to be measured without being affected by r_1 to r_4 .

14.3 DC and AC Measurement

Resistance (impedance) measurement can be performed using the DC or AC method.

- DC method
 - RM3542, RM3543, RM3544, RM3545, RM3545A, RM3548 resistance meters
 - Standard digital multimeters
 - Standard insulation resistance meters
- AC method
 - 3561, BT3561 series, BT3562 series, BT3563 series, BT3564 Battery HiTesters
 - BT3554 series Battery Tester
 - Standard LCR meters

The DC measurement method is used widely in applications such as measurement of general- purpose resistors, winding resistance, contact resistance, and insulation resistance. In the DC method, the measurement setup consists of a DC power supply and a DC voltmeter. While its simple circuitry makes it easier to increase accuracy, it is prone to measurement errors due to electromotive force that may be present in the measurement path.

See: “14.10 Effect of Thermal EMF” (p.342)

The AC method is used when it is not possible to measure using DC, for example in impedance measurement of inductors, capacitors, or batteries. Since an AC ohmmeter consists of an AC power supply and an AC voltmeter, it is not affected by DC electromotive force. On the other hand, caution is necessary since results differ from those obtained using DC measurement, for example due to components such as core loss in coils' series equivalent resistance.

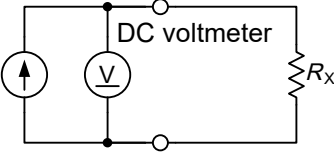
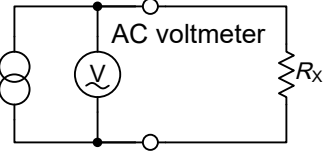
	DC ohmmeter	AC ohmmeter
Measurement signal Detection voltage	DC DC power supply 	AC AC power supply 
Advantages	High-precision measurement is possible.	Not affected by electromotive force. Reactance measurement is possible.
Disadvantages	Affected by electromotive force since not capable of performing DC superimposed measurement. (Thermal EMFs can be corrected by the OVC function.)	Difficult to increase precision.
Applications	DC resistance of windings such as transformers and motors, contact resistance, insulation resistance, PCB route resistance	Battery impedance, inductor, capacitor Electrochemical measurement
Measurement range	10^{-8} to 10^{16}	10^{-3} to 10^8
Hioki instruments	Resistance meters: RM3542 to RM3548 DMM: DM7275, DM7276 Insulation resistance meters: IR4000 series, SM series	Battery HiTesters: 3561, BT3562, BT3563 LCR Meters: IM3570, IM3533, IM3523, and so on

14.4 Temperature Correction (TC) Function

The temperature correction function converts the resistance values of temperature-dependent measurement targets such as copper wire into resistance values at a specific temperature (known as the standard temperature) and displays the results.

Resistances R_t and R_{t_0} below are the resistance values of the measurement target at t °C and t_0 °C (having resistance temperature coefficient at t_0 °C of α_{t_0}).

$$R_t = R_{t_0} \times \{ 1 + \alpha_{t_0} \times (t - t_0) \}$$

R_t	Actual measured resistance (Ω)
R_{t_0}	Corrected resistance (Ω)
t_0	Reference temperature ($^{\circ}\text{C}$)
t	Ambient temperature ($^{\circ}\text{C}$)
α_{t_0}	Temperature coefficient at t_0 ($1/^{\circ}\text{C}$)

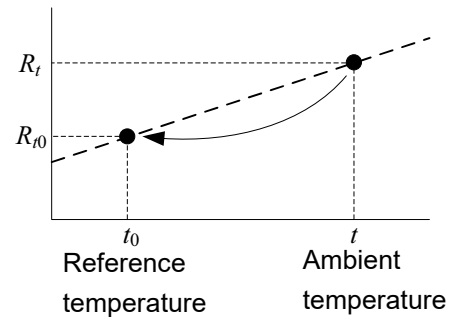

Example:

If a copper measurement target (with resistance temperature coefficient of 3930 ppm/ $^{\circ}\text{C}$ at 20 $^{\circ}\text{C}$) measures 100 Ω at 30 $^{\circ}\text{C}$, its resistance at 20 $^{\circ}\text{C}$ is calculated as follows:

If measuring a copper wire*¹ with a resistance value of 100 Ω at 30 $^{\circ}\text{C}$, the resistance value at 20 $^{\circ}\text{C}$ can be calculated using the resistance temperature coefficient as follows:

*1. The resistance temperature coefficient for copper wire at 20 $^{\circ}\text{C}$ is 3930 ppm/ $^{\circ}\text{C}$.

$$\begin{aligned} R_{t_0} &= \frac{R_t}{1 + \alpha_{t_0} \times (t - t_0)} \\ &= \frac{100}{1 + (3930 \times 10^{-6}) \times (30 - 20)} \\ &= 96.22 \Omega \end{aligned}$$

Refer to the following for temperature correction settings and execution method:

See: “4.5 Correcting for the Effects of Temperature (Temperature Correction [TC])” (p.76)

See: “4.18 Performing Temperature Rise Test (Temperature Conversion Function [ΔT])” (p.118)

IMPORTANT

- The temperature sensor detects only ambient temperature; not surface temperature.
- Allow the instrument to warm up before making measurements.
- Place the temperature sensor near the measurement target and allow both the sensor and the target to adequately adjust to the ambient temperature prior to use (for more than 10 minutes).

Reference

Conductive Properties of Metals and Alloys

Material	Content (%)	Density ($\times 10^3$) (kg/m ³)	Conductivity	Temperature coefficient (20°C) (ppm/°C)
Annealed copper wire	Cu>99.9	8.89	1.00 to 1.02	3810 to 3970
Hard-drawn copper wire	Cu>99.9	8.89	0.96 to 0.98	3770 to 3850
Cadmium copper wire	Cd 0.7 to 1.2	8.94	0.85 to 0.88	3340 to 3460
Silver copper	Ag 0.03 to 0.1	8.89	0.96 to 0.98	3930
Chrome copper	Cr 0.4 to 0.8	8.89	0.40 to 0.50 0.80 to 0.85	2000 3000
Carlson alloy wire	Ni 2.5 to 4.0 Si 0.5 to 1.0		0.25 to 0.45	980 to 1770
Annealed aluminum wire	Al>99.5	2.7	0.63 to 0.64	4200
Hard-drawn aluminum wire	Al>99.5	2.7	0.60 to 0.62	4000
Aldrey wire	Si 0.4 to 0.6 Mg 0.4 to 0.5 Al remaining portion		0.50 to 0.55	3600

Copper Wire Conductivity

Diameter [mm]	Annealed copper wire	Tinned annealed copper wire	Hard-drawn copper wire
0.01 to less than 0.26	0.98	0.93	-
0.26 to less than 0.29	0.98	0.94	-
0.29 to less than 0.50	0.993	0.94	-
0.50 to less than 2.00	1.00	0.96	0.96
2.00 to less than 8.00	1.00	0.97	0.97

The temperature coefficient changes according to temperature and conductivity. If the temperature coefficient at 20°C is α_{20} and the temperature coefficient for conductivity C at t °C is α_{Ct} , α_{Ct} is determined as follows near ambient temperature.

$$\alpha_{Ct} = \frac{1}{\frac{1}{\alpha_{20} \times C} + (t - 20)}$$

For example, the temperature coefficient of international standard annealed copper is 3930 ppm/°C at 20°C. For tinned annealed copper wire (with diameter from 0.10 to less than 0.26 mm), the temperature coefficient α_{20} at 20°C is calculated as follows:

$$\alpha_{20} = \frac{1}{\frac{1}{0.00393 \times 0.93} + (20 - 20)} \approx 3650 \text{ ppm/°C}$$

References: Handbook for Electronics, Information and Communication Engineers, Volume 1, published by the Institute of Electronics, Information and Communication Engineers

14.5 Temperature Conversion (ΔT) Function

Utilizing the temperature-dependent nature of resistance, the temperature conversion function converts resistance measurements for display as temperatures. This method of temperature conversion is described here. According to IEC 60034, the resistance law may be applied to determine temperature increase as follows:

$$\Delta t = \frac{R_2}{R_1} (k + t_1) - (k + t_a)$$

Δt	Temperature increase ($^{\circ}\text{C}$)
t_1	Winding temp. ($^{\circ}\text{C}$, cool state) when measuring initial resistance R_1
t_a	Ambient temp. ($^{\circ}\text{C}$) at final measurement
R_1	Winding resistance (Ω) at temp. t_1 (cool state)
R_2	Winding resistance (Ω) at final measurement
k	Reciprocal ($^{\circ}\text{C}$) of temp. coefficient of conductor material at 0°C

Example

With initial resistance R_1 of 200 m Ω at initial temperature t_1 of 20°C , and final resistance R_2 of 210 m Ω at current ambient temperature t_a of 25°C , the temperature increase value is calculated as follows:

$$\begin{aligned} \Delta t &= \frac{R_2}{R_1} (k + t_1) - (k + t_a) \\ &= \frac{210 \times 10^{-3}}{200 \times 10^{-3}} (235 + 20) - (235 + 25) \\ &= 7.75^{\circ}\text{C} \end{aligned}$$

Therefore, the current temperature t_R of the resistive body can be calculated as follows:

$$t_R = t_a + \Delta t = 25 + 7.75 = 32.75^{\circ}\text{C}$$

For a measurement target that is not copper or aluminum with a temperature coefficient of α_{t_0} , the constant k can be calculated using the formula shown for the temperature correction function and the above formula, as follows:

$$k = \frac{1}{\alpha_{t_0}} - t_0$$

For example, the temperature coefficient of copper at 20°C is 3930 ppm/ $^{\circ}\text{C}$, so the constant k in this case is as follows, which shows almost the same value as the constant for copper 235 defined by the IEC standard.

$$k = \frac{1}{3930 \times 10^{-6}} - 20 = 234.5$$

14.6 About Zero Adjustment

14

Zero adjustment is a function which adjusts the zero point by deducting the residual value obtained during 0 Ω measurement. For this reason, zero adjustment must be performed when connection is made to 0 Ω . However, connecting a sample with no resistance is difficult and therefore is not practical.

In this respect, when performing the actual zero adjustment, create a pseudo connection to 0 Ω and then adjust the zero point.

To create 0 Ω connection state

If an ideal 0 Ω connection is made, the voltage between SENSE A and SENSE B becomes 0 V according to the Ohm's Law of $E = I \times R$.

In other words, if you set the voltage between SENSE A and SENSE B to 0 V, this gives you the same state of 0 Ω connection.

To perform zero adjustment using the instrument

The instrument uses a measurement fault detection function to monitor the state of connection between measurement terminals.

For this reason, when performing zero adjustment, you need to make connections between the terminals appropriately in advance (Fig. 1).

First, short between SENSE A and SENSE B to set the voltage between SENSE A and SENSE B to 0 V. If route resistances R_{SEA} and R_{SEB} of the cable are less than few Ω , there will be no problem. Because the SENSE terminal is a voltage measurement terminal, almost no current I_0 flows. Therefore, in the $E = I_0 \times (R_{SEA} + R_{SEB})$ formula, $I_0 \approx 0$ is achieved; if route resistances R_{SEA} and R_{SEB} are less than few Ω , voltage between SENSE A and SENSE B will become almost zero.

Next, make connection between SOURCE A and SOURCE B. This is to avoid display of error when no measurement current flows through. Route resistances R_{SOA} and R_{SOB} of the cable must be less than the resistance for flowing measurement current.

Furthermore, if the instrument also monitors the connection between SENSE and SOURCE, you need to make connection between SENSE and SOURCE. If route resistance R_{Short} of the cable has only few Ω , there will be no problem.

If you wire in the way described above, measurement current I flowing out from SOURCE B will go to SOURCE A but not to the lead of SENSE A or SENSE B. This enables the voltage between SENSE A and SENSE B to be kept accurately at 0 V, and appropriate zero adjustment becomes possible.

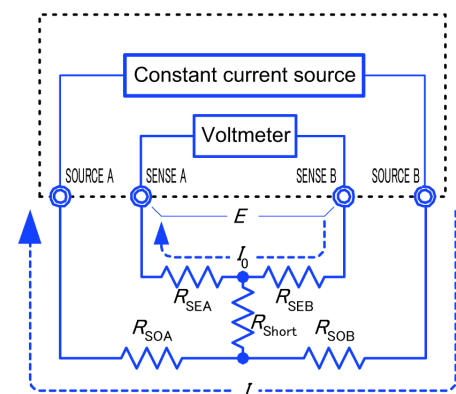

$$\begin{aligned} E &= (I_0 \times R_{SEB}) + (I_0 \times R_{SEA}) \\ &= (0 \times R_{SEB}) + (0 \times R_{SEA}) \\ &= 0 \text{ (V)} \end{aligned}$$

Figure 1. Pseudo connection to 0 Ω

To perform zero adjustment appropriately

Table 1 shows the correct and wrong connections. The resistances in the figure indicate route resistances; there will be no problem if they are less than few Ω respectively

In (a), if you connect SENSE A and SENSE B as well as SOURCE A and SOURCE B respectively, and use one path to make connection between SENSE and SOURCE, no potential difference occurs between SENSE A and SENSE B, and 0 V is input. This enables zero adjustment to be carried out correctly.

In (b), on the other hand, if you connect SENSE A and SOURCE A as well as SENSE B and SOURCE B respectively, and use one path to make connection between A and B, $I \times R_{Short}$ voltage occurs between SENSE A and SENSE B. For this reason, the pseudo 0 Ω connection state cannot be achieved and zero adjustment cannot be carried out correctly.

Connection method

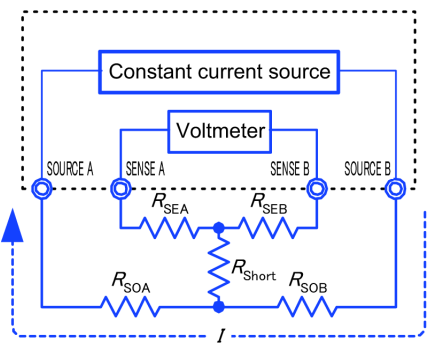
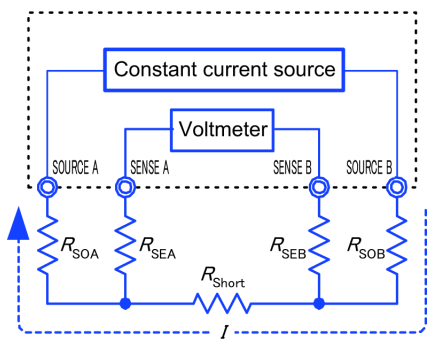
<p>Connection method</p>	 <p>(a) Use one point each between SENSE and SOURCE for connection</p>	 <p>(b) Use one point each between A and B for connection</p>
<p>Resistance between SENSE A and SENSE B</p>	$R_{SEA} + R_{SEB}$	$R_{SEA} + R_{Short} + R_{SEB}$
<p>Measurement current I's flow path</p>	$R_{SOB} \rightarrow R_{SOA}$	$R_{SOB} \rightarrow R_{Short} \rightarrow R_{SOA}$
<p>Voltage occurring between SENSE A and SENSE B</p>	<p>0</p>	$I \times R_{Short}$
<p>As connection method for zero adjustment</p>	<p>Correct</p>	<p>Incorrect</p>

To perform zero adjustment using measurement leads

When you actually perform zero adjustment using measurement leads, you may unexpectedly make the connection shown in Table 1 (b). Therefore, when performing zero adjustment, you need to pay sufficient attention to the connection state of each terminal.

Here, L2101 Clip Type Lead is used as an example for the connection explanation. Table 2 shows the connection state of the tip of the lead and equivalent circuit in the respective correct and wrong connections. Table 1 (a) indicates the correct connection method, resulting in 0 V between SENSE A and SENSE B. However, Table 1 (b) is the wrong connection method, so that 0 V is not obtained between SENSE A and SENSE B.

Clip type lead connection methods used during zero adjustment

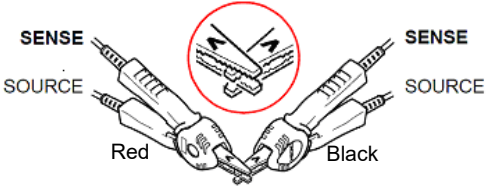
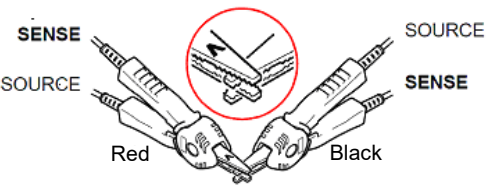
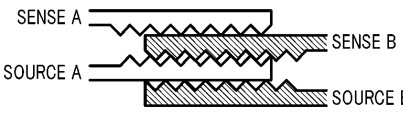
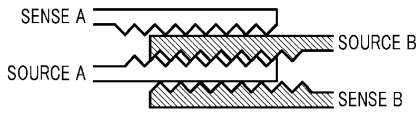
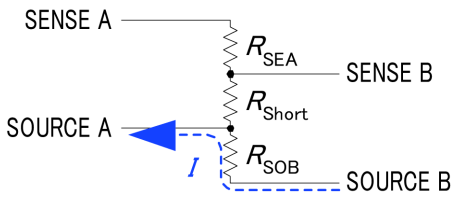
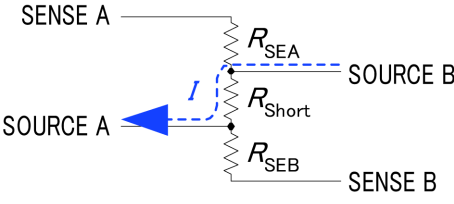
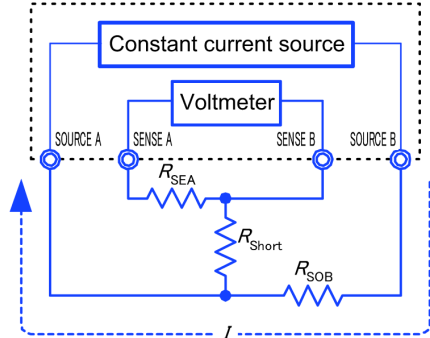
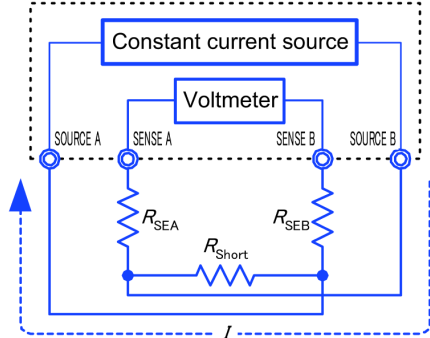
<p>Connection method</p>	<p style="text-align: center;">Correct</p> 	<p style="text-align: center;">Incorrect</p> 
<p>Tip of lead</p>		
<p>Equivalent circuit</p>		
<p>Deformed equivalent circuit</p>		
<p>As connection method for zero adjustment</p>	<p style="text-align: center;">Correct</p>	<p style="text-align: center;">Incorrect</p>

To perform zero adjustment using Z5038 0 ADJ Board

When performing zero adjustment, you cannot use a metal board or similar object to replace Z5038 0 ADJ Board.

Z5038 0 ADJ Board is not just a metal board. Its structure consists of two layers of metal boards screwed at one point. The zero adjustment board is used when performing zero adjustment of L2100 Pin Type Lead.

Table 3 shows cross sectional diagrams and equivalent circuits of the two connection methods: connecting Pin Type Lead to zero adjustment board, and connecting that to a metal board or similar object. Table 1 (a) indicates the connection using zero adjustment board, resulting in 0 V between SENSE A and SENSE B. However, Table 1 (b) is the connection using a metal board or similar object, so that 0 V is not obtained between SENSE A and SENSE B.

Pin type lead connection methods used during zero adjustment

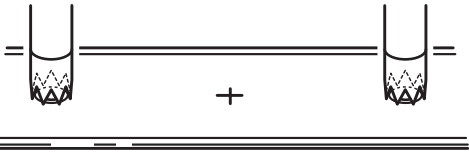
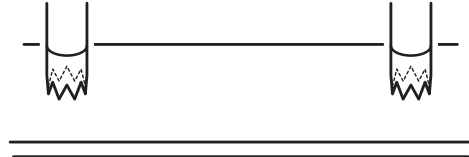
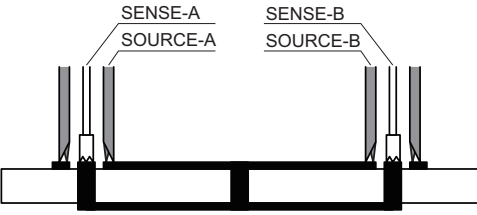
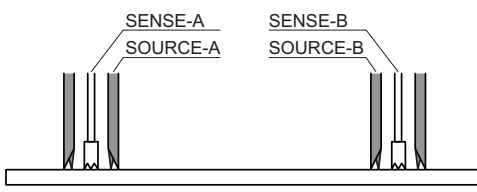
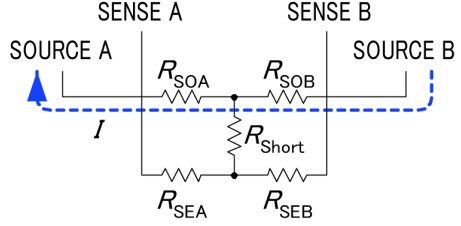
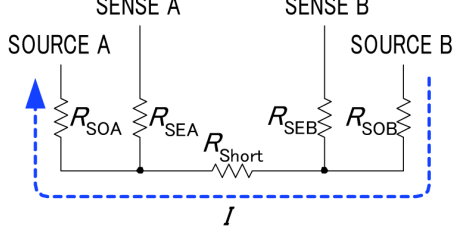
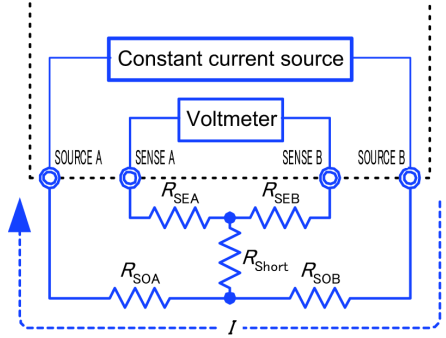
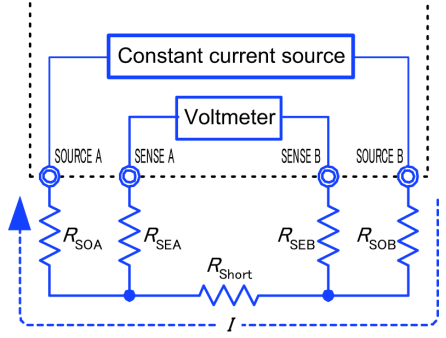
<p>Connection method</p>	 <p>If connection is made using Z5038 0 ADJ Board</p>	 <p>If connection is made using metal board or similar object</p>
<p>Tip of lead</p>		
<p>Equivalent circuit</p>		
<p>Deformed equivalent circuit</p>		
<p>As connection method for zero adjustment</p>	<p>Correct</p>	<p>Incorrect</p>

If zero adjustment is difficult when using self-made measurement lead to measure

When you perform zero adjustment using a self-made measurement lead to do measurement, connect the tip of the self-made measurement lead as shown in Table 1 (a). However, if such connection is difficult, you can try the following methods.

If DC resistance meter is used

The main purpose of performing zero adjustment is to remove offset of the measurement instrument. For this reason, the value to be deducted as a result of zero adjustment almost does not depend on the measurement lead. Therefore, after using the standard measurement lead to make the connection shown in Table 1 (a) and performing zero adjustment, you can replace it with a self-made measurement lead to measure with offset removed from the measurement instrument.

If AC resistance meter is used (Hioki 3561, BT3562, BT3563, etc.)

In addition to removing offset of the measurement instrument, another main purpose of performing zero adjustment is to remove influence of the measurement lead shape. For this reason, when performing zero adjustment, try as much as possible to set the form of the self-made measurement lead close to the actual measurement state. Then, you need to make the connection as shown in Table 1 (a) and perform zero adjustment.

However, if a Hioki product is used, even in AC resistance measurement, if the required resolution exceeds $100 \mu\Omega$, the same zero adjustment method used in DC resistance meter may be sufficient.

14.7 Unstable Measured Values

If the measured value is unstable, verify the following.

(1) Non-four-terminal measurements

The four-terminal method requires that four probes be connected to the measurement target.

By measuring as shown in Fig.1, the measured resistance includes that of the contacts between the probes and measurement target.

Typical contact resistance is several milliohm with gold plating, and several tens of milliohm with nickel plating.

With measured values of several $k\Omega$ this would not seem to be a problem, but if a probe tip is oxidized or dirty, contact resistance on the order of a $k\Omega$ is not unusual.

To maximize the opportunity for accurate measurement, separate the four probes so that they make contact with the measurement target as shown in Fig. 2.

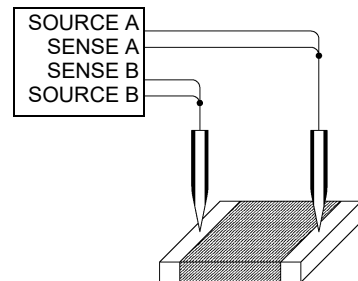

Fig. 1. Two-terminal measurement

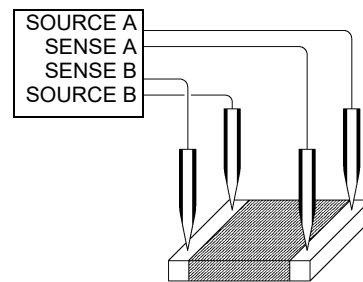

Fig. 2. Four-terminal measurement

(2) Effects of external noise

Measured values may exhibit instability due to noise entering the measurement target or noise from measurement cables, power cables, signal lines, or other wiring. In addition, if the GUARD line is not connected, the measurement error detection function may be triggered (this is rare). Noise can be classified into the following two categories:

- Inductive noise from high-voltage or high-current circuits
- Conductive noise from power lines or other sources

Solutions vary with the source of the noise.

For more information, see "14.9 Mitigating Noise" (p.338).

(3) Multi-point contacts with clip leads

The ideal conditions for four-terminal measurements are shown in Fig. 3: current flows from the far probe and voltage is detected with uniform current distribution.

SOURCE B, (SOURCE A) (current generation)

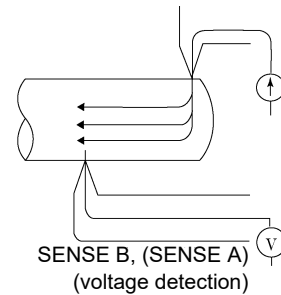

Fig. 3. Ideal four-terminal method

To facilitate measurement, the tips of the Hioki L2101 Clip Type Lead are jagged. When a clip is opened as shown in Fig. 4, measurement current flows from multiple points, and voltage is detected at multiple points. In such cases, the measured value varies according to the total contact area.

SOURCE B, (SOURCE A) (current generation)

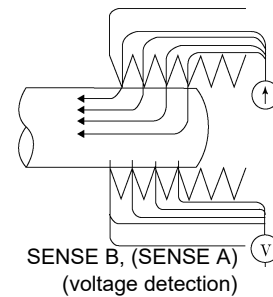

Fig. 4. Measurement with L2101 Clip Type Lead

Additionally, as shown in Fig. 5, when measuring the resistance of a 100 mm length of wire, the length between the nearest edges of the clips is 100 mm, but the length between the farthest edges of the clips is 110 mm, so the actual measurement length (and value) has an uncertainty of 10 mm (10%). If measured values are unstable for any of these reasons, maximize stability by measuring with point contacts as far as possible.

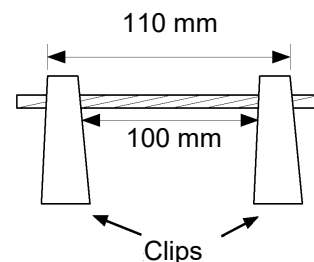

Fig. 5. Measuring the resistance of a 100 mm length of wire

(4) Wider/Thicker measurement targets

When the measurement target is wide or thick like a board or block, or when using a current sensing resistor (shunt resistor) of less than 100 mΩ, it will be difficult to measure accurately using Pin Type Leads or Clip Type Leads. By using such measurement probes, there may be considerable fluctuation of the measured value due to contact pressure or contact angle.

For example, when measuring a W300 × L370 × t0.4 mm metal board, the measured values are fairly different, even if measuring the same points, as shown below:

- 0.2 mm pitch pin type lead: 1.1 mΩ
- 0.5 mm pitch pin type lead: 0.92 mΩ to 0.97 mΩ
- L2101 Clip Type Lead: 0.85 mΩ to 0.95 mΩ

Additionally, since the resistance values of current sensing resistors assume mounting on a printed circuit board, the desired resistance value cannot be obtained if the resistor's terminals are measured using a pin-type lead.

This does not depend on the contact resistance between probes and the measurement target, but on the current distribution on the measurement target.

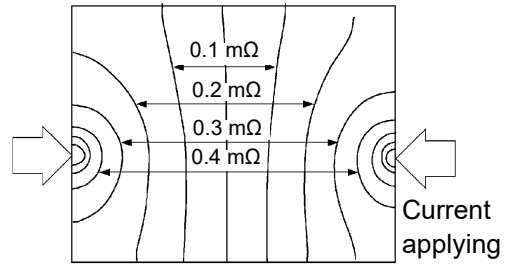

Fig. 6. Equipotential lines on a metal board (W300 mm × L370 mm × t0.4 mm) Applying 1 A current on points on edges and plotting equivalent electric potential lines at each 50 μV level

Fig. 6 is an example of plotting equivalent electric potential lines of a metal board. Similar to the relation between atmospheric pressure distribution and wind on a weather forecast diagram, current density is higher in locations where the equivalent electric potential lines are narrowly spaced, and lower in locations where they are widely spaced. Through this example, it is shown that the electric potential slope is larger around current applying points. This phenomenon is caused by high current density while current expands on the metal board. Due to this phenomenon, measured values should be rather different, even if the connected position difference is quite slight, in case connecting voltage detection terminals (of measurement probes) near current applying points.

It is known that such effects can be minimized by detecting the voltage within the space between the current contact points. Generally, if the probes are inside by a margin that is at least three times the measurement target's width (W) or thickness (t), current distribution may be considered uniform. As shown in Fig. 7, SENSE leads should be 3W or 3t mm or more inside from the SOURCE leads.

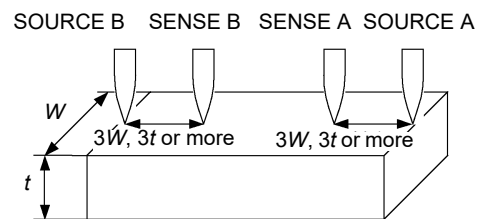

Fig. 7. Probe positions on wider/thicker measurement target

(5) Unstable temperature of the measurement target

Copper wire resistance has a temperature coefficient of about 0.4%/°C. Just holding a copper wire in the hand raises its temperature, causing its resistance to be increased as well. When the hand is removed from the wire, temperature and resistance decrease. Windings are more susceptible to temperature increase immediately after treatment with varnish, so the resistance tends to be relatively high.

When the temperature of the measurement target and probe differ, thermal EMFs will be generated, causing an error.

Allow the measurement target to adjust to room temperature as much as possible prior to measurement.

(6) Measurement target becomes warm

The maximum applied power to a measurement target by this instrument is determined as follows.

The resistance of samples with small thermal capacity can change due to heating. In such cases, enable the low-power mode.

- Low-power mode: Off

Measurement current setting	High		Low	
	Measurement current	Maximum power in measurement range	Measurement current	Maximum power in measurement range
1000 $\mu\Omega$	1 A	1.2 mW	–	
10 m Ω	1 A	12 mW	–	
100 m Ω	1 A	120 mW	100 mA	1.2 mW
1000 m Ω	100 mA	12 mW	10 mA	120 μ W
10 Ω	10 mA	1.2 mW	1 mA	12 μ W
100 Ω	10 mA	12 mW	1 mA	120 μ W
1000 Ω	1 mA	1.2 mW	–	
10 k Ω	1 mA	12 mW	–	
100 k Ω	100 μ A	1.2 mW	–	
1000 k Ω	10 μ A	120 μ W	–	
10 M Ω	1 μ A	12 μ W	–	
100 M Ω (high-precision mode: On)	100 nA	1.2 μ W	–	
100 M Ω , 1000 M Ω (high-precision mode: Off)	1 μ A or less	1.3 μ W	–	

- Low-power mode: On

Range	Measurement current	Maximum Applied Power Maximum power in measurement range
1000 m Ω	1 mA	1.2 μ W
10 Ω	500 μ A	3 μ W
100 Ω	50 μ A	0.3 μ W
1000 Ω	5 μ A	0.03 μ W

(7) The measurement is affected by thermal EMF

When there is a junction between different metals and a temperature difference between the junction and the area being observed, thermal EMF occurs. In light of use of copper measurement leads, nickel-plated connectors, and solder containing tin, it is not practical to ensure that only the same metals are used in connections. For more information about how to deal with errors caused by thermal EMF, see “14.10 Effect of Thermal EMF” (p.342).

(8) Using low-power mode

The low-power mode employs a smaller measurement current than normal resistance measurements. Therefore, measurements are more susceptible to the effects of external electrical noise and thermal EMF.

Measurement should be conducted as far as possible from devices emitting electric or magnetic fields such as power cords, fluorescent lights, solenoid valves and PC displays. If electrical noise ingress is a problem, see “14.9 Mitigating Noise” (p.338).

If thermal EMF is a problem, use the RM3545's offset voltage compensation (OVC) function. If the offset voltage compensation (OVC) function cannot be used for reasons such as tact time limitations, use a low-thermal EMF material such as copper for wiring, and protect against airflow on connecting parts (measurement target or connectors).

(9) Measuring transformers and motors

If noise enters an unconnected terminal of a transformer or if motor rotor moves, measurements may vary due to induced voltage on the measured winding.

The effects of noise can be reduced by shorting transformers' empty terminals.

Exercise care not to induce motor oscillation.

(10) Measuring large transformers

When measuring measurement targets with a large inductance component and a high Q value, such as large transformers, measured values may vary. The RM3545 depends on constant current flow through the measurement target. To obtain stability in a constant-current source with a large inductance, response time is sacrificed. If you find that resistance values are scattered when measuring large transformers, please consider the above or contact your local Hioki distributor for further assistance.

(11) Effects of cable configuration

To cancel thermal EMF, the RM3545A periodically reverses the polarity of the measurement current (via the OVC function).

Additionally, it only applies the current during measurement to limit heat generation. Rapid fluctuations in this measurement current trigger corresponding fluctuations in the magnetic field, inducing voltage in the voltage detection line between SENSE A and SENSE B as shown in the calculation formula below:

$$v = \frac{d\phi}{dt} = \frac{d}{dt} \left(\mu \frac{I}{l} \right) = \frac{\mu}{l} \cdot \frac{dI}{dt}$$

To avoid the effects of this voltage, the instrument waits for a fixed period of time after the measurement current changes before acquiring the voltage between SENSE A and SENSE B.

It is necessary to exercise caution when there are metallic objects present near the measurement cable or measurement target. When the measurement current fluctuates, an eddy current will be induced in such objects (see Fig. 8). This induced current is characterized by a sawtooth-shaped waveform and affects the voltage detection line between SENSE A and SENSE B for an extended period of time (see Fig. 9-b). The eddy current gradually decays due to the resistance of the metal plate, so its effect is more pronounced the faster the measurement speed.

The following five methods may be used to counteract this issue:

1. Move the metallic object farther away.
2. Twist the SENSE A and SENSE B lines together.
Doing so will make the lines more resistant to the effects of the eddy current.
3. Twist the SOURCE A and SOURCE B lines together.
Doing so will inhibit the generation of an eddy current.
4. Increase the delay setting.
Doing so will delay the start of measurement until the eddy current has dissipated.
5. Reduce the measurement speed.
Averaging data from the start of measurement, when the effects of the eddy current are more pronounced, can reduce those effects.

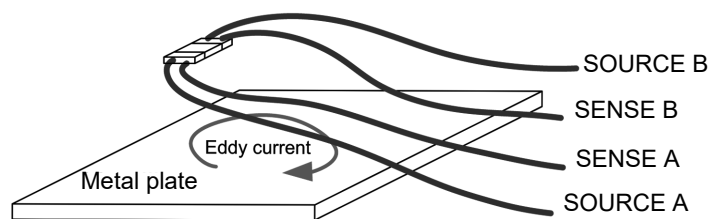

Fig. 8. Generation of an eddy current

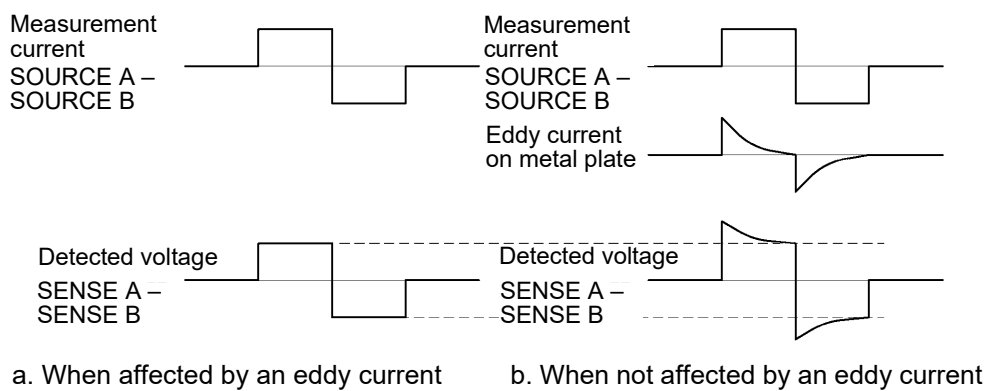

Fig. 9. Variations in the detected voltage due to eddy currents

(12) Measurement of current sensing resistors (shunt resistors)

When mounting a two-terminal type current sensing resistor on a printed circuit board, separate the current and voltage detection wires as shown in Fig. 10 in order to avoid the effects of route resistance. To ensure that the current will flow evenly to the sensing resistor, it is necessary to use the same width for the current wire as the electrode and to avoid bending the wire near the electrode (see Fig. 11). When testing the current sensing resistor, wire probes are generally used (see Fig. 12). In this case, the measurement current will gradually expand inside the current sensing resistor from the point of application (SOURCE B) and flow back again to the probe point (SOURCE A) (see Fig. 13). Current density is high at the current application points (SOURCE A, SOURCE B), and placing the voltage terminals (SENSE A, SENSE B) near them will yield resistance values that tend to be higher than the actual mounted value (see Fig. 14).

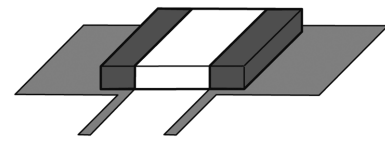

Fig. 10. Current sensing resistor mounted on a printed circuit board

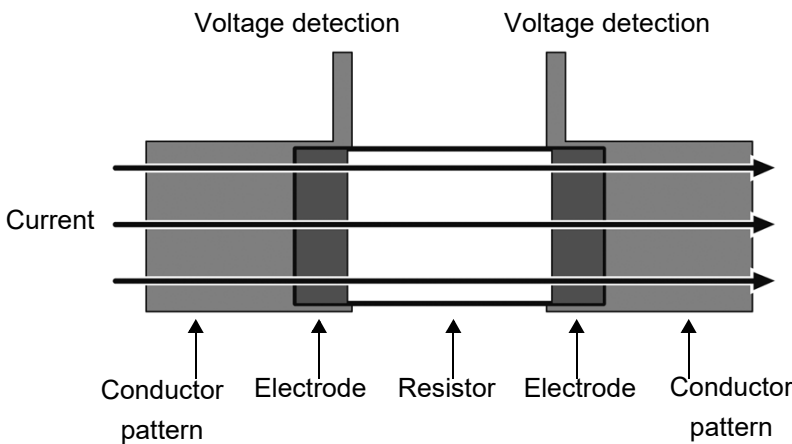

Fig. 11. Current flow in the mounted state

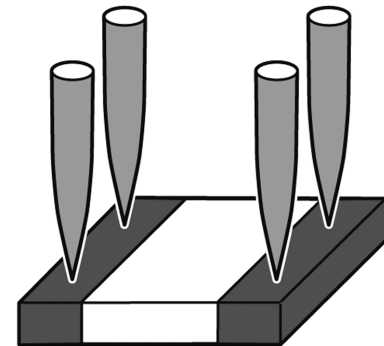

Fig. 12. Probing in the test state

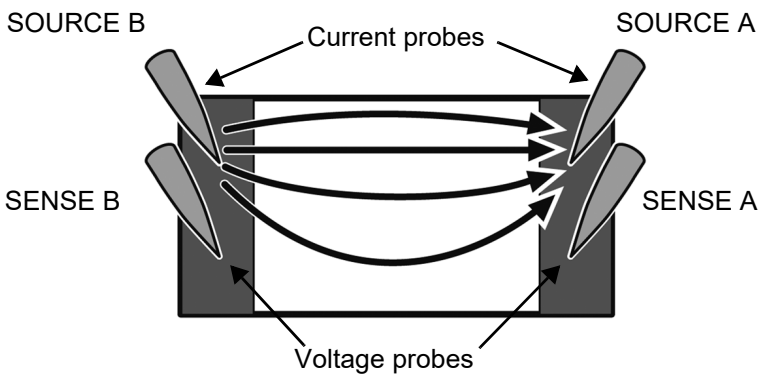

Fig. 13. Flow of current in the test state

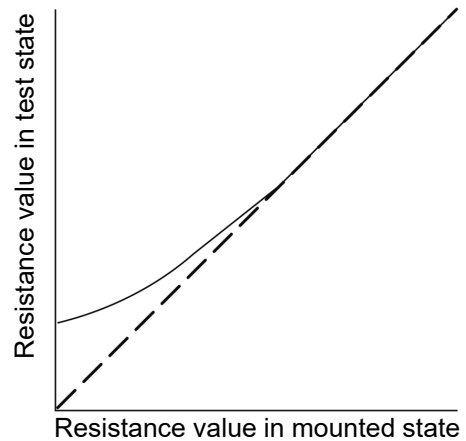

Fig. 14. Difference between mounted state and test state

14.8 Using Multiple Units of the Instrument

This section describes how to measure multiple locations such as rotary switches using multiple units of the instrument to which two measurement targets are connected.

This instrument measures resistance by applying a constant current to the measurement target. However, when multiple probes are placed in contact with a single point, the measurement current from one unit could be superposed with the measurement current from the other unit of instrument, preventing accurate measurement.

For example, if measuring two resistance values using two units of the instrument as shown in the figure to the right, current I1 will flow to R1, and current I2 will flow to R2. However, a minuscule current may also flow from one unit to the other, preventing accurate measurement.

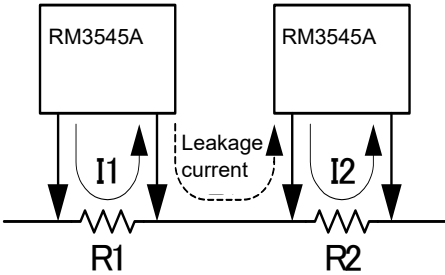

As shown in the figure below, the measurement currents from the two instruments will flow in common relative to the 10 mΩ resistance, resulting in an error.

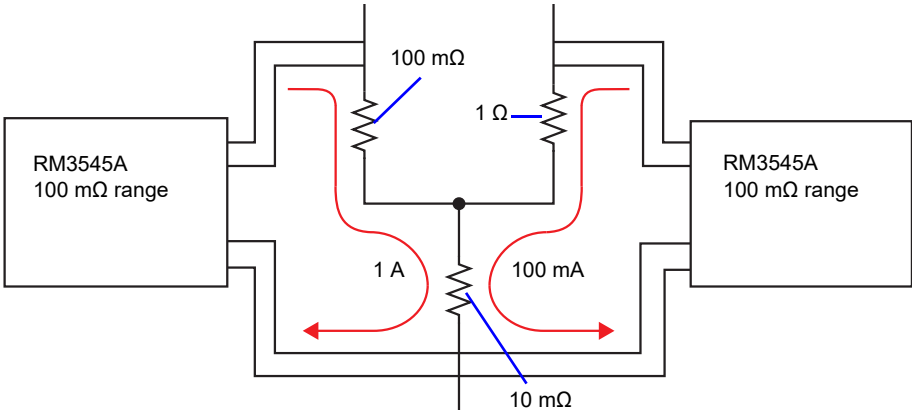

In this case, the unit on the left will measure the following resistance value:

$$\frac{(100 \text{ m}\Omega \times 1 \text{ A} + 10 \text{ m}\Omega \times 1.1 \text{ A})}{1 \text{ A}} = 111 \text{ m}\Omega$$

In this case, the unit on the right will measure the following resistance value:

$$\frac{(1 \text{ }\Omega \times 100 \text{ mA} + 10 \text{ m}\Omega \times 1100 \text{ mA})}{100 \text{ mA}} = 1.11 \text{ }\Omega$$

14.9 Mitigating Noise

(1) Effects of induced noise

Power cords, fluorescent lights, solenoid valves, PC displays, and other devices emit large amounts of noise. Two sources of noise with the potential to affect resistance measurement are:

1. Electromagnetic coupling between a high-voltage line and a measurement lead
2. Magnetic coupling between a high-current line and a measurement lead

Capacitive coupling from high-voltage lines

Current flowing from a high-voltage line is dominated by the coupled capacitance.

As an example, if a 100 V commercial power line and a wire used in resistance measurement are subject to capacitive coupling of 1 pF, a current of about 38 nA will be induced.

$$I = \frac{V}{Z} = 2\pi \cdot 60 \cdot 1 \text{ pF} \cdot 100 \text{ V rms} = 38 \text{ nA rms}$$

If a 1 Ω resistor is measured with a measurement current of 100 mA, the effect reaches to only 0.4 ppm of the measured value and may be ignored.

If a resistance of 1 M Ω is measured with a measurement current of 10 μ A, the effect is only 0.38% to the measured value. For high resistance measurement, care against electrostatic coupling between a high-voltage line and a measurement lead should be exercised. Shielding measurement leads and objects to be measured electrostatically is effective (see Fig. 1).

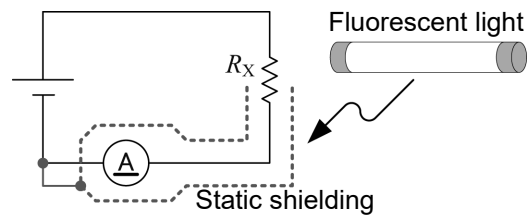

Fig. 1. Static shielding near high-voltage wires

Electromagnetic coupling from high-current lines

High-current lines emit a magnetic field. Transformers and choke coils with a large number of turns emit an even stronger magnetic field. The voltage induced by the magnetic field is affected by the distance and area. A loop of 10 cm² located 10 cm from a 1 A commercial power line will generate a voltage of about 0.75 μ V.

$$v = \frac{d\phi}{dt} = \frac{d}{dt} \left(\frac{\mu_0 I S}{2\pi r} \right) = \frac{4\pi \cdot 10^{-7} f I S}{r} = \frac{4\pi \cdot 10^{-7} \cdot 60 \text{ Hz} \cdot 0.001 \text{ m}^2 \cdot 1 \text{ A rms}}{0.1 \text{ m}} = 0.75 \mu\text{V rms}$$

When measuring a 1 m Ω resistor with 1 A, the effect measures 0.07%. Since the detection voltage can easily be increased for high-resistance measurement, this effect does not pose a significant problem.

The influence of electromagnetic coupling can be reduced by keeping the noise generating line away from the voltage detection line and twisting the cables for each (see Fig. 2).

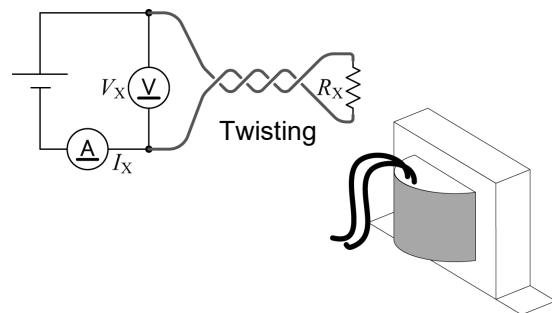

Fig. 2. Twisting near high-current wires

Induced noise countermeasures at the instrument

To counteract noise, it is effective to attach a ferrite core to the measurement leads, as shown in Fig. 3-1, or to twist the four shielded wires and to shield the measurement target with the GUARD potential, as shown in Fig. 3-2.

It is important to take similar precautions not only for the instrument, but also for the noise source. It is effective to twist nearby high-current wires that may serve as noise sources and to shield high-voltage wires.

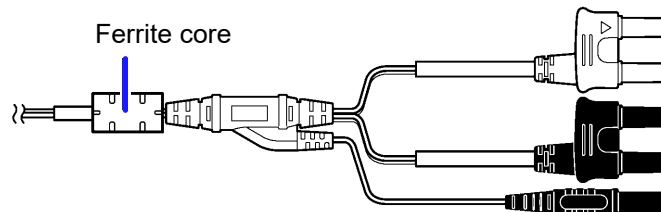

Fig. 3-1. Noise countermeasures at the measurement lead

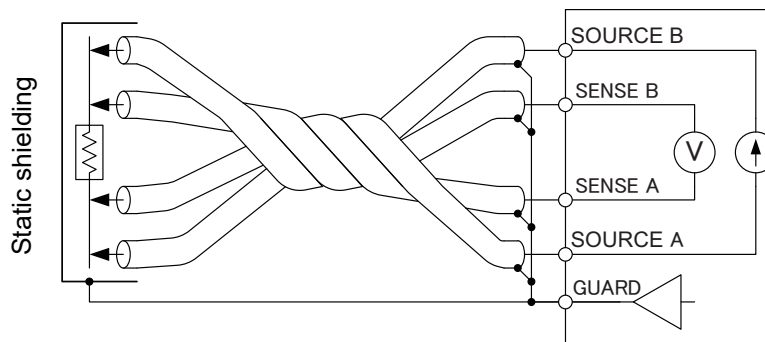

Fig. 3-2. Noise countermeasures at the instrument

When induced noise is caused by a commercial power supply

Induced noise caused by commercial power supplies is emitted not only by commercial power lines and power outlets, but also from fluorescent lights and household electronics. Noise caused by commercial power supplies occurs at frequencies of 50 Hz and 60 Hz, depending on the frequency of the power supply in use. To mitigate the effects of noise caused by commercial power supplies, it is standard practice to use a whole-number multiple of the power supply period as the integration time (see Fig. 4).

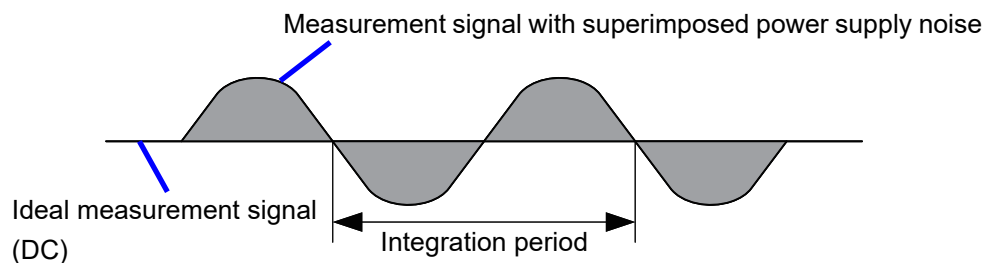

Fig. 4. Noise caused by a commercial power supply

The instrument offers four measurement speeds: FAST, MED, SLOW1, and SLOW2. Measured values may fail to stabilize during either high-resistance or low-resistance measurement. If this occurs, either decrease the measurement speed or implement adequate noise countermeasures.

If the line frequency setting is left at 60 Hz while the instrument is used in a region with a 50 Hz line frequency, measured values will vary, even if the measurement speed is set such that the integration time is equal to the integral multiple of the line frequency. Check the instrument's line frequency setting.

(2) Effects of conductive noise

Conductive noise is distinct from induced noise, which is superimposed on measurement targets and measurement leads. Conductive noise is noise that is superimposed on power lines and control lines such as USB.

A variety of devices, including motors, welders, and inverters, can be connected to power supply lines. A large spike current flows to the power supply while this equipment is operating and each time it starts and stops. Due to this spike current and the power supply line's wiring impedance, a large spike voltage occurs in the power supply line and the power supply ground line, and these spikes may affect measuring instruments. Similarly, noise may be introduced from the controller's control lines. Noise from the controller's power supply and noise from sources such as DC-DC converters in the controller may reach measuring instruments via USB and EXT. I/O wires (see Fig. 5).

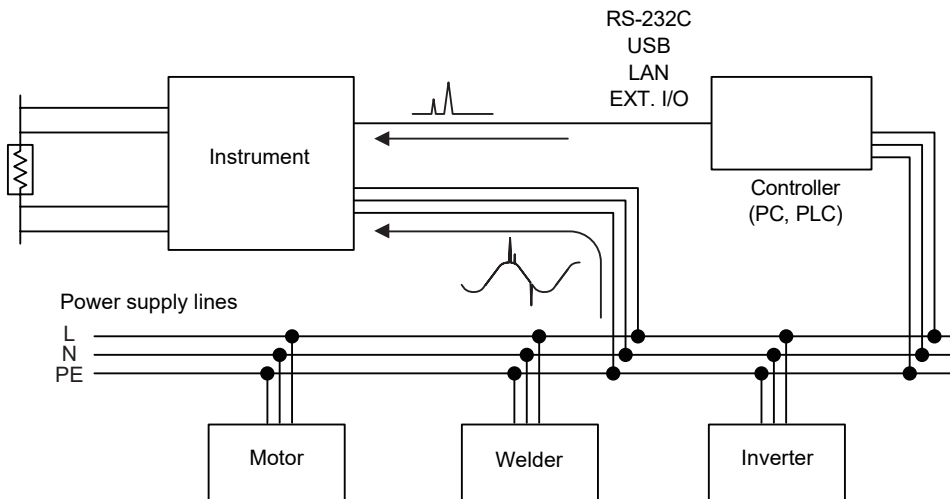

Fig. 5. Susceptibility to conductive noise

Once the path along which the conductive noise is traveling has been identified, the countermeasures show in Fig. 6 are effective.

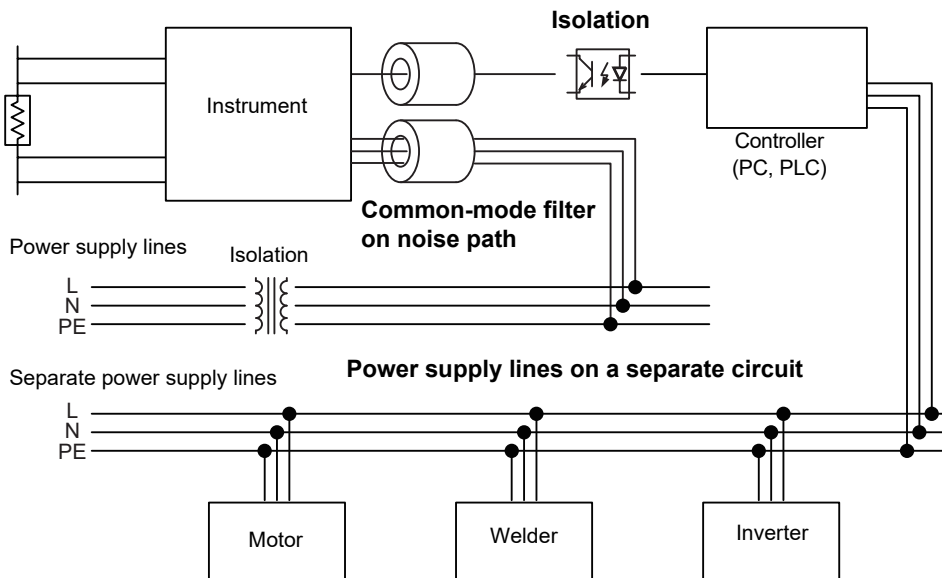

Fig. 6. Conductive noise countermeasures

Using separate power supply lines

It is preferable to place power circuits, welders, and other equipment on a separate power supply from the instrument.

Adding a common-mode filter (EMI choke) to the noise path

Choose common mode filters with as high an impedance as possible and use multiple filters for increased effectiveness.

Isolating lines

It is highly effective to optically isolate control lines.

It is also effective to isolate power supply lines using a noise-cutting transformer. However, note that shared ground lines before or after the isolation can make this approach less effective.

14.10 Effect of Thermal EMF

Thermoelectromotive force (thermal EMF) is the potential difference that occurs at the junction of two dissimilar metals, including between the probe tips and the lead wire of the measurement target. If the difference is sufficiently large, it can cause erroneous measurements (see Fig. 1). The amplitude of thermal EMF depends on the temperature of the measurement environment, with the force generally being greater at higher temperature.

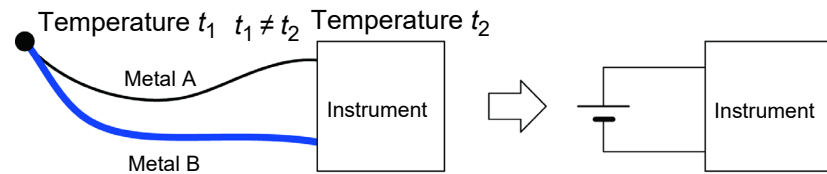

Fig. 1. Thermal EMF generation

Increasing thermal EMF examples

- The measurement target is a fuse, thermal fuse, thermistor, bimetal, or thermostat.
- The voltage detection lines incorporate a single stable relay as a contact.
- An alligator clip is used as a voltage detection terminal.
- A voltage detection terminal is held by hand.
- There is a large temperature difference between the measurement target and the instrument.
- Wire materials differ between the SENSE A and SENSE B.

In a resistance measurement, measurement current I_M is applied to measurement target R_X to detect voltage drop $R_X I_M$ across the target. In a low resistance measurement, the voltage $R_X I_M$ to be detected is naturally lower due to the low R_X . When the detected voltage is low, the measurement is affected by thermal EMF that is generated between the measurement target and probes, and between the cables and the instrument, as well as the voltmeter offset voltage V_{EMF} (Fig. 2).

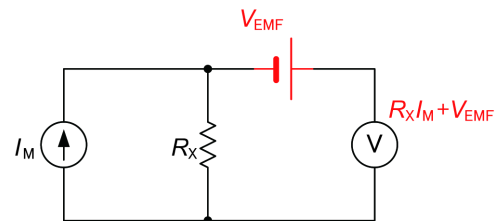

Fig. 2. Thermal EMF generation

If a measurement target is held by hand, the target will be warmed. A probe will also be warmed by holding it by hand. In such cases, even if every care is taken, it will be difficult to control thermal EMF so that it does not exceed 1 μV .

For example, if a measurement target with an actual resistance of 1 $\text{m}\Omega$ is measured with a measurement current of 1 A in an environment with an thermal EMF of 10 μV , the measured value will be obtained as follows.

$$\frac{1 \text{ m}\Omega \times 1 \text{ A} + 10 \text{ }\mu\text{V}}{1 \text{ A}} = 1.01 \text{ m}\Omega$$

This is a significant error of 1% higher than the actual resistance.

The voltmeter offset voltage will also be very large, ranging between 1 μV and 10 mV. This will cause a large low resistance measurement error.

To reduce the effects of thermal EMF, the following countermeasures are possible:

1. Increasing the detection voltage by increasing the measurement current
2. Using zero adjustment to cancel thermal EMF
3. Changing the detection signal to AC

1. Increasing the detection voltage by increasing the measurement current

In the above thermal EMF example, assume that the measurement current is increased from 1 A to 100 A. The error will be reduced to 0.01%.

$$\frac{1 \text{ m}\Omega \times 100 \text{ A} + 10 \text{ }\mu\text{V}}{100 \text{ A}} = 1.0001 \text{ m}\Omega$$

However, it is important to note that $R I^2$ power is applied.

2. Using zero adjustment to cancel thermal EMF

If current is blocked from being applied to measurement target R_X , the voltmeter will only be supplied with thermal EMF V_{EMF} . However, if the SOURCE terminals are made open-circuit, a current fault will be detected and a measured value will not be displayed. Thus, thermal EMF can be canceled by shorting the SOURCE lines to block current flow to R_X and performing zero adjustment. (Fig. 3).

See: "3.5 Checking Measured Values" (p.53)

See: "14.6 About Zero Adjustment" (p.325)

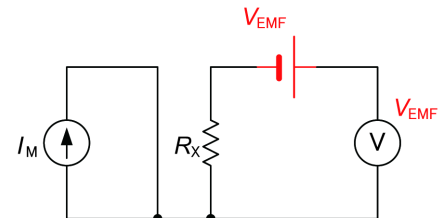

Fig. 3. Using zero adjustment to block current flow to R_X

3. Changing the detection signal to AC

Changing the detection signal to AC is a fundamental solution. Both the thermal EMF and voltmeter offset voltage can be treated as stable DC voltages as they are viewed for a short period of time in seconds. This allows frequency domain separation by changing the detection signal to AC. The Offset Voltage Compensation (OVC) function uses a pulse wave as a measurement current to eliminate thermal EMF (Fig. 4).

Specifically, a resistance value that is not affected by thermal EMF is obtained by subtracting the voltage detected when the measurement current is applied in the negative direction from that detected when the current is applied in the positive direction.

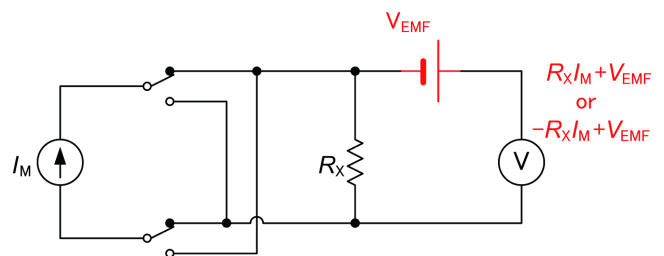

Fig. 4. EMF cancellation by current reversal

$$\frac{(R_X I_M + V_{EMF}) - (-R_X I_M + V_{EMF})}{2I_M} = R_X$$

When the measurement target is inductive, some delay must be set (p.86) to allow adequate current flow before starting measurement.

Set the delay so that inductance does not affect measurements. To fine tune the delay, begin with a longer delay than necessary, then gradually shorten it while watching the measured value.

14.11 Detecting the Location of a Short on a Printed Circuit Board

Comparing the resistance values at multiple locations provides a useful way to infer the location of a short on an unpopulated printed circuit board.

Short patterns X and Y as described below:

- 1** Connect SOURCE A and SOURCE B to their respective patterns.
- 2** Connect SENSE A to a point near SOURCE A, and SENSE B to location (1).
- 3** Observe the measured values as you move SENSE B from (1) to (2), (3), and (4). Higher resistance values indicate greater distance from the short location. By moving the SOURCE B and SENSE B terminals, narrow down the short location.

Example

- (1) 20 mΩ
- (2) 11 mΩ
- (3) 10 mΩ
- (4) 10 mΩ

Based on the above measured values, the short can be inferred to be near (3).

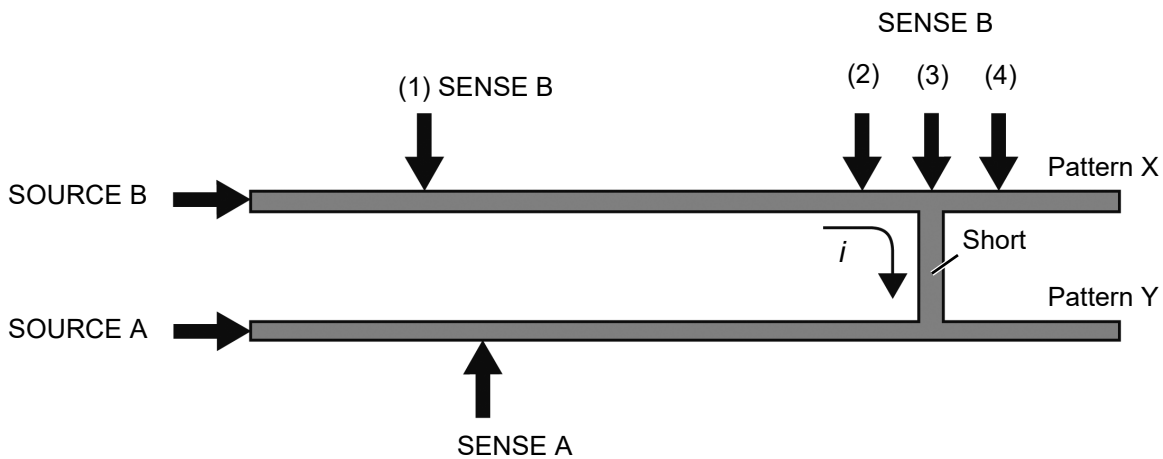

14.12 Measuring Contact Resistance

(1) Types of contacts

Switches, relays, and connector contacts can be broadly classified as either of two types:

- Power contacts
- Signal contacts

- Power contacts

Lines carrying currents of several dozens of amperes consume power measured in watts, even if they have a resistance of 1 m Ω . Consequently, switch contacts on high-current lines such as circuit breakers have resistance values that are far below 1 m Ω . Power relays, circuit breakers, and other components are designed based on the assumption that they will be used with high-current lines. Consequently, use of low currents (on the order of microamperes) requires caution since gradual corrosion of the contacts will eventually compromise their conductivity.

- Signal contacts

Since switches and connectors used in standard electronic circuits typically carry currents of 1 A or less, their contact resistance is on the order of several dozens of milliohms. These contacts are usually gold-plated so that stable contact can be achieved even with microampere-level currents.

Switches that use conductive rubber exhibit resistance values that vary dramatically with the pressure placed on them. They have a high contact resistance of around 1 k Ω , but they are characterized by an extremely high level of durability.

(2) Measuring contact resistance

- Power contacts

Unless otherwise defined, measurement can be accomplished at an adequate level of resolution by using a current of about 1 A. However, if there are local areas of high contact resistance, it is necessary to observe heat generation at the contact while using a current that approaches the conditions under which the contact will be used.

Power contacts are typically used at a relatively high voltage of at least 5 V. When measured with an ohmmeter with a low open voltage, the current may be unable to pass through contaminants (oxide film or dirt) on the contact that do not pose an issue during normal use, triggering a judgment of poor contact. For this reason, it is not desirable to measure power contacts with low-power ohmmeters.

- Signal contacts

Most signal contacts are connected to IC input terminals, and it is not unusual for them to carry currents of less than 1 μ A. Repeated opening and closing of contacts and vibration can cause the plating on contact surfaces to peel away, leading to rapid corrosion of contacts (oxidation and sulfurization).

When contacts become corroded so that their contact resistance increases, measurement at high currents such as 1 A may trigger a process by which the contact resistance gradually recovers. Measuring contacts with more advanced corrosion with an ohmmeter with a high open voltage may allow the current to pass through the corrosion, leading to a judgment of good contact.

For this reason, when measuring signal contacts, the open voltage should be limited to the extent possible, and measurement should be carried out using an extremely low current (dry-circuit testing). The instrument can be used to perform dry-circuit testing by enabling the low-power mode.

(3) Resistance in the open state

Generally, contacts have a resistance value of at least 10 MΩ when in the open state. The initial insulation resistance varies greatly with the insulating properties of the enclosure and tends to decline due to dirt on the contacts and nearby dust.

To ascertain the resistance in the open state, it is necessary to measure the resistance value with the maximum voltage that could be applied to the open contacts. Consequently, insulation resistance testers that are used to inspect power distribution equipment are designed so that they can apply high voltages ranging from 25 V to 5 kV.

(4) Standards related to contact resistance

Below is a list of some representative standards relating to the measurement of resistance. Please see individual standards for more information about their specific provisions.

JIS C 2525 Testing method for conductor-resistance and resistivity of metallic resistance materials

JIS C 3001 Resistance of copper materials for electrical purposes

JIS C 3002 Testing methods of electrical copper and aluminum wires

JIS C 3005 Test methods for rubber or plastic insulated wires and cables

JIS C 3101 Hard-drawn copper wires for electrical purposes

JIS C 3102 Annealed copper wires for electrical purposes

JIS C 3152 Tin coated annealed copper wires

JIS C 4034 Rotating electrical machines

JIS C 5012 Test methods for printed wiring boards

JIS C 5402 Connectors for electronic equipment

JIS C 5442 Test methods of low power electromagnetic relays for industrial control circuits

JIS C 8306 Testing methods for wiring devices

JIS H 0505 Measuring methods for electrical resistivity and conductivity of non-ferrous materials

JIS K 7194 Testing method for resistivity of conductive plastics with a four-point probe array

Reference URL: <https://www.jisc.go.jp/>

14.13 JEC 2137 Induction Machine-compliant Resistance Measurement

Standard JEC 2137 specifies the determination of resistance values according to the following formula:

$$R_{tR} = R_{tT} \times \frac{t_R + k}{t_T + k} \quad \dots\dots\dots \text{Formula 1}$$

R_{tR}	Winding resistance at reference temperature t_R
R_{tT}	Measured value of winding resistance at t_T
t_R	Reference temperature ($^{\circ}\text{C}$)
t_T	Temperature of winding during measurement ($^{\circ}\text{C}$)
k	Constant (235 for copper wire)

Transforming Formula 1 provides the following:

$$\frac{R_{tR}}{R_{tT}} = \frac{t_R + k}{t_T + k} = \frac{1}{1 + \frac{1}{t_R + k} (t_T - t_R)} \quad \dots\dots\dots \text{Formula 2}$$

On the other hand, Formula 3 shows the temperature correction process with this instrument.

So the temperature coefficient to be set is determined as shown in Formula 4.

$$R_{tR} = \frac{R_{tT}}{1 + \alpha_{tR} \times (t_T - t_R)} \quad \dots\dots\dots \text{Formula 3}$$

$$\alpha_{tR} = \frac{1}{t_R + k} \quad \dots\dots\dots \text{Formula 4}$$

For example, if the reference temperature is 20°C , set the temperature coefficient for the instrument as follows.

$$\alpha_{tR} = \frac{1}{t_R + k} = \frac{1}{20 + 235} = 3922 \text{ (ppm/}^{\circ}\text{C)}$$

14.14 Making Your Own Measurement Leads, Making Connections to the Multiplexer

Recommended Measurement Lead Specifications

Conductor resistance	500 mΩ/m or less
Capacitance	150 pF/m or less
Cable dielectric material	Polyethylene (PE), TEFLON* ¹ (TFE), polyethylene foam (PEF) Insulation resistance at least 100 GΩ (Performance value)

*1. Trademark of other company

Example: Hitachi Metals, Furukawa Electric, Sumitomo Electric Industries: UL1354, UL1631, UL1691

Before wiring

See: "14.7 Unstable Measured Values" (p.330)

- Use shielded wiring for measurement leads and connect the shield potential to the instrument's GUARD terminal. Use the GUARD potential to shield probes and near the measurement target. Twist the four wires together and keep loop area small.

Wiring diagram

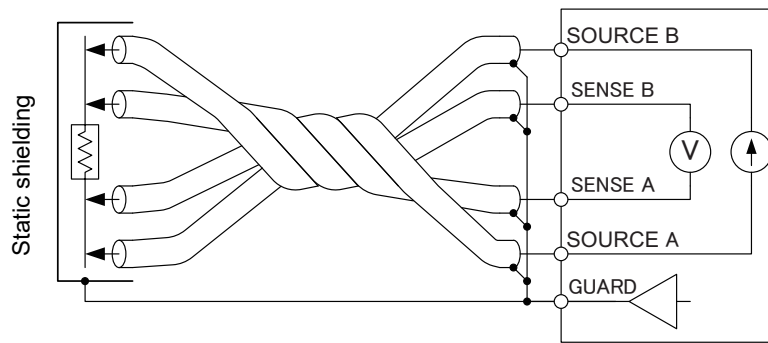

- Keep measurement leads and the measurement target away from high-current, high-voltage, and high-frequency wires (withstanding voltage testers, power cords, motors, solenoid valves).

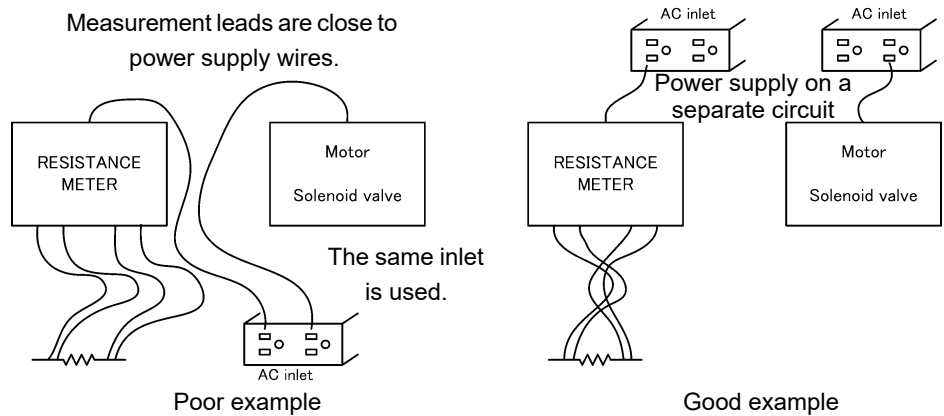

- The phenomenon of induction becomes pronounced in the 1000 μΩ, 10 mΩ, and 100 mΩ ranges (when the measurement current is set to 1 A). Variations in lead position or shape may cause measured values to vary. Exercise care to prevent positions and shapes from changing. Additionally, measurement leads and measurement targets should be kept as far as possible from metallic objects.
- When using two or more RM units, do not group the wires from multiple instruments together. Induction phenomena may cause measured values to become unstable or the contact check circuit to generate erroneous results.

- Refer to the block diagram (p.319) for internal circuit details.
- Route resistance in excess of the values listed in the table “Reference values for route resistance (wiring resistance + contact resistance) that will result in a current fault” (p.59) may cause a current fault, making measurement impossible. When using measurement current 1 A ranges, keep the route resistance low.
- Since the voltage detection circuit’s input resistance is sufficiently large, the SENSE route resistance can be as high as 1 k Ω without affecting measured values. However, the route resistance should be minimized due to susceptibility to noise. If an excessively high route resistance causes the contact check to generate an error, decrease the route resistance or disable the contact check function.
- Long wires are susceptible to noise, and measured values may be unstable.
- Extensions should maintain the four-terminal structure. If converted to a two-terminal circuit in the wiring, correct measurement may not be possible due to the effects of route resistance and contact resistance.

Example that would result in error:

Four-terminal wiring from the instrument to the relay, but two-terminal wiring from the relay.

- After extending measurement leads, confirm operation and accuracy (p.270).
- If cutting the ends off of Hioki measurement leads, make sure that the shield does not touch the center conductor of the SOURCE A, SENSE A, SENSE B, and SOURCE B leads. Correct measurement is not possible with a shorted lead.
- Do not connect the end of the shielding wire to a ground or other terminal. Doing so will create a ground loop, making the instrument more susceptible to noise. Keeping the shielding wire away from the center conductor, process the ends of the leads so that they do not come into contact with nearby metal objects.
- Do not apply a current of 1 mA or more to the GUARD terminal.

This terminal is not for guarding network resistance measurements.

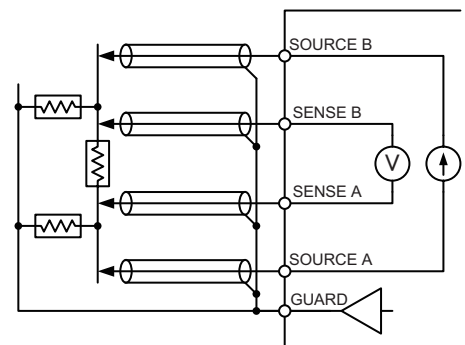
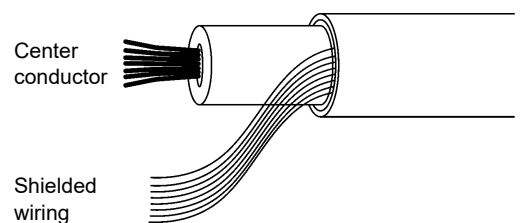

Example of defeated guard measurement

14.15 Checking Measurement Faults

The instrument monitors the connection status of SOURCE A, SOURCE B, SENSE A, and SENSE B. If you experience an unexpected measurement fault, check the following.

- 1 Disconnect the measurement lead plugs from the instrument while keeping the probes in contact with the measurement target.**

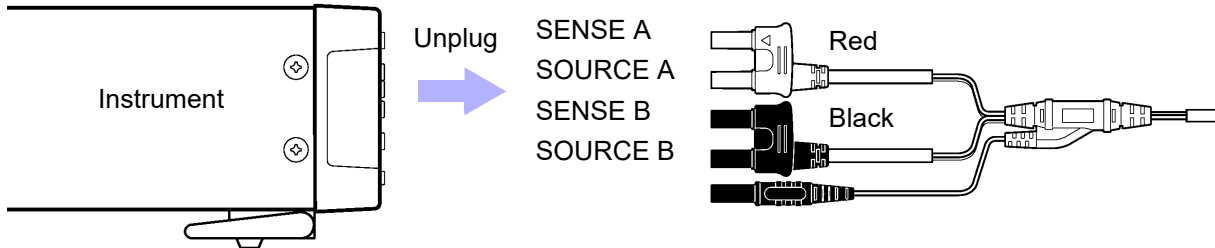

- 2 (1) Check the resistance between SOURCE A and SENSE A with a tester or other instrument.
(2) Check the resistance between SOURCE B and SENSE B with a tester or other instrument.
If good contact has been established, the resistance should be 1 Ω or less.**

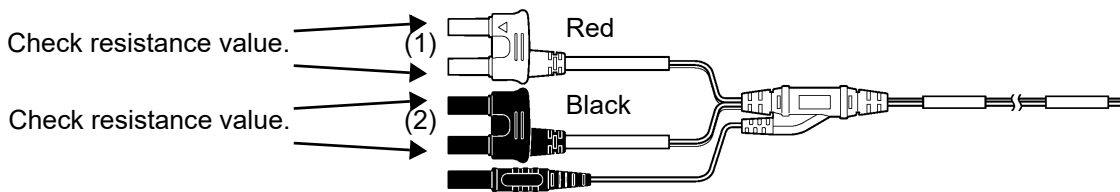

- 3 (3) Check the resistance between SOURCE A and SOURCE B with a tester or other instrument.
If good contact has been established, the resistance should be the sum of the measurement target resistance value and the route resistance.**

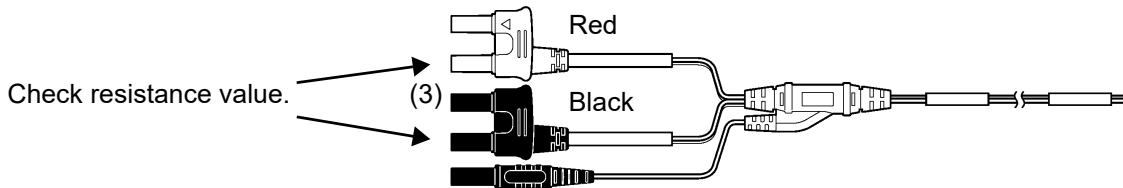

If the above resistance values are too high, check the following:

- Is the probe dirty or worn?
- Is the probe's contact pressure too low?
- Is a power relay being used to switch the wiring (in particular, the SENSE wiring)?
Use of power relay contacts without applying current will cause the contact resistance to increase gradually over time.
- Is the wiring too small?
Particularly if using a 1 A measurement current, keep the round-trip route resistance less than 3.0 Ω.
See: "Current fault detection function" (p.58)
- Is there a break in a measurement lead?
Switch the lead with another lead or jiggle the wiring and check the resistance value.

14.16 Using the Instrument with a Withstanding Voltage Tester

14

The instrument can also be used in conjunction with a withstanding voltage tester to test windings. When used with a withstanding voltage tester, the charge stored in the winding may flow into the instrument at the moment it is connected, damaging it.

When using the instrument in this manner, take the following into account during the production line design process:

- Ensure the contact withstanding voltage of the relays used for switching has a sufficient safety margin relative to the withstanding test voltage (at a minimum, it should be twice the peak voltage).

Example high-voltage relays

Okita Works	LRL-101-50PC (5 kV DC between contacts)
	LRL-101-100PC (10 kV DC between contacts)
Sanyu Switch	USM-11524 (5 kV DC between contacts)
	USM-13624SB (10 kV DC between contacts)

- During withstanding voltage testing, ground all of the instrument's terminals.
- Perform resistance measurement first and the withstanding voltage test last.

If you must perform the withstanding voltage test before resistance measurement, ground both of the measurement target's terminals after the withstanding voltage test to discharge any charge accumulated during the test. Then perform resistance measurement.

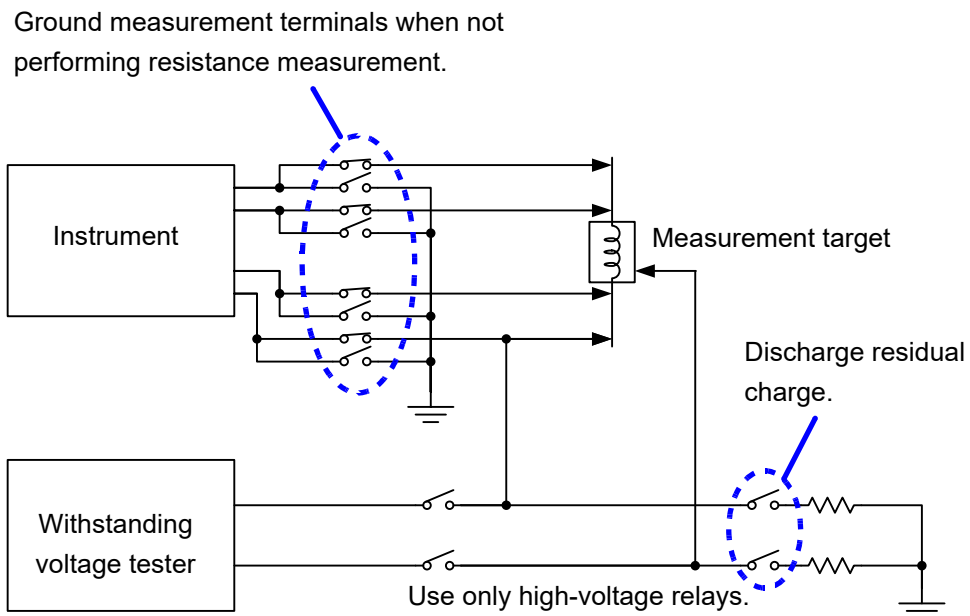

Using the instrument with a withstanding voltage tester

14.17 Measurement Leads (Options)

To purchase any of the options, contact your authorized Hioki distributor or reseller.

L2101 Clip Type Lead

These leads have clip tips. Four-terminal measurements are provided just by clipping on to the measurement target.

Overall length: Approx. 1500 mm

Bifurcation-to-lead length: Approx. 250 mm

Clippable diameter: $\varnothing 0.3$ mm to 5.0 mm

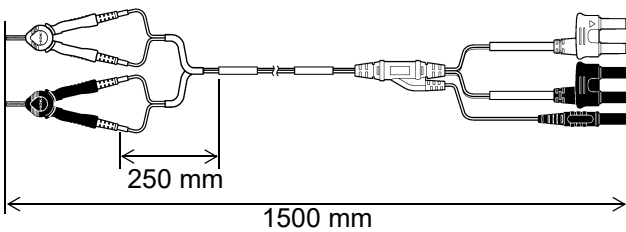

L2102 Pin Type Lead

Even on flat contact points that cannot be clipped to, or on measurement targets with small contacts such as relay terminals or connectors, four-terminal measurements are available by just pressing.

Overall length: Approx. 1500 mm

Bifurcation-to-lead length: Approx. 250 mm

Pin tip: $\varnothing 1.8$ mm

Initial contact pressure: Approx. 70 g

Total compression pressure: Approx. 100 g (Stroke: Approx. 2 mm)

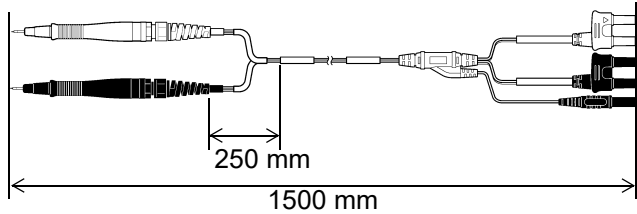

Tip pin*1

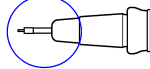

*1. Tip pins can be exchanged.
9770-90 Tip pin

L2103 Pin Type Lead

The tips have a four-terminal design developed for floating-foot testing of ICs mounted on boards.

Resistance can be correctly measured even with small measurement targets.

Overall length: Approx. 1500 mm

Bifurcation-to-lead length: Approx. 250 mm

Between pin bases: 0.2 mm

Initial contact pressure: Approx. 60 g

Total compression pressure: Approx. 140 g (Stroke: Approx. 1.3 mm)

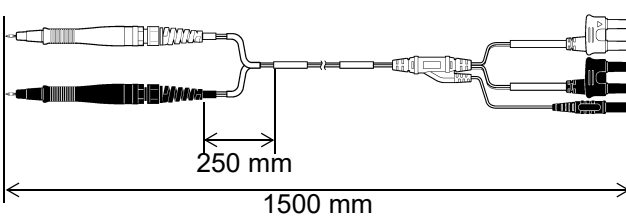

Tip pin*2

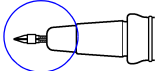

*2. Tip pins can be exchanged.
9770-90 Tip pin

L2104 4-Terminal Lead

The SOURCE leads of this four-terminal lead set have covered alligator clips, and the SENSE leads have standard test probes. Use for measuring printed circuit board pattern resistance, and where SOURCE and SENSE leads need to be connected separately.

Overall length: Approx. 1500 mm

Bifurcation-to-lead length: Approx. 280 mm

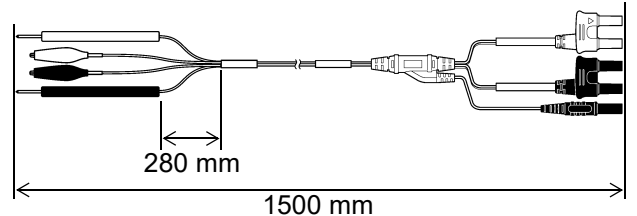

L2100 Pin Type Lead

These 4-terminal pin-type leads are ideal for measuring resistance at locations such as welds. The tips of the parallel two pin type enable stable contact for measurement.

Overall length: Approx. 1400 mm

Bifurcation-to-lead length: Approx. 300 mm

Between pin bases: 2.5 mm

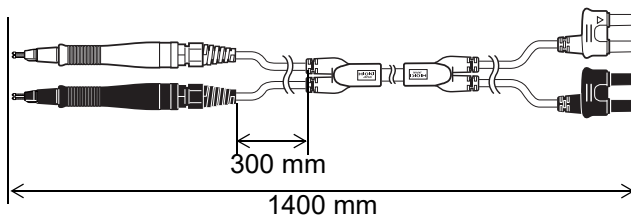

Tip pin*

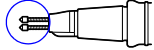

* Tip pins can be exchanged.

9771-90 Tip pin

14.18 Rack Mounting

By removing the screws on the sides or the bottom, this instrument can be installed in a rack mounting plate.



■ When installing the rack mounting plate on the sides or the bottom, do not allow the screws to intrude more than 3.5 mm inside the instrument.



Doing so could damage the instrument, causing the operator to experience an electric shock.

■ When installing the rack mounting plate on the instrument, use the specified screws.
(M4 × 8 mm)

■ When removing the rack mounting plate to return the instrument to stand-alone use, reuse the same screws that were installed originally.
(Feet: M3 × 6 mm, sides: M4 × 6 mm)

Fixing with other screws could cause damage to the instrument, resulting in bodily injury. If you lose or damage the screws, contact your authorized Hioki distributor or reseller.

Parts removed from this instrument should be stored in a safe place to enable future reuse.

Rack mounting plate template diagram (Unit: mm)

Rack mounting plate (EIA)

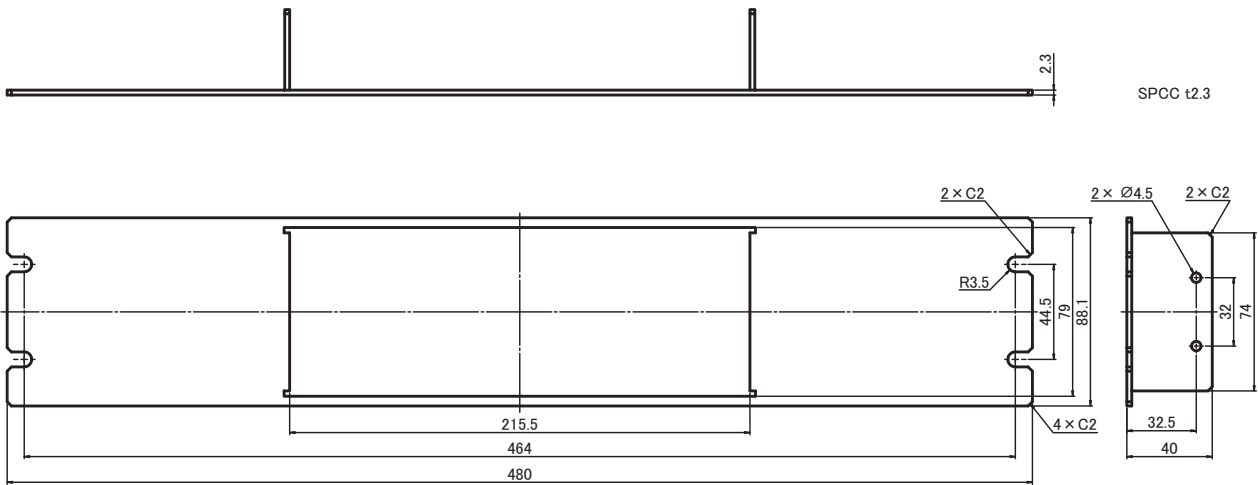

Rack mounting plate (JIS)

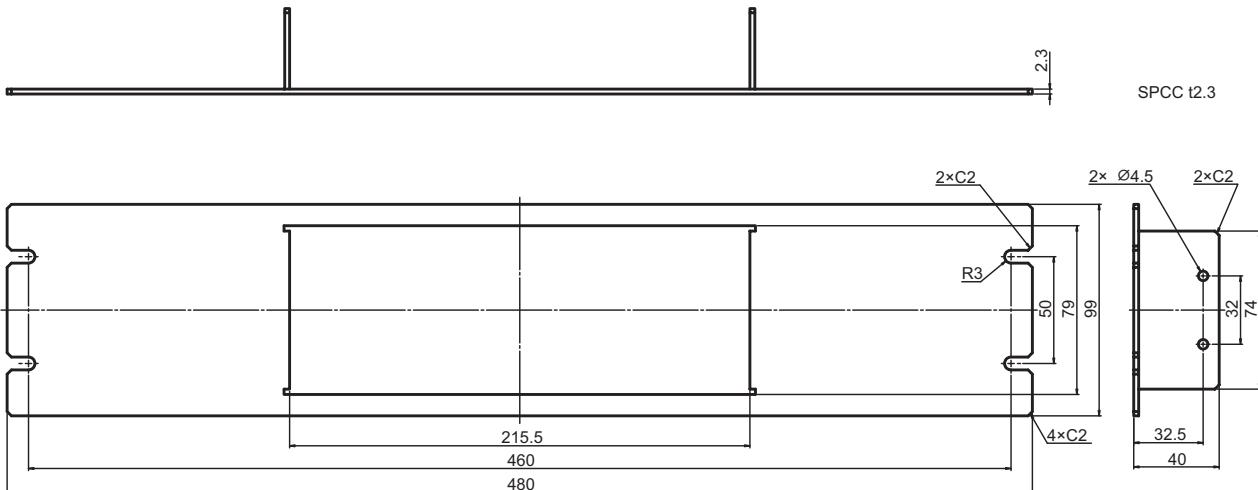

Spacer (two required)

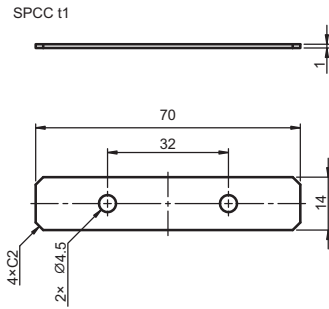

Rack mounting plate installation procedure

Required tools: Phillips screwdriver (No. 2), rack mounting plate (EIA or JIS), spacer × 2

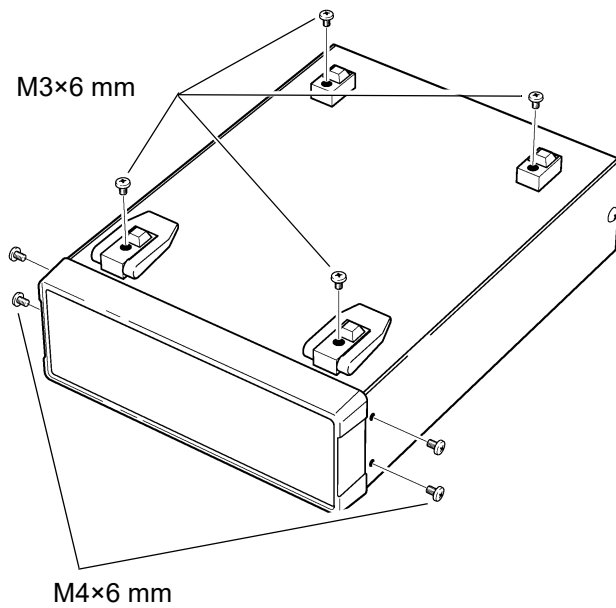

- 1** Place the instrument with its bottom side up, and remove the 8 screws from the feet and the sides.
- 2** Remove the feet from the instrument.

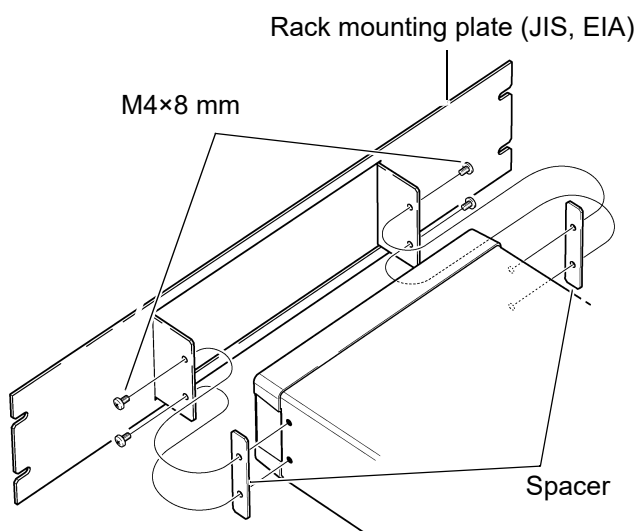

- 3** Install the spacers on both sides of the instrument, affix the rack mounting plate with four of the M4 × 8 mm screws.
Store the four remaining screws.

IMPORTANT
When installing the instrument into the rack, reinforce the installation with a commercially available support stand.

14.19 Outline Drawing

The figures show the RM3545A-2, but both models have the same dimensions.

Unit: mm

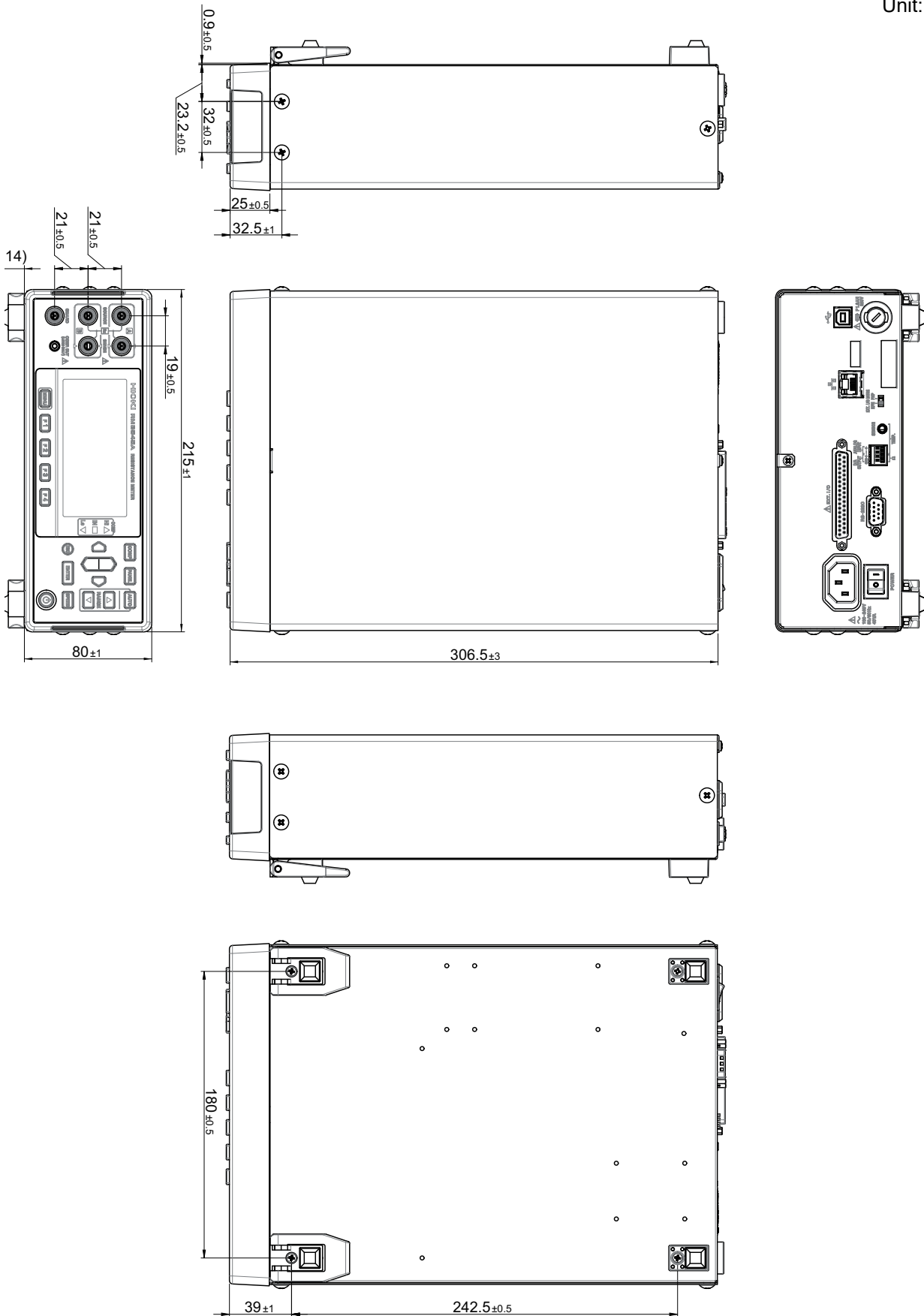

14.20 Calibrations

Calibration conditions

- Ambient temperature and humidity: 23°C ±5°C, 80% RH or less
- Warm-up time: 60 minutes
- Power source: 100 V to 240 V ±10%, 50 Hz/60 Hz, distortion rate of 5% or less
- External magnetic field: Environment close to the Earth's magnetic field
- Initialize settings by resetting the instrument.

Calibration equipment

Please use the following for calibration equipment.

Resistance measurement function

Equipment	Calibration point	Manufacturer	Standard model
Standard resistor	1 GΩ	Japan Finechem	RH1/2HV (1 GΩ)
Standard resistor	10 Ω to 100 MΩ	Fluke	Equivalent to 5700A
Standard resistor	1 Ω	Alpha Electronics	Equivalent to CSR-1R0
Standard resistor	100 mΩ	Alpha Electronics	Equivalent to CSR-R10
Standard resistor	10 mΩ	Alpha Electronics	Equivalent to CSR-10N
Standard resistor	1 mΩ	Alpha Electronics	Equivalent to CSR-1N0
Resistance measurement leads		Hioki	L2104 4-Terminal Lead

If the FLUKE 5700A cannot be used, please use the following equipment.

Alpha Electronics

- CSR-100 (10 Ω)
- CSR-101 (100 Ω)
- CSR-102 (1 kΩ)
- CSR-103 (10 kΩ)
- CSR-104 (100 kΩ)
- CSR-105 (1 MΩ)
- CSR-106 (10 MΩ)
- CSR-107 (100 MΩ)

Temperature measurement (Thermistor)

Equipment	Calibration point	Manufacturer	Standard model
Multi-product calibrator	25°C, 2186.0 Ω	Fluke	Equivalent to 5520A

Temperature (Analog input)

Equipment	Calibration point	Manufacturer	Standard model
Generator	10°C: 0.1 V 100°C: 1 V	Hioki	Equivalent to SS7012
Temperature measurement cable			Route resistance: 500 mΩ or less (round-trip)

D/A output

Equipment	Calibration point	Manufacturer	Standard model
Voltmeter	0 Ω : 0 V 1 Ω : 1 V	Hioki	Equivalent to DM7275 or DM7276
Output cable			Route resistance: 500 mΩ or less (round-trip)

Calibration point

	Range	Calibration point	OVC	Measurement current	100MΩ High-precision mode	0ADJ
Resistance measurement (Low-power mode: OFF)	1000 μΩ	0 Ω, 1000 μΩ	ON	High, Low	-	With or without*1
	10 mΩ	0 Ω, 10 mΩ	ON, OFF	High, Low	-	With or without*1
	100 mΩ	0 Ω, 100 mΩ	ON, OFF	High, Low	-	With or without*1
	1 Ω	0 Ω, 1 Ω	ON, OFF	High, Low	-	With or without*1
	10 Ω	0 Ω, 10 Ω	ON, OFF	High, Low	-	With or without*1
	100 Ω	0 Ω, 100 Ω	ON, OFF	High, Low	-	With or without*1
	1000 Ω	0 Ω, 1 kΩ	ON, OFF	-	-	With or without*1
	10 kΩ	0 Ω, 10 kΩ	OFF	-	-	-
	100 kΩ	0 Ω, 100 kΩ	OFF	-	-	-
	1000 kΩ	0 Ω, 1 MΩ	OFF	-	-	-
	10 MΩ	0 Ω, 10 MΩ	OFF	-	-	-
	100 MΩ	0 Ω, 100 MΩ	OFF	-	ON, OFF	-
	1000 MΩ	0 Ω, 1000 MΩ	OFF	-	OFF	-
Resistance measurement (Low-power mode: ON)	1000 mΩ	0 Ω, 1 Ω	ON	-	-	-
	10 Ω	0 Ω, 10 Ω	ON	-	-	-
	100 Ω	0 Ω, 100 Ω	ON	-	-	-
	1000 Ω	0 Ω, 1 kΩ	ON	-	-	-
Resistance measurement (PR mode: ON)	1000 μΩ	0 Ω, 1000 μΩ	ON	High, Low	-	With or without*1
	10 mΩ	0 Ω, 10 mΩ	ON, OFF	High, Low	-	With or without*1
	100 mΩ	0 Ω, 100 mΩ	ON, OFF	High	-	With or without*1
Temperature (thermistor)		25°C: 2186.0 Ω input				
Temperature (analog input)		10°C: 0.1 V input				
		100°C: 1 V input				
D/A output	1 Ω	0 Ω: 0 V output				
		1 Ω: 1 V output				

*1. No 0ADJ for OVC: Off only

Connection method

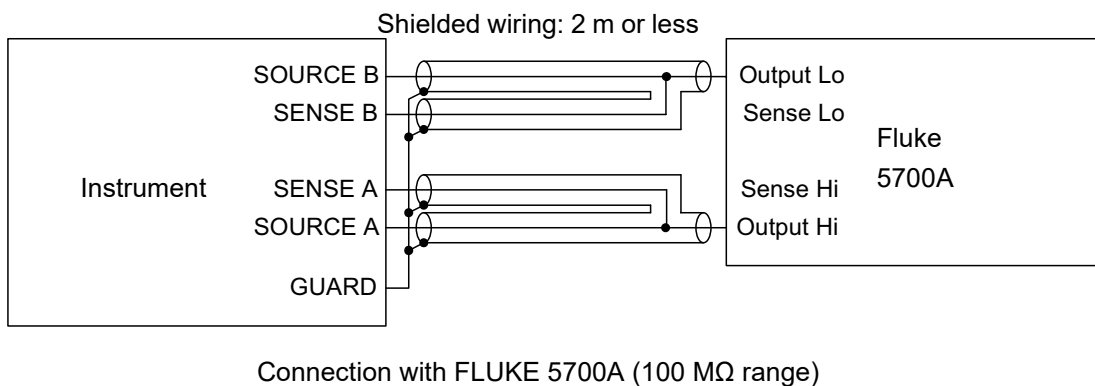
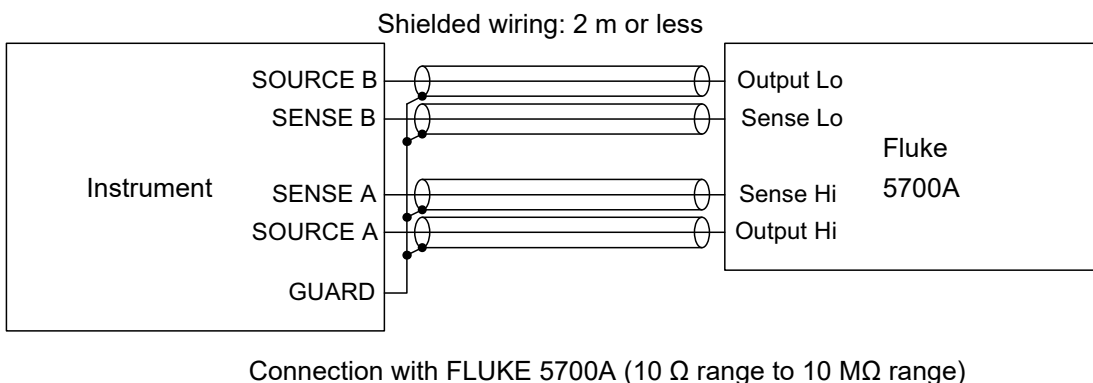
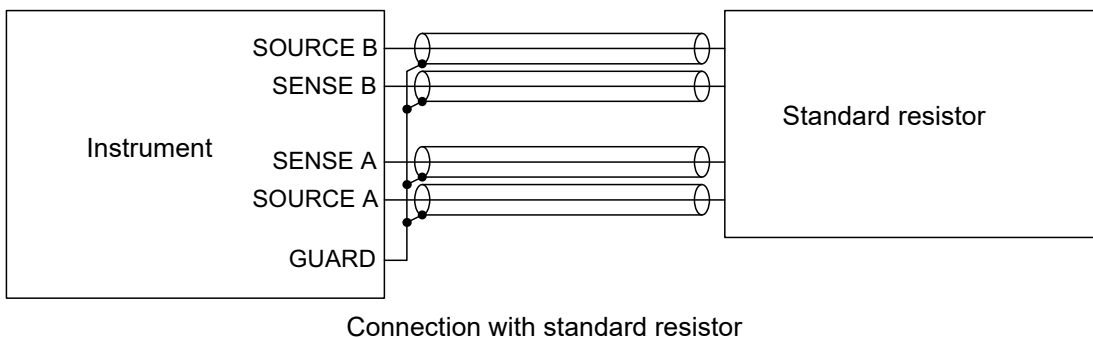
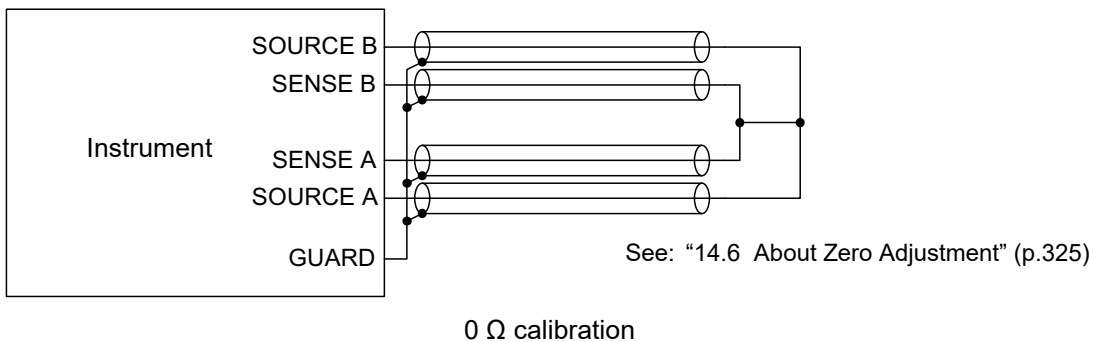

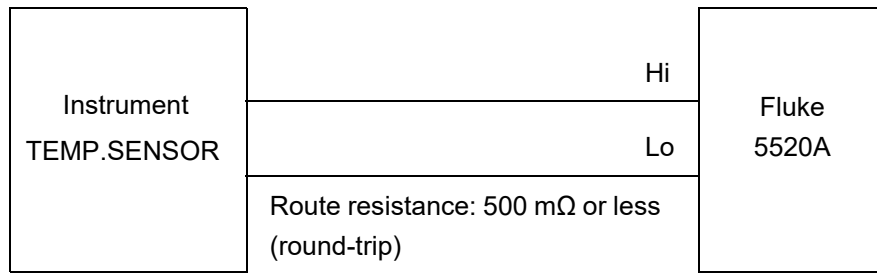

(No polarity)

Temperature measurement (Thermistor)

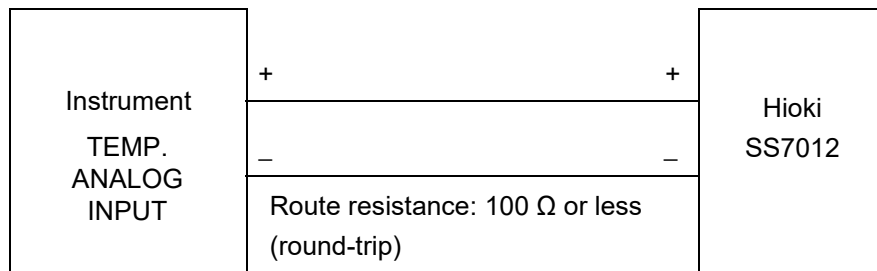

Temperature (Analog input)

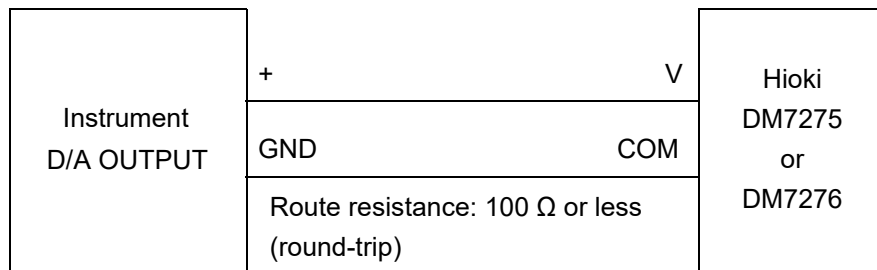

D/A output

IMPORTANT

- For more information about the wiring for 0 Ω calibration, see “14.6 About Zero Adjustment” (p.325).
- Adequate noise countermeasures must be implemented during high-resistance and low-resistance measurement, when using the low measurement current setting, and during low-power mode. In a highly noisy environment, the measured value may vary or become inaccurate. In addition, the measurement error detection function may react and no measured value may be displayed. Connect the metal exterior of standard resistors and dial resistors to the instrument’s GUARD potential.
See: “14.7 Unstable Measured Values” (p.330)
- Do not use alligator clips with the voltage detection terminals. Thermal EMFs may cause measured values to diverge.

When using the YOKOGAWA 2792 to calibration

Use the four-terminal lead from Hioki.

Note that connection cannot be made with the clip type lead.

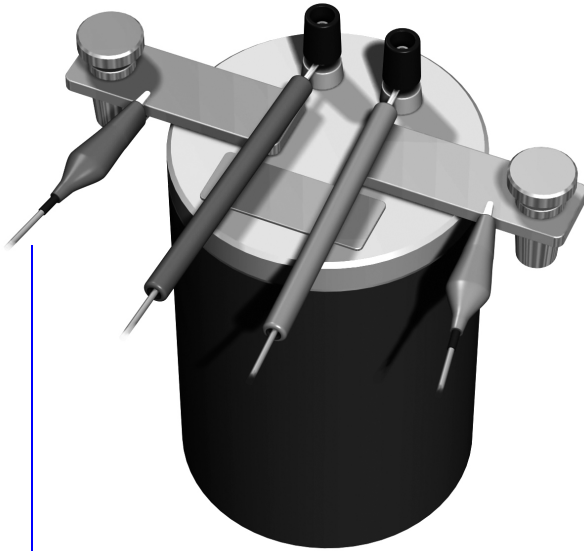
Correct

Four-terminal lead

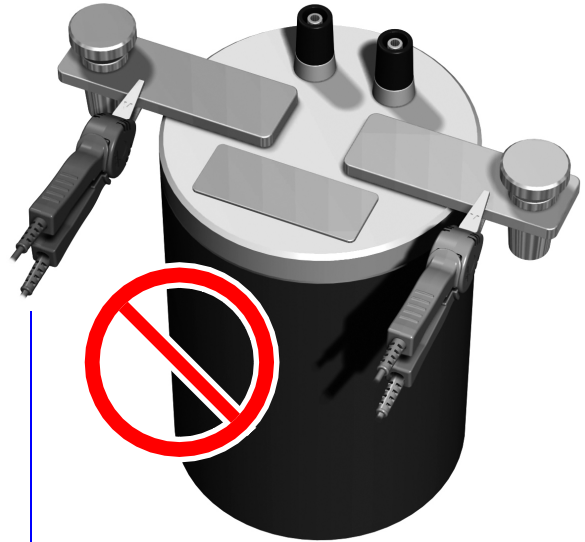
Incorrect

Clip-type lead

14.21 Adjustment Procedure

The System Settings screen includes an adjustment screen.

The Adjustment screen is used in repairs and adjustment carried out by Hioki. It is not available for use by end-users.

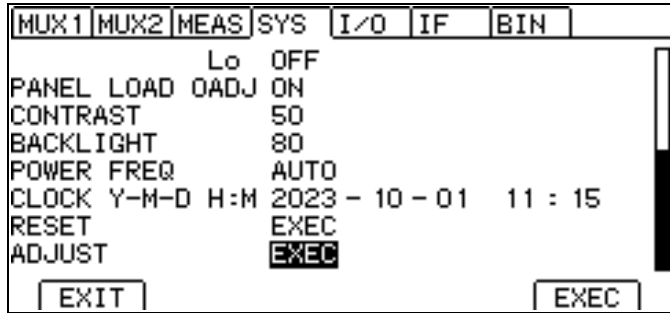

F4 Do not press.

14.22 Instrument Settings (Memo)

When you request that your instrument be calibrated or repaired, its settings will be reset to their default values.

It is recommended that you make note of the instrument's settings using the following table before requesting it be calibrated or repaired. The settings can also be saved to a PC by using the sample application software. The sample application software is available for download from Hioki's website.

<https://www.hioki.com/global/support/download/software/>

Screen		Setting and key	Setting
Measurement screen		COMP	
		PANEL	
		AUTO	
		▲▼ (RANGE)	
		SPEED	
Measurement screen (P.1/2) (P. 1/3 for RM3545A-2)		VIEW (F2)	
Measurement screen (P.2/2) (P. 2/3 for RM3545A-2)		0 ADJ (F2)	
		LOCK (F3)	
Measurement screen (P. 3/3)* ¹		FRONT (F1)	
		MUX (F2)	
		SCANSET (F3)	
Setting screen (SETTING)	Multiplexer Channel Settings screen (MUX1)* ¹	CH	
		TERM	
		INST	
		0ALL	
		0ADJ	
	Multiplexer Basic Measurement screen (MUX2)* ¹	SPD	
		RANGE	
		UPP/REF	
		LOW%	
		PASS	
	Measurement Setting screen (MEAS)	TC SET	
		ΔT	
		DELAY	
		AVERAGE	
		AUTO HOLD	
		SCALING(A*R+B)	
		OVC	
		LOW POWER	
		PURE RESISTANCE	
		MEAS CURRENT	
		Ω DIGITS	
		CURR ERROR MODE	
	CONTACT CHECK		
	CONTACT IMPRV		
	100MΩ PRECISION		

Screen		Setting and key	Setting
Setting screen (SETTING)	System Setting screen (SYS)	TERMINAL* ¹	
		STATISTICS	
		TEMP INPUT	
		CALIBRATION	
		KEY CLICK	
		COMP BEEP Hi	
		IN	
		Lo	
		PASS	
		FAIL	
		PANEL LOAD 0ADJ	
		CONTRAST	
		BACK LIGHT	
		POWER FREQ	
	EXT. I/O Setting screen (I/O)	TRIG SOURCE	
		TRIG EDGE	
		TRIG/PRINT FILT	
		EOM MODE	
		JUDGE/BCD MODE	
		OVRNRNG ERR OUT	
	Communications Interface Setting screen (IF)	INTERFACE	
		SPEED	
		DATA OUT	
		CMD MONITOR	
		PRINT INTRVL	
		PRINT COLUMN	
		STAT CLEAR	
		IP Address	
		Subnet Mask	
		Default Gateway	
		Port	
	BIN Setting screen (BIN)	MAC Address	
		BIN	

*1. RM3545A-2 only

15 License Information

This instrument uses the following open source software.

Amazon FreeRTOS

Copyright (C) 2020 Amazon.com, Inc. or its affiliates. All Rights Reserved.

Permission is hereby granted, free of charge, to any person obtaining a copy of this software and associated documentation files (the "Software"), to deal in the Software without restriction, including without limitation the rights to use, copy, modify, merge, publish, distribute, sublicense, and/or sell copies of the Software, and to permit persons to whom the Software is furnished to do so, subject to the following conditions:

The above copyright notice and this permission notice shall be included in all copies or substantial portions of the Software.

THE SOFTWARE IS PROVIDED "AS IS", WITHOUT WARRANTY OF ANY KIND, EXPRESS OR IMPLIED, INCLUDING BUT NOT LIMITED TO THE WARRANTIES OF MERCHANTABILITY, FITNESS FOR A PARTICULAR PURPOSE AND NONINFRINGEMENT. IN NO EVENT SHALL THE AUTHORS OR COPYRIGHT HOLDERS BE LIABLE FOR ANY CLAIM, DAMAGES OR OTHER LIABILITY, WHETHER IN AN ACTION OF CONTRACT, TORT OR OTHERWISE, ARISING FROM, OUT OF OR IN CONNECTION WITH THE SOFTWARE OR THE USE OR OTHER DEALINGS IN THE SOFTWARE.

lwip

LWIP is licenced under the BSD license:

Copyright (c) 2001-2004 Swedish Institute of Computer Science.

All rights reserved.

Redistribution and use in source and binary forms, with or without modification, are permitted provided that the following conditions are met:

1. Redistributions of source code must retain the above copyright notice, this list of conditions and the following disclaimer.
2. Redistributions in binary form must reproduce the above copyright notice, this list of conditions and the following disclaimer in the documentation and/or other materials provided with the distribution.
3. The name of the author may not be used to endorse or promote products derived from this software without specific prior written permission.

THIS SOFTWARE IS PROVIDED BY THE AUTHOR "AS IS" AND ANY EXPRESS OR IMPLIED WARRANTIES, INCLUDING, BUT NOT LIMITED TO, THE IMPLIED WARRANTIES OF MERCHANTABILITY AND FITNESS FOR A PARTICULAR PURPOSE ARE DISCLAIMED. IN NO EVENT SHALL THE AUTHOR BE LIABLE FOR ANY DIRECT, INDIRECT, INCIDENTAL, SPECIAL, EXEMPLARY, OR CONSEQUENTIAL DAMAGES (INCLUDING, BUT NOT LIMITED TO, PROCUREMENT OF SUBSTITUTE GOODS OR SERVICES; LOSS OF USE, DATA, OR PROFITS; OR BUSINESS INTERRUPTION) HOWEVER CAUSED AND ON ANY THEORY OF LIABILITY, WHETHER IN CONTRACT, STRICT LIABILITY, OR TORT (INCLUDING NEGLIGENCE OR OTHERWISE) ARISING IN ANY WAY OUT OF THE USE OF THIS SOFTWARE, EVEN IF ADVISED OF THE POSSIBILITY OF SUCH DAMAGE

Index

Symbols

ΔT 118, 324

Numeric characters

0ADJ 69, 190, 325
100 M Ω range high-precision mode 98

A

ABS mode 99, 102
Absolute value judgment 99
AC method 321
Accuracy 274, 297
 Example calculation 274, 297
 Resistance measurement 270
Adjustment 362
Allowable range 99, 104
Analog output thermometer 37
Appendix 319
AUTO 17, 48
Auto-hold 61
Automatic measurement 217
Auto-ranging 48
Average 74, 112

B

Backlight 135
Backup 44
BCD_LOW 191
BCDm-n 192
BIN measurement function 109
BIN0 to BIN9 109, 192
Block diagram 319
Broken wiring 90

C

CA 56, 312
CAL 94, 190
Calibration 94, 190, 299, 357
Capacitive coupling 338
CB 56, 312
Clip lead 331
Clock 136
Command monitor function 245
COMP 17, 101
Comparator
 Will not turn on 301
Comparator function 99

CONTACT A 56, 312
CONTACT B 56, 312
Contact check function 90
Contact error 56
Contact improver function 92
CONTACT TERM.A 56, 57, 90, 312
CONTACT TERM.B 56, 57, 90, 312
Continuous measurement 218
Crossover cable 237
Current fault detection function 58
Current sensing resistor 336

D

D/A output 181
Data memory function 247
Data output function 248
DC method 321
Default setting 139
Delay 86
Delay function 86
Delay setting 88
Deleting panel data 127
Disposing 316

E

Edge 219
Electromagnetic coupling 338
ENTER 17
EOM 192
ERR 56, 192, 311, 350
ESC 17
EXT. I/O
 Connection example 215
EXT. I/O connector 188, 229
External control 185
External triggering 217

F

F keys 16
F.LOCK 130
Four-terminal method 320
Free-run 218, 311
Frequency 133
FULL 130
Fuse 315

- H**
-
- HI99, 192
 - HILO99, 192
 - Hold 61
- I**
-
- IN99, 192
 - IN0, IN1 191
 - INDEX 192
 - Initialization 137
 - Inspection 30
 - INT 217
 - Internal circuitry 213
 - Internal triggering 217
 - IP address 239
- J**
-
- Judgment 99
 - Judgment beeper 106
 - Judgment method 99
- K**
-
- Key beeper 132
 - Keyboard 233
 - KEY_LOCK 130, 190
 - Key-lock cancel 131
 - Key-lock function 130
- L**
-
- LAN interface 238
 - Line frequency 133
 - LO99, 192
 - LOAD0 to LOAD5 123, 145, 191
 - Low-power mode65, 334
 - LP 65
- M**
-
- M.LOCK 130
 - Manual range 48
 - Measured value
 - Changing the number of digits 82
 - Checking 53
 - Fluctuation and error320, 348
 - Holding 61
 - Judging 99
 - Not displayed 303
 - Storing in memory 247
 - Unstable302, 330
 - Measurement condition
 - Loading 123
 - Saving 122
 - Measurement conditions45, 63, 121
 - Measurement current67
 - Measurement fault 56, 192, 311, 350
 - Measurement lead
 - Connecting 32
 - Option 352
 - User-made 348
 - Measurement process 20
 - Measurement range 48, 271
 - Measurement speed 50
 - Measurement target 332
 - Becomes warm 333
 - Unstable temperature 332
 - MENU key 16
 - Multiplexer 145
 - Multiplexer channel reset 137
 - Multiplexer connector 149
 - Multiplexer error 57
 - Multiplexer unit 41
 - Multiplexer unit test 172
 - MUX 123, 145, 191
- N**
-
- Negative measured value 53
 - NO UNIT 57
 - Noise 338, 339, 349
- O**
-
- OB 109, 192
 - Open work 58
 - OUT0 to OUT2 192
 - Outline drawing 356
 - Output signal 192
 - OVC 46, 83
 - Over-range detection function 58
 - OvrRng 57, 100, 312
- P**
-
- PANEL 17, 121
 - Panel
 - Changing panel names 126
 - Panel load 123
 - Panel save 122
 - Poor contact 90
 - Population standard deviation 112
 - Power cord 31
 - Power inlet 31
 - Power supply 43
 - PR 85
 - PRINT 190, 253
 - Printed circuit board 344
 - Printer 251
 - Printing 251, 253

Process capability index		
Bias	112	
Dispersion	112	
Pure resistance mode	85	
Q		
Q&A	301	
R		
Rack mounting	354	
RANGE	17, 48	
Range	48	
Range over	56	
REF% mode	99, 104	
Reference value	99, 104	
Relative value judgment	99	
Reset	137	
RMT	244	
RNG_OUT0 to RNG_OUT3	192	
RS-232C connector	18	
RS-232C interface	235	
S		
Scaling	78	
Scan zero-adjustment	169	
SCN_STOP	145, 191	
Screen contrast	134	
Screen organization	21	
Self-calibration	94, 190	
Self-test	44	
Shunt resistor	336	
Signal pinouts	188	
SPEED	17, 50	
Standard deviation of sample	112	
STANDBY key	43	
STAT	115	
Statistical calculation	112	
Statistical calculation function	114	
Statistical calculation result	116	
Printing	257	
SW.ERR	57	
System reset	137	
T		
TC	76, 322	
Temperature conversion	118, 324	
Temperature correction	76, 322	
Temperature sensor	34	
Temperature-rise test	118	
T_ERR	145, 192	
T_FAIL	145, 192	
Thermal emf	83, 342	
Timing chart	196	
Delay	87	
EXT. I/O	196	
T_PASS	145, 192	
Transformer	334	
Transmission speed	287	
TRG	114	
TRIG	190, 219	
Trigger source	217	
U		
Unit test	172	
UNLOCK	131	
Upper and lower limits	99, 102	
Upper threshold	102	
USB interface	233	
USB keyboard mode	233, 248	
V		
VIEW	21	
Voltage-drop method	320	
VPT function	59	
W		
Weld	46	
Wiring	348	
Z		
Zero adjustment fault	72	
Zero-adjustment	69, 190, 325	

Filling out "Inquiry Sheet" provides a convenient way to submit your questions.

Example of how to use the inquiry sheet

- Call us while viewing the inquiry sheet.
- Fax the inquiry sheet to us.
- Attach the inquiry sheet to an email and send it to us.

Initial screen

The model and version are displayed on the initial screen. They can also be checked on the [INFO] screen.

See: "Displaying a list of model and measurement conditions" (p.55)

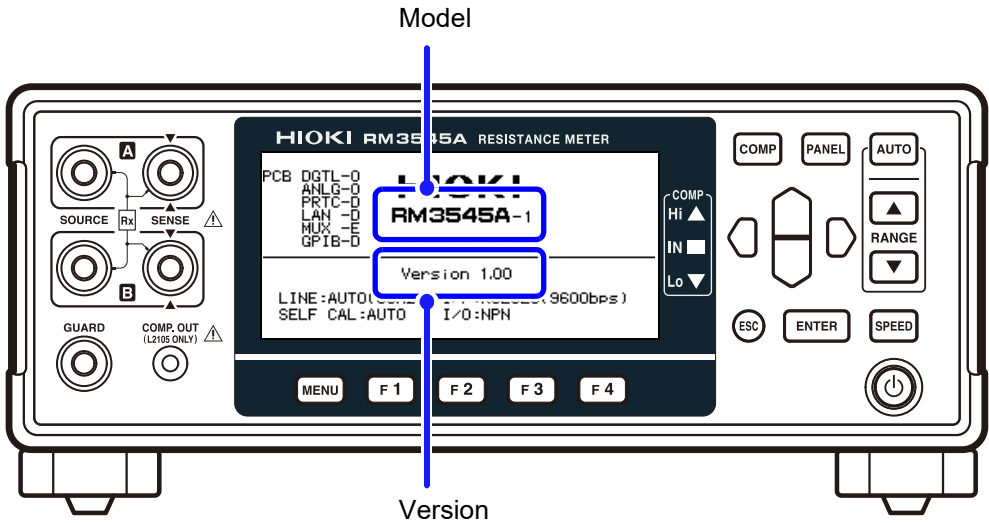

Rear panel

The manufacturing number is indicated on the rear panel. They can also be checked on the [INFO] screen.

See: "Displaying a list of model and measurement conditions" (p.55)

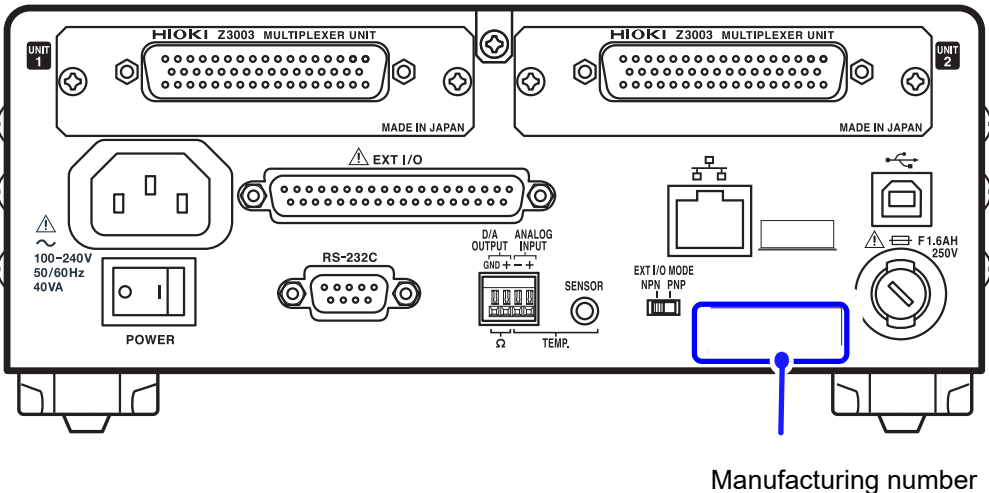

Inquiry Sheet (for communication)

Year Month Day

Name _____	Model of product being used _____	Version _____
Company _____	Department _____	
Phone number _____	E-mail _____	
Manufacturing number _____	Name of Hioki's respondent _____	

1. Interface being used

- RS-232C USB LAN
 EXT. I/O

2. Frequency of malfunction

- Always occurs every time.
 Occurs rarely (probability: approx. _____%)
 Other (_____)
- Value not displayed _____ is displayed on the screen

3. Fill out if using EXT. I/O.

- Description of malfunction
 - Triggers are not accepted
 - The EOM signal is not being output.
 - The comparator result is not being output.
 - Other (_____)
- Wiring method of EXT. I/O terminal, Timing chart for control
 (Describe in the space below or attach a separate sheet to facilitate our understanding of the current situation.)

4. Fill out the following if using RS-232C, USB, or LAN.

- Description of malfunction
 - Settings are not being applied.
 - The instrument fails to respond to queries.
 - The instrument responds unexpectedly to queries.
 - Other (_____)
- Connection destination (Name of controller, manufacturer, OS, etc.)
- Current setting method, etc.
 RS-232C, USB:
 COM port number _____
 RS-232C: Bit rate _____ bps
 LAN: IP address _____
 LAN: Subnet mask _____
 LAN: Default gateway _____
- Command that led to malfunction
 Command sent (_____)
 - Expected operation/response (_____)
 - Actual operation/response (_____)

Source code (to the extent you can disclose), Operation procedure, Wiring method of EXT. I/O terminal, EXT. I/O timing chart

(Explanations using figures and pictures facilitate our understanding of the current situation. They can be provided using separate sheets.)

HIOKI
www.hioki.com/



**All regional
contact
information**

HIOKI E.E. CORPORATION

81 Koizumi, Ueda, Nagano 386-1192 Japan

2309 EN

Edited and published by HIOKI E.E. CORPORATION

Printed in Japan

- Contents subject to change without notice.
- This document contains copyrighted content.
- It is prohibited to copy, reproduce, or modify the content of this document without permission.
- Company names, product names, etc. mentioned in this document are trademarks or registered trademarks of their respective companies.

Europe only

• EU declaration of conformity can be downloaded from our website.

• Contact in Europe: HIOKI EUROPE GmbH
Helfmann-Park 2, 65760 Eschborn, Germany

hioki@hioki.eu