

# Programmable High Precision DC Source Meter

GSM-20H10

---

## Quick Start Guide

GW INSTEK PART NO. 82SM-20H10M01



ISO-9001 CERTIFIED MANUFACTURER

**GW INSTEK**

## Copyright Statement

This manual contains proprietary information, which is protected by copyright. All rights are reserved. No part of this manual may be photocopied, reproduced or translated to another language without prior written consent of Good Will company.

The information in this manual was correct at the time of printing. However, Good Will continues to improve products and reserves the rights to change specification, equipment, and maintenance procedures at any time without notice.

**Good Will Instrument Co., Ltd.**  
**No. 7-1, Jhongsing Rd., Tucheng Dist., New Taipei City 236, Taiwan.**

# Table of Contents

<b>OVERVIEW .....</b>	<b>2</b>
Front Panel .....	3
Rear Panel .....	8
Terminal Connection.....	10
<b>BASIC OPERATION .....</b>	<b>16</b>
Preparation .....	16
Source Function .....	18
Measure Function.....	33
Limit Function .....	46
Sequence Function.....	58
TRIG Function .....	67
<b>SYSTEM SETTINGS .....</b>	<b>76</b>
Range Limitation .....	76
System Parameters .....	78
<b>Specifications .....</b>	<b>86</b>
Optional Accessories.....	91

# OVERVIEW

---

The GSM combines a precise, low-noise, highly stable DC power supply with a low-noise, high-impedance multimeter. It has 0.012% basic accuracy with  $6^{1/2}$  digit resolution. At  $4^{1/2}$  digits display resolution (Medium), the GSM delivers 520 readings/second over the IEEE-488 bus. At  $3^{1/2}$  digits display resolution (Fast), it can read up to 2000 readings/second into its internal buffer.

Because of its built-in source function, the GSM can be used to generate a set of current voltage (I-V) characteristic curves, which is very useful for semiconductor device and material testing.

It is equivalent to the combination of voltage source, current source, voltmeter, amperemeter and ohmmeter.

The digital GSM is designed for routine testing and high-speed production testing applications. In the manufacturing of components and modules of communication, semiconductor, computer, automobile and medical industry, GSM is of great practical value for their various characteristics analysis and production process testing. It is also usually used in testing and R & D laboratories.

# Front Panel

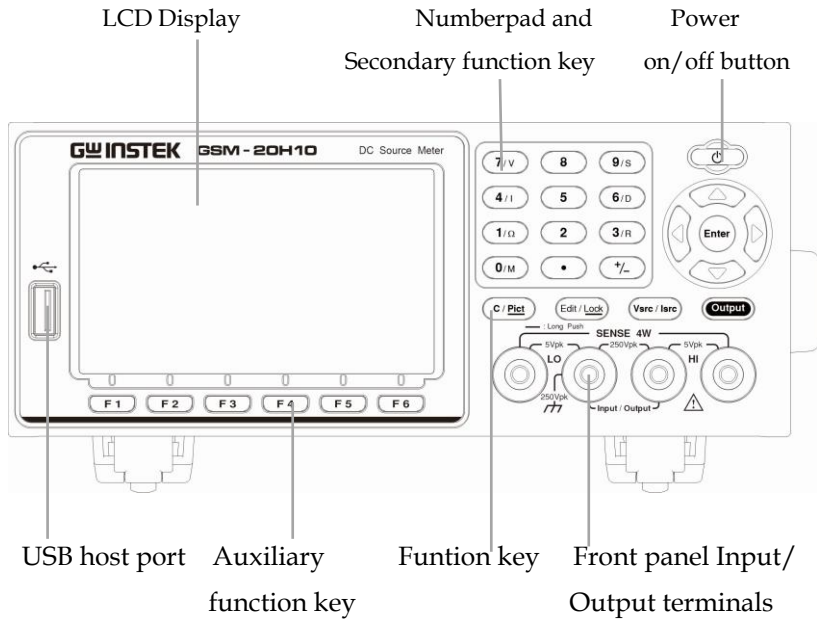

## Display & Parameter

Power on  
Display  
(Source)

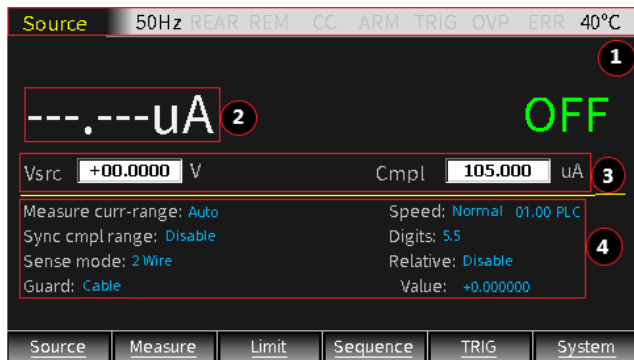

Description The display is used primarily to program source and compliance values and display the real measurement readings. The area is divided as follows.

- ① Status and Error messages  
Status and error messages are displayed momentarily, which are located on the top of the display, indicate various states of operation.
- ② Reading Data/Format  
The readback value is displayed with a resolution of up to  $6^{1/2}$  digits. The number of display digits can be changed by directly setting Digits or modifying the refresh Speed.
- ③ Edit the source  
Under the reading display area, is used for programming source value (Vsrc or Isrc) and compliance (Cmpl) limit.
- ④ Set the parameter  
Under the middle horizontal line used for programming related parameters.





Measure curr-range: 100uA	Speed: Normal 01.00 PLC
Sync cmpl range: Disable	Digits: 6.5
Sense mode: 2Wire	Relative: Disable
Guard: Ohms	Value: +0.000000

- ⑤ Auxiliary function key  
The bottom line is function name of the keys F1 to F6. Under the main interface, F1 is Source function, F2 is Measure function, F3 is Limit function, F4 is Sequence function, F5 is TRIG function, F6 is System function. In other interfaces, the definition of function keys is different.

Control Panel

Power standby switch



Long press for at least 2 seconds to turn on or turn off the power supply of the instrument (turn on the AC power switch on the rear panel first, and make the GSM standby light red ) , and the light turn to yellow  after turning on the machine.

Cancel/Hardcopy key



Short press C/Pict key to cancel the chosen setting value.

Long press (2 to 3sec) C/Pict key to copy current display interface. The screenshot will be stored to USB flash disk automatically.

Voltage and Current Setting key



Voltage-source (Vsrc)/ Current-source (Isrc) toggle button. See page 20 for details.

Output key



The Output key turns the output on or off. The Output key will light up when the output is on.

On:  → 

Auxiliary function key



Under the LCD is the F1 to F6 function button. In different interfaces, the definition of auxiliary function key is different.

Direction keys and Enter key



The direction keys are used for parameter and menu selection as well for fine adjustment of the current/voltage range settings.

Edit / Lock  
key



The Enter key is used to confirm the selection of any settings or parameters and to exit after a setting is complete.

The instrument must be in the edit mode to set source and compliance values. The edit mode is selected by short pressing the Edit/Lock key. The editing cursor (marking digit) appears for the source or compliance edit. If a value is not edited within 6 seconds, the edit mode is cancelled.

While in the edit mode, the Edit/Lock key toggles between the source value, compliance value and parameters setting.

Long pressing Edit/Lock key is used to disable all the panel keys except the Output key.

Pressing the Edit/Lock key for at least 2 seconds will turn the panel locked or unlocked.

Number  
pad

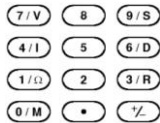

The number pad is used to enter various parameters values.

V/ I/ Ω/M, measurement shortcut keys. These buttons can only operate in the case of non digital input .V/ I shortcut keys can operate in Source and Measure function, Ω/M shortcut keys only operate in Measure function.

**V:** Measure and display the voltage

**I:** Measure and display the Current



**Ω:** Measure and display the Resistor

**M:** Measure and display the calculation result

Measurement operation under each function:

Source: V, I

Measure: V, I, Ω, M

Limit: V, I, Ω, M

Sequence: V, I, Ω, M

**!** **NOTE:** When measuring resistor under Sequence, set Ohm source as Manual.

S/D/R, parameters setting shortcut keys. These buttons can only operate in the case of non digital input.

**S:** Speed setting

**D:** Digits setting

**R:** Relative setting

**Terminals**

Input/Output

Terminals (SOURCE)

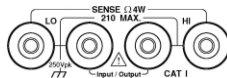

The middle two terminals are the Input and Output of the source.

Voltage Feedback Terminals (SENSE)

On both sides are voltage feedback terminals corresponding to positive and negative terminals. These two terminals are used for 4-Wire output or 4-Wire resistance measurement

# Rear Panel

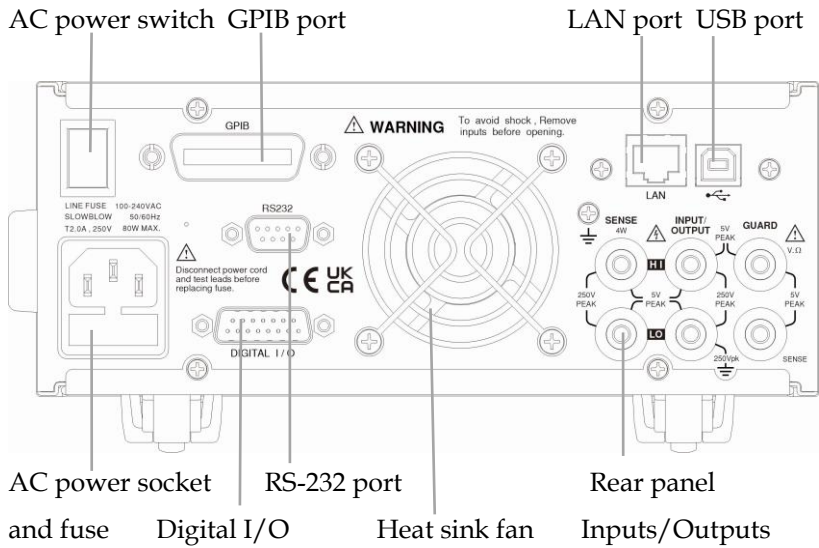

## Terminals

AC power switch



Power on or power off the main circuit, GSM-20H10 is in standby state after pressing I, and the standby light on the front panel is red.  
I->on, O->off

AC input socket and fuse case



The AC input accepts 100 to 240 ± 10% VAC. The frequency is 50Hz/60Hz.  
Fuse: 2.0A (slow-blow type).

USB port



USB device port for remote control.

GPIB port  GPIB slave port for remote control. Abides to IEEE488.2 (SCPI) protocol.

LAN port  LAN port for remote control.

RS-232 port  RS-232 device port for remote control.

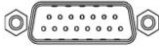
Digital I/O port  There are 15 I/O ports: one +5V output ports, one GND port, four digital output lines and four trigger link lines, two input signal lines, three idle lines. See Limit function page 47 and TRIG fuction page 67 for details.

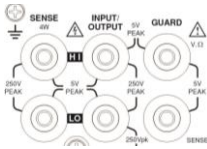
Rear panel inputs/outputs  There are six terminals, including two power Input and Output positive and negative terminals, two voltage feedback positive and negative terminals, one guard terminal and one guard sense terminal. Please refer to the printing of the back panel for the specific order.

Heatsink fan  It is used to discharge the heat inside the equipment through air flow. In either case, proper ventilation must be maintained to prevent overheating.

# Terminal Connection

## Front/Rear Terminals

**Terminals** The INPUT/OUTPUT (HI and LO) and SENSE (HI and LO) terminals are accessible from both the front and rear panels. The V.Ω GUARD and GUARD SENSE terminals are only accessible from the rear panel.

**Front/Rear terminals selection** The front/rear terminal can be selected through the System menu. When the rear terminal is selected, the LCD status bar will display REAR. The front panel is used by default when powered on, there is no display on the status bar.

Manually set from the front panel: System->Control->Rear, or set by the command :ROUTE:TERMINals.

**!** **NOTE: After change the front and rear terminals, the output will be turned off.**

## Connect to Load

**Description** The maximum allowable voltage differentials between terminals are labeled on the Front/Rear panel, as shown in the figure (rear panel).

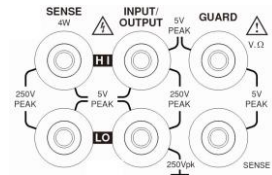

 **WARNING:** To prevent electric shock and damages to the GSM-20H10, DO NOT exceed the maximum allowable voltage differentials shown in terminals. The front and rear terminals of the GSM are rated for connection to circuits rated Installation Category I only. Do not connect the GSM terminals to CAT II, CAT III, or CAT IV circuits. Connections of the GSM Input/Output terminals to circuits higher than CAT I can cause damage to the equipment or expose the operator to hazardous voltages.

To prevent electric shock and damage to the GSM, external common mode voltage must be limited with 250VDC, 1.05A maximum.

## Sense Connect Methods

---

Description Basic source-measure operations are performed using either 2-wire local sense connections or 4-wire remote sense connections. The factory default sense selection is local.

 **NOTE:** The front panel terminals are isolated from the rear panel terminals. Therefore, if you are using the front panel terminals, ground the front panel LO terminal. If using the rear panel terminals, ground the rear panel LO terminal.

Connections alone do not determine sense mode. For local sensing, 2-wire sensing must be selected from the Sense mode option from front panel parameter setting area. For remote sensing, 4-wire sensing must be selected. The 2-wire sense mode is the BENCH and GPIB default.

**! WARNING:** There is no internal connection between earth ground and INPUT/OUTPUT LO terminal of the GSM. Therefore, hazardous voltages (>30V rms) maybe appear on that LO terminal. Typically, this can occur when the GSM is operating in any mode where the output changes rapidly, such as quick, pulsed waveforms that can be generated using the ZERO, AUTO-OFF output state, or fast pulse sweep operations.

To prevent this from occurring (if your application allows it), connect the INPUT/OUTPUT LO terminal to earth ground. You can connect the LO terminal to the chassis ground screw terminal on the rear panel, or to a known safety earth ground.

4-wire  
remote  
sensing

When measuring the voltage, there may be a deviation caused by the line resistor of the leads. Using 4-wire connection can optimize the measurement accuracy and ensure that the programmed voltage is transmitted to the DUT. When measuring the voltage, only the voltage drop on the DUT is measured. Use 4-wire remote sensing for the following source-measure conditions:

- Test circuit impedance <math><1\text{k}\Omega</math>.
- Need to obtain the best resistor value/voltage measurement accuracy.

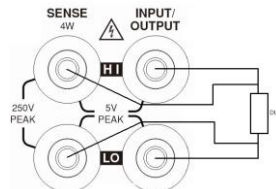

**! NOTE:** Specified accuracies for both source and measurement can only be achieved using 4-wire remote sensing.

When the output is turned off in 4-wire sensing mode, for safety reasons, the Sense mode automatically returns to 2-wire. When the output is turned on, the Sense mode automatically restores to 4-wire.

**⚠ WARNING: When sourcing voltage in remote sense, make sure the sense leads are connected to the DUT. If a sense lead becomes disconnected, 0V will be sensed, and the GSM will increase the output voltage (to possibly hazardous levels) to compensate. For increasing safety, you can limit the voltage output of the GSM (turn on OVP function).**

2-wire local sensing 2-wire local sense connections can only be used if the deviation contributed by test lead IR drop is acceptable to the user. When current levels below 100mA, the errors are usually not significant (assuming test lead resistor is not greater than 1Ω). Since the current in the series circuit is the same at all points in the loop, 4-wire sensing cannot improve the accuracy of I source or current measurement. Therefore, if it is I source measuring current mode, you can use 2-wire sensing. Other conditions that allow the use of 2-wire sensing methods include:

- Test circuit impedance is 1kΩ. Above 1GΩ, Guard option should select Cable.
- Measure V function or measure I function.

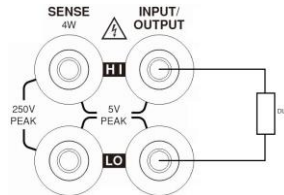

---

## Sense and Guard Selections

---

**Sense selection** When using the SENSE HI and LO terminals of the GSM, 4-wire remote sensing must be selected. When not using these terminals, 2-wire local sensing must be selected.

 **NOTE: When Sense mode or Guard settings are changed, the OUTPUT will turn off. The GSM defaults to the 2-wire mode when the output is off, regardless of the sense setting. When the output is turned on, the present sense setting will be in effect.**

**Front panel sense selection** On power-up, the instrument is automatically set for 2-wire local sense. Perform the following steps to change the sense selection:

1. Click the Edit/Lock button and the direction keys to make the cursor stop in the Sense mode setting box.
2. Press Enter button, use the direction keys to select 2 Wire or 4 Wire, and press Enter to exit programming.

 **NOTE: 2 Wire indicates that local sense is selected, and 4 Wire indicates that remote sense is selected.**

**Guard selection** Cable guard is used for high-impedance guarding for cables (i.e., coax and triax) and test fixtures. Ohms guard provides a high-current guard output, which allows in-circuit guarded ohms measurements. On power-up, Cable guard is selected.

 **NOTE: For 6-wire ohms measurements, use the Guard output off mode. See page 75.**



- Front panel guard selection
- Perform the following steps to change the Guard selection:
1. Click the Edit/Lock button and direction keys to make the cursor stay in the Guard setting box.
  2. Press Enter button, use the direction keys to select Ohms or Cable, and press Enter to exit programming.



**NOTE: 1, Do not use Ohms guard with coaxial cabling, or oscillations may occur.  
2, Ohms guard cannot be selected on the 1A range (source or measure).**

# BASIC OPERATION

## Preparation

---

### Function Overview

---

**Description** From the front panel, the GSM-20H10 can be configured to perform the following operations:

**Source Function:**

- Source voltage – Display current or voltage measurement reading
- Source current – Display voltage or current measurement reading

**Measure Function:**

- Measure resistor – Press  $\text{7/V}$  or  $\text{4/I}$  hot key to display voltage or current measurement reading of resistor under test.
- Measure only (V or I) – Display voltage or current measurement reading.

### Parameter Setting Method

---

**Description** There are roughly the following types of GSM parameters, and the operations are as follows:

- Value input**
- Require to select the range, press Enter to make it in the editing state  (the digital background is black), use the up and down direction keys to select the range first, and then choose the following two methods to input the

required value:

1. Press the numeric key to input the required value, and press the sign key firstly if a negative value is needed, then press Enter to exit editing.
  2. Press the left and right arrow keys, the cursor stops on the digit that needs to be modified, and use the sign key and numerical keys to input the required value; or press the up and down arrow keys to adjust the value to the required number.
- Do not require to select the range, press Enter to make it in the editing state  ( the digital background is black), then use the above two numerical input methods to operate.

Select  
input

There are up and down arrows in the edit box, use the up and down arrow keys to select, and use the Enter key to confirm, as shown in the figure:



## Source Function

### V/I Output Range

Source or Sink According to the settings and connection with the load, the GSM can operate in any one of the four quadrants. The figure below shows the four operating quadrants of the GSM. When operating in the first (I) or third (III) quadrant, the GSM operates as a power source (V and I have the same polarity). As a power source, the GSM provides power to the load.

When operating in the second quadrant (II) or the fourth quadrant (IV), the GSM operates as a sink (the polarity of V and I are opposite). As a sink, it is consuming energy, not providing energy.

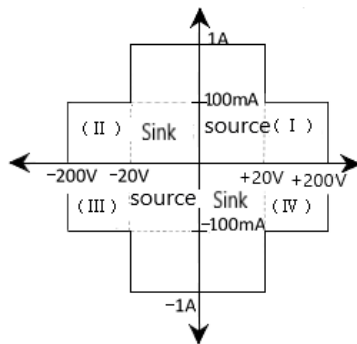

## Front Panel Programming Interface

Default  
power on  
interface

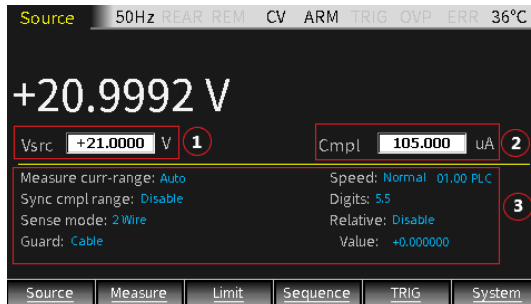

1. Source interface: the parameter setting consists of 3 areas, marked as ①②③ in the picture, press Edit/Lock key to toggle between ①②③.
2. When the cursor is moved to area ① or area ②, use the up and down direction keys to toggle the corresponding range, and enter the required value in the corresponding digit.
3. When the cursor is moved to the area ③, use the arrow keys to move the cursor to the corresponding option, press the Enter key to show up and down arrows (indicating that there are multiple options), select the corresponding option by the up and down keys, and press the Enter key to confirm parameter setting.

For numerical setting items, after selecting and Entering, if the pull-up and drop-down arrows appear, it means that there are multiple range options. Use the up and down keys to select the corresponding range, then enter the required value, and press Enter to confirm to complete the parameter setting. The value settings of other interfaces are similar to this.

 **NOTE:** After moving the cursor to area ③, in the case of non-parameter setting, operating the number "7" and "4" keys can toggle the

measurement reading between Voltmeter and Amperemeter.

## Parameter Description and Operation

---

Vsrc/Isrc Set the power supply as V-Source or I-Source. When it is in the editing state (press Edit/Lock key to make the number digits turn into white characters on a black background), the range can be changed by the up and down keys.

### Range setting

When in the editing state, operate the up and down direction keys to confirm the required range with the decimal point and unit. Vsrc has 4 ranges(200mV, 2V, 20V, 200V), and Isrc has 7 ranges(1uA, 10uA, 100uA, 1 mA, 10mA, 100mA, 1A).

### Numerical input

- ① Number key input: Use the number keys 0~9 to input the required value in digits order, and press Enter key to confirm.
- ② Digit-by-digit input: After inputting the first digit or sign, it is in the digit editing (single digit background and white character), press the left and right direction keys to select the digit to be fine-tuned, and press the up and down direction keys to increase or decrease the value. After setting, press Enter to confirm.



**NOTE: The time limit for editing is about 6 seconds. If there is no operation, the system will automatically return to the non-editing state.**

Cmpl Set the compliance value of output voltage or

current. When it is in the editing state (press Edit/Lock key to make the number digits turn into white characters on a black background), the range can be changed by the up and down keys.

#### Range setting

The operations is the same as Vsrc/Isrc setting.

#### Numerical input

The operations is the same as Vsrc/Isrc setting.



**NOTE: The time limit for editing is about 6 seconds. If there is no operation, the system will automatically return to the non-editing state.**

Measure - range This Measure-range refers to the range selection of V, I and  $\Omega$  measurement reading.

**Range limit:** When using as V-Source, the voltage measurement range cannot be changed. When using as I-Source, the current measurement range cannot be changed. The measurement range is determined by the selected source range.

**Manual range:** For Source V/Measure I, Source I/Measure V and Ohms measurement configurations, a fixed range can be selected. Please note that the highest available range depends on the corresponding compliance value.

**Auto range:** For Source V/Measure I, Source I/Measure V and Ohms measurement configurations, set Measure curr-range or Measure volt-range to Auto to enable auto range. After selecting the auto range, the instrument automatically selects the best range for measurement. Please note that the highest available range depends on the corresponding compliance setting.

If Measure curr-range or Measure vol-range option selects Auto, the SDM cycle will repeatedly read the measured value in the new range. Each SDM cycle includes source delay time.

**Range setting:** Press the Edit/Lock key to select the Measure volt-range or Measure curr-range option, press the Enter key to make it in the editing state, use the up and down keys to select the required range, press Enter to confirm and exit the editing state.

Sync  
cpl  
range

Setting measurement reading range to synchronize with compliance range, the default setting is Disable when power-on. To enable Sync cpl range, Auto for Measure volt-range or Measure curr-range should be deselected, that is, turn off the Auto range function. When Sync cpl range is selected as Enable, the measurement reading range can be automatically synchronized with the Cmpl range.

Sense  
mode

The basic source-measure operations of GSM performed using 2-wire local sense connections or 4-wire remote sense connections.

Guard

There are two protection methods of Ohms and Cable. The default Guard option is Cable guard.



**WARNING: GUARD terminal level is the same as Output HI terminal level. If Output HI terminal is high level, GUARD terminal is also high level.**

**Cable guard:** Used in the case where the impedance of the circuit under test is greater than  $1G\Omega$ , using the high-impedance guard connection. It is usually necessary to use shielded wires and test fixtures to test high-impedance equipment, which can reduce



interference and protect the users from being injured by hazardous voltage on the guard shield (or plate). The CABLE guard selection provides a high-impedance ( $\sim 10\text{k}\ \Omega$ ) driven guard to prevent positive feedback, which could cause oscillations when using shielded cables. Cable guard is used to drive the shields of cables and test fixtures. Inside the test fixture, the guard can be connected to a guard plate or shield that surrounds the DUT.

**⚠️ WARNING: To prevent electric shock injury, a safety shield must be used to prevent physical contact with a guard plate or guard shield that is at a hazardous potential (above 30Vrms or higher than 42.4V peak). The guard plate or guard shield must completely be enclosed by the safety shield device which must be connected to the earth ground.**

In the fixed device, a triaxial cable can be used to connect the GSM and the device under test. The wire in the center is connected to the Input/Output HI terminal, the metal plate is connected to the V. $\Omega$  GUARD terminal, and the safety shield is connected to the Input/Output LO (connected to the earth ground).

Coaxial cables can be used when the potential of the V. $\Omega$  GUARD terminal is not higher than 30Vrms (42.4V peak), the center wire is connected to the InputT/Output HI terminal of the GSM, and the metal plate is connected to the V. $\Omega$  GUARD terminal.

Figure below shows the cable guard connection mode. The V. $\Omega$  GUARD is connected to the metal plate equipped with insulated measuring column through test lead. Since the voltage at both ends of the insulation measuring column equal, the voltage drop on its parasitic resistor (RL1 and RL2) is 0, and

no leakage current passes. Therefore, the current measured by the GSM is the current flowing through the device under test.

**NOTE**

- a Cable guard must choose the connection shown in Figure below.
- b The plate of the fixture should be connected to the Input/Output LO terminal to reduce interference.
- c Cable guard should be used when the GSM source or sink low current (<1uA).

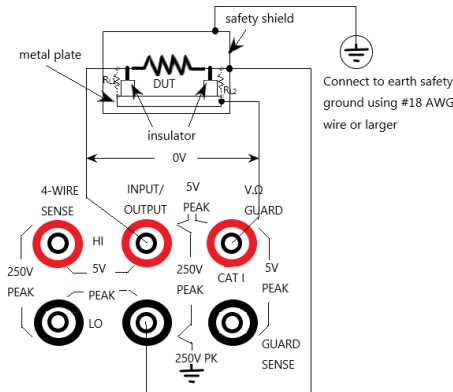

**Ohms guard:** Provide low internal resistor (<1Ω), high output current (up to 50mA) drive protection, allowing resistor measurement in the circuit. When measuring the resistor component in the resistor network, eliminate the influence of the resistor in parallel with it.

Guarded ohms measurement mode is divided into three connection methods according to the impedance of the DUT:

1.  $R_g \geq 1k\Omega$ 

When the impedance  $R_g$  from the V. $\Omega$  GUARD terminal to the Input/ Output LO terminal is more than  $1k\Omega$ , the voltage drop of the lead impedance (about  $1\Omega$ ) of the V. $\Omega$  GUARD terminal is very small relative to  $R_g$ , and the voltage drop of  $R_1$  is approximately zero, and no leakage current flows through  $R_1$ . The voltage on the DUT is the Input/Output HI terminal voltage, then the current value flowing through the DUT is measured, and the resistor value of the DUT can be calculated by the formula.

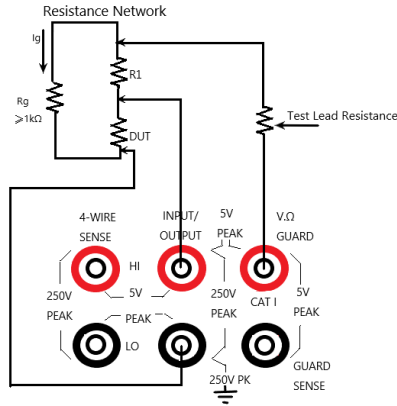

2.  $R_g < 1\text{ k}\Omega$

The voltage drop on the test lead (about  $1\Omega$ ) of the V.Ω GUARD terminal is significant respectively to the voltage drop on the  $R_g$ , causing the potential at the connection between  $R_1$  and the V.Ω GUARD terminal to be lower than the potential at the connection between  $R_1$  and the Input/Output HI terminal. Furthermore, there is leakage current flowing through  $R_1$  which will affect the measurement accuracy. In order to eliminate the influence of the voltage drop of the test leads on the V.Ω Guard terminal, use the connection method shown in the figure below to connect the GUARD SENSE port to the resistor network. The GUARD SENSE port senses the interface voltage of the V.Ω GUARD terminal in the resistor network. When the voltage is lower than the input/output HI terminal voltage, the V.Ω GUARD terminal voltage will increase until the voltage sensed by the GUARD SENSE terminal is equal to the input/output terminal voltage.

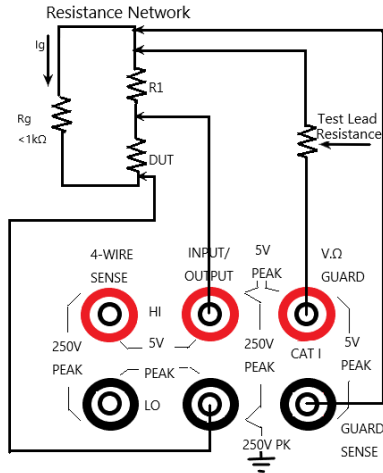

3.  $R_{DUT} < 1k\Omega$

In this situation, 4-Wire sense mode should be used. When  $R_g < 1k\Omega$ , this connection method is 6-Wire ohms guard measurement. When using this measurement method, select GUARD output-off states for Off state option.

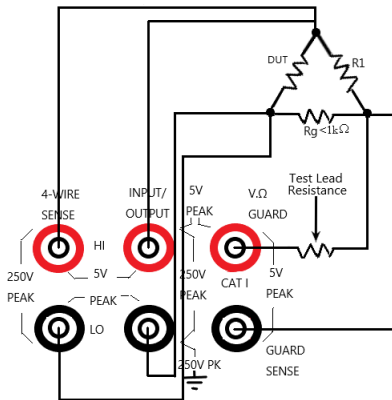

**! NOTE:**

- a Ohms guard cannot be selected in 1A range (as source or meter). If you have selected Ohms guard, you cannot select 1A range.
- b The Guard terminal current cannot exceed 50mA, otherwise the Guard terminal voltage

will be less than the Input/Output terminal voltage and affect the measurement data.

- c Guard sense operation is automatic, and it can be used directly after connecting the test leads without setting.

**Speed** Set the data sampling speed, that is, the calculation processing time of A/D conversion, which is determined by the number of power cycles. For example, for 50Hz AC voltage, 1PLC equals to 20ms (1/50). There are five options for data sampling speed: Fast, Medium, Normal, High, and Other. Fast corresponds to the shortest sampling period of 0.01PLC, the accuracy is the lowest, and the display Digits becomes 3.5 bits accordingly. High option corresponds to the longest sampling period of 10PLC, the measurement reading has the highest accuracy, and the display Digits becomes 6.5 bits accordingly. Generally speaking, the fastest sampling speed (Fast: 0.01PLC) will result in an increase in reading noise and a decrease in the number of available digits. The slowest sampling speed (High: 10PLC) provides the best accuracy and noise suppression. The middle settings are compromise between speed and noise. The default power on speed is Normal (1PLC). Other is a custom option.



**NOTE: Changing the Speed will modify the Digits synchronously, but changing the Digits does not affect the Speed setting.**

**Digits** The display digits of the measurement reading. There is four options of 3.5, 4.5, 5.5, and 6.5. This setting is global. After setting the display digits, it is valid for the display reading of all measurement functions (voltage, current, resistance).

**Relative** It is used to zero offset or subtract the reference value from the reading (it can be voltage, current or resistance).

**NOTE:**

- a **Relative Value is valid to all the ranges. For example, if the Relative Value is set to 5V in the 20V range, if the range is changed to 2V or 200V, the Relative Value is still 5V.**
- b **When the programmed Relative Value exceeds the selected range, it will not cause overflow and will not increase the maximum allowable input for the range. On the 20V range, for >21.1V input, the GSM will still overflow.**
- c **When Relative is set as Enable, the display area will display REL. If toggling the V/I measurement, Relative option will automatically change to Disable.**

Enter a Relative Value manually:

- 1) Press the arrow keys to move the cursor to the Relative Value setting box, select Enable, and then press Enter.
- 2) Press the arrow keys to move the cursor to the Value setting box, set the required value, and then press Enter.

### Other Settings

Long press the Source key to open the following interface which are used to set the parameters of OVP, Auto delay, Vsrc trig control, and Isrc trig control.

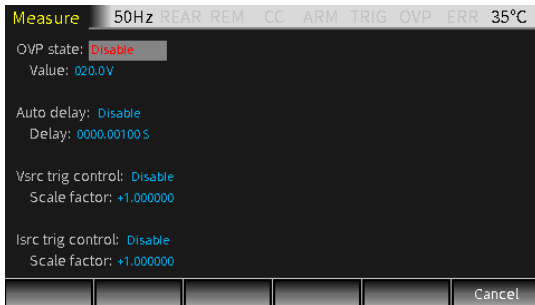

### OVP

When you select Enable, the OVP function is enabled,

and the OVP symbol **OVP** is displayed in the status bar.

When the output exceeds the OVP Value, the OVP status indicator is lit in red **OVP**, indicating that the OVP status is entered, and the actual output is limited to the programmed OVP Value.

**Auto delay** It is used to set the automatic delay time. The delay time refers to the delay phase in the Source-Delay-Measurement (SDM) cycle, which depends on the selected Source range.

GSM operations may include a series of Source-Delay-Measurement (SDM) cycles. During each SDM cycle, the following will happen:

1. Set the source value
2. Wait for the source delay
3. Take measurement reading

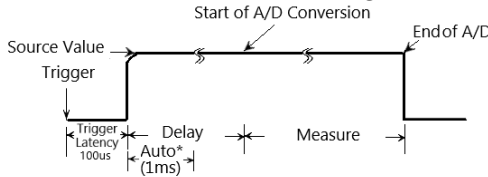

\* If enabled

The delay of the SDM cycle can make the source stabilize before the measurement. The source delay can be manually set from 0000.00000 seconds to 9999.9990 seconds using Delay setting box; if the Auto delay is Enabled, the delay time depends on the presently selected source range.

**Vsrc trig control** Used to control the V-Source trigger, move the cursor to the Vsrc trig control box, press Enter and the up and down keys to select Enable or Disable, and when Enter is selected, input the value in the Scale factor box. This function is used for SRC-MEM sequence.

**Isrc trig** Used to control the I-Source trigger, move the cursor



control to the Isrc trig control box, press Enter and the Arrow keys to select Enable or Disable, when selecting Enter, input the value in the Scale factor box. This function is used for SRC-MEM sequence.

## Output Operation

---

- Step Generally have the following:
- a Connect the external connection (front-panel or rear-panel) according to the requires of the test.
  - b For rear-panel output, enter System->Control->Rear in turn.
  - c Set Vsrc or Isrc and Cmpl on the front panel.
  - d Set other parameters in the parameter area (Measure interface).
  - e Select the required measurement reading V/I (corresponding to 7/V, 4/I buttons).
  - f Press the Output button to start the measurement.

## State Description

---

- REAR Display when setting as rear-panel output. Otherwise, it is the front-panel output
- REM Remote control
- CV When the GSM is set as I-Source, in case that the terminal output voltage is restricted by Cmpl or Measure vol-range, the GSM operates in CV (constant voltage) mode  
When the GSM is set as V-Source, in case that the terminal output current is not restricted by Cmpl or Measure cur-range, the GSM operates in CV (constant voltage) mode
- CC When the GSM is set as V-Source, in case that the terminal output current is restricted by Cmpl or Measure curr-range, the GSM operates in CC (constant current) mode  
When the GSM is set as I-Source, in case that the terminal output voltage is not restricted by Cmpl or Measure vol-range, the GSM operates in CC (constant current) mode

ARM	Source-measure operation is in progress
TRIG	Select external trigger source (Tlink, Rising Edge, Falling Edge, Edge)
OVP	When the overvoltage protection function is disable, the OVP mark is gray, when the OVP function is enable, the OVP mark is black, and the mark is red when the OVP function is triggered.
ERR	When reading failure or invalid calibration steps occur, ERR mark will display in status bar.

## Measure Function

### Measurement interface

Display

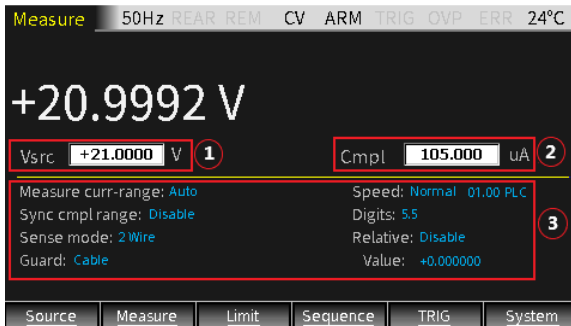

1. The Measure interface is basically the same as the Source (only increase setting items for resistor measurement). The parameter setting area is composed of 3 areas shown as ①②③ in Figure above. Press the Edit/Lock key to switch between ①②③.
2. For the programming of the three areas, please refer to the Source section, see page 20.

**⚠ NOTE: In the case of non-numerical input, operating the number key "7", "4", "1", and "0" keys can correspondingly switch the measurement reading to V-Meter for voltage measurement, I-Meter for current measurement, and resistor measurement  $\Omega$ -Meter or calculation function (Power, CompOhms, Vceoff, VarAlpha, DEV).**



Decription

The GSM can also be set to V-source or I-source under Measure. There are two ways of front and rear output (when REAR markis displayed in the status bar, it means the output is from the rear panel, otherwise the output is from the front panel). The front and rear panels cannot output at the same time.

---

## V/I Meter

---

Setting	Press the F2 (Measure) key to display the measurement interface. Under non-numerical programming, press the 7/V key to set as the voltmeter (Source must be Isrc), or press the 4/I key to select as the current meter (Source must be Vsrc).
Source and compliance value	<p>a, Set Isrc (Voltmeter) or Vsrc (Current Meter) to the lowest range, and then set the value of Isrc or Vsrc to 0 (0.00000uA or 000.000mV).</p> <p>b, Set Cmpl to a level higher than measurement required to test</p> <p>c, Press the output key to start the measurement</p> <p> <b>WARNING :</b>When the GSM is used as a voltmeter, Cmpl must be set to be higher than the voltage that is being measured. It may cause damage due to excessive current flowing into the GSM if this setting is not done.</p>
Set range	<p>When setting Measure volt-range or Measure curr-range, select a range suitable for the voltage or current to be measured. Usually, the lowest possible range should be selected for the best accuracy.</p> <p>When measuring current, select AUTO range, the GSM will automatically go to the most sensitive range. When measuring voltage, do not select AUTO range.</p> <p> <b>WARNING:</b> When the GSM is only used as a voltmeter, do not select AUTO range for measurement, and also do not select a measurement range lower than the voltage to be measured. Because in these two cases, a high current will flow into the GSM from the external</p>

source, which may damage the external source or test circuit.



**NOTE:** When only measuring voltage or current, connect the device under test and the GSM with 2-wire mode.

## Ohmmeter

Measurement interface

Press the F2 (Measure) key, and then press the "1/Ω" key to enter the resistor measurement interface.

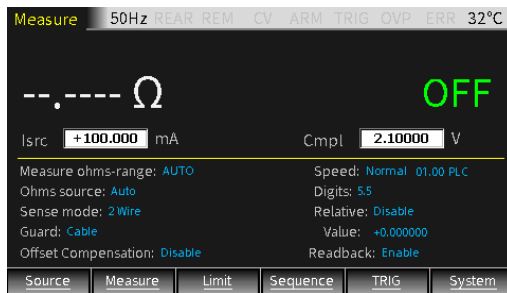

Function

Use Isrc/Vsrc to set the source value when measuring resistor.

When the Ohms source is selected to Auto, the GSM is defaulted as I-Source and operates as a traditional I-Source ohmmeter. When using Auto Ohms source, select a Measure ohms-range or select the AUTO option, and press the Output key to measure the resistor under test. When Auto Ohms source is selected, the default output current depends on the selected Measure ohms-range.

When selecting Ohms source as Manual, you can select GSM as V-Source or I-Source, set the required source value, and select a voltage or current measuring range that is most suitable for

the resistor to be measured to obtain the highest measurement accuracy. Generally, the current range corresponding to the resistor range is as follows:

Range(Ω)	2	20	200	2k	20k	200k	2M	20M	200M
I-Source range	--	100mA	10mA	1mA	100uA	10uA	1uA	1uA	100nA

Cmpl is used to set the compliance value, and the lowest allowable compliance value depends on the load and the source value.

## Calculation

**Description** Long press the F2 (Measure) key, enter the interface for calculation operation, including five function menus: Power, CompOhms, Vceoff, VarAlpha, and DEV.

The Power and DEV functions perform single-point measurements to obtain results.

CompOhms, Vceoff and VarAlpha functions require two-point measurement which require to set two source values, and then the corresponding measurement readings are used to perform calculations.



**Power**

This calculation function calculates power using the measurement voltage reading V and the measurement current reading I, and the unit of the displayed reading is watts.

$$\text{Power} = V * I$$

**CompOhms** Ohm compensation function. The existence of thermoelectric potential affects the measurement accuracy of low value resistor, CompOhms function can be used to reduce the influence of offset voltage. Calculated as follows:  

$$\text{CompOhms } \Omega = (V2 - V1) / (I2 - I1)$$
 V1 represents the voltage measurement reading measured by the first programmed I-Source value, V2 represents the voltage measurement reading measured by the second programmed I-Source value, I1 represents the current measurement reading measured by the first programmed I-Source value, I2 represents the current measurement reading measured by the second programmed I-Source value.

**NOTE:**

1. **The two programmed sources can be set as V-Source or I-Source.**
2. **When pressing the "1" key upon the Measure interface to toggle to the resistor measurement interface, the Offset Compensation option can also set the CompOhms function. When Enable is selected, the ohms compensation function is turned on, and the GSM automatically selects 0 as the second source.**

**Vcoeff** The high value or megohm-level resistors will change as the applied voltage changes. This effect produces a voltage coefficient, which can be expressed by the following formula:

$$\text{Coefficient\%} = [\Delta R / (R2 * \Delta V)] * 100\%$$

in the formula:  $\Delta R = R2 - R1$

$$\Delta V = V2 - V1$$

R1 represents the resistance measured by the first programmed source value, R2 represents the resistance measured by the second programmed source value, V1 represents the voltage measurement reading measured by the first programmed source value, and V2 represents the voltage measurement

reading measured by the second programmed source value. When calculating the  $V_{\text{coeff}}$  value, two voltage source values need to be set.

- VarAlpha** The alpha ( $\alpha$ ) value defines the characteristics of the varistor. The definition of  $\alpha$  value is expressed by the following formula:  

$$\alpha = \log(I_2/I_1) / \log(V_2/V_1)$$
 V1 represents the voltage measurement reading measured by the first programmed I-Source value, V2 represents the voltage measurement reading measured by the second programmed I-Source value, (I2/I1) and (V2/V1) take the absolute value for calculation. When performing VarAlpha calculation, two I-Source values need to be set.
- Dev** Provides the percent deviation between the measurement reading and the reference value set by the user, as expressed by the following formula:  

$$\text{Dev} = [(X - Y) / Y] * 100\%$$
 X represents the displayed measurement reading (voltage, current or resistor), and Y represents the reference value. Y can be manually set by entering a value in the Ref value box. The unit of Y (A, V or  $\Omega$ ) is determined by X.

## Parameter Description and Operation

---

- Vsrc/Isrc/Cmpl** \* The detailed setting operations are the same as the Source chapter description, please refer to page 20
- Measure-range/ Sync cmpl range/ Sense mode** \*The detailed setting operations are the same as the Source chapter description, please refer to page 20.



Speed/Digits/ Relative \*Press “9/S”, “6/D” and “3/R” to quickly operate to set Speed/ Digits/ Relative option

When it comes to resistance measurement, the following parameters require to be programmed as:



**Measure ohms-range** It is used to set a sensitive range for the resistor under test to obtain the best measurement accuracy, or select AUTO that the GSM will automatically go to the most suitable range. There are 9 options for resistance measurement: including 8 ranges 20Ω, 200Ω, 2kΩ, 20kΩ, 200kΩ, 2MΩ, 20MΩ, 200MΩ and Auto.

Setting: Move the cursor to the setting item (it turns into a red letter with a gray background), and press Enter. After the up and down arrow signs appear, operate the up and down direction keys to select the appropriate range, and then press Enter to confirm.

**Ohms source** This option is used to select manual or auto measurement mode when measuring resistance. When selecting Auto, the GSM operates as a traditional I-Source ohmmeter. When the manual mode is selected, the GSM can be switched to V-Source or I-Source. When switching to V-Source, you need to set the values of Vsrc and Cmpl. Please refer to the following comparison table to set Cmpl value:

Range( $\Omega$ )	2	20	200	2k	20k	200k	2M	20M	200M
I-Source range	-	100mA	10mA	1mA	100uA	10uA	1uA	1uA	100nA

Setting: Move the cursor to the setting item (it turns into a red letter with a gray background), and press Enter. After the up and down arrow signs appear, operate the up and down direction buttons to select the appropriate method (Manual or Auto), and then press Enter to confirm.



**NOTE: If selecting Auto, you cannot switch source between Vsrc and Isrc.**

**Offset Compensation** This measurement method is used to minimize the influence of thermoelectric potential when measuring small resistor. The method is to first measure the voltage (V1) and the current (I1) across the resistor using a programmed source value (V-Source or I-Source), and then measure the voltage (V2) and the current (I2) when the source is set to zero. When the source is set to zero, the voltage measured across the resistor is the thermoelectric potential. When Offset Compensation is set to Enable, the resistance of the measured resistor can be calculated by the following formula:

$$R=(V1-V2)/(I1-I2)$$

**Readback** When Readback option selects Enable, the measurement reading are the actual output voltage and current which will be used for resistance calculation. When Readback option selects Disable, the GSM uses the programmed value for resistor calculation, which may produce incorrect measurement values. When the source is in compliance (limited by compliance value), selecting Readback option as Disable can make ohms measurements correct.

---

## Parameter setting of calculation function

---

**Power** This calculation function uses the measurement voltage value multiplying the measurement current value to obtain the Power measurement reading, and the unit of the displayed value is watts.

Operation steps:

- a Press the F2 (Measure) key to enter the Measure interface, select the required source value(V-Source or I-Source), and then long press the F2 (Measure) key to display the calculation function interface.
- b Press the F1 (Power) key to select the Power function (the font turns red).
- c Press F6 (Cancel) to return to the Measure interface.
- d Press the 0/M key to enter the calculation interface, the POWER symbol appears in the display area, indicating that the POWER calculation is performed.
- e Finally, turn on the Output key, and the measurement power value will be displayed.

**CompOhms** Compensation function for resistance measurement.

Operation steps:

- a Press the F2 (CompOhms) key, select CompOhms (the font turns red), and the cursor will automatically jump to the CompOhms (Vs/Is) item.
- b Operate the Enter key, the arrow keys and the number keys to set the values of I1 and I2 in sequence.
- c Press F6 (Cancel) to return to the Measure interface
- d Press the 0/M key to switch to the calculation Measure interface. The CompOhms symbol appears in the display area, indicating that the ohm compensation calculation to be performed.

- e Finally, turn on the Output key, and the measurement resistance will be displayed.

 **NOTE: When programming the value of V1 and V2 (or I1 and I2), the up and down direction keys can switch the range of voltage or current. The value should be set in the most suitable range according to the range of the resistor to be measured. Using voltage V1 and V2 or current I1 and I2 depends on the source of the Measure interface.**

Vceoff      Used to measure the voltage coefficient of high value or megohm resistor.

Operation steps:

- a Press the F3 (Vceoff) key, select Vceoff (the font turns red), and the cursor will automatically jump to the Vceoff item.
- b Operate the Enter key, the arrow keys and the number keys to set the values of V1 and V2 in sequence.
- c Press F5 (Cancel) to return to the Measure interface.
- d Press the 0/M key to switch to the calculation Measure interface. The Vceoff symbol appears in the display area, indicating that the Vceoff to be calculated.
- e Finally, turn on the Output key, and the measurement reading of Vceoff will be displayed.

 **NOTE: When programming the value of V1 and V2, the up and down direction keys can switch the voltage range, and the value should be set in the most suitable range according to the range of the resistor to be measured.**

VarAlpha      Used to measure the varistor  $\alpha$  value.

Operation steps:

- a Press the F4 (VarAlpha) key, select VarAlpha (the font turns red), and the cursor will automatically jump to the VarAlpha item.

- b Operate the Enter key, the arrow keys and the number keys to set the values of I1 and I2 in sequence.
- c Press F5 (Cancel) to return to the Measure interface.
- d Press the 0/M key to switch to the calculation Measure interface. The VarAlpha symbol appears in the display area, indicating that the VarAlpha to be calculated.
- e Finally, turn on the Output key, and the measurement reading of VarAlpha will be displayed.

## DEV

Used to measure the percentage deviation between the measurement reading and the reference value set by the user.

Operation steps:

- a Press the F5 (DEV) key, select DEV (the font turns red), and the cursor will automatically jump to the DEV item.
- b Operate the Enter key, the arrow keys and the number keys to set the Ref value and also HI tol value and LO tol value in sequence.
- c Press F5 (Cancel) to return to the Measure interface.
- d Press the 0/M key to switch to the calculation Measure interface. The DEV symbol appears in the display area, indicating that the DEV to be calculated.
- e Finally, turn on the Output key, and the measurement reading of DEV will be displayed.



**NOTE: Ref value has no unit. The type of measurement reading(V, I,  $\Omega$ ) set in the Measure interface determines the type of Ref value.**

## Measurement Operations

---

- Steps
- Generally there are the following steps:
- a Connect the external test leads (front-panel or rear-panel) according to the requires of the test
  - b For rear-panel output, set it according to System->Control->Rear.
  - c Set Vsrc or Isrc and Cmpl on the front panel
  - d Set other parameters in the parameter area (Measure interface)
  - e Select the required measurement reading V/I/ $\Omega$ /M (corresponding to the buttons 7/V, 4/I, 1/ $\Omega$ , 0/M)
  - f Press the Output button to start the measurement.



**NOTE: After starting the measurement, the measurement function V/I/ $\Omega$ /M can also be toggled.**

## State Description

---

- REAR Display when setting as rear-panel output. Otherwise, it is the front-panel output
- REM Remote control
- CV When the GSM is set as I-Source, in case that the terminal output voltage is restricted by Cmpl or Measure vol-range, the GSM operates in CV (constant voltage) mode  
When the GSM is set as V-Source, in case that the terminal output current is not restricted by Cmpl or Measure cur-range, the GSM operates in CV (constant voltage) mode
- CC When the GSM is set as V-Source, in case that the terminal output current is restricted by Cmpl or Measure curr-range, the GSM operates in CC (constant current) mode  
When the GSM is set as I-Source, in case that the terminal output voltage is not restricted by Cmpl or Measure vol-range, the GSM operates in CC (constant current) mode
- ARM Source-measure operation is in progress
- TRIG Select external trigger source (Tlink, Rising Edge, Falling Edge, Edge)

- OVP      When the overvoltage protection function is disable, the OVP mark is gray, when the OVP function is enable, the OVP mark is black, and the mark is red when the OVP function is triggered.
- ERR      When reading failure or invalid calibration steps occur, ERR mark will display in status bar.

# Limit Function

## Display interface

Description

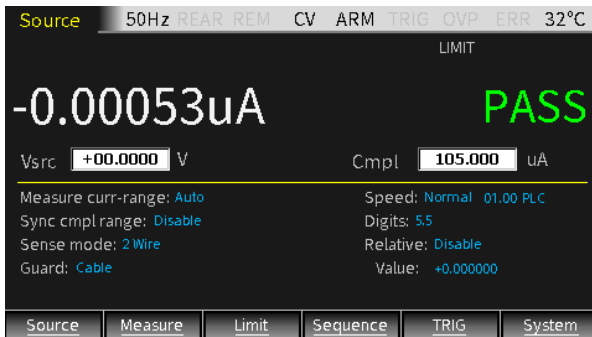

### Limit test classification:

There are three types of limits: compliance value (Cmpl), coarse limit (Limit 2), fine limit (limit 3, 5-12). When Output is ON, pressing the F3 (Limit) key will trigger the operation of the limit function as long as the Limit option is set to Enable, and the **LIMIT** mark will also appear on the display area.

The test procedure is as follows:

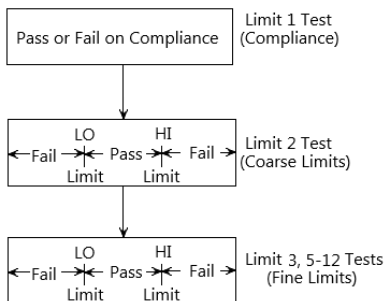

### Limit type:

There are a total of 11 limit tests that can be applied for the DUT. Either limit test can be performed only when it is Enabled. 11 types of limit tests can be performed simultaneously.



**Limit 1 test (compliance):** It is a hardware test, which checks the compliance status of the GSM, and uses the programmed compliance value as the test limit. If the measurement reading is at or above the programmed compliance value, indicating that the GSM is in compliance. If the measurement reading is below the programmed compliance value, indicating that the GSM is not in compliance.

**Limit 2, limit 3 and limit 5-12 test:** are software tests, used to determine whether the DUT is within the specified high and low limits.

Limit 2: Used to test coarse tolerance limits.

Limit 3 and Limit 5-12 : are used to test fine tolerance limits.

#### **Limit mode:**

The composite limit test has two modes:

- GRADING  
Maximum 11 limit tests are performed on the measurement reading until FAIL is detected.
- SORTING  
Maximum 11 limit tests are performed on the measurement reading until PASS is detected.

For Limit 1 test (compliance), the two modes are the same. If Limit 1 does not meet the compliance value limit, FAIL will be displayed in the display area and the test will be terminated. In the case of PASS, it will continue the next Enabled limit tests.

## Parameter description and operation

Setting interface

Long press F3(Limit) button to enter the setting interface as shown in the figure below:

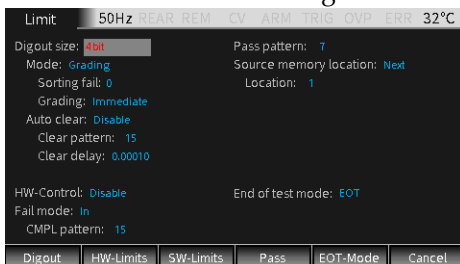

There are 5 sub-menus to be programmed respectively:

- F1 (Digout)
- F2 (HW-Limits)
- F3 (SW-Limits)
- F4 (Pass)
- F5 (EOT-Mode)

### Digout

Size

Used to control the bits number of digital I/O. Choose 3 or 4 or 16 digits. In the 3-bit mode, the fourth line of the digital I/O is selected as the EOT, /EOT, BUSY or /BUSY signal by the End of test option. In 4-bit mode, when the End of test option is set to EOT mode, the fourth line of digital I/O is manually controlled. When the Size is 3-bit, the range of the pattern value is 0-7.

When the Size is 4-bit, the range of the pattern value is 0-15.

When the Size is 16-bit, the range of the pattern value is 0-65535.

Mode

Choose Grading or Sorting mode

**Grading mode:** if a measurement reading has passed the compliance test and is within all HI/LO tolerance

limits, PASS will be displayed.

Sorting fail option cannot be set in Grading mode.

When Grading is set to Immediate, the measurement process will terminate at the first fail situation. If the measurement reading is less than the Low limit of any of Limit 2, 3, 5-12, the I/O port will output the corresponding Lo\_fail value. If the measurement reading is higher than the High limit of any of Limit 2, 3, 5-12, the I/O port outputs the corresponding Hi\_fail value. If HW\_Limits and SW\_Limits are all PASS, the value of Pass pattern will be outputted, and the measurement process will be terminated.

When Grading is set to End, regardless of whether a failure occurs, the test process will proceed to the completion of the software operation. This function can be used to test multiple devices. After the measurement is completed, the bit pattern value after the first failure is output. If all Enabled limit tests pass, the value of Pass pattern will be outputted.

**SORTING mode:** If a measurement reading fails the Compliance Test, or is not within any SW-Limits range, the Limit test will display FAIL. If the measurement reading passes the Compliance Test and only Limit 1 is enabled, the corresponding Pass pattern value will be output. If in addition to Limit 1, SW-Limits also has an item that is Enabled, in the case of Limit test PASS, the I/O port outputs the Lo\_fail value of the first limit test band that passes (Hi\_fail value is ignored).

If Limit 1 fail, the value of CMPL pattern is output. If all limit test bands in SW-Limits fail, the value of the fail pattern is output. When the SORTING mode is selected, the Sorting fail value can be set.

**Auto clear**      Used to select the automatic clear function of the digital output (Enable or Disable). If Enable, you can set the pulse width of the pass/fail pattern (delay 0 to 60s) and the Clear pattern of the digital output (0-7 for 3 digits, 0-15 for 4 digits). After the GSM is powered on, Auto clear is Enabled by default. The sequence of Auto clear is shown in the figure below:

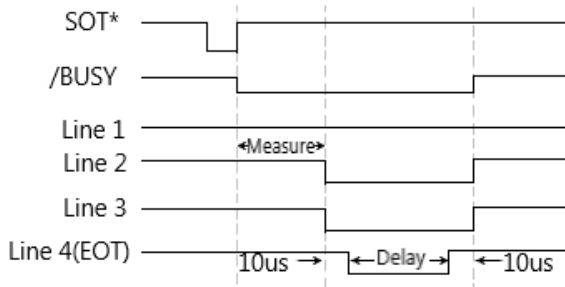

**⚠️ NOTE:** When the trigger event in the trigger mode selects ↓STEST, the SOT signal is a falling edge trigger. When the trigger event in the trigger mode selects ↑STEST, the SOT signal is a rising edge trigger. When the trigger event in the trigger mode selects ↑↓STEST, the SOT signal is a rising or falling edge trigger.

**HW-Limits**

Press F2 (HW-Limits) key to set the fail mode of Limit 1 test.

**H/W-Control**      Used to turn on or turn off the Limit 1 test (Compliance Test).

**Fail mode**      Used to select the fail mode of Limit 1 test.

When selecting In, if the measurement reading is within the compliance limit range, press the F3 key to display the green PASS logo; if the measurement

reading is restricted by the compliance value, press the F3 key to display the red FAIL logo;

When selecting Out, if the measurement reading is within the compliance limit range, press the F3 key to display the red FAIL logo; if measurement reading is restricted by the compliance value, press the F3 key to display the green PASS logo;

**CMPL pattern** Used to set the Fail pattern of Limit 1 test, When the Digout size is 3 bits, the value is 0-7; when the Digout size is 4 bits, the value is 0-15.

**SW-Limits**

Press the F3 (SW-Limits) key to control the enabling of LIM2, LIM3, LIM5-LIM12, High/Low limit range and fail pattern value. The specific settings are shown in the figure below:

Limit	50Hz	REAR	REM	CC	ARM	TRIG	OV	P	ERR	33°C
	Low	Lo_fail	High	Hi_fail						
L02:	Enable	-2.000000_	10	+2.000000_	11					
L03:	Enable	-3.000000_	12	+3.000000_	13					
L05:	Enable	-4.000000_	14	+4.000000_	15					
L06:	Disable	-1.000000_	15	+1.000000_	15					
L07:	Disable	-1.000000_	15	+1.000000_	15					
L08:	Disable	-1.000000_	15	+1.000000_	15					
L09:	Disable	-1.000000_	15	+1.000000_	15					
L10:	Disable	-1.000000_	15	+1.000000_	15					
L11:	Disable	-1.000000_	15	+1.000000_	15					
L12:	Disable	-1.000000_	15	+1.000000_	15					

Digout   HW-Limits   SW-Limits   Pass   EOT-Mode   Cancel

**Disable/Enable** Set the function of LIM2, LIM3, LIM5-LIM12 to Enable.

**Low** Set the low value of the limit range of LIM2, LIM3, LIM5 -LIM12.

**Lo\_fail** Setting the low fail pattern value of LIM2, LIM3, LIM5 -LIM12. When Digout size is 3 bits, the value is 0 to 7, and when Digout size is 4 bits, the value is 0 to 15.

High Set the high value of the limit range of LIM2, LIM3, LIM5 -LIM12.

Hi\_fail Setting the high fail pattern value of LIM2, LIM3, LIM5 -LIM12. When the Digout size is 3 digits, the value is 0 to 7, and when the Digout size is 4 digits, the value is 0 to 15.

## PASS

Press the F4 (Pass) key for the related actions under PASS. Related instructions can refer to page 59.

Pass pattern Used to define the digital output bit value. When the Digout size is 3 digits, the value digits are 0-7, and when the Digout size is 4 digits, the value digits are 0-15. When Mode is set as Grading, output the Pass pattern value in case that all limit tests pass. When Mode is set to Sorting, it is the pass pattern value of Limit 1 (Compliance Test) when SW-Limits are Disable.

Source memory location It is used with SRC-MEM sequence to select the next memory location point in the sequence in the PASS condition. If selecting Next, the next location of the present location in the sequence list is selected. If selecting Location, you can jump to any location from the present location in the sequence list (LOCATION 1 to LOCATION 100) by setting the location number.

Location Specify the branching Location in the sequence list, the range is 1-100. Only need to be set when Source memory location is selected as Location.

## EOT-Mode

End of test mode Define the 4th line of Digital I/O lines as EOT signal or Busy signal.

When EOT is selected, in the case of 3bit Digout size, the fourth line of the Digital I/O lines automatically outputs a HI pulse at the end of test. When the Digout size is 4bit, the End of test signal is not automatically controlled. Need to set Auto clear to Enable.

When /EOT is selected, in the case of 3bit Digout size, the fourth line of the Digital I/O lines automatically outputs a LO pulse at the end of test. When the Digout size is 4bit, the End of test signal is not automatically controlled. Need to set Auto clear to Enable.

When Busy is selected, the operation mode of the GSM is similar to 3bit Digout size mode. Setting the 4th line HI during the Limit test, need to set Arm in Source as Rising edge/Falling edge/Edge.

When /Busy is selected, the operation mode of the GSM is similar to 3bit Digout size mode. Setting the 4th line LO during the Limit test, need to set Arm in Source as Rising edge/Falling edge/Edge.

## External I/O

**Description** The GSM can be connected to an external device through the external DIGITAL I/O port. The DIGITAL I/O port includes 4 output lines and 2 input lines.

**Pin Definition**  
 line5: +3.3V  
 line7: GND  
 line6,8: IDLE

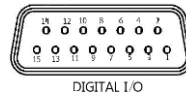

line9: +5V output, used to drive external logic circuits. The maximum output current of this port is 300mA.  
 line10: Start-of-test line, SOT is the input signal.  
 line11: Output enable, OE is the input signal. It is

used with an output enable circuit on a device or test fixture.

line12-line15: 4 output signal ports of Digital I/O ports

**Connection Diagram**

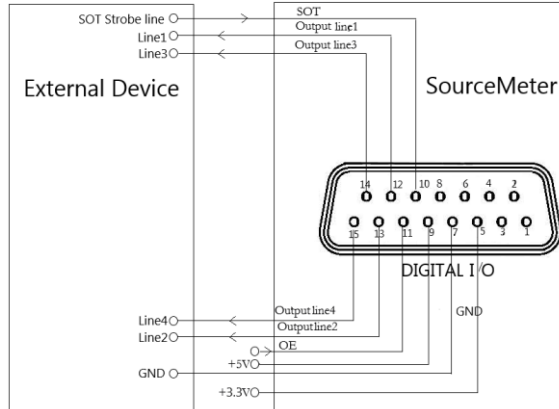

The measurement method shown in the figure above is used to send the pattern values of the limit test.

**Load connection**

Each open-collector output can be set to high level (+5V) or low level (0V), and can source 2mA current or sink 500mA current.

Source operation: Connect an external relay between one of digital output lines and the GND wire. The digital output line must be set to high level to drive the relay. The maximum source current is 2mA. The connection method is shown in the figure below:

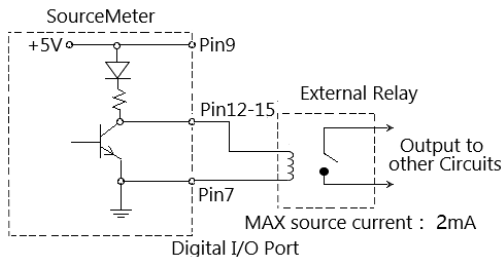

Sink current operation: connect an external relay between one of digital output lines and the +5V power supply. The digital output line must be set to



low level to drive the relay. The maximum sink current is 500mA. The connection method is shown in the figure below:

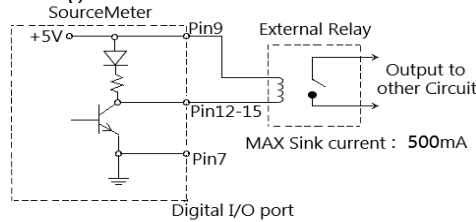

**Output Enable control line**

The digital I/O port provides an output enable control line to be used together with the output switch of a test fixture. When used correctly, the Output of the GSM will turn off if the lid of the test fixture is opened.

As shown in the figure below, when the output enable function is enabled, the output enable line is pulled down if the switch to ground is closed, then the Output of the GSM is turned on. If the lid of the test fixture opens, the switch to ground is opened as well, and the output enable line goes high turning the Output of the GSM off (high-impedance state). Only when the test fixture lid is closed and then press Output button, the output of GSM can be turned on again.

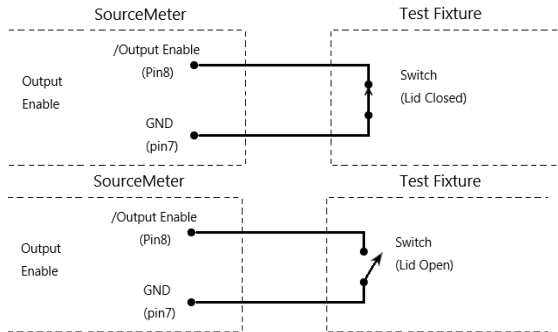



**⚠ NOTE: The Output enable line can be driven**

by Digital I/O. Allow 100us settling and response time. The digital I/O lines are edge-sensitive, open-collector, and signals must be debounced to avoid unstable operation.

## Limit Operation

- Operation** Generally there are the following steps:
- Set up the measurement system. Such as connecting a DUT to the GSM, and can also connecting components to external I/O port according to test requirements.
  - Set source-measure related parameters.
  - Select and set the relevant parameters of Limit test.
  - Select the required measurement reading type V/I/ $\Omega$ /M (corresponding to the buttons 7/V, 3/I, 1/ $\Omega$ , 0/M).
  - Press the Output key to turn on the output, and the GSM will output the programmed voltage.
  - Press F3 (Limit) key to run limit test. If the /SOT line of the digital I/O port is connected to a component, limit test needs to wait for the component to send a pulse to the /SOT line. If the /SOT line is not connected, the limit test will start immediately after pressing the F3 (Limit) key.

 **WARNING:** After starting the test, the measurement function V/I/ $\Omega$ /M can also be toggled.

 **NOTE:** PASS and FAIL indicate the result of each limit test. There are two exceptions:

- When Off state is set to Normal, High impedance, or Guard and limit measurement is turned on, set Auto off to Enable, and POFF or FOFF will be displayed. When Off state is set to Zero and limit measurement is turned on,

whether Auto off is set to Enable or Disable that PZER or FZER will be displayed when Output is turned off.

- If the programmed  $V_{src}$  exceeds OVP, "OVP" is displayed in red on the status bar. At this time, when the Limit function is running, P OVP or F OVP will be displayed accordingly.

## Sequence Function

### Display Interface

**Description** This function can be used when different voltage and current waveforms need to be output in practical applications. Users can program the output waveform according to needs. The amplitude range of the output waveform is the range of output voltage or current of the GSM.

When Output is turned on, press the F4 (Sequence) key to enter the running interface. When running a sequence, the \* symbol will appear on the upper left of the interface, and the presently running sequence type is displayed on the upper right:

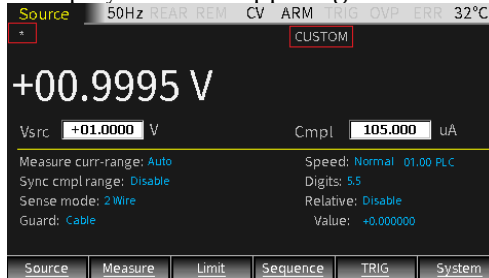

**! NOTE: When Counts option is set to Infinite, that is, when the times of sequence is infinite, the \* symbol will not appear on the upper left of the interface.**

When Output is turned off, press the F4 (Sequence) key to enter the sequence points browsing interface after running. The measurement reading of any point in the Sequence will display by changing the number of Location. When Counts option is set to Infinite, the source-measurement readings can not be review in this interface.

---

## Features

---

There are four types of Sequence: Stair, Log, Custom, and SRC-MEM.

**Stair** The output of the waveform depends on the following parameters: Start value, Stop value, Step (Stair) value, Delay value (Determined by Source delay, trigger delay and Speed which can be set separately).

**Log** The output of the waveform depends on the following parameters: Start value, Stop value, Points (log) number, Delay time (Determined by Source delay, trigger delay and Speed which can be set separately).  **NOTE: The value of logarithmic sequence mode cannot be set as 0.**

**Custom** Custom sequence type. It is necessary to set the number of points and the source value of each sequence point.

**SRC-MEM** Source memory sequence type. For this sequence type, setup configurations of 100 points can be stored in the memory.

When starting sequence, the setup at each memory point can be recalled, allowing multiple functions and math expressions to be used in a sequence.

### Sequence branching

When the the SRC-MEM sequence is performed with limit tests measure the sequence result, the order of the sequence points can be changed. Used to build a different set of tests on the basis of an initial test.

The SRC-MEM sequence can branch to a specified memory location or proceed to the next memory location in the sequence list. When a location is specified, under the PASS condition of limit tests, the sequence will jump to that specified position, and under the FAIL condition of limit

tests, the sequence will jump to the next position in the list. When NEXT is selected in Source memory location, regardless of the limit test PASS or FAIL, the sequence will proceed to the next position in the list.

The figure below shows a seven-point sequence branching. Indicating how the unit is programmed to branch to location 8 when a PASS condition occurs at location 3.

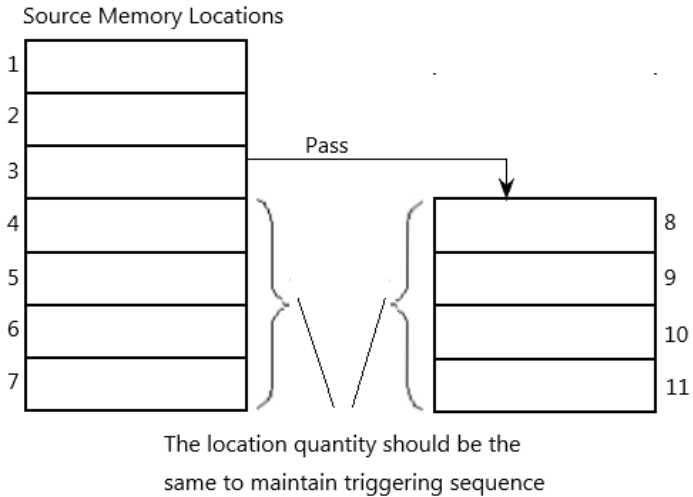

Be careful when branching, because you may unintentionally create an infinite memory loop. No matter how many branches are performed, the point number of the SRC-MEM sequence is the setting value of TRIG count.

The SRC-MEM sequence branching can be set in the Source memory location and Location options in the PASS section of the Limit chapter.

**! NOTE: When the limit tests is FAIL, only the instruction: CALCulate2:CLIMits:FAIL:SMLocation <NRf> | NEXT can be used to set the branch location.**

## Parameter Description And Operation

- Description There are 2 ways to enter the parameter setting interface of Sequence:
- a Long press the F4 (Sequence) key.
  - b When Output is turned off, press the F4 key to enter the Sequence data browsing interface, and then press the F1 (Setting) key to enter.

Waveform selection



Click the F1-F4 buttons to select the desired waveform (the corresponding Type name changes from white to red).

### Stair/Log waveform parameters

- Start** Set the start point of the Stair/Log output waveform, Vsrc or Isrc depends on the source type of main interface.
- Stop** Set the stop point of the Stair/Log output waveform, Vsrc or Isrc depends on the source type of main interface.
- Step (Stair)** Set the step value of the Stair output waveform, Vsrc or Isrc depends on the source type of main interface.
- Point (Log)** Set the point number of the Log output waveform.

## SRC-MEM waveform parameters

Start location The points number of SRC-MEM sequence: 1 to 100.

Memory save operation:

- a Press the F6 (System) key on the main interface, and then press the F2 (Control) key to enter the following interface:



- b Move the cursor to the Memory save option box, press Enter, enter a number between 1-100, and press Enter, the following dialog box appears:

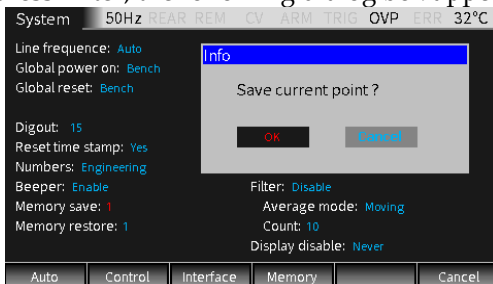

- c Move the cursor to OK button and press Enter to store the settings of the present Source interface in the memory location indicated by the number in the Memory save box.
- d If you need to view the parameter settings of the point in a sequence which stored in the specified location of the memory, move the cursor to the Memory restore option box:



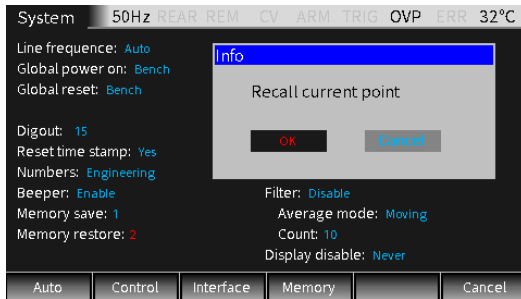

- e Press Enter, enter a number between 1-100, press Enter, the following dialog box appears, move the cursor to OK button and press Enter, which means to recall the settings in the corresponding memory location indicated by the number in the Memory restore box to present Source interface.

**Points** SRC-MEM memory sequence points, value: 100-Start location.

**Custom waveform**

Custom sequence type. Used to set the number of measurement points in the sequence and the source level of each point.

**Number of points** Used to set the number of measurement points in the sequence.  
 Setting: Press the F3 (Custom) key, the cursor jumps to the Number of points option box, press Enter key enter the editing state, input the required number (0 to 2499) and press Enter to confirm.

**V/I Edit** There are two ways: Block Edit (setting the points in the block to the same source level) and Single Edit.

Press the F2 (Block) key, the cursor jumps to the Start point, set the start position, set the end position in the Stop point option and set the source level in the Value box, and the source level of the points set in the Block are the same.

Press the F3 (Single) key to set the parameters of a single point.

The time parameters are determined by Source delay, trigger delay and Speed which can be set separately.

### Other Parameters

- Counts** Set the sequence times, you can choose Finite or Infinite.  
**Finite:** Indicates that the number of sequence times is limited.  
 maximum Finite sequence times = 2500/Points in sequence  
**Infinite:** Indicates that the number of sequence times is unlimited.
- SRC-range** Used to control the range of the source, you can choose Bestfixed, Fixed or Auto-range, the meaning of each option is as follows:
- Bestfixed:** Means that a range suitable for all points in the sequence is automatically selected.  
**Fixed:** Means to keep the source remain on the range when the sequence is started. When the sweep points exceed the source range, the maximum level of the range will be output.  
**Auto-range:** Means that the most suitable source range is automatically selected for each point in the sequence.
-  **NOTE: Frequent range changes of Auto-range may cause transients. If these transients are not allowed, selecting Bestfixed option.**
- CMPL-abort** Set the interrupt mode when the measurement reading is not within the compliance range during the sequence process. There are three types:

**Never:** Interrupt is prohibited.

**Early:** Indicates that when the measurement reading is not within the compliance range, an interruption occurs at the beginning of the SDM cycle.

**Late:** Indicates that when the measurement reading is not within the compliance range, an interruption occurs at the end of the SDM cycle.

**Store time stamp** The time stamp for storing the first measurement reading in the buffer (#0000) is marked as 0000000.000s. The buffer of GSM can store 2500 source-measure readings. Each source-measure reading is assigned a storage address and a time stamp.

The value of Store time stamp has two meanings:

1. When running the four sequence types of Stair, Log, Custom, and SRC-MEM, the Store time stamp is the actual number of sequence points.
2. If you need to run the sequence with the current source value, when the Output is turned on, long press the F4 (Sequence) key to enter the sequence Setting interface, set the required value in the Store time stamp option box, and press the Enter key to confirm, it will immediately run the sequence, the number of sequence points is the setting value of the Store time stamp.

**Time stamp type** Set the timing mode. There are two timing modes: Absolute and Delta.

**Absolute:** Represents the cumulative sequence time of all points reference to 0s.

**Delta:** Indicates the sequence time of single point.

## Sequence Output

---

Operation Generally there are the following steps:

- a Connect the external connection (front panel or rear panel) according to the requirement of test.
- b For rear panel output, set it by System->Control->Rear.
- c Set Vsrc or Isrc and Cmpl on the front panel.
- d Set other parameters in the parameter area (Sequence interface).
- e Select the desired waveform.
- f Press the Output button and the F4 (Sequence) key to start outputting the waveform until the last point, and then press the Output button to turn off the output.

## TRIG Function

### Programming Interface

Description Long press the F5 (TRIG) button on the main interface to enter the TRIG function setting interface:

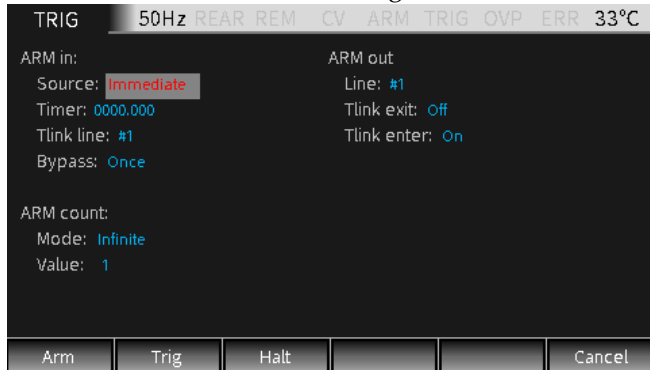

## Trigger process

The trigger mode is composed of the ARM layer and TRIG layer. The process is shown in the figure below:

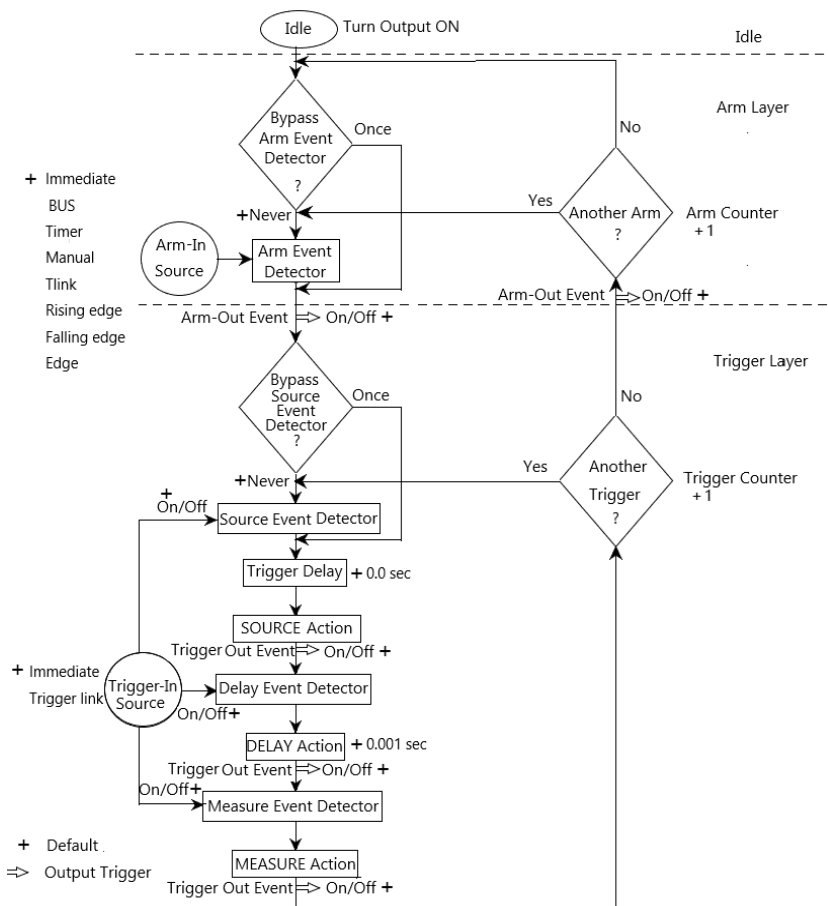

## Parameter Description And Operation

**ARM Layer** Press the F1(Arm) button, setting the Arm layer of the TRIG mode, and set the options in the ARM in, ARM count and ARM out.

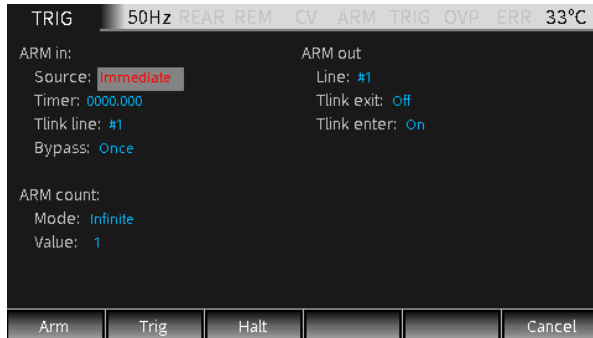

### ARM in

Source

Used to select the trigger source of the Arm layer. It can be set as Immediate, GPIB, Timer, Manual, Tlink, Rising edge, Falling edge, Edge, the specific description is as follows:

**Immediate:** Event detection occurs immediately allowing operation to continue.

**BUS:** Event detection occurs when a bus trigger (GET or \*TRG) command is received.

**Timer:** Select Timer mode, when Output is turned ON, event detection occurs immediately. When it passes "Another Arm? Yes", event detection occurs when the programmed timer interval is full. If it passes "Another Arm? No", the Timer resets allowing event detection to again occur immediately.

**Manual:** Used for manual TRIG. After selecting this option, **TRIGM** will be displayed on the measurement interface, and when Output is

turned ON, manually press the F5 (TRIG) key once, the event detection will be triggered to run once.

**Tlink:** When an input trigger is received through the Trigger Link input line, event detection occurs. When selecting Tlink, you can bypass the Arm Event Detector by selecting the Bypass option to ONCE.

**Rising edge:** Event detection occurs when the SOT line of the Digital I/O port is pulsed high. This pulse comes from an external component and is used to start limit test.

**Falling edge:** Event detection occurs when the SOT line of the Digital I/O port is pulsed low. This pulse comes from an external component and is used to start limit test.

**Edge:** Event detection occurs when the SOT line of the Digital I/O port is pulsed low or high. This pulse comes from an external component and is used to start limit test.

**Timer** Used to set the Timer interval when the Source option is set to Timer mode, the timing unit is second.

**Tlink line** This option needs to be set only when the Source option is selected as Tlink, which is used to set the required line (#1, #2, #3, or #4) of input trigger signal. Line 2 is the output line by default, and line 1 is the input line by default.



- Bypass** Event detector bypass is valid when the Source option is set to Tlink, Rising edge, Falling edge and Edge. There are two options:
- Never:** Indicates to wait for an input trigger before performing the operation.
  - Once:** Indicates that the operation bypasses the Arm event detector and directly enters the trigger layer.



**NOTE: The F5 (TRIG) key in the main interface has the highest priority. An event will be triggered as long as you press this key.**

### ARM count

- Mode** Two options of Finite and Infinite are available.
- Finite:** Indicates that the number of the ARM count is a certain value.
  - Infinite:** Indicates that the number of the ARM count is unlimited.
- Value** When Finite is selected, set the sepecified number.

### ARM out

- Line** To select the Tlink line (#1, #2, #3, or #4) to output the trigger signal.
- Tlink exit** Can be set to On or Off.
- On:** Indicates that an output trigger signal is allowed when entering the Trigger layer from the Arm layer or entering the Arm layer from the Trigger layer.
  - Off:** Indicates that an output trigger signal is prohibited when entering the Trigger layer from the Arm layer or entering the Arm layer from the Trigger layer.

- Tlink enter** Can be set to On or Off.
- On:** Indicates that trigger action is allowed when entering the Trigger layer.
  - Off:** Indicates that the trigger action is prohibited when entering the Trigger layer.

**Trigger Layer** Press the F2 (Trig) button to select the Trigger layer of the trigger mode, and set the options in TRIG in, TRIG delay and TRIG out. As shown below:

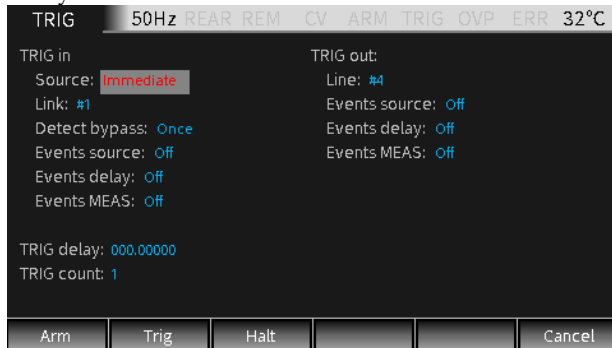

## TRIG in

**Source** Select the trigger source of the Trigger layer, which can be set as Immediate or Trigger link.

**Immediate:** Indicates that the event is triggered immediately. When this option is selected, source event detector, delayed event detector and measurement event detector will run immediately. The Trigger layer executes the source, delay, and measurement actions in sequence.

**Trigger link:** If you select this option, you need to set these 5 items of Link/Detect bypass/Events source /Events delay/ Events MEAS.

**Link** To select the input line of the trigger signal, one of the 4 lines (#1, #2, #3, #4) can be selected.

Detect bypass	Used to set whether to bypass the source event detector, you can choose Once or Never. <b>Once:</b> Indicates that the operation will bypass the event detector. <b>Never:</b> Indicates that the event detector needs to wait for an input trigger signal before performing subsequent operations.
Events source	Enable (On) or disable (Off) trigger-in source. <b>On:</b> Indicate that operation will wait at that event for an input source trigger. <b>Off:</b> Indicate that operation will not wait and it will continue to perform the subsequent operations.
Events delay	Enable (On) or disable (Off) trigger-in delay. <b>On:</b> Indicate that operation will wait at that event for an input delay trigger. <b>Off:</b> Indicate that operation will not wait and it will continue to perform the subsequent operations.
Events MEAS	Enable (On) or disable (Off) trigger-in MEAS. <b>On:</b> Indicate that operation will wait at that event for an input MEAS trigger. <b>Off:</b> Indicate that operation will not wait and it will continue to perform the subsequent operations.

### TRIG out

Line	To select the Tlink line (#1, #2, #3 or #4) that outputs the trigger signal.
Events source	It is used to enable (On) or disable (Off) the output triggers after the source operations.
Events delay	It is used to enable (On) or disable (Off) the output triggers after the delay operations.
Events MEAS	It is used to enable (On) or disable (Off) the output triggers after the measure operations.

**TRIG delay** Set the delay time for the trigger delay, the default unit is seconds.

**TRIG counts** Set the number of trigger times.

## HALT

**Description** Press F3 (HALT) button to return the GSM to idle state, it does not turn off Output, and the programmed source will still be output. The following three operations can make the GSM out of the idle state.

- Turn off Output first, then turn on Output.
- Reselect the Arm in event or Trigger in event.
- Return from the TRIG setting menu, and then long press the F5 (TRIG) button to enter the TRIG setting menu.

## Interface Requirements

**Pin definition** When the TRIG function is enabled, it is associated with the corresponding I/O ports, described as below.

line1 - line4: As the input trigger signal and output trigger signal line of the Arm layer and the Trigger layer.

line5: +3.3V

line6: Idle line

line7: GND

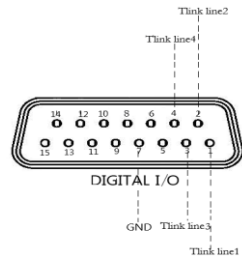

**!** **NOTE:**The factory default line1 is the input trigger signal line, and line2 is the output trigger signal line. These input and output lines can be changed in the Arm and Trig setting interface.

Instructions • line1-line4 input trigger requirements

The input trigger is used to trigger the event detector of the Arm layer or the Trigger layer of the trigger model.

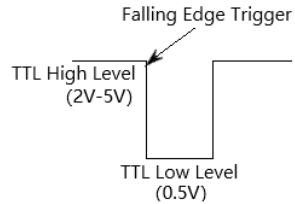

Input trigger is falling edge trigger, TTL compatible pulse level.

• line1-line4 output trigger specifications

The GSM can be set to output a trigger signal after multiple trigger actions.

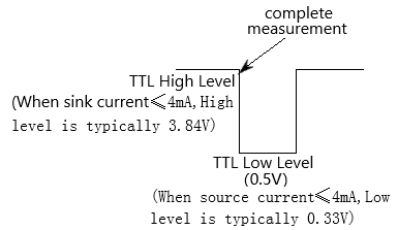

Output trigger provides a TTL compatible pulse level that can be used to trigger other peripherals.

# SYSTEM SETTINGS

## Range Limitation

---

Click F6 (System) button on the main interface to enter the System setting interface. It has four submenus: Auto, Control, Interface, and Memory.

### Auto

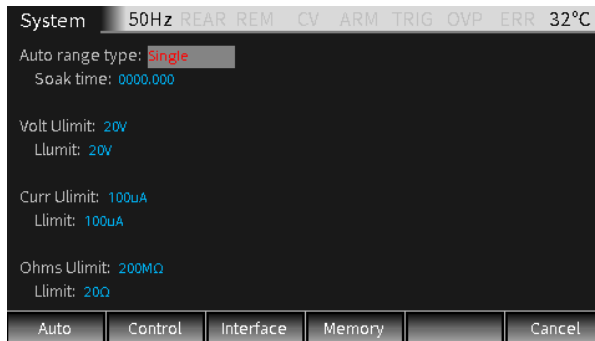

**Auto range type** There are two options, Single and Multiple, which determine the way the GSM automatically obtains the range.

**Single:** Indicates that the GSM will auto acquire the range only after reading a value for the first time.

**Multiple:** Indicates that the GSM will auto range up on the Cmpl value during the Delay phase of the SDM cycle to minimize the possibility that the GSM will be in compliance in a multiple GSM system. As long as the GSM taking a measurement reading, it will perform a downrange action.

**Soak time:** Soak time needs to be set only

when Auto range type is set as Multiple. It is used to set the total time after the first point of a sequence that the GSM will sit in a loop actively auto up and down the range during the first SDM cycle after the initial sequence trigger. This is useful for situations with long DUT settling time(such as measuring low current ) that requires several downrange cycles from higher ranges.

**Setting range:** 0 seconds to 9999.999 seconds.

- |                |  |
|----------------|--|
| Volt limit     | <p><b>Ulimit:</b> voltage upper limit is determined by the compliance value set on the present Source interface.</p> <p><b>Llimit:</b> The lower limit of voltage is set to a voltage value that is not greater than the upper limit of voltage.</p> |
| Curr limit     | <p><b>Ulimit:</b> The upper limit is determined by the compliance value set on the present Source interface.</p> <p><b>Llimit:</b> The lower limit of current is set to a current value that is not greater than the upper limit of current.</p>     |
| Ohms<br>Ulimit | <p><b>Ulimit:</b> The upper limit of the Ohms can be set manually.</p> <p><b>Llimit:</b> The lower limit value of the Ohms is set to a value not greater than the upper limit value.</p>   |

# System Parameters

## Control

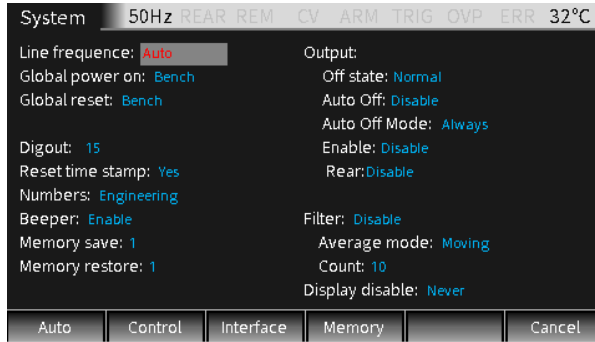

**Line frequency** Set the power line frequency according to the frequency of the power supply. It can be set as Auto, 50Hz or 60Hz. When setting to Auto, the GSM will detect the power line frequency and set it automatically when power on. When there is a lot of interference on the power line, you can manually set the frequency to avoid automatic detection of the wrong frequency that will affect the measurement result.

**Global power on** It is used to define whether the power-on setup is to use factory settings (users cannot modify) or custom settings. The factory settings is Bench and GPIB. Custom settings include four memory configuration methods of Save0, Save1, Save2, Save3.

**Global reset** Used to select Bench or GPIB to return factory settings.

**Digout** It is used to set the high or low level of the four digital I/O lines. The corresponding decimal values are as follows, for details on setting the Digout bit, see page 48.



Digout bit	3	decimal range	0-7
Digout bit	4	decimal range	0-15
Digout bit	16	decimal range	0-65535

**Reset time stamp** Used to reset the time stamp when exiting the idle state. There are two options, Yes or No.

**Yes:** In the trigger mode, when exiting the idle mode, the time stamp is allowed to be reset automatically.

**No:** In the trigger mode, when exiting the idle mode, the time stamp is not allowed to be reset automatically.

**Numbers** Used to select Engineering units or scientific notation to display the measurement reading. The measurement reading can be fixed or floating-point format.

**Beeper** Used to select Enable or Disable touch-tone, the factory default is Enable.

**Memory save** Used for source memory sequence setup configurations. Up to 100 setups can be stored. Enter the number (1-100) in the option box and press Enter to save the present setup in the corresponding location in the memory.

The stored setups can be recalled directly (operate by Memory restore) or recall multiple setups continuously (see the SRC-MEM chapter on page 62 for details)

**Memory restore** It is used to recall the setups in the memory. Up to 100 setups can be recalled. Enter the number (1-100) in the option box and press Enter to recall the setup information stored in the corresponding location in the memory to the Source interface.

**Output** There are several parameters related with Output required to be set here: Off state, Auto off, Enable, Front/Rear Output.

Off state: Used to select the off state of the Output terminal. There are four options: High impedance, Normal, Zero and Guard.

**High impedance:** In this Output-off state, when the Output is turned off, the output relay will open, disconnecting the Input/Output terminal from the external circuit. In order to prevent excessive loss of output relay, this output-off state is not used for tests that require output off and on frequently.



**NOTE: The High impedance Output-off function can only be executed when the Auto-off function is enabled.**

**Normal:** When in the relatively high impedance Output-off state, the V-Source is selected and set to 0V, and the current compliance value is set to 0.5% full scale of the present measure curr-range. Theoretically, when the V-Source is set to 0V, the GSM does not output voltage. In fact, the voltage value is not an accurate zero value. Therefore, the GSM can still output a tiny voltage. In most cases, the voltage is very small.

**Zero:** When in this Output-off state, ZER will be displayed (instead of OFF), and the GSM will be set according to the following steps.

When selected as V-Source:

- The programmed V-Source value remains displayed.
- Internally, the V-Source is set to 0V.

- The current compliance value setting remains the same as the output-on value, and the Real and range compliance detection functions remain valid.
- Measurements are still performed and displayed.

When selected as I-Source:

- The programmed I-Source value remains displayed
- Internally, select as V-Source and set the voltage to 0V
- The current compliance is set to the larger value of the programmed I-Source value and 0.5% full scale of the present measure curr-range
- Measurements are still performed and displayed

When the GSM is in the Zero Output-off state, it can be used as an amperemeter.



**WARNING:** When selecting Zero and Auto off option to generate quick pulsed waveforms, dangerous voltage (>30V rms) can appear on the Input/Output LO terminal. To eliminate the risk of electric shock, connect the LO terminal to the earth ground. When using the front panel, connect the LO terminal of the front panel to the ground. When using the rear panel, connect the LO of the rear panel to the ground. The ground can be selected from the ground screw on the rear panel or other safety ground.

**Guard:** In the Guard Output-off state, I-Source is selected and set the output current to 0A. The voltage compliance value is set to 0.5% full scale of the present measure volt-range. When making 6-wire guard ohms measurement or

for other loads that use power, you should select the GUARD Output-off state.



1. **When using Off state option to change the output-off state, it will immediately change to the selected state.**
2. **When power on, the GSM will instantly enter the HIGH IMPEDANCE output-off state, and then enter the default Normal Off state.**
3. **If an overheating condition or interference on the OE line occurs, the GSM will enter the HIGH IMPEDANCE output-off state.**

Output off state and inductive load: The output-off state selected when the inductive load is loaded depends on the power of the inductive load itself. NORMAL output-off state reduces the compliance value setting and is not suitable for inductive loads. ZERO or GUARD is more suitable. The ZERO output-off state does not change the compliance value setting. The GUARD output-off state changes the voltage source to a current source and sets the voltage compliance value at the same time. GUARD output-off state is mainly used for guarded ohms measurement. In order to prevent the GSM from being damaged by the inductive load, this application needs to connect a spark discharge tube between INPUT HI and LO.

**Auto off:** Used to Enable or Disable "output automatic off" function.

Enable: Output will be turned off after the end of the measurement phase of each SDM cycle. Output will be turned on again at the beginning of the next SDM cycle.

Disable: Output remains on as long as the GSM operates in the trigger mode (the ARM symbol is displayed).



**NOTE: In the case of Enable, pressing the Output key will turn off the Auto off function (it becomes the Disable state).**

**Enable:** Enable or Disable the output enable function (/OE line). Enable or Disable Output when the GSM is connected to the DUT or test fixture equipped with a switch controlled by lid. For details, see External I/O port operation on page 53 of the Limit chapter.

**Enable:** Turn on the output enable function. The output of the GSM is controlled by the input signal of /OE line.

**Disable:** Turn off the output enable function.

**Rear:** Used to select the rear-panel output.

**Enable:** Input/Output is performed from the rear panel.

**Disable:** Input/Output is performed from the front panel.

**Filter** Used to turn on (Enable) or turn off (Disable) the output filter.

**Average mode:** When Filter is set as Enable, you need to set this option. It is used to select the method how the filter handles the measurement readings with interference. There are two Average methods: Moving and Repeat:

**Moving:** Use the first-in first-out method. When the stack is full, take the average of the measured value, which is the measurement reading in the display area. For each

subsequent measured value put into the stack, taking the new average value as the measurement reading.

**Repeat:** When this option is selected, you need to wait until the stack is full, then average the measured value in the stack before clear these value, then take the average value after the stack is full next time, and repeat this process.

**Count:** Used to set the amount of stack value involved in the average calculation, from 1 to 100 data amounts can be set.

### Display disable

It is used to select the front panel display to be disabled in the following situations. When the front panel display is disabled, the prompt interface as shown in the figure below will appear:

**Now:** Indicates that the front panel display is disabled immediately.

**Never:** Indicates that the front panel display is never disabled.

**Sequence:** Indicates that the front panel display is disabled when sequence is running. When the sequence starts running, the front panel display is immediately disabled and it will be automatically enabled when the sequence completes.

**Store:** Indicates when the number of storage which is used to store source-measurement readings in the buffer is set (Store time stamp), the front panel display will be disabled immediately. When the buffer is enabled, the front panel display will be disabled and it will be re-enabled after the storage is complete. Note that when you select this option, the display will be disabled when sequence is running, the

source-measurement readings of the sequence will be automatically stored in the buffer.

# Specifications

The specifications apply under the following conditions: The GSM-20H10 is powered on for at least 30 minutes, within +18°C~+28°C.

Maximum	Voltage	±210V
	Current	±1.05A
	Power	22W
	Voltage Resolution	1uV
	Current Resolution	10pA
DC Voltage Source	Output Voltage	±21V/ ±1.05A, ±210V/±105 mA
	Current Limit	Min. 0.1% of range
	Programming Resolution	1uV, ±200.000mV range
		10uV, ±2.00000V range
		100uV, ±20.0000V range
		1mV, ±200.000V range
	Programming Accuracy <sup>1</sup>	±(0.02%+600uV), ±200.000mV range ±(0.02%+600uV), ±2.00000V range ±(0.02%+2.4mV), ±20.0000V range ±(0.02%+24mV), ±200.000V range
	Load Regulation	0.01% of range + 100uV
	Line Regulation	0.01% of range
	Overshoot	<0.1% typical (full scale step,resistive load,10mA range)
	Recovery Time(1000%Load Change)	<250us (within 0.1% plus load regulation errors, 1A and 100mA compliance.)
	Ripple and Noise	4mV rms(20Hz~ 1MHz)
		10mVpp(20Hz~ 1MHz)
Temperature Coefficient (0°-18°C & 28°-50°C)	±(0.15 × accuracy specification)/°C	
DC Current Source	Output Current	±1.05A /±21V, ±105 mA /±210V
	Voltage Limit	Min. 0.1% of range
	Programmed Source Resolution	10pA, ±1.00000uA range
		100pA, ±10.0000uA range
		1nA, ±100.000uA range
		10nA, ±1.00000mA range
		100nA, ±10.00000mA range
1uA, ±100.000mA range		
10uA, ±1.00000A range		



	Programmed Source Accuracy <sup>1</sup>	$\pm(0.035\%+600\text{pA})$ , $\pm 1.00000\text{uA}$ range $\pm(0.033\%+2\text{nA})$ , $\pm 10.0000\text{uA}$ range $\pm(0.031\%+20\text{nA})$ , $\pm 100.000\text{uA}$ range $\pm(0.034\%+200\text{nA})$ , $\pm 1.00000\text{mA}$ range $\pm(0.045\%+2\text{uA})$ , $\pm 10.00000\text{mA}$ range $\pm(0.066\%+20\text{uA})$ , $\pm 100.000\text{mA}$ range $\pm(0.27\%+900\text{uA})$ , $\pm 1.00000\text{A}$ range
	Load Regulation	0.01% of range + 100pA
	Line Regulation	0.01% of range
	Overshoot	<0.1% typical (1mA step, RL = 10k $\Omega$ , 20V range).
	Temperature Coefficient (0°-18°C & 28°-50°C)	$\pm(0.15 \times \text{accuracy specification})/^{\circ}\text{C}$
Source General	Output Settling Time <sup>2</sup>	100 $\mu\text{s}$ typical Time
	Output Rise Time ( $\pm 30\%$ )	300 $\mu\text{s}$ , 200V range, 100mA compliance. 150 $\mu\text{s}$ , 20V range, 100mA compliance.
	DC Floating Voltage Remote Sense	Output can be floated up to $\pm 250\text{VDC}$ Up to 1V drop per load lead.
	Compliance Accuracy	Add 0.3% of range and $\pm 0.02\%$ of reading to base specification.
	Range Change Overshoot <sup>3</sup>	Adjacent range changes between 200mV, 2V and 20V ranges, 100mV typical.
	Minimum Compliance value	0.1% of range
	Command Processing Time <sup>4</sup>	Autorange On:10ms.Autorange Off:7ms.
	Measurement Voltage	Input Resistance
Measurement Resolution		1 $\mu\text{V}$ , $\pm 200.000\text{mV}$ range 10 $\mu\text{V}$ , $\pm 2.00000\text{V}$ range 100 $\mu\text{V}$ , $\pm 20.0000\text{V}$ range 1mV, $\pm 200.000\text{V}$ range
Measurement Accuracy		$\pm(0.012\%+300\text{uV})$ , $\pm 200.000\text{mV}$ range $\pm(0.012\%+300\text{uV})$ , $\pm 2.00000\text{V}$ range $\pm(0.015\%+1.5\text{mV})$ , $\pm 20.0000\text{V}$ range $\pm(0.015\%+10\text{mV})$ , $\pm 200.000\text{V}$ range
Temperature Coefficient (0°-18°C & 28°-50°C)		$\pm(0.15 \times \text{accuracy specification})/^{\circ}\text{C}$
Measurement Current		Voltage Burden (4-wire mode)
	Programmed Source Resolution	10pA, $\pm 1.00000\text{uA}$ range 100pA, $\pm 10.0000\text{uA}$ range 1nA, $\pm 100.000\text{uA}$ range 10nA, $\pm 1.00000\text{mA}$ range 100nA, $\pm 10.00000\text{mA}$ range 1 $\mu\text{A}$ , $\pm 100.000\text{mA}$ range 10 $\mu\text{A}$ , $\pm 1.00000\text{A}$ range

	Programmed Source Accuracy <sup>1</sup>		±(0.029%+300pA), ±1.00000uA range ±(0.027%+700pA), ±10.0000uA range ±(0.025%+6nA), ±100.000uA range ±(0.027%+60nA), ±1.00000mA range ±(0.035%+600nA), ±10.00000mA range ±(0.055%+6uA), ±100.000mA range ±(0.22%+570uA), ±1.00000A range ±(0.1 × accuracy specification) / °C	
	Temperature Coefficient (0°-18°C & 28°-50°C)		±(0.1 × accuracy specification) / °C	
Measurement Resistance	Range	Resolution	Test current	Accuracy
	<2.00000Ω	---	---	Source IACC+Meas.VACC
	2.00000Ω	10uΩ	---	Source IACC+Meas.VACC
	20.0000Ω	100uΩ	100mA	±(0.1%+0.003 Ω), Normal ±(0.07%+0.001 Ω), Enhanced
	200.000Ω	1mΩ	10mA	±(0.08%+0.03 Ω), Normal ±(0.05%+0.01 Ω), Enhanced
	2.00000kΩ	10mΩ	1mA	±(0.07%+0.3 Ω), Normal ±(0.05%+0.1 Ω), Enhanced
	20.0000kΩ	100mΩ	100uA	±(0.06%+3 Ω), Normal ±(0.04%+1 Ω), Enhanced
	200.000kΩ	1Ω	10uA	±(0.07%+30 Ω), Normal ±(0.05%+10 Ω), Enhanced
	2.00000MΩ	10Ω	5uA	±(0.11%+300 Ω), Normal ±(0.05%+100 Ω), Enhanced
	20.0000MΩ	100Ω	0.5uA	±(0.11%+1k Ω), Normal ±(0.05%+500 Ω), Enhanced
	200.000MΩ	1kΩ	100nA	±(0.66%+10k Ω), Normal ±(0.35%+5k Ω), Enhanced
	>200.000MΩ	---	---	Source IACC+Meas.VACC
		Temperature Coefficient (0°-18°C & 28°-50°C)		±(0.15 × accuracy specification)/°C
		Source I mode, Manual OHMS	Total uncertainty = I source accuracy + V measure accuracy (4-wire remote sense).	
	Source V mode, Manual OHMS	Total uncertainty = V source accuracy + I measure accuracy (4-wire remote sense).		
	6-wire OHMS mode	Available using active ohms guard and guard sense. Max. Guard Output Current: 50mA (except 1A range). Accuracy is load dependent.		
	Guard Output Impedance	<0.1Ω in ohms mode		

System Speed <sup>5</sup>	Maximum Measure	40ms (fixed source) <sup>6</sup>				
	Auto Range Time					
	Sequence reading rates <sup>7</sup> (rdg./second) for 60Hz (50Hz)					
	Speed	NPLC/ Trig Origin	Measure	Source-Measure <sup>9</sup>	Measure Memory <sup>9</sup>	
			TO MEM.	TO GPIB	TO MEM.	
			TO GPIB	TO MEM.	TO GPIB	
	Fast	0.01 / internal	2081 (2030)	1198 (1210)	1551 (1515)	1000 (900)
	488.2	0.01 / external	1239 (1200)	1079 (1050)	1018 (990)	916 (835)
	Medium	0.1 / internal	510 (433)	509 (433)	470 (405)	470 (410)
	488.2	0.1 / external	438 (380)	438 (380)	409 (360)	409 (365)
Normal	1 / internal	59 (49)	59 (49)	58 (48)	58 (48)	
488.2	1 / external	57 (48)	57 (48)	57 (48)	57 (47)	
Speed	NPLC/ Trig Origin	Source-Measure Pass/Fail test <sup>8,9</sup>	Measure Memory <sup>9</sup>			
		TO MEM.	TO GPIB	TO MEM.	TO GPIB	
		TO GPIB	TO MEM.	TO GPIB	TO MEM.	
Fast	0.01 / internal	902 (900)	809 (840)	165 (162)	164 (162)	
488.2	0.01 / external	830 (830)	756 (780)	163 (160)	162 (160)	
Medium	0.1 / internal	389 (343)	388 (343)	133 (126)	132 (126)	
488.2	0.1 / external	374 (333)	374 (333)	131 (125)	131 (125)	
Normal	1 / internal	56 (47)	56 (47)	44 (38)	44 (38)	
488.2	1 / external	56 (47)	56 (47)	44 (38)	44 (38)	
<b>Single Reading Operation Rates (rdg./second) for 60Hz (50Hz)</b>						
Speed	NPLC/ Trig Origin	Measure	Source-Measure <sup>9</sup>	Source-Measure Pass/Fail test <sup>8,9</sup>		
		TO GPIB	TO GPIB	TO GPIB		
Fast(488.2)	0.01 / internal	256 (256)	79 (83)	79 (83)		
Medium(488.2)	0.1 / internal	167 (166)	72 (70)	69 (70)		
Normal(488.2)	1 / internal	49 (42)	34 (31)	35 (30)		
<b>Component Interface Handler Time for 60Hz (50Hz):<sup>8,10</sup></b>						
Speed	NPLC/ Trig Origin	Measure	Source Pass/Fail test	Source-Measure Pass/Fail test <sup>9,11</sup>		
		TO GPIB	TO GPIB	TO GPIB		
Fast	0.01 / external	1.04 ms (1.08 ms)	0.5 ms (0.5 ms)	4.82 ms (5.3 ms)		
Medium	0.1 / external	2.55 ms (2.9 ms)	0.5 ms (0.5 ms)	6.27 ms (7.1 ms)		
Normal	1 / external	17.53 ms (20.9 ms)	0.5 ms (0.5 ms)	21.31 ms (25.0 ms)		
System General	Load Impedance	Stable into 20,000pF typical				
	Differential mode	250 V Pk				
	Voltage					
	Common mode Voltage	250V DC				
	Common mode	>10GΩ, <1000pF				
	Isolation					
	Over Range	105% of range, source and measure.				
	Max. Voltage drop	5V				
	Max. Sense lead	1MΩ				
	Resistance					
	Sense input Impedance	>100G Ω				
	Guard offset Voltage	<150μV, typical				
	Source output modes	Fixed DC level, Memory List (mixed function), Stair (linear and log)				
Source memory list	100 points max.					
Memory buffer	5,000 readings @ 5 digits (two 2,500 point buffers). Includes selected measured value(s) and time stamp. Lithium battery backup(3 yr+ battery life).					

	Programmability	IEEE-488.2 (SCPI), RS-232 5 user-definable power-up states plus factory default and *RST.
	Digital I/O Connector	Active low input. Start of test, end of test, 3 category bits. +5V@ 300mA supply. 1 trigger input, 4 TTL/Relay Drive outputs (33V @ 500mA, diode)
	Remote Interface	USB/GPIB/LAN/RS-232
Insulation	Chassis and Terminal	20MΩ or above (DC 500V)
	Chassis and AC cord	30MΩ or above (DC 500V)
Operation Environment	Indoor use, Altitude:	≤ 2000m
	Ambient temperature:	0 ~ 40°C
	Relative humidity:	≤ 80%
	Installation category:	II, Pollution degree: 2
Storage Environment	Temperature:	-20°C ~ 70°C
	Humidity:	< 80%
Input Power		100-240VAC, 50-60Hz
Power Consumption		80W
Accessories		CD User manual x1, Quick Start manual x1 Test lead GTL-207A x 1, ALLIGATOR CLIP x 2
Dimensions		214 (W) x 86 (H) x 356.5 (D) mm
Weight		Approx. 4.8kg
Remarks		<p><sup>1</sup> Speed = Normal (1 PLC). For 0.1 PLC, add 0.005% of range to offset specifications, except 200mV, 1A ranges, add 0.05%. For 0.01 PLC, add 0.05% of range to offset specifications, except 200mV, 1A ranges, add 0.5%.</p> <p><sup>2</sup> Required to reach 0.1% of final value after command is processed. Resistive load. 10μA to 100mA range.</p> <p><sup>3</sup> Overshoot into a fully resistive 100kΩ load, 10Hz to 1MHz BW, adjacent ranges: 100mV typical, except 20V/200V.</p> <p><sup>4</sup> Maximum time required for the output to begin to change following the receipt of :SOURce:VOLTage CURRent &lt;nrf&gt; command</p> <p><sup>5</sup> Reading rates applicable for voltage or current measurements. Auto zero off, autorange off, filter off, display off, trigger delay = 0, and binary reading format.</p> <p><sup>6</sup> Purely resistive load. 1μA and 10μA ranges &lt;65ms.</p> <p><sup>7</sup> 1000 point sweep was characterized with the source on a fixed range.</p> <p><sup>8</sup> Pass/Fail test performed using one high limit and one low math limit.</p> <p><sup>9</sup> Includes time to re-program source to a new level before making measurement.</p> <p><sup>10</sup> Time from falling edge of START OF TEST signal to falling edge of END OF TEST signal.</p> <p><sup>11</sup> Command processing time of :SOURce:VOLTage CURRent: TRIGgered&lt;nrf&gt; command not included.</p>

### Optional Accessories

GTL-246	USB 2.0, A-B type
GTL-108A	4-wire banana plug bridge clip