

DC Electronic Load

PEL-500 Series

USER MANUAL



ISO-9001 CERTIFIED MANUFACTURER

GW INSTEK

This manual contains proprietary information, which is protected by copyright. All rights are reserved. No part of this manual may be photocopied, reproduced or translated to another language without prior written consent of Good Will company.

The information in this manual was correct at the time of printing. However, Good Will continues to improve products and reserves the rights to change specification, equipment, and maintenance procedures at any time without notice.

Good Will Instrument Co., Ltd.
No. 7-1, Jhongsing Rd., Tucheng Dist., New Taipei City 236, Taiwan.

Table of Contents

SAFETY INSTRUCTIONS	3
GETTING STARTED	7
PEL-500 Series Introduction	9
PEL-500 Series Introduction	10
Accessories	12
Accessories Installation Description	13
Operating Mode Description	15
Operating Area	20
APPEARANCE	22
Front Panel	22
LCD Display	56
Rear Panel	63
INSTALLATION	64
Check line voltage	65
Power up	66
USB & RS232 interface option	66
Load wire inductance	67
Input terminal and wire consideration	71
Wire/Cable Guide	73
REMOTE CONTROL	74
Interface Configuration	75
Communication Interface programming command list	77
Command Syntax	86
Command List	88
PRESET Commands	90
Limit Commands	100







STATE commands	102
System Commands	108
Measure Commands	111
APPLICATION	112
Local sense connections	113
Remote sense connections	114
Constant Current mode application	116
Constant Resistance mode application	120
Constant Voltage mode application	123
Constant Power mode application	126
Zero-Volt loading application.....	130
PEL-500 series electronic load OCP, OPP, SHORT operation flow chart.....	131
Power Supply OCP testing	132
Power Supply OPP testing	134
SHORT testing.....	136
APPENDIX.....	138
Replacing the Fuse.....	139
PEL-500 Default Settings	140
PEL-500 Dimensions.....	142
PEL-500 series Specifications	144
Certificate Of Compliance	149

S SAFETY INSTRUCTIONS

This chapter contains important safety instructions that you must follow during operation and storage. Read the following before any operation to insure your safety and to keep the instrument in the best possible condition.

Safety Symbols

These safety symbols may appear in this manual or on the instrument.

	WARNING	Warning: Identifies conditions or practices that could result in injury or loss of life.
	CAUTION	Caution: Identifies conditions or practices that could result in damage to the instrument or to other properties.
		DANGER High Voltage
		Attention Refer to the Manual
		Earth (ground) Terminal
		Frame or Chassis Terminal
		Do not dispose electronic equipment as unsorted municipal waste. Please use a separate collection facility or contact the supplier from which this instrument was purchased.

Safety Guidelines

General Guideline



CAUTION

- Do not place any heavy object on the instrument. Note: Only 2 units can be stacked vertically.
- Avoid severe impact or rough handling that leads to damaging the instrument.
- Do not discharge static electricity to the instrument.
- Use only crimped wires, not bare wires, for the terminals.
- Do not block the cooling fan opening.
- Do not disassemble the instrument unless you are qualified.
- The equipment is not for measurements performed for CAT II, III and IV.

(Measurement categories) EN 61010-1:2010 specifies the measurement categories and their requirements as follows.

- Measurement category IV is for measurement performed at the source of low-voltage installation.
 - Measurement category III is for measurement performed in the building installation.
 - Measurement category II is for measurement performed on the circuits directly connected to the low voltage installation.
 - 0 is for measurements performed on circuits not directly connected to Mains.
 - Do NOT position the equipment so that it is difficult to disconnect the appliance inlet or the power plug.
 - If the equipment is used in a manner not specified by the manufacturer, the protection provided by the equipment may be impaired.
-

Power Supply	<ul style="list-style-type: none">• AC Input voltage range: 115Vac / 230Vac \pm10%• Frequency: 47-63Hz• To avoid electrical shock connect the protective grounding conductor of the AC power cord to an earth ground.• To avoid electric shock, the power cord protective grounding conductor must be connected to ground. No operator serviceable components inside. Do not remove covers. Refer servicing to qualified personnel.
 WARNING	
Cleaning	<ul style="list-style-type: none">• Disconnect the power cord before cleaning.• Use a soft cloth dampened in a solution of mild detergent and water. Do not spray any liquid.• Do not use chemicals containing harsh material such as benzene, toluene, xylene, and acetone.
Operation Environment	<ul style="list-style-type: none">• Location: Indoor, no direct sunlight, dust free, almost non-conductive pollution (Note below)• Temperature: 0°C to 40°C• Humidity: 0 to 85% RH• Altitude: <2000m• Overvoltage category II <p>(Pollution Degree) EN 61010-1:2010 specifies the pollution degrees and their requirements as follows. The instrument falls under degree 2.</p> <p>Pollution refers to “addition of foreign matter, solid, liquid, or gaseous (ionized gases), that may produce a reduction of dielectric strength or surface resistivity”.</p> <ul style="list-style-type: none">• Pollution degree 1: No pollution or only dry, non-conductive pollution occurs. The pollution has no influence.• Pollution degree 2: Normally only non-conductive pollution occurs. Occasionally, however, a temporary conductivity caused by condensation must be expected.• Pollution degree 3: Conductive pollution occurs, or dry, non-conductive pollution occurs which becomes conductive due to condensation which is expected. In such conditions, equipment is normally protected against exposure to direct sunlight, precipitation, and full wind pressure, but neither temperature nor humidity is controlled.

Storage
environment

- Location: Indoor
 - Temperature: -20°C to 70°C
 - Humidity: <90% RH
-

Disposal



Do not dispose this instrument as unsorted municipal waste. Please use a separate collection facility or contact the supplier from which this instrument was purchased. Please make sure discarded electrical waste is properly recycled to reduce environmental impact.

G E T T I N G S T A R T E D

More and more electronic products, such as mobile phones, laptops, tablet chargers, mobile power supplies, wireless chargers, electric hand tool chargers, etc., are currently using a single input voltage. In response to this trend, Electronics introduced the single-machine PEL-500 series of five electronic loads, including 80V and 500V, 350W and 700W four loads, and a 250W / 80V / 50A low wattage load to meet the needs of various tests on the market.

PEL-500 series electronic load continues the functions of various electronic load modes, including constant current, constant resistance, constant voltage, and constant power, dynamic and short-circuits mode, high-precision 5bit voltage, current, and power meter display simultaneously, full range RS232 and USB interfaces are standard.

In addition, it also includes various complete performance tests for battery CC, CP, timed discharge, etc., and Surge function for simulating electronic product startup overcurrent and hot plugging instantaneous current.

Each load module is capable of sinking a wide range of voltage and current values. The load modules are limited by the maximum power they can sink. For example the PEL-500 can sink up to 50A and 80Vdc at a maximum of 250W. So if the maximum voltage of 80Vdc is present at the load's input terminals a maximum load current of 3.125A is possible. Conversely if the PEL-503-80-50 is required to sink 50A the voltage must be limited to 5V.



PEL-500 Series Introduction.....	9
Main Features	9
PEL-500 Series Introduction	10
Protection features	10
Accessories	12
Accessories Installation Description.....	13
Operating Mode Description.....	15
CC Mode	15
CR Mode.....	15
CV Mode	16
CP Mode.....	16
Slew Rate.....	17
Dynamic Waveform Definition	18
Operating Area.....	20

PEL-500 Series Introduction

Main Features

- Features
- 5 digital V / A / W Meter.
 - High-speed measurement and communication transmission.
 - V.A.W. values can be displayed simultaneously.
 - Large LCD Display 、 setting values can be adjusted by rotary knob or push button.
 - Short, OCP, OPP, Battery and Surge test function.
 - Battery test function with stop condition: Vbatt, Discharge capacity and discharge time.
 - Surge test with boot-on inrush simulation and hot-swap simulation.
 - Flexible CC. CR, CV, CP, Dynamic and Short operation modes.
 - SHORT time setting and SHORT_VH, SHORT_VL setting function.
 - Protections against V, I, W and °C.
 - Voltage meter display the polarity positive (“+”) or negative (“-“) is selectable.
 - Interface : RS232, USB

PEL-500 Series Introduction

Protection features

The protection features of the PEL-500 series Electronic load modules are as follows:

Overvoltage protection	<p>The Electronic Load input will turn OFF if the overvoltage circuit is tripped. The message OVP will be displayed on the LCD. When the OVP fault has been removed the load can be set to sink power again. While the unit will attempt to protect itself given an OVP state it is strongly advised to guard against any potential OVP fault state by using external protection and the correctly rated electronic load.</p> <p>The Overvoltage protection circuit is set at a predetermined voltage and cannot be adjusted. The OVP level is 105% of the PEL-500 series nominal voltage rating.</p>
Caution	<p>Never apply an AC voltage to the input of the PEL-500 series Load. Do not apply a DC voltage that is higher than PEL-500 series Load rating. If this advice is ignored it is likely that damage will be caused to the electronic load module. This damage will not be covered by the warranty.</p>
Over current protection (OCP)	<p>The OCP protection will engage if the current being taken by the load reaches 105% of the load module's maximum current. The message OCP will be displayed on the front panel and the unit will switch to its LOAD OFF state. Once the source of the over current has been removed the load can be switched on again.</p>
Over power protection (OPP)	<p>The PEL-500 series Electronic Load monitors the power dissipation level. The input to the load is automatically switched to LOAD OFF if the power dissipation is greater than 105% of the rated</p>

	power input. If an over power condition occurs the display will show OPP
Over temperature protection (OTP)	The load module's internal temperature at the heat sink is monitored. If the temperature reaches approximately 90°C the OTP message will be displayed and the unit will automatically switch to the LOAD OFF state. If an OTP error occurs please check the ambient temperature is between 0 to 40°C. Also ensure that the front and rear air vents of the mainframe are not obstructed. The air flow is taken from the front of the mainframe and exhausted from the rear. Therefore a suitable gap needs to be left at the rear of the mainframe. A minimum of 15cm is recommended. After a suitable cooling period the load can be switched.
Reverse Polarity	<p>The PEL-500 series load module will tolerate a reverse current up to the maximum current rating of the load module. The “-“ symbol will be shown on the voltage and current displays.</p> <p>Please note that damage will occur if the reverse current is higher than the load module's maximum rating. If a reverse current is noticed turn off and disconnect the dc power source and turn the load off. The connections between the DC Source and the Load Module can now be correctly made.</p>
Caution	If a reverse polarity situation occurs the load will sink power even if the LOAD button is OFF. No current will be displayed on the PEL-500 series load module. Current up to the load's maximum current rating will be tolerated in reverse polarity. However there is no OVP OCP and OPP protection. It is strongly recommended that the load lines be fused if it is likely that the load could be subject to reverse polarity. These fuses should be fast acting and rated at the maximum current of the load module +5%.

Accessories

Item no.	Standard Accessories	Description	PCs
A	4mm Banana Plug (Red)		1
B	4mm Banana Plug (Black)		1
C	2mm Banana Plug (Red)		1
D	2mm Banana Plug (Black)		1
E	Hook terminal Y type large size terminal		1
F	Hook terminal Y type small size terminal		4
G	BNC Cable		2
H	PEL-500 series User Manual	It can be downloaded from GW Instek website	

Optional Accessories	Description	PCs
USB Cable	GEL-246, 0.6m	1
RS-232 cable	GEL-238, 9pin, M-F Type, 1000mm	1

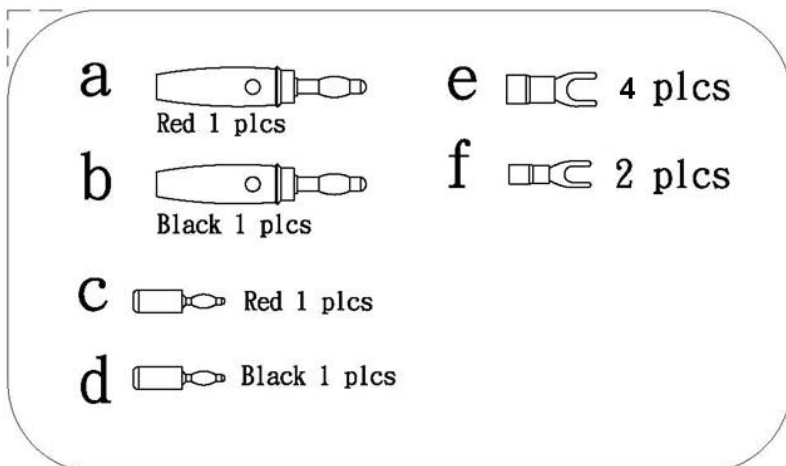

Accessories Installation Description

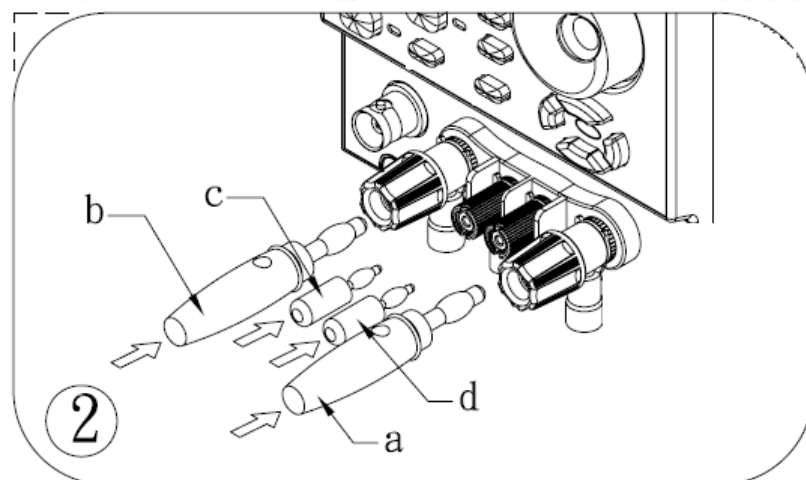
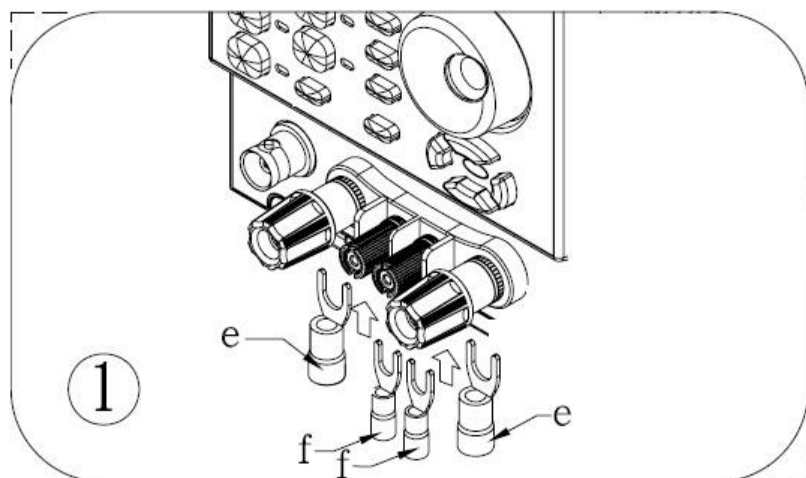

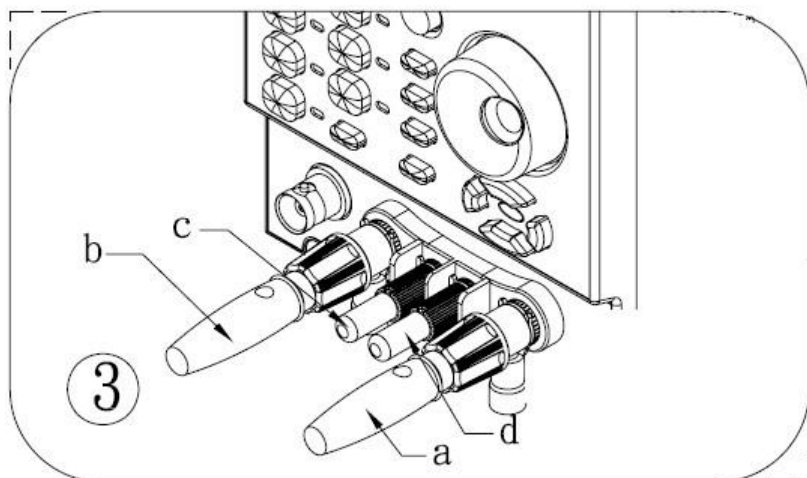

Operating Mode Description

CC Mode

Background With the operating mode of constant current, the PEL-500 series electronic load will sink a current in accordance with the programmed value regardless of the input voltage.

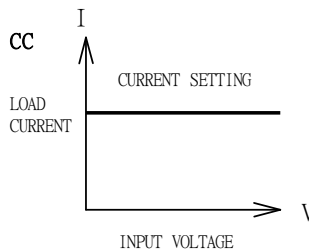

CR Mode

Background At Constant Resistance mode, the PEL-500 series electronic load will sink a current linearly proportional to the load input voltage in accordance with the programmed resistance setting

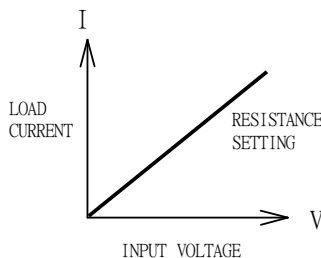

CV Mode

Background

At Constant Voltage mode, the PEL-500 series electronic load will attempt to sink enough current until the load input voltage reaches the programmed value.

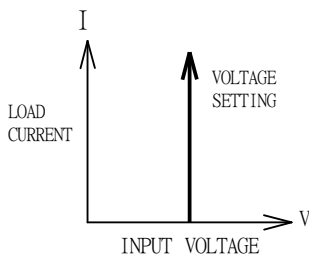

CP Mode

Background

At Constant Power mode, the PEL-500 series electronic load will attempt to sink load power (load voltage * load current) in accordance with the programmed power.

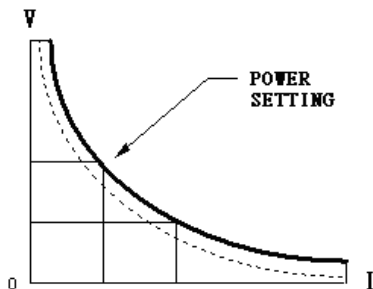

Slew Rate

Background

Slew rate is defined as the change in current or voltage over time. A programmable slew rate allows for a controlled transition from one load setting to another. It can be used to minimize induced voltage drops on inductive power wiring, or to control induced transients on a test device (such as would occur during power supply transient response testing).

In cases where the transition from one setting to another is large, the actual transition time can be calculated by dividing the voltage or current transition by the slew rate. The actual transition time is defined as the time required for the input to change from 10% to 90% or from 90% to 10% of the programmed excursion.

In cases where the transition from one setting to another is small, the small signal bandwidth (of the load) limits the minimum transition time for all programmable slew rates. Because of this limitation, the actual transition time is longer than the expected time based on the slew rate.

Rise Time Transition Limitation

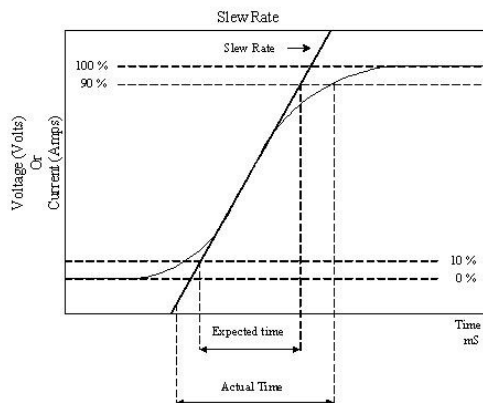

Therefore, both minimum transition time and slew rate must be considered when determining the actual transition time.

Following detail description is excluded in operation manual. The minimum transition time for a given slew rate as about a 30% or greater load change, the slew rate increases from the minimum transition time to the Maximum transition time at a 100% load change. The actual transition time will be either the minimum transition time, or the total slew time (transition divided by slew rate), whichever is longer.

Example	<p>PEL-503-80-50</p> <p>80V/50A/250W (CCH - CCL >50.4Ax 30%)</p> <p>Use the following formula to calculate the minimum transition time for a given slew rate Min transition time=18A/slew rate (in amps/second). $7.56\mu\text{S} (15.12\text{A}/2) \times 0.8(10\% \sim 90\%) = 6.048\mu\text{S}$</p> <p>Use the following formula to calculate the maximum transition time for a given slew rate Max transition time=60/slew rate (in amps/second). $25.2\mu\text{S} (50.4\text{A}/2) \times 0.8(10 \sim 90\%) = 20.16\mu\text{S}$</p>
---------	--

Example	<p>CCH=10.08A, CCL=0A Slew Rate =2A/uS, the expected time is 128uS but the actual transition Time will be limited to 144uS</p> <p>$5.04\mu\text{S} (10.08\text{A}/2) \times 0.8(10\% \sim 90\%) = 4.032\mu\text{S}$</p>
---------	--

Dynamic Waveform Definition

Background	<p>Along with static operation the PEL-500 series electronic load are built with a dynamic mode for operation in Constant Current (CC), Constant Resistance (CR) or Constant Power (CP). This allows the test engineer to simulate real world</p>
------------	---

pulsing loads or implement a load profile that varies with time.

A dynamic waveform can be programmed from the front panel of the PEL-500 electronic load. The user would first set a high and low value of load current using the Level button. The Dynamic Setting then allows for the rise and fall time between these 2 current values to be adjusted. The time period that the waveform is high (Thigh) along with the time period that the waveform is low (Tlow) can also be set.

Dynamic Waveform

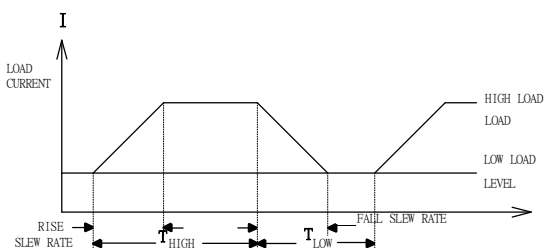

The dynamic waveform can also be set up via the optional computer interface. Dynamic waveform settings made from the front panel of the load module can also be saved in the memory of the PEL-500 series Electronic Load.

Further dynamic waveform definitions are :

- The period of dynamic waveform is $T_{high} + T_{low}$.
- The dynamic frequency = $1 / (T_{high} + T_{low})$
- The duty cycle = $T_{high} / (T_{high} + T_{low})$

Operating Area

The PEL-500 series electronic load can be operated for manual and GPIB operation.

The PEL-500 series high power electronic Load can be controlled locally at the front panel or remotely via computer over the GPIB/RS232/USB/LAN. Constant current (CC) mode, constant resistance (CR) mode, and constant voltage (CV) mode and constant power (CP) mode. The wide range dynamic load with independent rise and fall current slew rate and analog programming input with arbitrary wave-form input is available in Constant Current mode.

PEL-503-80-50
80V/50A/250W
 power contour

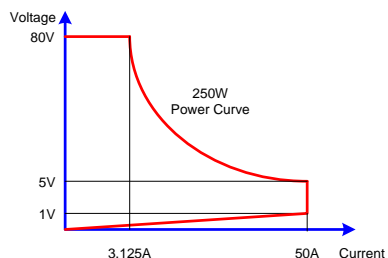

PEL-504-80-70
80V/70A/350W
 power contour

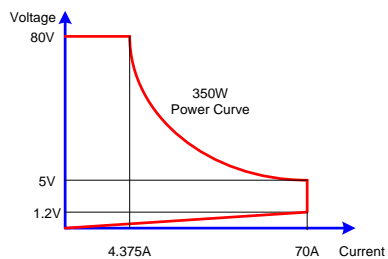

PEL-504-500-15
500V/15A/350W
 power contour

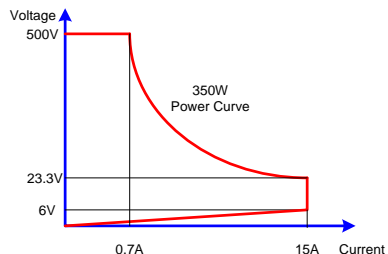

PEL-507-80-140
80V/140A/700W
power contour

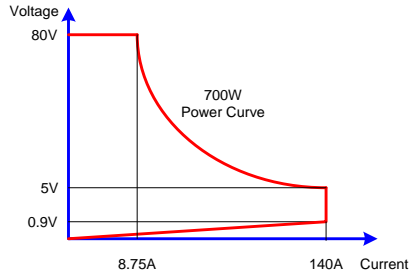

PEL-507-500-30
500V/30A/700W
power contour

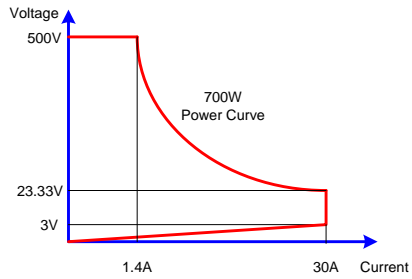

APEARANCE

Front Panel

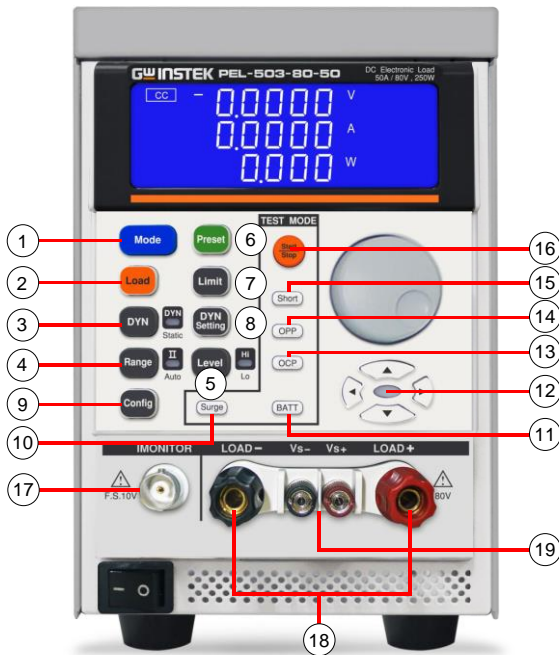

- 1 Mode and CC, CR, CV, CP Indicators
- 2 Load key and LED
- 3 DYN/STA key and LED
- 4 Range key and LED
- 5 Level key and LED
- 6 Preset key and LED

- 7 Limit key
- 8 DYN setting key
- 9 Config key
- 10 Surge key
- 11 BATT key
- 12 Rotary knob and Arrow keys
- 13 OCP key
- 14 OPP key
- 15 Short key
- 16 Start /Stop key
- 17 I-monitor terminal
- 18 DC INPUT terminal
- 19 V-sense input terminal

Mode and CC,
CR, CP, CV
Indicator



There are four operating modes. These can be selected in turn by pressing the "MODE" key on the PEL-500 series Electronic Load module. The sequence is:

- (CC) Constant Current
- (CR) Constant Resistance
- (CP) Constant Power
- (CV) Constant Voltage

The appropriate LCD will illuminate according to the operating mode is selected.

Load key and
LED



The input to the PEL-500 Series electronic load can be switched ON/OFF by using the "LOAD" button. Indication of the ON/OFF state is provided by illumination of the button.

LOAD button lit=LOAD ON (load sinks according to the preset values)

LOAD button unlit = LOAD OFF (the load

does not sink current)

Turning the LOAD OFF does not affect the preset values. When the LOAD ON state is enabled the unit will revert to sinking according to the preset values.

When the Load ON/OFF key is operated the current taken by load will follow the RISE or FALL with time according to the preset rate. The current RISE and FALL times can be adjusted in the DYN Setting button of the front panel.

In addition to the LOAD ON/OFF function the user can also adjust the voltage level at which the unit will automatically start or stop sinking energy. The adjustable LDon and LDoff voltage levels are found within the CONFIG menu.



Note

The LDoff level cannot be set higher than the LDon level.

DYN/STA key and LED

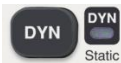

The DYN button allows the user to switch between DYNAMIC operation and STATIC operation. Dynamic operation is only possible in constant current (CC) or constant power (CP) mode only. The LED next to the DYN button will become lit when DYNAMIC operation is selected. If you are in constant resistance (CR) or constant voltage (CV) mode pressing the DYN button will have no effect.



Note

- In the Static mode, the range for Low level varies with the range for High level.
- The range for Rise/ Fall also varies with the range for High level.

Range key

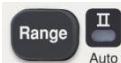

The PEL-500 series Load Module features 2 setting ranges for CC, CR, CV & CP operation. This allows improved resolution for setting low values. When left in the

default AUTO mode, the changeover between ranges is automatic depending on the setting value entered.

If desired the RANGE button can be pressed to force the unit to operate only in RANGE II. This is signaled by the accompanying LED becoming lit.



Note

It is only possible to force RANGE II in CC mode.

Level key and LED



The LEVEL button is used to program a High or Low load value. The setting value changes between current, resistance, voltage or power depending whether CC, CR, CV or CP mode has been selected. If the LED is lit then the High level value setting Has been enabled. If the LED is not lit then the low load level can be set using the rotary switch in combination with the arrow keys.

In STATIC mode the user can switch between High and low load levels during operation.

In DYNAMIC operation (CC & CP modes only) the preset high and low levels are used to define the dynamic waveform.



Note

The low level setting cannot exceed the high level. The converse is also true in that the High level cannot be set below the low level.

- Constant Current (CC) mode:
The level is initial setting on High, LEVEL High / Low has two level, Low current level setting must be lower than Level High.
- Constant Resistance (CR) mode:
The level is initial setting on High, LEVEL High / Low has two level, Low resistance level setting must be lower

than Level High. CR Mode Level High / Low level by current perspectives.

- Constant Voltage (CV) mode:
IF Low level load voltage value greater than High level load voltage value or opposite status, the load voltage value is equal.
CV Mode Level High / Low has “automatic push function”.
- Constant Power (CP) mode:
The level is initial setting on High, LEVEL High / Low has two level, Low power level setting must be lower than Level High.

Automatically Push Function level setting: Level High must be higher or equal than Level Low; When level High equal to then LEVEL Low, it can't be adjusted anymore.

When Level High equals to lower low, the Automatic push function can push down the level Low value.

Therefore, the Level High can continue adjusting.

Preset key and
LED
indicators



If the PRESET key is pressed the button will become lit indicating that the PRESET mode has been accessed. The lowest 5 digit display will change from showing the power consumption in watts to displaying the value to be preset. The value that can be programmed changes according to the operating mode that has been selected.

- Constant Current (CC) mode:
The High and Low levels of load current can be preset at lower 5 digit LCD. The “A” LED will be lit indicating the setting value is amps.

- Constant Resistance (CR) mode:
The High and Low levels of load resistance can be preset on the lower 5 Digit LCD. The “Ω” LED will be lit indicating the setting value is ohms.
- Constant Voltage (CV) mode:
The High and Low levels of load voltage can be preset on the lower 5 Digit LCD. The “V” LED will be lit indicating the setting value is volts.
- Constant Power (CP) mode:
The High and Low levels of load power can be preset on the lower 5 digit LCD. The “W” LED will be lit indicating the setting value is watts.
- Dynamic mode (CC, CR or CP modes only):
Each press of the DYN button cycles through the dynamic load settings. The DYN settings are used in conjunction with the High and Low levels of load current to define the dynamic waveform. Each press of the DYN button switches from T_Hi (time high), to T_Lo (time low), to Rise time and then to fall time. The middle LCD shows the section of the dynamic waveform which is programmed with the rotary knob and read from the lower display. The “ms” LED shows that the settings are programmed in milliseconds.

Limit key



The LIMIT button allows the user to set left and right thresholds for voltage, current or power. These threshold settings are used in conjunction with the NG function to flag when the load is operating outside the desired limit.

Each press of the LIMIT key enables a different value to be entered. On first press of the LIMIT key the button will illuminate and +CV will be displayed on the middle LCD. The setting is made with the rotary knob and can be read from the lower LCD during setting.

The setting sequence is shown below:

- V_Hi (DVM upper limit)
- V_Lo (DVM lower limit)
- I_Hi (DAM upper limit)
- I_Lo (DAM lower limit)
- W_Hi (DWM upper limit)
- W_Lo (DWM lower limit)
- NG OFF/ON (No Good Flag)
- LIMIT setting function OFF

The engineering unit is “V”, “A” or “W” depending on the threshold LIMIT being set.



Set upper limit voltage VH , Middle 5

digit LCD display "V-Hi", lower 5 digit LCD display the unit is "V", the V-Hi set range from 0.000 V to 81.000V step 0.001V by rotating the Setting knob.



Setting lower limit voltage VL, Middle 5 digit LCD display "V-Lo", lower 5 digit LCD display the unit is "V", the V-Lo set range from 0.000 V to 81.000V step 0.001V by rotating the Setting knob.

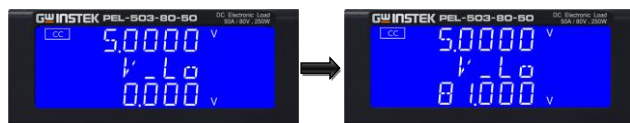

Setting Upper limit current IH, Middle 5 digit LCD display "I-Hi", lower 5 digit LCD display the unit is "A", the I-Hi set range from 0.000 A to 50.400A step 0.001A by rotating the Setting knob.

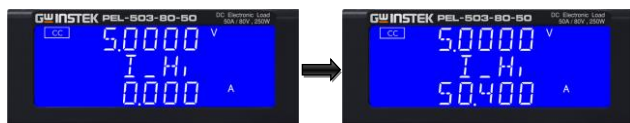

Setting lower limit current IL, Middle 5 digit LCD display "I-Lo", lower 5 digit LCD display the unit is "A", the I-Lo set range from 0.000 A to 60.000A step 0.001A by rotating the setting knob.

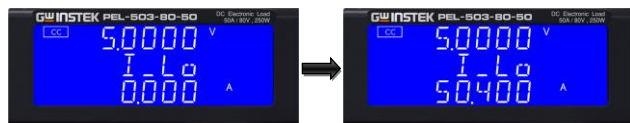

Setting Upper limit power WH, Middle 5 digit LCD display "W-Hi" lower 5 digit LCD display the unit is "W", the W-Hi set

range from 0.00 W to 250.20W step 0.01W by rotating the Setting knob.



Setting lower limit power WL, Middle 5 digit LCD display “W-Lo” lower 5 digit LCD display the unit is “W”, the W-Lo set range from 0.00 W to 300.00W step 0.01W by rotating the Setting knob.

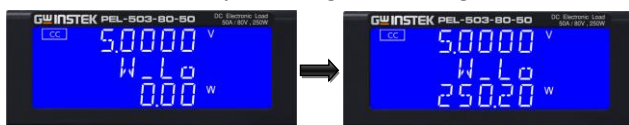

Setting NG ON/OFF, When exceed VH, VL, IH, IL, WH, WL One of these Whether NG on LCD display

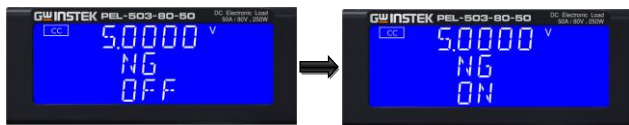

CC mode, press Limit key to set the V-Hi and V-Lo voltage upper and lower limits of the GO / NG.

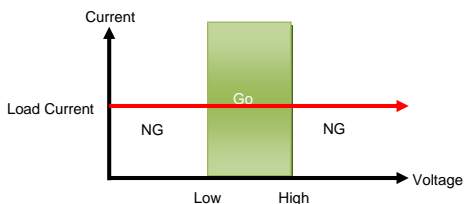

CC Dynamic Mode, press Limit key to set the Level Hi and Level Low voltage upper and lower limits of the GO / NG.

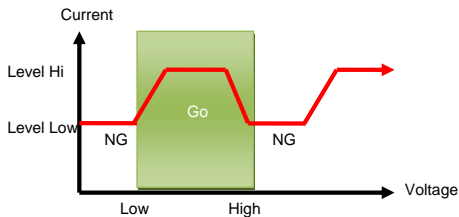

CR mode, press Limit key to set the V-Hi and V-Lo voltage upper and lower limits of the GO / NG.

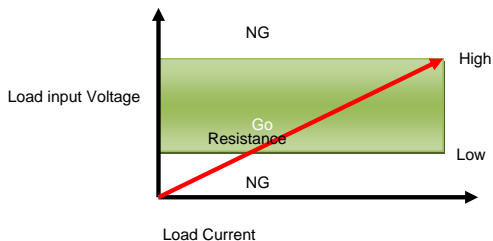

CV mode, press limits key to set the I-Hi and I-Lo Current upper and lower limits of the GO / NG.

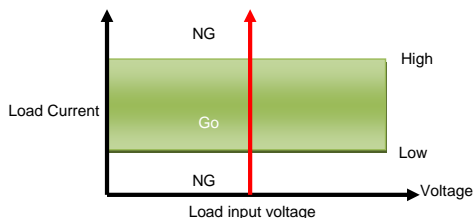

CP mode, press Limit key to set the W-Hi and W-Lo power upper and lower limits of the GO / NG.

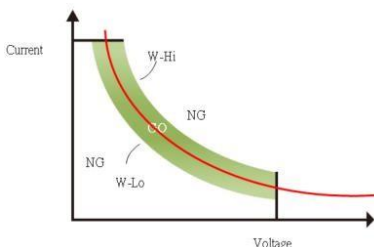

DYN setting
key



The DYN button allows the user to define the timings of the dynamic load waveform. Firstly the high and low levels of load current will need to be set via the LEVEL switch. The RISE and FALL times between the low load current and the high load current along with the TIME the waveform is HIGH and the TIME LOW can be set via the DYN menu.

Each press of the DYN key enables a section of the DYNAMIC waveform to be set.

On first press of the DYN key the button will illuminate and T-Hi will be displayed on the middle LCD. The value is adjusted with the rotary knob and can be read from the lower LCD during setting.

The setting sequence is shown below:

- T_Hi (time the waveform is high)
- T_Lo (time the waveform is low)
- RISE (rise time)
- FALL (fall time)
- Exit DYN Setting function

The time that the waveform is high includes the rise time and is set in "ms".

The time that the waveform is low includes the fall time and is set in "ms".

The RISE and FALL time is set in "mA/ μ s" or "A/ μ s". The actual engineering unit is shown on the right of the lower 5 digit display.



Press DYN setting key, LED will ON setting level High Period, Middle 5 digit LCD display will show “T-Hi” lower 5 digit LCD display will show setting value, the unit is “ms” , The T-Hi set range from 0.050 ms to 9999 ms step 0.001ms by rotating the setting knob.



Setting level Low period, Middle 5 digit LCD display will show “T-Lo”, lower 5 digit LCD display will show setting value, the unit is “ms”, The T-Lo set range from 0.050 ms to 9999 ms step 0.001ms by rotating the Setting knob.



Setting rise time, Middle 5 digit LCD display will show “RISE”, lower 5 digit LCD display will show setting value, the unit is “mA/μs”, The RISE time set range from 3.2 mA/us to 204.0 mA/us step 1mA/us by rotating the setting knob.



Setting fall time, Middle 5 digit LCD display will show “FALL”, lower 5 digit LCD display will show setting value, the unit is “mA/μs”, The FALL time set range from 3.2 mA/us to 204.0 mA/us step 1mA/us by rotating the setting knob.



Config key



The CONFIG key allows the sense function to engage automatically or switched ON. The CONFIG key also enables the LOAD to automatically turn ON/OFF when a voltage level is reached. The polarity symbol can also be switched via the CONFIG menu.

Each press of the CONFIG key moves the menu on one step. On first press of the CONFIG key the button will illuminate and EXTIN will be displayed on the Right upper LCD. The value is adjusted with the rotary knob and can be read from the right LCD during setting.

The setting sequence is shown below:

- SENSE (AUTO or ON)
- LDon (Voltage at which LOAD turns ON)
- LDOFF (Voltage at which LOAD turns OFF)
- POLAR (change polarity symbol)
- Exit CONFIG options

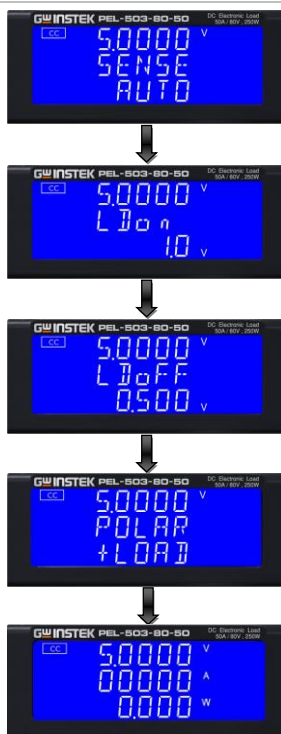

Note

- The adjustable LDon (LOAD ON) voltage is valid for CC, CR & CP operating modes. The adjusted LDon voltage will not operate in CV mode.
- The LDon (LOAD ON) voltage setting cannot be lower than the LDOFF (LOAD OFF) voltage. If 0V is required for both LOAD ON and LOAD OFF make the LOAD OFF adjustment first.

Set Vsense and load input switching methods, the middle of the 5 digit LCD display will show "SENSE", Lower 5 digit LCD display will show "AUTO" or "ON".

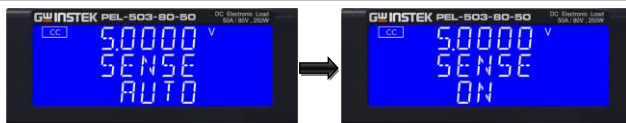

Set Load ON voltage, the middle of the 5 digit LCD display will show "LDon", Lower 5 digit LCD display will show setting value, the units is V, The Load ON Voltage set range from 0.0V to 25.0V step 0.1V by rotating the setting knob. If the load is greater than the input voltage the Electronic Load ON voltage setting, the Electronic load current begin to load on.

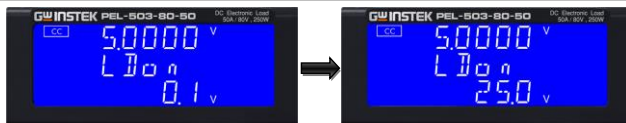

 **Note**

- CC/CR/CP MODE is controlled by Load ON voltage, CV MODE is not controlled by Load ON voltage.
- If Load ON voltage Setting 0V, load OFF voltage has to setting to 0V.

Set Load OFF voltage, the middle of the 5 digit LCD display will show "LDOFF", lower the 5 digit LCD display will show settings value, the units is V, the Load OFF Voltage set range from 0.0V to 24.9V step 0.1V by rotating the setting knob.

If the load input voltage is less than Load OFF setting voltage, the electronic load to load off.

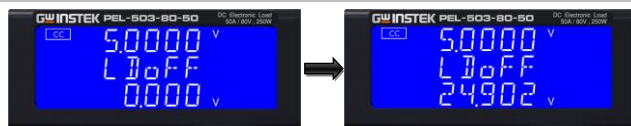

Set Load polarity, the middle of the 5 digit LCD display will show “POLAR”, lower the 5 digit LCD display “will show + LOAD” or “-LOAD”, use the knobs and key settings “+ LOAD” or “-LOAD”.

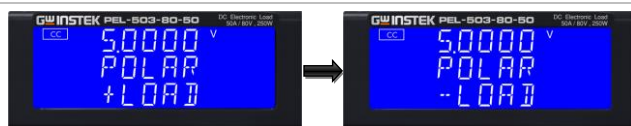

Surge key

Surge

Press the SURGE button to enter the SURGE setting mode. The LED indicator is ON and its setting sequence is as follows:

- SUR_I
- NOR_I
- S.TIME'
- S.STEP

Set surge current, middle 5 digit LCD display will show “SUR_I”, lower 5 Digit LCD display will show setting value, the unit is “A”, the surge current set range from 0.000 A to 50.400A step 0.005A by rotating the setting knob.

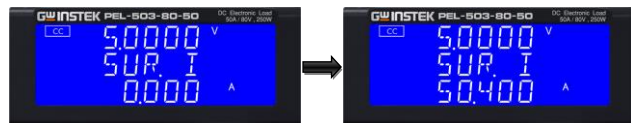

Set normal current, Middle 5 digit LCD display will show “NOR_I”, lower 5 Digit LCD display will show setting value, the unit is “A”, The Normal current set range from 0.000 A to 50.400A step 0.005A by rotating the setting knob.

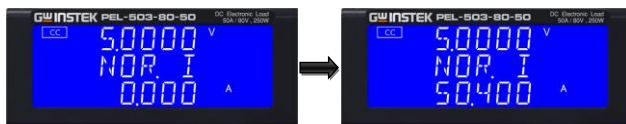

Set S.TIME, Middle 5 digit LCD display will show “S.TIME”, Lower 5 Digit LCD display will show setting value, the unit is “ms”, the surge current time set range from 10 to 1000ms step 10ms by rotating the setting knob.

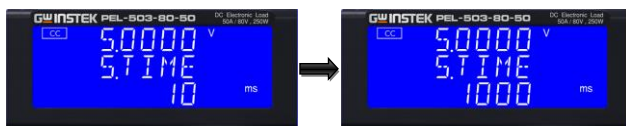

Set S.STEP, Middle 5 digit LCD display will show “S.STEP”, Lower 5 Digit LCD display will show setting value, the S.STEP set range from 1 to 5. Press the START key to start the test.

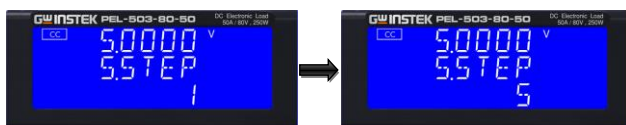

BATT key



Press the BATT key to enter the BATT setting mode, the LED indicator is ON, and the setting sequence is as follows:

- DISCH MODE CC
- DISCH CC
- STOP VOLT.V
- STOP TIME.S
- STOP CAP.AH
- STOP CAP.WH

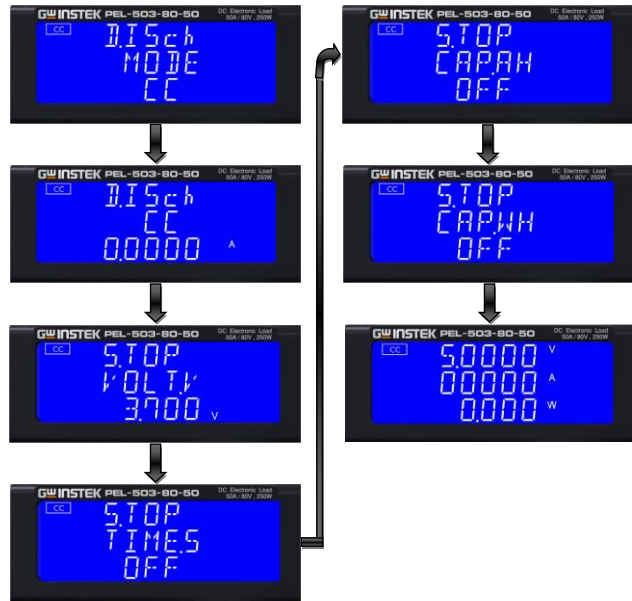

Set DISCH CC, LCD displays “DISCH”, the middle 5 digit monitor display “CC”, the setting range is from 0.000A to 50.400A, and the setting interval of each setting knob and key is 0.0001A.

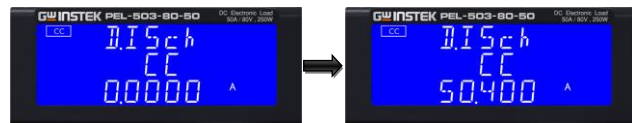

Set STOP VOLT.V, the middle 5 digit monitor display “VOLT.V”, the lower 5 digit display shows the set value, the unit is V, STOP VOLT.V The setting range is from 0.000V to 81.000V, each setting knob and key adjustment the interval is 0.001V.

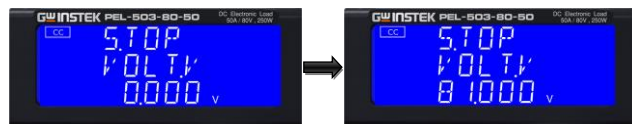

Set STOP TIME.S, the middle 5 digit monitor display will display “TIME.S”, the lower 5 digit display will display the set value, and the STOP TIME.S setting range will be from OFF to 99999. The setting interval of each setting knob and key is 1.

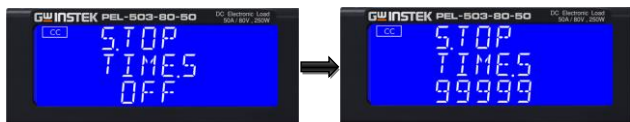

Set STOP CAP.AH, the middle 5 digit monitor display “CAP.AH”, the lower 5 digit monitor display the set value, the STOP CAP.AH setting range is from OFF to 19999.9, and the setting interval of each setting knob and key is 0.1.

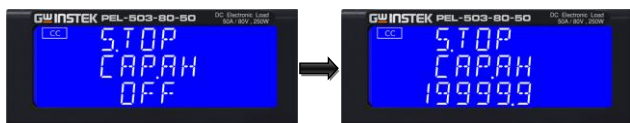

Set STOP CAP.WH, the middle 5 digit monitor display “CAP.WH”, the lower 5-digit monitor display display the set value, the STOP CAP.WH setting range is from OFF to 19999.9, and the setting interval of each setting knob and key is 0.1.



Rotary knob and Arrow keys

The Rotary knob and Arrow keys are used to increase or decrease the set values.

- Clockwise operation of the Rotary knob increases the setting value.

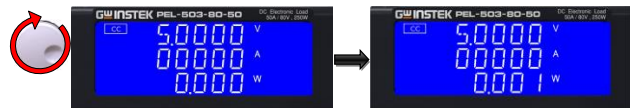

- Anti-clockwise operation of the Rotary knob decreases the setting value.

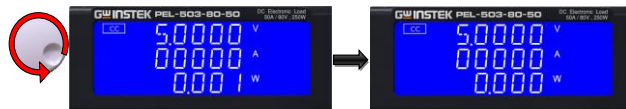

- Left Arrow key: Moves the setting selection one digit to the left.



- Right Arrow key moves the setting selection one digit to the right.



- Up arrow key increases the setting value.

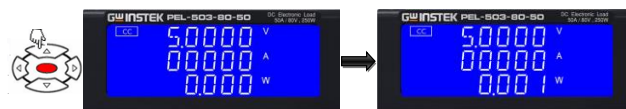

- Down arrow key reduces the setting value.

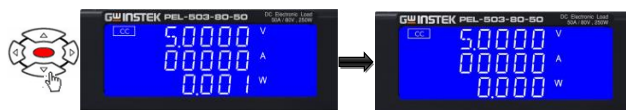

 **Note**

- In CR mode, the Up arrow key and clockwise operation of the ROTARY Knob reduces the resistance.
- In CR mode, the Down arrow key and Anti-clockwise operation of the ROTARY Knob increases the resistance.

OCP key



The OCP key allows the parameters of an Over Current Protection test to be entered. The OCP test will ramp up the load current in steps to validate the device under test's (DUT) protection and

behavior. A voltage threshold level can be set. If the voltage measured during the test is lower than the set Threshold voltage then the test will fail and the display will signal OCP ERROR. Similarly a current Threshold (I STOP) can be set. If the measured current reaches the I STOP Threshold the test will be discontinued and the OCP ERROR message will be displayed.

Press the OCP key once will cause the button to illuminate. The message "OCP PRESS START" will be shown across the 3 displays.



Each press of the OCP button moves the menu on one step. The upper and Middle LCDs show the currently selected test parameter as text. The value is adjusted by the rotary knob and can be read from the lower display during Setting.

The setting sequence is shown below:

- OCP PRESS START (pressing the red start/stop key starts test)
- OCP I STAR (current starting point of the OCP test)
- OCP I STEP (value of incremental current steps from I START)
- OCP I STOP (the OCP test's upper current threshold)
- OCP Vth (the voltage threshold setting)
- Exit OCP test set-up

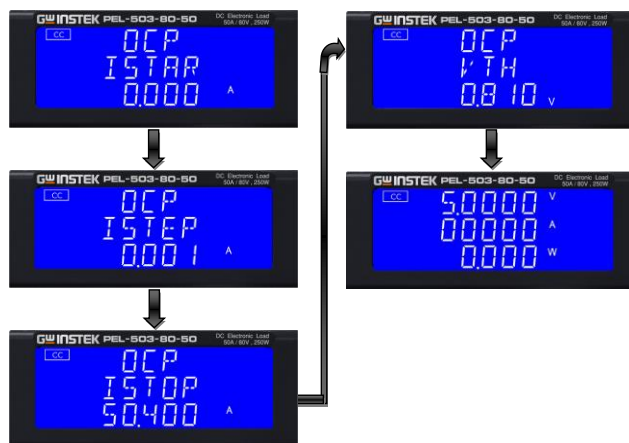

- ISTAR: setting the start current point, The LCD display shows “OCP” on upper 5 digit LCD display, Middle 5 digit LCD display “ISTAR”, lower 5 digit LCD display setting value, the unit is “A”. The setting range is 0.000A to the full scale of the CC mode specification. The setting is by rotating the setting knob.

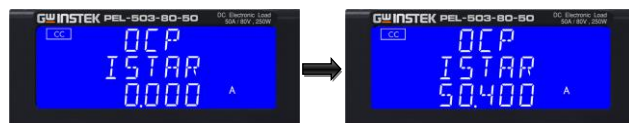

- ISTEP: setting the increment step current point, The LCD display shows “OCP” on upper 5 digit LCD display, Middle 5 digit LCD display “ISTEP”, lower 5 digit LCD display setting range value, the unit is “A”. The setting range is 0.001A to the full scale of the CC mode specification. The setting is by rotating the setting knob.

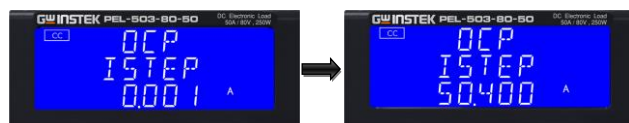

- **ISTOP:** setting the stop current point, The LCD display shows “OCP” on upper 5 digit LCD display, Middle 5 digit LCD display “ISTOP”, lower 5 digit LCD display setting value, the unit is “A”, the setting range is 0.000A to the full scale of the CC mode specification. The setting is by rotating the setting knob.



- **Vth:** Setting threshold voltage; The LCD display shows “OCP” on upper 5 digit LCD display, Middle 5 digit LCD display “Vth”, lower 5 digit LCD display setting value, the unit is “V”, the setting range is 0.00V to the full scale of the Voltage specification. The setting is by rotating the setting knob.



Once the test parameters have been entered the test is started by pressing the red START/STOP button while the OCP PRESS START text is displayed. During the Test the middle LCD will show run and the actual current being Taken will be Displayed on the lower LCD.

 **Note**

The message OCP ERROR will be displayed if the DUT fails the test. The reasons for failure are due to one of the following conditions:

- (a) The voltage level of the DUT falls below the set voltage threshold (OCP Vth)during the test
- (b) The current taken from the DUT reaches the OCP I

STOP setting.

The message PASS will be displayed if the DUTs voltage stays above the set threshold. Also to PASS the OCP test the current taken from the DUT cannot equal the I STOP setting.

If the DUT passes the OCP test the maximum current taken during the test is displayed on the lower LCD.

Upon PASS or OCP ERROR the test will automatically stop. The red START/STOP button can be used during the test to immediately cease operation.

After the test is completed, the test result “PASS” or “FAIL” will be displayed and hold on the lower 5-digit display until the user presses any button to release.

OPP key



The OPP allows the parameters of an Over Power Protection test to be entered. The OPP test will ramp up the load power in steps to validate the Device under test's (DUT) protection and behavior. A voltage threshold level can be set. If the voltage measured during the test is lower than the set Threshold voltage then the test will fail and the display will signal OPP ERROR. Similarly a power threshold (P STOP) can be set. If the measured power reaches the P STOP threshold the test will be discontinued and the OPP ERROR message will be displayed.

Press the OPP key once will cause the button to illuminate. The message “OPP PRESS START” will be shown across the 3 displays.



Each press of the OPP button moves the menu on one step. The upper and Middle LCDs show the currently selected test

parameter as text. The value is adjusted by the rotary knob and can be read from the lower display during Setting.

The setting sequence is shown below:

- OPP PRESS START (pressing the red start/stop key starts test)
- OPP P STAR (power starting point of the OPP test)
- OPP P STEP (value of incremental current steps from P START)
- OPP P STOP (the OPP test's upper threshold power limit)
- OPP Vth (the voltage threshold setting)
- Exit OPP test set-up

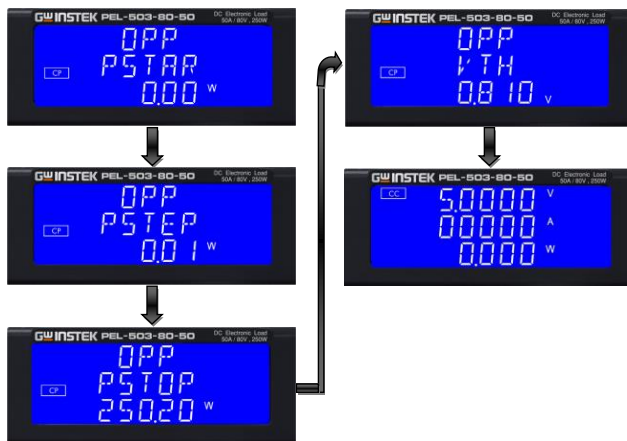

- PSTAR: setting the start power, The LCD display shows “OPP” on upper 5 digit LCD display, Middle 5 digit LCD display “PSTAR”, lower 5 digit LCD display setting value, the unit is “W”, the setting range is 0.00W to the full scale of the CP mode specification. The setting is by rotating the setting knob.

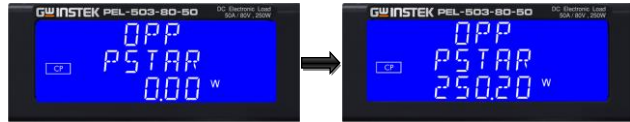

- PSTEP: setting the increment step power, The LCD display shows “OPP” on upper 5 digit LCD display, Middle 5 digit LCD display “PSTEP”, lower 5 digit LCD display setting value, the unit is “W”, the setting range is 0.00W to the full scale of the CP mode specification. The setting is by rotating the setting knob.

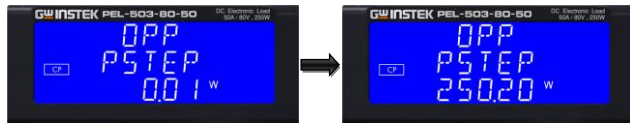

- PSTOP: setting the stop power, The LCD display shows “OPP” on upper 5 digit LCD display, Middle 5 digit LCD display “PSTOP”, lower 5 digit LCD display setting value, the unit is “W”, the setting range is 0.00W to the full scale of the CP mode specification. The setting is by rotating the setting knob.



- Vth : Setting threshold voltage; The LCD display shows “OPP” on upper 5 digit LCD display, Middle 5 digit LCD display “Vth”, lower 5 digit LCD display setting value, the unit is “V”, the setting range is 0.000V to the full scale of the Voltage specification. The setting is by rotating the setting knob

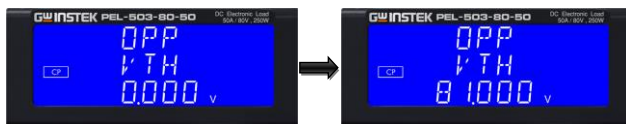

Once the test parameters have been entered the test is started by pressing the red START/STOP button while the OPP PRESS START text is displayed. During the test the middle LCD will show run and the actual power being taken will be displayed on the lower LCD.



The message OPP ERROR will be displayed if the DUT fails the test. The reasons for failure are due to one of the following conditions:

- (a) The voltage level of the DUT falls below the set voltage threshold (OPP Vth) during the test
- (b) The current taken from the DUT reaches the OPP P STOP setting.

The message PASS will be displayed if the DUT's voltage stays above the set threshold. Also to PASS the OPP test the current taken from the DUT cannot equal the I STOP setting.

If the DUT passes the OPP test the maximum power taken during the test is displayed on the lower LCD.

Upon PASS or OCP ERROR the test will automatically stop. The red START/STOP button can be used during the test to immediately cease operation.

After the test is completed, the test result "PASS" or "FAIL" will be displayed and hold on the lower 5-digit display until the user presses any button to release.

Short key



The Short key allows the parameters of a SHORT circuit test to be entered. The SHORT test will attempt to sink high current up to the PEL-500 series load maximum current in order to check the power source's protection and behavior. The test time can be adjusted and

threshold values for the High and low voltage limits set.

Press the Short key once will cause the button to illuminate. The Message "SHORT PRESS START" will be shown across the 3 displays.

Each press of the SHORT key moves the menu on one step. The upper and middle LCDs show the currently selected test parameter as text. The value is adjusted by the rotary knob and can be read from the lower display during setting.

The setting sequence is shown below:

- SHORT PRESS START (pressing the start/stop key starts test)
- SHORT Time (CONTI = Continuous or 100ms to 10,000ms possible)
- SHORT V_Hi (High voltage threshold setting)
- SHORT V_Lo (Low voltage threshold setting)
- Exit SHORT test set-up



- Set the short test time, the LCD display show "SHORT" on upper 5 digits LCD

display, shows “TIME” on middle 5 digits LCD display, lower 5 digit LCD display “CONTI”, the unit is “ms”.



- **TIME:** Set the short test time, The LCD display show “SHORT” on upper 5 digits LCD display, shows “TIME” on middle 5 digits LCD display the unit is “ms”, and shows “CONTI” on lower 5 digits LCD display, the setting range is “CONTI” means continue, 100mS to 10000mS step 100mS by clockwise rotate the setting knob.

The short test will be no time limitation when setting to CONTI until press “START/STOP” key to stop the short test.

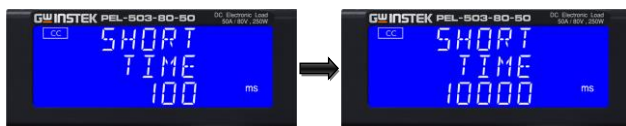

- **V-Hi :** Short test voltage check upper limitation setting, The LCD display shows “SHORT” on upper 5 digit LCD display, Middle 5 digit LCD display “V-Hi”, lower 5 digit LCD display setting value, the unit is “V”, The V-Hi setting range from 0.000V to 81.000V step 0.001V by rotating the setting knob.

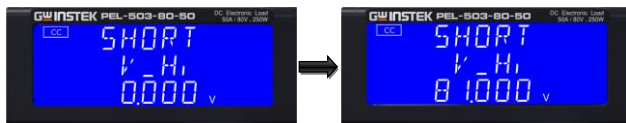

- **V-Lo :** Short test voltage check lower

limitation setting, The LCD display shows "SHORT" on upper 5 digit LCD display, Middle 5 digit LCD display "V-Lo", lower 5 digit LCD display setting value, the unit is "V", the V-Hi setting range from 0.000V to 81.000V step 0.001V by rotating the setting knob.

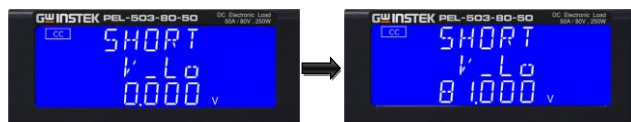

Once the test parameters have been entered the test is started by pressing the red START/STOP button while the SHORT PRESS START text is displayed. During the test the bottom LCD will show run and the actual short current will be displayed on the middle LCD.



Note

- The message PASS END will be displayed if the measured voltage levels stay within the V_Hi and V_Lo threshold levels during the test.
- The message FAIL END will be displayed if the measured voltage levels fall outside the V_Hi and V_Lo threshold levels during the test. The NG flag will also illuminate.
- If continuous short time is selected the test is ended by pressing the red START/STOP button.

Start/Stop key



The red START/STOP key is used in conjunction with the FUSE, BMS, SHORT, OCP or OPP test functions. It is used to START a test according to the set parameters or to STOP a test before PASS or FAIL is signaled. Please refer to the preceding sections for more information on the FUSE, BMS, SHORT, OCP & OPP tests.

I-Monitor



The I-monitor is provided as a BNC socket. It is designed to enable the user to monitor the Electronic Load's input current or short current. The I-monitor's signal is 0V to 10V. This signal is proportional to the full scale current that the particular electronic Load module is capable of.

Example PEL-503-80-50: $I_{max} = 50A$ therefore I-monitor 10V = 50A, so 1V = 5A

Please refer to the specification on page for the maximum current that each PEL-500 series module is capable of.

Caution

The current monitor of this unit is not isolated. Please be careful when you connect an oscilloscope. Improper connections are likely to cause damage.

An equivalent circuit in terms of the current monitor

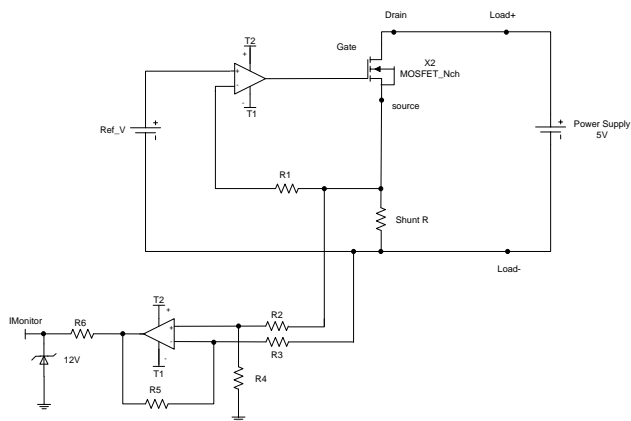

DC INPUT Terminal



The positive (LOAD +) and negative (LOAD -) power input terminals are clearly marked. **DO NOT** confuse them with the smaller SENSE terminals.

Please ensure that the voltage and current rating of the DUT do not exceed the maximum rating of the PEL-500 load module being used. Please also check the output polarity of the DUT prior to

connection and testing.

The negative load terminal should be connected to ground if testing a positive output power supply. This is normally achieved when the negative output of the power supply is grounded.

Similarly if a power supply with a negative output is to be tested then the positive load terminal should be grounded. This is normally achieved when the positive output of the power supply under test is grounded.

V-sense input terminal



The V-sense terminals can be used to compensate for a voltage drop in the load lines between the power supply and the PEL-500 series Electronic Load. This is a useful feature useful when the load current is relatively high.

If remote sense is required the V-sense terminals are connected to the appropriate positive and negative terminals of the power supply as shown in Fig below.

In the CONFIG menu the V-sense function can be set to AUTO or ON.

Please note that if V-sense is set to AUTO and the sense leads are connected to the DUT the losses need to be approx. 1V (PEL-503-80-50, PEL-504-80-70, PEL-504-80-140) or 6V (PEL-504-500-15, PEL-507-500-30) before the display compensates for the voltage loss.

If V-sense is set to "ON" and the sense terminals are connected to the DUT the load will check and compensate for all voltage drops.

The maximum voltage sense

compensation is the same as the rating of the PEL-500 series electronic load module. For example the PEL-503-80-50 is capable of sinking current at up to 80Vdc. Therefore the maximum V-sense is also 80Vdc.

Typical connection of PEL-500 series load module

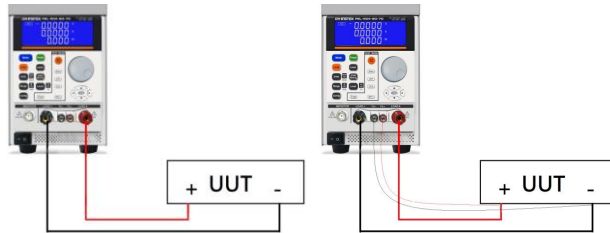

Connecting the I-monitor to an oscilloscope

When you connect this product to an oscilloscope, please ensure the correct polarities of the connecting probes as shown in fig below.

(Correct)
Connections to
an oscilloscope

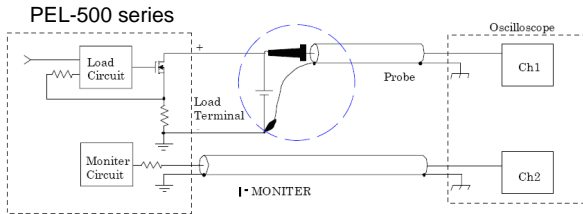

(Wrong)
Connections to
an oscilloscope

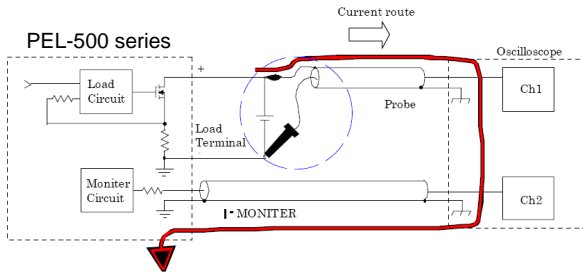

If the probes connection is reversed as shown above, a large current would flow through the probe and the internal circuitry of the oscilloscope is likely to be damaged.

LCD Display

The following sketch shows the layout of the front panel of the unit. Please refer to the relevant section as indicated by the number assigned to a front panel function.



- | | |
|--|--|
| 1 Model number and sink ranges | The model number along with maximum voltage, current and power values are detailed in this position at the top of the load front panel. |
| 2 Mode key and CC, CR, CV, CP Indicators | There are four operating modes that can be selected by pressing the "MODE" key on the PEL-500 series Electronic Load module.

The sequence is Constant Current (CC), Constant Resistance (CR), Constant Voltage (CV), and Constant Power (CP). Each time the "MODE" key is pressed, the operating mode is changed. The actual operating mode selected is indicated on the left hand side of the LCD. |
| 3 NG LCD Indicator | The user can adjust upper and lower limits for voltage, current and power within the CONFIG menu and turn the NG Indicator ON. If a voltmeter, ammeter or wattmeter measurement is outside these set limits then the NG indicator will illuminate. |
| 4 Remote LCD Indicator | If the REMOTE LCD Indicator is illuminated this means that the unit is operating remotely |

	via one of the optional interfaces. While REMOTE is lit it is not possible to make settings manually at the front panel. The LOCAL button on the mainframe can be used to revert back to front panel control. When the unit is operating from the front panel the REMOTE LCD will not be illuminated.
5 Upper 5 digit LCD display	The 5 digit LCD display is a multi-function display. The function of the display changes depending whether the user is in NORMAL mode or in a SHORT, OPP or OCP modes:
Normal mode	The upper 5 digit display displays the voltage present at the load's input terminals. The value displayed will include the automatic voltage compensation if the sense terminals are also connected to the device under test (DUT).
 Note	<p>If V-sense is set to "AUTO" and the sense leads are connected to the DUT the losses need to be approx.</p> <p>If V-sense is set to "ON" and the sense terminals are connected to the DUT, the load will check and compensate for all voltage drops.</p>
Test mode	<p>If the SHORT, OPP or OCP buttons are pressed the upper display will show a text Message that correlates with the selected test function.</p> <ul style="list-style-type: none"> • SHORT test selected: upper display will show "Short". • OPP test selected: upper display will show "OPP". • OCP test selected: upper display will show "OCP". <p>During the test, the upper display will show the load Input voltage.</p>
6 Middle 5 digit LCD display	The middle 5 digit displays also changes function depending if the user is in normal mode or has entered a setting menu.

Normal mode	In normal mode the middle LCD display functions as a 5 digit ammeter. The 5 digit DAM shows the load current flowing into the DC load when the Load is ON.
-------------	--

Setting mode	If CONFIG, LIMIT, DYN, SHORT, OPP or OCP buttons are pressed, The middle LCD shows a text message according to the setting function it is in. Each subsequent press of the button moves the display to the next available function.
--------------	---

The sequence of each setting menu is detailed below

- CONFIG:
Sequence is "SENSE" → "LDon" → "LDOff" → "POLAR"
 - LIMIT:
Sequence is "V_Hi" → "V_Lo" → "I_Hi" → "I_Lo" → "W_Hi" → "W_Lo" → "NG"
 - DYN setting:
Sequence is "T-Hi" → "T-Lo" → "RISE" → "FALL"
 - SURGE:
Sequence is "SUR_I" → "NOR_I" → "S.TIME" → "S.STEP."
 - BATT:
Sequence is "MODE" → "CC" → "VOLT.V" → "MODE" → "CC" → "VOLT.V" → "TIME.S" → "CAP.AH" → "CAP.WH."
 - SHORT:
Sequence is "PRESS" → "TIME" → "V_Hi" → "V_Lo"
 - OPP:
Sequence is "PSTAR" → "PSTEP" → "PSTOP" → "Vth"
 - OCP:
Sequence is "ISTAR" → "ISTEP" → "ISTOP"
-

→ "Vth"

7 Lower 5 digit LCD display	The lower 5 digit display also changes function depending if the unit is in normal mode or one of the setting menus has been activated.
Normal mode	In normal mode the lower 5 digit display shows the power consumption in Watts (W).
Setting mode	The lower display together with the rotary adjustment knob is used to set values. The value changes according to the setting function that is active. The middle LCD provides a text message to tell the user which part of the setting menu is active.
PRESET mode	<p>The value of the setting entered on the lower display changes depending on the operating MODE that has been selected.</p> <ul style="list-style-type: none"> • If CC mode is selected the right display provides setting in amps "A". • If CR mode is selected the right display provides setting in ohms "Ω" • If CP mode is selected the right display provides setting in watts "W". • If CV mode is selected the right display provides setting in volts "V".
Limit	<p>Each press of the LIMIT button changes the middle LCD text. The sequence and the corresponding setting value shown on the bottom display are as follows:</p> <ul style="list-style-type: none"> • V_Hi (upper limit voltage) displays the set value in volts "V". • V_Lo (lower limit voltage) displays the set value in volts "V". • I_Hi (upper limit current) displays the set value in amps "A". • I_Lo (lower limit current) displays the set value in amps "A".

- W_Hi (upper limit power) displays the set value in watts "W".
- W_Lo (lower limit power) displays the set value in watts "W".
- NG displays whether the NG flag is set to "ON" or "OFF".

DYN Setting

Each press of the DYN setting button changes the text on the middle LCD. The sequence and the corresponding setting value shown on the bottom display are as follows:

- T-Hi (time high) displays the set value in milliseconds "ms"
- T-Low (time low) displays the set value in milliseconds "ms"
- Rise (current rise time/slew rate) displays the set value in "A/us" or "A/ms"
- Fall (current fall time/slew rate) displays the set value in "A/us" or "A/ms"

CONFIG

Each press of the CONFIG button changes the middle LCD Text.

The sequence and the corresponding setting value shown on the bottom displays are as follows:

- SENSE can be set to "AUTO" or "ON"
- LDon (load ON voltage) displays the set value in volts "V"
- LDoff (load OFF voltage) displays the set value in volts "V"
- POLAR (load polarity) can be set to "+LOAD" or "-LOAD"

SHORT test

This allows the parameters of the short test to be set up.

Each press of the SHORT button moves the setting function.

The sequence of the short test along with the

setting value is as follows:

- Short Press Start (pressing the red START/STOP button starts the test).
- TIME shows the duration of the SHORT test. "CONTI", on the bottom display indicates continuous. Time can be adjusted in "ms".
- V-Hi (voltage high threshold) displays the set value in volts "V"
- V-Lo (voltage low threshold) displays the set value in volts "V"

When the test is started the lower display will show RUN. When the test has finished the lower display will show END.

OPP test

This allows the parameters of the over power protection test to be set up. Each press of the OPP button moves the setting function. The sequence of the OPP test along with the setting value is as follows:

- OPP Press Start (pressing the red START/STOP button starts the test)
- PSTAR (power start point) lower display provides setting in watts "W"
- PSTEP (power steps) lower display provides setting in watts "W"
- PSTOP (power stop point) lower display provides setting in watts "W"
- VTH (voltage threshold) lower display provides setting in volts "V"

When the test is started the lower display will show the power value being taken by the load. If the Device Under Test is able to supply the load according to the values set then the middle display will show PASS and the lower display will show the maximum power taken during the OPP test. If, during the test, OTP is displayed the over temperature protection has

been engaged. Similarly if OPP is shown on the display the over power protection has been activated.

OCP test

This allows the parameters of the over current protection test to be set up. Each press of the OCP button moves the setting function.

The sequence of the OCP test along with the setting value is as follows:

- OCP Press Start (pressing the red START/STOP button starts the test)
- ISTAR (current start point) lower display provides setting in amps "A"
- ISTEP (current steps) lower display provides setting in amps "A"
- ISTOP (current stop point) lower display provides setting in amps "A"
- VTH (voltage threshold) lower display provides setting in volts "V"

When the test is started the lower display will show the current value being taken by the load. If the Device Under Test is able to supply the load according to the values set then the middle display will show PASS and the lower display will show the maximum current taken during the OCP test. If, during the test, OTP is displayed the over temperature protection has been engaged. Similarly if OPP is shown on the display the over power protection has been activated.

Rear Panel

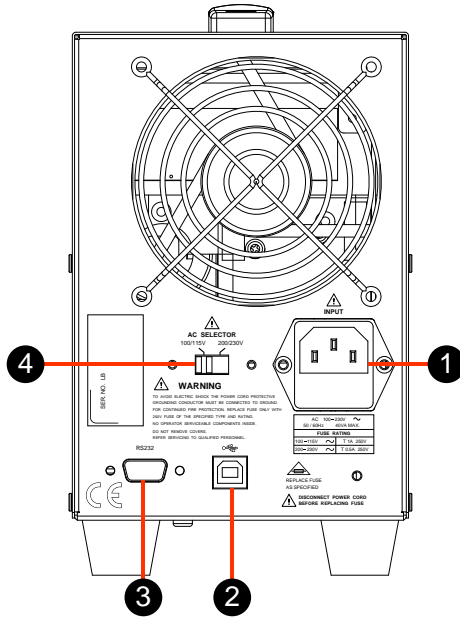

1 Line voltage input	The input is for power line voltage only. Before powering the unit on, please check the voltage setting in order to make sure it meets your local requirements.
2 USB terminal	USB interface
3 RS-232 terminal	RS-232 interface
4 Power-line voltage selector	There are 100/115V and 200/230V options

INSTALLATION

The PEL-500 series was carefully inspected, tested and calibrated before shipment. If damage to the instrument has occurred during transport, please inform GW Instek sales and service office or representative. Your PEL-500 series was shipped with a power cord for the type of outlet used at your location. If the appropriate cord was not included, please contact your nearest sales office to obtain the correct cord. Refer to “check line voltage” to check the line voltage selection and fuse type.

Check line voltage.....	65
Power up.....	66
USB & RS232 interface option	66
Load wire inductance.....	67
Input terminal and wire consideration.....	71

Check line voltage

Background The PEL-500 series can be operated from a 100/115 or 200/230Vac input as indicated on the label on the rear panel. The input is switchable so please make sure that the switch is set correctly for your nominal mains input before turning on the mains power. The procedure below details how to change the switch position:

- Installation**
1. With the PEL-500 series power OFF, disconnect the power cord.
 2. Refer the drawing on the rear panel in Fig below. set the switches to the proper voltage as described in the following:
 - a. Set switch to 100V/115V for 115Vac line voltage
 - b. Set switch to 200V/230V for 230Vac line voltage



Note

100Vac and 200Vac is used for Japan only (Option)

Setting of switch

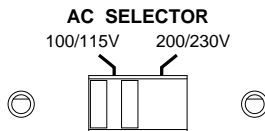

Power up

The following procedure should be followed before applying mains power:

- | | |
|-----------|---|
| Procedure | <ol style="list-style-type: none">1. Check that the power switch is in the off (O) position.2. Check the rear panel voltage selector of the PEL-500 series is correctly set.3. Check that nothing is connected to the DC INPUT (load input terminals) on the front panel of the PEL-500 series load.4. Connect correct AC mains lead to the PEL-500 series.5. Turn on the power switch. |
|-----------|---|
-

USB & RS232 interface option

Fig below shows the RS232 & USB interface (Female) on the rear panel. This connects the PEL-500 series to RS232 port of computer.

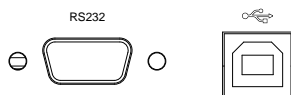

Load wire inductance

Connection procedure of the load input terminal on the rear panel

The load wiring has an inductance (L). When the current (I) varies in short time period, It generates a large voltage at both ends of the wiring cable. This voltage applies to all of the load input terminals of the PEL-500 Series when the impedance of the EUT is relatively small. The voltage generated by the load wire inductance (L) and the current variation (I) is expressed using the following equation.

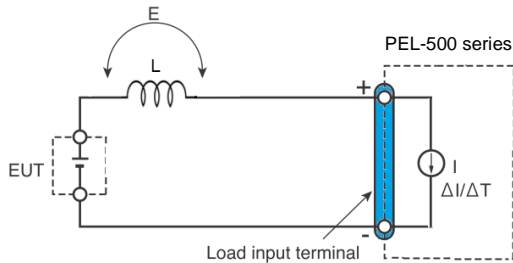

$$E = L \times (\Delta I / \Delta T)$$

E: Voltage generated by the wire inductance

L: Load wire inductance

ΔI : Amount of Current variation

ΔT : Variation period of current

In general, the wire inductance can be measured approximately 1 μH per 1 meter. If the 10 meters of Load wires is connected between the EUT and the electronic load (PEL-500 Series) with the current Variation of 2 A/ μs , the voltage generated by the wire inductance Will be 20 V.

The negative polarity of the load input terminal is the reference potential of the external Control signal, Therefore, the device connected to the external control terminal may get malfunctioned.

When operating under the constant voltage (CV) mode or constant resistance (CR) mode or constant power (CP), the load current is varied by the voltage at the load input terminal, so the operation can be affected easily by the generated voltage.

The wiring to the EUT should be twisted and the shortest as possible.

If the load wire is long or has a large loop, the wire inductance is increased. Consequently, the Current variation that results when switching occurs will cause a large voltage drop.

When the value of instantaneous voltage drops under the minimum operating voltage depends on the generated voltage at the load input terminal, the response of recovery will be extensively delayed.

In such event, the electronic load may generate unstable oscillation. In such condition, the input voltage may exceed the maximum input voltage and cause damage to the PEL-500 series.

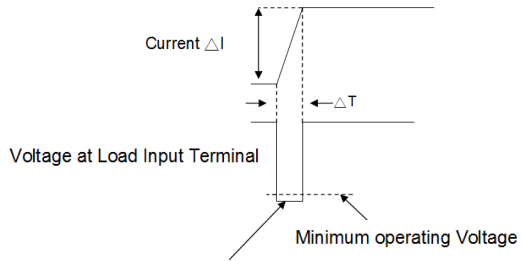

When the Voltage drops under minimum operating voltage, the electronic load may generate unstable oscillation

Waveform example:
Generate unstable oscillation

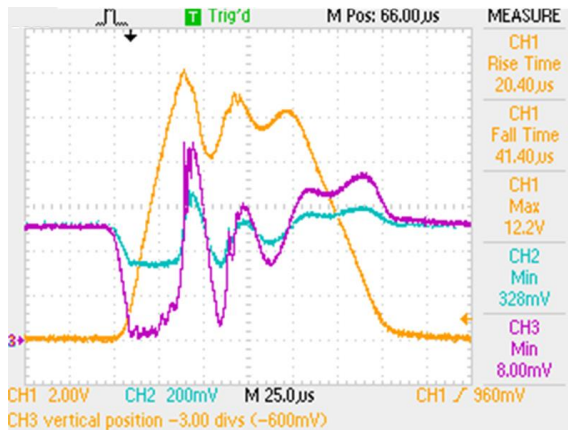

CH1= Imonitor

CH2=Power Supply output Voltage (x10)

CH3= LOAD Input Voltage (x10)

You must be careful especially when the slew rate setting is high or switching is performed using large currents through parallel operation.

To prevent problems, connect the PEL-500 series and the equipment under test using the shortest Twisted Wire possible to keep the voltage caused by inductance between the minimum operating Voltage and the maximum input voltage range or set a low slew rate.

If the high-speed response operation is not required, decrease the slew rate setting.

In such settings, the value of DI / DT will be decreased, accordingly the generated voltage Will be reduced even the inductance of load wiring can't be reduced.

In the case of DC operation also, the phase delay of the current may cause instability in the PEL-500 series Control inducing oscillation. In this case also, connect the PEL-500 series and the equipment under test using the shortest twisted wire possible.

If only DC operation is required, a capacitor may be connected to the load Input Terminal as shown in Fig below to alleviate oscillation. In this case, use the capacitor within its Allowable ripple current.

Length of wiring

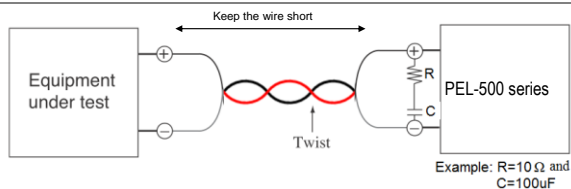

Input terminal and wire consideration

The Load input terminals are rated at 70A. Please note that the banana plug and spade/hook connectors provided in the accessory pack have a current rating of 20A. Please be sure to use the correct connection method if sinking high currents. There are five ways to connect the Device under Test (DUT) to the Electronic Load as detailed below.

Plug connectors	This is the most popular way to connect the input of electronic load to the device under test. It is recommended that the load current is less than 20A to keep within the current rating of the plug. A maximum wire gauge of AWG14 can be used in this application.
Spade/Hook terminals	The spade terminals provide a good contact to the binding posts. The spade terminals provided in the accessory pack are rated at 20A. The maximum wire gauge of AWG10 can be used for this connection method.
Insert the wire into the input terminal	Unscrewing the binding post will reveal a hole. The wire from the output of the DUT can be pushed into this hole and the binding post tightened to clamp the wire. The Maximum wire gauge is AWG14.
Both plug connectors and spade terminals	It is recommended to use this method when input current is greater than 20A or if long load wires are used between the DUT and the load module.
Both plug connectors and Insert the wire into the input terminal	It is recommended to use this method when the input current is greater than 20A or long wires are needed to connect the DUT to the load module.

A major consideration in making the input connection is the wire size. The minimum wire size is required to prevent overheating and to maintain good regulation. It is recommended that the wires should be large enough to limit the voltage drop to less than 0.5V per lead.

Hook Terminal Y type
large size terminal
connections

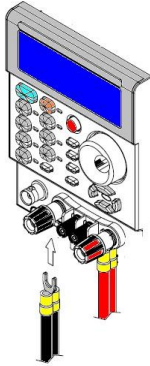

Wire/Cable Guide

The following table provides a guide to the current carrying capability (ampacity) of Both Metric and AWG sizes. Metric sizes are expressed as a cross sectional areas (CSA). If in any doubt of a cables ampacity it is recommended that you ask your cable supplier.

Note Ratings for AWG-sized wires derived from MIL-W-5088B. Ratings for metric-sized wires derived from IEC Publication.

Wire Size AWG	Ampacity(A)	CSA(mm ²)	Ampacity of aluminum wire is approximately 84% of that listed for copper wire.
22	5.0	-----	When two or more wires are bundled together, ampacity for each wire must be reduced to the following percentages: 2 conductors 94% 3 conductors 89% 4 conductors 83% 5 conductors 76% 4. Maximum temperatures: Ambient = 50° C Conductor = 105° C
20	8.33	-----	
---	10	0.75	
18	15.4	-----	
---	13.5	1	
16		-----	
---	16	1.5	
14	31.2	-----	
---	25	2.5	
12	40	-----	
---	32	4	
10	55	-----	
---	40	6	
8	75	-----	
---	63	10	
6	100	-----	
4	135	-----	

Table Stranded Copper Wire Ampere Capacity

REMOTE CONTROL

If your unit is fitted with a computer interface option then a RS232, USB socket will be present on the rear panel according to what was ordered. The interface allows the load settings to be configured remotely and measurements read back.

There are two sets of programming terms for the PEL-500 series. One is referred to as the SIMPLE format and the other is COMPLEX format.

Interface Configuration	75
Configure RS232C	75
Communication Interface programming command list.....	77
SIMPLE TYPE FORMAT	77
COMPLEX TYPE FORMAT	81
Command Syntax	86
The description of abbreviation	86
Communication Interface programming command syntax description	86
Command List	88

Interface Configuration

Configure RS232C

The RS232C protocol in PEL-500 Series mainframe is listing below:

RS232C Configuration	Baud Rate	115200bps
	Stop Bit	1 bit
	Data Bit	8 bits
	Parity	None
	Handshaking	Hardware (RTS/CTS)

The RS232 Interface connector of PEL-500 Series rear panel

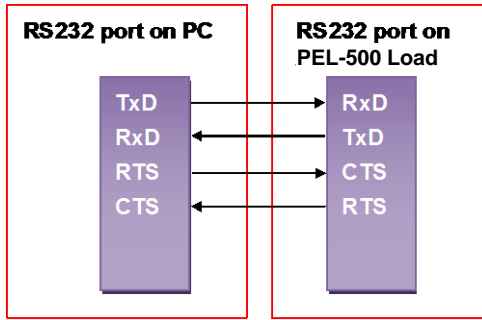

Inside of PEL-500 series Mainframe

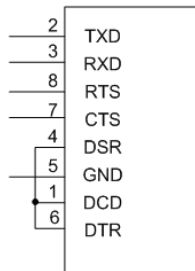

Pin Assignment

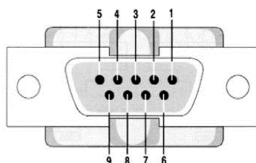

Table PC RS232
port

PIN	Abbreviation	Description
Pin1	CD	Carrier Detect
Pin2	RXD	Receive
Pin3	TXD	Transmit
Pin4	DTR	Data Terminal Ready
Pin5	GND	Ground
Pin6	DSR	Data Set Ready
Pin7	RTS	Request To Send
Pin8	CTS	Clear To Send
Pin9	RI	Ring Indicator

Communication Interface programming command list

SIMPLE TYPE FORMAT

Table: Communication interface programming setting command summary

SETTING PRESET NUMERIC COMMAND	Note
RISE{SP}{NR2}{; NL}	A/us
FALL{SP}{; NL}	A/us
PERD:{HIGH LOW}{SP}{NR2}{; NL}	
LDONV{SP}{NR2}{; NL}	
LDOFFV{SP}{NR2}{; NL}	
CC CURR:{HIGH LOW}{SP}{NR2}{; NL}	
CP:{HIGH LOW}{SP}{NR2}{; NL}	
CR RES:{HIGH LOW}{SP}{NR2}{; NL}	
CV VOLT:{HIGH LOW}{SP}{NR2}{; NL}	
TCONFIG{SP}{NORMAL OCP OPP SHORT}{; NL}	
OCP:START{SP}{NR2}{; NL}	
OCP:STEP{SP}{NR2}{; NL}	
OCP:STOP{SP}{NR2}{; NL}	
VTH{SP}{NR2}{; NL}	
OPP:START{SP}{NR2}{; NL}	
OPP:STEP{SP}{NR2}{; NL}	
OPP:STOP{SP}{NR2}{; NL}	
STIME{SP}{NR2}{; NL}	
BATT:UVP{SP}{NR2}{; NL}	unit: V
BATT:TIME{SP}{n}{; NL}	n= 1~99999sec, 0=OFF
BATT:TEST{SP}{ON OFF}{; NL}	ON: Start test, OFF: Stop test
BATT:AH{SP}{NR2}{; NL}	
BATT:WH{SP}{NR2}{; NL}	

TESTING{?}; NL}	0: TEST END, 1: TESTING
SURGE:SURI{NR2}; NL}	
SURGE:NORI{NR2}; NL}	
SURGE:TIME{NR2}; NL}	SURGE TIME: 10~1000ms
SURGE:STEP{SP}{n}; NL}	n=1~5
SURGE{ON OFF}; NL}	ON: RUN SURGE, OFF: STOP

Table: Communication Interface programming query command summary

QUERY PRESET NUMERIC COMMAND	RETURN
RISE{?}; NL}	###.####
FALL{?}; NL}	###.####
PERI PERD:{HIGH LOW}{?}; NL}	###.####
LDONv{?}; NL}	###.####
LDOFfv{?}; NL}	###.####
CC CURR:{HIGH LOW}{?}; NL}	###.####
CP:{HIGH LOW}{?}; NL}	###.####
CR RES:{HIGH LOW}{?}; NL}	###.####
CV VOLT:{HIGH LOW}{?}; NL}	###.####
TCONFIG{?}; NL}	1: NORMAL, 2: OCP, 3: OPP, 4: SHORT
OCP:START{?}; NL}	###.####
OCP:STEP{?}; NL}	###.####
OCP:STOP{?}; NL}	###.####
VTH{?}; NL}	###.####
OPP:START{?}; NL}	###.####
OPP:STEP{?}; NL}	###.####
OPP:STOP{?}; NL}	###.####
STIME{?}; NL}	###.####
OCP{?}; NL}	###.####
OPP{?}; NL}	###.####
BATT:AH{?}; NL}	
BATT:WH{?}; NL}	

BATT:RTIME{?}; | NL}
 BATT:TIME{?}; | NL}
 BATT:RAH{?}; | NL}
 BATT:RWH{?}; | NL}
 BATT:RVOLT{?}; | NL}
 SURGE:SURI{?}; | NL}
 SURGE:NORI{?}; | NL}
 SURGE:TIME{?}; | NL}
 SURGE:STEP{?}; | NL}

Table: Communication Interface programming limit command summary

LIMIT COMMAND	RETURN
IH IL{SP}{NR2}; NL}	
IH IL{?}; NL}	
WH WL{SP}{NR2}; NL}	
WH WL{?}; NL}	###.####
VH VL{SP}{NR2}; NL}	
VH VL{?}; NL}	###.####
SVH SVL{SP}{NR2}; NL}	
SVH SVL{?}; NL}	###.####

Table: STAGE COMMAND SUMMARY

STAGE COMMAND	REMARK
LOAD{SP}{ON OFF}; NL}	
LOAD{?}; NL}	0: OFF, 1: ON
MODE{SP}{CC CR CV CP}; NL}	
MODE{SP}{CC CR CV}; NL}	
MODE{?}; NL}	0: CC, 1: CR, 2: CV, 3: CP
SHORT{SP}{ON OFF}; NL}	
SHORT{?}; NL}	0: OFF, 1: ON
PRESet{SP}{ON OFF}; NL}	
PRESet{?}; NL}	0: OFF, 1: ON
SENSe{SP}{ON AUTO}; NL}	
SENSe{SP}{ON OFF}; NL}	

SENSe{?}; NL}	0: OFF/AUTO, 1: ON
LEVEI{SP}{ LOW HIGH}; NL}	
LEVEI{?}; NL}	0: LOW, 1: HIGH
LEV{SP}{ LOW HIGH}; NL}	
LEV{?}; NL}	0: LOW, 1: HIGH
DYN{SP}{ LOW HIGH}; NL}	
DYN{?}; NL}	0: OFF, 1: ON
CLRerr; NL}	
ERRor{?}; NL}	
NG{?}; NL}	0: GO, 1: NG
PROtect {?}; NL}	
CCR{SP}{AUTO R2}; NL}(NOTE 1)	
NGENABLE{SP}{ON OFF}; NL}	
POLAR{SP}{POS NEG}; NL}	
START; NL}	
STOP; NL}	
TESTING{?}; NL}	0: TEST END, 1: TESTING

Table: SYSTEM COMMAND SUMMARY

COMMAND	NOTE	RETURN
RECALL{SP}{m[,n] }; NL}	m=1~10, n=1~15, m: STATE, n: BANK	
STORE{SP}{m[,n] }; NL}	m=1~10, n=1~15, m: STATE, n: BANK	
REMOTE; NL}	RS232/USB command	
LOCAL; NL}	RS232/USB command	
NAME{?}; NL}		“XXXXX”
*RST {; NL}		

Table: MEASURE COMMAND SUMMARY

MEASURE COMMAND	RETURN
MEAS:CURR{?}; NL}	###.####
MEAS:VOLT{?}; NL}	###.####
MEAS:POW{?}; NL}	###.####
MEAS:VC{?}; NL}	###.####.###.####

Remark	<ol style="list-style-type: none"> 1. The current unit is Ampere (A) 2. The resistance is in ohms(Ω) 3. The voltage is in volts (V) 4. The period unit is milliseconds (mS) 5. Slew-rate is in milliamps per microsecond(A/μS) 6. The power unit is watts (W)
--------	--

COMPLEX TYPE FORMAT

Table: Communication Interface programming setting command summary

SETTING PRESET NUMERIC COMMAND	Note
[PRESet:]RISE{SP}{NR2}{; NL}	A/us
[PRESet:]FALL{SP}{; NL}	A/us
[PRESet:]PERI PERD:{HIGH LOW}{SP}{NR2}{; NL}	
[PRESet:]LDONv{SP}{NR2}{; NL}	
[PRESet:]LDOFfv{SP}{NR2}{; NL}	
[PRESet:]CC CURR:{HIGH LOW}{SP}{NR2}{; NL}	
[PRESet:]CP:{HIGH LOW}{SP}{NR2}{; NL}	
[PRESet:]CR RES:{HIGH LOW}{SP}{NR2}{; NL}	
[PRESet:]CV VOLT:{HIGH LOW}{SP}{NR2}{; NL}	
[PRESet:]TCONFIG{SP}{NORMAL OCP OPP SHORT}{; NL}	
[PRESet:]OCP:START{SP}{NR2}{; NL}	
[PRESet:]OCP:STEP{SP}{NR2}{; NL}	
[PRESet:]OCP:STOP{SP}{NR2}{; NL}	
[PRESet:]VTH{SP}{NR2}{; NL}	
[PRESet:]OPP:START{SP}{NR2}{; NL}	
[PRESet:]OPP:STEP{SP}{NR2}{; NL}	
[PRESet:]OPP:STOP{SP}{NR2}{; NL}	
[PRESet:]STIME{SP}{NR2}{; NL}	
[PRESet:]BATT:UVP{SP}{NR2}{; NL}	
[PRESet:]BATT:TIME{SP}{n}{; NL}	

[PRESet:]BATT:TEST{SP}{ON | OFF}{;} | NL}

[PRESet:]BATT:AH{SP}{NR2}{;} | NL}

[PRESet:]BATT:WH{SP}{NR2}{;} | NL}

[PRESet:]TESTING{?}{;} | NL}

[PRESet:]SURGE:SURI{NR2}{;} | NL}

[PRESet:]SURGE:NORI{NR2}{;} | NL}

[PRESet:]SURGE:TIME{NR2}{;} | NL}

[PRESet:]SURGE:STEP{SP}{n}{;} | NL}

[PRESet:]SURGE{ON | OFF}{;} | NL}

Table: Communication Interface programming query command summary

QUERY PRESET NUMERIC COMMAND	RETURN
[PRESet:]RISE{?}{;} NL}	###.####
[PRESet:]FALL{?}{;} NL}	###.####
[PRESet:]PERI PERD:{HIGH LOW}{?}{;} NL}	###.####
[PRESet:]LDONv{?}{;} NL}	###.####
[PRESet:]LDOFfv{?}{;} NL}	###.####
[PRESet:]CC CURR:{HIGH LOW}{?}{;} NL}	###.####
[PRESet:]CP:{HIGH LOW}{?}{;} NL}	###.####
[PRESet:]CR RES:{HIGH LOW}{?}{;} NL}	###.####
[PRESet:]CV VOLT:{HIGH LOW}{?}{;} NL}	###.####
[PRESet:]TCONFIG{?}{;} NL}	1: NORMAL, 2: OCP, 3: OPP, 4: SHORT
[PRESet:]OCP:START{?}{;} NL}	###.####
[PRESet:]OCP:STEP{?}{;} NL}	###.####
[PRESet:]OCP:STOP{?}{;} NL}	###.####
[PRESet:]VTH{?}{;} NL}	###.####
[PRESet:]OPP:START{?}{;} NL}	###.####
[PRESet:]OPP:STEP{?}{;} NL}	###.####
[PRESet:]OPP:STOP{?}{;} NL}	###.####
[PRESet:]STIME{?}{;} NL}	###.####
[PRESet:]BATT:AH{?}{;} NL}	
[PRESet:]BATT:WH{?}{;} NL}	
[PRESet:]BATT:RTIME{?}{;} NL}	

```
[PRESet:]BATT:TIME{?}; | NL}
[PRESet:]BATT:RAH{?}; | NL}
[PRESet:]BATT:RWH{?}; | NL}
[PRESet:]BATT:RVOLT{?}; | NL}
[PRESet:]SURGE:SURI{?}; | NL}
[PRESet:]SURGE:NORI{?}; | NL}
[PRESet:]SURGE:TIME{?}; | NL}
[PRESet:]SURGE:STEP{SP}{?}; | NL}
```

Table: Communication Interface programming limit command summary

LIMIT COMMAND	RETURN
LIMit:CURRent:{HIGH LOW}{SP}{NR2}; NL}	
LIMit:CURRent:{HIGH LOW}{?}; NL}	###.####
IH IL{SP}{NR2}; NL}	
IH IL{?}; NL}	
LIMit:POWer:{HIGH LOW}{SP}{NR2}; NL}	
LIMit:POWer:{HIGH LOW}{?}; NL}	###.####
WH WL{SP}{NR2}; NL}	
WH WL{?}; NL}	###.####
LIMit:VOLTag:e:{HIGH LOW}{SP}{NR2}; NL}	
LIMit:VOLTag:e:{HIGH LOW}{?}; NL}	###.####
VH VL{SP}{NR2}; NL}	
VH VL{?}; NL}	###.####
SVH SVL{SP}{NR2}; NL}	
SVH SVL{?}; NL}	###.####

Table: STAGE COMMAND SUMMARY

STAGE COMMAND	REMARK
[STATe:]LOAD{SP}{ON OFF}; NL}	
[STATe:]LOAD{?}; NL}	0: OFF, 1: ON
[STATe:]MODE{SP}{CC CR CV CP}; NL}	
[STATe:]MODE{?}; NL}	0: CC, 1: CR, 2: CV, 3: CP
[STATe:]SHORt{SP}{ON OFF}; NL}	
[STATe:]SHORt{?}; NL}	0: OFF, 1: ON

[STATe:]PRESet{SP}{ON OFF}; NL}	
[STATe:]PRESet{?}; NL}	0: OFF, 1: ON
[STATe:]SENSe{SP}{ON AUTO}; NL}	
[STATe:]SENSe{SP}{ON OFF}; NL}	
[STATe:]SENSe{?}; NL}	0: OFF/AUTO, 1: ON
[STATe:]LEVEI{SP}{ LOW HIGH}; NL}	
[STATe:]LEVEI{?}; NL}	0: LOW, 1: HIGH
[STATe:]LEV{SP}{ LOW HIGH}; NL}	
[STATe:]LEV{?}; NL}	0: LOW, 1: HIGH
[STATe:]DYNAmic{SP}{ LOW HIGH}; NL}	
[STATe:]DYNAmic{?}; NL}	0: OFF, 1: ON
[STATe:]CLR; NL}	
[STATe:]ERRor{?}; NL}	
[STATe:]NO{SP}GOOD{?}; NL}	0: GO, 1: NG
[STATe:]NG{?}; NL}	0: GO, 1: NG
[STATe:]PROTect {?}; NL}	
[STATe:]CCR{SP}{AUTO R2}; NL}(NOTE 1)	
[STATe:]NGENABLE{SP}{ON OFF}; NL}	
[STATe:]POLAR{SP}{POS NEG}; NL}	
[STATe:]START; NL}	
[STATe:]STOP; NL}	
[STATe:]TESTING{?}; NL}	0: TEST END, 1: TESTING

Table: SYSTEM COMMAND SUMMARY

COMMAND	NOTE	RETURN
[SYStem:]RECall{SP}{m [,n] } ; NL}	m=1~10, n=1~15	
[SYStem:]STORe{SP}{m [,n] } ; NL}	m=1~10, n=1~15	
[SYStem:]REMOTE; NL}	RS232/USB command	
[SYStem:]LOCAL; NL}	RS232/USB command	
[SYStem:]NAME{?}; NL}		“XXXXXX”
[SYStem:]*RST ; NL}		

Table: MEASURE COMMAND SUMMARY

COMMAND	RETURN
MEASure:CURRent{?}; NL}	###.####
MEASure:VOLTage{?}; NL}	###.####
MEASure:POW{?}; NL}	###.####
MEAS:VC{?}; NL}	###.####,###.####
Remark	<ol style="list-style-type: none"> 1. Current engineering unit: A/Arms 2. Resistance engineering unit: Ω 3. Voltage engineering unit: V/Vrms 4. Period engineering unit: mS 5. Frequency engineering unit: Hz. 6. Power engineering unit: W 7. Volt-Ampere engineering unit: VA

Command Syntax

The description of abbreviation

Command Tree	<p>SP: Space, the ASCII code is 20 Hexadecimal.</p> <p>;;Semicolon, Program line terminator, the ASCII code is 0A Hexadecimal.</p> <p>NL:New line, Program line terminator, the ASCII code is 0A Hexadecimal.</p> <p>NR2:Digits with decimal point. It can be accepted in the range and format of ###.#####.</p> <p>For Example:</p> <p>30.12345, 5.0</p>
--------------	---

Communication Interface programming command syntax description

{ }	The contents of the { } symbol must be used as a part or data of the GPIB command, it cannot be omitted.
[]	The contents of the [] symbol indicates the command can be used or not. It depends on the testing application.
	<p>This symbol means option. For example "LOW HIGH" means it can only use LOW or HIGH as the command, it can choose only one as the setting command.</p> <p>Terminator: You have to send the program line terminator character after send the command, the available command terminator characters which can be accepted in PEL-500 series mainframe is listed in table below</p>

LF
LF WITH EOI
CR , LF
CR , LF WITH EOI

Semicolon “;”:The semicolon “;” is a back-up command, the semicolon allows you to combine command statement on one line to create command message.

Command List

PRESET Commands.....	90
RISE.....	90
FALL.....	90
PERI or PERD.....	91
LDON _v	91
LDOFF _v	91
CURR: HIGH LOW.....	92
CP:{HIGH LOW}.....	92
CR RES:{HIGH LOW}.....	93
CV:{HIGH LOW}.....	93
OCP:START.....	94
OCP:STEP.....	94
OCP:STOP.....	94
VTH.....	95
OPP:START.....	95
OPP:STEP.....	95
OPP:STOP.....	95
TCONFIG.....	96
STIME.....	96
OCP.....	96
OPP.....	96
BATT:UVP.....	97
BATT:TIME.....	97
BATT:TEST.....	97
BATT:AH.....	97
BATT:WH.....	97
BATT:RTIME.....	98
BATT:RAH.....	98
BATT:RWH.....	98
BATT:RVOLT.....	98
SURGE:SURI.....	98
SURGE:NORI.....	99
SURGE:TIME.....	99
SURGE:STEP.....	99
SURGE:ON OFF.....	99
Limit Commands.....	100
[LIMit:]CURRent:{HIGH LOW} or IH IL.....	100
[LIMit:]POWer:{HIGH LOW} or WH WL.....	100
[LIMit:]VOLtage:{HIGH LOW} or VH VL.....	101
SVH SVL.....	101

STATE commands	102
[STATe:]LOAD{SP} {ON OFF}	102
[STATe:]MODE{SP} {CC CR CV CP}	102
[STATe:]SHORT{SP} {ON OFF}	103
[STATe:]PRESet{SP} {ON OFF}	103
[STATe:]SENSe{SP} {ON OFF AUTO}	103
[STATe:]LEVel{SP} {HI LOW} or LEV {SP} {HIGH LOW}	104
[STATe:]DYNamic{SP} {ON OFF}	104
[STATe:]CLR	105
[STATe:]NG?	105
[STATe:]PROTect ²	105
[STATe:]CCR{AUTO R2}	106
[STATe:]NGEABLE {ON OFF}	106
[STATe:]POLAR{POS NEG}	106
[STATe:]START	107
[STATe:]STOP	107
System Commands	108
[SYStem:]RECall{SP} m{n}	108
[SYStem:]STORe{SP} m{n}	108
[SYStem:]NAME?	109
[SYStem:]REMOTE	110
[SYStem:]LOCAL	110
Measure Commands	111
MEASure:CURRent?	111
MEASure:VOLTage?	111
MEASure:POWer?	111

PRESET Commands

Set and Read the Default of Load

RISE

Set →

→ Query

Description	<p>Set and read the RISE SLEW-RATE.</p> <ul style="list-style-type: none"> • The definition of RISE SLEW-RATE is load level change or dynamic load can be programmed of RISE and FALL are completely independent. • The value of RISE has to be included the number of the decimal point, otherwise the command will not be available. • The least significant number is the 3th behind the decimal point. • PEL-500 series will set to the maximum value of the model automatically when the set RISE is over the specification of Load. • The unit is A/uS.
-------------	--

Syntax [PRESet:]RISE {SP}{NR2}{;NL}

Query Syntax [PRESet:]RISE? {;NL}

FALL

Set →

→ Query

Description	<p>Set and read the FALL SLEW-RATE.</p> <ul style="list-style-type: none"> • The definition of FALL SLEW-RATE is load level change or dynamic load can be programmed of RISE and FALL are completely independent. • PEL-500 series will set to the maximum value of the model automatically when the FALL which has been set is over the specification of Load. • The unit is A/uS.
-------------	--

Syntax [PRESet:]FALL {SP}{;|NL}

Query Syntax [PRESet:]FALL? {;|NL}

Set →

→ Query

PERI or PERD

Description Set and read the TLOW and Thigh of DYNAMIC when loading.

- A period of loading waveform of DYNAMIC is combined by TLOW and THIGH.
- The value of TLOW and THIGH have to be included the number of the decimal point, otherwise the command will not be available.
- The least significant number is the 5th behind the decimal point.
- PEL-500 series will set the value of TLOW or THIGH automatically when the value which has been set is over the maximum of the Load.
- The unit is mS.

Syntax [PRESet:]PERI|PERD:HIGH|LOW{SP}{NR2}{;|NL}

Query Syntax [PRESet:]PERI|PERD:HIGH|LOW? {;|NL}

Set →

→ Query

LDONv

Description Set and read the voltage of LOAD ON. This command is for setting the load voltage value of LOAD ON.

Syntax [PRESet:]LDONv{SP}{NR2}{;|NL}

Query Syntax [PRESet:]LDONv ?{;|NL}

Set →

→ Query

LDOFfv

Description Set and read the voltage of LOAD OFF. This command is for setting the load voltage value of LOAD OFF.

Syntax [PRESet:]LDOFv{SP}{NR2}{;|NL}
 Query Syntax [PRESet:]LDOFv ?{;|NL}

CURR: HIGH|LOW

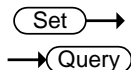

Description Set and read the current of HIGH | LOW. This command is for setting the required load current. And this command must be followed the next notices:

- The required value of current must be included the number of the decimal point, otherwise the command will not be available.
- The least significant number is the 5th behind the decimal point.
- PEL-500 series will set the maximum value of current of the load automatically when the value which has been set is over the maximum of the load.
- The value of LOW has to be smaller than HIGH.
- The unit is A

Syntax [PRESet:]CC|CURR:HIGH|LOW{SP}{NR2}{;|NL}
 Query Syntax [PRESet:]CC|CURR:HIGH|LOW?{;|NL}

CP:{HIGH|LOW}

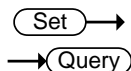

Description Set and read the value of Watt. This command is for setting the required value of Watt, and the unit is W.

Syntax [PRESet:]CP:{HIGH|LOW}{SP}{NR2}{;|NL}
 Query Syntax [PRESet:]CP:{HIGH|LOW}?{;|NL}

CR|RES:{HIGH|LOW}

Set →

→ Query

Description	<p>Set and read the value of resistance. This command is used for setting the required value of Load Resistance. And this command must be followed the next notices:</p> <ul style="list-style-type: none"> • The required value of resistance must be included the number of the decimal point, otherwise the command will not be available. • The least significant number is the 3rd behind the decimal point. • PEL-500 Series will set to the maximum value of the model automatically when the value of Resistance which has been set is over the specification of load. • The Resistance value which has been set of LOW has to be smaller than HIGH. • The unit is Ω.
Syntax	[PRESet:]CR RES:{HIGH LOW}{SP}{NR2}{; NL}
Query Syntax	[PRESet:]CR RES:{HIGH LOW}?{; NL}

CV:{HIGH|LOW}

Set →

→ Query

Description	<p>Set and Read the value of load voltage. This command is used for setting the required Load Voltage. And this command must be followed the next notices:</p> <ul style="list-style-type: none"> • The required value of resistance must be included the number of the decimal point, otherwise the command will not be available. • The least significant number is the 5th behind the decimal point. • PEL-500 Series will set to the maximum value of the model automatically when the value of voltage which has been set over the
-------------	--

specification of load.

- The Voltage value which has been set of LOW has to be smaller than HIGH.
- The unit is voltage (V)

Syntax [PRESet:]CV:{HIGH|LOW}{SP}{NR2}{;|NL}

Query Syntax [PRESet:]CV:{HIGH|LOW}?{;|NL}

OCP:START

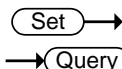

Description Set and read the initial value of OCP test. This command is used for setting the required initial value (I-START) of OCP test.

Syntax [PRESet:]OCP:START{SP}{NR2}{;|NL}

Query Syntax [PRESet:]OCP:START?{;|NL}

OCP:STEP

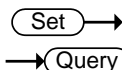

Description Set and read the increasing value of OCP test. This command is used for setting the increasing value (I-STEP) of OCP test.

Syntax [PRESet:]OCP:STEP{SP}{NR2}{;|NL}

Query Syntax [PRESet:]OCP:STEP?{;|NL}

OCP:STOP

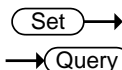

Description Set and read the maximum value of OCP test. This command is used for setting the maximum value (I-STOP) of OCP test.

Syntax [PRESet:]OCP:STOP{SP}{NR2}{;|NL}

Query Syntax [PRESet:]OCP:STOEP?{;|NL}

		Set →
		→ Query
<hr/>		
VTH		
Description	Set and read the value of the threshold voltage. This command is used for setting the Threshold Voltage. That is the OCP/OPP of this Load model when the output voltage of appliance is lower or equaled to the VTH.	
Syntax	[PRESet:]VTH{SP}{NR2}{; NL}	
Query Syntax	[PRESet:]VTH{?}{; NL}	
<hr/>		
		Set →
		→ Query
<hr/>		
OPP:START		
Description	Set and read the initial value of OPP test. This command is used for setting the required initial value (P-START) of OPP test.	
Syntax	[PRESet:]OPP:START{SP}{NR2}{; NL}	
Query Syntax	[PRESet:]OPP:START?{; NL}	
<hr/>		
		Set →
		→ Query
<hr/>		
OPP:STEP		
Description	Set and read the increasing value of OPP test. This command is used for setting the increasing value (P-STEP) of OPP test.	
Syntax	[PRESet:]OPP:STEP{SP}{NR2}{; NL}	
Query Syntax	[PRESet:]OPP:STEP?{; NL}	
<hr/>		
		Set →
		→ Query
<hr/>		
OPP:STOP		
Description	Set and read the maximum value of OPP test. This command is used for setting the maximum value (P-STOP) of OPP test.	
Syntax	[PRESet:]OPP:STOP{SP}{NR2}{; NL}	
Query Syntax	[PRESet:]OPP:STOP?{; NL}	
<hr/>		

Set →
→ Query

TCONFIG	
Description	Set and read the function of dynamic test. There are four options of this command. Those are NORMAL mode, OCP test, OPP test and SHORT test.
Syntax	[PRESet:] TONFIG{NORMAL OCP OVP OPP SHORT}{; NL}
Query Syntax	[PRESet:] TONFIG{?}{; NL}

Set →
→ Query

STIME	
Description	Set and read time of the short circuit test. This command is used for setting time of the short-circuit test. If time set to 0, it means that have no the time limit and continue to be short circuited. The unit is millisecond (ms)
Syntax	[PRESet:]STIME{SP}{NR2}{; NL}
Query Syntax	[PRESet:]STIME{?}{; NL}

→ Query

OCP	
Description	Read OCP testing current. This command is used for reading OCP current.
Query Syntax	OCP{?}

→ Query

OPP	
Description	Read OPP testing watt. This command is used for reading OPP watt.
Query Syntax	OPP{?}

BATT:UVP

Set →

Description Set UVP function. The command is used to set UVP (Under Voltage Protection). The unit is V.

Syntax [PRESet:] BATT:UVP {SP}{NR2}{;|NL}

BATT:TIME

Set →

→ Query

Description Set and read battery discharge time. This command is to set and read battery discharge time. n=1~99999, unit is second (S).

Syntax [PRESet:]BATT:TIME{SP}{n}{;|NL}

Query Syntax [PRESet:]BATT:TIME?{;|NL}

BATT:TEST

Set →

Description Set battery test. This command is to set battery test. ON: Start test, OFF: Stop test.

Syntax [PRESet:]BATT:TEST{SP}{ON|OFF}{;|NL}

BATT:AH

Set →

→ Query

Description Set and read BATT AH.

Syntax [PRESet:]BATT:AH{SP}{NR2}{;|NL}

Query Syntax [PRESet:]BATT:AH?{;|NL}

BATT:WH

Set →

→ Query

Description Set and read BATT WH

Syntax [PRESet:]BATT:WH{SP}{NR2}{;|NL}

Query Syntax [PRESet:]BATT:WH?{;|NL}

BATT:RTIME

→ Query

Description Read BATT RTIME. This command is used to read the battery result time.

Query Syntax [PRESet:]BATT:RTIME?{;|NL}

BATT:RAH

→ Query

Description Read BATT RAH. This command is used to read the battery result AH.

Query Syntax [PRESet:]BATT:RAH?{;|NL}

BATT:RWH

→ Query

Description Read BATT RWH. This command is used to read the battery result WH.

Query Syntax [PRESet:]BATT:RWH?{;|NL}

BATT:RVOLT

→ Query

Description Read BATT RVOLT. This command is used to read the battery result VOLT.

Query Syntax [PRESet:]BATT:RVOLT?{;|NL}

SURGE:SURI
 Set →
 → Query

Description Set and read the load current value of the surge current test. This command is set and read the load current value of the surge current test.

Syntax [PRESet:]SURGE:SURI{SP}{NR2}{;|NL}

Query Syntax [PRESet:]SURGE:SURI?{;|NL}

		Set →
		→ Query
<hr/>		
SURGE:NORI		
Description	Set and read the load current value of the Normal current test. This command is Set and read the load current value of the normal current test.	
Syntax	[PRESet:]SURGE: NORI{SP}{NR2}{;} NL}	
Query Syntax	[PRESet:]SURGE: NORI ?{;} NL}	
<hr/>		
		Set →
		→ Query
<hr/>		
SURGE:TIME		
Description	Set and read the surge current test time. This command is to set and read the surge current test time. Surge time: 10~1000ms.	
Syntax	[PRESet:]SURGE:TIME{SP}{NR2}{;} NL}	
Query Syntax	[PRESet:]SURGE:TIME?{;} NL}	
<hr/>		
		Set →
		→ Query
<hr/>		
SURGE:STEP		
Description	Set and read the surge current test decrement current setting. This command is to set and read the surge current test decrement current setting. n=1~5	
Syntax	[PRESet:]SURGE:STEP{SP}{n}{;} NL}	
Query Syntax	[PRESet:]SURGE:STEP?{;} NL}	
<hr/>		
		Set →
		→ Query
<hr/>		
SURGE:ON OFF		
Description	Set and read surge mode ON or OFF. This command is to set and read the surge current ON or OFF, ON: Run surge, OFF: Stop surge.	
Syntax	[PRESet:]SURGE: ON OFF {;} NL}	
Query Syntax	[PRESet:]SURGE: ON OFF?{;} NL}	
<hr/>		

Limit Commands

Set and read the top and bottom of the Load judgment NG limit

[LIMit:]CURRent:{HIGH|LOW} or IH|IL Set →
→ Query

Description This command is to set the lower limit value of threshold current. When load sink current is lower than this lower limit value or higher than the upper limit value, NG indicating light will come on to indicate "NO GOOD".

Syntax [LIMit]:CURRent:{HIGH|LOW}{SP}{NR2 }{;|NL}
[IH|IL]{SP}{NR2}{;|NL}

Query Syntax [LIMit]:CURRent:{HIGH|LOW}{?}{;|NL}
[IH|IL]?{;|NL}

[LIMit:]POWer:{HIGH|LOW} or WH|WL Set →
→ Query

Description This command is to set the upper/lower limit value of threshold power (W). When power (W) is lower than this lower limit value or higher than the upper limit value, NG indicating light will come on to indicate "NO GOOD"

Syntax [LIMit]:POWer:{HIGH|LOW}{SP}{NR2 }{;|NL}
[WH|WL]{SP}{NR2}{;|NL}

Query Syntax [LIMit]:POWer:{HIGH|LOW}{?}{;|NL}
[WH|WL]?{;|NL}

[LIMit:]VOLTage:{HIGH|LOW} or VH|VL  →
 → 

Description This command is to set the upper/lower limit value of threshold voltage. When input voltage is lower than the lower limit value or higher than the upper limit value, NG indicating light will come on to indicate “NO GOOD”.

Syntax [LIMit:]VOLTage:{HIGH|LOW}{SP}{NR2}{;|NL}
 [VH|VL]{SP}{NR2}{;|NL}

Query Syntax [LIMit:]VOLTage:{HIGH|LOW}{?}{;|NL}
 [VH|VL] ?{;|NL}

SVH|SVL  →
 → 

Description This command is to set the upper/lower limit value of short current. When short current is lower than the lower limit value or higher than the upper limit value, NG indicating light will come on to indicate “NO GOOD”.

Syntax [LIMit:]{SVH|SVL}{SP}{NR2}{;|NL}

Query Syntax [LIMit:]{SVH|SVL}{?}{;|NL}

STATE commands

Set and read the status of Load

[STATE:]LOAD{SP}{ON|OFF}
Set →
 → Query

Description Set and read the status of Sink Current or not. This command is used for setting the status of Sink Current. When setting it to ON, the Load is going to sink current from appliance. When setting it to OFF, the Load would not act.

Syntax [STATE:]LOAD{SP}{ON|OFF}{;|NL}

Query Syntax [STATE:]LOAD?}{;|NL}

Parameter	0	OFF
	1	ON

[STATE:]MODE{SP}{CC|CR|CV|CP}
Set →
 → Query

Description Set and read the mode of LOAD. Load is acting under these four modes as the following table. When reading the Loading Operation mode, the return value 0 | 1 | 2 | 3 | are meant to be CC | CR | CV | CP

Syntax [STATE:]MODE{SP}{CC|CR|CV|CP}{;|NL}

Query Syntax [STATE:]MODE?}{;|NL}

Module for each series	Model	CC	CR	CV	CP
	(Value)	0	1	2	3
	PEL-500	V	V	V	V

[STATe:]SHORT{SP}{ON|OFF} (Set) →
→ (Query)

Description Set and read the short circuit test of load. This command is for setting the load to make a short circuit test. While setting for the ON, the V+, V- pin of load like short circuit status.

Syntax [STATe:] SHORT {SP}{ON|OFF}{ ;|NL}

Query Syntax [STATe:] SHORT ?{;|NL}

[STATe:]PRESet{SP}{ON|OFF} (Set) →
→ (Query)

Description Set the upper or lower digit multi-function meter to display the programming load level. This command is for select the left 5 digit LCD display to show current setting or DWM.

Pres ON: To select the LCD display to shows current setting.

Pres OFF: To select the LCD Display is “DWM”

Syntax [STATe:]PRESet{SP}{ON|OFF}{;|NL}

Query Syntax [STATe:]PRESet{?}{;|NL}

Parameter	0	OFF
	1	ON

[STATe:]SENSe{SP}{ON|OFF|AUTO} (Set) →
→ (Query)

Description Set and read the load voltage to read whether is carried by the VSENSE or not. This command is for setting the Load voltage to read whether is carried by VSENSE or INPUT Connector. When setting for ON, the voltage is got from VSENSE, and setting for OFF, the voltage is got from INPUT Connector. In PEL-500, the optional are ON and AUTO. So, if setting for AUTO, it means the voltage is got and read from VSENSE. But if no

voltage is inputted from VSENSE, the voltage will be inputted from INPUT Connector.

Syntax [STATe:]SENSe{SP}{ON|OFF|AUTO }{;|NL}

Query Syntax [STATe:]SENSe?){;|NL}

[STATe:]LEVEl{SP}{HI|LOW} or
LEV{SP}{HIGH|LOW}

Set →
→ Query

Description Set and read the LOW and HIGH of load. LEV LOW is a low level value of current on CC mode. It is a low level value of resistance on CR mode. It is a low level value of voltage on CV mode. It is a low level value of power on CP mode.

Syntax [STATe:]LEVEl{SP}{HIGH|LOW}{;|NL}

[STATe:]LEV{SP}{ HIGH|LOW}{;|NL}

Query Syntax [STATe:]LEVEl?){;|NL}

[STATe:]LEV?){;|NL}

Parameter	0	LOW
	1	HIGH

[STATe:]DYNAmic{SP}{ON|OFF}

Set →
→ Query

Description Set and read whether the status is dynamic or static of load

1. DYN ON, set for a DYNAMIC Load
2. DYN OFF, set for a STATIC Load

Syntax [STATe:]DYNAmic{SP}{ON|OFF}{;|NL}

Query Syntax [STATe:]DYNAmic?){;|NL}

[STATe:]CLR



Description Clear the error flag of PEL-500 series which during the period of working. This command is for clearing the contents in the register of PROT and ERR. After implementation, the contents of these two registers will be "0".

Syntax [STATe:]CLR{;|NL}

[STATe:]NG?



Description Query if there have NG flag in this PEL-500 series. Set command NG? To show the NG status. If "0" is set, the LCD of NG (NO GOOD) will be put out. If "1" is set, the LCD will be lit.

Query Syntax [STATe:]NG{?}{;|NL}

Return Parameter	0	GO
	1	NG

[STATe:]PROTeCt?

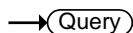

Description Query if there have protection flag which had been set in this PEL-500 series.

- PROT? Means the status of Protection of PEL-500. "1" means OPP occurred."4" means OVP. "8" means OCP. Table below shows the corresponding number of protection status.
- Use command CLR to clear the register of PROT status to be "0".

Query Syntax [STATe:]PROTeCt{?}{;|NL}

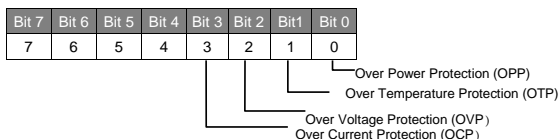

Register of PROT status	BIT ID	BIT VALUE	REMARK
	bit 0	0 = Off, 1 = Triggered	Over Power Protection (OPP)
	bit 1	0 = Off, 1 = Triggered	Over Temperature Protection (OTP)
	bit 2	0 = Off, 1 = Triggered	Over Voltage Protection (OVP)
	bit 3	0 = Off, 1 = Triggered	Over Current Protection (OCP)

[STATe:]CCR{AUTO|R2} Set →

Description Set the CC mode range to be forced to switch to RANGE II. It will switch the RANGE position automatically when setting for AUTO Set R2 when implementing RANGE II

Syntax [STATe:]CCR {AUTO|R2}{;|NL}

[STATe:]NGEABLE {ON|OFF} Set →

Description Set the GO/NG check function enable or disable. To set the function of NG judgment opens when POWER ON. When setting for POWER OFF, the function of NG judgment will not be implemented.

Syntax [STATe:]NGEABLE{ON|OFF}{;|NL}

[STATe:]POLAR{POS|NEG} Set →

Description Set for the display of the voltage meter shows the pole is contrary or not. Set the display of the voltage meter shows the pole. If it shows POS, it means the pole is not contrary. If the pole is contrary, it will show NEG.

Syntax [STATe:]POLAR{POS|NEG}{;|NL}

[STATe:]START**Set** →

Description Set for load to implement the test. According to TEST CONFIG (TCONFIG), the Load will start to test the items and parameters which are required

Syntax [STATe:]START{;|NL}

[STATe:]STOP**Set** →

Description Set for load to stop the test

Syntax [STATe:]STOP{;|NL}

System Commands

Set and Read the Status of PEL-500 series

[SYStem:]RECall{SP}m{n}

Set →

Description	<p>Recall the status of loading which had been saved in the Memory. This command is for recalling the status of Load which had been saved in the Memory.</p> <p>m(STATE)=1~10, n(BANK)=1~15.</p> <p>If the operating module is other series, omit “n” and it will be operated in the BANK which has been shown on the display.</p>
Syntax	[SYStem:]RECall{SP}m{n }{; NL}
Example	<p>RECALL 2,15</p> <p>Recall the status of loading which had been saved in the 2nd and 15th BANK of the memory.</p>
Example	<p>REC 3</p> <p>Recall the status of loading which had been saved in the 3rd of memory. If PEL-500 series is operated, it will be operated in the BANK which has been shown on the display.</p>

[SYStem:]STORe{SP}m{n}

Set →

Description	<p>Save the status of Loading to the Memory. This command is for saving the status of Loading to the Memory.</p> <p>m(STATE)=1~10, n(BANK)=1~15 .</p> <p>If PEL-500 series is operated, omit “n” and it will be operated in the BANK which has been shown on the display.</p>
-------------	---

Syntax [SYStem:] STORe{SP}m{n}{;|NL}

Example STORE 2,15

Save the status of loading which had been saved in the 2nd and 15th BANK of the memory.

Example STORE 3

Save the status of Loading to the 3rd memory. If it is operated with PEL-500, BANK will be set the BANK which shows on the display.



Note

Model	PEL-500
BANK(n)	15
STATE(m)	10
Total STATE	150

There are at most 15 banks for each model of PEL-500 series product, and at most 10 states for each bank. Therefore, there are at most 150 states totally.

[SYStem:]NAME?

→ Query

Description Read the model number of load. This command is for reading the model number of Load. It will be lit the model number as table

Table Model number

Model
PEL-503-80-50
PEL-504-80-70
PEL-504-500-15
PEL-507-80-140
PEL-507-500-30

Query Syntax [SYStem:]NAME{?}{;|NL}

[SYStem:]REMOTE**Set** →

Description	Command to enter the REMOTE status (only for RS232). This command is for controlling the RS232
-------------	--

Syntax	[SYStem:]REMOTE{; NL}
--------	-----------------------

[SYStem:]LOCAL**Set** →

Description	Command to exit the REMOTE status (only for RS232). This command is for finishing the RS232
-------------	---

Syntax	[SYStem:]LOCAL{; NL}
--------	----------------------

Measure Commands

Measure the actual current and voltage value of Load

MEASure:CURRent?

→ Query

Description	Read the current which is loading of Load. Read the five numbers of current meters, and the unit is Ampere (A)
-------------	--

Query Syntax	MEASure:CURRent{?}{; NL}
--------------	--------------------------

MEASure:VOLTage?

→ Query

Description	Read the voltage which is loading of Load. Read the five numbers of current meters, and the unit is Voltage (V)
-------------	---

Query Syntax	MEASure:VOLTage{?}{; NL}
--------------	--------------------------

MEASure:POWer?

→ Query

Description	Read the power which is loading of Load. Read the five numbers of current meters, and the unit is Watt (W)
-------------	--

Query Syntax	MEASure:POWer{?}{; NL}
--------------	------------------------

A APPLICATION

This chapter details the basic operating modes along with some common applications in which the PEL-500 series Electronic Load is used.

Local sense connections	113
Remote sense connections	114
Constant Current mode application	116
Static mode.....	116
Dynamic mode	117
CC Mode Operating Instructions	118
Constant Resistance mode application	120
Power supply power up sequence.....	120
CR Mode Operating Instructions	121
Constant Voltage mode application	123
Current source testing	123
Power supply current limit characterization.....	123
CV Mode Operating Instructions	124
Constant Power mode application	126
Battery Evaluation.....	126
CP Mode Operating Instructions.....	127
Zero-Volt loading application.....	130
PEL-500 series electronic load OCP, OPP, SHORT operation flow chart.....	131
Power Supply OCP testing	132
Power Supply OPP testing	134
SHORT testing.....	136

Local sense connections

Background

Local sensing is used in applications where the lead lengths are relatively short, or where load regulation is not critical. When connected in local sense mode the 5 digit voltage meter of the PEL-500 Series Electronic load measures the voltage at its DC input terminals. The connecting leads between the DUT and the Electronic Load should be bundled or tie wrapped together to minimize inductance.

The diagram below illustrates a typical set up with the electronic load connected to the DC power supply.

Local voltage sense connections

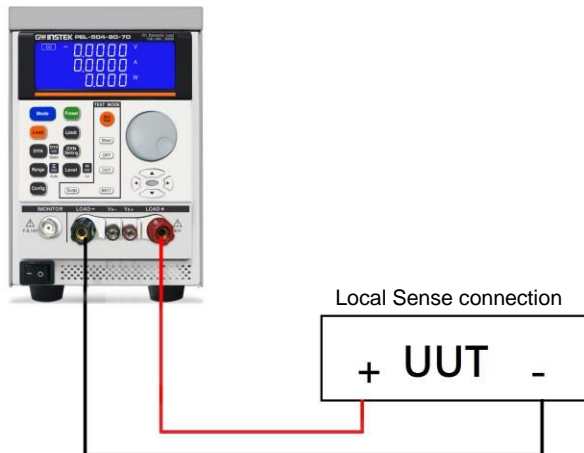

Remote sense connections

Background	<p>Remote sensing compensates for the voltage drop in applications that require long lead lengths. It is useful under low voltage high current conditions. The remote voltage sense terminals (Vs+) and (Vs-) of the load are connected to (+) and (-) output of the DC Source. Be sure to observe the correct polarity or damage may occur. The power and sense cables should be bundled or tie wrapped together to minimize inductance.</p> <p>The following diagram illustrates a typical set up with the electronic load connected for remote sense operation.</p> <p>Please note that if V-sense is set to AUTO and the sense leads are connected to the DUT the losses need to be approx. 1.2V (PEL-503-80-50, PEL-504-80-70, PEL-507-80-140) or 6V (PEL-504-500-15, PEL-507-500-30) before the display compensates for the voltage loss. If V-sense is set to 'ON' and the sense terminals are connected to the DUT the load will check and compensate for all voltage drops. The maximum voltage sense compensation is the same as the rating of the PEL-503-80-50.</p>
Example	<hr/> <p>Vmax of PEL-503-80-50 is 80Vdc so maximum Vsense is also 80Vdc.</p> <hr/>

Remote voltage
sense
connections

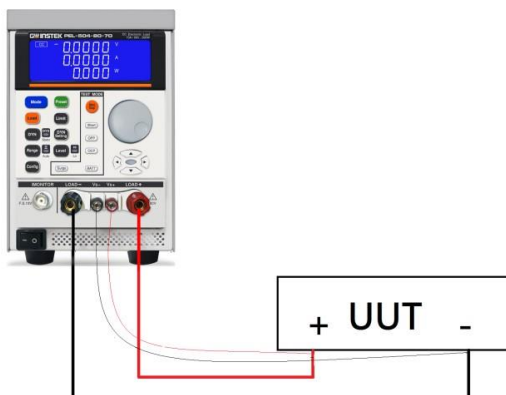

Constant Current mode application

The Constant Current (CC) mode is ideal for testing the Load Regulation, Cross Regulation, Output Voltage and Dynamic Regulation of the power supply under test. The CC mode can also be used to test the Discharge Characteristics and the Life Cycle of cells and battery packs. In CC operation the PEL-503-80-50 can operate as a static load with switchable high and low current levels. It is also possible to operate the load dynamically enabling the user to adjust sink current with time.

Static mode

Background

Major application areas include:

- Voltage source testing
- Power supply load regulation testing
- Battery discharge testing

Constant current mode application

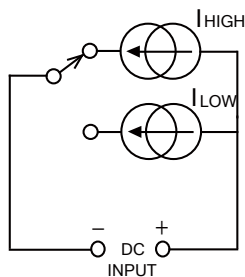
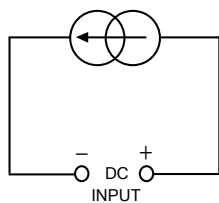
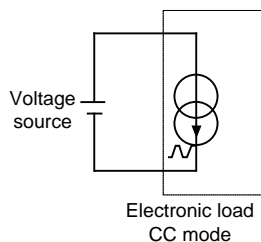
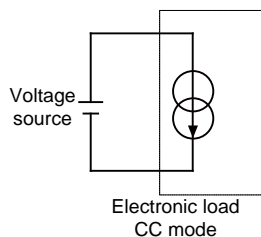

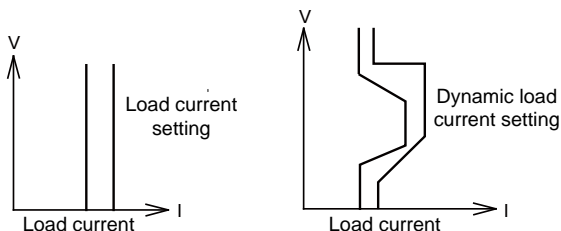

Dynamic mode

The built-in pulse generators allow the user to recreate real world loads that vary with time.

Background

Major application areas for dynamic operation in CC mode include:

- Power supply load transient response testing
- Power recovery time testing
- Battery Pulse load simulation
- Power component testing
- Two levels of current can be set and the rate of change between the 2 current levels can be adjusted in relation to time. The current rise (slew) rate and the current fall (slew) rate can be adjusted independently from each other and are further defined below.
- Rise slew rate = $| I_{low} - I_{high} | / T_a$ (A/us)
- Fall slew rate = $(I_{high} - I_{low}) / T_b$ (A/us)
- Rise time(T_a) = $(I_{low} - I_{high}) / \text{Rise slew rate}$
- Fall time(T_b) = $(I_{high} - I_{low}) / \text{Fall slew rate}$
- The time the waveform is high (T_{high}) and the time the waveform is low (T_{low}) can Also be adjusted. The diagram below shows the 6 adjustable parameters that define the dynamic waveform.

Dynamic load current with independent programmed Rise/Fall slew rate

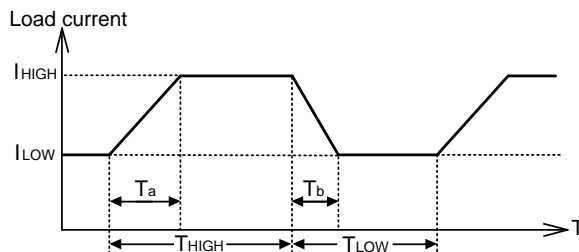

CC Mode Operating Instructions

Example Set the power supply to 5V/ 3A, CC mode, Level HI 3.000A, Level 1.500A



Steps

1. These can be selected in turn by pressing the “MODE” key (2), LCD will illuminate according to the operating mode is selected CC.



2. Press the “Preset” key (1) once will cause the button to illuminate.
3. Press the LEVEL key (4) LED once will illuminate, select LEVEL Hi, adjusted by the rotary knob and arrow key (5) can be read from the lower display during setting 3.0000A.



- Press the LEVEL key (4) LED once will off, Select LEVEL Lo, adjusted by the rotary knob and arrow key (5) can be read from the lower display during setting 1.5000A.



- Press the "Preset" key (1) LED once will cause the button to off, Leave setting mode.



- Press the "LOAD" key (3) LOAD button lit (Load on), Pressing the "LEVEL" key (4), LED once will illuminate, select is "LEVEL Hi".



- Press the "LEVEL" key (4), LED once will off, Select is "LEVEL Lo".



Constant Resistance mode application

Operating in Constant Resistance mode is useful for testing both voltage and current sources. The CR mode is particularly suited for the “soft start” of power supplies.

This is explained in more detail below.

Power supply power up sequence

Background	In constant current mode the demand at initial ‘Load ON’ of the preset current value is almost instantaneous. This might cause the Device under Test (DUT) problems meeting the relatively high current demand at initial switch on.
------------	--

Example	5V/50A output power supply may not be able to deliver 50A over its entire start-up range of 0-5 volts. In many cases the power supply’s short circuit or over current protection circuit cause the power supply to shut down. This is because the power supply is trying to deliver the 50A at a voltage level that is too low.
---------	---

The answer to this problem is not to use CC mode but to use CR mode instead. This is because in CR mode the current and voltage ramp up together providing a “soft start” when compared to standard CC mode.

However please note that with the PEL-500 series of Electronic Loads allow an adjustable current ramp can be set. This feature is found within the dynamic settings as rise slew rate. Even in static mode the PEL-500 series load will regulate its current demand at “Load ON” in line with the adjusted RISE slew rate. The fall slew rate also in the dynamic settings allows the current ramp down to be controlled at “Load OFF”.

Constant Resistance mode Application

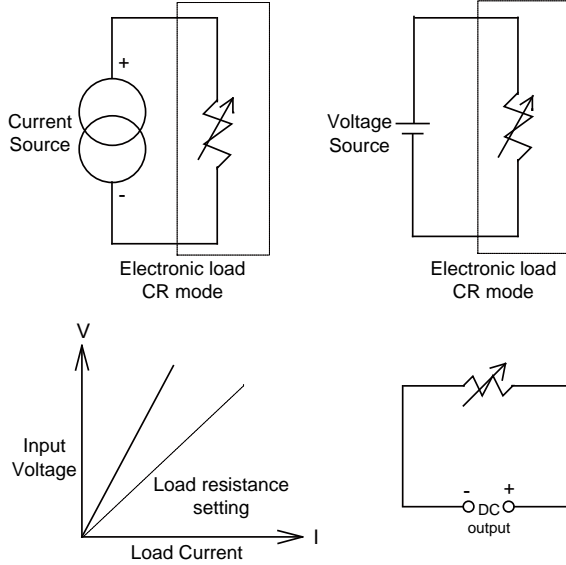

CR Mode Operating Instructions

Example

Set the power supply to 5 V/ 3 A, CR mode, Level HI 2.0 Ω, Level Lo 4.0Ω



Steps

1. These can be selected in turn by pressing the “MODE” key (2), LCD will illuminate according to the operating mode is selected CR.



2. Press the “Preset” key (1) once will cause the button to illuminate.
3. Press the LEVEL key (4) LED once will illuminate, select LEVEL Hi, adjusted by the rotary knob and arrow key (5) can be read from the lower display during setting 2.0000Ω.



4. Press the LEVEL key (4) LED once will illuminate, Select LEVEL Lo, adjusted by the rotary knob and arrow key (5) can be read from the lower display during setting 4.0000Ω.



5. Press the “Preset” key (1) LED once will cause the button to off, Leave setting mode.



6. Press the “LOAD” key (3) LOAD button lit (Load on), Pressing the “LEVEL” key (4), LED once will illuminate, select is “LEVEL Hi”.



7. Press the “LEVEL” key (4), LED once will off, Select is “LEVEL Lo”.



Constant Voltage mode application

In Constant Voltage (CV) operation the load will attempt to sink as much current as required in order to reach the set voltage value. CV operation is useful in checking the load regulation of dc current sources. The CV mode is also ideal for characterizing the current limit of dc power supplies.

These application areas are explained a little more below.

Current source testing

Background A common application for a dc current source is as a battery charger. Most battery chargers are designed to automatically adjust their charging current according to the battery voltage. In CV mode the electronic load will sink the current that is needed to reach the desired voltage. The CV mode is therefore ideal for checking the charge current at a particular voltage level.

If the battery charger is tested at a number of different voltage levels in CV mode a current curve can be recorded. Thus the battery charger's load regulation can be checked during development, production and batch testing.

Power supply current limit characterization

Background The current limit is a necessary function for power supplies. The fold back current limit curve is very common for fixed output switching power supplies. The constant current limit curve is more popular for adjustable laboratory power supplies.

It is very difficult or impossible to find the current limit curve by CC or CR mode. However it becomes simple by using CV mode. The user sets the CV voltage and records the output current.

Plotting the current measurements against the voltage Settings result in the output current limit curve of a power supply (figure below)

Constant Voltage mode application

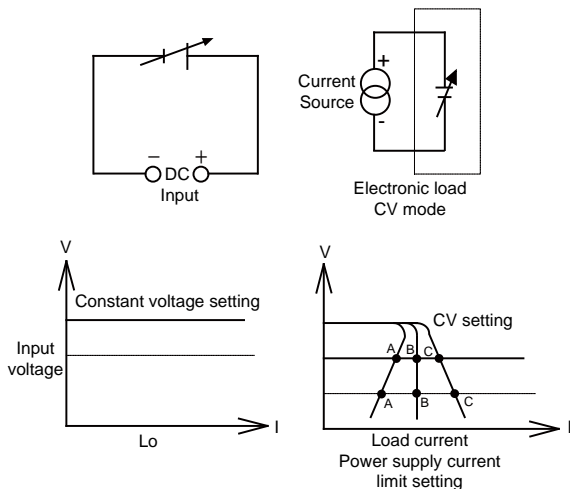

CV Mode Operating Instructions

Example Set the power supply to 5V/ 1A, CV mode, Level HI 4.000V, Level 3.000V



- Steps**
1. These can be selected in turn by pressing the "MODE" key (2), LCD will illuminate according to the operating mode is selected CV.



2. Press the "Preset" key (1) once will cause the button to illuminate.
3. Press the LEVEL key (4) LED once will illuminate, select LEVEL Lo, adjusted by the rotary knob and arrow key (5) can be read from the lower display during setting 3.0000V.



4. Press the LEVEL key (4) LED once will illuminate, Select LEVEL Hi, adjusted by the rotary knob and arrow key (5) can be read from the lower display during setting 4.0000V.



5. Press the "Preset" key (1) LED once will cause the button to off, Leave setting mode.



6. Press the "LOAD" key (3) LOAD button lit (Load on), Pressing the "LEVEL" key (4), LED once will illuminate, select is "LEVEL Hi".



7. Press the "LEVEL" key (4), LED once will off, Select is "LEVEL Lo".



Constant Power mode application

Battery Evaluation

Background

Primary or secondary batteries are the power source for a wide range of portable electronics products, such as notebook computers, video cameras and mobile phones. To ensure long usage times and customer satisfaction the battery pack should be able to provide a constant power for the longest time possible.

It can be measured that the output voltage of a battery will drop over time (Fig a). The rate of voltage decay depends on a number of factors including duty cycle, chemistry type, battery age and ambient temperature.

So to keep the device powered for the longest possible time the battery must be able to provide a stable power output regardless of output voltage (Fig c). In order to maintain a constant power the output current will need to increase over time to compensate for the reducing voltage (Fig b).

Operating the PEL-500 Series electronic load in CP mode is ideal for testing the characteristics of a battery. This is because as the battery voltage drops the load current will automatically increase in order to keep the CP setting. By logging sink values against time the test engineer can also measure the battery's energy capacity at various discharge rates.

The PEL-500 Series also features an adjustable Load OFF setting. This allows a voltage level to be set so that the electronic load automatically stops sinking power upon reaching this preset voltage. This can be used to ensure the battery is not

subjected to a damaging deep discharge.

Along with static operation the load can also be operated dynamically in CP mode. The dynamic functions allow the ramp, fall and plateau times to be adjusted between 2 levels of power. This capability means that “real world” loads can be more accurately simulated. For example the dynamic mode could be used to test the performance of a battery that is required to provide power pulses to transmit data from a radio frequency terminal.

Constant power mode application

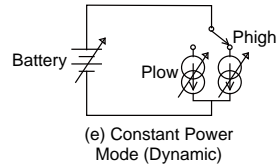
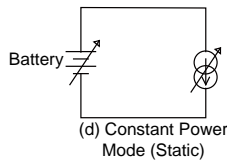
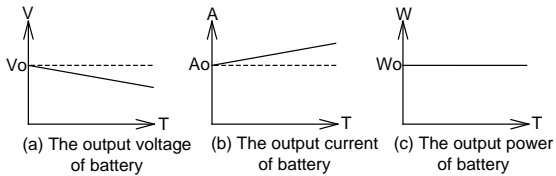

CP Mode Operating Instructions

Example

Set the power supply to 5V/ 3A, CP mode, Level HI 10.00W, Level 5.000W



Steps

1. These can be selected in turn by pressing the “MODE” key (2), LCD will illuminate

according to the operating mode is selected CP.



2. Press the “Preset” key (1) once will cause the button to illuminate.
3. Press the LEVEL key (4) LED once will illuminate, select LEVEL Hi, adjusted by the rotary knob and arrow key (5) can be read from the lower display during setting 10.000W.



4. Press the LEVEL key (4) LED once will illuminate, Select LEVEL Hi, adjusted by the rotary knob and arrow key (5) can be read from the lower display during setting 5.000W.



5. Press the “Preset” key (1) LED once will cause the button to off, Leave setting mode.



6. Press the “LOAD”key (3) LOAD button lit (Load on), Pressing the “LEVEL” key (4), LED once will illuminate, select is “LEVEL Hi”.



7. Press the “LEVEL” key (4), LED once will off, Select is “LEVEL Lo”.



Zero-Volt loading application

Background

As shown in Fig below, the Electronic load can be connected in series with a DC voltage source which output voltage greater than 1V (PEL-503-80-50, PEL-504-80-70, PEL-507-80-140), 6V (PEL-504-500-15, PEL-507-500-30) or so that the device under test that are connected to the Electronic load can be operated down to a Zero- Volt condition, the DC voltage source provides the minimum 1V (PEL-503-80-50, PEL-504-80-70, PEL-507-80-140), 6V (PEL-504-500-15, PEL-507-500-30) operating voltage required by the Electronic load. This application is suitable for low voltage Battery cell with high discharge current testing.

Zero-Volt loading connection

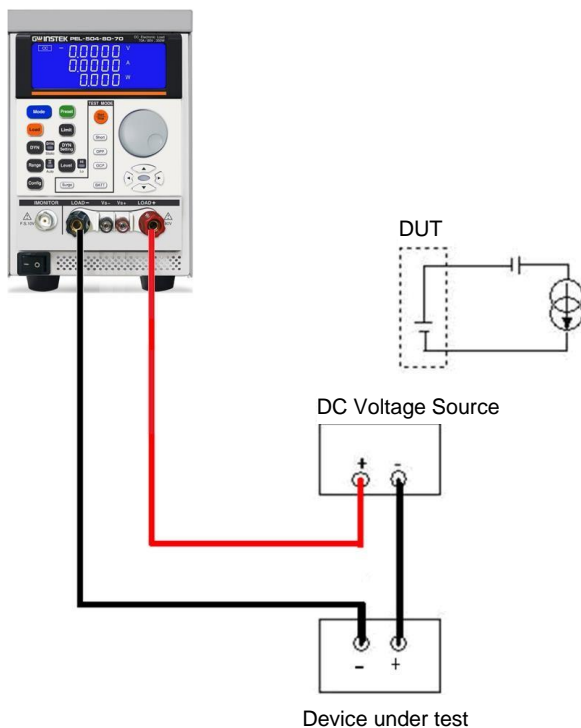

PEL-500 series electronic load OCP, OPP, SHORT operation flow chart

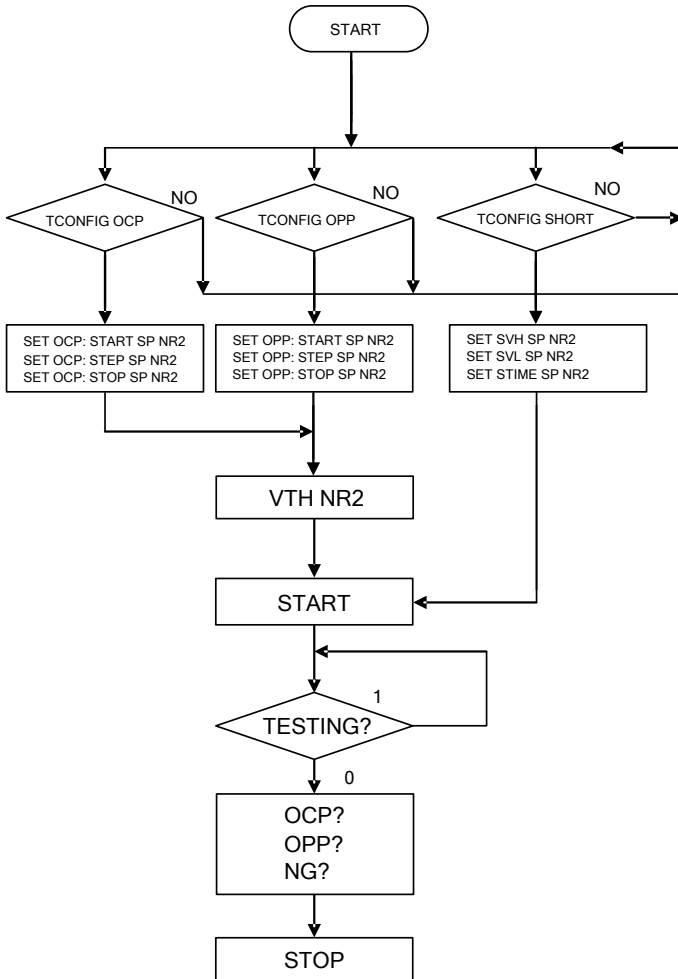

Power Supply OCP testing

OCP Manual control

1. Press Limit key function to setting I_Hi 6A.



2. Press Limit key function to setting I_Lo 0A.



3. Setting OCP test, press OCP key to the next step.



4. Setting start load current 0A, press OCP key to the next step.



5. Setting step load current 0.001A, press OCP key to the next step.



6. Setting stop load current 0.65A, press OCP key to the next step.



7. Setting OCP VTH 6.00V, press OCP key to the next step.
-



8. Press START/STOP test key.



9. The UUT's output voltage drop-out lower than the threshold voltage (V-th Setting), and the OCP trip point is between I_Hi and I_Lo limitation, then middle 5 digits LCD display will shows "PASS", otherwise shows "FAIL".



Remote control OCP example

REMOTE	(Set Remote)
TCONFIG OCP	(Set OCP test)
OCP:START 0.1	(Set start load current 0.1A)
OCP:STEP 0.01	(Set step load current 0.01A)
OCP:STOP 2	(Set stop load current 2A)
VTH 3.0	(Set OCP VTH 3.0V)
IL 0	(Set current low limit 0A)
IH 2	(Set current high limit 2A)
NGENABLE ON	(Set NG Enable ON)
START	(Start OCP testing)
TESTING?	(Ask Testing? 1: Testing, 0: Testing End)
NG?	(Ask PASS/FAIL?, 0: PASS, 1: FAIL)
OCP?	(Ask OCP current value)
STOP	(Stop OCP testing)

Power Supply OPP testing

OPP Manual control

1. Press Limit Key function to setting W_Hi 30.00W.



2. Press Limit Key function to setting W_Lo 0W.



3. Setting OPP test, press OPP key to the next step.



4. Setting start load current 0W, press OPP key to the next step.



5. Setting step load current 0.01W, press OPP key to the next step.



6. Setting stop load current 3.25W, press OPP key to the next step.



- Setting OPP VTH 6.00V, press OPP key to the next step.



- Press START/STOP test key.



- The UUT's output voltage drop-out lower than the threshold voltage (V-th setting), and the OPP trip point is between W_Hi and W_Lo limitation, then lower 5 digits LCD display will shows "PASS", otherwise shows "FAIL".



Remote control OPP example

REMOTE	(Set Remote)
TCONFIG OPP	(Set OPP test)
OPP:START 3	(Set start load watt 3W)
OPP:STEP 1	(Set step load watt 1W)
OPP:STOP 5	(Set stop load watt 5W)
VTH 3.0	(Set OPP VTH 3.0V)
WL 0	(Set watt low limit 0W)
WH 5	(Set watt high limit 5W)
NGENABLE ON	(Set NG Enable ON)
START	(Start OPP testing)
TESTING?	(Ask Testing? 1: Testing, 0: Testing End)
NG?	(Ask PASS/FAIL?, 0: PASS, 1:FAIL)
OPP?	(Ask OPP watt value)
STOP	(Stop OPP testing)

SHORT testing

- SHORT Manual control
1. Setting SHORT test, press Short key to the next step.



2. Press UP key, setting Short time to 10000ms, press Short key to the next Step.

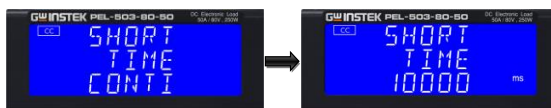

3. Press down key, setting V-Hi voltage to 1.000V, press Short key to the next Step.



4. Press down key, setting V-Lo voltage to 0V, press Short key to the next step.



5. Press START/STOP test key.



- Short test finish, the UUT's drop voltage is between V_{Hi} and V_{Lo} limitation, then right upper 5 digits LCD display will shows "PASS".



- The UUT's not drop voltage is between V_{Hi} and V_{Lo} limitation, LCD display will shows FAIL.



Remote control SHORT example

REMOTE	(Set Remote)
TCONFIG SHORT	(Set SHORT test)
STIME 1	(Set short time 1ms)
START	(Start SHORT testing)
TESTING?	(Ask Testing? 1: Testing, 0: Testing End)
STOP	(Stop SHORT testing)

APPENDIX

Replacing the Fuse.....	139
PEL-500 Default Settings	140
PEL-500 Dimensions.....	142
PEL-503-80-50, PEL-504-80-70, PEL-504-500-15	142
PEL-507-80-140, PEL-507-500-30.....	143
PEL-500 series Specifications	144
PEL-503-80-50, PEL-504-80-70	144
PEL-504-500-15	145
PEL-507-80-140, PEL-507-500-30.....	147

Replacing the Fuse

Background This product has the power fuse, and exchanges it according to the following procedure.



Never fail to turn off the power of this product, and disconnect the plug of the AC Power cable.



To avoid the fire or electronic shock, the Fuse that will be used in the product should have the safety standard in the area of the region you use. Any use of improper Fuse or shorting the Fuse holder would be extremely dangerous and would be strictly prohibited.

Before exchanging the Fuse, if there are abnormal odor or abnormal noise, please stop using immediately and ask for the repair.

Procedure

1. Check the rating of the mains input fuse.

Replace only the correct type and rating.

For 100/115Vac input, use T1A/ 250V
(5*20mm)

For 200/230Vac input, use T1A/ 250V
(5*20mm)

2. The AC line fuse is located below the AC line socket (see below figure). Use a small screwdriver to remove the fuse holder. Replace the failed fuse with the appropriate type and rating according to your mains voltage.

Fuse Receptacle

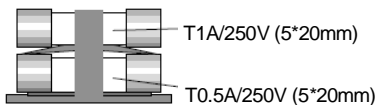
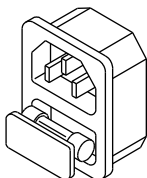

3. Reinstall the fuse holder and connect the power cord.

PEL-500 Default Settings

The following default settings are the factory configuration settings for the load.

Model	PEL-503-80-50	PEL-504-80-70	PEL-504-500-15
Item	Initial value		
CC L+Preset	0.0000A	0.0000A	0.00000A
CC H+Preset	0.0000A	0.0000A	0.00000A
CR H+Preset	96000Ω	68400Ω	2400000Ω
CR L+Preset	96000Ω	68400Ω	2400000Ω
CV H+Preset	81.000V	81.000V	500.00V
CV L+Preset	81.000V	81.000V	500.00V
CP L+Preset	0.000W	0.000W	0.000W
CP H+Preset	0.000W	0.000W	0.000W

Model	PEL-507-80-140	PEL-507-500-30
Item	Initial value	
CC L+Preset	0.0000A	0.0000A
CC H+Preset	0.0000A	0.0000A
CR H+Preset	34200Ω	1200000Ω
CR L+Preset	34200Ω	1200000Ω
CV H+Preset	81.000V	500.00V
CV L+Preset	81.000V	500.00V
CP L+Preset	0.000W	0.000W
CP H+Preset	0.000W	0.000W

Model	PEL-503-80-50	PEL-504-80-70	PEL-504-500-15
Item	Initial value for Limit		
V_Hi	81.000V	81.000V	500.00V
V_Lo	0.000V	0.000V	0.000V
I_Hi	50.400A	70.200A	15.0000A
I_Lo	0.000A	0.00A	0.0000A
W_Hi	250.20W	350.40W	350.40W
W_Lo	0.00W	0.00W	0.00W

Model	PEL-507-80-140	PEL-507-500-30
Item	Initial value for Limit	
V_Hi	81.000V	500.00V
V_Lo	0.000V	0.000V

I_Hi	140.400A	30.000A
I_Lo	0.000A	0.000A
W_Hi	700.20W	700.20W
W_Lo	0.00W	0.00W

Model	PEL-503-80-50	PEL-504-80-70	PEL-504-500-15
Item	Initial value for DYN		
T HI	0.050ms	0.050ms	0.050ms
T LO	0.050ms	0.050ms	0.050ms
RISE	200.0mA/μS	290.0mA/μS	62.5mA/μS
FALL	200.0mA/μS	290.0mA/μS	62.5mA/μS

Model	PEL-507-80-140	PEL-507-500-30
Item	Initial value for DYN	
T HI	0.050ms	0.050ms
T LO	0.050ms	0.050ms
RISE	600.0mA/μS	1250.0mA/μS
FALL	600.0mA/μS	1250.0mA/μS

Model	PEL-503-80-50	PEL-504-80-70	PEL-504-500-15
Item	Initial value for CONFIG		
SENSE	Auto	Auto	Auto
LD-ON	1.0V	1.0V	2.0V
LD-OFF	0.500V	0.500V	0.500V
POLAR	+LOAD	+LOAD	+LOAD

Model	PEL-507-80-140	PEL-507-500-30
Item	Initial value for CONFIG	
SENSE	Auto	Auto
LD-ON	1.0V	2.0V
LD-OFF	0.500V	0.500V
POLAR	+LOAD	+LOAD

Model	All model
Item	Initial value
SHORT	Disable
OPP	Disable
OCP	Disable

PEL-500 Dimensions

PEL-503-80-50, PEL-504-80-70, PEL-504-500-15

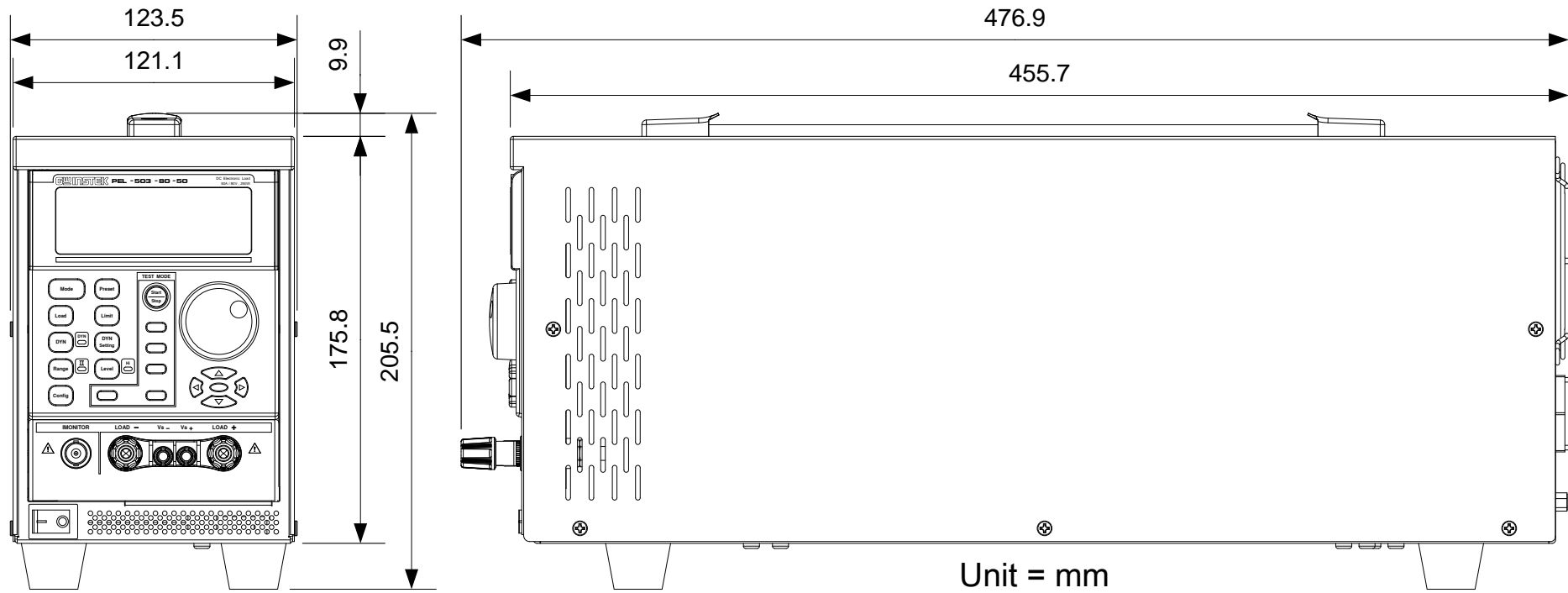

PEL-507-80-140, PEL-507-500-30

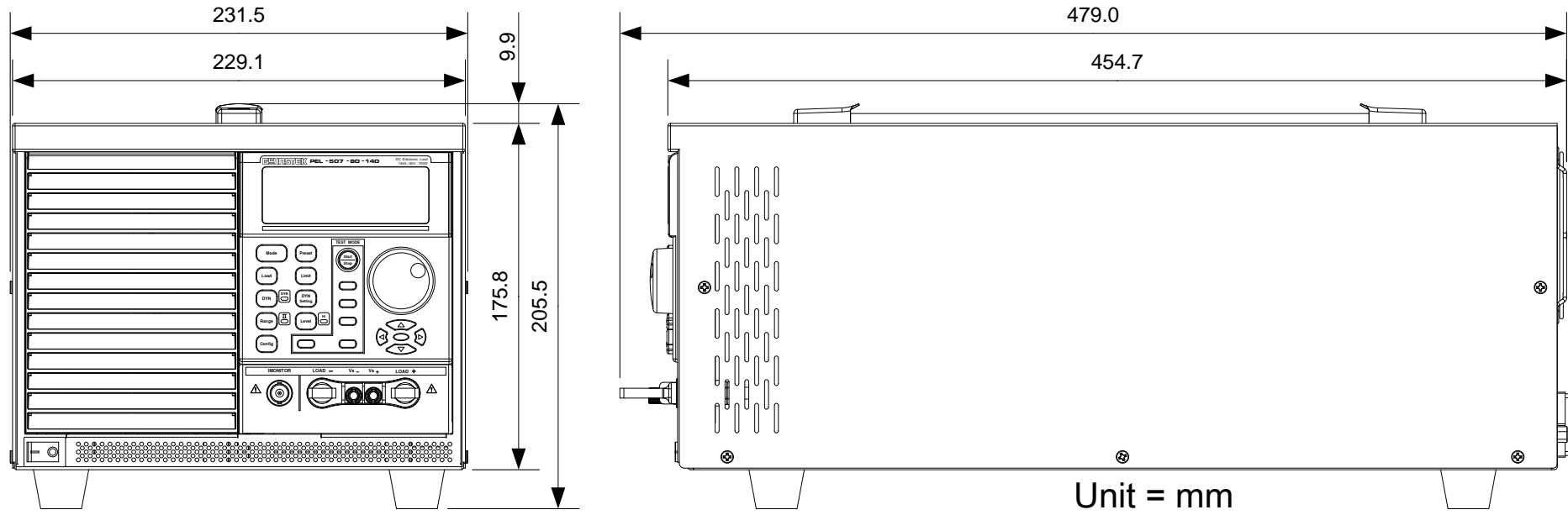

PEL-500 series Specifications

The specifications apply when the PEL-500 is powered on for at least 30 minutes. Note that the high frequency and high voltage options are listed as separate specifications.

PEL-503-80-50, PEL-504-80-70

Model	PEL-503-80-50	PEL-504-80-70	
INPUT RATINGS			
Power (Watt)	250W	350W	
Current(Ampere)	50A	70A	
Voltage(Volt)	80V		
Min. Operating Voltage	1.0V@50A	1.2V@70A	
PROTECTIONS			
Over Power Protection(OPP)	≅ 262.5W	≅ 367.5W	
Over Current Protection(OCP)	≅ 52.5A	≅ 73.5A	
Over Voltage Protection(OVP)	≅ 84V		
Over Temp. Protection(OTP)	Yes		
OPERATION MODE			
CC Mode	Range	0~5.04~50.4A	0~7.02~70.2A
	Resolution	0.084mA/0.84mA	0.117mA/1.17mA
	Accuracy	±0.1% of (setting + range)	
CR Mode	Range	0.016 ~ 1.6 ~ 96000Ω	0.0114 ~ 1.14 ~ 68400Ω
	Resolution	26.666μΩ/0.010416mSiemens	19μΩ/ 0.014619 mSiemens
	Accuracy	±0.2% of (setting + range)	
CV Mode	Range	0 ~ 8.1 ~ 81V	
	Resolution	0.135mV/ 1.35mV	
	Accuracy	±0.05% of(setting + range)	
CP Mode	Range	0 ~ 25.02 ~ 250.2 W (Imax.= r1: 5A, r2: 50A)	0 ~ 35.04 ~ 350.4 W (Imax.= r1: 7A, r2: 70A)
	Resolution	0.417 mW/ 4.17 mW	0.584mW/ 5.84 mW
	Accuracy	±0.5% of (setting + range)	
Dynamic Mode	THIGH/TLOW	10 μS to 9.999 Sec	
	Resolution	0.001/0.01/0.1/1mS	
	Slew-rate	0.032 ~ 2A/μS	0.0464 ~ 2.90A/μs
	Accuracy	3.2 ~ 200mA/μs	4.64 ~ 290 mA/μs
MEASUREMENT			
Voltage Read Back			
Range (5 Digital)	0 ~ 8.1 ~ 81V		
Resolution	0.135mV/ 1.35mV		
Accuracy	±0.025% of(reading + range)		

Current Read Back				
Range (5 Digital)	0 ~ 5.04 ~ 50.4 A		0 ~ 7.02 ~ 70.2 A	
Resolution	0.084 mA / 84 mA		0.117 mA / 1.17 mA	
Accuracy	±0.1% of(reading + range)			
Power Read Back				
Range (5 Digital)	25W	250W	35W	350W
Resolution	0.001W	0.01W	0.001W	0.1W
Accuracy	±0.1% of(reading + range)			
SURGE TEST				
Surge & Normal current	0~50A		0~70A	
Surge time	10~1000ms			
Surge step	1~5			
BATTERY DISCHARGE TEST				
UVP	0~81V			
Time	1~99999Sec			
Capacity	0.1~19999.9AH/0.1~19999.9WH			
OTHERS				
Load ON Voltage	0.1 ~ 25V			
Accuracy	1% of (Setting +Range)			
Load OFF Voltage	0 ~ 25V			
Accuracy	0.05% of (Setting +Range)			
Imonitor (non-Isolated)	5.04A/V		7.02A/V	
Current Monitor	FULL SCALE 10V			
Accuracy	0.5% of (Setting + Range)			
Typical Short Resistance	0.018Ω		0.0169Ω	
Max. short Current	50A		70A	
Interface	USB/RS232			
Power Consumption	40VA			
Dimension(H x W x D)	205 x 123 x 477 mm			
Weight	5.3Kg			

PEL-504-500-15

Model	PEL-504-500-15
INPUT RATINGS	
Power (Watt)	350W
Current(Ampere)	15A
Voltage(Volt)	500V
Min. Operating Voltage	6.0@15A
PROTECTIONS	
Over Power Protection (OPP)	≅ 367.5W
Over Current Protection (OCP)	≅ 15.75A
Over Voltage Protection (OVP)	≅ 525V
Over Temp. Protection (OTP)	Yes

Typical Short Resistance	0.0367Ω
Max. short Current	15A
Interface	USB/RS232
Power Consumption	40VA
Dimension(H x W x D)	205 x 123 x 477 mm
Weight	5.3Kg

PEL-507-80-140, PEL-507-500-30

Model	PEL-507-80-140	PEL-507-500-30		
INPUT RATINGS				
Power (Watt)	700W			
Current(Ampere)	140A	30A		
Voltage(Volt)	80V	500V		
Min. Operating Voltage	0.9V@140A	3V@30A		
PROTECTIONS				
Over Power Protection(OPP)	≅ 735W			
Over Current Protection(OCP)	≅ 147A	≅ 31.5A		
Over Voltage Protection(OVP)	≅ 84V	≅ 525V		
Over Temp. Protection(OTP)	Yes			
OPERATION MODE				
CC Mode	Range	0~14.04~140.4A	0~3~30A	
	Resolution	0.234mA/2.34mA	0.05mA/0.5mA	
	Accuracy	±0.1% of (setting + range)		
CR Mode	Range	0.0057 ~ 0.57 ~ 34200Ω	0.2 ~ 20 ~ 1200000Ω	
	Resolution	9.5μΩ/29.239mSiemens	333.334uΩ/ 0.833μSiemens	
	Accuracy	±0.2% of (setting + range)		
CV Mode	Range	0 ~ 8.1 ~ 81V	0 ~ 60 ~ 500V	
	Resolution	0.135mV/ 1.35mV	1mV/ 10mV	
	Accuracy	±0.05% of(setting + range)		
CP Mode	Range	0 ~ 70.02 ~ 700.2 W (Imax.= r1: 14A, r2: 140A)	0 ~ 70.02 ~ 700.2 W (Imax.= r1: 3A, r2: 30A)	
	Resolution	1.167 mW/ 11.67 mW	1.17mW/ 117 mW	
	Accuracy	±0.5% of (setting + range)		
Dynamic Mode	THIGH/TLOW	10 μS to 9.999 Sec		
	Resolution	0.001/0.01/0.1/1mS		
	Slew-rate	0.0096 ~ 0.6A/μS	2 ~ 125mA/μs	
		0.096 ~ 6A/μs	20 ~ 1250 mA/μs	
Accuracy	±5% ±10μS			
MEASUREMENT				
Voltage Read Back				
Range (5 Digital)	0 ~ 8.1 ~ 81V	0 ~ 60 ~ 500V		
Resolution	0.135mV/ 1.35mV	1mV/ 10mV		
Accuracy	±0.025% of(reading + range)			

Current Read Back			
Range (5 Digital)	0 ~ 14.04 ~ 140.4 A	0 ~ 3 ~ 30 A	
Resolution	0.234mA / 2.34mA	0.05mA / 0.5mA	
Accuracy	±0.1% of (reading + range)		
Power Read Back			
Range (5 Digital)	70W	700W	70W 700W
Resolution	0.001W	0.01W	0.001W 0.01W
Accuracy	±0.1% of (reading + range)		
SURGE TEST			
Surge & Normal current	0~140A	0~30A	
Surge time	10~1000ms		
Surge step	1~5		
BATTERY DISCHARGE TEST			
UVP	0~81V	0~500V	
Time	1~99999Sec		
Capacity	0.1~19999.9AH/0.1~19999.9WH		
OTHERS			
Load ON Voltage	0.1 ~ 25V	0.4 ~ 100V	
Accuracy	1% of (Setting +Range)		
Load OFF Voltage	0 ~ 25V	0 ~ 100V	
Accuracy	0.05% of (Setting +Range)		
Imonitor (non-Isolated)	14.04A/V	3A/V	
Current Monitor	FULL SCALE 10V		
Accuracy	0.5% of (Setting + Range)		
Typical Short Resistance	0.053Ω	0.087Ω	
Max. short Current	140A	30A	
Interface	USB/RS232		
Power Consumption	60VA		
Dimension (H x W x D)	205 x 231 x 480 mm		
Weight	10.3Kg		

Certificate Of Compliance

We

GOOD WILL INSTRUMENT CO., LTD.

declare that the CE marking mentioned product

satisfies all the technical relations application to the product within the scope of council:

Directive: EMC; LVD; WEEE; RoHS

The product is in conformity with the following standards or other normative documents:

© EMC	
EN 61326-1	Electrical equipment for measurement, control and laboratory use -- EMC requirements
Conducted & Radiated Emission EN 55011 / EN 55032	Electrical Fast Transients EN 61000-4-4
Current Harmonics EN 61000-3-2 / EN 61000-3-12	Surge Immunity EN 61000-4-5
Voltage Fluctuations EN 61000-3-3 / EN 61000-3-11	Conducted Susceptibility EN 61000-4-6
Electrostatic Discharge EN 61000-4-2	Power Frequency Magnetic Field EN 61000-4-8
Radiated Immunity EN 61000-4-3	Voltage Dip/ Interruption EN 61000-4-11 / EN 61000-4-34
© Safety	
EN 61010-1 :	Safety requirements for electrical equipment for measurement, control, and laboratory use - Part 1: General requirements

GOODWILL INSTRUMENT CO., LTD.

No. 7-1, Jhongsing Road, Tucheng District, New Taipei City 236, Taiwan

Tel: [+886-2-2268-0389](tel:+886-2-2268-0389)

Fax: [+886-2-2268-0639](tel:+886-2-2268-0639)

Web: <http://www.gwinstek.com>

Email: marketing@goodwill.com.tw

GOODWILL INSTRUMENT (SUZHOU) CO., LTD.

No. 521, Zhujiang Road, Snd, Suzhou Jiangsu 215011, China

Tel: [+86-512-6661-7177](tel:+86-512-6661-7177)

Fax: [+86-512-6661-7277](tel:+86-512-6661-7277)

Web: <http://www.instek.com.cn>

Email: marketing@instek.com.cn

GOODWILL INSTRUMENT EURO B.V.

De Run 5427A, 5504DG Veldhoven, The Netherlands

Tel: [+31-\(0\)40-2557790](tel:+31-(0)40-2557790)

Fax: [+31-\(0\)40-2541194](tel:+31-(0)40-2541194)

Email: sales@gw-instek.eu