

# Multi-Range DC Power Supply

PSW-Multi Series

---

**USER MANUAL**



ISO-9001 CERTIFIED MANUFACTURER

**GW INSTEK**

This manual contains proprietary information, which is protected by copyright. All rights are reserved. No part of this manual may be photocopied, reproduced or translated to another language without prior written consent of Good Will company.

The information in this manual was correct at the time of printing. However, Good Will continues to improve products and reserves the rights to change specification, equipment, and maintenance procedures at any time without notice.

# Table of Contents

<b>SAFETY INSTRUCTIONS .....</b>	<b>5</b>
<b>GETTING STARTED .....</b>	<b>8</b>
PSW-Multi Series Overview .....	10
Appearance .....	21
Theory of Operation .....	28
<b>OPERATION .....</b>	<b>42</b>
Set Up .....	43
Basic Operation .....	61
Test Scripts .....	72
<b>CONFIGURATION .....</b>	<b>83</b>
Configuration .....	84
<b>ANALOG CONTROL .....</b>	<b>100</b>
Analog Remote Control Overview .....	101
Remote Monitoring .....	117
<b>COMMUNICATION INTERFACE .....</b>	<b>122</b>
Interface Configuration .....	123
<b>MAINTENANCE .....</b>	<b>138</b>
<b>FAQ .....</b>	<b>140</b>
<b>APPENDIX .....</b>	<b>142</b>
PSW-Multi Web Control Description .....	143
PSW-Multi Default Settings .....	153
Error Messages & Messages .....	155
LED Display Format .....	155

Specifications .....	156
PSW-Multi Dimensions .....	162
Certificate Of Compliance .....	166
<b>I</b> NDEX.....	<b>167</b>

# S SAFETY INSTRUCTIONS

This chapter contains important safety instructions that you must follow during operation and storage. Read the following before any operation to insure your safety and to keep the instrument in the best possible condition.

## Safety Symbols

These safety symbols may appear in this manual or on the instrument.

---



WARNING

Warning: Identifies conditions or practices that could result in injury or loss of life.



CAUTION

Caution: Identifies conditions or practices that could result in damage to the PSW-Multi or to other properties.



DANGER High Voltage



Attention Refer to the Manual



Protective Conductor Terminal



Earth (ground) Terminal



Do not dispose electronic equipment as unsorted municipal waste. Please use a separate collection facility or contact the supplier from which this instrument was purchased.

## Safety Guidelines

---

### General Guideline



#### CAUTION

- Do not place any heavy object on the PSW-Multi.
- Avoid severe impact or rough handling that leads to damaging the PSW-Multi.
- Do not discharge static electricity to the PSW-Multi.
- Use only mating connectors, not bare wires, for the terminals.
- Do not block the cooling fan opening.
- Do not disassemble the PSW-Multi unless you are qualified.

### Power Supply



#### WARNING

- AC Input voltage rating: 100Vac-240Vac +/-10%
- Frequency: 47Hz~63Hz
- To avoid electrical shock connect the protective grounding conductor of the AC power cord to an earth ground.

### Cleaning the PSW-Multi

- Disconnect the power cord before cleaning.
- Use a soft cloth dampened in a solution of mild detergent and water. Do not spray any liquid.
- Do not use chemicals containing harsh material such as benzene, toluene, xylene, and acetone.

### Operation Environment

- Location: Indoor, no direct sunlight, dust free, almost non-conductive pollution (Note below)
- Relative Humidity: 20%~ 85%
- Altitude: < 2000m

- Temperature: 0°C to 50°C
- Mains supply voltage fluctuations: +/-10 %
- Overvoltage category: OVC II
- If the equipment is used in a manner not specified by the manufacturer, the protection provided by the equipment may be impaired.
- LAN, RS232/RS485, USB, and GPIB ports are only to be connected to the circuits which are separated from mains supply by double / reinforce insulation.

(Pollution Degree) EN 61010-1 and EN 61010-2-030 specify the pollution degrees and their requirements as follows. The PSW falls under degree 2.

Pollution refers to “addition of foreign matter, solid, liquid, or gaseous (ionized gases), that may produce a reduction of dielectric strength or surface resistivity”.

- Pollution degree 1: No pollution or only dry, non-conductive pollution occurs. The pollution has no influence.
- Pollution degree 2: Normally only non-conductive pollution occurs. Occasionally, however, a temporary conductivity caused by condensation must be expected.
- Pollution degree 3: Conductive pollution occurs, or dry, non-conductive pollution occurs which becomes conductive due to condensation which is expected. In such conditions, equipment is normally protected against exposure to direct sunlight, precipitation, and full wind pressure, but neither temperature nor humidity is controlled.

---

#### Storage environment

- Location: Indoor
- Temperature: -25°C to 70°C
- Relative Humidity: <90%, no condensation

---

#### Disposal



Do not dispose this instrument as unsorted municipal waste. Please use a separate collection facility or contact the supplier from which this instrument was purchased. Please make sure discarded electrical waste is properly recycled to reduce environmental impact.

All hazardous wiring must be immediately destroyed and replaced in accordance to the above standard.

# GETTING STARTED

This chapter describes the power supply in a nutshell, including its main features and front / rear panel introduction. After going through the overview, please read the theory of operation to become familiar with the operating modes, protection modes and other safety considerations.



<b>PSW-Multi Series Overview</b> .....	<b>10</b>
Series lineup .....	10
Dual Channel model.....	11
Triple Channel model.....	12
Main Features .....	17
Accessories .....	18
PSW 30/40/80/160 Accessories .....	18
PSW 250/800 Accessories.....	19
<b>Appearance</b> .....	<b>21</b>
PSW-Multi Front Panel.....	21
PSW-720 .....	21
PSW-1080 .....	21
PSW-Multi Rear Panel (low voltage models).....	24
PSW-720 .....	24
PSW-1080 .....	24
PSW-Multi Rear Panel (high voltage models) .....	25
PSW-720 .....	25
PSW-1080 .....	25
<b>Theory of Operation</b> .....	<b>28</b>
Operating Area Description .....	28



CC and CV Mode.....	30
Slew Rate .....	32
Bleeder Control .....	32
Sink Current Table .....	34
Internal Resistance .....	36
Alarms.....	37
Considerations .....	37
Grounding.....	40

## PSW-Multi Series Overview

### Series lineup

The PSW-Multi series consists of 37 models divided into 2 output terminal type (Busbar and connector type) with 2 different size model types (PSW-720 and PSW-1080). The PSW-720 is 2 channel output type and PSW-1080 is 3 channel output type. The models of busbar output type are PSW 30, PSW 40, PSW 80 and PSW160 and connector type are PSW 250 and PSW 800.

---



Note

Throughout the user manual, PSW 30, PSW 40, PSW 80, PSW 160, PSW 250, PSW 800 will refer to any of the PSW models with a maximum voltage rating of 30V, 40V, 80V, 160V, 250V or 800V, respectively.

Each channel of PSW-Multi series doesn't support serial or parallel operation.

Dual Channel model

Model name	Output	Voltage Rating	Current Rating	Output Type
PSW-720L11	CH1	0-30V	0-36A	BusBar
	CH2	0-30V	0-36A	
PSW-720L12	CH1	0-30V	0-36A	
	CH2	0-40V	0-27A	
PSW-720L14	CH1	0-30V	0-36A	
	CH2	0-80V	0-13.5A	
PSW-720L15	CH1	0-30V	0-36A	
	CH2	0-160V	0-7.2A	
PSW-720L22	CH1	0-40V	0-27A	
	CH2	0-40V	0-27A	
PSW-720L24	CH1	0-40V	0-27A	
	CH2	0-80V	0-13.5A	
PSW-720L25	CH1	0-40V	0-27A	
	CH2	0-160V	0-7.2A	
PSW-720L44	CH1	0-80V	0-13.5A	
	CH2	0-80V	0-13.5A	
PSW-720L45	CH1	0-80V	0-13.5A	
	CH2	0-160V	0-7.2A	
PSW-720L55	CH1	0-160V	0-7.2A	
	CH2	0-160V	0-7.2A	
PSW-720H66	CH1	0-250V	0-4.5A	Connector
	CH2	0-250V	0-4.5A	
PSW-720H68	CH1	0-250V	0-4.5A	
	CH2	0-800V	0-1.44A	
PSW-720H88	CH1	0-800V	0-1.44A	
	CH2	0-800V	0-1.44A	

Triple Channel model

Model name	Output	Voltage Rating	Current Rating	Output Type
PSW-1080L111	CH1	0-30V	0-36A	
	CH2	0-30V	0-36A	
	CH3	0-30V	0-36A	
PSW-1080L112	CH1	0-30V	0-36A	
	CH2	0-30V	0-36A	
	CH3	0-40V	0-27A	
PSW-1080L114	CH1	0-30V	0-36A	
	CH2	0-30V	0-36A	
	CH3	0-80V	0-13.5A	
PSW-1080L115	CH1	0-30V	0-36A	
	CH2	0-30V	0-36A	
	CH3	0-160V	0-7.2A	
PSW-1080L122	CH1	0-30V	0-36A	
	CH2	0-40V	0-27A	
	CH3	0-40V	0-27A	
PSW-1080L124	CH1	0-30V	0-36A	BusBar
	CH2	0-40V	0-27A	
	CH3	0-80V	0-13.5A	
PSW-1080L125	CH1	0-30V	0-36A	
	CH2	0-40V	0-27A	
	CH3	0-160V	0-7.2A	
PSW-1080L144	CH1	0-30V	0-36A	
	CH2	0-80V	0-13.5A	
	CH3	0-80V	0-13.5A	
PSW-1080L145	CH1	0-30V	0-36A	
	CH2	0-80V	0-13.5A	
	CH3	0-160V	0-7.2A	
PSW-1080L155	CH1	0-30V	0-36A	
	CH2	0-160V	0-7.2A	
	CH3	0-160V	0-7.2A	

PSW-1080L222	CH1	0-40V	0-27A	
	CH2	0-40V	0-27A	
	CH3	0-40V	0-27A	
PSW-1080L224	CH1	0-40V	0-27A	
	CH2	0-40V	0-27A	
	CH3	0-80V	0-13.5A	
PSW-1080L225	CH1	0-40V	0-27A	
	CH2	0-40V	0-27A	
	CH3	0-160V	0-7.2A	
PSW-1080L244	CH1	0-40V	0-27A	
	CH2	0-80V	0-13.5A	
	CH3	0-80V	0-13.5A	
PSW-1080L245	CH1	0-40V	0-27A	BusBar
	CH2	0-80V	0-13.5A	
	CH3	0-160V	0-7.2A	
PSW-1080L255	CH1	0-40V	0-27A	
	CH2	0-160V	0-7.2A	
	CH3	0-160V	0-7.2A	
PSW-1080L444	CH1	0-80V	0-13.5A	
	CH2	0-80V	0-13.5A	
	CH3	0-80V	0-13.5A	
PSW-1080L445	CH1	0-80V	0-13.5A	
	CH2	0-80V	0-13.5A	
	CH3	0-160V	0-7.2A	
PSW-1080L455	CH1	0-80V	0-13.5A	
	CH2	0-160V	0-7.2A	
	CH3	0-160V	0-7.2A	
PSW-1080L555	CH1	0-160V	0-7.2A	
	CH2	0-160V	0-7.2A	
	CH3	0-160V	0-7.2A	

	CH1	0-250V	0-4.5A	
PSW-1080H666	CH2	0-250V	0-4.5A	
	CH3	0-250V	0-4.5A	
	CH1	0-250V	0-4.5A	
PSW-1080H668	CH2	0-250V	0-4.5A	
	CH3	0-800V	0-1.44A	
	CH1	0-250V	0-4.5A	Connector
PSW-1080H688	CH2	0-800V	0-1.44A	
	CH3	0-800V	0-1.44A	
	CH1	0-800V	0-1.44A	
PSW-1080H888	CH2	0-800V	0-1.44A	
	CH3	0-800V	0-1.44A	

Apart from the differences in output type, each unit differs at output channels and voltage. The PSW-720 is two channel output and PSW-1080 is three channel output.

PSW-Multi 2-channel modules with low voltage models.

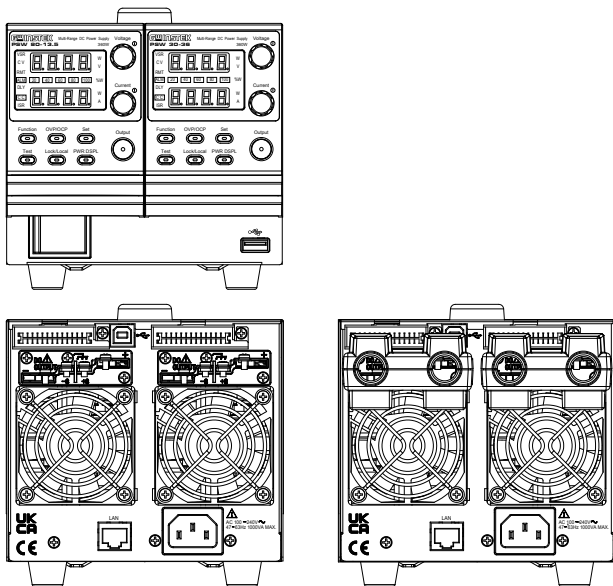

PSW-Multi 2-channel modules with high voltage models.

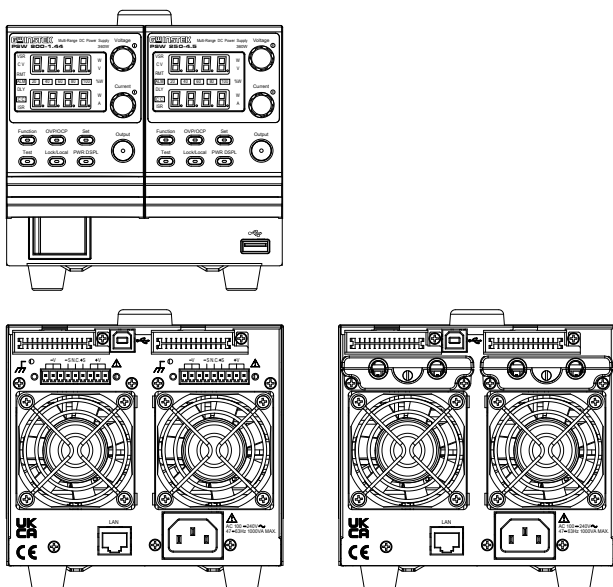

PSW-Multi 3-channel modules with low voltage models.

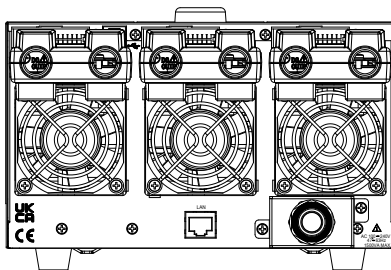
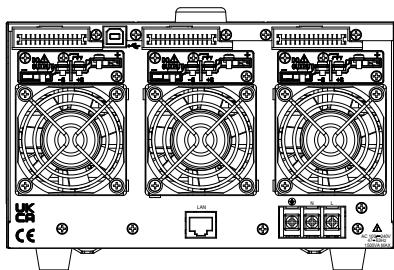
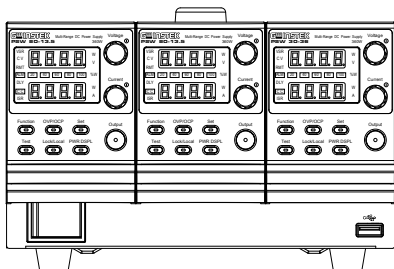

PSW-Multi 3-channel modules with high voltage models.

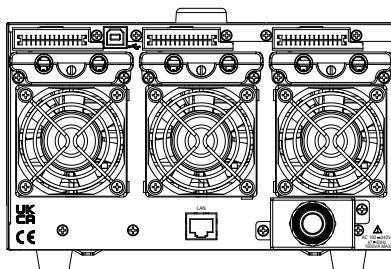
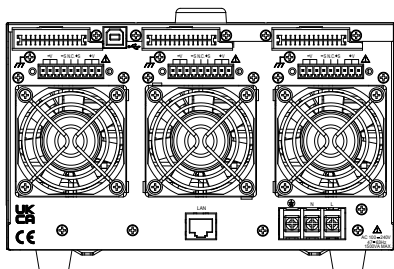
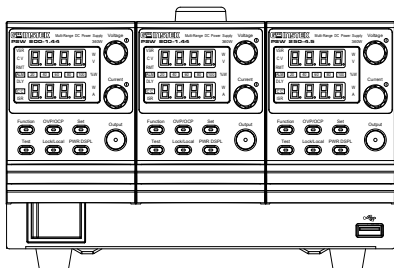



## Main Features

---

- |             |  |
|-------------|--|
| Performance | <ul style="list-style-type: none"><li>• High performance/power</li><li>• Power efficient switching type power supply</li><li>• Low impact on load devices</li><li>• Fast transient recovery time of 1ms</li><li>• Fast output response time</li></ul> <hr/>  |
| Features    | <ul style="list-style-type: none"><li>• OVP, OCP and OHP (OTP) protection</li><li>• Adjustable voltage and current slew rates</li><li>• User adjustable bleeder control to quickly dissipate the power after shutdown to safe levels.</li><li>• Extensive remote monitoring and control options</li><li>• Power on configuration settings.</li><li>• Supports test scripts</li><li>• Web server monitoring and control</li></ul> <hr/> |
| Interface   | <ul style="list-style-type: none"><li>• Ethernet port</li><li>• Analog connector for analog voltage and current monitoring</li><li>• USB host and device port</li></ul>  |

## Accessories

Please check the contents before using the PSW-Multi.

### PSW 30/40/80/160 Accessories

Standard Accessories	Part number	Description
		Power cord (PSW-720)
		Power cord (PSW-1080)
		Output terminal Cover (per channel)
	GTL-123	Test leads: 1x red, 1x black (per channel)
	GTL-240	USB Cable
	PSW-004	Basic Accessory Kit (per channel): M4 terminal screws and washers x2, M8 terminal bolts, nuts and washers x2, Air filter x1, Analog control protection dummy x1, Analog control lock level x1

Optional Accessories	Part number	Description
	GET-001	Extended terminal with max. 30A
	GET-005	Extended European terminal with max. 20A
	PSW-001	Accessory Kit: Pin contact x10, Socket x1, Protection cover x1
	PSW-002	Simple IDC Tool
	PSW-003	Contact Removal Tool
	GRA-410-J	Rack mount adapter (JIS)

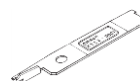
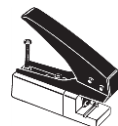

GRA-410-E	Rack mount adapter (EIA)
GUG-001	GPIB to USB adapter
GTL-240	USB Cable
GUR-001A	RS-232 to USB adapter with M3 rivet nut
GUR-001B	RS-232 to USB adapter with #4-40 UNC rivet nut

Download	Name	Description
	PSW-Multi_cdc.inf	USB driver

### PSW 250/800 Accessories

Standard Accessories	Part number	Description
		Power cord (PSW-720)
		Power cord (PSW-1080)
		High voltage output terminal (per channel)
	GTL-240	USB Cable
		High voltage output terminal (per channel)
	PSW-008	Basic Accessory Kit (per channel): (Air filter x1, Analog control protection dummy x1, Analog control lock level x1)

Optional Accessories	Part number	Description
	GET-002	Extended terminal with max. 10A
	PSW-001	Accessory Kit: Pin contact x10, Socket x1, Protection cover x1
	PSW-002	Simple IDC Tool

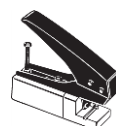

PSW-003 Contact Removal Tool

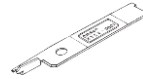

GRA-410-J Rack mount adapter (JIS)

GRA-410-E Rack mount adapter (EIA)

GTL-130 Test leads: 2x red, 2x black

GUG-001 GPIB to USB adapter

GTL-240 USB Cable

GUR-001A RS-232 to USB adapter with M3 rivet nut

GUR-001B RS-232 to USB adapter with #4-40 UNC rivet nut

Download

Name

Description

PSW-Multi\_cdc.inf USB driver

# Appearance



## PSW-Multi Front Panel

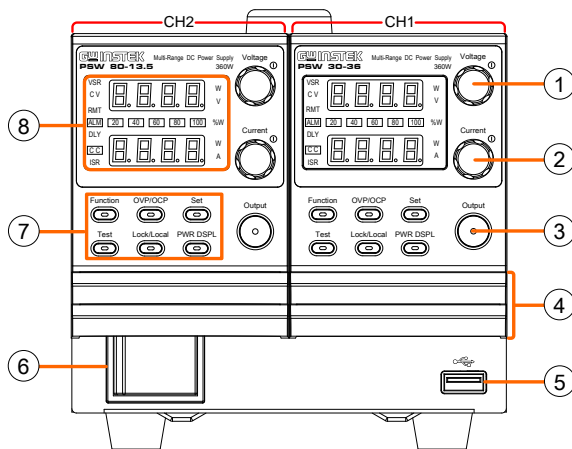

### PSW-720

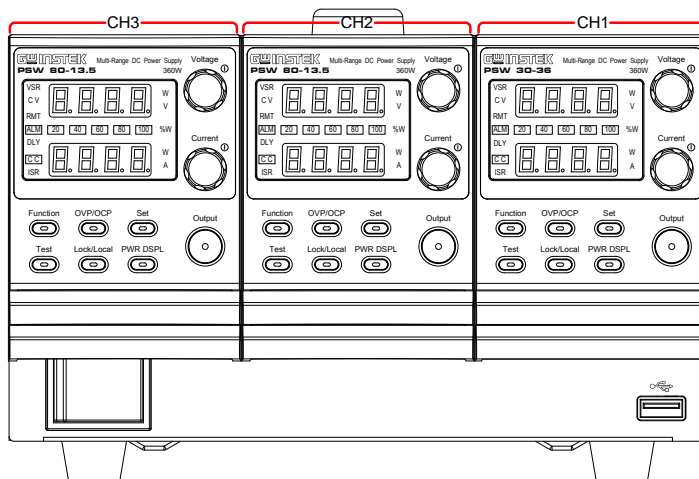

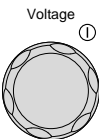
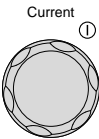
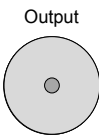

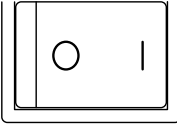
### PSW-1080



- 1 Voltage Knob  Sets the voltage.
- 2 Current Knob  Sets the current.
- 3 Output Button  Press to turn on the output. The Output key will light up when the output is active.
- 4 Cover panel
- 5 USB  USB A port for data transfer, loading test scripts etc.
- 6 Power Switch  Used to turn the power on/off.
- 7 Function Keys The Function keys along with the Output key will light up when a key is active.

  - Function  The Function key is used to configure the power supply.
  - OVP/OCV  Set the over current or over voltage protection levels.
  - Set  Sets the current and voltage limits.

		Test	Used to run customized scripts for testing.
		Lock/Local	Locks or unlocks the panel keys to prevent accidentally changing panel settings.
		PWR DSPL	Toggles the display from viewing V/A → V/W or A/W*. *Press the Voltage knob for V/W, press the Current knob for A/W.
8 Display Indicators		VSR	Voltage Slew Rate
		C V	Constant Voltage Mode
		RMT	Remote Control Mode
		<b>ALM</b>	Alarm on
		DLY	Delay Output
		<b>CC</b>	Constant Current Mode
		ISR	Current Slew Rate
		<b>20</b> <b>40</b> <b>60</b>	Power bar
		<b>80</b> <b>100</b> % W	Indicates the current power output as a percentage.

PSW-Multi Rear Panel (low voltage models)

PSW-720

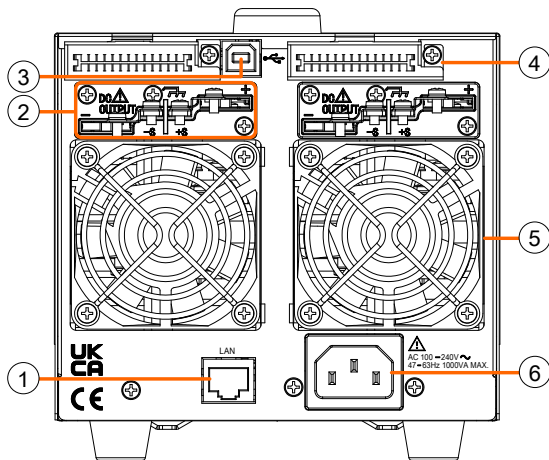

PSW-1080

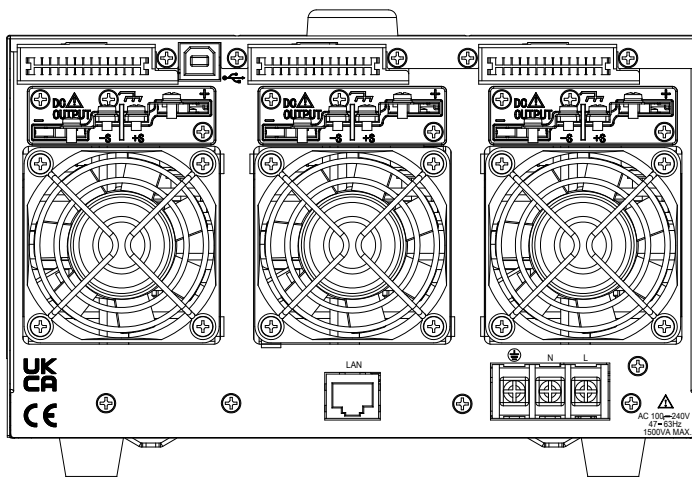



PSW-Multi Rear Panel (high voltage models)

PSW-720

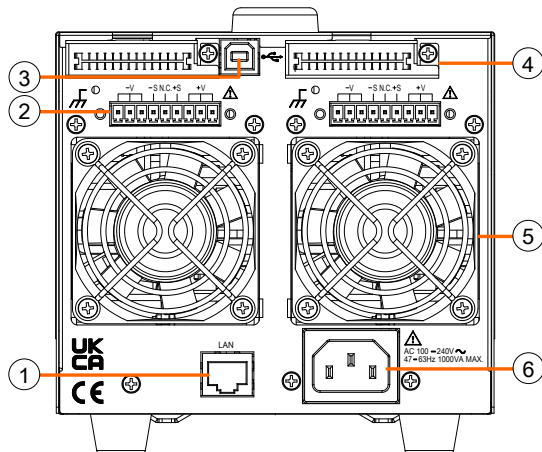

PSW-1080

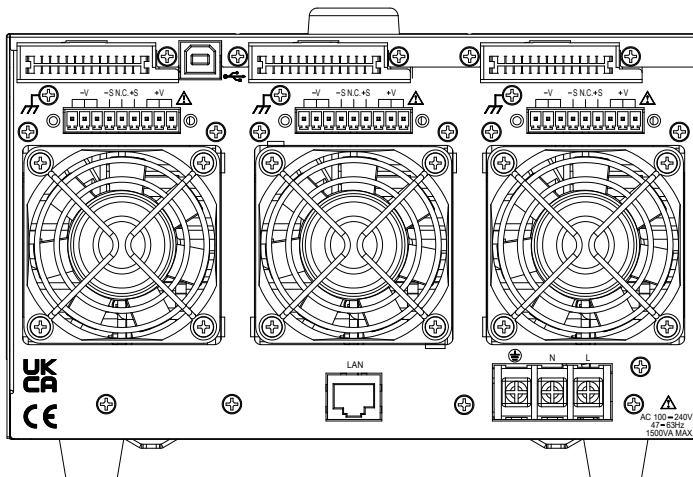

1 Ethernet Port

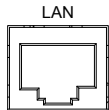

The ethernet port is used for remote control and digital monitoring from a PC.

2 Output Terminals  
(30, 40, 80, 160  
volt models)

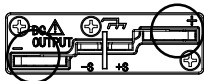

Positive (+) and negative (-) output terminals.

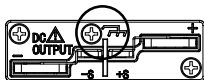

Chassis ground

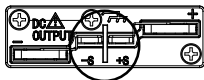

Sense (-S) and Sense (+S) terminals.

Output Terminals  
(250, 800 volt  
models)

The 250 and 800 volt models use a 9 pin connector and a plug for the output and sense terminal connections. The plug is a MC420-38109Z plug by DECA SwitchLab Inc. This plug is also available separately (GW part number PSW-012).

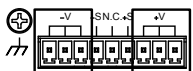

Positive (V+) and negative (V-) output terminals (3 of each).

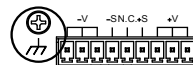

Chassis ground

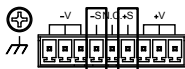

Sense (-S) and Sense (+S) terminals.

3 USB B port

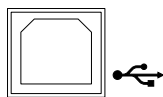

The USB B port is used for remote control.

4 Analog Control  
Connector



Standard 26 pin MIL connector (OMRON XG4 IDC plug).

The analog control connector is used to monitor current and voltage output, machine status (OVP, OCP, OHP (OTP) etc.), and for analog control of the

current and voltage output.

Use an OMRON XG5 IDC socket as the mating socket.

5 Fans

Temperature controlled fans

6 Line Voltage Input  
(PSW-720)

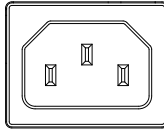

- Voltage Input: 100~240 VAC
- Line frequency: 50Hz/60 Hz (Automatically switchable)

Line Voltage Input  
(PSW-1080)

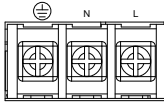

- Voltage Input: 100~240 VAC
- Line frequency: 50Hz/60 Hz (Automatically switchable)

## Theory of Operation

The theory of operation chapter describes the basic principles of operation, protection modes and important considerations that must be taken into account before use.

### Operating Area Description

---

#### Background

The PSW power supplies are regulated DC power supplies with a high voltage and current output. These operate in CC or CV mode within a wide operating range limited only by the output power.

The operating area of each power supply is determined by the rated output power as well as the voltage and current rating. For example the operating area and rated power output for the PSW 30-36 is shown below.

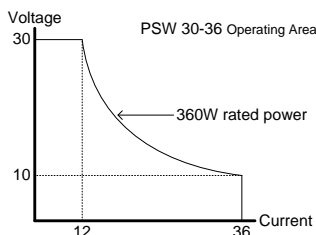

When the power supply is configured so that the total output (current x voltage output) is less than the rated power output, the power supply functions as a typical constant current, constant voltage power supply.

If however, the power supply is configured such that the total output (current x voltage output) exceeds the rated power output, the effective output is actually limited to the power limit of the

unit. In this case the output current and voltage then depend purely on the load value.

Below is a comparison of the operating areas of each power supply.

**PSW-Multi 250V, 800V Operating Area**

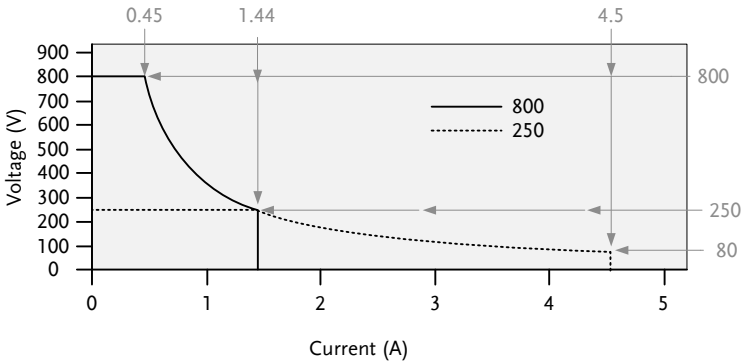

**PSW-Multi 80V, 160V Operating Area**

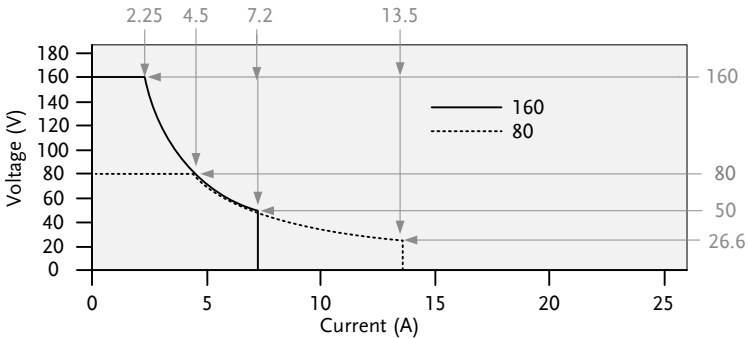

**PSW-Multi 30, 40V Operating Area**

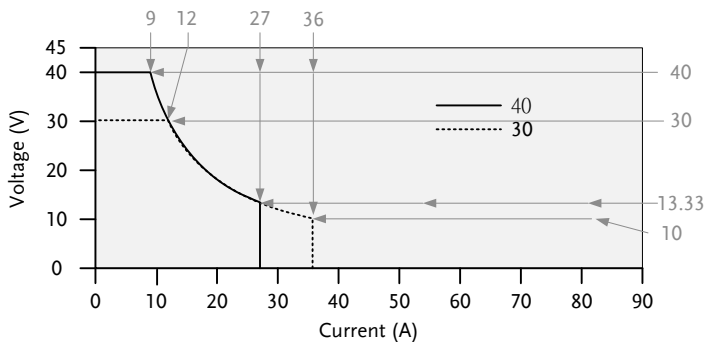

**CC and CV Mode**

**CC and CV mode Description**

When the power supply is operating in constant current mode (CC) a constant current will be supplied to the load. When in constant current mode the voltage output can vary, whilst the current remains constant. When the load resistance increases to the point where the current limit ( $I_{SET}$ ) can no longer be sustained the power supply switches to CV mode. The point where the power supply switches modes is the crossover point.

When the power supply is operating in CV mode, a constant voltage will be supplied to the load, whilst the current will vary as the load varies. At the point that the load resistance is too low to maintain a constant voltage, the power supply will switch to CC mode and maintain the set current limit.

The conditions that determine whether the power supply operates in CC or CV mode depends on the set current ( $I_{SET}$ ), the set voltage ( $V_{SET}$ ), the load

resistance ( $R_L$ ) and the critical resistance ( $R_C$ ). The critical resistance is determined by  $V_{SET}/I_{SET}$ . The power supply will operate in CV mode when the load resistance is greater than the critical resistance. This means that the voltage output will be equal to the  $V_{SET}$  voltage but the current will be less than  $I_{SET}$ . If the load resistance is reduced to the point that the current output reaches the  $I_{SET}$  level, the power supply switches to CC mode.

Conversely the power supply will operate in CC mode when the load resistance is less than the critical resistance. In CC mode the current output is equal to  $I_{SET}$  and the voltage output is less than  $V_{SET}$ .

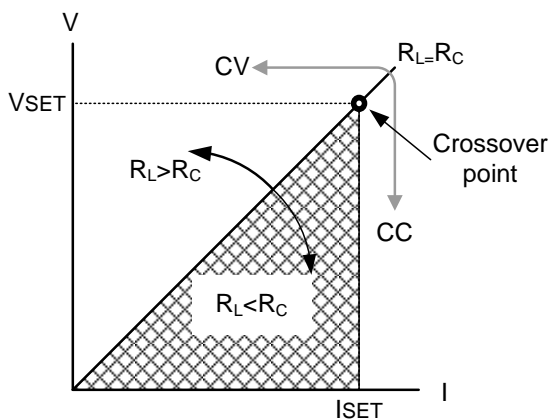

## Slew Rate

### Theory

The PSW has selectable slew rates for CC and CV mode. This gives the PSW power supply the ability to limit the current/voltage draw of the power supply. Slew rate settings are divided into High Speed Priority and Slew Rate Priority. High Speed Priority mode disables slew rate settings for CC or CV mode. Slew Rate Priority mode allows for user adjustable slew rates for CC or CV mode. The rising and falling slew rate can be set independently.

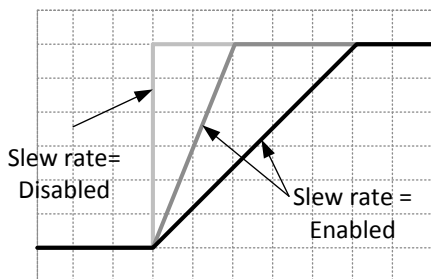

## Bleeder Control

### Background

The PSW DC power supplies employ a bleed resistor in parallel with the output terminals.

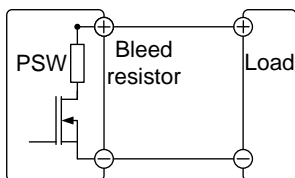

Bleed resistors are designed to dissipate the power from the power supply filter capacitors when power is turned off and the load is



disconnected. Without a bleed resistor, power may remain charged on the filter capacitors for some time and be potentially hazardous.

In addition, bleed resistors also allow for smoother voltage regulation of the power supply as the bleed resistor acts as a minimum voltage load.

The bleed resistance can be turned on or off using the configuration settings.

---



Note

By default the bleed resistance is on. For battery charging applications, be sure to turn the bleed resistance off as the bleed resistor can discharge the connected battery when the unit is off.

## Sink Current Table

Background Sink current (reference value) from an external voltage source according to the bleeder circuit setting.

PSW 30-36

Vout	Bleeder ON	Bleeder OFF
	Sink Current	
(V)	(A)	(mA)
1	1.455	0.000
3	1.733	0.000
5	1.559	0.002
10	1.123	0.009
15	0.715	0.014
20	0.471	0.021
25	0.353	0.031
30	0.267	0.038

PSW 40-27

Vout	Bleeder ON	Bleeder OFF
	Sink Current	
(V)	(A)	(mA)
5	1.193	0.002
10	0.994	0.009
15	0.799	0.014
20	0.625	0.021
25	0.51	0.025
30	0.445	0.03
35	0.397	0.035
40	0.356	0.041

PSW 80-13.5

Vout	Bleeder ON	Bleeder OFF
	Sink Current	
(V)	(A)	(mA)
5	0.640	0.002
10	0.589	0.009
20	0.488	0.015
30	0.387	0.026
40	0.292	0.032
50	0.224	0.045
60	0.188	0.058
80	0.140	0.084

PSW 160-7.2

Vout	Bleeder ON	Bleeder OFF
	Sink Current	
(V)	(A)	(mA)
10	0.173	0.009
20	0.164	0.017
40	0.146	0.034
60	0.128	0.057
80	0.112	0.076
100	0.101	0.095
130	0.093	0.128
160	0.088	0.207

PSW 250-4.5

Vout	Bleeder ON	Bleeder OFF
	Sink Current	
(V)	(A)	(mA)
10	0.158	0.031
30	0.143	0.098
50	0.129	0.164
80	0.107	0.267
100	0.092	0.333
150	0.061	0.508
200	0.463	0.697
250	0.035	0.961

PSW 800-1.44

Vout	Bleeder ON	Bleeder OFF
	Sink Current	
(V)	(A)	(mA)
20	0.061	0.056
50	0.058	0.138
100	0.054	0.274
200	0.046	0.550
300	0.037	0.823
400	0.029	1.097
600	0.020	1.653
800	0.015	2.214

## Internal Resistance

---

### Background

On the PSW, the internal resistance of the power supply can be user-defined in software. (Internal Resistance Setting, page 85). When the internal resistance is set it can be seen as a resistance in series with the positive output terminal. This allows the power supply to simulate power sources that have internal resistances such as lead acid batteries.

### Internal Resistance Range

Unit Model	Internal Resistance Range
PSW 30-36	0.000 ~ 0.833Ω
PSW 40-27	0.000 ~ 1.481Ω
PSW 80-13.5	0.000 ~ 5.926Ω
PSW 160-7.2	0.000 ~ 22.222Ω
PSW 250-4.5	0.00 ~ 55.55Ω
PSW 800-1.44	0.0 ~ 555.5Ω

## Alarms

The PSW power supplies have a number of protection features. When one of the protection alarms are set, the ALM icon on the display will be lit. For details on how to set the protection modes, please see page 61.

---

OVP	Overvoltage protection (OVP) prevents a high voltage from damaging the load.
OCP	Overcurrent protection prevents high current from damaging the load.
OHP (OTP)	Overheat (Over temperature) protection protects the instrument from overheating.
Power Switch Trip	When the Power Switch Trip configuration setting is enabled, the power supply will automatically shut down when a protection setting has been tripped (OCP, OVP, OHP (OTP)).
Alarm output	Alarms are output via the analog control connector. The alarm output is an isolated open-collector photo coupler output.

## Considerations

The following situations should be taken into consideration when using the power supply.

---

Inrush current	When the power supply switch is first turned on, an inrush current is generated. Ensure there is enough power available for the power supply when first turned on, especially if a number of units are turned on at the same time.
----------------	--

---



Caution

Cycling the power on and off quickly can cause the inrush current limiting circuit to fail as well as reduce the working life of the input fuse and power switch.

Pulsed or Peaked loads

When the load has current peaks or is pulsed, it is possible for the maximum current to exceed the mean current value. The PSW power supply ammeter only indicates mean current values, which means for pulsed current loads, the actual current can exceed the indicated value. For pulsed loads, the current limit must be increased, or a power supply with a greater capacity must be chosen. As shown below, a pulsed load may exceed the current limit and the indicated current on the power supply ammeter.

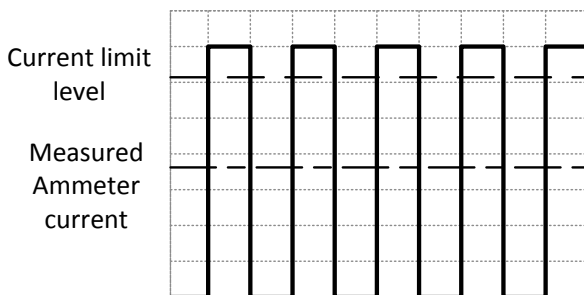

Reverse Current: Regenerative load

When the power supply is connected to a regenerative load such as a transformer or inverter, reverse current will feed back to the power supply. The PSW power supply cannot absorb reverse current. For loads that create reverse current, connect a resistor in parallel (dummy load) to the power supply to bypass the reverse current.

To calculate the resistance for the dummy resistor,  $R_D$ , first determine the maximum reverse current,  $I_R$ , and determine what the output voltage,  $E_O$ , will be.

$$R_D(\Omega) \leq E_O(V) \div I_R(A)$$

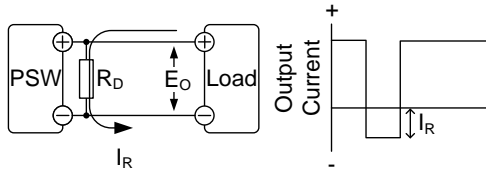

Note

The current output will decrease by the amount of current absorbed by the dummy resistor.

Ensure the resistor used can withstand the power capacity of the power supply/load.

Reverse Current:  
Accumulative  
energy.

When the power supply is connected to a load such as a battery, reverse current may flow back to the power supply. To prevent damage to the power supply, use a reverse-current-protection diode in series between the power supply and load.

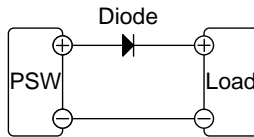

CAUTION

Ensure the reverse withstand voltage of the diode is able to withstand 2 times the rated output voltage of the power supply and the forward current capacity can withstand 3 to 10 times the rated output current of the power supply.

Ensure the diode is able to withstand the heat generated in the following scenarios.

When the diode is used to limit reverse voltage, remote sensing cannot be used.

## Grounding

The output terminals of the PSW power supplies are isolated with respect to the protective grounding terminal. The insulation capacity of the load, the load cables and other connected devices must be taken into consideration when connected to the protective ground or when floating.

**Floating** As the output terminals are floating, the load and all load cables must have an insulation capacity that is greater than the isolation voltage of the power supply.

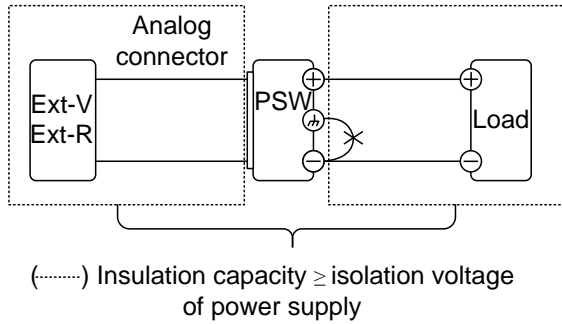

**WARNING**

If the insulation capacity of the load and load cables is not greater than the isolation voltage of the power supply, electric shock may occur.

**Grounded output terminal** If the positive or negative terminal is connected to the protective ground terminal, the insulation capacity needed for the load and load cables is greatly reduced. The insulation capacity only needs to be greater than the maximum output voltage of the power supply with respect to ground.



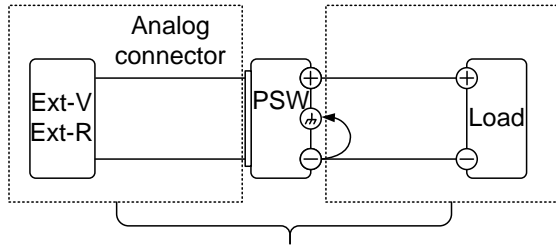

(-----) Insulation capacity  $\geq$  voltage of power supply with respect to ground



If using external voltage control, do not ground the external voltage terminal as this will create a short circuit.

# OPERATION

---

<b>Set Up</b> .....	<b>43</b>
Line Voltage Connection – PSW-1080 Models .....	43
Filter Installation .....	45
Power Up .....	45
Wire Gauge Considerations .....	46
Output Terminals PSW 30/40/80/160 .....	47
Using the Output Terminal Cover PSW 30/40/80/160 .....	49
Output Terminals PSW 250/800 .....	50
Using the Output Terminal Cover PSW 250/800 .....	54
Using the Rack Mount Kit .....	55
How to Use the Instrument .....	55
Reset to Factory Default Settings .....	57
View System Version and Build Date .....	58
<b>Basic Operation</b> .....	<b>61</b>
Setting OVP/OCP Levels .....	61
Set to C.V. Mode .....	63
Set to C.C. Mode .....	66
Display Modes .....	69
Panel Lock .....	70
Remote Sense .....	70
<b>Test Scripts</b> .....	<b>72</b>
Test Script File Format .....	73
Test Script Settings .....	73
Setting the Test Script Settings .....	74
Load Test Script from USB .....	75
Run Test Script (Manual) .....	77
Run Test Script (Automatically at Startup) .....	79
Export Test Script to USB .....	80
Remove Test Script .....	81
Checking the Available Memory .....	82

## Set Up

### Line Voltage Connection – PSW-1080 Models

---

**Background** The PSW-1080 models use a universal power input that can be used with 100 and 200 VAC systems. To connect or replace the power cord (GW Instek part number: 4320-91001101, use the procedure below:

---



Warning

The following procedure should only be attempted by competent persons.

Ensure the AC power cord is not connected to power.

---

**Removal**

1. Turn off the power switch.

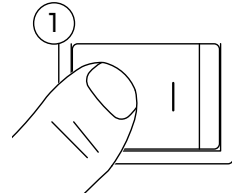

2. Unscrew the power cord protective sheath.
3. Remove the 2 screws holding the power cord cover and remove.

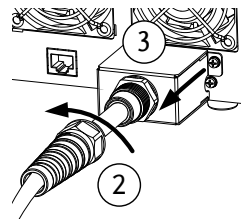

4. Slide the cover off the AC terminals.
5. Remove the AC power cord wires.

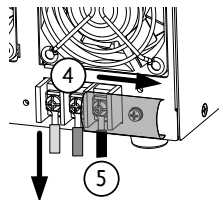

**Installation**

1. Connect the AC power cord wires to the AC input terminals.

- White/Blue → Neutral (N)
- Green/Green-yellow → GND ( $\perp$ )
- Black/Brown → Line (L)

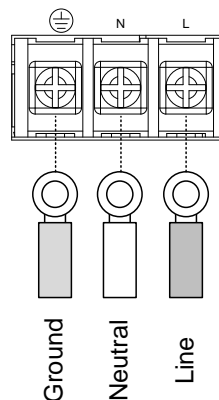

2. Set the cover back over the AC terminals.

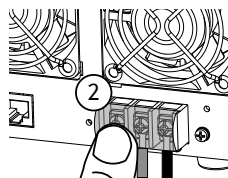

3. Re-install the power cord cover.

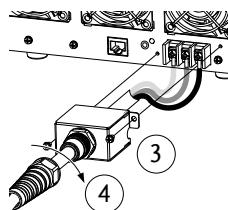

4. Screw the power cord sheath back onto the cover.

## Filter Installation

---

**Background** The PSW has a small filter (GW Instek part number, 57RG-30B001X1) that must first be inserted under the control panel before operation. The small filter must be inserted for all model types.

---

### Steps

1. Insert the small filter in the open area under the control panel.



2. The unit is now ready to power up.

## Power Up

---

### Steps

1. PSW-720: Connect the power cord to the rear panel socket.

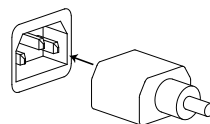

PSW-1080: Connect the power cord to the universal power input.

Page 43

2. Press the POWER key. If used for the first time, the default settings will appear on the display, otherwise The PSW recovers the state right before the power was last turned OFF.

For default configuration settings, see page 143.

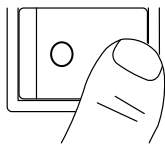

**! CAUTION**

The power supply takes around 8 seconds to fully turn on and shutdown.

Do not turn the power on and off quickly. Please wait for the display to fully turn off.

### Wire Gauge Considerations

**Background** Before connecting the output terminals to a load, the wire gauge of the cables should be considered.

It is essential that the current capacity of the load cables is adequate. The rating of the cables must equal or exceed the maximum current rated output of the instrument.

Recommended wire gauge	Wire Gauge	Nominal Cross Section	Maximum Current
	20	0.5	9
	18	0.75	11
	18	1	13
	16	1.5	18
	14	2.5	24
	12	4	34
	10	6	45
	8	10	64
	6	16	88
	4	25	120
	2	32	145
	1	50	190
	0	70	240
	0	95	290
	0	120	340

The maximum temperature rise can only be 60 degrees above the ambient temperature. The ambient temperature must be less than 30 deg.

## Output Terminals PSW 30/40/80/160

---

**Background** Before connecting the output terminals to the load, first consider whether voltage sense will be used, the gauge of the cable wiring and the withstand voltage of the cables and load.

The output terminals can be connected to load cables using M4 sized screws or M8 sized bolts.

---



### WARNING

Dangerous voltages. Ensure that the power to the instrument is disabled before handling the power supply output terminals. Failing to do so may lead to electric shock.

---

### Steps

1. Turn the power switch off.

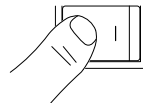

2. Remove the output terminal cover. Page 49

3. If necessary, screw the chassis ground terminal to either the positive or negative terminal. See the grounding chapter for details. Page 40

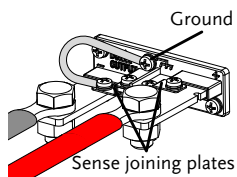

4. Choose a suitable wire gauge for the load cables. Page 46

5. Choose a suitable crimp for the terminals.
6. If using voltage sense, remove the Page 70 sense terminal joining plates and connect sensing wires to the load(s).
7. Connect the positive load cable to the positive output terminal and the negative cable to the negative output terminal.
8. Reattach the output terminal Page 49 cover.

Connection with local sense wiring

Using M4 screws

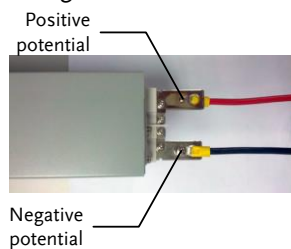

Using M8 bolts

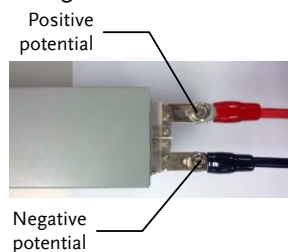

Connection with voltage sense wiring

Using M4 screws

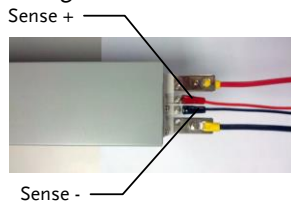

Using M8 bolts

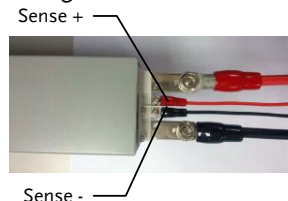



## Using the Output Terminal Cover PSW 30/40/80/160

---

- Steps
1. Remove the screw holding the top cover to the bottom cover.
  2. Line-up the bottom cover with the notches in the output terminals.
  3. Place the top terminal cover over the bottom cover.

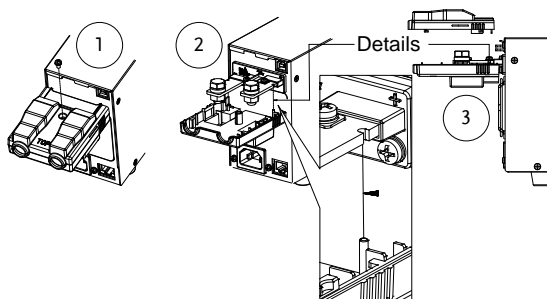

4. Use your thumb to slide the terminal covers shut, as shown in the diagram below.
5. When the top and bottom covers are flush, re-insert the screw that was removed in step 1.

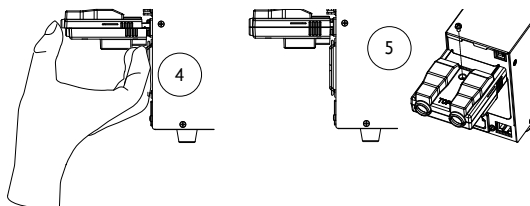

---

### Removal

Reverse the procedure to remove the terminal covers.

## Output Terminals PSW 250/800

---

**Background** The high voltage models (PSW 250 and PSW 800 models) use a 9 pin socket for the output voltage and sense connections. The corresponding plugs (GW part number PSW-012 // DECA SwitchLab MC420-38109Z) should be used to connect the terminals to the appropriate cable.

Before connecting the output terminals to the load, first consider whether voltage sense will be used, the gauge of the cable wiring and the withstand voltage of the cables and load.



**WARNING**

Dangerous voltages. Ensure that the power to the instrument is disabled before handling the power supply output terminals. Failing to do so may lead to electric shock.

Please note the wire gauge used and the capacity of the plug/socket. It may be necessary to wire the load to a number of terminals to offset the capacity over a number of terminals.

**Output Connector Overview** When using the output connector make sure the wires that are used follow the following guidelines:

Wire gauge:	AWG 26 to AWG 16
Strip length	6.5mm // 0.26 in.
Current rating	10A
Insulation resistance	AC 2000V min
Insulation withstand voltage	>2000MΩ DC500V
Operation Temperature	-40°C to +105°C

Output Connector Pinout

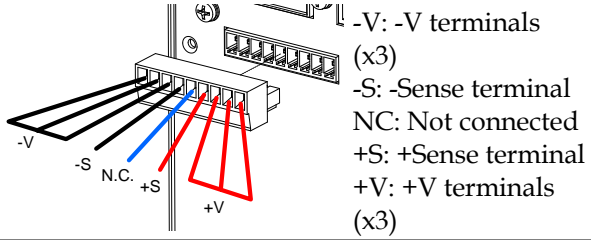

Wiring the Connector Plug

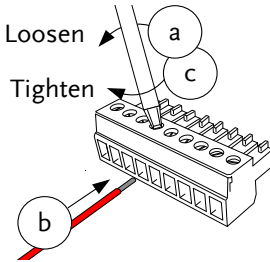

- a. Unscrew the appropriate terminal anticlockwise to release the receptacle.
- b. Insert a wire that has had at least ~7mm stripped from the insulation.
- c. Tighten the receptacle by screwing clockwise.

Steps

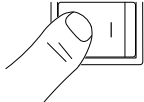
1. Turn the power switch off. 
2. Remove the output terminal cover. Page 54
3. Choose a suitable wire gauge for the load cables. Page 46
4. Strip ~7mm from one end of each load cable.
5. Connect the positive load cable to one of the +V pins and the negative cable to one of the -V pins.



**WARNING**

Please note the wire gauge used and the capacity of the plug/socket. It may be necessary to wire the load to a number of terminals to offset the capacity over a number of terminals.

6. If using local sense, connect the -S pin to a -V pin, and connect the +S pin to a +V pin.

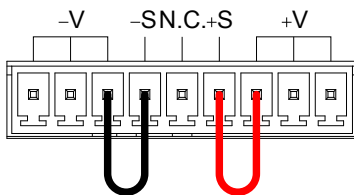

7. If not using local sense, see the remote sense section to wire the sense terminals for remote sensing. Page 70

8. If necessary, connect the chassis ground terminal to either the -V or +V pin. See the grounding chapter for details. Page 40

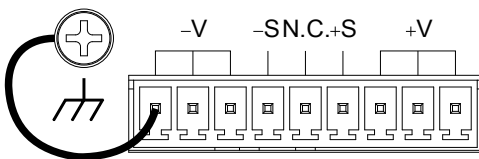

9. Reattach the output terminal cover. Page 54

Local Sense  
Wiring

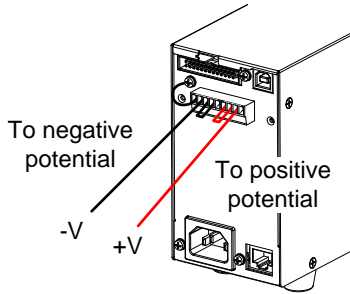

Remote Sense  
Wiring

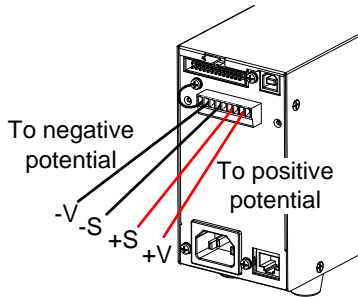

## Using the Output Terminal Cover PSW 250/800

**Steps**

1. Screw the bottom cover onto the rear panel using the two M4 screws.

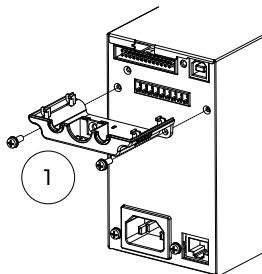

2. Slide the top cover over the bottom cover.

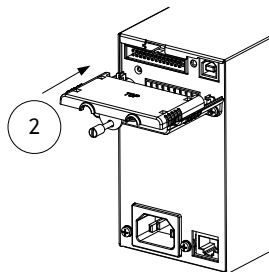

3. Finally, secure the top cover with the screw in the center of the top cover.

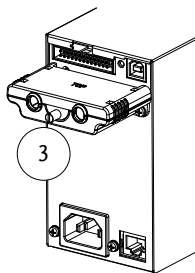

**Removal**

Reverse the procedure to remove the terminal covers.

## Using the Rack Mount Kit

---

**Background** The PSW series has an optional Rack Mount Kit (GW Instek part number: [JIS] GRA-410-J, [EIA] GRA-410-E[EIA]) that can be used to hold 6x PSW models, 3x PSW-720 models, 2x PSW-1080 models or a combination of all models (1x PSW, 1x PSW-720 and 1x PSW-1080).

**Rack mount diagram**



## How to Use the Instrument

---

**Background** The PSW power supplies use a novel method of configuring parameter values only using the Voltage or Current knobs. The knobs are used to quickly edit parameter values at 0.01, 0.1 or 1 unit steps at a time.

When the user manual says to set a value or parameter, use the steps below.

---

**Example** Use the Voltage knob to set a voltage of 10.05 volts.

1. Repeatedly press the Voltage knob until the last digit is highlighted. This will allow the voltage to be edited in 0.01 volt steps.

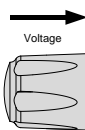

2. Turn the Voltage knob till 0.05 volts is shown.

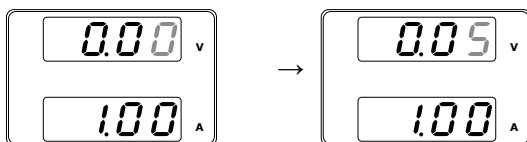
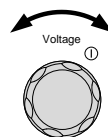

3. Repeatedly press the Voltage knob until the first digit is highlighted. This will allow the voltage to be edited in 1 volt steps.
4. Turn the Voltage knob until 10.05 is shown.

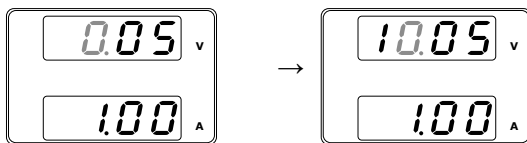

 Note

Notice the Set key becomes illuminated when setting the current or voltage.

If the Voltage or Current knobs are unresponsive, press the Set key first.



## Reset to Factory Default Settings

**Background** The F-88 configuration setting allows the PSW to be reset back to the factory default settings. See page 143 for the default factory settings.

**Steps** 1. Press the Function key. The Function key will light up.

Function



2. The display should show F-01 on the top and the configuration setting for F-01 on the bottom.

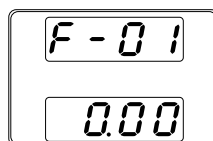

3. Rotate the Voltage knob to change the F setting to F-88 (Factory Set Value).

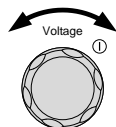

4. Use the Current knob to set the F-88 setting to 1 (Return to factory settings).

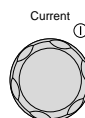

5. Press the Voltage knob to confirm. Conf will be displayed when successful.

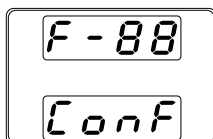
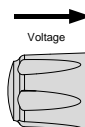

6. Press the Function key again to exit. The function key light will turn off.

Function



## View System Version and Build Date

**Background** The F-89 configuration setting allows you to view the PSW version number, build date, keyboard version, analog-control version, kernel build, test command version, test command build date, and the USB driver version.

**Steps**

1. Press the Function key. The Function key will light up.

Function



2. The display should show F-01 on the top and the configuration setting for F-01 on the bottom.



3. Rotate the Voltage knob to change the F setting to F-89 (Show Version).

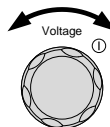

4. Rotate the Current knob to view the version and build date for the various items.

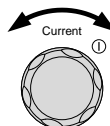

**F-89**

- 0-XX: PSW Main Program Version
- 1-XX: PSW Main Program Version
- 2-XX: PSW Main Program Build On-Year.
- 3-XX: PSW Main Program Build On-Year.
- 4-XX: PSW Main Program Build On-Month.
- 5-XX: PSW Main Program Build On-Day.
- 6-XX: Keyboard CPLD version.
- 7-XX: Keyboard CPLD version.
- 8-XX: Analog CPLD version.

9-XX: Analog CPLD version.  
 A-XX: Control Board Version.  
 B-XX: Reserved.  
 C-XX: Kernel Build On-Year.  
 D-XX: Kernel Build On-Year.  
 E-XX: Kernel Build On-Month.  
 F-XX: Kernel Build On-Day.  
 G-XX: Test Command Version.  
 H-XX: Test Command Version.  
 I-XX: Test Command Build On-Year.  
 J-XX: Test Command Build On-Year.  
 K-XX: Test Command Build On-Month.  
 L-XX: Test Command Build On-Day.  
 M-XX: USB Driver version (Major).  
 N-XX: USB Driver version (Minor).

5. Press the Function key again to exit. The function key light will turn off.

Function



Example

Main Program Version: Vt1.50, 2014/01-13

0-t1: PSW Main Program Version  
 1-50: PSW Main Program Version  
 2-20: PSW Main Program Build On-Year.  
 3-14: PSW Main Program Build On-Year.  
 4-01: PSW Main Program Build On-Month.  
 5-13: PSW Main Program Build On-Day.

Example

Keyboard CPLD Version: 0x030c

6-03: Keyboard CPLD Version.  
 7-0c: Keyboard CPLD Version.

Example

Analog CPLD Version: 0x0427

8-04: Analog CPLD Version.  
 9-27: Analog CPLD Version.

Example

Kernel Version: 2013/03/22

C-20: Kernel Build On-Year.  
D-13: Kernel Build On-Year.  
E-03: Kernel Build On-Month.  
F-22: Kernel Build On-Day.

Example            Test Command Version: V01:00, 2011/08/01

G-01: Test Command Version.  
H-00: Test Command Version.  
I-20: Test Command Build On-Year.  
J-11: Test Command Build On-Year.  
K-08: Test Command Build On-Month.  
L-01: Test Command Build On-Day.

Example            USB Driver Version: V02.01:

M-02: USB Driver Version (Major release).  
N-01: USB Driver Version (Minor release).

## Basic Operation

This section describes the basic operations required to operate the power supply.

- Setting OVP/OCP → from page 61
- C.V. mode → from page 62
- C.C. mode → from page 66
- Display modes → page 69
- Panel lock → page 70
- Remote sensing → from page 70

Before operating the power supply, please see the Getting Started chapter, page 8.

### Setting OVP/OCP Levels

---

**Background** For most models the OVP level has a selectable range of approximately\* 10% to 110% of the rated output voltage. Likewise the OCP level for most models has a selectable range of approximately\* 10%~ 110% of the rated output current. The OVP and OCP level is set to the maximum by default. The OCP level can also be turned off.

\*Note that the *actual* setting range differs for each model.

When one of the protection measures are on, ALM is shown on the panel display. By default, the power switch will turn off when any of the protection levels are tripped.

---

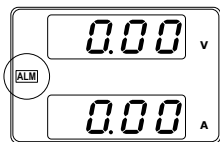

Before setting the OVP or OCP level:

- Ensure the load is not connected.
- Ensure the output is set to off.

**Setting Ranges**

PSW	30-36	40-27	80-13.5	160-7.2	250-4.5	800-1.44
OVP Range (V)	3-33	4-44	8-88	16-176	20-275	20-880
OCP Range (A)	3.6-39.6	2.7-29.7	1.35-14.85	0.72-7.92	0.45-4.95	0.144-1.584

**Steps**

1. Press the OVP/OCP key. The OVP/OCP key lights up. 
2. The OVP setting will be displayed on the top and the OCP setting (or OFF) will be displayed on the bottom.

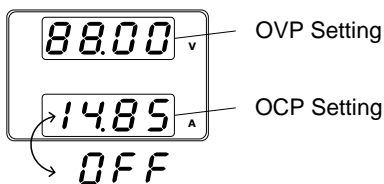

**OVP Level**

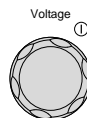

3. Use the Voltage knob to set the OVP level.

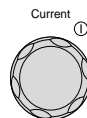

**OCP Level**

4. Use the Current knob to set the OCP level, or to turn OCP off.



	5. Press OVP/OCP again to exit. The OVP/OCP indicator will turn off.	OVP/OCP 
Power switch trip	Set F-95 (Power switch trip) to 1 (to disable the power switch trip) or to 0 (to enable the power switch trip) and save.  F-95                      1 (Disable) or 0 (Enable)	Page 98
Clear OVP/OCP protection	The OVP or OCP protection can be cleared after it has been tripped by holding the OVP/OCP button for 2 seconds. (Only applicable when the power switch trip setting is disabled [F-95 = 1])	OVP/OCP  (hold)

## Set to C.V. Mode

When setting the power supply to constant voltage mode, a current limit must also be set to determine the crossover point. When the current exceeds the crossover point, the mode switches to C.C. mode. For details about C.V. operation, see page 28. C.C. and C.V. mode have two selectable slew rates: High Speed Priority and Slew Rate Priority. High Speed Priority will use the fastest slew rate for the instrument while Slew Rate Priority will use a user-configured slew rate.

**Background** Before setting the power supply to C.V. mode, ensure:

- The output is off.
- The load is connected.

**Steps** 1. Press the Function key. The Function key will light up.



2. The display should show F-01 on the top and the configuration setting for F-01 on the bottom.



3. Rotate the Voltage knob to change the F setting to F-03 (V-I Mode Slew Rate Select).

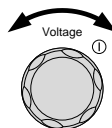

4. Use the Current knob to set the F-03 setting.

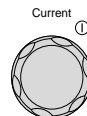

Set F-03 to 0 (CV High Speed Priority) or 2 (CV Slew Rate Priority).

F-03      0 = CV High Speed Priority  
             2 = CV Slew Rate Priority

5. Press the Voltage knob to save the configuration setting. ConF will be displayed when successful.

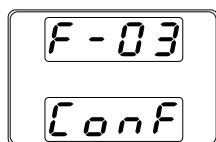
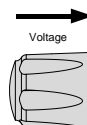



6. If CV Slew Rate Priority was chosen as the operating mode, repeat steps 3~5 to set F-04 (Rising Voltage Slew Rate) and the F-05 (Falling Voltage Slew Rate) and save.

F-04 / F-05 0.1V/s ~ 60V/s (PSW 30)  
 0.1V/s ~ 80V/s (PSW 40)  
 0.1V/s ~ 160V/s (PSW 80)  
 0.1V/s ~ 320V/s (PSW 160)  
 0.1V/s ~ 500.0V/s (PSW 250)  
 1V/s ~ 1600V/s (PSW 800)

7. Press the Function key again to exit the configuration settings. The function key light will turn off.

Function



8. Use the Current knob to set the current limit (crossover point).

Current ①



9. Use the Voltage knob to set the voltage.

Voltage ①



Note

Notice the Set key becomes illuminated when setting the current or voltage. If the Voltage or Current knobs are unresponsive, press the Set key first.

10. Press the Output key. The Output key becomes illuminated.

Output

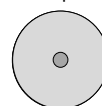

CV and the Power Bar will become illuminated (top left & center)



Note

Only the voltage level can be altered when the output is on. The current level can only be changed by pressing the Set key.

For more information on the Normal Function Settings (F-00 ~ F-61, F-88~F-89) see page 87.

### Set to C.C. Mode

When setting the power supply to constant current mode, a voltage limit must also be set to determine the crossover point. When the voltage exceeds the crossover point, the mode switches to C.V. mode. For details about C.C. operation, see page 28. C.C. and C.V. mode have two selectable slew rates: High Speed Priority and Slew Rate Priority. High Speed Priority will use the fastest slew rate for the instrument while Slew Rate Priority will use a user-configured slew rate.

#### Background

Before setting the power supply to C.C. mode, ensure:

- The output is off.
- The load is connected.

#### Steps

1. Press the Function key. The Function key will light up.



2. The display should show F-01 on the top and the configuration setting for F-01 on the bottom.

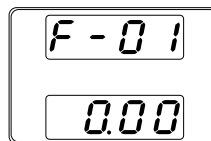

3. Rotate the Voltage knob to change the F setting to F-03 (V-I Mode Slew Rate Select).

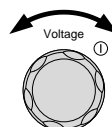

4. Use the Current knob to set the F-03 setting.



Set F-03 to 1 (CC High Speed Priority) or 3 (CC Slew Rate Priority) and save.

F-03            1 = CC High Speed Priority  
                   3 = CC Slew Rate Priority

5. Press the Voltage knob to save the configuration setting. ConF will be displayed when successful.

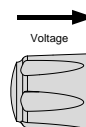

6. If CC Slew Rate Priority was chosen as the operating mode, set F-06 (Rising Current Slew Rate) and F-07 (Falling Current Slew Rate) and save.

F-06 / F-07 0.01A/s ~ 72.00A/s (PSW 30-36)  
                   0.01A/s ~ 54.00A/s (PSW 40-27)  
                   0.01A/s ~ 27.00A/s (PSW 80-13.5)  
                   0.01A/s ~ 14.40A/s (PSW 160-7.2)  
                   0.001A/s ~ 9.000A/s (PSW 250-4.5)  
                   0.001A/s ~ 2.880A/s (PSW 800-1.44)

7. Press the Function key again to exit the configuration settings. The function key light will turn off.



8. Use the Voltage knob to set the voltage limit (crossover point).



9. Use the Current knob to set the current.

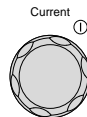

Note

Notice the Set key becomes illuminated when setting the current or voltage. If the Voltage or Current knobs are unresponsive, press the Set key first.

10. Press the Output key. The Output key becomes illuminated.

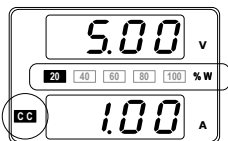
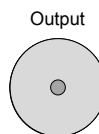

CC and the Power Bar will become illuminated (bottom left & center)



Note

Only the current level can be altered when the output is on. The voltage level can only be changed by pressing the Set key.

For more information on the Normal Function Settings (F-00 ~ F-61, F-88~F-89) see page 87.

## Display Modes

The PSW power supplies allow you to view the output in three different modes: voltage and current, voltage and power or current and power.

### Steps

1. Press the PWR/DSPL key. The PWR DSPL key lights up. 
2. The display changes to voltage and power (V/W).
3. To switch between displaying A/W and V/W, simply press the corresponding Voltage or Current knob.

For example: when in A/W mode, press the Voltage knob to display V/W. Conversely when in V/W mode, press the Current knob to display A/W.

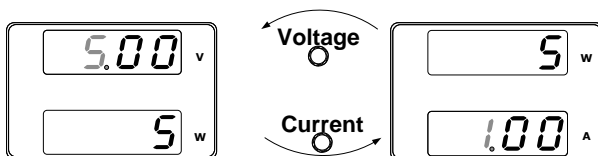

- When V/W is displayed, the Voltage knob can still be used to change the voltage level.
- When A/W is displayed, the Current knob can still be used to change the current level.

### Exit

Press the PWR/DSPL key again to return to normal display mode. The PWR DSPL light will turn off.



## Panel Lock

The panel lock feature prevents settings from being changed accidentally. When activated, the Lock/Local key will become illuminated and all keys and knobs except the Lock/Local key and Output key (if active) will be disabled.

If the instrument is remotely controlled via the USB/LAN interface, the panel lock is automatically enabled.

Activate the panel lock	Press the Lock/Local key to activate the panel lock. The key will become illuminated.	
-------------------------	---	---

Disable the panel lock	Hold the Lock/Local key for ~3 seconds to disable the panel lock. The Lock/Local light turns off.	
------------------------	---	---

## Remote Sense

Remote sense is used to compensate for the voltage drop seen across load cables due to the resistance inherent in the load cables. The remote sense terminals are connected to the load terminals to determine the voltage drop across the load cables.

Remote sense can compensate up to 0.6 volts for 30V/40V/80V/160V models and 1V for 250V/800V models (compensation voltage). Load cables should be chosen with a voltage drop less than the compensation voltage.



**WARNING**

Ensure the output is off before connecting any sense cables.

Use sense cables with a voltage rating exceeding the isolation voltage of the power supply.

Never connect sensing cables when the output is on. Electric shock or damage to the power supply could result.



Note

Be sure to remove the Sense joining plates so the units are not using local sensing.

Single Load

1. Connect the Sense+ terminal to the positive potential of the load. Connect the Sense- terminal to the negative potential of the load.

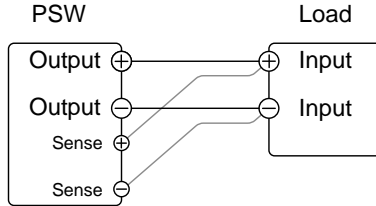

Page 47

2. Operate the instrument as normal. See the Basic Operation chapter for details.

Wire Shielding and Load line impedance

To help to minimize the oscillation due to the inductance and capacitance of the load cables, use an electrolytic capacitor in parallel with the load terminals.

To minimize the effect of load line impedance use twisted wire pairing.

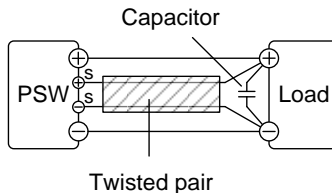

## Test Scripts

This section describes how to use the Test function to run, load and save test scripts for automated testing. The Test function is useful if you want to perform a number of tests automatically. The PSW test function can store ten test scripts in memory.

Each test script is programmed in a scripting language. For more information on how to create test scripts, please contact GW Instek.

- Test Script File Format → from page 73
- Test Script Settings → from page 73
- Setting the Test Script Settings → from page 74
- Load Test Script → from page 75
- Run Test Script (Manually) → from page 77
- Run Test Script (Automatically at startup) → from page 79
- Export Test Script → from page 80
- Remove Test Script → from page 81
- Check the Available Memory Capacity → from page 82



## Test Script File Format

---

Background	The test files are saved in *.tst file format.
	Each file is saved as tXXX.tst, where XXX is the save file number 001~010.

## Test Script Settings

---

Test Run	Runs the chosen test script from the internal memory. A script must first be loaded into the internal memory before it can be run. See the test function Test Save, below.
	The script will run as soon as the test function is started.
	T-01                      1~10
Test Load	Loads a test script from the USB drive to the designated save slot in memory. A script must first be loaded into internal memory before it can be run.
	T-02                      1~10 (USB→PSW)
Test Export	Exports a script from the designated memory save slot to the USB drive.
	T-03                      1~10 (PSW→USB)
Test Remove	Deletes the chosen test file from the PSW internal memory.
	T-04                      1~10
Test Memory	Displays the amount of internal memory that is available on the unit in kilobytes (1024 bytes).
	T-05                      Max: 1848 KB

## Setting the Test Script Settings

Steps                      The test script settings (T-01~T-04) are set with the Test key.

1. Press the Test key. The Test key will light up.



2. The display will show T-01 on the top and the memory no. for T-01 on the bottom. The bottom of the screen will also indicate whether the memory no. has a script loaded, "y" (yes) or "n" (no).

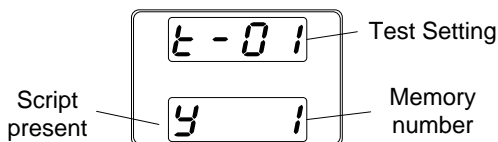
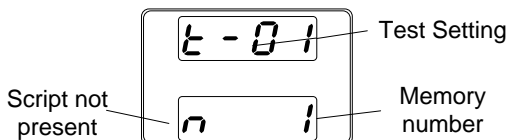

3. Rotate the Voltage knob to change the T setting (Test setting).

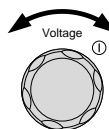

Test Run	T-01
Test Load	T-02
Test Export	T-03
Test Remove	T-04
Test Memory	T-05

4. Rotate the Current knob to choose a memory number.

Range 1~10

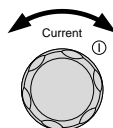

5. Press the Voltage knob to complete the setting.

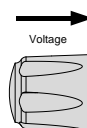

Exit

Press the Test key again to exit the Test settings. The Test key light will turn off.



## Load Test Script from USB

Overview

Before a test script can be run, it must first be loaded into a one of the 10 memory save slots. Before loading a test script into memory:

- Ensure the script file is placed in the root directory.
- Ensure the file name number corresponds to the memory number that you wish to save to.

For example: A test file named t001.tst can only be saved to memory number 01, t002.tst can only be saved to memory number 02, and so on.

Steps

1. Insert a USB flash drive into the front panel USB-A slot. Ensure the flash drive contains a test script in the root directory.

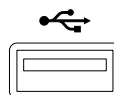

- Turn on the power. MS (Mass Storage) will be displayed on the screen after a few seconds if the USB drive is recognized.

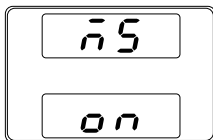

Note

If the USB drive is not recognized, check to see that the function settings for F-20 = 1 (page 91). If not, reinsert the USB flash drive.

---

- Configure T-02 (Test Load) to 1~10 Page 74 (save memory slot)  
T-02 range 1~10 (t001 ~t010)
  - The script will now be available in the memory slot the script was saved to.
- 



Note

Error messages: If you load a file that is not present on the USB drive "Err 002" will be displayed on the display.

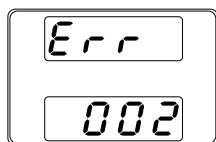

## Run Test Script (Manual)

---

Overview A test script can be run from one of ten memory slots.

---

- Steps
1. Before a test script can be run, it must first be loaded into one of the 10 memory save slots. Page 75
  2. Configure T-01 (Run Test) to 1~10 (save memory slot#). Page 74  
T-01 range 1~10
  3. The loading screen will appear. For example if memory slot #1 is loaded, the following screen will appear.

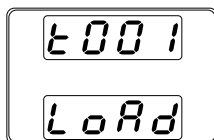

Note

If the script is very small, the loading screen may not appear on the screen for very long.

When the “t00X Load” screen is shown on the display, pushing the TEST key will abort the loading procedure.

---

4. If there are no errors during loading, the script engine will enter the wait state. The wait state indicates that the unit is ready to execute the script.

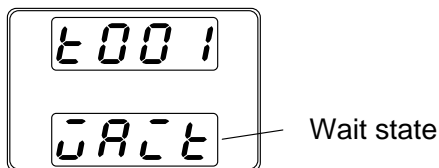

5. To execute the script, press the Output key. The Output key becomes illuminated.

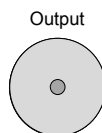

- When the script is executing, the measurement results will display as normal.
- The Test LED will flash.



Note

When a script is running, press the Output key again to return the script engine to the wait state.



Note

When a script is running, press the Test key to abort the execution of the script and return to normal operating mode. The Test LED will turn off after the script has been aborted.



Note

Error messages: If you try to run a test script from an empty memory location “Err 003” will be displayed on the display.

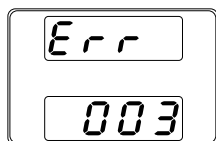

## Run Test Script (Automatically at Startup)

---

Overview      The power supply can be configured to automatically run a test script at startup.

---

- Steps
1. Before a test script can be run, it must first be loaded into one of the 10 memory save slots. Page 75
  2. Turn the unit off.
  3. Enter the power-on configuration settings and set F-92 (Power-ON Output) to run the desired test script. Page 98  
Range      T001~T010\*
  4. The selected test script will automatically start to run the next time the unit is powered on.
- 



Note

\*Setting F-92 to 0 or 1 will disable loading a test script at startup. 0 will turn the output off at startup. 1 will turn the output on at startup. See the power on configuration settings for details, page 94.

---



Note

When a script is running, press the Output key to pause the script. To resume the script, press the Output key again.

## Export Test Script to USB

---

### Overview

The Export Test function saves a test file to the root directory of a USB flash drive.

- Files will be saved as tXXX.tst where XXX is the memory number 001~010 from which the test script was exported from.
  - Files of the same name on the USB flash drive will be written over.
- 

### Steps

1. Insert a USB flash drive into the front panel USB-A slot.

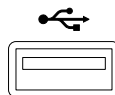

2. Turn on the power. MS (Mass Storage) will be displayed on the screen after a few seconds if the USB drive is recognized.

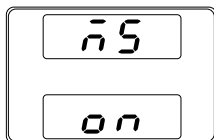

### Note

If the USB drive is not recognized, check to see that the function settings for F-20 = 1 (page 91). If not, reinsert the USB flash drive.

---

3. Configure T-03 (Test Export) to 0~10 (save memory slot) Page 74  
T-03 range 1~10
  4. The script will now be copied to the USB flash drive.
-





Note

Error messages: If you try to export a test script from an empty memory location “Err 003” will be displayed on the display.

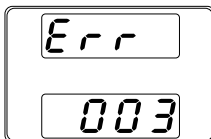

## Remove Test Script

---

Overview      The Remove Test function will delete a test script from the internal memory.

---

- Steps
1. Select T-04 (Test Remove) and choose which test script to remove from the internal memory. Page 74  
T-04 range 1~10
  2. The test script will be removed from the internal memory.
- 



Note

Error messages: If you try to remove a test script from an empty memory location “Err 003” will be displayed on the display.

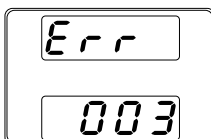

## Checking the Available Memory

---

**Overview**                      The T-05 function displays the amount of internal memory that is left on the unit to load test scripts. The displayed units are in kilobytes (1024 bytes).

---

**Steps**                              Select T-05 (Test Memory). The available memory in kilobytes is displayed. Page 74

T-05 range 1~1848 KB

# C ONFIGURATION

---

Configuration .....	84
Configuration Table.....	84
Normal Function Settings.....	88
USB/GPIB Settings*.....	92
LAN Settings* .....	93
System Settings .....	94
Power On Configuration Settings.....	95
Multi-Channel Function Setting.....	96
Calibration.....	97
Setting Normal Function Settings.....	97
Setting Power On Configuration Settings.....	98

## Configuration

Configuration of the PSW power supplies is divided into six different configuration settings: Normal Function, USB/ GPIB/ RS232, LAN, Power ON Configuration, Calibration Setting, Multi-channel Function setting and System settings. Power ON Configuration differs from the other settings in that the settings used with Power ON Configuration settings can only be set during power up. The other configuration settings can be changed when the unit is already on. This prevents some important configuration parameters from being changed inadvertently. Power On Configuration settings are numbered F-90 to F-95 and the other configuration settings are numbered F-00 to F-61, F-71 to F-74, F-88 to F-89 and F130 to F132.

### Configuration Table

Please use the configuration settings listed below when applying the configuration settings.

Normal Function Settings	Setting	Setting Range
Output ON delay time	F-01	0.00s~99.99s
Output OFF delay time	F-02	0.00s~99.99s
V-I mode slew rate select	F-03	0 = CV high speed priority 1 = CC high speed priority 2 = CV slew rate priority 3 = CC slew rate priority
Rising voltage slew rate	F-04	0.01V/s ~ 60.00V/s (PSW 30) 0.01V/s ~ 80.00V/s (PSW 40) 0.1V/s ~ 160.0V/s (PSW 80) 0.1V/s ~ 320.0V/s (PSW 160) 0.1V/s ~ 500.0V/s (PSW 250) 1V/s ~ 1600V/s (PSW 800)
Falling voltage slew rate	F-05	0.01V/s ~ 60.00V/s (PSW 30) 0.01V/s ~ 80.00V/s (PSW 40) 0.1V/s ~ 160.0V/s (PSW 80) 0.1V/s ~ 320.0V/s (PSW 160) 0.1V/s ~ 500.0V/s (PSW 250) 1V/s ~ 1600V/s (PSW 800)

Rising current slew rate	F-06	0.01A/s ~ 72.00A/s (PSW 30-36)
		0.01A/s ~ 54.00A/s (PSW 40-27)
		0.01A/s ~ 27.00A/s (PSW 80-13.5)
		0.01A/s ~ 14.40A/s (PSW 160-7.2)
		0.001A/s ~ 9.000A/s (PSW 250-4.5)
		0.001A/s ~ 2.880A/s (PSW 800-1.44)
Falling current slew rate	F-07	0.01A/s ~ 72.00A/s (PSW 30-36)
		0.01A/s ~ 54.00A/s (PSW 40-27)
		0.01A/s ~ 27.00A/s (PSW 80-13.5)
		0.01A/s ~ 14.40A/s (PSW 160-7.2)
		0.001A/s ~ 9.000A/s (PSW 250-4.5)
		0.001A/s ~ 2.880A/s (PSW 800-1.44)
Internal resistance setting	F-08	0.000Ω ~ 0.833Ω (PSW 30-36)
		0.000Ω ~ 1.481Ω (PSW 40-27)
		0.000Ω ~ 5.926Ω (PSW 80-13.5)
		0.000Ω ~ 22.222Ω (PSW 160-7.2)
		0.00Ω ~ 55.55Ω (PSW 250-4.5)
		0.0Ω ~ 555.5Ω (PSW 800-1.44)
Bleeder circuit control	F-09	0 = OFF, 1 = ON, 2 = AUTO
Buzzer ON/OFF control <sup>*1</sup>	F-10	0 = OFF, 1 = ON
Measurement Average Setting	F-17	0 = Low, 1 = Middle, 2 = High
Lock Mode	F-19	0 = Panel lock: allow output off
		1 = Panel lock: allow output on/off
USB/GPIB/RS232 settings <sup>*1</sup>		
Front panel USB State	F-20	0 = Absent, 1 = Mass Storage
Rear panel USB State	F-21	0 = Absent, 2 = USB-CDC, 3 = GPIB-USB adapter, 5 = RS232-USB adapter
		0 = Disable, 1 = USB Host, 2 = Auto detect speed, 3 = Full speed only
Rear panel USB mode	F-22	0 = Disable, 1 = USB Host, 2 = Auto detect speed, 3 = Full speed only
GPIB address	F-23	0 ~ 30
LAN settings <sup>*1</sup>		
MAC Address-1	F-30	0x00 ~ 0xFF
MAC Address-2	F-31	0x00 ~ 0xFF
MAC Address-3	F-32	0x00 ~ 0xFF
MAC Address-4	F-33	0x00 ~ 0xFF
MAC Address-5	F-34	0x00 ~ 0xFF
MAC Address-6	F-35	0x00 ~ 0xFF
LAN	F-36	0 = Disable, 1 = Enable

DHCP	F-37	0 = Disable, 1 = Enable
IP Address-1	F-39	0 ~ 255
IP Address-2	F-40	0 ~ 255
IP Address-3	F-41	0 ~ 255
IP Address-4	F-42	0 ~ 255
Subnet Mask-1	F-43	0 ~ 255
Subnet Mask-2	F-44	0 ~ 255
Subnet Mask-3	F-45	0 ~ 255
Subnet Mask-4	F-46	0 ~ 255
Gateway-1	F-47	0 ~ 255
Gateway-2	F-48	0 ~ 255
Gateway-3	F-49	0 ~ 255
Gateway-4	F-50	0 ~ 255
DNS address -1	F-51	0 ~ 255
DNS address -2	F-52	0 ~ 255
DNS address-3	F-53	0 ~ 255
DNS address-4	F-54	0 ~ 255
Sockets active	F-57	0 = Disable, 1 = Enable
Web Server active	F-59	0 = Disable, 1 = Enable
Web password active	F-60	0 = Disable, 1 = Enable
Web setting password	F-61	0000~9999
<b>UART Settings<sup>*1*3</sup></b>		
UART Baud Rate	F-71	0 = 1200, 1 = 2400, 2 = 4800, 3 = 9600, 4 = 19200, 5 = 38400, 6 = 57600, 7 = 115200
UART Data Bits	F-72	0 = 7 bits, 1 = 8 bits
UART Parity	F-73	0 = None, 1 = Odd, 2 = Even
UART Stop Bit	F-74	0 = 1 bit, 1 = 2 bits
<b>System Settings</b>		
Factory Set Value	F-88	0 = No effect 1 = Return to factory settings 2 <sup>*1</sup> = All channels return to factory settings
Show Version	F-89	0, 1 = PSW version 2, 3 = PSW build year 4, 5 = PSW build month/day 6, 7 = Keyboard CPLD version 8, 9 = Analog-Control CPLD version A = Control Board Version B = Reserved

C, D = Kernel build year  
 E, F = Kernel build month/day  
 G, H = Test command version  
 I, J = Test command build year  
 K, L = Test command build month/  
 day  
 M, N = USB Driver version.

Power On Configuration Settings*2		
CV Control	F-90	0 = Panel control (local) 1 = External voltage control 2 = External resistance control (Ext-R $\searrow$ 10k $\Omega$ = Vo, max) 3 = External resistance control (Ext-R $\triangle$ 10k $\Omega$ = 0)
CC Control	F-91	0 = Panel control (local) 1 = External voltage control 2 = External resistance control (Ext-R $\searrow$ 10k $\Omega$ = Io, max) 3 = External resistance control (Ext-R $\triangle$ 10k $\Omega$ = 0)
Power-ON Output	F-92	0 = OFF at startup 1 = ON at startup T001 ~ T010 = Run test script TXX at start up
External Out Logic	F-94	0 = High ON, 1 = Low ON
Power Switch trip*1	F-95	0 = Enable , 1 = Disable
Multi-Channel Function Settings		
Output Synchronize	F130	0 = OFF, 1 = ON, 2*1 = All Channel ON, 3*1 = All Channel OFF
Protection Trigger Synchronous	F131	0 = OFF, 1 = ON, 2*1 = All Channel ON, 3*1 = All Channel OFF
Key Lock/ Local Synchronize*1	F132	0 = OFF, 1 = ON
Calibration Settings		
Calibration	F-00	0000 ~ 9999

**Note**

\*1 : Only configure from CH1

\*2 : Power on configuration settings only can be set during power up.

Enter configuration setting from CH1 and each channel can be used different settings. Under normal operation they only can be viewed.

\*3 : Need to be used together with GUR-001 series.

## Normal Function Settings

---

**Output ON Delay Time** Delays turning the output on for a designated amount of time. The Delay indicator will light when the Delay time is not 0.

Note: The Output ON Delay Time setting has a maximum deviation (error) of 20ms.

The Output ON Delay Time setting is disabled when the output is set to external control.

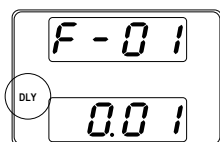

F-01                      0.00s~99.99s

---

**Output OFF Delay Time** Delays turning the output off for a designated amount of time. The Delay indicator will light when the Delay time is not 0.



Note

The Output OFF Delay Time setting has a maximum deviation (error) of 20ms.

The Output OFF Delay Time setting is disabled when the output is set to external control.

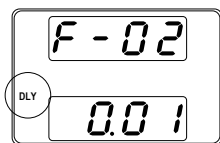

F-02                      0.00s~99.99s

---



**V-I Mode** Selects High Speed Priority or Slew Rate Priority for CV or CC mode. The voltage or current slew rate can only be edited if CC/CV Slew Rate Priority is selected. The ISR indicator will be lit for CC Slew Rate Priority and the VSR indicator will be lit for CV Slew Rate Priority.

Note: CC and CV Slew Rate Priority mode are disabled when voltage/current output is set to external control.

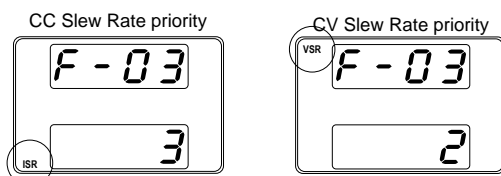

F-03

- 0 = CV high speed priority
- 1 = CC high speed priority
- 2 = CV slew rate priority
- 3 = CC slew rate priority

**Rising Voltage Slew Rate** Sets the rising voltage slew rate. Only applicable if V-I Mode is set to CV Slew Rate Priority.

- F-04
- 0.01V/s ~ 60V/s (PSW 30)
  - 0.01V/s ~ 80.00V/s (PSW 40)
  - 0.1V/s ~ 160V/s (PSW 80)
  - 0.1V/s ~ 320V/s (PSW 160)
  - 0.1V/s ~ 500.0V/s (PSW 250)
  - 1V/s ~ 1600V/s (PSW 800)

**Falling Voltage Slew Rate** Sets the falling voltage slew rate. Only applicable if V-I Mode is set to CV Slew Rate Priority.

- F-05
- 0.01V/s ~ 60V/s (PSW 30)
  - 0.01V/s ~ 80.00V/s (PSW 40)
  - 0.1V/s ~ 160V/s (PSW 80)
  - 0.1V/s ~ 320V/s (PSW 160)
  - 0.1V/s ~ 500.0V/s (PSW 250)
  - 1V/s ~ 1600V/s (PSW 800)

Rising Current Slew Rate      Sets the rising current slew rate. Only applicable if V-I Mode is set to CC Slew Rate Priority.

F-06                      0.01A/s ~ 72.00A/s (PSW 30-36)  
                                  0.01A/s ~ 54.00A/s (PSW 40-27)  
                                  0.01A/s ~ 27.00A/s (PSW 80-13.5)  
                                  0.01A/s ~ 14.40A/s (PSW 160-7.2)  
                                  0.001A/s ~ 9.000A/s (PSW 250-4.5)  
                                  0.001A/s ~ 2.880A/s (PSW 800-1.44)

Falling Current Slew Rate      Sets the falling current slew rate. Only applicable if V-I Mode is set to CC Slew Rate Priority.

F-07                      0.01A/s ~ 72.00A/s (PSW 30-36)  
                                  0.01A/s ~ 54.00A/s (PSW 40-27)  
                                  0.01A/s ~ 27.00A/s (PSW 80-13.5)  
                                  0.01A/s ~ 14.40A/s (PSW 160-7.2)  
                                  0.001A/s ~ 9.000A/s (PSW 250-4.5)  
                                  0.001A/s ~ 2.880A/s (PSW 800-1.44)

Internal Resistance Settings      Sets the internal resistance of the power supply.

F-08                      0.000Ω ~ 0.833Ω (PSW 30-36)  
                                  0.000Ω ~ 1.481Ω (PSW 40-27)  
                                  0.000Ω ~ 5.926Ω (PSW 80-13.5)  
                                  0.000Ω ~ 22.222Ω (PSW 160-7.2)  
                                  0.00Ω ~ 55.55Ω (PSW 250-4.5)  
                                  0.0Ω ~ 555.5Ω (PSW 800-1.44)

Bleeder Control      Bleeder control turns ON/OFF the bleeder resistor. When set to AUTO the bleeder resistor is automatically turned on when the output is turned on and turned off when the output or power is turned off. See page 32 for usage details.



**Caution**

When Bleeder Control is turned OFF or set to AUTO, the bleeder resistor is turned off when the power or output is turned off.

The AUTO setting is only applicable to firmware version 1.59 or above.

The following table shows how the state of the bleeder resistor depends on the Bleeder Control settings, the power state and the output state.

Bleeder Control Setting			
F-09	0 = OFF	1 = ON	2 = AUTO
Bleeder resistor State			
Output ON	OFF	ON	ON
Output OFF	OFF	ON	OFF
Power OFF	OFF	ON	OFF

F-09                      0 = OFF, 1 = ON, 2 = AUTO

**Buzzer ON/OFF\*** Turns the buzzer sound on or off. The buzzer is associated with alarm sounds and keypad entry sounds.

F-10                      0 = OFF, 1 = ON

**Measurement Average Setting** Determines the level of smoothing for the average setting.

Only available for firmware version 1.5 or above.

F-17                      0 = Low, 1 = Middle, 2 = High

**Lock Mode** Determines the behavior of the Output key when the panel lock is on.

Only available for firmware version 1.54 or above.

F-19                      0 = Panel lock: allow output off, 1 = Panel lock: allow output on/off

\*: Only configure from CH1

## USB/GPIB Settings\*

Front Panel USB State	Displays the front panel USB-A port state. This setting is not configurable.
	F-20                      0 = Absent, 1 = Mass Storage

Rear Panel USB State	Displays the rear panel USB-B port state. This setting is not configurable.
	F-21                      0 = Absent, 2 = USB-CDC, 3 = GPIB-USB adapter

Rear Panel USB Mode	Sets the rear panel USB mode.
---------------------	-------------------------------

Rear Panel USB Mode	Sets the rear panel USB mode.
	F-22                      0 = Disable, 1 = USB Host, 2 = Auto detect speed, 3 = Full speed only



Caution

Option #3, USB CDC Full Speed Only, can be used to reduce the data transmission speed when there are sources of interference in the operating environment. This option is only available for firmware version 1.42 and above.

GPIB Address	Sets the GPIB address.
	F-23                      0~30

\*: Only configure from CH1

## LAN Settings\*

MAC Address-1~6	Displays the MAC address 1~6. This setting is not configurable. F-30~F-35      0x00~0xFF
LAN	Turns Ethernet on or off. F-36      0 = Disable, 1 = Enable
DHCP	Turns DHCP on or off. F-37      0 = Disable, 1 = Enable
IP Address-1~4	Sets the default IP address. IP address 1~4 splits the IP address into four sections. (F-39 : F-40 : F-41 : F-42) (0~255 : 0~255 : 0~255 : 0~255)
Subnet Mask 1~4	Sets the subnet mask. The subnet mask is split into four parts. (F-43 : F-44 : F-45 : F-46) (0~255 : 0~255 : 0~255 : 0~255)
Gateway 1~4	Sets the gateway address. The gateway address is split into 4 parts. (F-47 : F-48 : F-49 : F-50) (0~255 : 0~255 : 0~255 : 0~255)
DNS Address 1~4	Sets the DNS address. The DNS address is split into 4 parts. (F-51 : F-52 : F-53 : F-54) (0~255 : 0~255 : 0~255 : 0~255)
Sockets active	Enables Web socket connections. F-57      0 = Disable, 1 = Enable
Web server active	Turns Web server control on/off. F-59      0 = Disable, 1 = Enable

Web Password active	Turns a web password on/off.
F-60	0 = Disable, 1 = Enable

---

Web Password	Sets the Web password.
F-61	0000 ~ 9999

\*: Only configure from CH1

## System Settings

---

Factory Set Value	Returns the PSW to the factory default settings. See page 143 for a list of the default settings.
F-88	0 = Disable, 1 = Return to factory default settings, 2* = All channels return to factory settings.

---

Displays the PSW version number, build date, keyboard version, analog-control version, kernel build, test command version and test command build date.

Show Version	<p style="margin-left: 40px;">0, 1 = PSW version                  2, 3 = PSW build year                  4, 5 = PSW build month/day                  6, 7 = Keyboard CPLD version                  8, 9 = Analog-Control CPLD version                  A = Control Board Version                  B = Reserved                  C, D = Kernel build year                  E, F = Kernel build month/day                  G, H = Test command version                  I, J = Test command build year                  K, L = Test command build month/day                  M, N = USB Driver version</p>
F-89	

---

\*: Only configure from CH1

## Power On Configuration Settings

---

CV Control	Sets the constant voltage (CV) control mode between local and external voltage/resistance control. For external voltage control, see page 103 (External Voltage Control of Voltage Output) and page 108 (External Resistance Control of Voltage Output).
F-90	0= Panel control (local) 1 = External voltage control 2 = External resistance control (Ext-R $\searrow$ 10k $\Omega$ = Vo,max) 3 = External resistance control (Ext-R $\triangle$ 10k $\Omega$ = 0)
CC Control	Sets the constant current (CC) control mode between local and external voltage/resistance control. For details on external voltage control, see page 106 (External Voltage Control of Current Output) and 110 (External Resistance Control of Current Output).
F-91	0= Panel control (local) 1 = External voltage control 2 = External resistance control (Ext-R $\searrow$ 10k $\Omega$ = Io,max) 3 = External resistance control (Ext-R $\triangle$ 10k $\Omega$ = 0)
Power-ON Output	Configures the power supply to do one of the following at startup: keep the output off, turn the output on, or load a test script.
F-92	0 = OFF at startup 1 = ON at startup T001 ~ T010 = Run test script TXX at start up

External Out Logic	Sets the external logic as active high or low. F-94                      0= High ON, 1 = Low ON
Power Switch Trip*	Turns the power off if enabled when the protection settings are tripped. F-95                      1 = Disable, 0 = Enable

\*: Only configure from CH1



Note

Power on configuration settings only can be set during power up. Enter configuration setting from CH1 and each channel can be used different settings. Under normal operation they only can be viewed.

## Multi-Channel Function Setting

Output Synchronize	Output synchronize setting. Each channel can be used different setting. F130                      0 = OFF, 1 = ON, 2* = All Channel ON, 3* = All channel OFF
Protection Trigger Synchronous	Protection Trigger Synchronous setting. Each channel can be used different setting. F131                      0 = OFF, 1 = ON, 2* = All Channel ON, 3* = All channel OFF
Key Lock/ Local Synchronize*	Lock/Local Synchronize setting. F132                      0 = OFF, 1 = ON

\*: Only configure from CH1



## Calibration

---

Programmable Calibration	The calibration password is used to access the local mode calibration or other special functions. The password used determines which function is accessed. Please see your distributor for details.
F-00	0000 ~ 9999

## Setting Normal Function Settings

---

Background	The normal function settings (F-01 ~ F-61, F88 ~ F89 and F130 ~ F132) can be easily configured with the Function key.
------------	---

- Ensure the load is not connected.
- Ensure the output is off.



Note

Function setting F-89 (Show Version) can only be viewed, not edited.

Configuration settings F-90~F-95 cannot be edited in the Normal Function Settings. Use the Power On Configuration Settings. See page 98 for details.

### Steps

1. Press the Function key. The function key will light up.

Function



2. The display will show F-01 on the top and the configuration setting for F-01 on the bottom.



3. Rotate the Voltage knob to change the F setting.

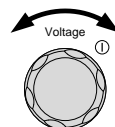

Range F-00 ~ F-61, F-88 ~ F-89  
and F130 ~ F132

- Use the Current knob to set the parameter for the chosen F setting.

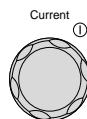

- Press the Voltage knob to save the configuration setting. ConF will be displayed when successful.

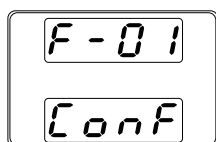
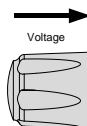

Exit

Press the Function key again to exit the configuration settings. The function key light will turn off.



## Setting Power On Configuration Settings

Background

The Power On configuration settings can only be changed during power up to prevent the configuration settings being inadvertently changed.

- Ensure the load is not connected.
- Ensure the power supply is off.

Steps

- Hold the Function key of CH1 whilst turning the power on.
- The display of all channel will show F-90 on the top and the configuration setting for F-90 on the bottom.

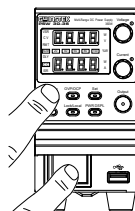

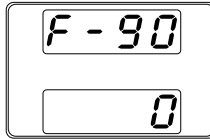

3. Rotate the voltage knob to change the F setting on each channel.

F-90~ F-95

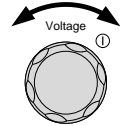

4. Use the Current knob to set the parameter for the chosen F setting.

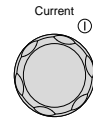

5. Press the Voltage knob to save the configuration setting. Conf will be displayed when successful.

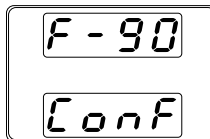
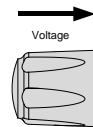

Exit

Cycle the power to save and exit the configuration settings.

# A ANALOG CONTROL

The Analog Control chapter describes how to control the voltage or current output using an external voltage or resistance, monitor the voltage or current output as well as remotely turning off the output or shutting down the power supply.

---

<b>Analog Remote Control Overview .....</b>	<b>101</b>
Analog Control Connector Overview .....	101
External Voltage Control of Voltage Output.....	103
External Voltage Control of Current Output.....	106
External Resistance Control of Voltage Output.....	108
External Resistance Control of Current Output.....	110
External Control of Output.....	112
External control of Shutdown.....	115
<b>Remote Monitoring.....</b>	<b>117</b>
External Voltage and Current Monitoring.....	117
External Operation and Status Monitoring .....	119

## Analog Remote Control Overview

The PSW power supply series have a number of analog control options. The Analog Control connectors are used to control output voltage and current using external voltage or resistance. The power supply output and power switch can also be controlled using external switches.

- Analog Control connector overview → from page 101
- External voltage control of voltage output → from page 103
- External voltage control of current output → from page 106
- External resistance control of voltage output → from page 108
- External resistance control of current output → from page 110
- External control of output → from page 112
- External control of the power switch → from page 115

## Analog Control Connector Overview

Overview	The Analog Control Connector is a standard Mil 26 pin connector (OMRON XG4 IDC plug). The connector is used for all analog remote control. The pins used determine what remote control mode is used.
----------	--



**WARNING**

To prevent electric shock, ensure that the cover for the Analog Control Connector is used when the connector is not in use.

Pin Assignment

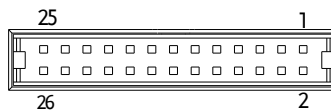

Pin name	Pin number	Description
Current Share	1	No supported on PSW-Multi series.
D COM	2	Connected to the (-S) sense- terminal when remote sense is used. Connected to the negative output terminal when remote sense is not used.
CURRENT SUM OUT	3	No supported on PSW-Multi series.
EXT-V CV CONT	4	External voltage control of the voltage output. A voltage of 0~10V is used to control the full scale voltage output (0%~100%) of the instrument.
EXT-V CC CONT	5	External voltage control of the current output. A voltage of 0~10V is used to control the full scale current output (0%~100%) of the instrument
EXT-R CV CONT PIN1	6	External resistance control of the voltage output. A resistance of 0k $\Omega$ ~ 10k $\Omega$ is used to control the full scale voltage output (0%~100%) of the instrument.
EXT-R CV CONT PIN2	7	External resistance control of the voltage output. A resistance of 0k $\Omega$ ~ 10k $\Omega$ is used to control the full scale voltage output (0%~100%) of the instrument.
EXT-R CC CONT PIN1	8	External resistance control of the current output. A resistance of 0k $\Omega$ ~ 10k $\Omega$ is used to control the full scale current output (0%~100%) of the instrument.
EXT-R CC CONT PIN2	9	External resistance control of the current output. A resistance of 0k $\Omega$ ~ 10k $\Omega$ is used to control the full scale current output (0%~100%) of the instrument.
V MON	10	Voltage Monitor Output. Outputs the full scale voltage (0~100%) as a voltage (0V~10V).
I MON	11	Current Monitor Output. Outputs the full scale current (0~100%) as a voltage (0V~10V).
SHUTDOWN	12	The shut down signal will turn off the output or power when a low TTL signal is applied. The shutdown signal is pulled up to 5V with a 10k $\Omega$ pull-up resistor.
CURRENT_SUM_1	13	No supported on PSW-Multi series.
CURRENT_SUM_2	14	No supported on PSW-Multi series.
FEEDBACK	15	No supported on PSW-Multi series.

A COM	16	Analog signal common. Connected to the sense-terminal when remote sense is used. Connected to the negative output terminal when remote sense is not used.
STATUS COM	17	Common for status signals 18, 19, 20, 21 and 22.
CV STATUS	18	Turns on when CV mode is active. (photo coupled open collector output)
CC STATUS	19	Turns on when CC mode is active. (photo coupled open collector output)
ALM STATUS	20	Turns on when any of the protection modes are tripped (OVP, OCP) or if a shutdown signal is input. (photo coupled open collector output)
OUTPUT ON STATUS	21	Turns on when the output has been turned on. (photo coupled open collector output)
POWER OFF STATUS	22	Turns on when the power switch is turned off.
N.C.	23	Not connected
OUT ON/OFF CONT	24	Turns the output on/off when (default setting) a low TTL signal is applied. Internally, the circuit is pulled up to +5V with 10k $\Omega$ resistance.
SER SLV IN	25	No supported on PSW-Multi series.
N.C.	26	Not connected

## External Voltage Control of Voltage Output

**Background** External voltage control of the voltage output is accomplished using the MIL-26 connector on the rear panel. A voltage of 0~10V is used to control the full scale voltage of the instrument, where:

$$\text{Output voltage} = \text{full scale voltage} \times (\text{external voltage}/10)$$

**Connection** When connecting the external voltage source to the MIL connectors, use shielded or twisted paired wiring.

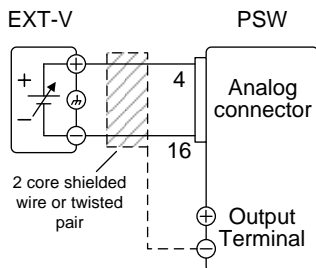

- Pin16 → EXT-V (-)
- Pin4 → EXT-V (+)
- Wire shield → negative (-) output terminal

**Connection- alt. shielding** If the wire shield needs to be grounded at the voltage source (EXT-V), then the shield cannot also be grounded at the negative (-) terminal output of the PSW power supply. This would short the output.

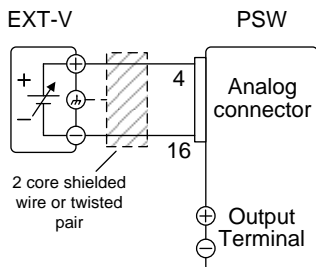

- Pin16 → EXT-V(-)
- Pin4 → EXT-V(+)
- Wire shield → EXT-V ground (GND)

**Panel operation** 1. Connect the external voltage according to the connection diagrams above.



2. Set the F-90 power on configuration setting to 1 (CV control - Ext voltage). Page 98
- Be sure to cycle the power after the power on configuration has been set.
3. Press the Function key and confirm the new configuration settings (F-90=1). Function
4. Press the Output key. The voltage can now be controlled with the External voltage. Output



Note

The input impedance for external voltage control is 10k $\Omega$ .

Use a stable voltage supply for the external voltage control.



Note

CV and CC Slew Rate Priority are disabled for V-I mode (F-03) when using external voltage control. See the normal function settings on page 87.



CAUTION

Ensure no more than 10.5 volts are input into the external voltage input.

Ensure the voltage polarity is correct when connecting the external voltage.

## External Voltage Control of Current Output

**Background** External voltage control of the current output is accomplished using the MIL-26 connector on the rear panel. A voltage of 0~10V is used to control the full scale current of the instrument, where:

$$\text{Output current} = \text{full scale current} \times (\text{external voltage}/10)$$

**Connection** When connecting the external voltage source to the MIL connectors, use shielded or twisted paired wiring.

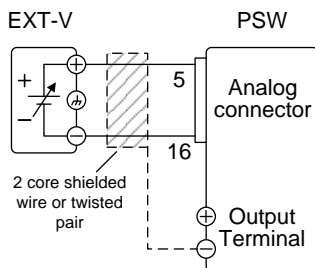

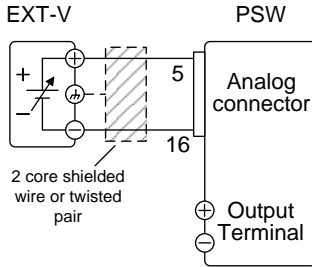

- Pin16 → EXT-V (-)
- Pin5 → EXT-V (+)
- Wire shield → negative (-) output terminal

Connection- alt. shielding If the wire shield needs to be grounded at the voltage source (EXT-V), then the shield cannot also be grounded at the negative (-) terminal output of the PSW power supply. This would short the output.



- Pin16 → EXT-V (-)
- Pin5 → EXT-V (+)
- Wire shield → EXT-V ground (GND)

- Steps
1. Connect the external voltage according to the connection diagrams above.
  2. Set the F-91 power on configuration setting to 1 (CC control - Ext voltage). Page 98
    - Be sure to cycle the power after the power on configuration has been set.
  3. Press the Function key and confirm the new configuration settings (F-91=1). Function

  4. Press the Output key. The current can now be controlled with the External voltage. Output



Note

The input impedance for external voltage control is 10k $\Omega$ .

Use a stable voltage supply for the external voltage control.

---



Note

CV and CC Slew Rate Priority are disabled for V-I mode (F-03) when using external voltage control. See the normal function settings on page 87.

---



CAUTION

Ensure the voltage polarity is correct when connecting the external voltage.

Ensure no more than 10.5 volts are input into the external voltage input.

## External Resistance Control of Voltage Output

---

### Background

External resistance control of the voltage output is accomplished using the MIL-26 connector on the rear panel. A resistance of 0k $\Omega$ ~10k $\Omega$  is used to control the full scale voltage of the instrument.

The output voltage (0 to full scale) can be controlled with the external resistance going up (Ext-R  $\swarrow$ ) 0k $\Omega$ ~10k $\Omega$ (10k $\Omega$  =  $V_{o,max}$ ) or down (Ext-R  $\searrow$ ) 10k $\Omega$ ~0k $\Omega$ (10k $\Omega$  = 0).

For 0k $\Omega$ ~10k $\Omega$ : Output voltage = full scale voltage  $\times$  (external resistance/10)

For 10k $\Omega$ ~0k $\Omega$ : Output voltage = full scale voltage  $\times$  ([10-external resistance]/10)

---



Note

The Ext-R $\nabla$  configuration is recommended for safety reasons. In the event that the cables become accidentally disconnected, the voltage output will drop to zero. Under similar circumstances using Ext-R $\sphericalangle$ , an unexpected high voltage would be output.

If switches are used to switch between fixed resistances, use switches that avoid creating open circuits. Use short-circuit or continuous resistance switches.

Connection

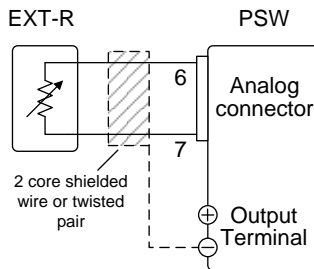

- Pin6 → EXT-R
- Pin7 → EXT-R
- Wire shield → negative (-) output terminal

Steps

1. Connect the external resistance according to the connection diagrams above.
2. Set the F-90 (CV Control) Page 98 configuration settings to 2 for Ext-R $\sphericalangle$  or 3 for Ext-R $\nabla$ .
  - Be sure to cycle the power after the power on configuration has been set.
3. Press the Function key and confirm the new configuration settings (F-90=2 or 3).

Function



4. Press the Output key. The voltage can now be controlled with the External resistance.

Output

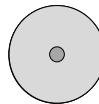

Note

Ensure the resistor(s) and cables used exceed the isolation voltage of the power supply. For example: insulation tubes with a withstand voltage higher than the power supply can be used.

When choosing an external resistor ensure the resistor can withstand a high degree of heat.



Note

CV and CC Slew Rate Priority are disabled for V-I mode (F-03) when using external resistance control. See the normal function settings on page 87.

## External Resistance Control of Current Output

### Background

External resistance control of the current output is accomplished using the MIL-26 connector on the rear panel. A resistance of  $0\text{k}\Omega\sim 10\text{k}\Omega$  is used to control the full scale current of the instrument.

The output current (0 to full scale) can be controlled with the external resistance going up (Ext-R  $\swarrow$ )  $0\text{k}\Omega\sim 10\text{k}\Omega$  ( $10\text{k}\Omega = V_{o,max}$ ) or down (Ext-R  $\searrow$ )  $10\text{k}\Omega\sim 0\text{k}\Omega$  ( $10\text{k}\Omega = 0$ ).

For  $0\text{k}\Omega\sim 10\text{k}\Omega$ : Output current = full scale current  $\times$  (external resistance/10)

For  $10\text{k}\Omega\sim 0\text{k}\Omega$ : Output current = full scale current  $\times$  ([10-external resistance]/10)



Note

The Ext-R $\nabla$  configuration is recommended for safety reasons. In the event that the cables become accidentally disconnected, the current output will drop to zero. Under similar circumstances using Ext-R $\sphericalangle$ , an unexpected high current would be output.

If switches are used to switch between fixed resistances, use switches that avoid creating open circuits. Use short-circuit or continuous resistance switches.

Connection

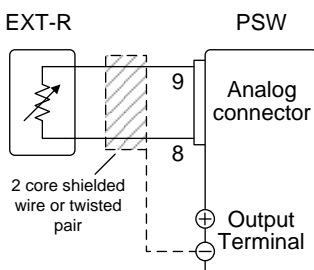

- Pin9 → EXT-R
- Pin8 → EXT-R
- Wire shield → negative (-) output terminal

Steps

1. Connect the external resistance according to the connection diagrams above.

1. Set the F-91 (CC Control) Page 98  
configuration settings to 2 for Ext-R $\sphericalangle$  or 3 for Ext-R $\nabla$ .

- Be sure to cycle the power after the power on configuration has been set.

2. Press the Function key and confirm the new configuration settings (F-91=2 or 3).

Function



3. Press the Output key. The current can now be controlled with the External resistance.

Output

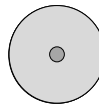

Ensure the resistor(s) and cables used exceed the isolation voltage of the power supply. For example: insulation tubes with a withstand voltage higher than the power supply can be used.

When choosing an external resistor ensure the resistor can withstand a high degree of heat.



CV and CC Slew Rate Priority are disabled for V-I mode (F-03) when using external resistance control. See the normal function settings on page 87.

## External Control of Output

### Background

The output can be turned on or off externally using a switch. The analog control connector can be set to turn the output on from a high or low signal. The voltage across pins 2 and 24 are internally pulled to +5V  $\pm 5\%$  @ 500uA with 10k $\Omega$  pull-up resistor. A short (closed switch) produces a low signal.

When set to High = On, the output is turned on when the pins 2-24 are open.

When Low = On, the output is turned on when pins 2-24 are shorted.



Connection

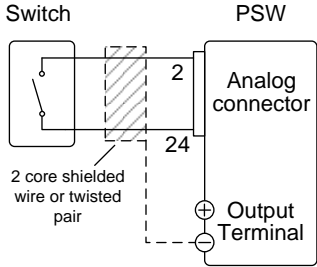

- Pin2 → Switch
- Pin24 → Switch
- Wire shield → negative (-) output terminal

Steps

1. Connect the external switch according to the connection diagrams above.

Set F-94 (External output logic) in Page 98 the power on configuration settings to 0 (High = On) or 1 (Low = On).

- Be sure to cycle the power after setting the power on configuration settings.

2. Press the Function key and confirm the new configuration settings.

Function



3. The switch is now ready to set the output on or off.



Note

When using a switch over long distances, please use a switch relay to extend the line from the coil side of the relay.

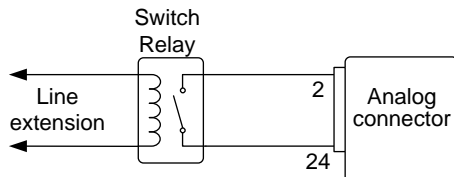

If a single switch control is to be used for Multiple units, please isolate each instrument. This can be achieved by using a relay.



Warning

Ensure the cables used and the switch exceed the isolation voltage of the power supply. For example: insulation tubes with a withstand voltage higher than the power supply can be used.



Note

Messages: If F-94 = 0 (High = on) and the pin 24 is low (0) “MSG 001” will be displayed on the display.

If F-94 = 1 (Low = on) and the pin 24 is high (1) “MSG 002” will be displayed on the display.

Output off (High=on)

Output off (Low=on)

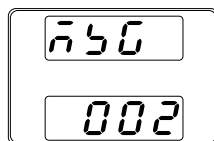
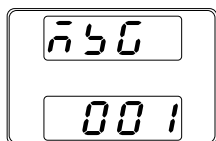

## External control of Shutdown

**Background**      The output of the power supplies can be configured to shut down via an external switch. The ability to externally shut down the power supply must first be enabled in the power on configuration settings. The voltage across pins 2 and 12 are internally pulled to +5V  $\pm$ 5% @ 500uA with 10k $\Omega$  pull-up resistor.

**Connection**

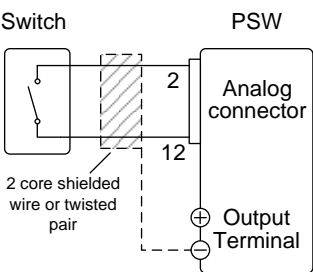

- Pin2 → Switch
- Pin12 → Switch
- Wire shield → negative (-) output terminal

- Steps**
1. Connect the external switches according to the connection diagrams above.
  2. Set F-95 to in the configuration settings to 0 (Enable). This will allow the external control of shutdown. Page 98
  3. Press the function key and confirm the new configuration settings. Function 
  4. The switch will now shut down the power supply when shorted.



Note

When using a switch over long distances, please use a switch relay to extend the line from the coil side of the relay.

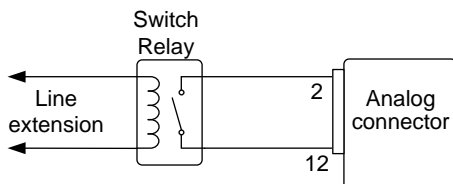

If a single switch control is to be used for Multiple units, please isolate each instrument. This can be achieved by using a relay.



Warning

Ensure the cables and switch used exceed the isolation voltage of the power supply. For example: insulation tubes with a withstand voltage higher than the power supply can be used.

## Remote Monitoring

The PSW power supplies have remote monitoring support for current and voltage output. They also support monitoring of operation and alarm status.

- External monitoring of output voltage and current → from page 117
- External monitoring of operation mode and alarm status → from page 119

### External Voltage and Current Monitoring

#### Background

The MIL 26 pin connector is used to monitor the current (IMON) or voltage (VMON) output.

An output of 0~10V represents the voltage or current output of 0~ rated current/voltage output.

- $IMON = (\text{current output}/\text{full scale}) \times 10$
- $VMON = (\text{voltage output}/\text{full scale}) \times 10$

External voltage and current monitoring doesn't need to be enabled in the configuration settings.

#### VMON Connection

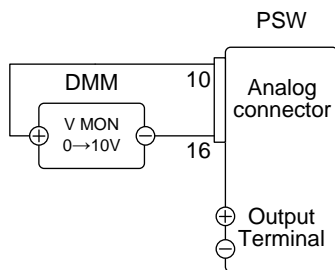

- Pin16 → Neg (-)
- Pin10 → Pos (+)

**IMON  
Connection**

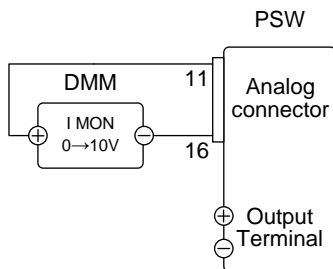

- Pin16 → Neg (-)
- Pin11 → Pos (+)



**Note**

The output impedance of the voltage (VMON) and current (IMON) monitor pins is 1kΩ.

Maximum current is 10mA.

The monitor outputs are strictly DC and should not be used to monitor analog components such as transient voltage response or ripple etc.



**CAUTION**

Ensure IMON(pin 11) and VMON(pin 10) are not shorted together. This will cause damage to the unit.

## External Operation and Status Monitoring

**Background** The MIL 26 pin connector can also be used to monitor the status operation and alarm status of the instrument.

The pins are isolated from the power supply internal circuitry by photo couplers. Status Com (Pin 17) is a photo coupler emitter output, whilst pins 18~22 are photo coupler collector outputs.

A maximum of 30V and 8mA can be applied to each pin.

Name and Pin	Description
STATUS COM 17	Common (photo coupler emitter) for status signals 18, 19, 20, 21 and 22.
CV STATUS 18	Low when CV mode is active.
CC STATUS 19	Low when CC mode is active.
ALM STATUS 20	Low when any of the protection modes are tripped (OVP, OCP). Active low.
OUT ON STATUS 21	Low when the output is on.
PWR OFF STATUS 22	Active low.

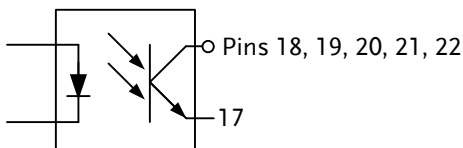

**Timing diagrams** Below are 4 example timing diagrams covering a number of scenarios. Note that pins 18~22 are all active low.

**CV MODE:** The diagram below shows the timing diagram  
 Output turned on when the output is turned on when the PSW is set to CV mode.

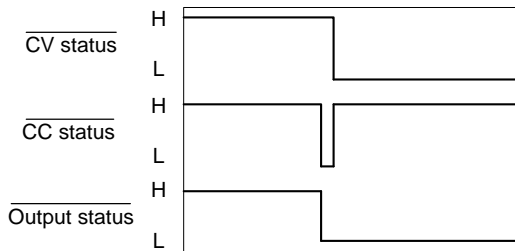

**CV MODE:** The diagram below shows the output status lines  
 Output turned off when the output is turned off in CV mode.

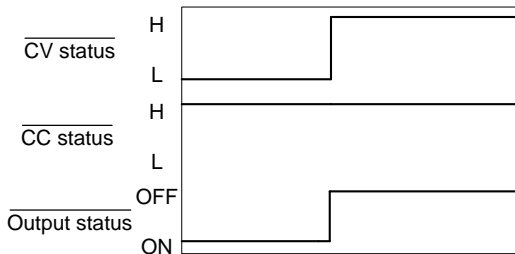

**CC MODE:** The diagram below shows the timing diagram  
 Output turned on when the output is turned on when the PSW is set to CC mode.

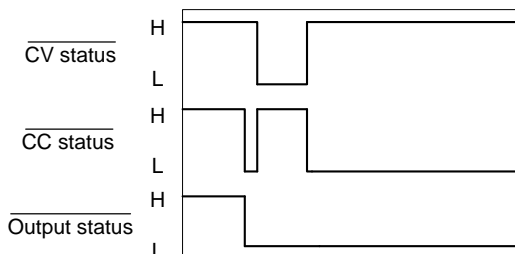



CC MODE: The diagram below shows the output status lines  
Output turned off when the output is turned off in CC mode.

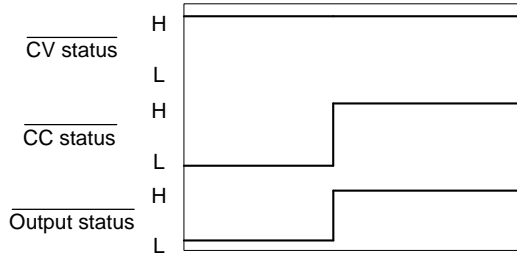

# C

# COMMUNICATION

## INTERFACE

This chapter describes basic configuration of IEEE488.2 based remote control. For a command list, refer to the programming manual, downloadable from GW Instek website, [www.gwinstek.com](http://www.gwinstek.com)

---

Interface Configuration .....	123
Configure USB Remote Interface .....	123
Configure GPIB Interface .....	123
Configure Ethernet Connection.....	125
Web Server Configuration.....	125
Sockets Server Configuration.....	126
USB Remote Control Function Check .....	127
Using Realterm to Establish a Remote Connection.....	128
GPIB Remote Control Function Check .....	130
Web Server Remote Control Function Check .....	133
Socket Server Function Check .....	133

## Interface Configuration

### Configure USB Remote Interface

USB configuration	PC side connector	Type A, host
	PSW side connector	Rear panel Type B, slave
	Speed	1.1/2.0 (full speed/high speed)
	USB Class	CDC (communications device class)

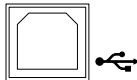
- Panel operation
1. Connect the USB cable to the rear panel USB B port. 
  2. Press the Function key to enter the Normal configuration settings.
- Set the following USB settings:
- F-22 = 2                      Set the rear panel USB port to USB-CDC.

### Configure GPIB Interface

Background                      To use GPIB, the optional GPIB to USB (GUG-001) adapter must be used. The GPIB to USB adapter must be connected before the PSW is turned on. Only one GPIB address can be used at a time.

- Configure GPIB
1. Ensure the PSW is off before proceeding.
  2. Connect the USB cable from the rear panel USB B port on the PSW to the USB A port on the GPIB to USB adapter.

3. Connect a GPIB cable from a GPIB controller to the GPIB port on the adapter.

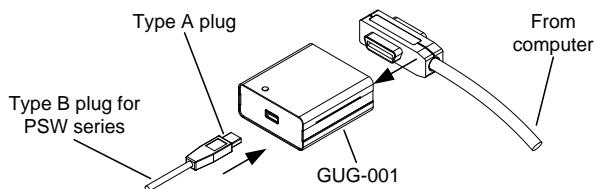

4. Turn the PSW on.
5. Press the Function key to enter the Normal configuration settings.

Set the following GPIB settings:

F-22 = 1 Set the real panel USB port to USB Host.

F-23 = 0~30 Set the GPIB address (0~30)

- GPIB constraints
- Maximum 15 devices altogether, 20m cable length, 2m between each device
  - Unique address assigned to each device
  - At least 2/3 of the devices turned On
  - No loop or parallel connection

## Configure Ethernet Connection

The Ethernet interface can be configured for a number of different applications. Ethernet can be configured for basic remote control or monitoring using a web server or it can be configured as a socket server.

The PSW Series supports both DHCP connections so the instrument can be automatically connected to an existing network or alternatively, network settings can be manually configured.

Ethernet configuration Parameters	MAC Address (display only)	LAN
	DHCP	IP Address
	Subnet Mask	Gateway
	DNS Address	Sockets Active
	Web Server Active	Web Password Active
	Web set password	0000~9999 (default 0000)

## Web Server Configuration

**Configuration** This configuration example will configure the PSW as a web server and use DHCP to automatically assign an IP address to the PSW.

1. Connect an Ethernet cable from the network to the rear panel Ethernet port.
2. Press the Function key to enter the Normal configuration settings.

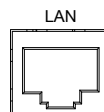

Set the following LAN settings:

- F-36 = 1            Enable LAN
- F-37 = 1            Turn DHCP to enable
- F-59 = 1            Turn the web server on



Note

It may be necessary to cycle the power or refresh the web browser to connect to a network.

## Sockets Server Configuration

---

**Configuration** This configuration example will configure the PSW sockets server.

The following configuration settings will manually assign the PSW an IP address and enable the socket server. By default, the socket server port number is 2268 and cannot be configured.

1. Connect an Ethernet cable from the network to the rear panel Ethernet port.



2. Press the Function key to enter the Normal configuration settings.
3. Set the following LAN settings:

F-36 = 1	Enable LAN
F-37 = 0	Disable DHCP
F-39 = 172	IP Address part 1 of 4
F-40 = 16	IP Address part 2 of 4
F-41 = 5	IP Address part 3 of 4
F-42 = 133	IP Address part 4 of 4
F-43 = 255	Subnet Mask part 1 of 4
F-44 = 255	Subnet Mask part 2 of 4
F-45 = 128	Subnet Mask part 3 of 4
F-46 = 0	Subnet Mask part 4 of 4
F-43 = 172	Gateway part 1 of 4
F-44 = 16	Gateway part 2 of 4
F-45 = 21	Gateway part 3 of 4
F-46 = 101	Gateway part 4 of 4
F-57 = 1	Enable Sockets



Note

The socket function is supported only in PSW firmware version V1.12 or later. However, the socket function is supported in all firmware versions of PSW-Multi.

## USB Remote Control Function Check

---

Functionality  
check

Invoke a terminal application such as Reialterm. The PSW will appear as a COM port on the PC.

To check the COM port No, see the Device Manager in the PC. For WinXP; Control panel → System → Hardware tab.



Note

If you are not familiar with using a terminal application to send/receive remote commands via a USB connection, please page 128 for more information.

Run this query command via the terminal after the instrument has been configured for USB remote control.

```
*idn?
```

This should return the Manufacturer, Model number, Serial number, and Firmware version in the following format.

```
GW-INSTEK, PSW30-36,TW123456,01.00.20110101
```

```
Manufacturer: GW-INSTEK
```

```
Model number : PSW30-36
```

```
Serial number : TW123456
```

```
Firmware version : 01.00.20110101
```



Note

For further details, please see the programming manual, available on the GW Instek web site @ [www.gwinstek.com](http://www.gwinstek.com).

## Using Realterm to Establish a Remote Connection

---

**Background** Realterm is a terminal program that can be used to communicate with a device attached to the serial port of a PC or via an emulated serial port via USB.

The following instructions apply to version 2.0.0.70. Even though Realterm is used as an example to establish a remote connection, any terminal program can be used that has similar functionality.



Note

Realterm can be downloaded on Sourceforge.net free of charge.

For more information please see <http://realterm.sourceforge.net/>

---

- Operation**
1. Download Realterm and install according to the instructions on the Realterm website.
  2. Connect the PSW via USB.
  3. Go to the Windows device manager and find the COM port number for the connection. For example, go to the Start menu > Control Panel > Device Manager

Double click the *Ports* icon to reveal the connected serial port devices and the COM port for the each connected device.

The baud rate, stop bit and parity settings can be viewed for the virtual COM port by right-clicking connected device and selecting the *Properties* option.



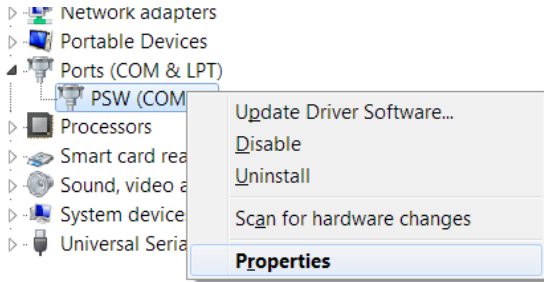

4. Start Realterm on the PC as an administrator.  
Click:  
Start menu>All Programs>RealTerm>realterm

Tip: to run as an administrator, you can right click the Realterm icon in the Windows Start menu and select the *Run as Administrator* option.

5. After Realterm has started, click on the *Port* tab.

Enter the *Baud*, *Parity*, *Data bits*, *Stop bits* and *Port* number configuration for the connection.

The *Hardware Flow Control*, *Software Flow Control* options can be left at the default settings.

Press *Open* to connect to the PSW.

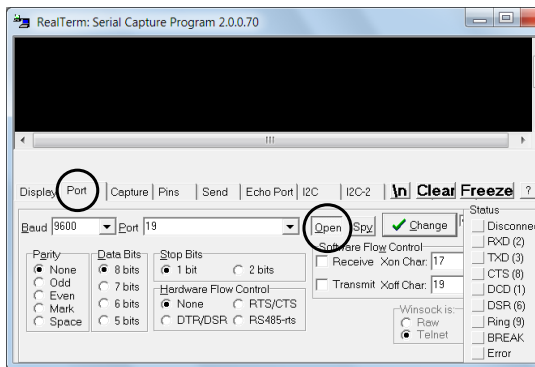

- Click on the *Send* tab.

In the *EOL* configuration, check on the +*CR* and +*LF* check boxes.

Enter the query:

*\*idn?*

Click on *Send ASCII*.

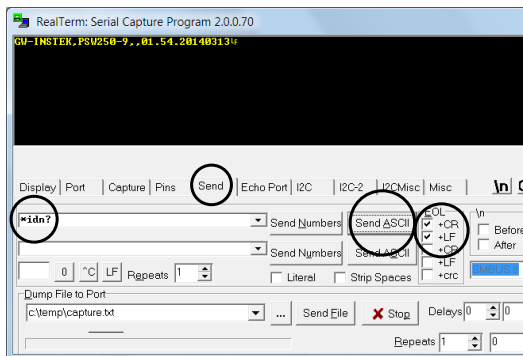

- The terminal display will return the following:  
*GW-INSTEK,PSW250-9,,01.54.20140313*  
 (manufacturer, model, serial number, version)
- If Realterm fails to connect to the PSW, please check all the cables and settings and try again.

## GPIB Remote Control Function Check

### Background

To check if the GPIB connection is functioning properly, you can use the National Instruments Measurement and Automation Explorer (NI MAX). NI MAX needs to be obtained by installing NI-VISA.

You can download NI-VISA from the NI website [www.ni.com](http://www.ni.com). Please search for “NI-VISA download” on the NI website to obtain it.

Once NI-VISA is installed, please download NI-488.2 and complete the installation. NI-488.2 can be downloaded from the NI website [www.ni.com](http://www.ni.com). Please search for “NI-488.2 download” on the NI website to obtain it.

The following function check is based on version 2022 Q3.



Warning

NI-VISA is a product of NI, when you want to use NI-VISA, please abide by the NI license terms.

Steps

1. Complete the setup procedure described previously.
2. Start the Measurement and Automation Explorer (MAX) program. Using Windows, press;

**Start>All Programs>National Instruments>NI MAX**

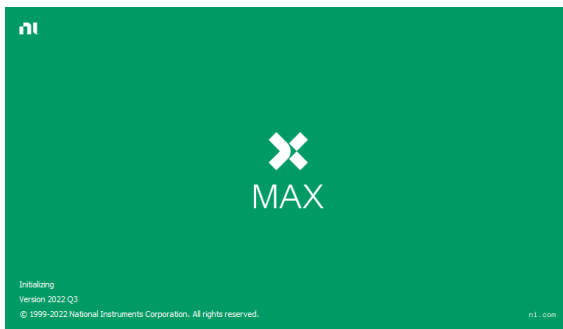

The Measurement & Automation Explorer initial splash screen.

3. From the **Configuration** panel access;  
**My System>Devices and Interfaces>GPIB0(GPIB-USB-HS+)**
4. Press the **Scan for Instruments** button.

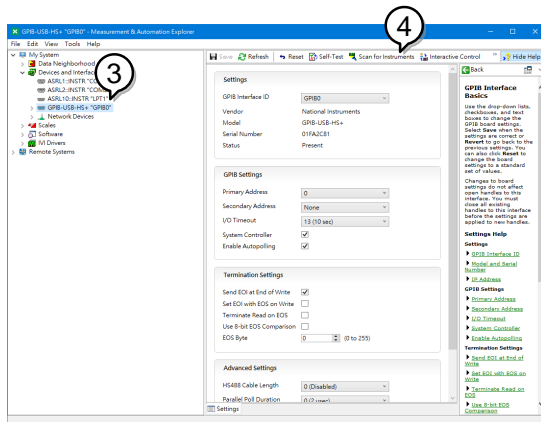

5. Click on **Communicate with Instrument**.
6. In the **NI-488.2 Communicator** window, ensure *\*IDN?* is written in the **Send String:** text box. Click on the **Query** button to send the *\*IDN?* query to the oscilloscope.
7. The **String Received** text box will display the query return:

*GW-INSTEK,PSW250-9,,01.54.20140313\n*  
 (manufacturer, model, serial number, version)

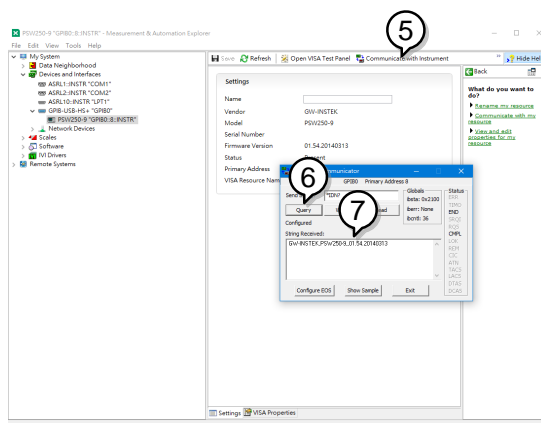

8. The function check is complete.

## Web Server Remote Control Function Check

---

**Functionality check** Enter the IP address of the power supply in a web browser after the instrument has been configured as a web server (page 125).

`http:// XXX.XXX.XXX.XXX`

The web browser interface appears.

---



Note

For further details, please see the programming manual, available on the GW Instek web site @ [www.gwinstek.com](http://www.gwinstek.com).

## Socket Server Function Check

---

**Background** To check if the socket server connection is functioning properly, you can use the National Instruments Measurement and Automation Explorer (NI MAX). NI MAX needs to be obtained by installing NI-VISA.

You can download NI-VISA from the NI website [www.ni.com](http://www.ni.com). Please search for “NI-VISA download” on the NI website to obtain it.

The following function check is based on version 2022 Q3.

---



Warning

NI-VISA is a product of NI, when you want to use NI-VISA, please abide by the NI license terms.

---

**Functionality check** 1. Start the NI Measurement and Automation Explorer (MAX) program. Using Windows, press:

*Start>All Programs>National Instruments>Measurement & Automation*

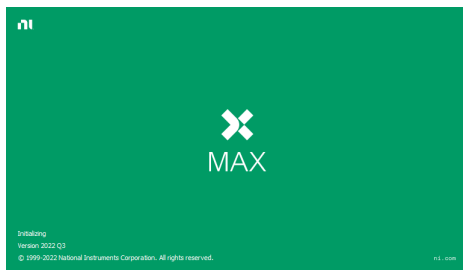

2. From the Configuration panel access;  
*My System>Devices and Interfaces>Network Devices*
3. Click *Create New...*
4. Select *Visa TCP/IP Resource*.

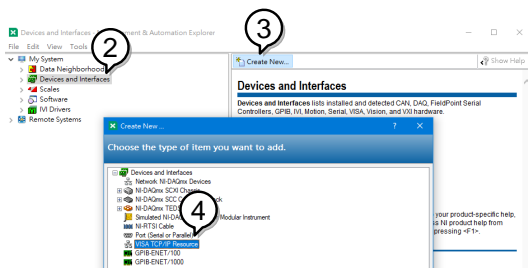

5. Select *Manual Entry of Raw Socket* from the popup window.
6. Click *Next*.

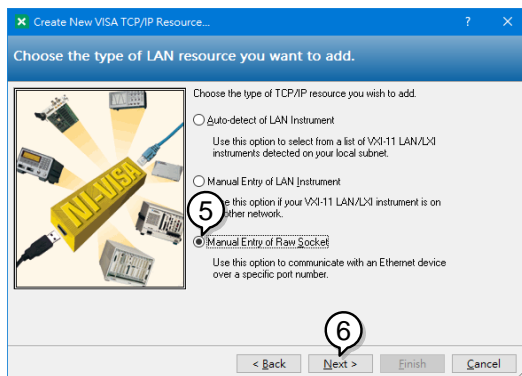

7. Enter the IP address and the port number of the PSW. The port number is fixed at 2268.
8. Click the Validate button. A popup box will appear when successful.
9. Click *Next*.

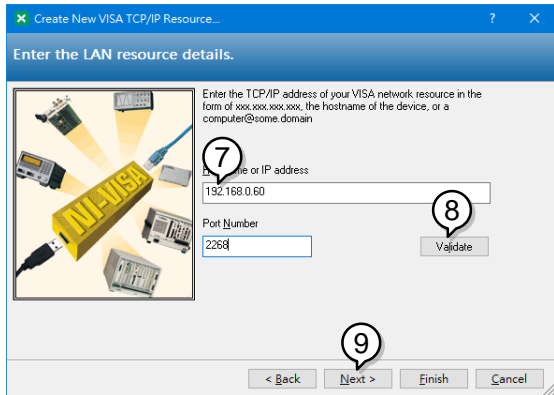

10. Next configure the Alias (name) of the PSW connection. In this example the Alias is: PSW\_DC1

11. Click finish.

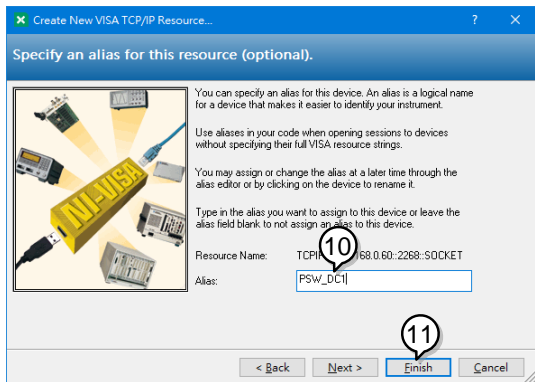

12. The IP address of the PSW will now appear under Network Devices in the configuration panel. Select this icon now.

13. Press *Open VISA Test Panel*.

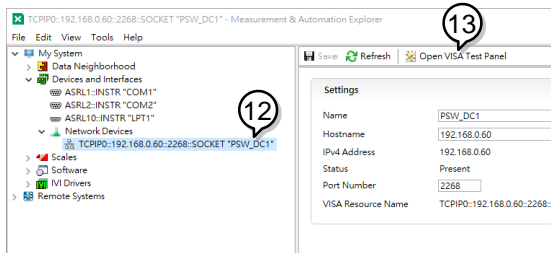

14. Click *Configuration* icon.

15. In the *I/O Settings* tab, select the *Enable Termination Character* check box. Ensure *Line Feed - \n* is selected as the line feed character.

16. Click *Apply Changes*.

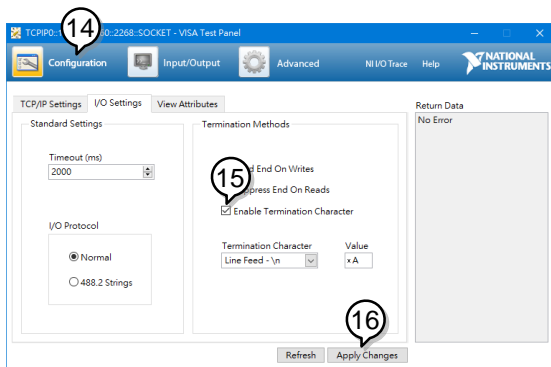

17. Click the *Input/Output* icon.

18. Ensure *\*IDN? \n* is selected in the *Select or Enter Command* dropdown text box.

19. Click the *Query* button.

20. The *\*IDN?* query should be returned to the buffer area:  
*GW-INSTEK,PSW250-9,,01.54.20140313 \n*



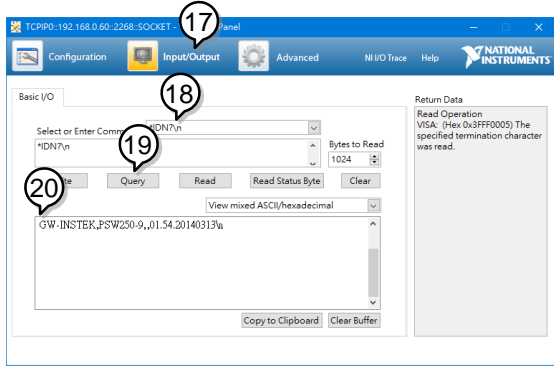

For further details, please see the programming manual, available on the GW Instek web site @ [www.gwinstek.com](http://www.gwinstek.com).

# M AINTENANCE

The PSW power supply filters should be replaced on a periodic schedule to maintain performance and specification characteristics.

---

Replacing the Dust Filter .....	139
---------------------------------	-----

## Replacing the Dust Filter

The dust filter should be replaced at least 2 times a year. Not replacing the filter on a regular basis will reduce performance and may cause the unit to overheat.

---

Front panel filter (all models)

1. Turn the instrument off.
2. Pull the filter out from the bottom of the front panel.

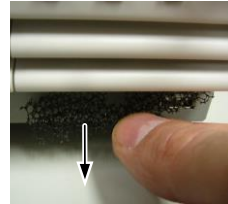

3. Replace the filter with GW Instek part number 57RG-30B03801.

# FAQ

---

- The power supply won't let me change the mode (C.V. mode ↔ C.C. mode).
- The OVP voltage is triggered earlier than expected.
- Can I combine more than 1 cable together for the output wiring?
- The accuracy does not match the specification.

The power supply won't let me change the mode (C.V. mode ↔ C.C. mode).

---

To set the power supply to CC or CV mode, the Function key must be held when the power is turned on to enter the Power On Configuration Mode. See page 98.

The OVP voltage is triggered earlier than expected.

---

When setting the OVP voltage, take into account the voltage drop from the load cables. As the OVP level is set from the output terminals and not the load terminals, the voltage at the load terminals may be slightly lower.

Can I combine more than 1 cable together for the output wiring?

---

Yes. Cables can be used together (in parallel) if the current capacity of a single cable is insufficient. However the withstand voltage should also be taken into account. Ensure the cables are twisted together and are the same length.

The accuracy does not match the specification.

---

Make sure the device is powered On for at least 30 minutes, within +20°C~+30°C. This is necessary to stabilize the unit to match the specification.

For more information, contact your local dealer or GWInstek at [www.gwinstek.com](http://www.gwinstek.com) / [marketing@goodwill.com.tw](mailto:marketing@goodwill.com.tw).

# APPENDIX

PSW-Multi Web Control Description .....	143
Tab <b>Welcome Page</b> .....	143
Tab <b>Network Configuration</b> .....	144
Tab <b>SCPI command</b> .....	144
Tab <b>Web control</b> .....	144
Tab <b>Data log</b> .....	149
Tab <b>Edit Sequence</b> .....	150
Tab <b>Visit Our Site</b> .....	152
PSW-Multi Default Settings .....	153
Error Messages & Messages .....	155
LED Display Format .....	155
Specifications .....	156
PSW 30-36, PSW 40-27, PSW 80-13.5, PSW 160-7.2, PSW 250-4.5, PSW 800-1.44 .....	156
PSW-720 .....	159
PSW-1080 .....	160
PSW-Multi Dimensions .....	162
PSW-720 .....	162
PSW 250-4.5/ PSW 800-1.44 (scale: mm) .....	162
PSW 160-7.2/ PSW 80-13.5/ PSW 40-27/ PSW 30-36 (scale: mm) .....	163
PSW-1080 .....	164
PSW 250-9/ PSW 800-2.88 (scale: mm) .....	164
PSW 160-14.4/ PSW 80-27/ PSW 40-54/ PSW 30-72 (scale: mm) .....	165
Certificate Of Compliance .....	166

## PSW-Multi Web Control Description

Open the web browser and input the IP address of PSW-Multi and then push “Enter key” to move over to Web Control server.

There are seven tabs on the top of the Web Control Page. Select the tab you desire on the top of the Web control page by clicking the mouse so that you can control the PSW-Multi or get more information about it.

### Tab Welcome Page

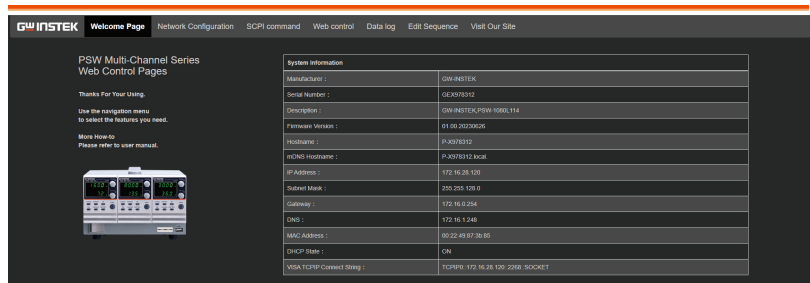

System Information	
Manufacturer :	GW INSTEK
Serial Number :	GCX079312
Description :	GW INSTEK PSW-500L111
Firmware Version :	01.00.20200309
Hostname :	P-X079312
PCDN3 Hostname :	P-X079312.local
IP Address :	172.16.26.100
Subnet Mask :	255.255.192.0
Gateway :	172.16.0.254
DNS :	172.16.1.248
MAC Address :	00:22:49:87:36:85
DHCP State :	ON
VISA TCP/IP Command String :	TCP:IP: 172.16.26.100 :2548 :SOCKET

- On the Welcome Page, users can get the system information of this PSW-Multi.
- The system information includes all information about Manufacturer, Serial Number, Description, Firmware Version, Web setting, and Web information.

## Tab Network Configuration

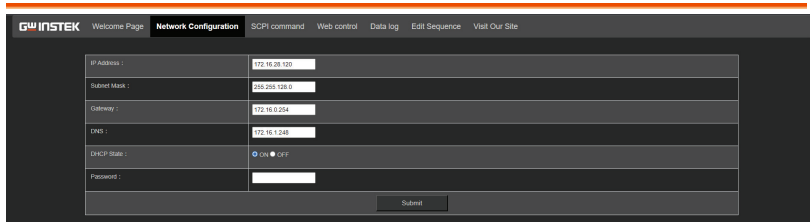

On the Network Configuration page, user can change the IP Address, Subnet Mask, Gateway, DNS address or set password or set DHCP enable to get all network settings from router.

## Tab SCPI command

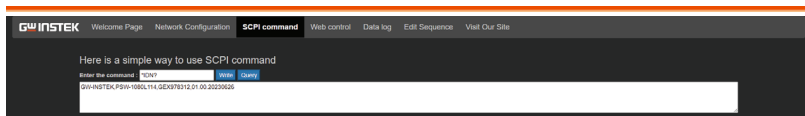

On SCPI command page, user can use SCPI command to remote control PSW-Multi. For usage of remote control, please refer to programming manual for a command list.

## Tab Web control

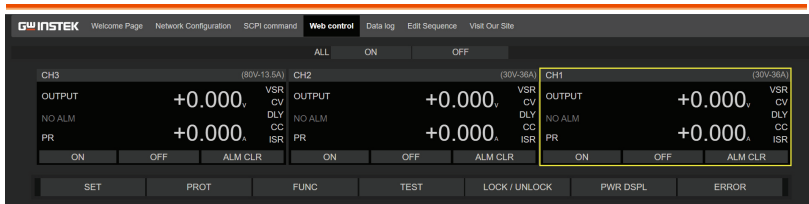

On Web control page, there are seven function tables and all the channels' setting are independent. User can choose any channel and use these functions to remote control PSW-Multi online. All the control methods and behavior is the same as stand-alone.





<b>CH1</b>	Channel display
<b>(30V-36A)</b>	Model type
<b>VSR</b>	This indicator is for indicating Voltage Slew Rate signal. If VSR function is enabled, the signal will become green.
<b>CV</b>	Constant Voltage Mode signal. If PSW-Multi operates in constant voltage mode, the signal will become green.
<b>DLY</b>	Delay Output signal. If delay function is enabled, the signal will become green.
<b>CC</b>	Constant Current Mode signal. If PSW-Multi operates in constant current mode, the signal will become red.
<b>ISR</b>	Current Slew Rate. If ISR function is enable, the signal will become green.
<b>OUTPUT</b>	Output signal. If output set to on, the signal will become green.
<b>NO ALM</b>	Alarm signal. If there is any alarm that is occurred, the signal will show what alarm is activated.
<b>PR</b>	Program ready signal. When user upload sequence to PSW-Multi, the front panel of PSW-Multi will show "WAIT" and this signal will become green. After user press output on, the sequence is executing and this signal will become orange.
<b>ON</b>	Output ON button
<b>OFF</b>	Output OFF button
<b>ALM CLR</b>	Alarm Clear button

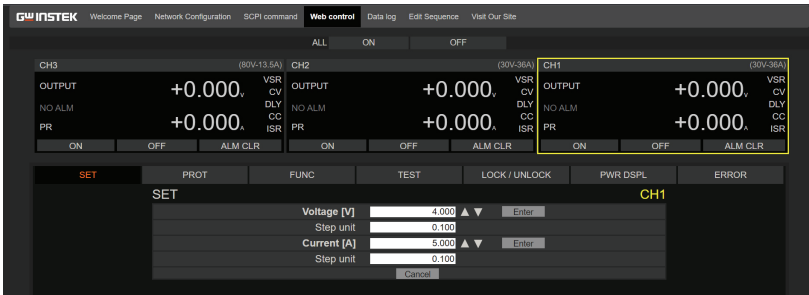

**SET**

SET Table: User can set Voltage and current setting or adjust the setting step unit in this table.

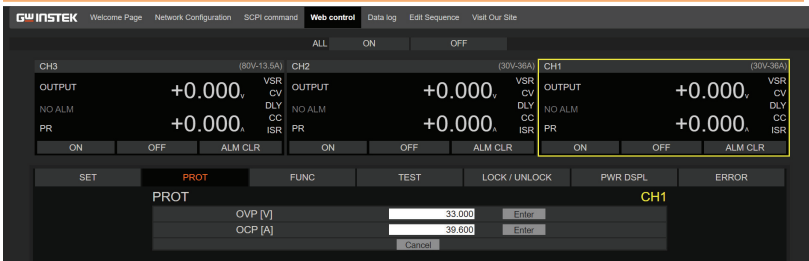

**PROT**

PROT Table: User can set OVP and OCP setting in this table

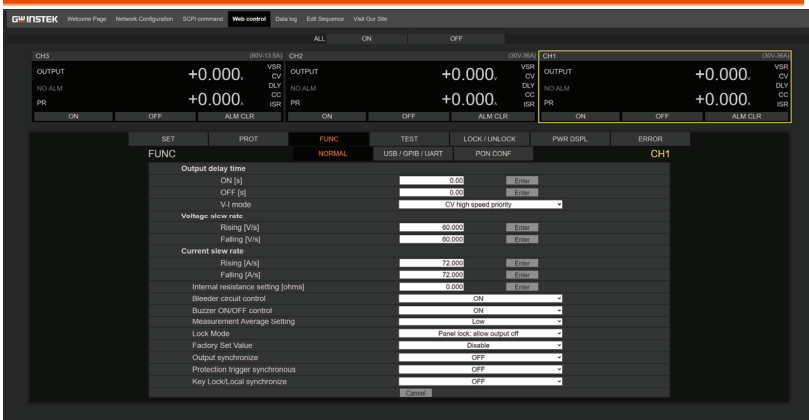

**FUNC**

**NORMAL**

FUNC\_NORMAL Table: User can set function setting in this table.

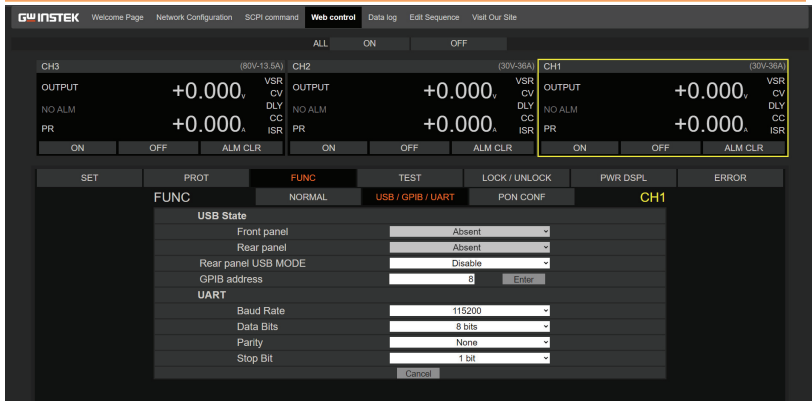

**FUNC**  
**USB / GPIB / UART**

FUNC\_USB/GPIB/UART Table: User can set interface setting in this table.

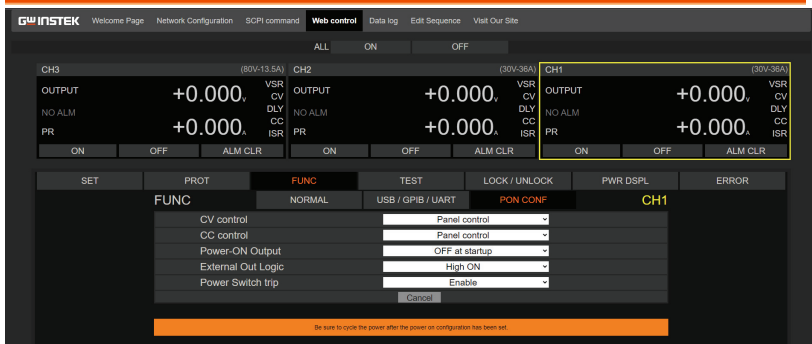

**FUNC**  
**PON CONF**

FUNC\_PON CONF Table: User can set power on configuration setting in this table. Be sure to cycle the power after the power on configuration has been set.

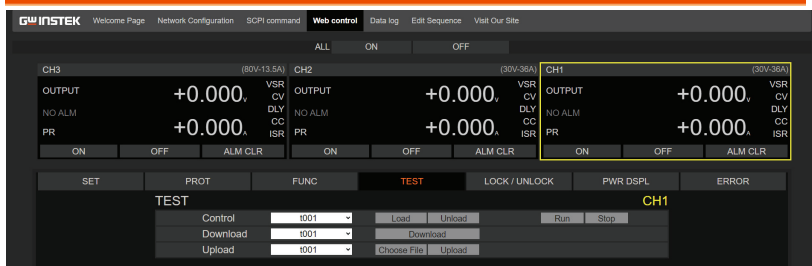

**TEST**

TEST Table: User can use test script function in this table.

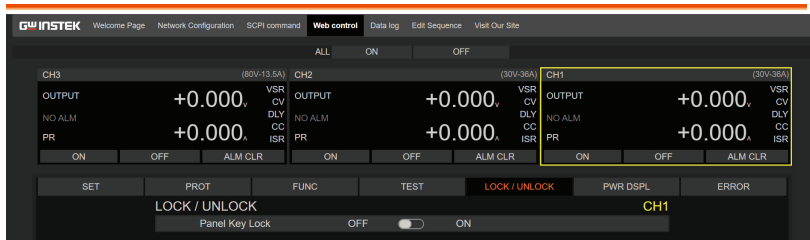

**LOCK / UNLOCK**

LOCK/UNLOCK Table: User can use lock or unlock function in this table.

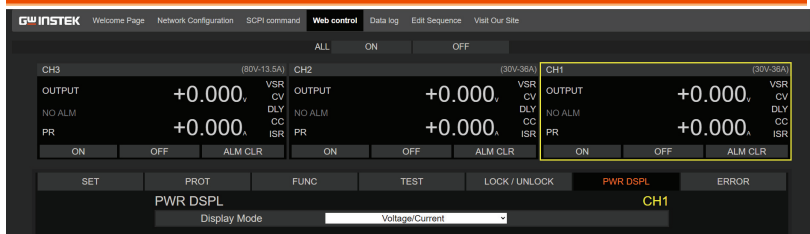

**PWR DSPL**

PWR DSPL Table: User can choose display mode to change Voltage/ Current/ Power display setting in this table.

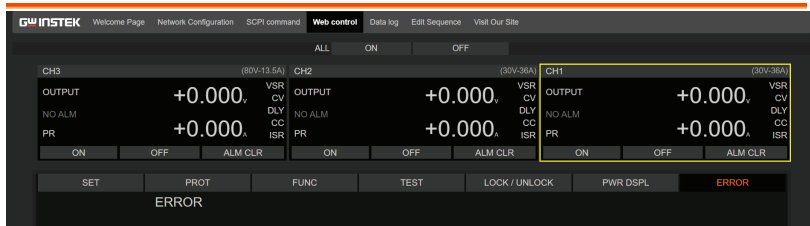

**ERROR**

ERROR Table: If there is a program error during remote control, user can get information from this table.

## Tab Data log

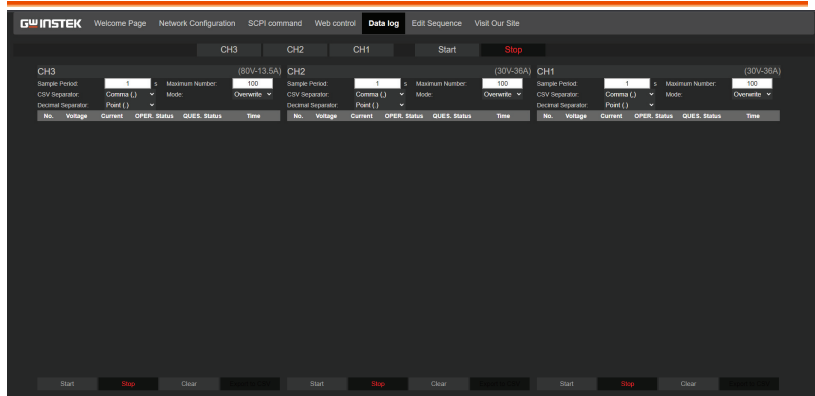

- On Data log page, user can set data log function to record the output voltage and output current by period sampling time and counter setting.
- For usage of data log record function, please follow the setting description.

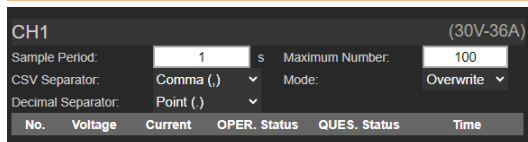

**Sample Period:** Set the sampling period. It can be set from 1sec to 600sec.

**Maximum Number:** Set Maximum counter numbers. It can be set from 100 to 60000 counters.

**CSV Separator:** Before start data log record, User can choose comma (,) or semicolon (;) for CSV separator to generate report.

**Decimal Separator:** Before start data log record, User can choose point (.) or comma (,) for Decimal separator to generate report.

**Mode:** When the data log reaches the maximum counter number settings, user can choose overwrite or stop the data log record.

**No.:** Number of data log counter.

**Voltage:** measurement voltage value.

**Current:** measurement current value.

**OPER. Status:** Value of operation Status Register. Please refer to programming manual for a detail description.

**QUES. Status:** Value of questionable Status Register Value. Please refer to programming manual for a detail description.

**Time:** Time of Data log record.

CH1 (30V-36A)

Sample Period: 1 s Maximum Number: 100

CSV Separator: Comma (,) Mode: Overwrite

Decimal Separator: Point (.)

No.	Voltage	Current	OPER. Status	QUES. Status	Time
1	+1.000	+0.000	+280	+0	06/26 19:57:29.8
2	+1.000	+0.000	+280	+0	06/26 19:57:30.9
3	+1.000	+0.000	+280	+0	06/26 19:57:32.0
4	+1.000	+0.000	+280	+0	06/26 19:57:33.0
5	+1.000	+0.000	+280	+0	06/26 19:57:34.1

Start Stop Clear Export to CSV

**Start Button:** Start data log record function.

**Stop Button:** Stop data log record function.

**Clear Button:** Clear data log record data.

**Export to CSV Button:** Export the data log record data to CSV format.

## Tab Edit Sequence

GW INSTEK Welcome Page Network Configuration SCPI command Web control Data log **Edit Sequence** Visit Our Site

t001 Upload Export csv.tst Import csv

Add Row Del Row Cycle Number: 2 Stop Start Stop End

Step	Point	Output	Time(s)	Voltage (V)	Current (A)	OCP(V)	OCP(A)	Delay	IV Mode	Var (uV/V)	Var down(V/s)	Itr (uA/s)	Itr down(A/s)	R(Ohm)	Deepen	Sense Average	Jump to	Jump Off
1	CIN	1	MIN	MIN	MAX	MAX	CIN +	CVES +	MAX	MAX	MAX	MAX	MIN	EXP +	LDW +			
2	CIN	1	MIN	MIN	MAX	MAX	CIN +	CVES +	MAX	MAX	MAX	MAX	MIN	EXP +	LDW +			
3	CIN	1	MIN	MIN	MAX	MAX	CIN +	CVES +	MAX	MAX	MAX	MAX	MIN	EXP +	LDW +			
4	CIN	1	MIN	MIN	MAX	MAX	CIN +	CVES +	MAX	MAX	MAX	MAX	MIN	EXP +	LDW +			
5	CIN	1	MIN	MIN	MAX	MAX	CIN +	CVES +	MAX	MAX	MAX	MAX	MIN	EXP +	LDW +			
6	CIN	1	MIN	MIN	MAX	MAX	CIN +	CVES +	MAX	MAX	MAX	MAX	MIN	EXP +	LDW +			

On edit sequence page, user can edit sequence online, export sequence to CSV format, import CSV format to sequence and upload sequence to PSW-Multi.

t001 Upload Export csv.tst Import csv

t001 Upload

When sequence editing is complete, user can upload sequence to PSW-Multi. There are ten groups sequence can be uploaded. If there is any sequence already that has been uploaded, the group will be displayed in dark black.



**Export csv, tst**

Export sequence to CSV format and generate .tst attachment.

**Import csv**

Import CSV format to sequence information from this table.

Step	Point	Output	Time(pac)	Voltage (V)	Current (A)	OP(V)	OC(P/A)	Bleeder	IV Mode	Vir up(V/s)	Vir down(V/s)	Ir up(A/s)	Ir down(A/s)	R(ohm)	Beeper	Sense Average	Jump to	Jump Cnt
1	ON	1	MIN	MIN	MAX	MAX	ON	CVHS	MAX	MAX	MAX	MAX	MAX	MIN	OFF	LOW		
2	ON	1	MIN	MIN	MAX	MAX	ON	CVHS	MAX	MAX	MAX	MAX	MAX	MIN	OFF	LOW		
3	ON	1	MIN	MIN	MAX	MAX	ON	CVHS	MAX	MAX	MAX	MAX	MAX	MIN	OFF	LOW		
4	ON	1	MIN	MIN	MAX	MAX	ON	CVHS	MAX	MAX	MAX	MAX	MAX	MIN	OFF	LOW		
5	ON	1	MIN	MIN	MAX	MAX	ON	CVHS	MAX	MAX	MAX	MAX	MAX	MIN	OFF	LOW		
6	ON	1	MIN	MIN	MAX	MAX	ON	CVHS	MAX	MAX	MAX	MAX	MAX	MIN	OFF	LOW		

The default of sequence has six rows and user can use “Add Row” or “Del Row” to adjust it.

Step	Point	Output	Time(pac)	Voltage (V)	Current (A)	OP(V)	OC(P/A)	Bleeder	IV Mode	Vir up(V/s)	Vir down(V/s)	Ir up(A/s)	Ir down(A/s)	R(ohm)	Beeper	Sense Average	Jump to	Jump Cnt
1	ON	1	MIN	MIN	MAX	MAX	ON	CVHS	MAX	MAX	MAX	MAX	MAX	MIN	OFF	LOW		
2	ON	1	MIN	MIN	MAX	MAX	ON	CVHS	MAX	MAX	MAX	MAX	MAX	MIN	OFF	LOW		
3	ON	1	MIN	MIN	MAX	MAX	ON	CVHS	MAX	MAX	MAX	MAX	MAX	MIN	OFF	LOW		
4	ON	1	MIN	MIN	MAX	MAX	ON	CVHS	MAX	MAX	MAX	MAX	MAX	MIN	OFF	LOW		
5	ON	1	MIN	MIN	MAX	MAX	ON	CVHS	MAX	MAX	MAX	MAX	MAX	MIN	OFF	LOW		
6	ON	1	MIN	MIN	MAX	MAX	ON	CVHS	MAX	MAX	MAX	MAX	MAX	MIN	OFF	LOW		

Step	Point	Output	Time(pac)	Voltage (V)	Current (A)	OP(V)	OC(P/A)	Bleeder	IV Mode	Vir up(V/s)	Vir down(V/s)	Ir up(A/s)	Ir down(A/s)	R(ohm)	Beeper	Sense Average	Jump to	Jump Cnt
1	ON	1	MIN	MIN	MAX	MAX	ON	CVHS	MAX	MAX	MAX	MAX	MAX	MIN	OFF	LOW		
2	ON	1	MIN	MIN	MAX	MAX	ON	CVHS	MAX	MAX	MAX	MAX	MAX	MIN	OFF	LOW		
3	ON	1	MIN	MIN	MAX	MAX	ON	CVHS	MAX	MAX	MAX	MAX	MAX	MIN	OFF	LOW		
4	ON	1	MIN	MIN	MAX	MAX	ON	CVHS	MAX	MAX	MAX	MAX	MAX	MIN	OFF	LOW		
5	ON	1	MIN	MIN	MAX	MAX	ON	CVHS	MAX	MAX	MAX	MAX	MAX	MIN	OFF	LOW		
6	ON	1	MIN	MIN	MAX	MAX	ON	CVHS	MAX	MAX	MAX	MAX	MAX	MIN	OFF	LOW		

Step	Point	Output	Time(pac)	Voltage (V)	Current (A)	OP(V)	OC(P/A)	Bleeder	IV Mode	Vir up(V/s)	Vir down(V/s)	Ir up(A/s)	Ir down(A/s)	R(ohm)	Beeper	Sense Average	Jump to	Jump Cnt
1	ON	1	MIN	MIN	MAX	MAX	ON	CVHS	MAX	MAX	MAX	MAX	MAX	MIN	OFF	LOW		
2	ON	1	MIN	MIN	MAX	MAX	ON	CVHS	MAX	MAX	MAX	MAX	MAX	MIN	OFF	LOW		
3	ON	1	MIN	MIN	MAX	MAX	ON	CVHS	MAX	MAX	MAX	MAX	MAX	MIN	OFF	LOW		
4	ON	1	MIN	MIN	MAX	MAX	ON	CVHS	MAX	MAX	MAX	MAX	MAX	MIN	OFF	LOW		
5	ON	1	MIN	MIN	MAX	MAX	ON	CVHS	MAX	MAX	MAX	MAX	MAX	MIN	OFF	LOW		
6	ON	1	MIN	MIN	MAX	MAX	ON	CVHS	MAX	MAX	MAX	MAX	MAX	MIN	OFF	LOW		

- When user wants to edit sequence, user can move mouse flag to everywhere which he wants to edit and press mouse button.
- Then description field will show description and setting range, user can take a reference and edit it.

### **Tab Visit Our Site**

Visit our site then user can get more information, firmware and resource from website.



## PSW-Multi Default Settings

The following default settings are the factory configuration settings for the power supply (Function settings/Test settings).

For details on how to return to the factory default settings, see page 57.

Initial Settings	Default Setting	
Output	Off	
LOCK	0 (Disabled)	
Voltage	0V	
Current	0A	
OVP	Maximum	
OCP	Maximum	
Normal Function Settings	Setting	Default Setting
Output ON delay time	F-01	0.00s
Output OFF delay time	F-02	0.00s
V-I mode slew rate select	F-03	0 = CV high speed priority
Rising voltage slew rate	F-04	60.00V/s (PSW 30) 80.00V/s (PSW 40) 160.0V/s (PSW 80) 320.0V/s (PSW 160) 500.0V/s (PSW 250) 1600V/s (PSW 800)
Falling voltage slew rate	F-05	60.00V/s (PSW 30) 80.00V/s (PSW 40) 160.0V/s (PSW 80) 320.0V/s (PSW 160) 500.0V/s (PSW 250) 1600V/s (PSW 800)
Rising current slew rate	F-06	72.00A/s (PSW 30-36) 54.00A/s (PSW 40-27) 27.00A/s (PSW 80-13.5) 14.40A/s (PSW 160-7.2) 9.000A/s (PSW 250-4.5) 2.880A/s (PSW 800-1.44)

Falling current slew rate	F-07	72.00A/s (PSW 30-36) 54.00A/s (PSW 40-27) 27.00A/s (PSW 80-13.5) 14.40A/s (PSW 160-7.2) 9.000A/s (PSW 250-4.5) 2.880A/s (PSW 800-1.44)
Internal resistance setting	F-08	0.000Ω
Bleeder circuit control	F-09	1 = ON
Buzzer ON/OFF control	F-10	1 = ON
Measurement Average Setting	F-17	0 = Low
Lock Mode	F-19	0 = Panel lock: allow output off
<b>USB/GPIB setting</b>		
Rear Panel USB Mode	F-22	2 = USB CDC
GPIB address	F-23	8
<b>LAN setting</b>		
LAN	F-36	1 = Enable
DHCP	F-37	1 = Enable
Sockets active	F-57	1 = Enable
Web Server active	F-59	1 = Enable
Web password active	F-60	1 = Enable
Web setting password	F-61	0000
<b>Power On Configuration</b>		
CV Control	F-90	0 = Panel control (local)
CC Control	F-91	0 = Panel control (local)
Power-ON Output	F-92	0 = OFF at startup
External Out Logic	F-94	0 = High ON
Power Switch trip	F-95	0 = Enable
<b>Multi-Channel Function Setting</b>		
Output Synchronize	F130	0 = OFF
Protection Trigger Synchronous	F131	0 = OFF
Key Lock/ Local Synchronize	F132	0 = OFF

## Error Messages & Messages

The following error messages or messages may appear on the PSW screen during operation.

Error Messages	Description
Err 001	USB Mass Storage is not present
Err 002	No (such)file in USB mass storage
Err 003	Empty memory location
Err 004	File access error
Err 901	Keyboard CPLD error
Err 902	Analog CPLD error
Err 920	The ADC is over range for calibration
Err 921	The DAC is over range for calibration
Err 922	Point invalid for calibration

Messages	Description
MSG 001	External control of output. Output off (F-94=0, High=on)
MSG 002	External control of output. Output off (F-94=1, Low=on)
MSG 003	F-93 is not zero. Unable to calibrate.
LOCK F-19	F-19 is zero. Unable to turn the output on.

## LED Display Format

Use the following table to read the LED display messages.

0	1	2	3	4	5	6	7	8	9	A	B	C	D
0	1	2	3	4	5	6	7	8	9	A	b	C	d
E	F	G	H	I	J	K	L	M	N	O	P	Q	R
E	F	G	H	I	J	K	L	M	N	O	P	Q	R
S	T	U	V	W	X	Y	Z	(	)	+	-	,	
S	T	U	V	W	X	Y	Z	(	)	+	-	,	

## Specifications

The specifications apply when the PSW is powered on for at least 30 minutes.

PSW 30-36, PSW 40-27, PSW 80-13.5, PSW 160-7.2,  
PSW 250-4.5, PSW 800-1.44

Model	Unit	PSW 30-36	PSW 40-27	PSW 80-13.5	PSW 160-7.2	PSW 250-4.5	PSW 800-1.44
Rated Output Voltage	V	30	40	80	160	250	800
Rated Output Current	A	36	27	13.5	7.2	4.5	1.44
Rated Output Power	W	360	360	360	360	360	360
Power Ratio	--	3	3	3	3.2	3.125	3.2
<b>Constant Voltage Mode</b>							
Line Regulation* <sup>1</sup>	mV	18	23	43	83	128	403
Load Regulation* <sup>2</sup>	mV	20	25	45	85	130	405
<b>Ripple and Noise*<sup>3</sup></b>							
p-p* <sup>4</sup>	mV	60	60	60	60	80	150
r.m.s.* <sup>5</sup>	mV	7	7	7	12	15	30
Temperature coefficient	ppm/°C	100ppm/°C of rated output voltage, after a 30 minute warm-up.					
Remote sense compensation voltage (single wire)	V	0.6	0.6	0.6	0.6	1	1
<b>Rise Time*<sup>6</sup></b>							
Rated Load	ms	50	50	50	100	100	150
No Load	ms	50	50	50	100	100	150
<b>Fall Time*<sup>7</sup></b>							
Rated Load	ms	50	50	50	100	150	300
No Load	ms	500	500	500	1000	1200	2000
Transient response time* <sup>8</sup>	ms	1	1	1	2	2	2
<b>Constant Current Mode</b>							
Line regulation* <sup>1</sup>	mA	41	32	18.5	12.2	9.5	6.44
Load regulation* <sup>9</sup>	mA	41	32	18.5	12.2	9.5	6.44
<b>Ripple and noise</b>							
r.m.s.* <sup>5</sup>	mA	72	54	27	15	10	5
Temperature coefficient	ppm/°C	200ppm/°C of rated output current, after a 30 minute warm-up.					

<b>Protection Function</b>							
Over voltage protection (OVP)							
Setting range	V	3-33	4-44	8-88	16-176	20-275	20-880
Setting accuracy	± (2% of rated output voltage)						
Over current protection (OCP)							
Setting range	A	3.6-39.6	2.7-29.7	1.35-14.85	0.72-7.92	0.45-4.95	0.144-1.584
Setting accuracy	± (2% of rated output current)						
Overheat(Over temperature) protection (OHP (OTP))							
Operation	Turn the output off.						
Low AC input protection (AC-FAIL)							
Operation	Turn the output off.						
Power limit (POWER LIMIT)							
Operation	Over power limit.						
Value (fixed)	Approx. 105% of rated output power						
<b>Analog Programming and Monitoring</b>							
External voltage control output voltage	Accuracy and linearity: ±0.5% of rated output voltage.						
External voltage control output current	Accuracy and linearity: ±1% of rated output current.						
External resistor control output voltage	Accuracy and linearity: ±1.5% of rated output voltage.						
External resistor control output current	Accuracy and linearity: ±1.5% of rated output current.						
Output voltage monitor							
Accuracy	%	±1	±1	±1	±1	±2	±2
Output current monitor							
Accuracy	%	±1	±1	±1	±1	±2	±2
Shutdown control	Turns the output or power off with a LOW (0V to 0.5V) or short-circuit.						
Output on/off control	Possible logic selections: Turn the output on using a LOW (0V to 0.5V) or short-circuit, turn the output off using a HIGH (4.5V to 5V) or open-circuit. Turn the output on using a HIGH (4.5V to 5V) or open-circuit, turn the output off using a LOW (0V to 0.5V) or short-circuit.						
CV/CC/ALM/PWR ON/OUT ON indicator	Photocoupler open collector output; Maximum voltage 30V, maximum sink current 8mA.						

Front Panel							
Display, 4 digits							
Voltage accuracy 0.1% +	mV	20	20	20	100	200	400
Current accuracy 0.1% +	mA	40	30	20	5	5	2
Indications		GREEN LED's: CV, CC, VSR, ISR, DLY, RMT, 20, 40, 60, 80, 100, %W, W, V, A					
		RED LED's: ALM					
Buttons		Function, OVP/OCP, Set, Test, Lock/Local, PWR DSPL, Output					
Knobs		Voltage, Current					
USB port		Type A USB connector					
Programming and Measurement (USB, LAN, GPIB)							
Output voltage programming accuracy 0.1% +							
mV	10	10	10	100	200	400	
Output current programming accuracy 0.1% +							
mA	30	20	10	5	5	2	
Output voltage programming resolution							
mV	1	1	2	3	5	14	
Output current programming resolution							
mA	1	1	1	1	1	1	
Output voltage measurement accuracy 0.1% +							
mV	10	10	10	100	200	400	
Output current measurement accuracy 0.1% +							
mA	30	20	10	5	5	2	
Output voltage measurement resolution							
mV	1	1	2	3	5	14	
Output current measurement resolution							
mA	1	1	1	1	1	1	
Efficiency							
100Vac	%	77	78	78	79	79	80
200Vac	%	79	80	80	81	81	82

\*1 At 85 ~ 132Vac or 170 ~ 265Vac, constant load.

\*2 From No-load to Full-load, constant input voltage. Measured at the sensing point in Remote Sense.

\*3 Measure with JEITA RC-9131B (1:1) probe

\*4 Measurement frequency bandwidth is 10Hz to 20MHz.

\*5 Measurement frequency bandwidth is 5Hz to 1MHz.

\*6 From 10% to 90% of rated output voltage, with rated resistive load.

\*7 From 90% to 10% of rated output voltage, with rated resistive load.

\*8 Time for output voltage to recover within 0.1% + 10mV of its rated output for a load change from 50 to 100% of its rated output current.

\*9 For load voltage change, equal to the unit voltage rating, constant input voltage.

## PSW-720

Input Characteristics		
Nominal input rating	100Vac to 240Vac, 50Hz to 60Hz, single phase	
Input voltage range	85Vac ~ 265Vac	
Input voltage range	47Hz ~ 63Hz	
Maximum input current		
100Vac	A	10
200Vac	A	5
Inrush current	Less than 50A.	
Maximum input power	VA	1000
Power factor		
100Vac	0.99	
200Vac	0.97	
Hold-up time	20ms or greater	
Interface Capabilities		
USB	TypeA: Host, TypeB: Slave, Speed: 1.1/2.0, USB Class: CDC(Communications Device Class)	
LAN	MAC Address, DNS IP Address, User Password, Gateway IP Address, Instrument IP Address, Subnet Mask	
GPIB	Optional: GUG-001 ( GPIB to USB Adapter)	
Environmental Conditions		
Operating temperature	0°C to 50°C	
Storage temperature	-25°C to 70°C	
Operating humidity	20% to 85% RH; No condensation	
Storage humidity	90% RH or less; No condensation	
Altitude	Maximum 2000m	
General Specifications		
Weight (main unit only)	kg	Approx. 5.4kg
Dimensions (W x H x D)	mm	142 x 124 x 350
Cooling	Forced air cooling by internal fan.	
EMC	Complies with the European EMC directive for Class A test and measurement products.	
Safety	Complies with the European Low Voltage Directive and carries the CE-marking.	
Withstand voltage	Between input and chassis: No abnormalities at 1500 Vac for 1 minute. Between input and output: No abnormalities at 3000 Vac for 1 minute.	

	Between output and chassis: No abnormalities at 500 Vdc for 1 minute for 30V, 40, 80V, 160V models. No abnormalities at 1500 Vdc for 1 minute for 250V, 800V models.
Insulation resistance	Between input and chassis: 500 Vdc, 100MΩ or more Between input and output: 500 Vdc, 100MΩ or more Between output and chassis: 500 Vdc, 100MΩ or more for 30V, 40V, 80V, 160V and 250V models. 1000Vdc, 100MΩ or more for 800V models.

## PSW-1080

<b>Input Characteristics</b>	
Nominal input rating	100Vac to 240Vac, 50Hz to 60Hz, single phase
Input voltage range	85Vac ~ 265Vac
Input voltage range	47Hz ~ 63Hz
Maximum input current	
100Vac	A 15
200Vac	A 7.5
Inrush current	Less than 75A.
Maximum input power	VA 1500
Power factor	
100Vac	0.99
200Vac	0.97
Hold-up time	20ms or greater
<b>Interface Capabilities</b>	
USB	TypeA: Host, TypeB: Slave, Speed: 1.1/2.0, USB Class: CDC(Communications Device Class)
LAN	MAC Address, DNS IP Address, User Password, Gateway IP Address, Instrument IP Address, Subnet Mask
GPIB	Optional: GUG-001 ( GPIB to USB Adapter)
<b>Environmental Conditions</b>	
Operating temperature	0°C to 50°C
Storage temperature	-25°C to 70°C
Operating humidity	20% to 85% RH; No condensation
Storage humidity	90% RH or less; No condensation
Altitude	Maximum 2000m



General Specifications	
Weight (main unit only)	kg Approx. 7.7kg
Dimensions (W x H x D)	mm 214 x 124 x 350
Cooling	Forced air cooling by internal fan.
EMC	Complies with the European EMC directive for Class A test and measurement products.
Safety	Complies with the European Low Voltage Directive and carries the CE-marking.
Withstand voltage	Between input and chassis: No abnormalities at 1500 Vac for 1 minute.
	Between input and output: No abnormalities at 3000 Vac for 1 minute.
	Between output and chassis: No abnormalities at 500 Vdc for 1 minute for 30V, 40, 80V, 160V models.
	No abnormalities at 1500 Vdc for 1 minute for 250V, 800V models.
Insulation resistance	Between input and chassis: 500 Vdc, 100M $\Omega$ or more
	Between input and output: 500 Vdc, 100M $\Omega$ or more
	Between output and chassis: 500 Vdc, 100M $\Omega$ or more for 30V, 40V, 80V, 160V and 250V models. 1000Vdc, 100M $\Omega$ or more for 800V models.

# PSW-Multi Dimensions

PSW-720

PSW 250-4.5/ PSW 800-1.44 (scale: mm)

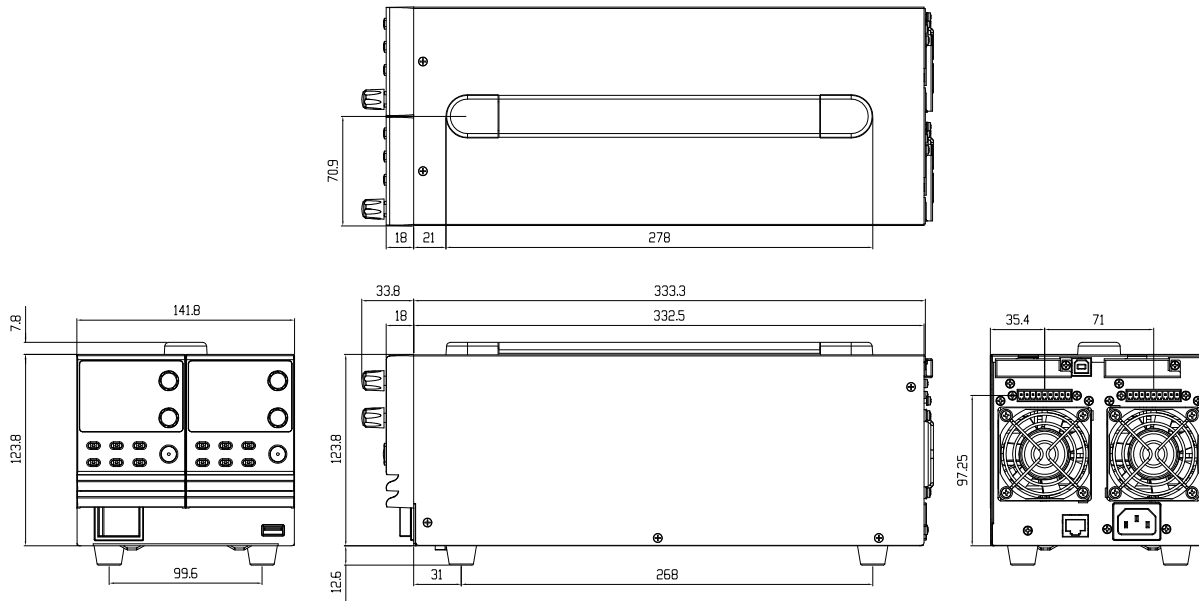

PSW 160-7.2/ PSW 80-13.5/ PSW 40-27/ PSW 30-36 (scale: mm)

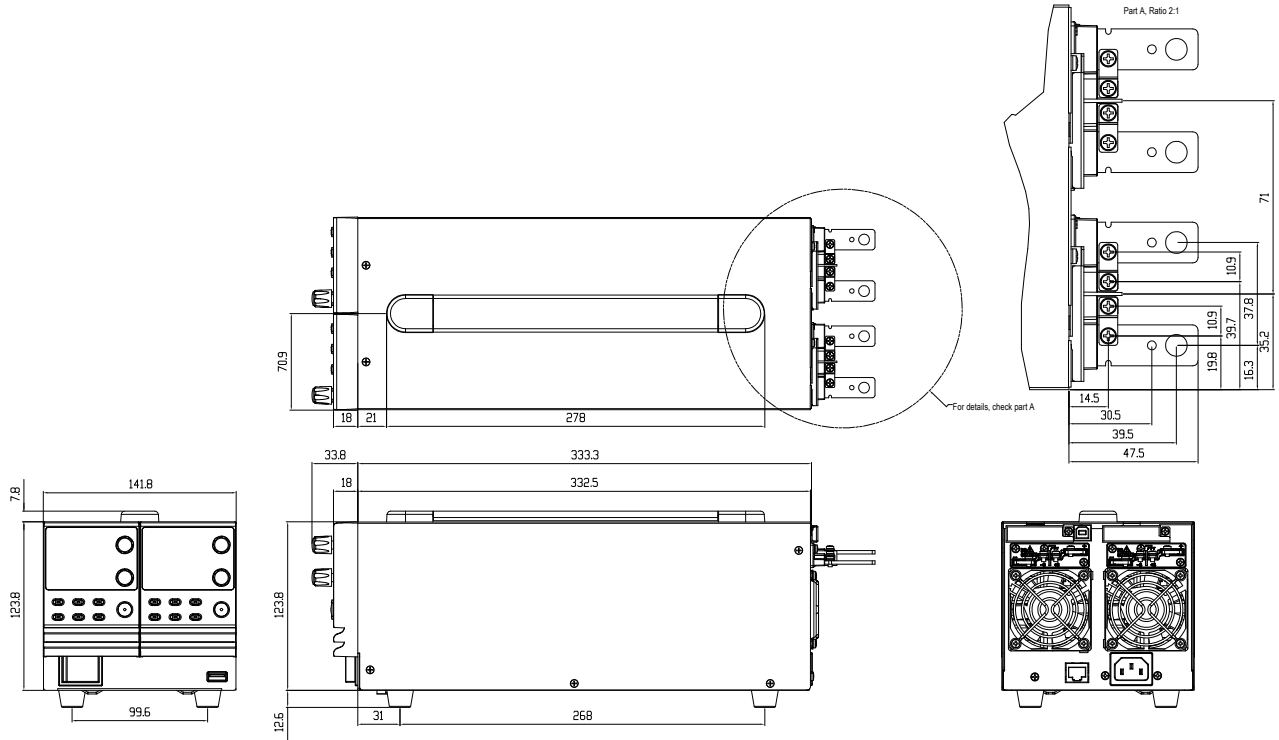

PSW-1080

PSW 250-9/ PSW 800-2.88 (scale: mm)

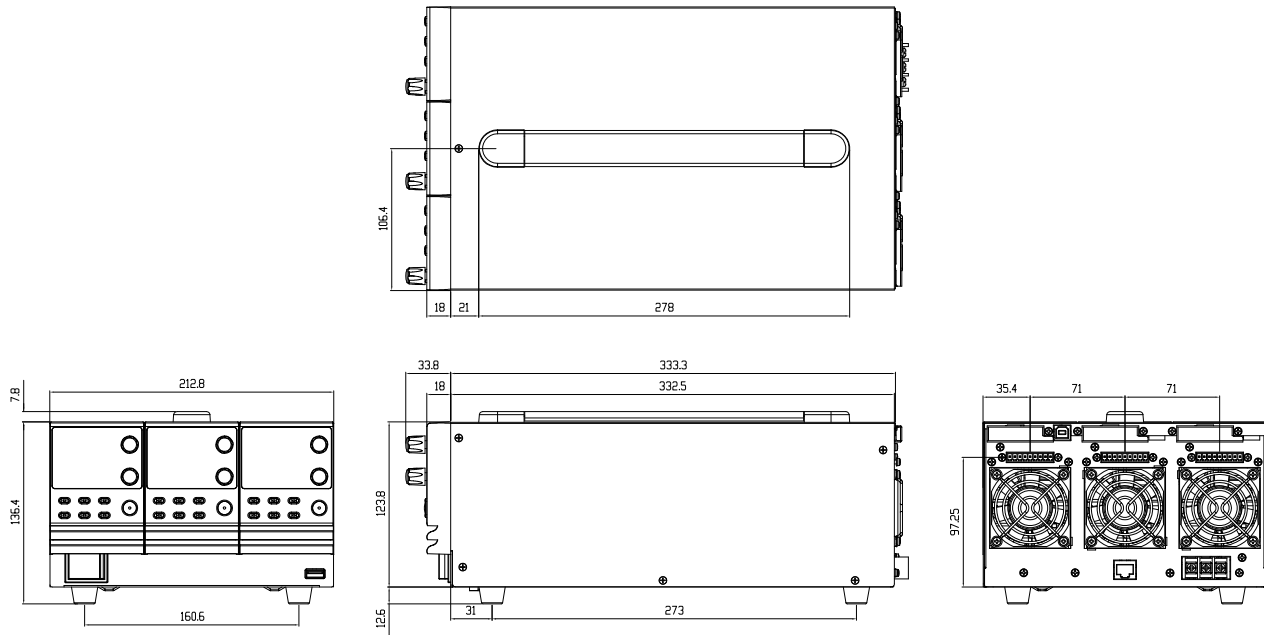

PSW 160-14.4/ PSW 80-27/ PSW 40-54/ PSW 30-72 (scale: mm)

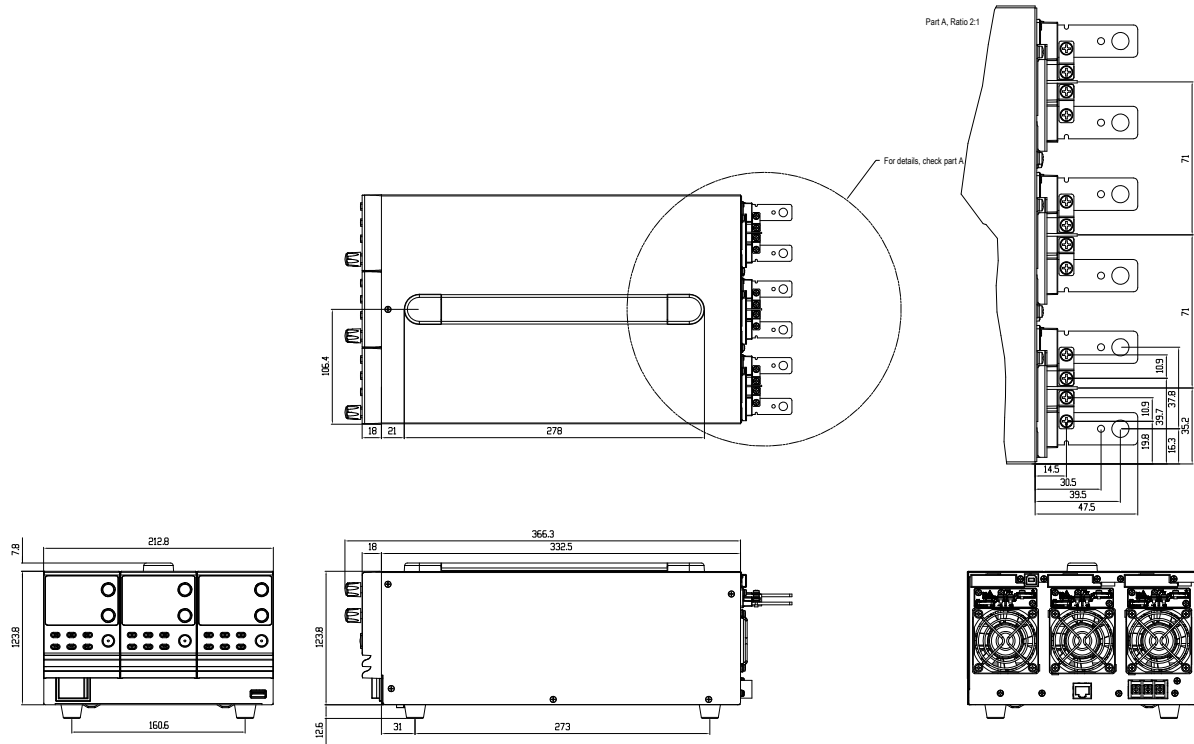

# Certificate Of Compliance

We

**GOOD WILL INSTRUMENT CO., LTD.**

declare that the CE marking mentioned product satisfies all the technical relations application to the product within the scope of council:

Directive: EMC; LVD; WEEE; RoHS

The product is in conformity with the following standards or other normative documents:

© EMC	
EN 61326-1	Electrical equipment for measurement, control and laboratory use -- EMC requirements
Conducted & Radiated Emission EN 55011 / EN 55032	Electrical Fast Transients EN 61000-4-4
Current Harmonics EN 61000-3-2 / EN 61000-3-12	Surge Immunity EN 61000-4-5
Voltage Fluctuations EN 61000-3-3 / EN 61000-3-11	Conducted Susceptibility EN 61000-4-6
Electrostatic Discharge EN 61000-4-2	Power Frequency Magnetic Field EN 61000-4-8
Radiated Immunity EN 61000-4-3	Voltage Dip/ Interruption EN 61000-4-11 / EN 61000-4-34
© Safety	
EN 61010-1 :	Safety requirements for electrical equipment for measurement, control, and laboratory use - Part 1: General requirements

**GOODWILL INSTRUMENT CO., LTD.**

No. 7-1, Jhongsing Road, Tucheng District, New Taipei City 236, Taiwan

Tel: [+886-2-2268-0389](tel:+886-2-2268-0389)

Fax: [+886-2-2268-0639](tel:+886-2-2268-0639)

Web: <http://www.gwinstek.com>

Email:

[marketing@goodwill.com.tw](mailto:marketing@goodwill.com.tw)

**GOODWILL INSTRUMENT (SUZHOU) CO., LTD.**

No. 521, Zhujiang Road, Snd, Suzhou Jiangsu 215011, China

Tel: [+86-512-6661-7177](tel:+86-512-6661-7177)

Fax: [+86-512-6661-7277](tel:+86-512-6661-7277)

Web: <http://www.instek.com.cn>

Email: [marketing@instek.com.cn](mailto:marketing@instek.com.cn)

**GOODWILL INSTRUMENT EURO B.V.**

De Run 5427A, 5504DG Veldhoven, The Netherlands

Tel: [+31-\(0\)40-2557790](tel:+31-(0)40-2557790)

Fax: [+31-\(0\)40-2541194](tel:+31-(0)40-2541194)

Email: [sales@gw-instek.eu](mailto:sales@gw-instek.eu)

# INDEX

Accessories .....	18
Alarm	
description .....	37
Analog connector	
pin assignment .....	101
Analog control	
output control .....	112
overview .....	100
remote monitoring .....	117
resistance control - current	
output .....	110
resistance control - voltage	
output .....	108
shutdown control .....	115
status monitoring .....	119
voltage control - current output	106
voltage control - voltage output	103
Bleeder control	
description .....	34
Description .....	32
Build date	
view .....	58
Caution symbol .....	5
CC and CV mode	
description .....	30
CC mode	
operation .....	66
Cleaning the instrument .....	6
Configuration	
calibration settings .....	97
LAN settings .....	93
Normal function settings .....	88
normal function settings	
operation .....	97
overview .....	84
power on configuration operation	98
power on configuration settings	95
script test settings .....	73
System settings .....	94
table .....	84
test function settings .....	74
USB/GPIB settings .....	92
Connector plug manufacturer	26, 50
Conventions .....	55
CV mode	
operation .....	64
DECA SwitchLab .....	26, 50
Declaration of conformity .....	166
Default settings .....	152, 153
reset .....	57
Dimensions	
diagram .....	163
Display format .....	155
Display mode	
operation .....	69
Disposal instructions .....	7
EN61010	
pollution degree .....	7
Environment	
safety instruction .....	6
Error messages .....	155
Ethernet	
interface .....	125
sockets .....	126
web server .....	125
FAQ .....	140
Filter installation .....	45
Front panel diagram .....	21, 24
Ground	
symbol .....	5
Grounding .....	40
Internal resistance	
description .....	36
LCD conversion .....	155
Line voltage	
PSW-1080 .....	43
List of features .....	17

Load connection		operation.....	70
PSW-250/800.....	50	Service operation	
PSW-30/40/80/160.....	47	about disassembly .....	6
Maintenance		contact .....	141
replacing the filter .....	139	Slew rate	
Marketing		description.....	32
contact .....	141	Socket server function check ..	133
Messages.....	155	Specifications.....	156
OCP level.....	61	PSW 160-7.2.....	156
Operating area description	28, 145, 146	PSW 250-4.5.....	156
Operation considerations .....	37	PSW 30-36 .....	156
floating output .....	40	PSW 40-27 .....	156
inrush current .....	37	PSW 800-1.44.....	156
Pulsed loads .....	38	PSW 80-13.5 .....	156
reverse current.....	38	System version	
Output connector pinout.....	51	view .....	58
Output connector wiring.....	51	Terminal cover	
OVP level.....	61	PSW-30/40/80/160.....	49
Panel lock .....	70	Test script	
Power on/off		check available memory .....	82
safety instruction.....	6	export.....	80
Power up .....	45	load .....	75
Rack mount		overview .....	73
description .....	55	remove/delete test .....	81
Rear panel diagram.....	25	run	
Remote control.....	122	automatically .....	79
USB configuration .....	123	manually .....	77
Remote control function check	127	USB driver version	
Realterm.....	128	view .....	58
Remote sense		Warning symbol .....	5
connection.....	71	Web server function check .....	133
		Wire gauge chart.....	46