

JBC

www.jbctools.com

INSTRUCTION MANUAL



FAE1

Fume Extractor for 1 Workbench

This manual corresponds to the following references:

FAE1-1C (120V)

FAE1-2C (230V)

FAE1-9C (100V)

Packing List

The following items are included:



Fume Extractor for 1 Workbench 1 unit

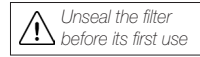

FAE1100 Filter for FAE1 1 unit
 Ref. FAE1-100 (already assembled inside the Fume Extractor)



RJ12 Connection Cable 2 units
 Ref. 0019751



Power Cable 1 unit
 Ref. 0023715 (100V / 120V)
 0023714 (230V)



USB Connection Cable
 (USB-A to USB-B) 1 unit
 Ref. 0021042



Station Connection Adapter
 (RJ12 to USB-A) 1 unit
 Ref. 0023504



Manual 1 unit
 Ref. 0032497

These station connection cables are only required for compact station versions "E" and previous versions. Modular control units and compact stations from version "F" require the RJ12 station connection cable.

Features and Connections

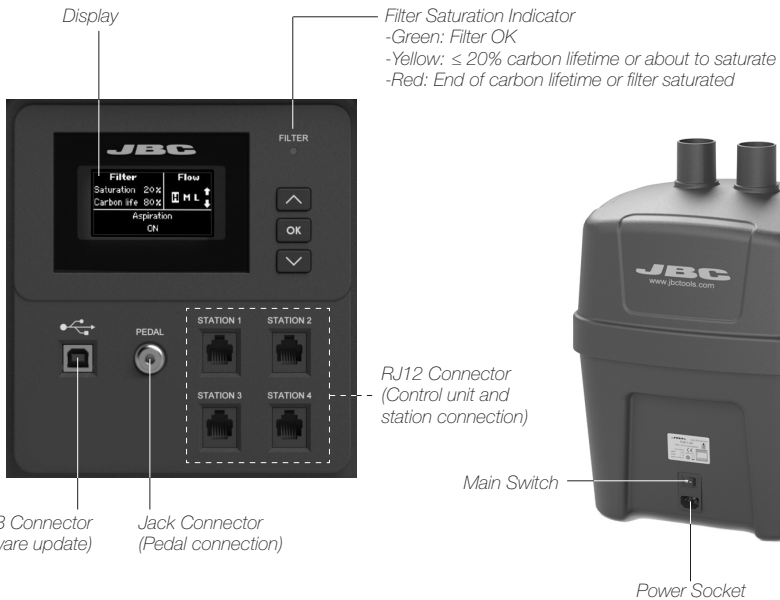

Standard Assembly

Configuration for 1 Workbench

F AE070
Flexible Arm with Clamp Ø50
 - Length: 1 m / 39.37 in
 - To be assembled onto the workbench with the included clamp.

F AE050
Fume Inlet Duct for Modular Stand (stands from versions Ref. xx-SD onwards)

F AE060
Fume Inlet Duct for Compact Stations (stations from versions Ref.xx-xB onwards)

F AE020
Flexible Arm Ø50
 - Length: 1 m / 39.37 in
 - To be inserted and screwed directly onto the workbench (hole drilling required).

F AE040
Accessory for Stand Aspiration with Clamp
 - For flexible hose Ø50 mm.
 - To be fixed in place with the included clamp.
 - For up to 4 stands.

F AE030
Accessory for Stand Aspiration
 - For flexible hose Ø50 mm.
 - To be inserted and screwed directly onto the workbench (hole drilling required).

F AE010
Flexible Hose Ø50
 - Length: 1,5 m / 59.05 in
 - For connecting either to a flexible arm or to a accessory for the stand aspiration.
 - **Attention:** Avoid awkward positions in order to minimize pressure losses.

F AE1
Fume Extractor for 1 Workbench

Main Screen

Access by  and  to change the aspiration program.

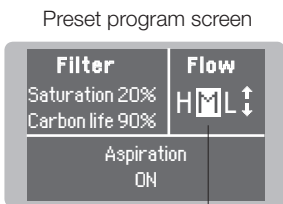

Aspiration Programs: high, medium and low.

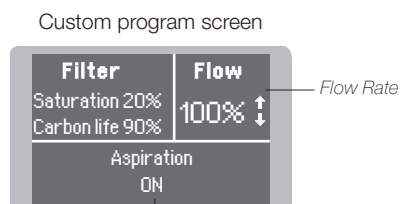

Aspiration Status

Alternative Assembly Option

Configuration for 2 Workbenches

This configuration is activated by setting Workbench option to “2” in the FAE1 main menu.

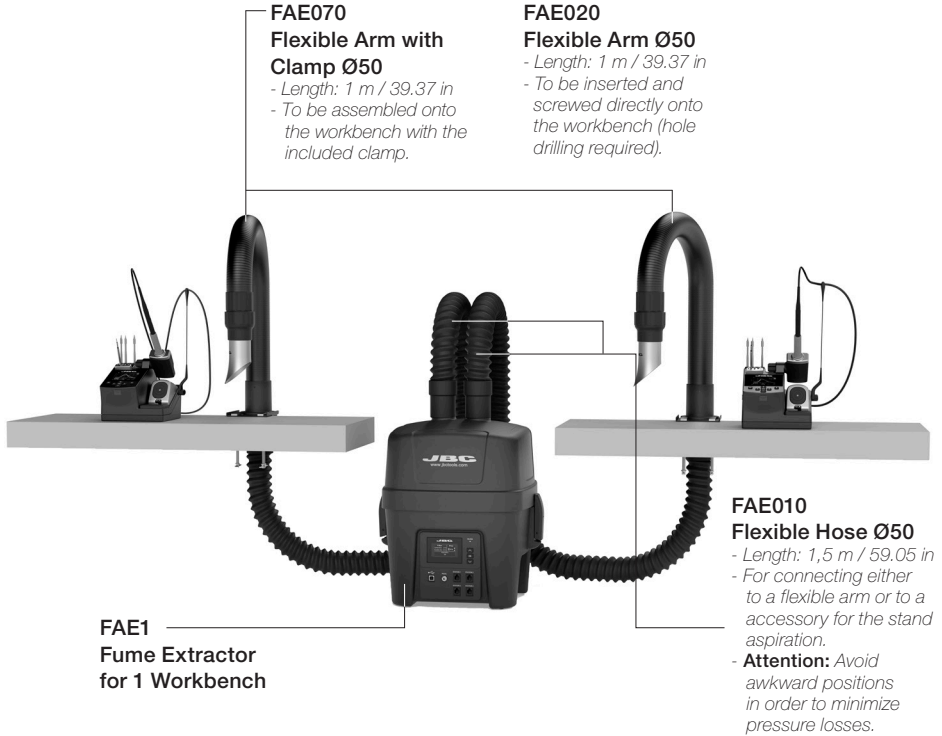

Main Screen

Access by and to change the aspiration program.

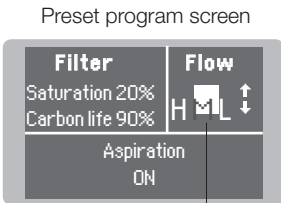

Aspiration Programs:
high, medium and low.

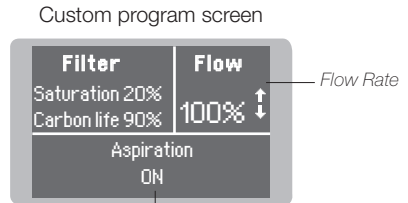

Aspiration Status

Note: For this configuration stand aspiration is not available.

Connection with Modular Stations

JBC Soldering Stations feature a robot port to the fume extractor in order to automatically activate the extraction when the tools are in use. Use the Premium Station Cable (included) for the connection.

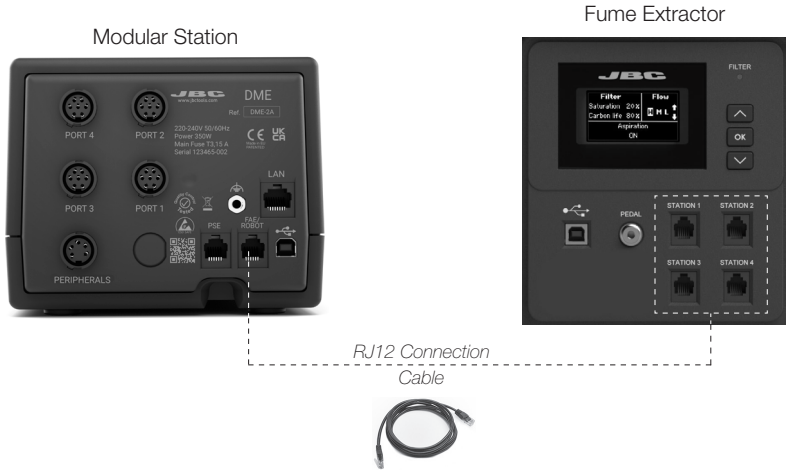

Connect up to 4 stations directly to a fume extractor port (STATION 1, STATION 2, ...) through the soldering station port (FAE/ROBOT). Every tool connected to a station can control the aspiration system.

Each Station detects the fume extractor as "FAE_a". The tool that should activate the fume extraction need to be configured through the peripheral menu option on the station menu.

Station Peripheral Menu

17:14	
Peripherals	Port 1-T245
Pedal	None
Module	None
Fume extractor	FAE_a
Back	

Note: For a correct operation always update soldering stations with the latest available software version. The minimum required version is 8886160 for DDE, HDE and NAE stations and 8886162 for DME stations.

Connection with Compact Stations

Use the Compact Station Cable and the Adapter cable to connect JBC Soldering Stations. They feature a USB-B port to the fume extractor in order to automatically activate the extraction when the tools are in use.

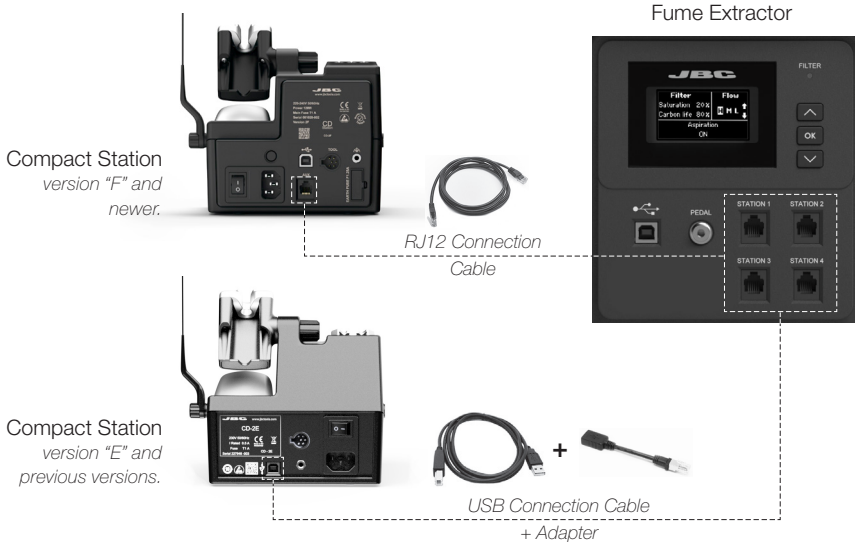

Important:

First connect the compact station to the fume extractor and then switch on the fume extractor. Otherwise the compact station will not be able to control the fume extractor.

Fume Extractor Firmware Update

FAE fume extractor can be updated via its USB-B connector by means of the USB connection cable. The firmware update file can be downloaded from www.jbctools.com/software.html.

Note: The RJ12 station connection cable must be disconnected for the update process. If a station is connected to the RJ12 connector, the update process will not start.

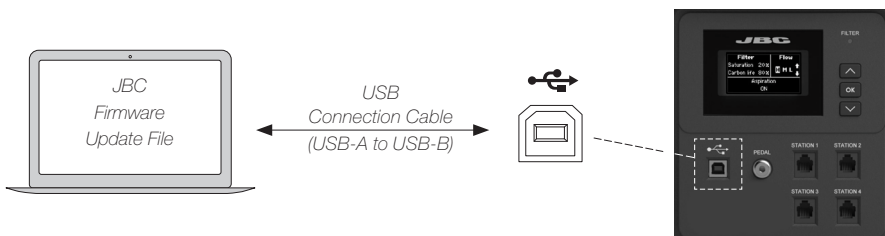

Menu Interface

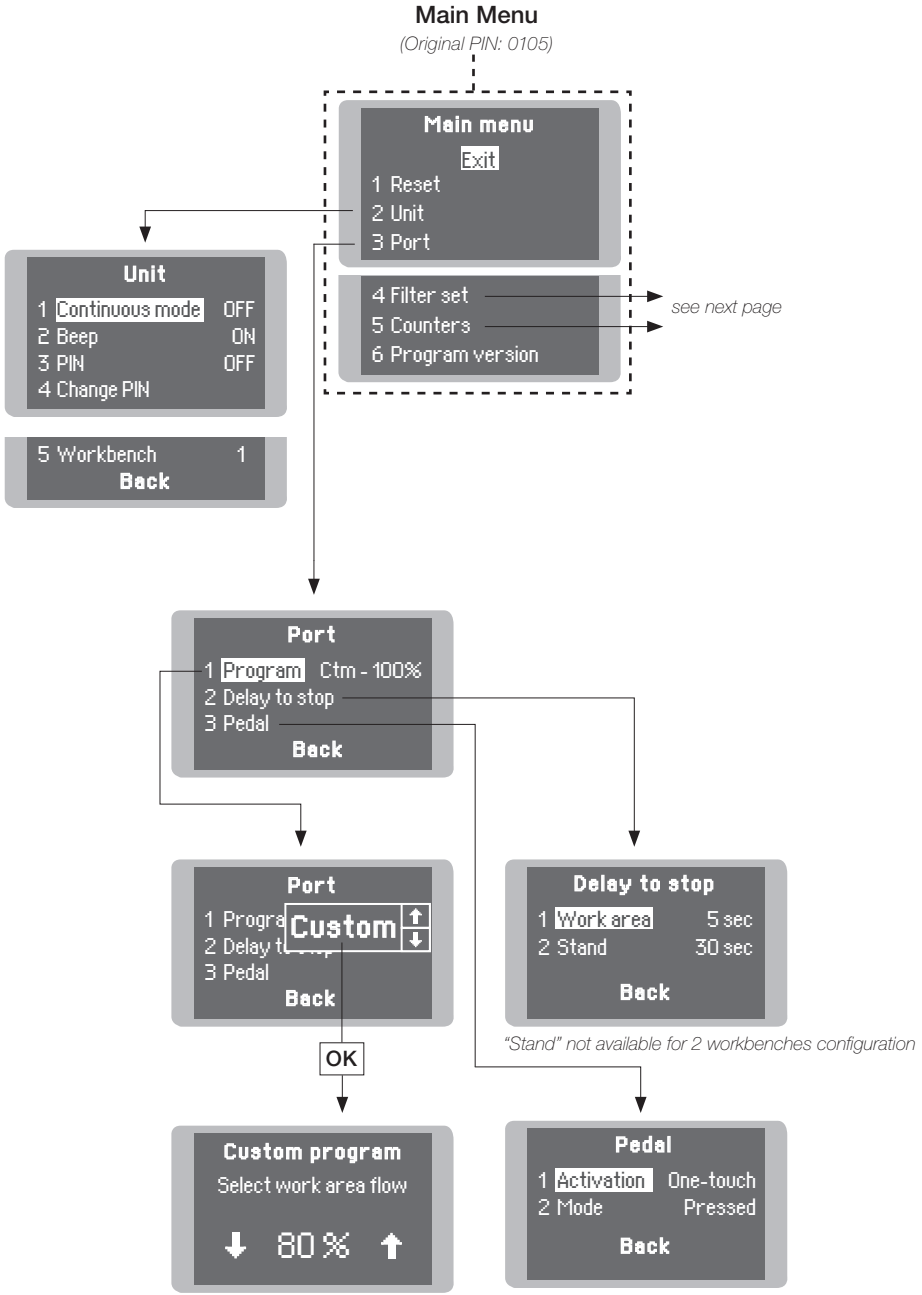

Menu Interface

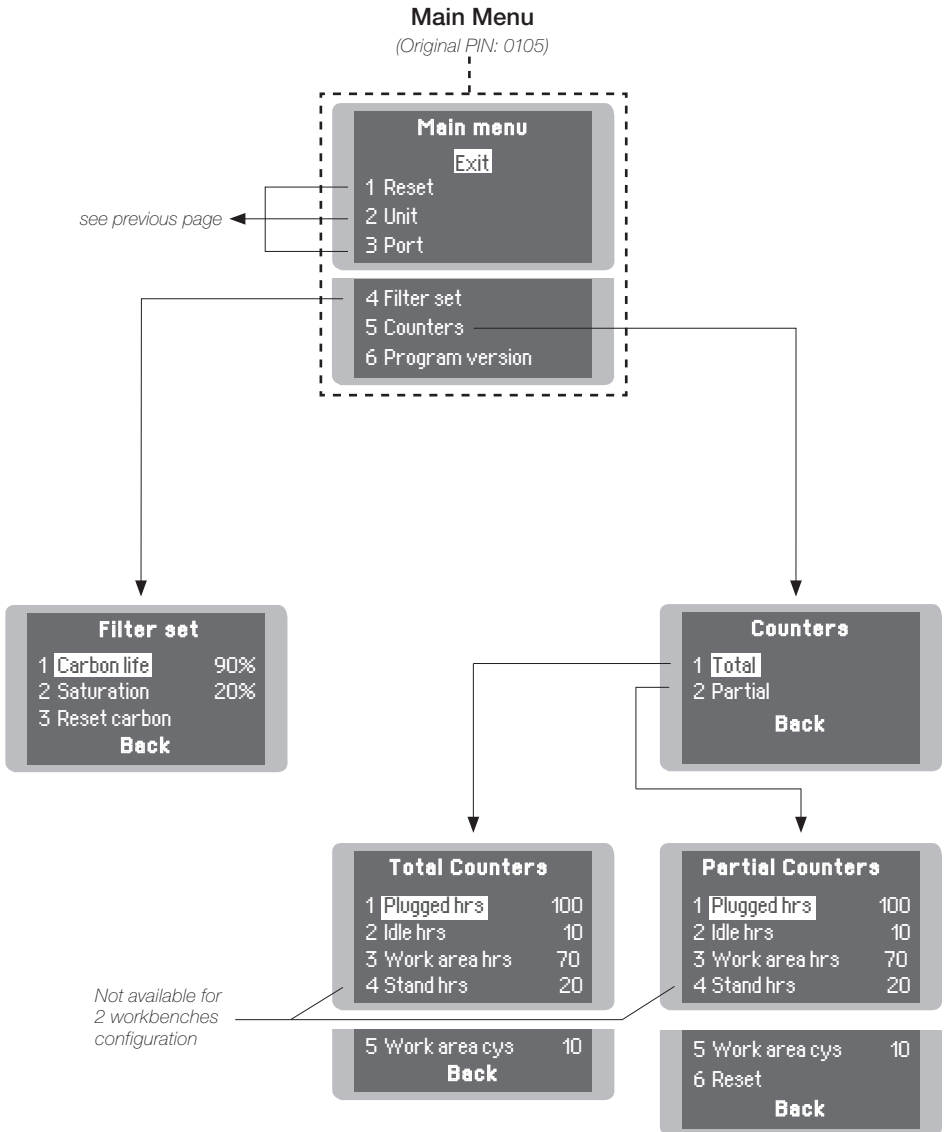

Fume Extractor Activation

Once the fume extractor is turned on, the display shows a similar screen as the following one and the filter saturation indicator is green if the carbon filter lifetime is higher than 20%.

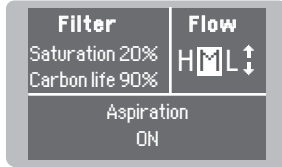

- Green: Filter OK
- Yellow: ≤ 20% carbon lifetime or about to saturate
- Red: End of carbon lifetime or filter saturated

If the display shows STOP#4, power off the fume extractor, remove the cover, place it back and secure it by using the quick release levers.

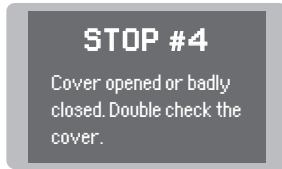

Troubleshooting

Station troubleshooting available on the product page at www.jbctools.com

Parameters

 **Important: Power off soldering stations connected to the fume extractor before modifying any parameter.**

Unit

Parameter	Description
Continuous mode	Enable/disable continuous aspiration. Fume extractor aspirations remains active independently from tool or pedal status.
Beep	Enable/disable the sound of the keypad.
PIN	Enable/disable PIN request when modifying parameters.
Change PIN	Change the default security PIN code. Default PIN 0105
Workbench	Select working mode for 1 or 2 workbenches (see page "Menu Interface").

Port

Parameter	Description
Program	<p>It sets the fume extractor aspiration flow. You can select between preset and custom aspiration programs.</p> <p>H (High), M (Medium) or L (Low) are the three available preset options. Use UP and DOWN keys to switch between them while being on the main screen.</p> <p>Up to ten aspiration levels between H (High) and L (Low) can be selected for custom program (range 10-100%). If a custom aspiration program is selected, the selected aspiration level can be changed on the main screen. By default, M (Medium) aspiration program is selected.</p>
Delay to stop / Stand	<p>It sets the time that a fume extractor keeps aspirating fumes at the stand once the tool is returned to it (range 0-999 seconds)</p> <p>By default stand time is 60 seconds.</p>
Delay to stop / Work area	<p>It sets the time that a fume extractor keeps aspirating fumes at the work area once the tool is returned to the stand (range 0-300 seconds).</p>
Pedal / Activation	<p>It sets the pedal activation mode. There are two different modes: "pressed" and "released".</p> <p>One-touch: Press the pedal once to activate aspiration. Press again to stop aspiration.</p> <p>Pressed: (Mode function must be pressed) aspiration is active as long as the pedal is kept pressed.</p> <p>By default activation is pressed.</p>
Pedal / Mode	<p>When the activation parameter is set to pressed, the mode parameter can be configured to released mode. In this mode aspiration is always active until the pedal is pressed.</p> <p>By default mode is pressed.</p>

Filter Set

Parameter	Description
Carbon life	It shows remaining activated carbon lifetime expressed in %. It is also displayed on the main screen. When 0% is reached the system will show pop-up message STOP#1 to replace the filter.
Saturation	It shows saturation status of HEPA + carbon filter set, expressed in %. It is also displayed on the main screen. When 100% is reached the system will show pop-up message STOP#2 to replace the filter.
Reset carbon	Perform this action after replacing the HEPA + carbon filter set. The carbon lifetime counter will not start until the filter is detected for the first time. After executing that function carbon filter life will be 100%.

Extraction Control via the Pedal

The fume extractor aspiration can be activated/deactivated by using JBC's pedal P405 or P005.

Pedal Connection

Connect the pedal to the pedal connector and read the description for "Pedal / Activation" and "Pedal / Mode" on the previous page.

P405 Pedal
or
P005 Pedal



Fume Extractor Configurations

Some parameters, features and the performance vary depending on fume extractor configuration, see the following table:

230V - 50/60Hz	Mode: 1 Workbench	Mode: 2 Workbenches
Flexible Arm Aspiration Intake	1	2
Stand Aspiration Intake	1	Not available
Flow per Flexible Arm Intake	80 m ³ / h (47.08 cfm)	80 m ³ /h (47.08 cfm)
Preset Aspiration Programs	3	3
Custom Aspiration Programs	10	10
Power Consumption	130 W	300 W

120V - 50/60Hz	Mode: 1 Workbench	Mode: 2 Workbenches
Flexible Arm Aspiration Intake	1	2
Stand Aspiration Intake	1	Not available
Flow per Flexible Arm Intake	80 m ³ / h (47.08 cfm)	75 m ³ /h (44.14 cfm)
Preset Aspiration Programs	3	3
Custom Aspiration Programs	10	10
Power Consumption	135 W	270 W

100V - 50/60Hz	Mode: 1 Workbench	Mode: 2 Workbenches
Flexible Arm Aspiration Intake	1	2
Stand Aspiration Intake	1	Not available
Flow per Flexible Arm Intake	80 m ³ /h (47.08 cfm)	65 m ³ /h (38.28 cfm)
Preset Aspiration Programs	3	3
Custom Aspiration Programs	10	10
Power Consumption	135 W	200 W

Maintenance and Filter Replacement

- The fume extractor unit indicates by means of display and LED's that the filters need to be replaced.
- To replace the filters remove the cover by opening the quick release levers, located on both sides of the casing.
- If the saturation indicator remains in red after replacing the pre-filter, it means that the compact filter is saturated and must also be replaced (see figure below).
- After replacing the compact filter, the carbon filter counter must be reset (Main Menu > Filter Set > Reset Carbon).
- The service life of the compact filter is a maximum of 1 year after opening its packaging.
- If the filter is changed while the fume extractor is switched on, the fume extractor unit automatically starts the filter detection process and activates the aspiration for a few seconds.

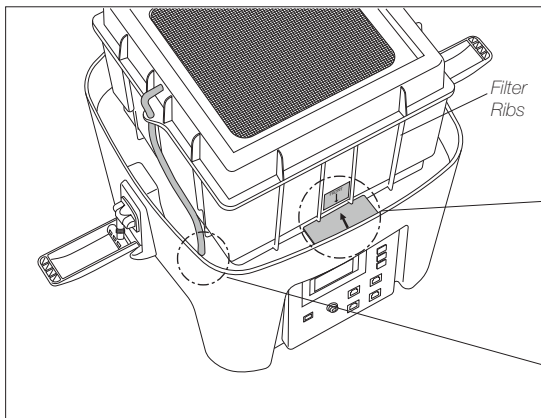
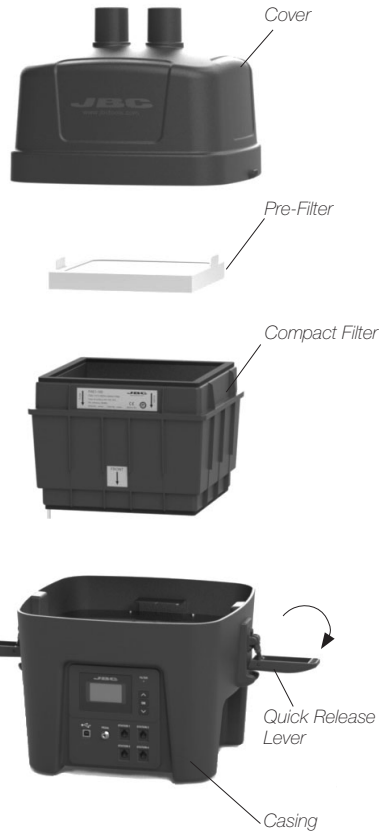

 The filter has a given position. Make sure the filter ribs mate with the corresponding slots.

Connect the filter tube to the quick-coupling placed on the metal sheet

Quick Release Lever Adjustment

- Turn clockwise to loosen and counterclockwise to tighten, in order to adjust the filter airtightness.

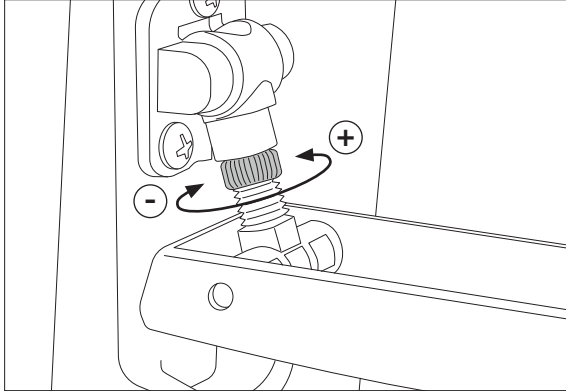

Accessories

FAE1100
Filter for FAE1

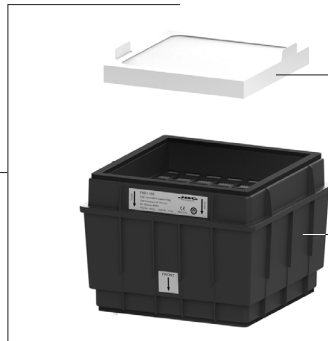

FAE1110
Pre-Filter for FAE1
*includes medium dust filter
M5 (EN 779)*

Compact Filter
*includes activated carbon
filter and particle filter HEPA
13 filter (EN 1822)*



Read the safety guidelines to do the equipment maintenance safely.

Safety



Follow safety guidelines to prevent electric shock, injury, fire or explosion.

- The equipment is designed to filtrate only the fumes generated by soldering.
- Do not use the units for the filtration of combustible, explosive or corrosive gases. Incorrect use may cause fire.
- The power plug must be plugged into approved bases. Be sure that it is properly grounded before use. When unplugging it, hold the plug, not the wire.
- Do not leave the appliance unattended when it is on.
- Do not cover the ventilation grills. Heat can cause flammable products to ignite.
- This appliance can be used by children over the age of eight and persons with reduced capabilities or lack of experience provided that they have been given adequate supervision or instruction concerning use of the appliance and understand the hazards involved.
- Maintenance must not be carried out by children unless supervised.
- Keep your workplace clean and tidy. Wear appropriate protective mask, safety goggles and gloves when handling polluted filters or pre-filters.
- Do not use the equipment without the filters.
- Saturated filters can not be cleaned and reused.
- Avoid blowing out the filter or the dirty parts of the equipment, if necessary it is recommendable to vacuum them.
- When handling the filter, avoid losing particles from the filter.
- Treat the saturated filters as waste depending on the filtered contaminant and the applicable standards in each country. This is the European Waste Catalogue classification:
 - 15 02: Absorbents, filter materials, wiping cloths and protective clothing.
 - 15 02 02: Absorbents, filter materials (including oil filters not otherwise specified), wiping cloths, protective clothing contaminated by dangerous substances.
 - 15 02 03: Absorbents, filter materials, wiping cloths and protective clothing other than those mentioned in 15 02 02.
- In case of not complying with the filter change recommendations, the maximum particle and gas concentrations established in each country could be exceeded.

Notes

Specifications

F AE1

Fume Extractor for 1 Workbench

Ref.: **F AE1-1C** 120V 50/60Hz. Input power: 270W. Fuse 4A

F AE1-2C 230V 50/60Hz. Input power: 300W. Fuse 2.5A

F AE1-9C 100V 50/60Hz. Input power: 200W. Fuse 4A

- Blower Type: Brushless
- Flow Rate: 230 m³/h (135 CFM)
- Max. Vacuum for 230V: 6 kPa (0.87 psi)
- Max. Vacuum for 120V: 4.3 kPa (0.62 psi)
- Max. Vacuum for 100V: 3.2 kPa (0.46 psi)

- Work Areas (Workbenches): 1 or 2
- Noise: 55 dB @ 1m *
**F AE1-2C with 1 Workbench configuration and Low aspiration program.*

- Pre-Filter: Medium Dust Filter M5 (EN 779)
- Compact Filter: Particle Filter HEPA 13 (EN 1822)
Activated Carbon Filter

- Connections: USB-B
Pedal connector
Station connectors RJ12 (4x)

- Total Net Weight: 10.87 kg / 23.96 lb

- Total Package Dimensions / Weight:
(L x W x H) 425 x 425 x 545 mm / 12.90 kg
16.73 x 16.73 x 21.46 in / 28.45 lb

Complies with CE standards.

ESD safe.

JBC

Warranty

JBC's 2 year warranty covers this equipment against all manufacturing defects, including the replacement of defective parts and labor.

Warranty does not cover product wear or misuse.

In order for the warranty to be valid, equipment must be returned, postage paid, to the dealer where it was purchased.

Get 1 extra year JBC warranty by registering here:
<https://www.jbctools.com/productregistration/>
within 30 days of purchase.

If you register, you will receive e-mail notifications about new software updates for your registered product.



This product should not be thrown in the garbage.

In accordance with the European directive 2012/19/EU, electronic equipment at the end of its life must be collected and returned to an authorized recycling facility.

CE EAC UK
CA

www.jbctools.com

0032497-180724