

JBC

www.jbctools.com



Nitrogen Kit

Ref. KNE-A

Packing List

The following items should be included:

Nitrogen Flow Regulator 1 unit
Ref. MNE-A



Stand 1 unit
Ref. DN-SE



Nitrogen Handle 1 unit
Ref. T245-NA



Nozzles 2 units
Ref. B7244 (x1)
B7968 (x1)



Cartridge 1 unit
Ref. C245903



ESD Tip Cleaner 1 unit
Ref. CL8499



Sponge 1 unit
Ref. S0354



Sponge 1 u
Ref. CL6210



Stand Cable 1 u
Ref. 0011283



Module Cable 1 u
Ref. 0014874



Manual 1 u
Ref. 0020524



Features

The KNE-A requires the GN-A generator or an available nitrogen supply at the operator's bench.

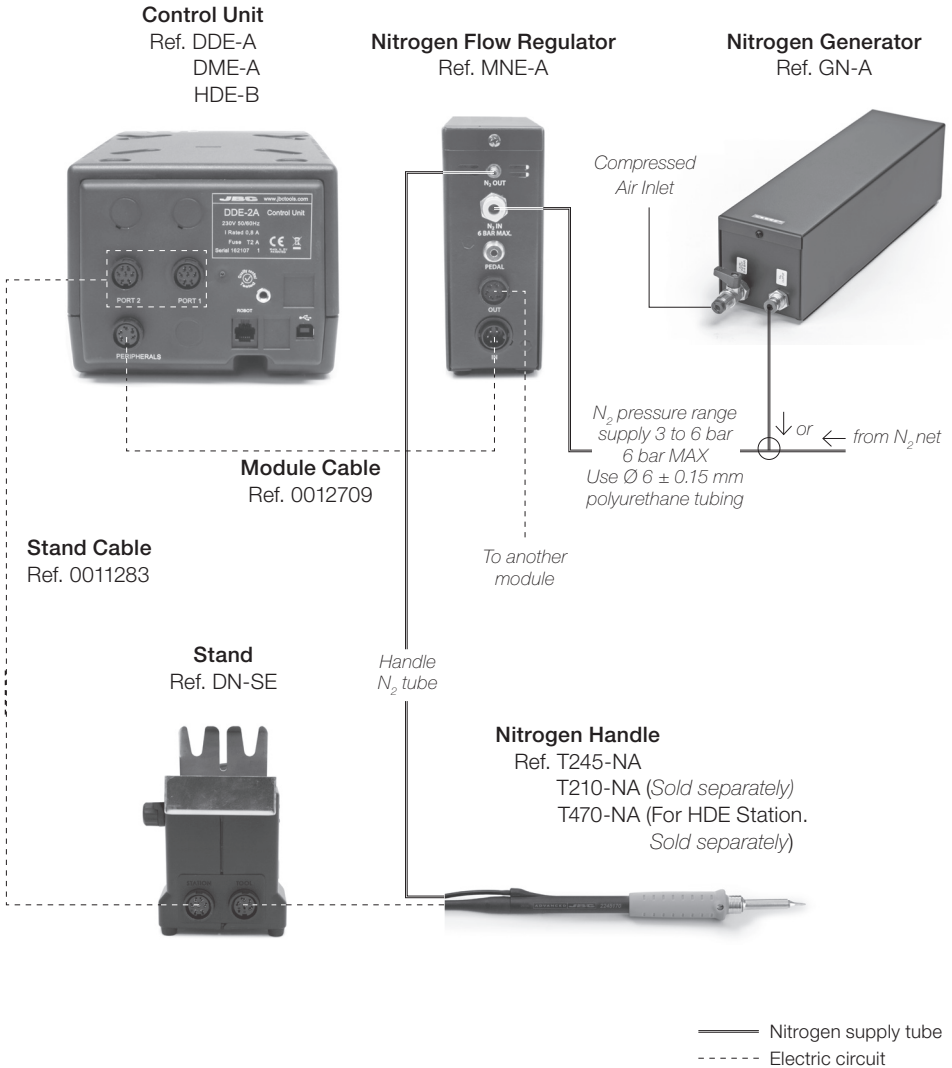

Initial Set up

For DDE and HDE Control Units

1. After connecting the MNE, enter the **Peripherals** Menu and select the port you want to join to the module.
2. Select the module from the list of peripheral connections. Remember your first connection is denoted as "a", the second as "b", etc. (e.g. MNE_a, MNE_b,...)
3. Press Menu or Back to save changes.

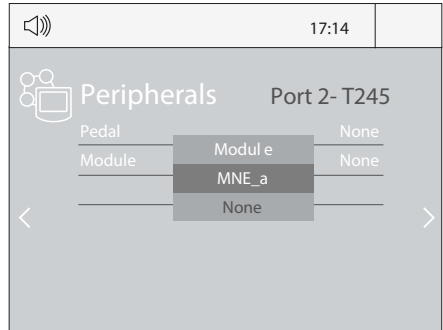

For DME Control Unit

When a new MNE is detected, a **pop-up screen** appears with instructions. If no screen appears, click on the **icon**  on the main bar and follow the steps.

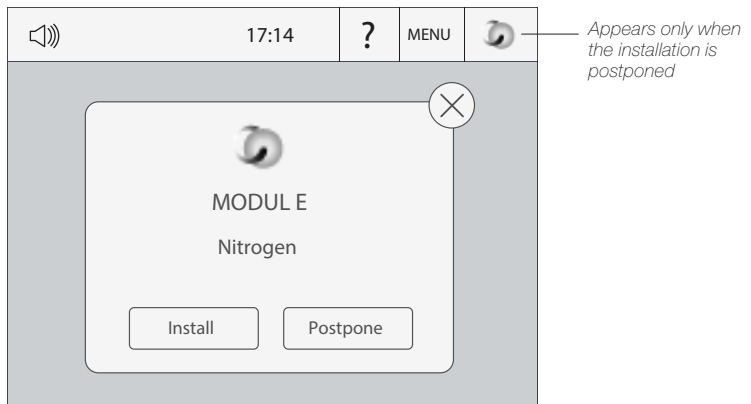

For both Control Units



Once set up, you can change the module settings by entering the **Peripherals Menu**.

Operation

Using nitrogen improves the quality of the solder joint as well as preventing tip oxidation. The MNE is an electrovalve that manages nitrogen flow. It is controlled by the station which keeps gas consumption to a minimum.

1. The nitrogen flow is automatically activated when the soldering iron is lifted from the stand.
2. The flow is interrupted when the tool is returned to the stand and the temperature drops for the tip to go into the Sleep mode.

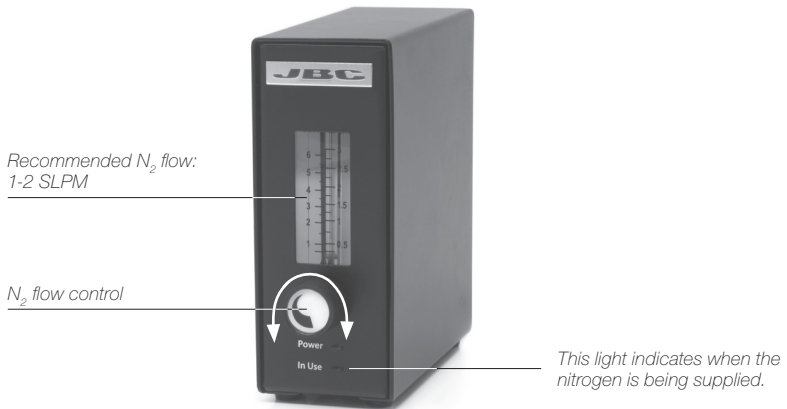

Accessories

Use the P-005 Pedal to **enable/disable** the module. This pedal will work with any module or tool regardless of the module to which it is connected.

Pedal
Ref. P-005

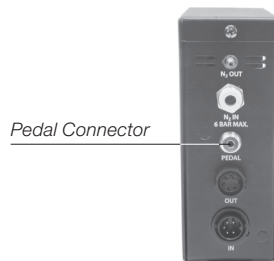

Maintenance

Before carrying out maintenance or storage, always allow the equipment to cool.

- Use a damp cloth to clean the casing, the stand and the tool. Alcohol can only be used to clean the metal parts.
- Check periodically that the metal parts of the tool/stand are clean so that the station can check the tool status.
- Maintain tip surface clean and tinned prior to storage in order to avoid tip oxidation. Rusty and dirty surfaces reduce heat transfer to the solder joint.
- Periodically check all cables and tube connections.
- Replace any defective or damaged parts. Use original JBC spare parts only.
- Repairs should only be performed by a JBC authorized technical service.



Safety



It is imperative to follow safety guidelines to prevent electric shock, injury, fire or explosion.

- Only nitrogen can be used with this unit.
- Do not use the unit for any purpose other than soldering or rework. Incorrect use may cause fire.
- The power cord must be plugged into approved bases. Be sure that it is properly grounded before use. When unplugging it, hold the plug, not the wire.
- Do not work on electrically live parts.
- The tool should be placed in the stand when not in use in order to activate the sleep mode. The soldering tip, the stand and the metal part of the tool may still be hot even when the station is turned off. Handle with care, including when adjusting the stand position.
- Do not leave the appliance unattended when it is on.
- Do not cover the ventilation grills. Heat can cause inflammable products to ignite.
- Avoid flux coming into contact with skin or eyes to prevent irritation.
- Be careful with the fumes produced when soldering.
- Keep your workplace clean and tidy. Wear appropriate protection glasses and gloves when working to avoid personal harm.
- Utmost care must be taken with liquid tin waste which can cause burns.
- This appliance can be used by children over the age of eight as well as persons with reduced physical, sensory or mental capabilities or lacking experience provided that they have been given adequate supervision or instruction concerning use of the appliance and understand the hazards involved. Children must not play with the appliance.
- Maintenance must not be carried out by children unless supervised.

Exploded View

KNE-A NITROGEN KIT



SPARE PARTS

MNE-A:

-CIRCUIT	0018457
-ENCLOSURE	
· TOP	0014074
· BOTTOM	0016082

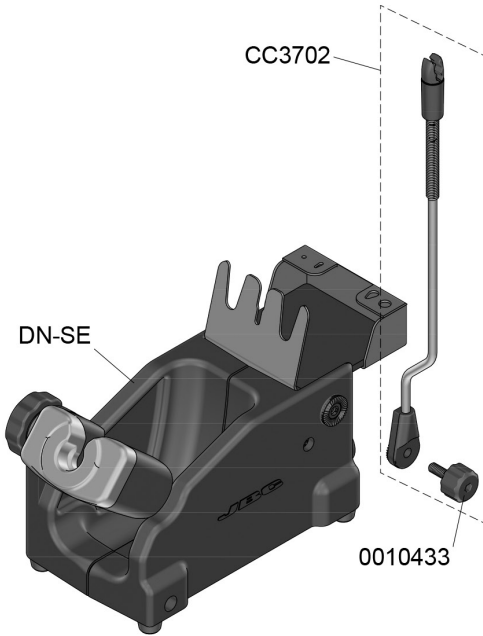
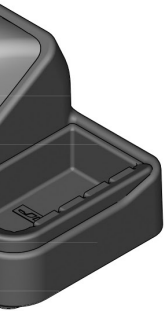

4

37244

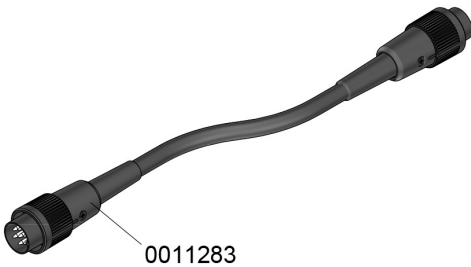

Specifications

- Weight: 3,7 kg (8.2 lb)
- Dimensions (MNE): 55 x 130 x 140 mm (2 x 5.1 x 5.5 in)
- Voltage (AC): 24V (from control unit)
- Power: 3W
- N₂ pressure range supply: 3-6 bar
- Maximum N₂ pressure: 6 bar
- N₂ flow regulation: 0.5 - 3 SLPM
- Recommended N₂ flow: 1-2 SLPM
- Ambient Operating Temperature: 10 - 40 °C (50 - 104 °F)

Complies with CE standards.
ESD protected housing.

JBC

Warranty

JBC's 2 year warranty covers this equipment against all manufacturing defects, including the replacement of defective parts and labour.

Warranty does not cover product wear or misuse.

In order for the warranty to be valid, equipment must be returned, postage paid, to the dealer where it was purchased.

Register your warranty within 30 days of purchase in www.jbctools.com/productregistration



This product should not be thrown in the garbage.

In accordance with the European directive 2002/96/EC, electronic equipment at the end of their life must be collected and returned to an authorized recycling facility.



Manual in other languages available on our website

www.jbctools.com