

JBC

www.jbctools.com

INSTRUCTION MANUAL



NH

High-Precision Heater Hose Set
for JNA

This manual corresponds to the following references:

NH-A

Packing List

The following items are included:

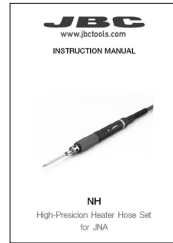

High-Precision Heater Hose Set 1 unit

Manual 1 unit
Ref. 0026662

Features and Connections

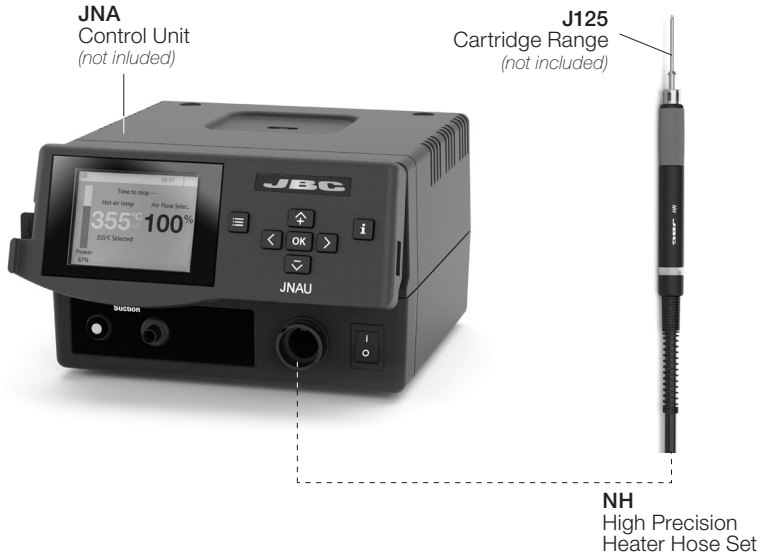

Changing the Cartridge

Save time and change the cartridge safely without switching the station off.

1. Removing

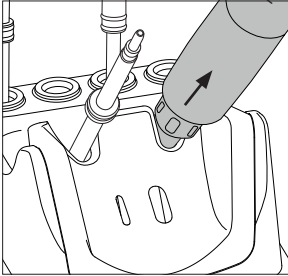

Place the cartridge in the extractor and pull the handle to remove it. Use the ring (J325) or umbrella (J125) around the cartridge as a stop to extract it from the tool.

2. Inserting

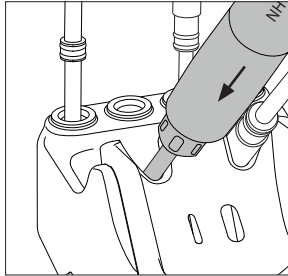

Place the handpiece on top of the new cartridge and press down slightly.

3. Fixing

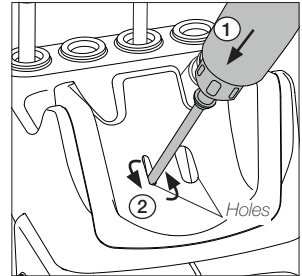

Use the holes to fix the cartridge at the right depth (1). The extractor holes also allows correcting the nozzle angle of curved cartridges. To do this, rotate the tool (2) with the cartridge inserted in the extractor until the nozzle is in the right position.

*Important

It is essential to insert the cartridge up to the mark for a proper connection.



Compatible Accessories *(Not included)*

Grips for NH High Precision Heater Hose Set *(Ref. 0024473)*

Soft foam grips ensure a better manual control of the tool and greater comfort when working. Easily replace the grips using the slip-on tabs.

1. Inserting Tabs

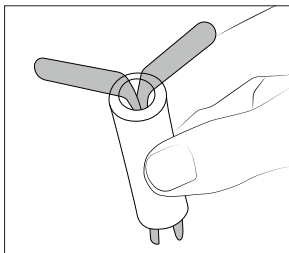

Insert the slide-on tabs into the new grip.

2. Inserting Handle

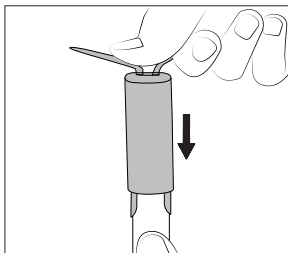

Push the grip with the tabs onto the handle.

3. Removing Tabs

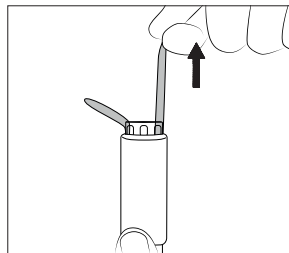

Hold the grip and pull them out. Use a pliers if necessary.

Maintenance

Before carrying out maintenance or storage, always unplug the stand from the station and the tool.

- Use a damp cloth to clean the stand. Alcohol can be used only when cleaning the metal parts.
- Check periodically that the metal parts of the tool/stand are clean so that the station can check the tool's status.
- Periodically check all cables and tube connections.
- Replace any defective or damaged parts. Use original JBC spare parts only.
- Repairs should only be performed by a JBC authorized technical service.

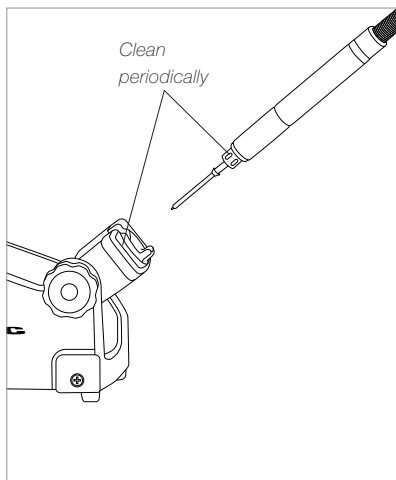

Safety



It is imperative to follow safety guidelines to prevent electric shock, injury, fire or explosion.

- Do not use the stands for any purpose other than soldering or rework.
- The power cord must be plugged into approved bases. Be sure that it is properly grounded before use. When unplugging it, hold the plug, not the wire.
- The tool should be placed in the stand when is not in use in order to activate the sleep mode. The soldering tip, the metal part of the tool and the stand may still be hot even when the station is turned off. Handle with care, including when adjusting the stand position.
- Avoid the contact of flux with skin or eyes to prevent irritation.
- Be careful with the fumes produced when soldering.
- Keep your workplace clean and tidy. Wear appropriate protection glasses and gloves when working to avoid personal harm.
- Utmost care must be taken with liquid tin waste which can cause burns.
- This appliance can be used by children over the age of eight and also persons with reduced physical, sensory or mental capabilities or lack of experience provided that they have been given adequate supervision or instruction concerning use of the appliance and understand the hazards involved. Children must not play with the appliance.
- Maintenance must not be carried out by children unless supervised.

Specifications

NH

High-Precision Heater Hose Set for JNA

Ref.: **NH-A**

- Net Weight 0.31 kg / 0.69 lb
- Total Package Dimensions/Weight: 382 x 159 x 81 mm / 0.45 kg
(L x W x H) 13.46 x 6.10 x 4.72 in / 0.98 lb

Complies with CE standards
ESD protected

JBC

Warranty

JBC's 2 year warranty covers this equipment against all manufacturing defects, including the replacement of defective parts and labour.

Warranty does not cover product wear or misuse.

In order for the warranty to be valid, equipment must be returned, postage paid, to the dealer where it was purchased.



This product should not be thrown in the garbage.

In accordance with the European directive 2012/19/EU, electronic equipment at the end of its life must be collected and returned to an authorized recycling facility.



www.jbctools.com

0026662-201023