



KANOMAX
The Ultimate Measurements

Digital Dust Monitor

Model 3444

User's Manual

List of Components

■ Standard

Items	Model	Quantity
Main Body	3444-00	1
Pump Filter	3444-60	Built-in:1 Spare:1
Purge Filter	3442-03	Built-in:1 Spare:1
Shoulder belt	-	1
AA Battery	-	6
LCD protection sheet	3444-61	1
USB cable	3444-20	1
Measurement Software	3444-40	1
User's Manual	-	1

■ Available Accessories

Items	Model
AC adapter	3444-10
USB cable	3444-20
Output cable (Analog)	3444-30
I/O cable (Communication)	3444-21
Pump Filter	3444-60
LCD protection sheet	3444-61
Protector	3444-70
Cover	3444-71
L-shape tripod bracket	3444-72
Tube connection inlet adapter	3444-73
Cyclone connection adapter	3444-74
Purge Filter	3442-03

Important Safety Information

The symbols for the warnings used in this manual are defined below:

Classifications



Danger

Warnings in this classification indicate a danger that may result in serious injury or death if not observed.



Caution

Warnings in this classification indicate a risk of damage to the product that may void the product warranty if not observed.

Important

This symbol indicates that the product may be subject to physical damage or performance may not be guaranteed if this symbol is ignored, and the product is handled improperly.

Description of Symbols



△ symbol indicates a condition that requires caution (including danger). The subject of each caution is illustrated inside the triangle (e.g., the high temperature caution symbol is shown on the left).



⊘ symbol indicates a prohibition. Do not take the prohibited action shown inside or near this symbol (e.g., the disassembly prohibition symbol is shown on the left).



● symbol indicates a mandatory action. A specific action is given near the symbol.

Danger



(Disassembly prohibited) Never disassemble, modify, or repair the product. Short circuits and adjustment malfunctions may cause performance to be unmaintained.



(Prohibition of use) When using AC power, use the optional dedicated AC adapter. Failure to do so may cause malfunction. There is a risk of overheating and ignition, which may lead to fire or accident.



(Prohibition of use) Do not use the main unit where the ambient temperature exceeds 40°C. Doing so may cause a short circuit or fire.



(Correct handling) Please follow the instructions in this instruction manual to use the product correctly. Improper use may cause electric shock, ignition, or damage.



If abnormal noises, smells or smoke occur, or if liquid enters the instrument, turn off the instrument immediately, and remove the batteries or pull out the plug. There is possibility of malfunction, electric shock, and/or fire. Please contact your local distributor or our service center for repair.

Caution



(Handle correctly) Always unplug the instrument from the electrical outlet when the instrument is not in use. Failure to do so may cause an electrical shock, fire or circuit damage.

(Handle correctly) When using the optional AC adapter, make sure there is no dust on the power plug. Check the power plug for dust. Use a dedicated 100-240 V outlet for the power supply. Failure to do so may cause ignition.

Important



(Prohibition) Do not measure this unit in a place with high temperature, low temperature, or high humidity. Also, do not leave the unit in direct sunlight for long periods of time.

The product may not operate properly outside the operating temperature range. Use within the operating range.



(Prohibited) Do not apply strong shocks to the unit or place heavy objects on it. Dropping or crashing may cause malfunction or damage.



(Prohibited) When cleaning, do not wipe the unit with solvents such as thinner or benzene.

The case may be deformed or altered. When the case gets dirty, wipe it dry with a soft cloth. If the case is heavily soiled, wipe it dry with a cloth moistened with neutral detergent.



(Prohibited) Do not touch the unit while it is charged.

It may affect the measured value or cause damage to the circuitry of the main unit.



(Prohibited) Do not move this unit suddenly from a cold to a warm place as this may cause condensation.

Even within the appropriate temperature and humidity range, condensation may occur due to sudden temperature changes. Dew condensation on metal parts may cause rust, which may lead to malfunction.



(Handle properly) When storing, store in a non-condensing location between -10 and 45°C (-10 and 45°F).



(Handle correctly) When using at high concentrations (100 CPM) or higher, clean the unit after each measurement.

Leaving the optical system unattended after measurement may cause contamination inside the optical system, resulting in incorrect measurement.



(Prohibited) When disposing of the product, do not throw it away with general garbage.

Dispose of the unit and optional AC adapter in accordance with applicable laws and regulations. Or please contact your distributor.

Laser class

This device is a Class 1 laser product based on the following standards.

- EN60825-1: 2014

CLASS 1 LASER PRODUCT
EN60825-1: 2014

Handling of Laser Light



DANGER-This device uses a Class 3B laser diode as the sensor light source inside the main case. Never open or close the main unit case or disassemble the internal optical components.

Wavelength	790nm
Maximum output	4.5mW
Beam radiation angle	20-45° (Vertical)
	8-15° (Horizontal)



CAUTION - Control or adjustment by procedures other than those specified here will result in hazardous laser radiation exposure.

Table of Contents

1. Part Names and Functions	8
1.1 Overview.....	8
1.2 Principle of Measurement	8
1.3 Part Names and Functions.....	9
1.4 How to attach the shoulder strap.....	12
2. Getting Started.....	13
2.1 Power supply.....	13
2.1.1 Installing Batteries.....	13
2.1.2 Connecting the AC adapter	13
2.2 Precautions during storage and transportation of the unit.....	15
2.3 Cleaning.....	16
2.4 User calibration.....	17
3. Screen Descriptions and Operating Procedures	18
3.1 Startup screen	18
3.2 Initial Screen.....	19
3.3 Screen during measurement.....	21
3.4 Menu	22
3.4.1 MEASURE MODE.....	23
3.4.2 CALIBRATION	36
3.4.3 FILE	38
3.4.4 UTILITY.....	41
3.5 Serial Communication	50
3.6 Measurement Procedure	51
4. Replacement of Consumables	52
4.1 Replacing the filter	52
4.1.1 Purge filter replacement	52
4.1.2 Pump filter replacement.....	53
4.2 Replacing the LCD protective sheet	54
5. Optional Products.....	55
5.1 Tube connection inlet adapter.....	55
5.2 Cyclone connection adapter	56
5.3 Tripod Fixing L Angle	57
5.4 Protector.....	58
5.5 Dust monitor Cover	59
5.6 Output cable (Analog).....	60

5.7 I/O cable (Communication).....	61
6. Specifications	62
7. Trouble Shooting	64
7.1 Check power	64
7.2 Checking during measurement.....	64
7.3 Background check.....	65
7.4 Sensitivity check.....	66
7.5 Calibration check.....	67
7.6 Analog output	67
7.7 Pulse output	68
7.8 Alarm output.....	68
7.9 Date and Time Setting	68
8. Warranty and After-Sales Service.....	69
9. Contact Information	70

1. Part Names and Functions

1.1 Overview

This product (Model 3444) is a light scattering portable dust monitor using a semiconductor laser light source. Measurement data can be displayed on the LCD screen and stored in the internal memory. Stored data can be read out with the included software.

<Features>

- With the use of pump-type suction, dust measuring in like asbestos environments are capable.
- Color LCD display used.
- User calibration can be performed by operating the screen and the sensitivity control knob.
- Free to read out measured data with data logging function.
- Uses non-volatile memory for storing calibration parameters and correction values
- Type-C USB interface and an included USB cable for communication.
- Can be powered by AA batteries or an optional AC adapter (3444-10).
- Be capable of outputting analog/pulse/alarm signal by using an optional output cable (3444-30), also capable for communicating with external devices.
- Capable with commercial camera tripod by using the tripod hole on side of the unit.

Also, attach an optional protector (3444-70) is capable for preventing the impact by falling.

※The protector cannot completely guarantee that the unit will not be damaged.

Depending on the environment and the level of fall, the unit could still be damaged even with a protector.

1.2 Principle of Measurement

By the scattering light generated by the laser light irradiating on the dust particles, is proportional to the mass concentration. The main unit could measure the mass concentration of dust particles suspending in the air.

1.3 Part Names and Functions

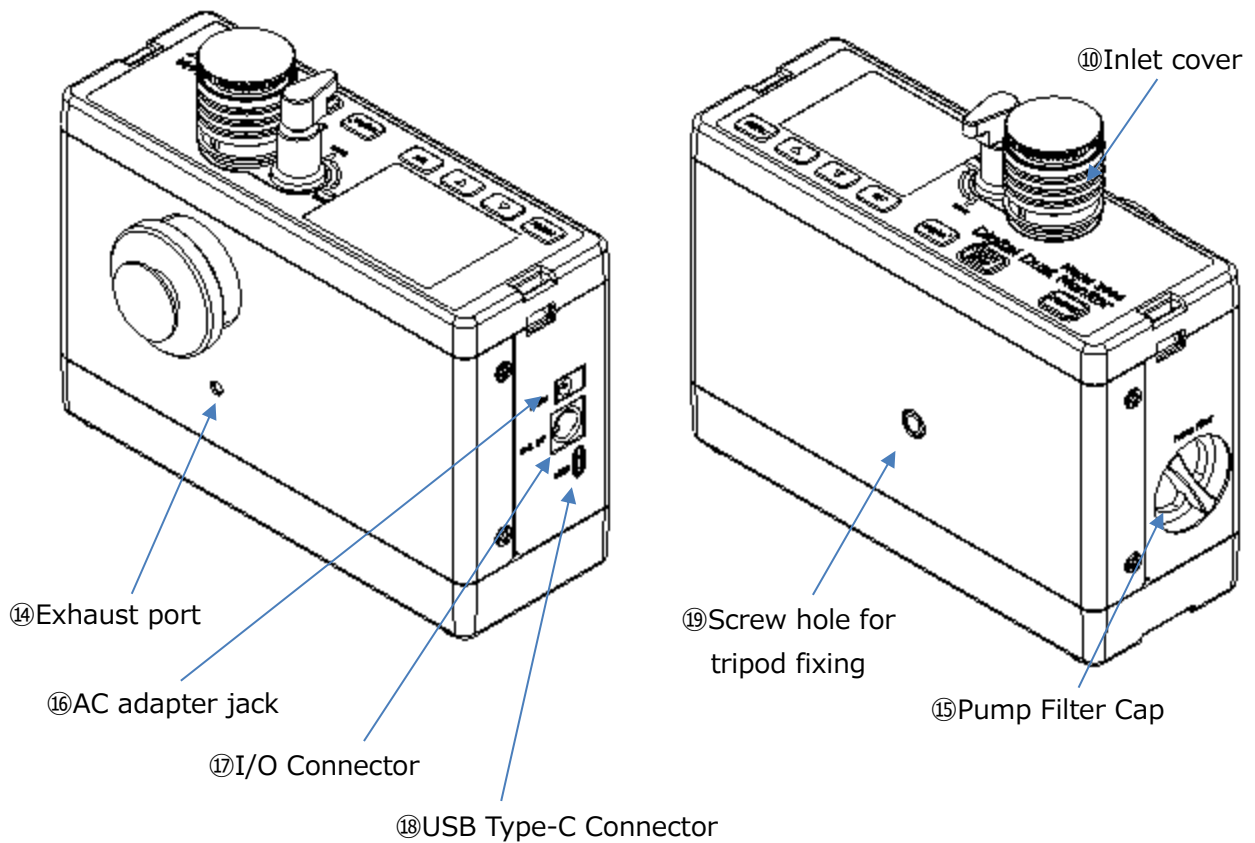
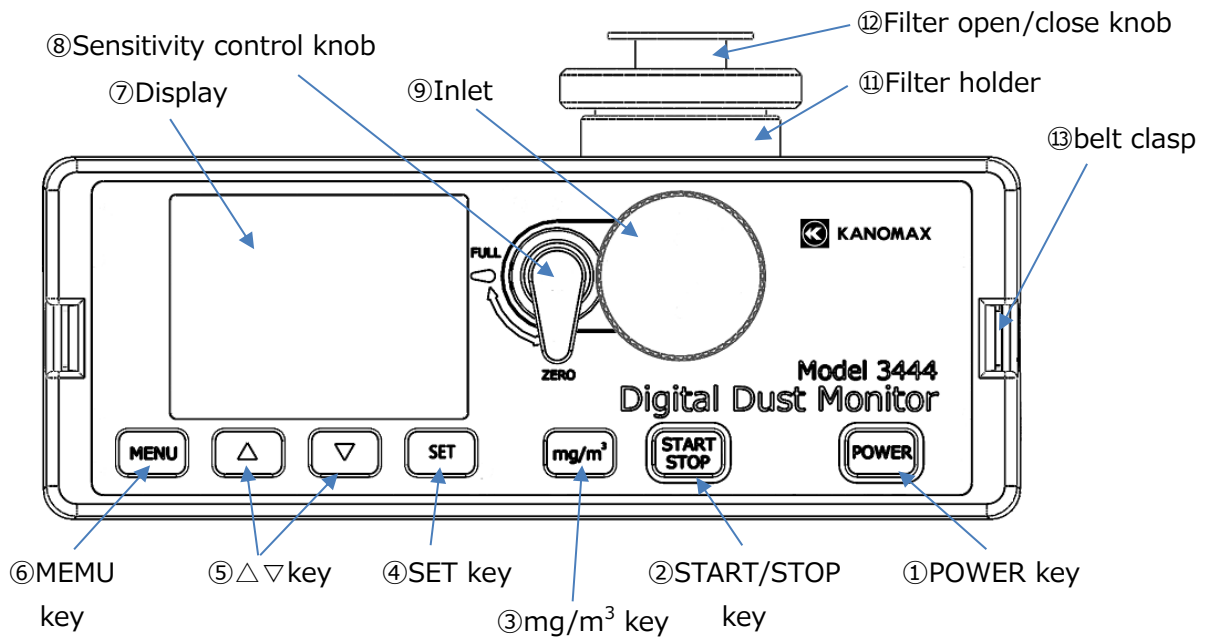

Name	Function
① POWER key	Turn power on/off
② START/STOP key	Start/stop measurement and cleaning.
③ mg/m ³ key	Displays the mass concentration after the measurement is completed in each measurement mode.
④ SET key	Set items and numerical values.
⑤ △▽ key	Select items and increase/decrease numerical values.
⑥ MEMU key	Calls up the menu screen.
⑦ Display	Displays measured values and menus
⑧ Sensitivity control knob	This knob is used for doing the sensitivity adjustment. Turn the knob toward to "FULL", check if there is any significant change in the standard CPM value. (Refer to "2.4 User Calibration.") Please keep the knob at the "ZERO" side except doing sensitivity adjustment. To switch the knob, please press the knob first and rotate it toward the side needed.
⑨ Inlet	Sample air inlet with a built-in filter inside for removing coarse particles.
⑩ Inlet Cover	The inlet can be closed and opened by moving it up and down. Raise (close) the cover for background adjustment, sensitivity adjustment, and cleaning.
⑪ Filter holder	There is a built-in filter used for background adjustment, sensitivity adjustment, and cleaning. (See "4.1.1 Replacing the purge filter" for details.)
⑫ Filter open/close knob	Pull out the knob when doing background adjustment, sensitivity adjustment, and cleaning.
⑬ Belt clasp	Attach the shoulder strap.
⑭ exhaust port	Air outlet of the internal pump. Do not block the air exhaust port when device is in operation.
⑮ Pump Filter Cap	A built-in filter inside for pump protection. (See "4.1.2 Replacing the pump filter" for replacement instructions.)
⑯ AC adapter jack	Connect the optional AC adapter (3444-10).

<p>⑰ I/O Connector</p>	<p>Connect the optional output cable (analog) (3444-30). Analog output: Outputs a voltage equivalent to 0 to 1 V for 0 to 1,000 CPM or 0 to 10,000 CPM. Analog output: A voltage equivalent to 0 to 1 V is output for 0 to 1,000 CPM or 0 to 10,000 CPM. Load impedance should be set at 1kΩ or higher. Instantaneous value will be outputted linearly in the range. Pulse output: Pulses equivalent to 0.0166 Hz to 166.6 Hz are output for 1 to 10,000 CPM. Photo-coupler output. (No-voltage output) Alarm output: Outputs when the alarm setpoint is exceeded. It is a photocoupler output (no-voltage output) and is turned on when an alarm is detected. RS-232C communication is available by connecting optional I/O cable (communication) (3444-31).</p>
<p>⑱ USB Type-C Connector</p>	<p>Connect the included USB cable for communication.</p>
<p>⑲ Screw hole for tripod fixing</p>	<p>Use this screw to secure the main unit to the tripod. (Screw hole diameter 1/4-20UNC)</p>

1.4 How to attach the shoulder strap

Pass the end of the shoulder belt through the hole in the belt clasp of the dust monitor, fold it back and secure it through the shoulder belt attachment. Adjust the length of the shoulder strap by the length of the belt that goes through the attachment.

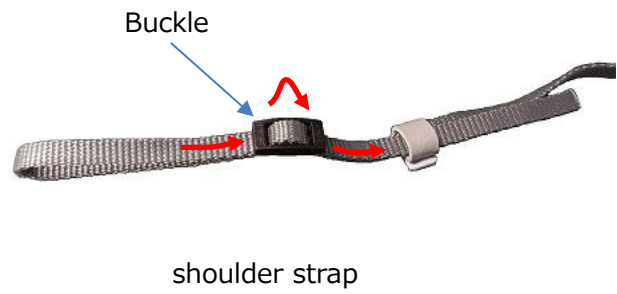
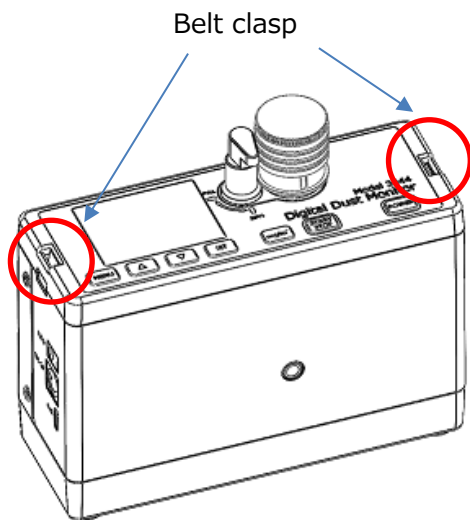

2. Getting Started

2.1 Power supply

The instrument can be powered by batteries or an optional dedicated AC adapter (3444-10). Please set the battery or optional AC adapter.

2.1.1 Installing Batteries

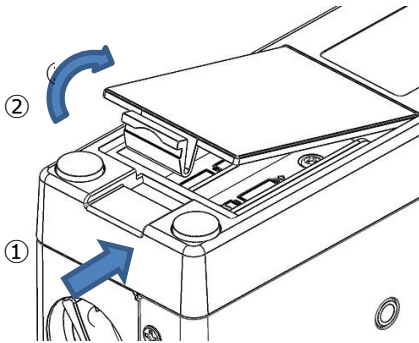

- ① Press the battery box lid claw in the direction of the arrow.
- ② Lift the lid in the direction of the arrow while holding the claw.

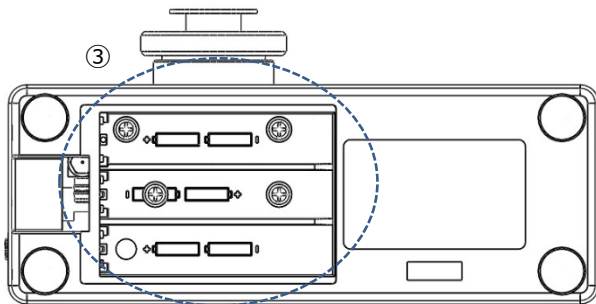

- ③ Insert the battery. (*Please set the battery polarity correctly.)

Use 6 AA manganese, alkaline, or Ni-MH batteries. Be sure to use the same type of batteries. Using a combination of different types of batteries may cause leakage or damage to the main unit.

When replacing batteries, be sure to replace all batteries with new ones. Mixing used old batteries with new batteries may shorten the usable time, cause leakage, or damage the main unit.

*The AC adapter cannot be used to charge batteries.

- ④ Close the lid in the reverse order.

*To avoid contact failure due to battery corrosion, remove the batteries from the battery box when not in use for an extended period of time.

Types of batteries that can be used

- Manganese battery (AA type)
- Alkaline battery (AA type)
- Ni-MH battery (AA type)

2.1.2 Connecting the AC adapter

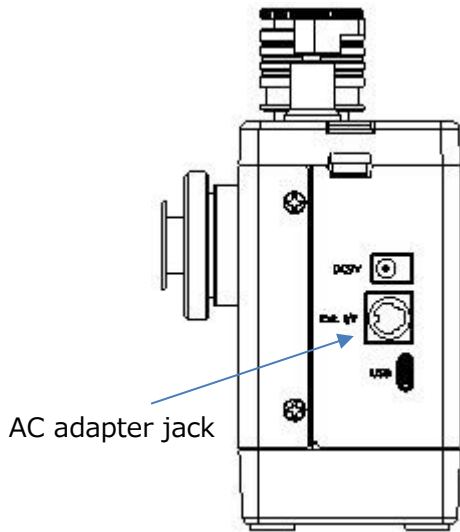

Insert the AC adapter into the AC adapter jack on the side of the main unit.

The AC adapter has priority to the batteries. Please remove the batteries from the box if not in use for a long period, or it may cause contact failure due to battery corrosion.



Warning: Please use the optional dedicated AC adapter (Model 3444-10) as it may cause malfunction.

◆ Battery level

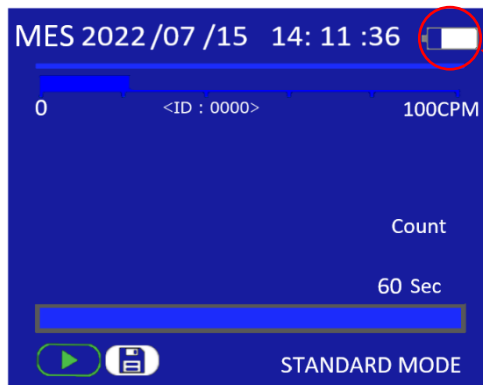

The remaining battery level is displayed in the upper right corner of the screen.

Battery level display

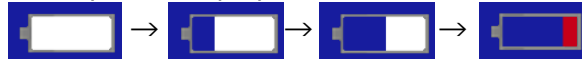

As the battery decreases, the display changes as shown above.

the AC adapter in use



<<Caution>>

The remaining battery charge is displayed in 10 levels. When the remaining battery charge is low, the battery display would turn out to red.

Please connect the optional AC adapter (3444-10) instead or stop the measurement and replace the batteries with new ones.

The display(measurement) will be shut down when run out of battery.

2.2 Precautions during storage and transportation of the unit

- ◆ Precautions for storing the main unit



CAUTION: When not in use for an extended period of time, remove the battery in use from the battery compartment. Corrosion of the batteries may cause contact failure.

- ◆ Precautions for transporting the main unit



CAUTION: If you are shipping the unit, please remove the batteries from the battery compartment as described above.

CAUTION: When transporting the main unit by yourself, remove the battery in use from the battery box in the same manner as described above.

2.3 Cleaning

To maintain the accuracy of instrument, the instrument must be cleaned before use.

(In the case of a one-day use, please clean before and after the first and last measurement.)

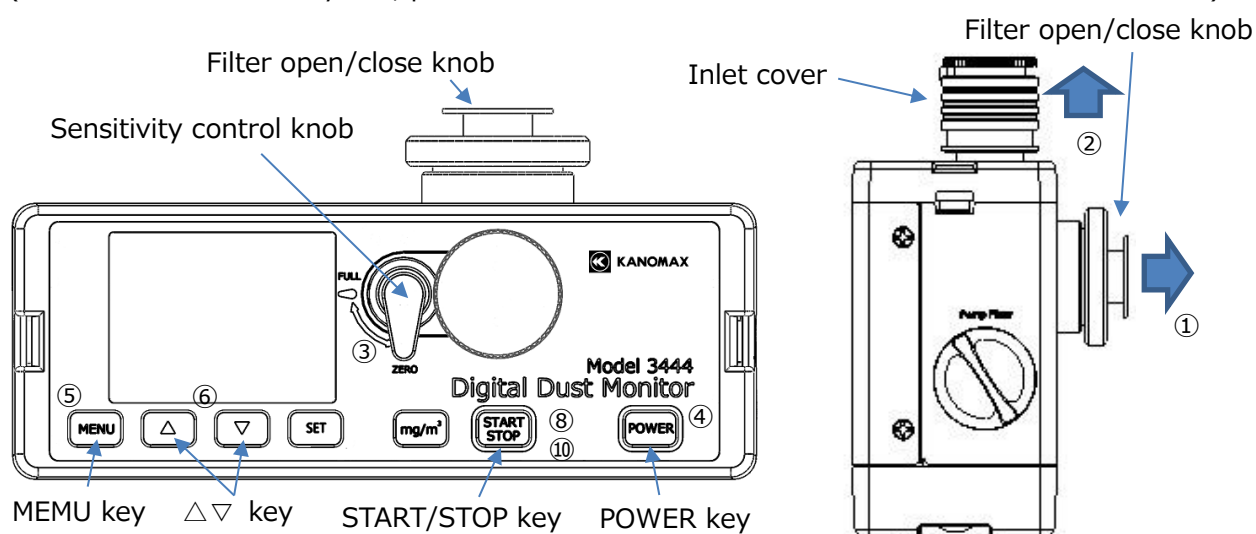

- ① Make sure the ambient atmosphere is clean and pull out the filter open/close knob.
- ② Raise the inlet cover up and then turn it clockwise to lock it.
- ③ Set the sensitivity control knob to the "ZERO" side.
- ④ Press the [POWER] key to turn on the power.
- ⑤ Press the [MENU] key to display the menu screen.
- ⑥ Press the [∇] key (or the [Δ] key), move the cursor to "Utility" and press the [SET] key to enter the Utility screen.
- ⑦ Move the cursor to "Cleaning" and press the "SET" key to enter the cleaning screen.
(See 3.4.4 A) Cleaning.)
- ⑧ Press the [START/STOP] key to start cleaning.
- ⑨ Clean the unit for 5 minutes.
*The time required for cleaning varies depending on the operating environment.
- ⑩ Press the [START/STOP] key to finish cleaning.

*To minimize the time spent for cleaning as much as possible, please clean the optical system by the method described above immediately after measurement if the measurement was performed in a high concentration environment (100 CPM or higher) or a long continuous measurement.

If the instrument is left without cleaning, residual dust may accumulate inside the optical system, resulting in reduced measurement accuracy or calibration failure.

*Cleaning should be performed in a clean place.

Also please do not start the cleaning when someone is smoking nearby.

It may cause errors and damage the instrument.

2.4 User calibration

To maintain the accuracy of instrument, please perform user calibration before use.

(In the case of a one-day use, please do the user calibration before the first measurement.)

User calibration includes background adjustment and sensitivity adjustment (SPAN).

Please run background adjustment and sensitivity adjustment in the order.

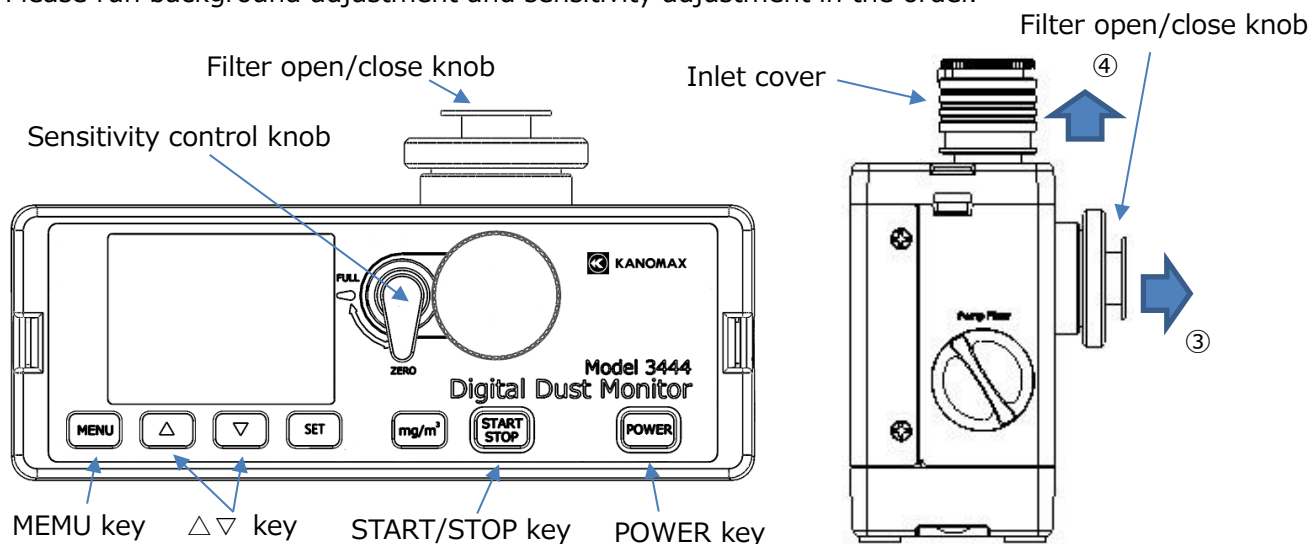

- ① Please finish the cleaning process (see “2.3 Cleaning”) before starting user calibration.
- ② Please warm up the instrument (over 20 minutes) before starting user calibration, or the calibration may not be performed precisely.
- ③ Pull out the filter open/close knob.
- ④ Raise the inlet cover up and then turn clockwise to lock it up.
- ⑤ Please do the background adjustment first, switch the sensitivity control knob to “ZERO” side.
- ⑥ Press the [MENU] key to display the menu screen.
- ⑦ Press the [▽] key (or the [△] key), move the cursor to “User Calibration” and press the [SET] key to display the User Calibration screen. (Refer to 3.4.2 User Calibration.)
- ⑧ And then do the sensitivity adjustment. Set the sensitivity control knob to “FULL” side.
- ⑨ Execute steps ⑥ and ⑦ above.
- ⑩ After finishing all the adjustments, set the sensitivity control knob back to “ZERO” side.

*Be sure to perform user calibration before measurement if the instrument is used under severe conditions (high concentration) or if it is frequently used.

*Please must do the cleaning process and warm up the instrument (over 20 mins) before starting calibration.

Note that calibration cannot be performed accurately if the warm-up operation is not sufficient.

*If a “Calibration error” message appears on the display, please perform the cleaning process again.

3. Screen Descriptions and Operating Procedures

3.1 Startup screen

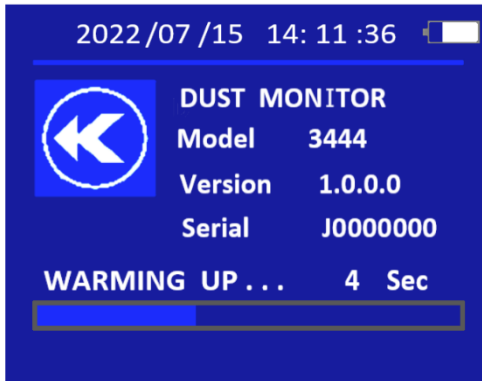

Press the [POWER] button to turn on the power, which will display the startup screen and warm up the unit for 10 seconds.

Screen will display the model's name, version, serial number and remaining warm-up time.

3.2 Initial Screen

After the warm-up is completed, the screen shown below will be displayed.

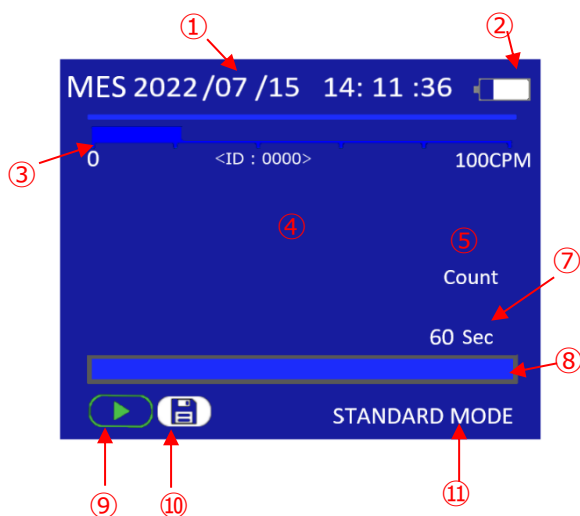



<Explanation of each part>

- ① Date, time
- ② Battery level
(See "2.1 Power supply")
- ③ Relative concentration bar
- ④ Measure value
- ⑤ Unit
- ⑥ Time graph during measurement
- ⑦ Remaining time of measurement

The remaining time will be updated together with the bar graph below when starting a measurement.

In manual mode, it will show the elapsed time instead.

- ⑧ Bar graph
Indicates the time remaining for measurement. Bar graph is not displayed in manual mode.
- ⑨ Measurement state

standby	under measurement
	

- ⑩ Save setting

ON	OFF
	

***Data can only be saved in standard and calculate mode.**

Data saving will be turned off when other modes are selected.

Data will not be saved if you start measurement with data saving OFF.

- ⑪ Measurement mode

The selected measurement mode is displayed.

- Standard mode
- Free mode
- Manual mode
- TWA (Time Weighted Average) mode
- Calculation mode

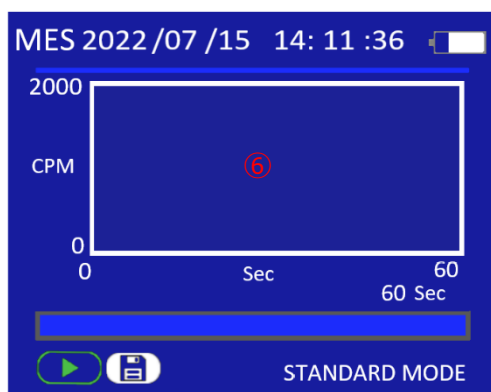

<Key Instruction>

Key	Operation
[START/STOP]	Starts and stops the measurement.
[mg/m ³]	Press after the measurement finished to display the mass concentration.
[MENU]	Open menu.

(See "3.4 Menu")

<Measurement Mode>

There are five measurement modes, all the modes could be set on the menu screen.

(See "3.4.1 Measurement Mode")

1. Standard mode Measurement is performed with a predetermined measurement time. The measurement time can be selected from 6, 10, 30 seconds or 1, 2, 3, 5, 10 minutes. *Measurement results are stored in memory.
2. Free mode Enter a measurement time to perform the measurement. The measurement time can be set from 1 to 59 seconds or 1 to 99 minutes. *Data cannot be saved.
3. Manual mode Start and end measurement manually. After starting measurement, press the [START/STOP] key to end measurement. *Data cannot be saved.
4. TWA mode Measurement is performed under the set conditions. Data cannot be saved. The conditions to be set are as shown in the table below. *Data cannot be saved.

Terms	Setting
Measurement Time	1min~48hours(per minute)
TLV-C(Upper value)	0.001~10.000mg/m ³ (C> STEL)
TLV-STEL(Short-Time Exposure Limits)	0.001~10.000mg/m ³ (C> STEL> TWA)
TLV-TWA(Time weighted average)	0.001~10.000mg/m ³ (TWA < STEL)
Alarm	ON/OFF

5. Calculation mode Repeat measurement is performed under the set conditions. The measurement results are stored in memory. The conditions to be set are shown in the table below.

Terms	Setting
Date and time to start measurement	Time since present~2099/12/31/23:59:59
Measurement Time	1s~99min 59s
Number of measurements	1~65535

Saved data can be viewed from the menu screen. (See "3.4.3 Data Display")

3.3 Screen during measurement

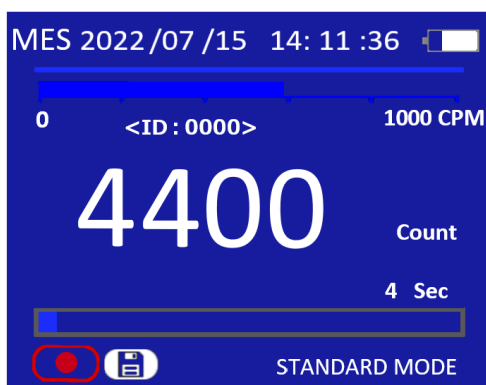

During measurement, the total number of particles counted and the instantaneous value corresponding to the relative concentration per minute (CPM: Count Per Minute) are displayed in the indicated value position and concentration bar graph, respectively.

The remaining time of measurement is displayed on the time bar graph and the remaining time display.

The time bar graph and the remaining time display show the remaining time of measurement.

The number of counts that can be measured by this unit is from 0 to 999,999. If the count exceeds this number, "OVER" message will be displayed on the screen.

*When the "over" message is displayed, pressing the [mg/m3] key will not convert the data.
 *When measuring in high concentration or for a long time, be sure to clean the inside of the optical system by performing the cleaning process.

In manual mode, the elapsed time of measurement will be displayed instead of the remaining time.

In Calculation mode, (number of measurements made/total number of measurements) will be displayed at the upper left position of the bar graph.

<Key Instruction>

Key	Operation
[START/STOP]	Start/Stop measurement.
[△][▽]	Switch graph display.

(See "3.4 Menu")

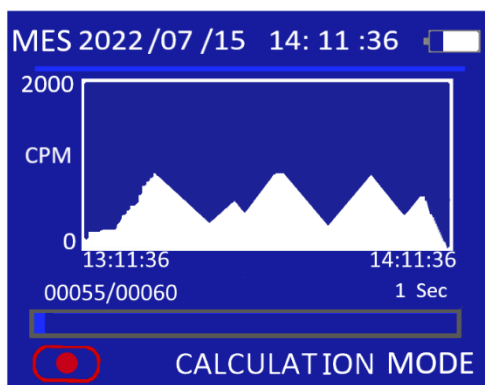

When in Calculation mode, the results of repeated measurements can be displayed in sequential graphs. The vertical axis is CPM and the horizontal axis is measurement time (Sec).

Data for a maximum of 60 measurements is displayed. If more than 60 measurements are taken, the latest 60 data points are displayed.

<Key Instruction>

Key	Operation
[△][▽]	Switches between graphical and numerical display.

3.4 Menu

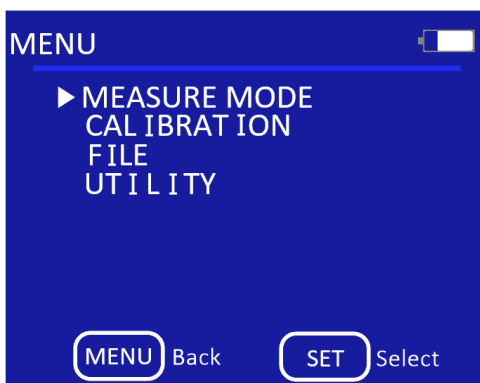

Press the [MENU] key on the initial screen displays the menu screen.

On the menu screen, the following items can be selected.

Item	Description
MEASURE MODE	Sets the measurement mode. (See "3.4.1 Measurement Mode")
CALIBRATION	User background adjustment and sensitivity adjustment (SPAN). (See "3.4.2 User Calibration")
FILE	Display and delete the stored data in the main unit's memory. (See "3.4.3 Files")
UTILITY	Perform cleaning, user calibration, and the settings of the main unit (See "3.4.4 Utility")

<Key Instruction>

Key	Operation
[MENU]	Return to the initial screen.
[△][▽]	Move the cursor up or down.
[SET]	Enter the screen of the item indicated by the cursor.

3.4.1 MEASURE MODE

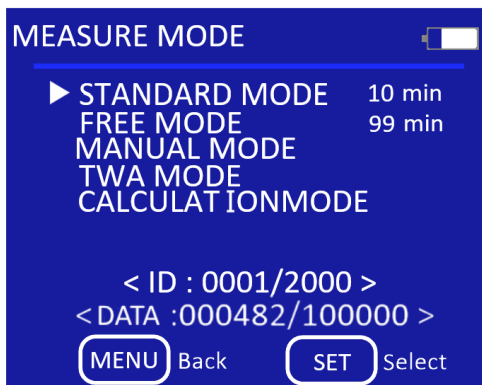

When enter the “MEASURE MODE” screen, the screen shown on the left will be displayed.

On this screen, you can select a measurement mode from the following five modes.

- STANDARD MODE
- FREE MODE
- MANUAL MODE
- TWA MODE
- CALCULATION MODE

Use the [Δ][∇] keys to move the cursor up or down and the [SET] key to select.

*Note that you must use the [SET] button to save the new settings.

A) STANDARD MODE

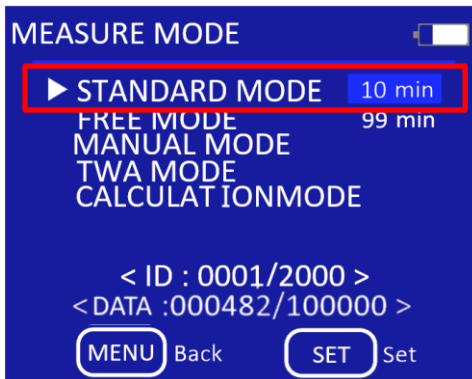

In "STANDARD MODE", the required measurement time must be set in advance.

The selectable measurement times are 6, 10, 30 seconds or 1, 2, 3, 5, 10 minutes.

When pressing the [SET] key on the "STANDARD MODE", the background color of the time setting field will be highlighted, then it is capable to use [Δ][▽] keys to change the time setting.

Measurement Time

6sec

[Δ]key ↓ ↑ [▽]key

10sec

[Δ]key ↓ ↑ [▽]key

30sec

[Δ]key ↓ ↑ [▽]key

1min

[Δ]key ↓ ↑ [▽]key

2min

[Δ]key ↓ ↑ [▽]key

3min

[Δ]key ↓ ↑ [▽]key

5min

[Δ]key ↓ ↑ [▽]key

10min

[Δ]key ↓ ↑ [▽]key

6sec

Move the cursor to "STANDARD MODE" and press the [SET] key to set the measurement time.

Use [Δ][▽] keys to select the required measuring time, press the [SET] key to save the setting and display the measurement screen.

*Measurement data will be stored in memory.

Press [MENU] key to leave the setting screen.

*Setting will not be saved.

B) FREE MODE

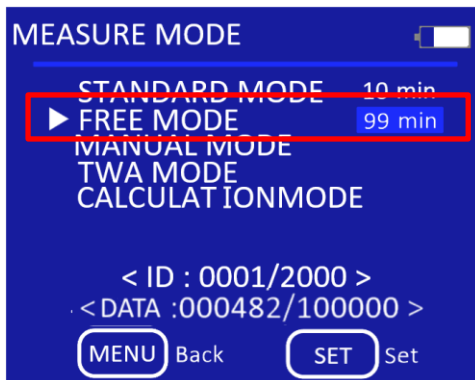

In "FREE MODE", the measurement time can be set in 1-second increments for the range of 1~59 seconds and in 1-minute increments for the range of 1~99 minutes. While the time setting is highlighted, use the [Δ][▽] keys to change the measurement time.

Measurement Time

01sec

[Δ]key 1sec UP ↓ ↑ [▽]key 1sec DOWN

01min

[Δ]key 1min UP ↓ ↑ [▽]key 1min DOWN

99min

Move the cursor to "FREE MODE" and press the [SET] key. The measurement time can be set.

Use the [Δ][▽] keys to change time setting, press the [SET] key to save the setting and display the measurement screen

*Measurement data cannot be saved at this mode.

Press [MENU] key to leave the setting screen.

*Setting will not be saved.

C) MANUAL MODE

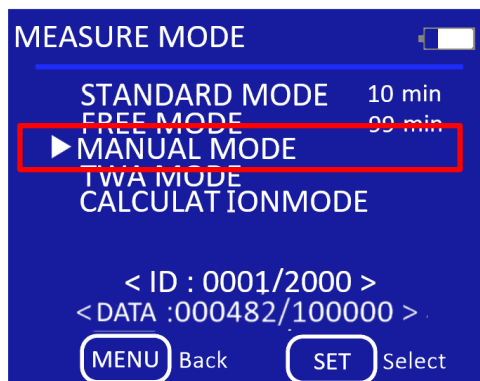

Move the cursor to "MANUAL MODE" and press the [SET] key to enter the measurement screen.

In "MANUAL MODE", measurement can be started and stopped by pressing the [START/STOP] key at any timing.

*Measurement data cannot be saved at this mode.

D) TWA MODE

In TWA (Time Weighted Average) MODE, this function measures the time-weighted average concentration and notifies the user with an alarm when it exceeds a set threshold value. There are three types of threshold values can be set as following.

TLV-C value, which is the concentration that must not be exceeded even momentarily.
 TLV-STEL value, which is the concentration that must not be exceeded in the latest 15-minute time weighted average.

TLV-TWA value, which is the concentration that must not be exceeded in the time weighted average from the beginning to the end of the measurement.

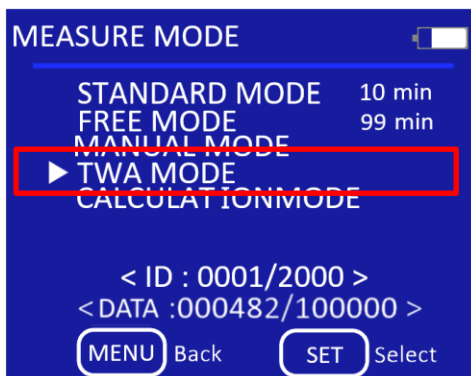

Move the cursor to "TWA MODE" and press the [SET] key to move to the setting screen.

Key	Operation
[MENU]	Returns to the "MEASURE MODE" screen.
[△][▽]	Move the cursor up or down.
[SET]	Select the item indicated by the cursor.
[MENU] (Selecting)	Undo the setting and cancel the selected state.
[△][▽] (Selecting)	Change the currently selected value.
[SET] (Selecting)	Apply the change.

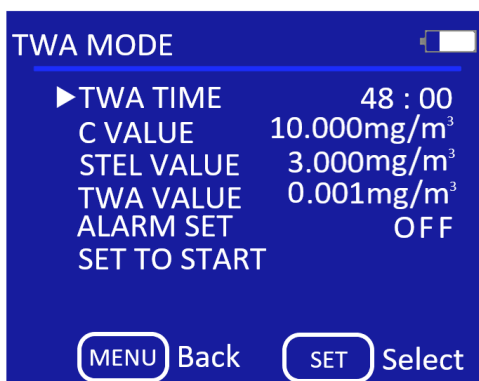

Item	Description
TWA TIME	1min~48hour (per minute)
C VALUE (Upper value)	0.001~10.000mg/m ³ (C> STEL)
STEL VALUE (Short-Time Exposure Limits)	0.001~10.000mg/m ³ (C> STEL> TWA)
TWA VALUE (Time weighted average)	0.001~10.000mg/m ³ (TWA<STEL)
ALARM SET	ON/OFF
SET TO START	Start measurement with the settings

1) TWA TIME

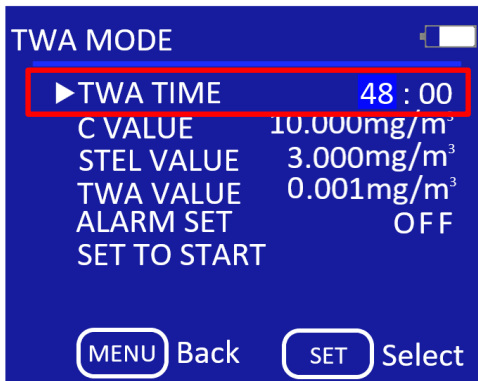

Set the value in the order of hours → minutes.

Use the [Δ][∇] keys to move cursor/change value.

Use [SET] key to select/set next value/apply the change.

[MENU] key to cancel/return.

The input range of the measurement time is from 1 minute to 48 hours, and the setting is made in units of 1 minute.

2) C VALUE (Threshold Limit Value - Ceiling : Upper value)

The TLV-C alarm will sound if the instantaneous (one sampling) concentration (mg/m³) exceeds the set value. And a message "C-ALARM" will be displayed on the screen.

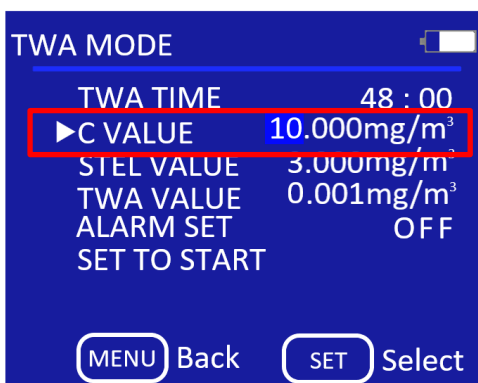

Set the value in the following order: integer part → first decimal place → second decimal place → third decimal place.

Use the [Δ][∇] keys to move cursor/change value.

[SET] key to select/set next value/apply the change.

[MENU] key to cancel/return.

*The input range of TLV-C value setting value can be set from 0.001 to 10.000 mg/m³.

The ceiling value cannot be set smaller than the TLV-STEL setting value.

*Due to the upper limit of 10.000 mg/m³, if "10" is entered at the integer part, the decimal part will be fixed at 0.

*If the ceiling value is set lower than the TLV-STEL value, the value will be automatically adjusted to TLV-STEL set value +0.001.

3) STEL VALUE (Threshold Limit Value - Short Term Exposure Limit : Short-Time Exposure Limits)

The TLV-STEL alarm will sound when the latest 15-minute moving average concentration (mg/m³) exceeds this set value.

And a message "S-ALARM" will be displayed on the screen.

Also, the alarm will go off if the concentration exceeds the TLV-TWA set value over 5 times within 8 hours, or the concentration exceeds the TLV-TWA set value at the last 60 minutes of the measurement. If the set measurement time is less than 8 hours, the set time will be applied as is.

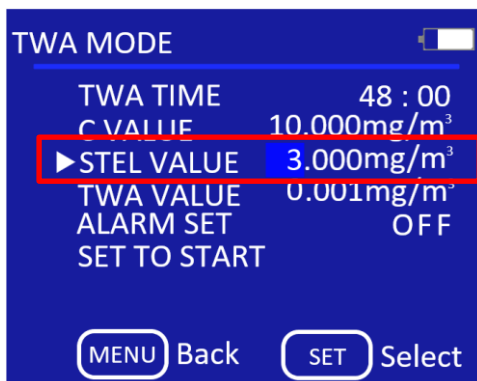

Set the value in the following order: integer part → first decimal place → second decimal place → third decimal place.

Use the [△][▽] keys to move cursor/change value.

Use [SET] key to select/set next value/apply the change.

[MENU] key to cancel/return.

*If the STEL value is set to "10" at the integer part, the value will be cut down automatically to the TLV-C set value -0.001.

*If the STEL value is set higher than the TLV-C value, the value will be automatically adjusted to TLV-C set value -0.001.

*If the STEL value is set lower than the TLV-TWA value, the value will be automatically adjusted to TLV-TWA set value +0.001.

4) TWA VALUE (Threshold Limit Value - Time Weighted Average: Time weighted average)

The TLV-TWA alarm will sound when the average concentration (mg/m³) from the start to the end of measurement in TWA mode exceeds the set value.

And a message "T-ALARM" will be displayed on the screen.

If the set measurement time is less than 8 hours, the set time will be applied as is.

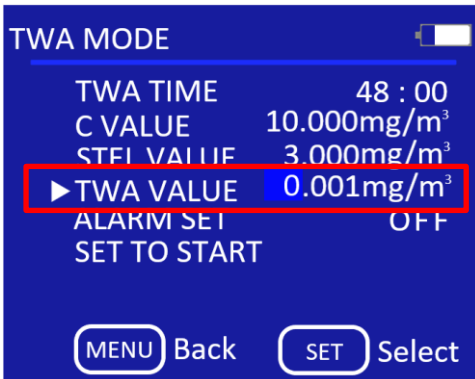

Set the value in the following order: integer part → first decimal place → second decimal place → third decimal place.

Use the [Δ][▽] keys to move cursor/change value.

Use [SET] key to select/set next value/apply the change.

[MENU] key to cancel/return.

*If the [SET] key is pressed when the integer part is 10, the value is automatically adjusted to the TLV-STEL setting value of -0.0001 and the display will be normal.

*The TLV-TWA setting value can be set from 0.001 to 10.000 mg/m³.

5) ALARM SET

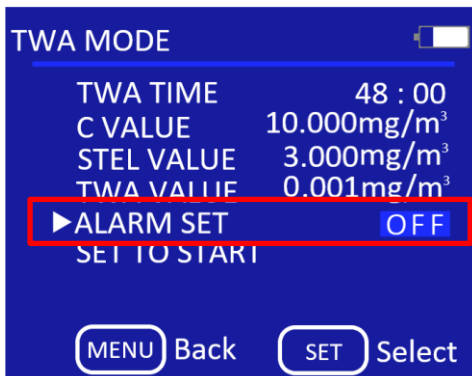

Set alarm ON/OFF.

6) SET TO START

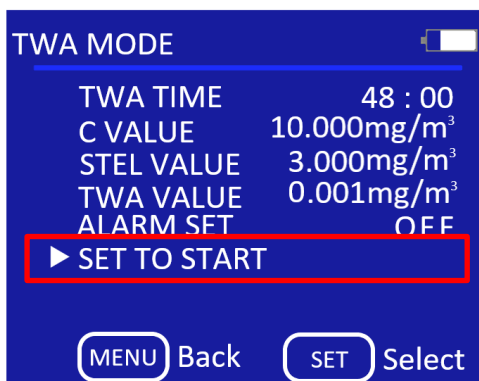

Start measurement with the set contents.

*Data cannot be saved.

<Alarm Condition>

<TLV-TWA Alarm>

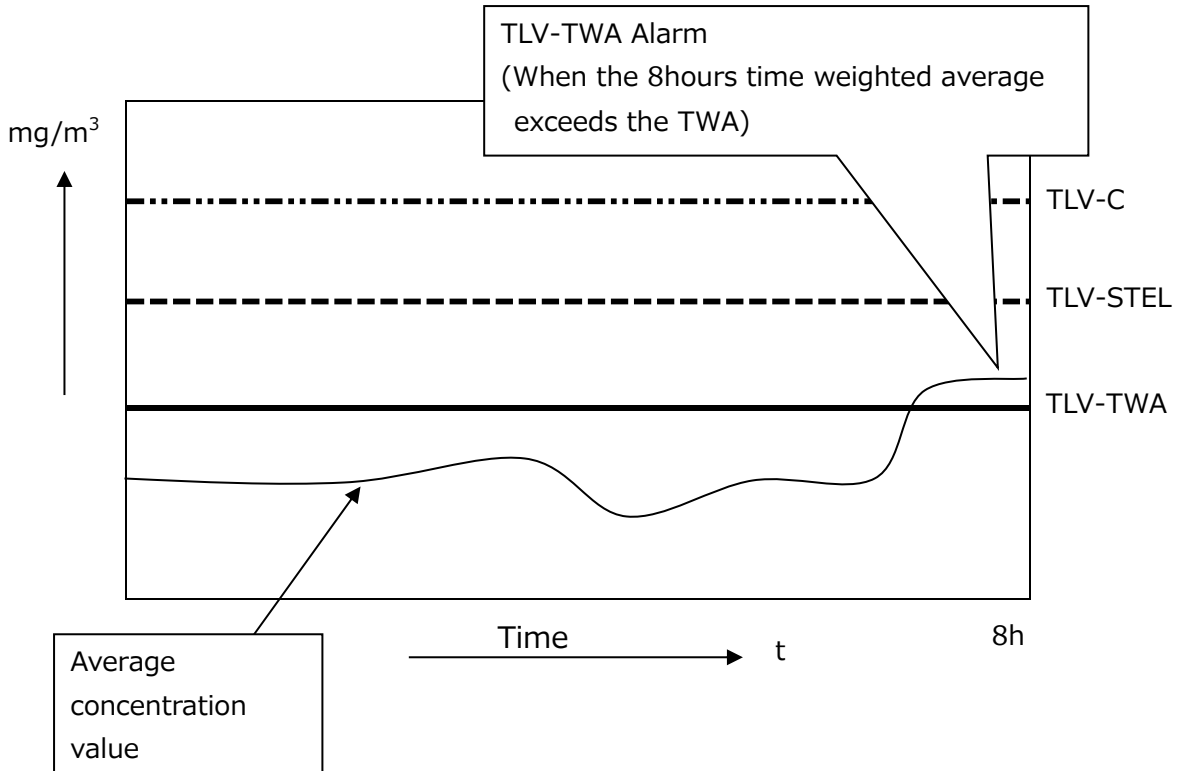

<TLV-C Alarm>

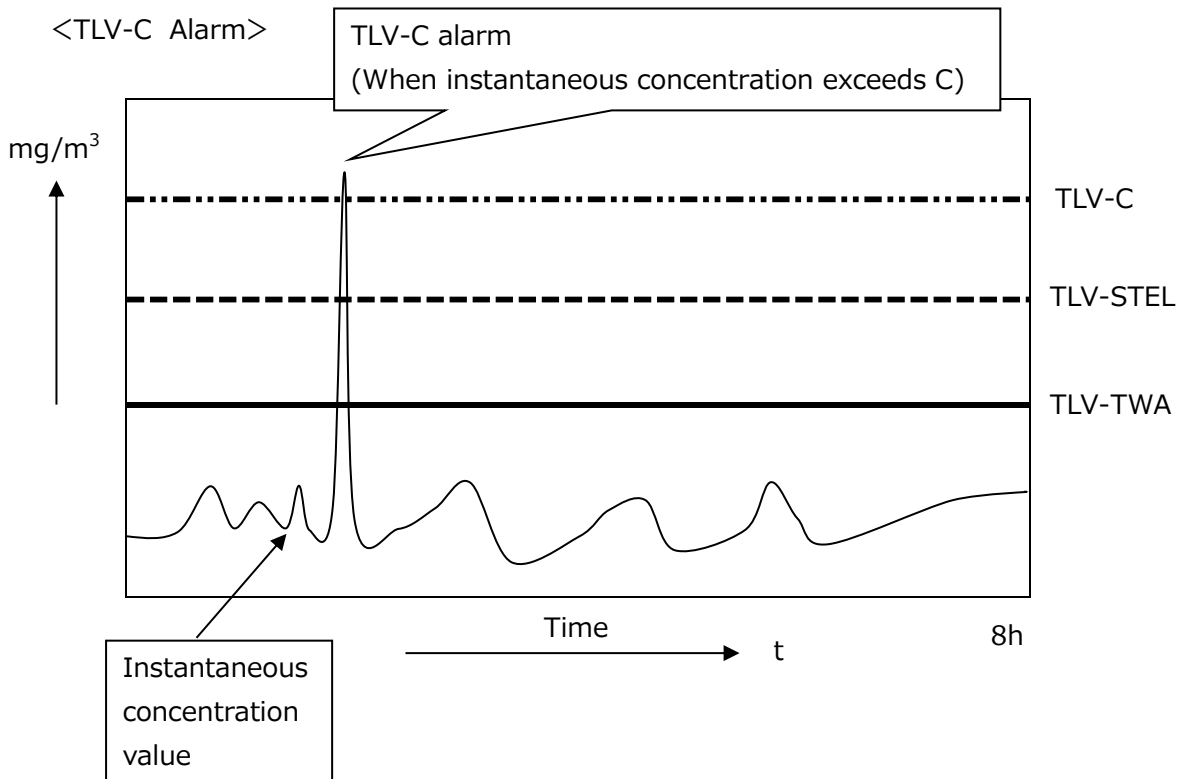

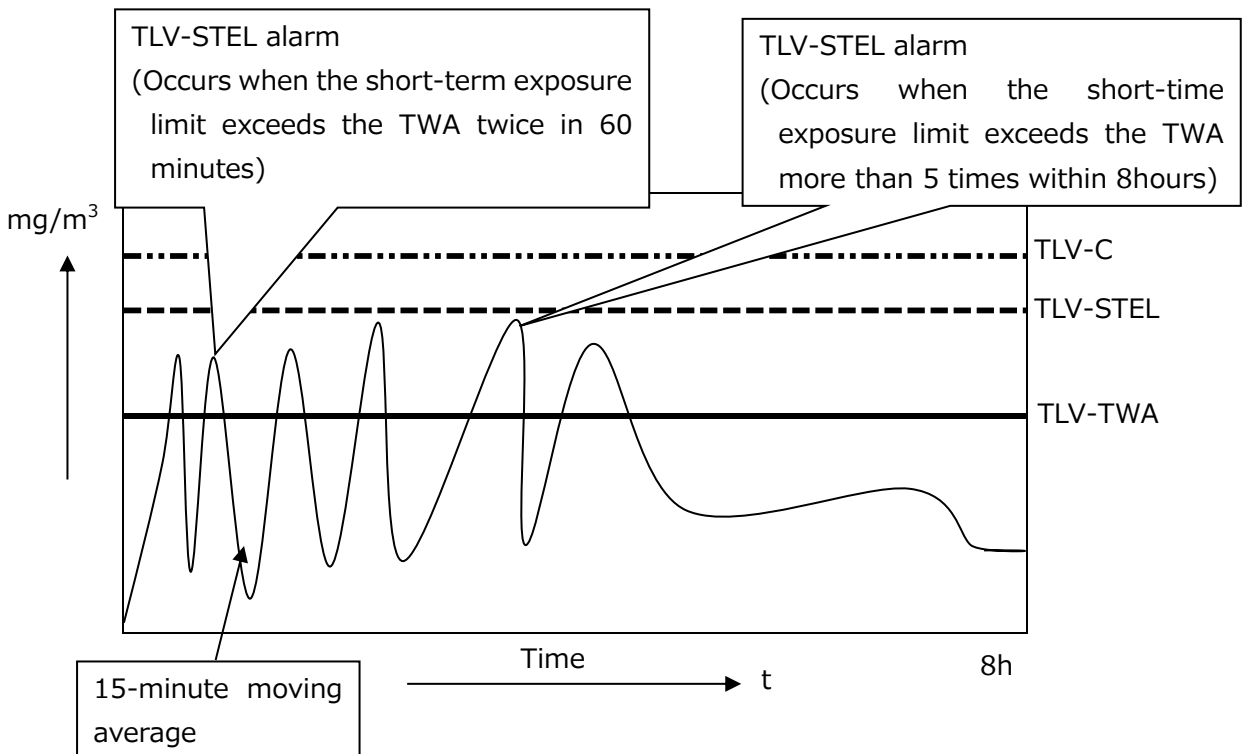
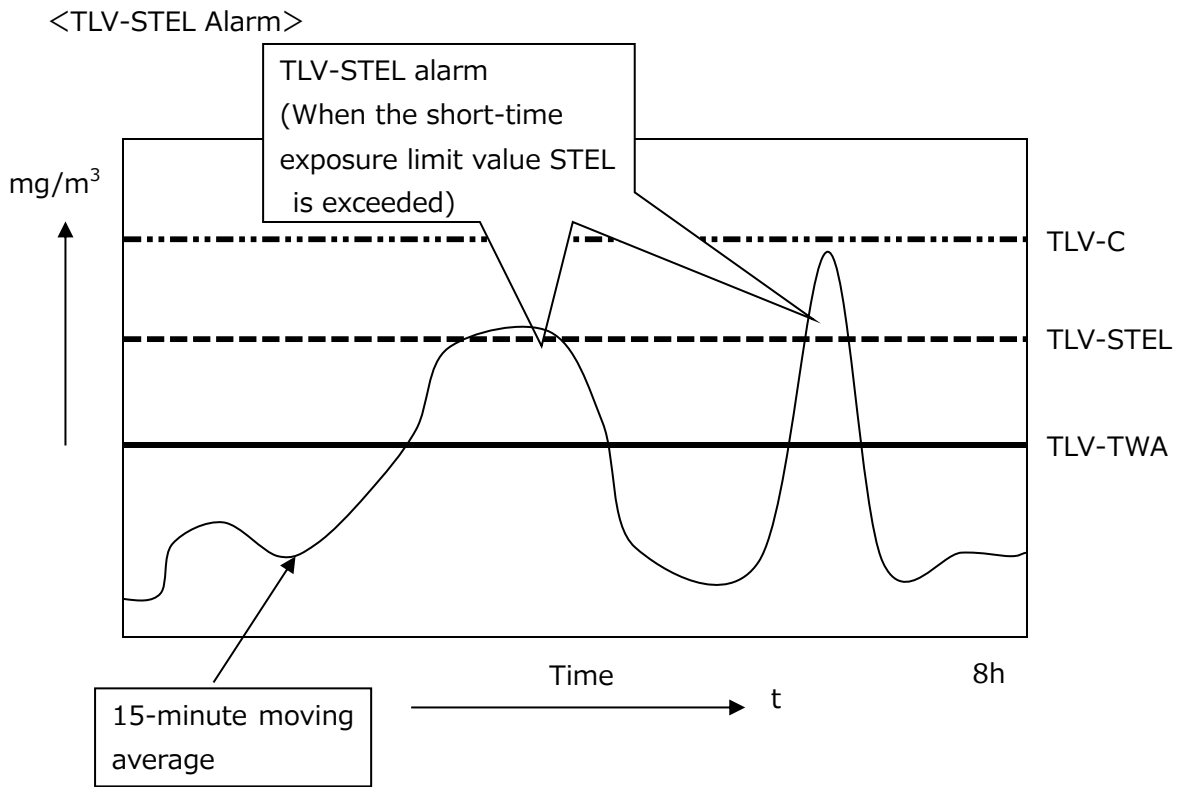

<Alarm classification>

The alarm output sound varies depending on the content of the detected alarm. Alarms in TWA mode are displayed on the measurement screen and outputting a respective sound as shown below.

Note that the alarm cannot be output to the external terminal.

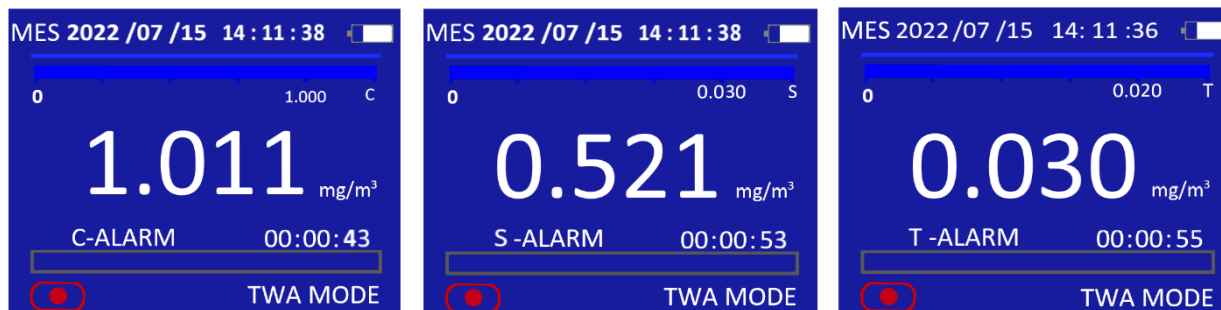

Alarm	Sound
TLV-C (C-ALARM)	Beep (Continuous beep)
TLV-STEL (S-ALARM)	Beep-Beep-Beep- (Long intermittent beeps)
TLV-TWA (T-ALARM)	Pi-Pi-Pi- (Short intermittent beeps)

*The order of priority of alarms is TLV-C (upper limit), TLV-STEL (short time exposure limit), and TLV-TWA (time weighted average) in descending order.

Therefore, if a TLV-C (upper limit) alarm occurs during a TLV-STEL (short time exposure limit) alarm, the TLV-C (upper limit) alarm sound will take precedence.

<Alarm cancellation procedure>

Pressing the [Δ] or [∇] key to clear the alarm.

If an alarm is detected immediately after the alarm is cleared, the alarm will be output again.

For resetting the alarm, please do it for each generated alarm.

The alarm will continue after the measurement ends and will be cleared when the next measurement starts.

E) CALCULATION MODE

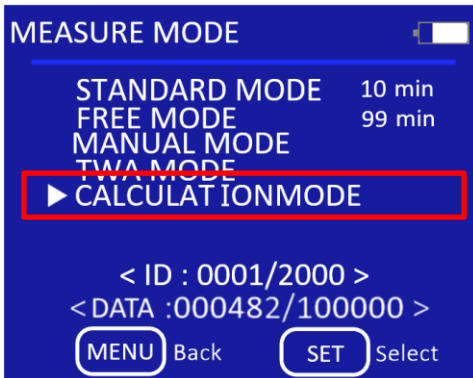

In "CALCULATION MODE", measurement time and settings can be set and scheduled.

Use the [△][▽] keys to move cursor/change value.
 Use [SET] key to select/set next value/apply the change.
 [MENU] key to cancel/return.

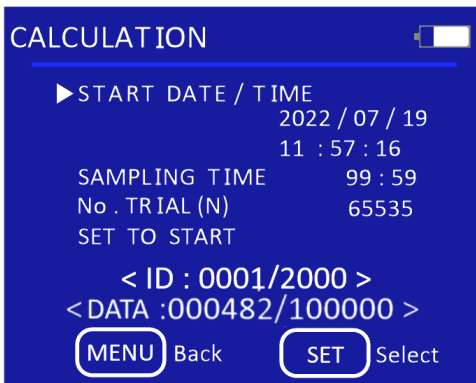

Item	Description
START DATE / TIME	Date and time to start measurement
SAMPLING TIME	Can be set from 1 second to 99 minutes and 59 seconds
No. TRIAL(N)	Can be set from 1 to 65,535 times
SET TO START	Start measurement
ID	Serial number of current measurement data.
DATA	Number of data point measured

1) START DATE / TIME

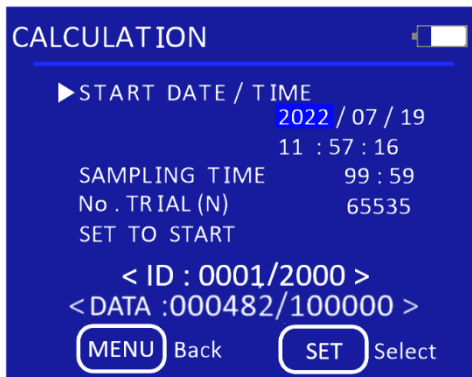

Set START DATE/ TIME values in the order of year → month → day → hour → minute → second.

2) SAMPLING TIME

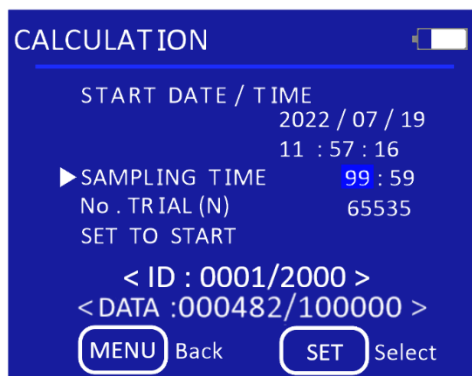

Set SAMPLING TIME value in the order of hour → minute.

The input range of the sampling time can be set from 1 second to 99 minutes and 59 seconds.

3) No.TRIAL(N)

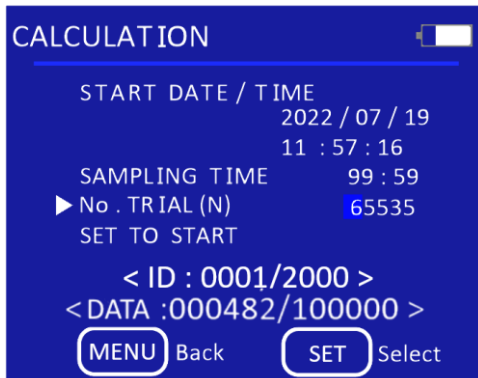

Set No.TRIAL(N) value from large digits to small.
10,000 → 1,000 → 100 → 10 → 1 .

The input range of the number of measurements can be set from 1 to 65535 times.

4) SET TO START



After completing all settings,
Move cursor to "SET TO START" and press [SET] key,
the measurement will start as set.

*Measurement results will be stored in memory.

<Screen while waiting for measurement>

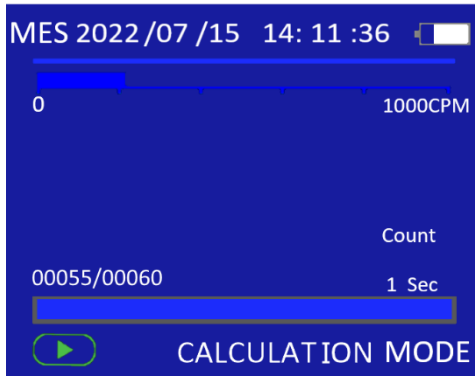

Wait until the set time or press the [START/STOP] key to start the measurement earlier.

<Screen during measurement>

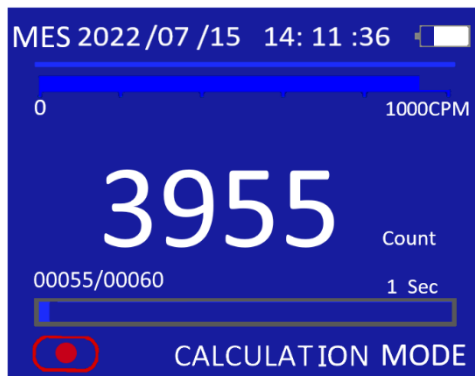

During measurement, press the [START/STOP] key to suspend/restart the measurement; press [Δ][∇] keys to switch to the graph screen.

<Graph>

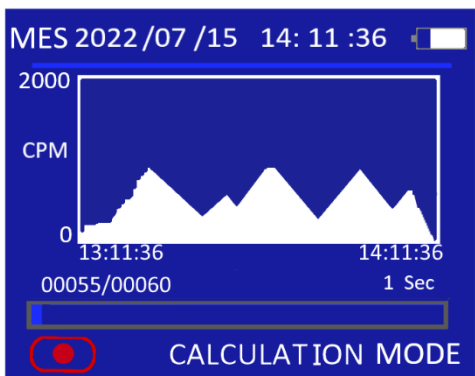

During measurement, use [Δ][∇] keys to switch alternately from graph display to count value display. Press the key again returns to the graph display. The number of data points that can be displayed on one screen is 60.

3.4.2 CALIBRATION

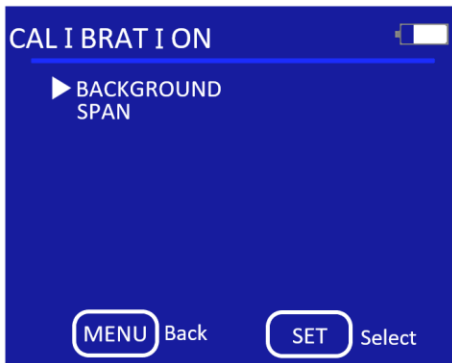

For a proper user calibration, please perform cleaning process before starting user calibration and warm up the instrument over 20 minutes.

For user calibration, please refer to "2.4 User Calibration"

Select "User Calibration" on the menu screen to start user calibration. Please start from "BACKGROUND(background adjustment)", "SPAN(sensitivity adjustment)" in order.

Use the [△][▽] keys to move the cursor to select the items and then press the [SET] key to start each item. Press [MENU] key to return to the menu screen.

<BACKGROUND>

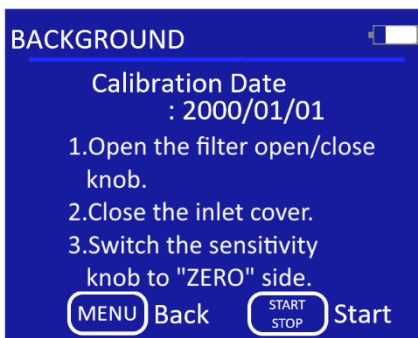

[START/STOP] key ↓

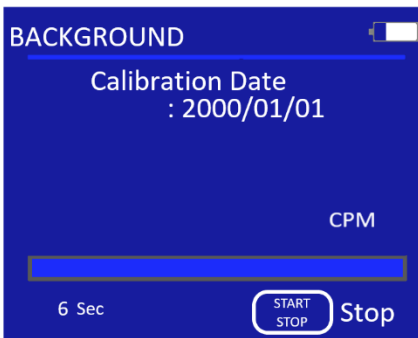

Measurement ended ↓



First start with the background adjustment, move the cursor to "BACKGROUND", press [SET] key entering the background adjustment screen.

Follow the instructions shown on the screen,

1. Pull out (Open) the filter open/close knob
2. Raise up (Close) the inlet cover
3. Switch the sensitivity control knob to "ZERO" side

Press the [START/STOP] key when the above actions are completed.

There will be a 6 second measurement.

During the measurement, the background instantaneous value (CPM) will be displayed.

The remaining measurement time is displayed at the bottom left of the screen.

After the measurement ended, the average background value (CPM) will be displayed on the screen.

Press the [SET] key to apply this value for adjustment.

Press the [MENU] key to cancel and return to menu.

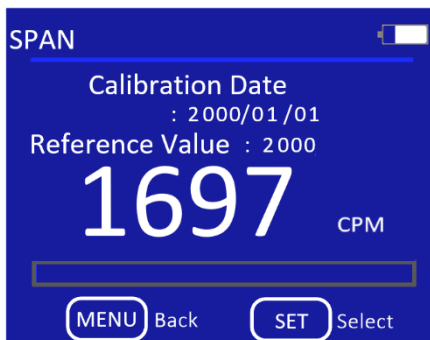
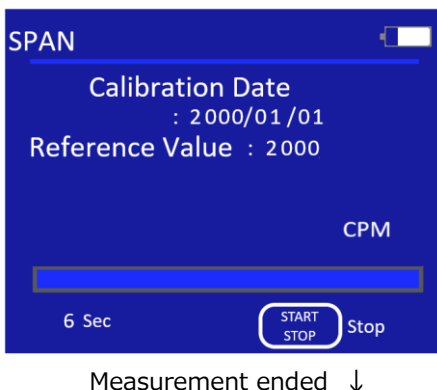

Next do the sensitivity adjustment, move the cursor to "SPAN" in the calibration menu, press [SET] key entering the sensitivity adjustment screen and make sure the background adjustment is finished before starting sensitivity adjustment.

Follow the instructions shown on the screen,

1. Pull out (Open) the filter open/close knob
 2. Raise up (Close) the inlet cover
 3. Switch the sensitivity control knob to "FULL" side
- Press the [START/STOP] key when the above actions are completed.

Same as background adjustment,

there will be a 6 second measurement.

During the measurement, the background instantaneous value (CPM) will be displayed.

The remaining measurement time is displayed at the bottom left of the screen.

After the measurement ended, the average value (CPM) will be displayed on the screen.

Press the [SET] key to apply this value for adjustment, and the calibration date will be updated.

Press the [MENU] key to cancel and return to menu.

*Please must do the cleaning process and warm up the instrument more than 20 minutes before starting user calibration, otherwise errors or deviations may result.

*Background adjustment

Note that if background adjustment is performed in a high concentration environment or improper operation, it may affect the measured value greatly.

Also, if the background adjustment measured value deviates more than ± 20 CPM from the manufacturer's calibration value, a "Calibration Error" message will be displayed on the screen.

In this case, please contact our service center or distributor.

* Sensitivity adjustment

Same as background adjustment, please note the measured value of sensitivity adjustment will be affected by improper operation and environment.

And if the measured value deviates more than $\pm 20\%$ CPM from the manufacturer's calibration value, a "Calibration Error" message will be displayed on the screen.

Please contact our service center or distributor.

3.4.3 FILE



Selecting "FILE" on the menu screen.

Saved measurement data can be managed here.

You can view or delete data, turn ON/OFF the data saving function, and check the remaining memory.

A) DATA LIST

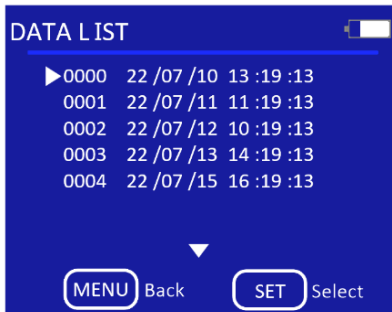

Move the cursor to "DATA LIST" and press the [SET] key.

Data from "STANDARD MODE" & "CALCULATION MODE" are listed and can be viewed here.

Use [Δ][∇] keys to move the cursor.

Press [SET] key to select and display the content of the selected data.

Press [MENU] key to return.



Measurement data screen as left shown.

Press the [mg/m^3] key to switch the units between CPM & mass concentration.

Press [SET] key to display the data details.

Press [MENU] key to return.

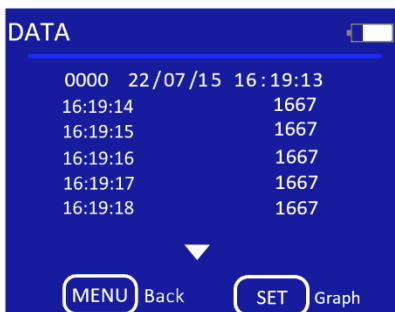

One data point per row, showing time of measurement and relative concentration measured.

Press the [mg/m^3] key to switch the units between CPM & mass concentration.

Press [SET] key to display the graph.

Use [Δ][∇] keys to scroll up and down.

Press [MENU] key to return.

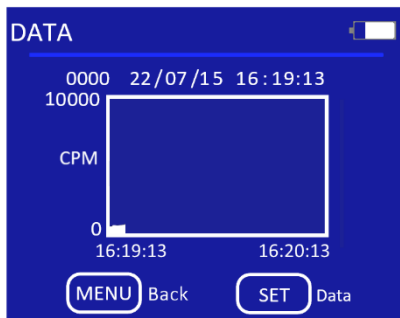

The time series graph of the measured data can display up to 60 data on one screen.
 The horizontal axis of the graph is time, and the vertical axis is relative concentration.
 The scale of the vertical axis will be set automatically.
 Press the [mg/m³] key to switch the units between CPM & mass concentration.
 Press [SET] key to return to the data list.
 Press [MENU] key to return.

B) DELETE DATA

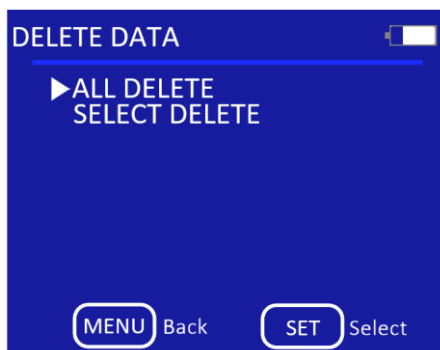

Select "ALL DELETE" to delete all the saved data in the instrument, and a confirmation message "All stored data will be deleted" will be displayed, press [SET] key to confirm or press [MENU] to cancel.

For the case that only want to delete specific data, use "SELECT DELETE" function, the data list will be displayed. Use [Δ][▽] keys to move the cursor. Press [SET] key to delete, and a confirmation message "Stored data to be deleted" will be displayed, press [SET] key to confirm or press [MENU] to cancel.

C) SAVE DATA

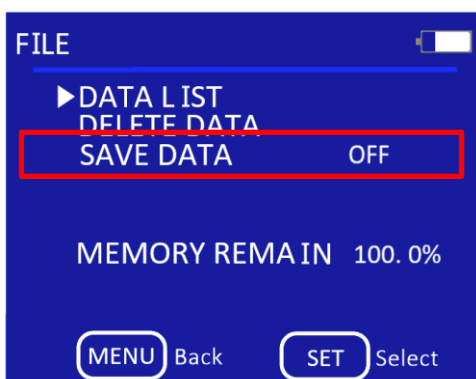

Setting to turn ON/OFF the data saving function.
 Press [SET] at "SAVE DATA",
 Use the [Δ][▽] keys to change the setting, and press the [SET] key again to save the change.
 When "SAVE DATA" is ON, the measurement data in the standard mode & calibration mode will be saved.
 When it's OFF, no data will be saved.

D) MEMORY REMAIN

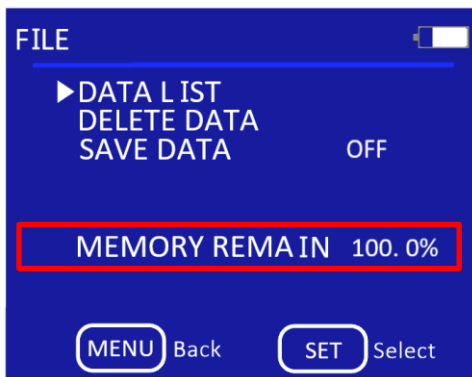

Indicates the percentage of remaining memory.

When "SAVE DATA" is ON and the memory is insufficient, message "REC: OVER" will be displayed and measurement cannot be started.

In this case, to start the measurement, please do one of the following:

- (1) Turn off data saving and measure.
(Data will not be saved.)
- (2) Delete the data before measurement to free up memory.
- (3) Install the included measurement software and start measuring with a PC.
(For details on the installation and measurement, refer to the "Digital Dust Monitor Application Manual" included in the measurement software (3444-40).)

3.4.4 UTILITY



Select "UTILITY" on the menu screen.
 The functions are shown in the table below.
 Use the [△][▽] keys to move the cursor.
 Press the [SET] key to select and set each item.
 Press the [MENU] key to cancel and return.

Item	Contents
CLEANING	Clean the unit
DATE&TIME	You can set the date and time
K FACTER	Set the K value (Mass concentration conversion factor)
LCD/BEEP	Set screen settings and beep sound ON/OFF
ANALOG OUT/ ALARM	Analog output configurations.
LANGUAGE	Japanese/English

A) CLEANING

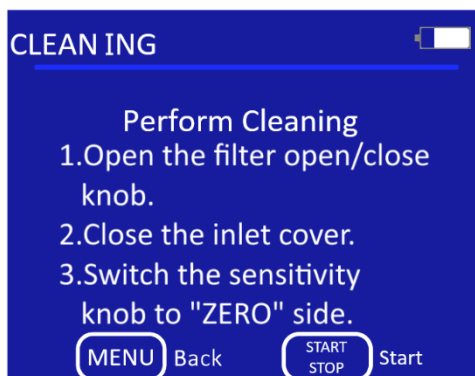

Clean the main unit. (See "2.3 Cleaning.")
 To start cleaning,
 1. Pull out (Open) the filter open/close knob
 2. Raise up (Close) the inlet cover
 3. Switch the sensitivity control knob to "ZERO" side
 Press the [START/STOP] key to start cleaning.
 Press the [MENU] key to return to the utility screen.

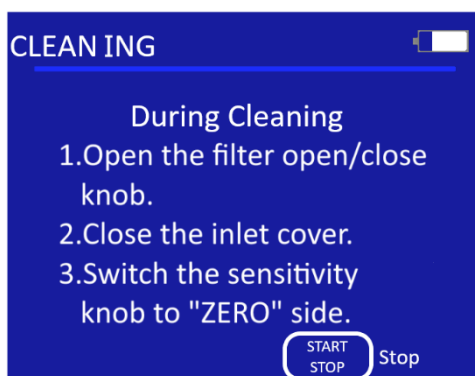

Press the [START/STOP] key again to finish cleaning and return to the utility screen.
 5 minutes is recommended for cleaning.
 *Cleaning will not end automatically.
 *Cleaning time varies depending on the operating environment.
 *If the user calibration error persists after cleaning for more than 10 minutes, an internal cleaning may be required. Please contact our service center or distributor.

B) DATE&TIME



This function is for date and time settings.

Use [Δ][∇] keys to move cursor and change value.

Use [SET] key to select and set.

Press the [MENU] key to return to the menu screen.

Item	Contents
Style	Set the date display format.
Date	Set the date.
Time	Set the time.

<STYLE>



Select the date display format.

Formats are shown in the table below.

YYYY: Year ; MM: Month ; DD: Day

Use [Δ][∇] keys to move cursor and change value.

Use [SET] key to select and set.

Press the [MENU] key to return to the menu screen.

Item	Example
YYYY/MM/DD	2022/07/15
MM/DD/YYYY	07/15/2022
DD/MM/YYYY	15/07/2022

<DATE>



Set the date in the order of date display format.

(e.g., order of year, month, date, for YYYY/MM/DD format)

* The order changes in different formats.

Use [Δ][∇] keys to move cursor and change value.

Use [SET] key to select and set.

Press the [MENU] key to cancel and return.

<TIME>

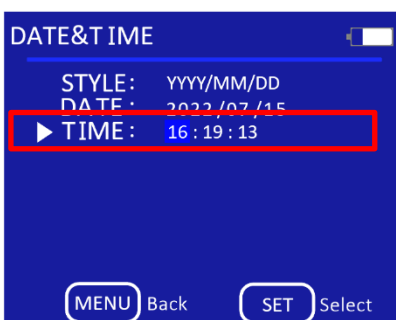

Set the time for the instrument.

Use [Δ][∇] keys to move cursor and change value.

Use [SET] key to select and set.

Press the [MENU] key to cancel and return.

C) K FACTER



Set the K value (mass concentration conversion factor).

Use [Δ][∇] keys to change value.

*The setting range is from 0.1 to 9.9.

Press the [SET] key to apply the change.

Press the [MENU] key to cancel and return.

In order to convert from the measured value (CPM) of this instrument to mass concentration (mg/m^3), it is necessary to determine the mass concentration conversion factor. This coefficient is determined by parallel measurement with this instrument and a filtration collector with a particle size separator.

The following is the specific method to obtain the mass concentration conversion coefficient. Set the instrument and the filtration collector at the same height and with their inlet in the same direction so that start measurement at the same time.

Divide the value "C" (mg/m^3) measured by collector by the average count value "R" (CPM) measured by instrument to get the value "K" ($\text{mg}/\text{m}^3/\text{CPM}$) which is the conversion factor.

$$K_{\text{true}} = C/R$$

Multiply this coefficient by the count value (CPM) obtained by the instrument at each measurement point to convert it into mass concentration (mg/m^3).

*Note that the actual K value calculated is different from the input K value.

Their relationship is as follows:

$$K_{\text{input}} = K_{\text{true}} \times 1000$$

*The range of input K value is from 0.1 to 9.9 ($K_{\text{input}} = 0.1 \sim 9.9$).

* Since the unit conversion for calibration particles is set at $1 \text{ CPM} = 0.001 \text{ mg}/\text{m}^3$, the factory default value for K will be 1.0 (meaning 1 CPM equal to $0.001 \text{ mg}/\text{m}^3$ during conversion).

*Example

$$K = 1.0: 100 \text{ CPM} \rightarrow 0.1 \text{ mg}/\text{m}^3$$

$$K = 2.0: 100 \text{ CPM} \rightarrow 0.2 \text{ mg}/\text{m}^3$$

D) LCD / BEEP



Screen settings and beep sound ON/OFF.

Use [△][▽] keys to move the cursor.

Use [SET] key to select and apply changes.

Press the [MENU] key to return.

Item	Contents
CONTRAST	Set the contrast setting for the screen.
BACKLIGHT OFF	Set the backlight off time setting.
BEEP	Set the ON/OFF setting for the beep sound.

<CONTRAST>



Move the cursor to "CONTRAST" and press the [SET] key, use [△][▽] keys to change the value of contrast.

The contrast range is 0 to 63. (The default value is 32.)

Press the [SET] key to apply the change.

Press the [MENU] key to cancel and return.

<BACKLIGHT OFF>



This feature is used to turn off the backlight when the device is not in use.

Move the cursor to "BACKLIGHT OFF" and press the [SET] key, use [△][▽] keys to change backlight time setting.

The setting range is 1 to 60 minutes, or always on.

Press the [SET] key to apply the change.

Press the [MENU] key to cancel and return.

<BEEP>



Beep sound ON/OFF setting.

Use [△][▽] keys to switch on/off.

Press the [SET] key to apply the change.

Press the [MENU] key to cancel and return.

E) ANALOG OUT/ALARM



Sets analog output settings and alarm output thresholds. Use [Δ][∇] keys to move the cursor and change setting. Press the [SET] key to select and apply changes. Press the [MENU] key to return to the utility screen.

Item	Description
ANALOG OUT	Sets analog output ON/OFF.
ALARM	Sets alarm output ON/OFF.
THRESHOLD	Set threshold settings.

<ANALOG OUT>

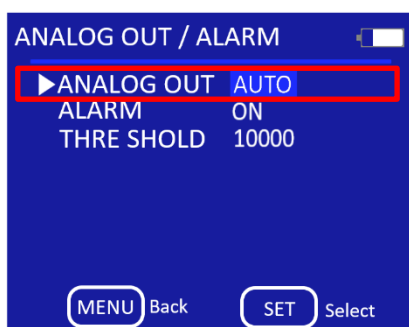

Set the corresponding relationship between the measured relative concentration value (CPM) and the voltage output by the output terminal. Use [Δ][∇] keys to change the setting. Press [SET] key to apply the change.

0-1000

[Δ] ↓ ↑ [∇]

0-10000

[Δ] ↓ ↑ [∇]

AUTO

The difference between each setting is as follows:

0-1,000: 1V will be output when the density is 1,000 CPM.

0-10,000: 1V will be output when the density is 10,000 CPM.

AUTO: The voltage output is automatically switched to 0-1V in the range of 0-1000 CPM and 0.1-1V in the range of 1000-10000 CPM.

- (1) Data update interval Output data is always updated at 1 second intervals.
- (2) Load impedance 1k Ω or more
- (3) Output cable Please purchase the optional output cable (3444-30).
Refer to "5.6 Output Cable (Analog)" for output cable connection.

Output method of measurement data (in case of analog output)	Description
	<p>CPM value (Instantaneous value) per second is converted to voltage and output.</p>

*The output voltage value is different from the count value on the display screen.
*Please prepare the optional output cable (3444-30).

<Alarm & Threshold>

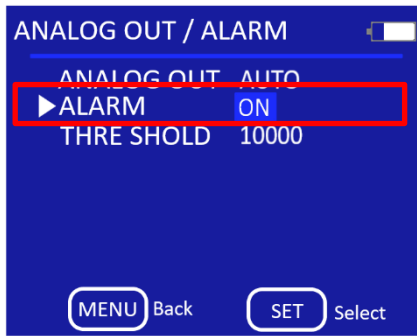

Set "ALARM" to "ON" to enable the following functions:
When the instantaneous measured value (CPM) exceeds the threshold value, the alarm output will be activated.

(Alarm Output : OFF → ON)

And when the instantaneous measured value falls below the threshold value, the alarm output will go off.

(Alarm Output : ON → OFF)

Use [△][▽] keys to enable/disable this function.

Please note that this function can only be enable during the measurement and will be automatically deactivated after the measurement is completed.

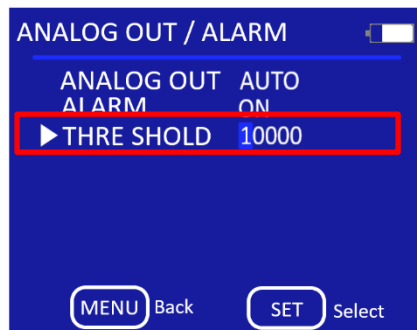

Set threshold value from large digits to small.

10,000 → 1,000 → 100 → 10 → 1 .

Use the [△][▽] keys to change value.

Press the [SET] key to set next value/apply the change.

Press the [MENU] key to cancel/return.

The set range of threshold value is 1-10000.

- (1) Data update interval Output data is updated every second.
- (2) Valid range of output From the start to the end of measurement.
- (3) Output form and specification Photo-coupler output
(No-voltage contact output: collector-emitter)

Model: TLP187

Maximum applied voltage: 300V DC

Maximum current: 150mA

- (4) Output cable Please purchase the optional output cable (3444-30)
Refer to "5.6 Output Cable (Analog)" for output cable connection.

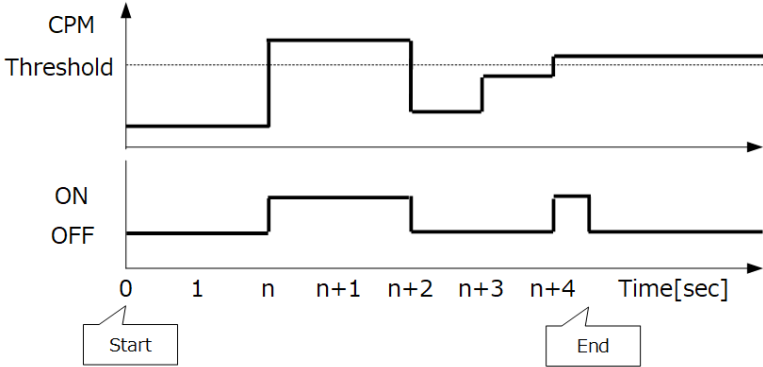
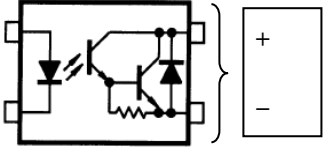
Alarm output	Description
	<p data-bbox="1114 241 1444 407">Alarm judgment is made and output by CPM value (Instantaneous value) every second.</p> <p data-bbox="1114 443 1444 481">(Output terminal circuit)</p> 

*The CPM value (Instantaneous value) for the alarm judgment is different from the count value on the display screen.

*Please prepare the optional output cable (3444-30).

<Pulse output>

This device can output pulses equivalent to the CPM value (Instantaneous value).
Please connect the output cable (optional).

- (1) Pulse frequency update intervalUpdated every seconds.
- (2) Pulse range0.0166Hz-166.6Hz (1-10,000CPM) DUTY 50%.
- (3) Output form & specification Photo-coupler output
 (No-voltage contact output: collector-emitter)
 Model: TLP187
 Maximum applied voltage: DC300V
 Maximum current: 150mA
- (4) Output cablePlease purchase the optional output cable (3444-30)
 Refer to "5.6 Output Cable (Analog)" for output cable connection.

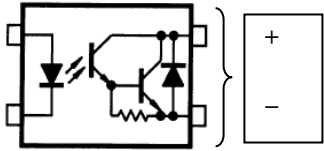
Pulse output		Description
CPM value (Instantaneous value)	Pulse frequency	Outputs pulses corresponding to the CPM value (Instantaneous value) every second. (Output terminal circuit) 
1 CPM	0.0166 Hz	
60 CPM	1 Hz	
600 CPM	10 Hz	
6,000 CPM	100 Hz	
10,000 CPM	166.6 Hz	
*No pulse output at 0CPM.		

F) LANGUAGE

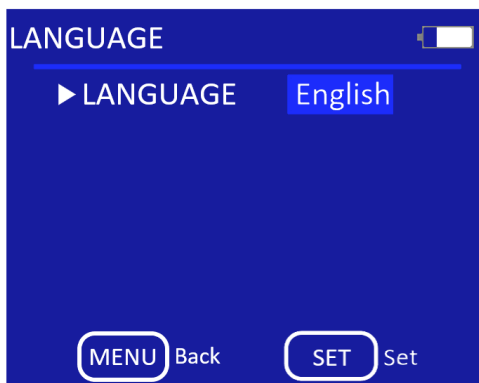

Language setting screen.

Use the [Δ][∇] keys to switch alternately between Japanese and English.

Press the [SET] key to save the change, the device will reboot automatically.

Press the [MENU] key to cancel and return.

3.5 Serial Communication

<USB communication connector>

Communication with a host computer is possible by connecting the attached USB cable for communication.

- ① Use the included USB communication cable to connect with PC.
- ② Install the attached measurement software on the host computer.
(For details on software installation, refer to the "Measurement Software Instruction Manual for Light Scattering Digital Dust monitor" included in the measurement software (3444-40).

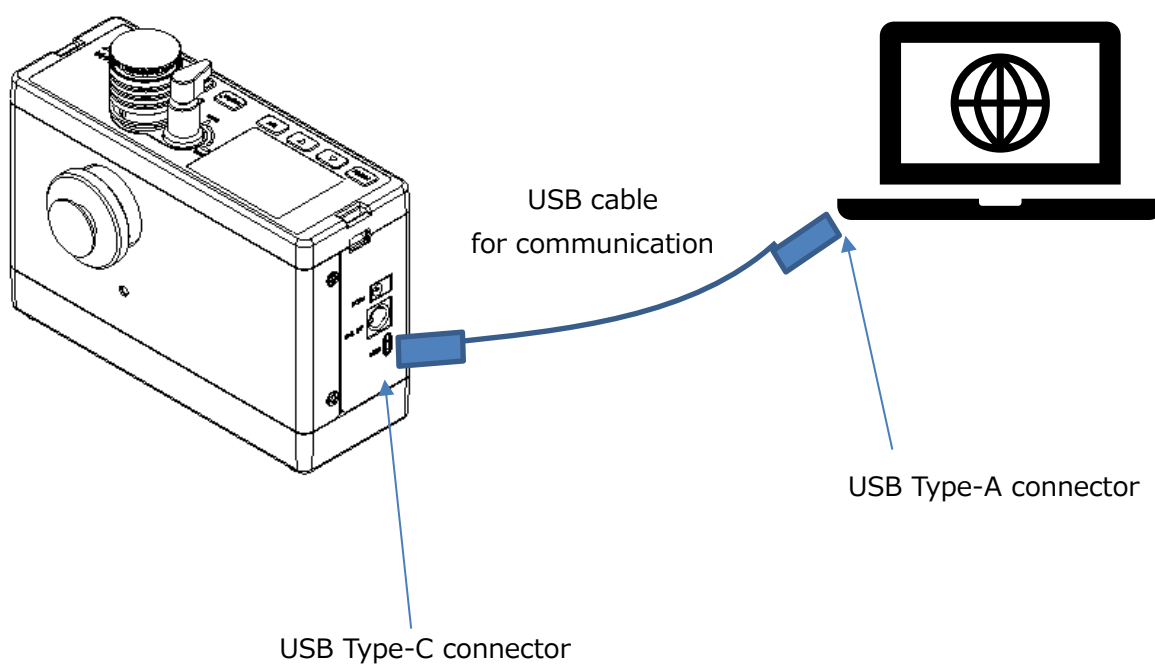

3.6 Measurement Procedure

To ensure accurate measurements, let the product to fully adapt to the ambient temperature where it will be used (more than 20 minutes).

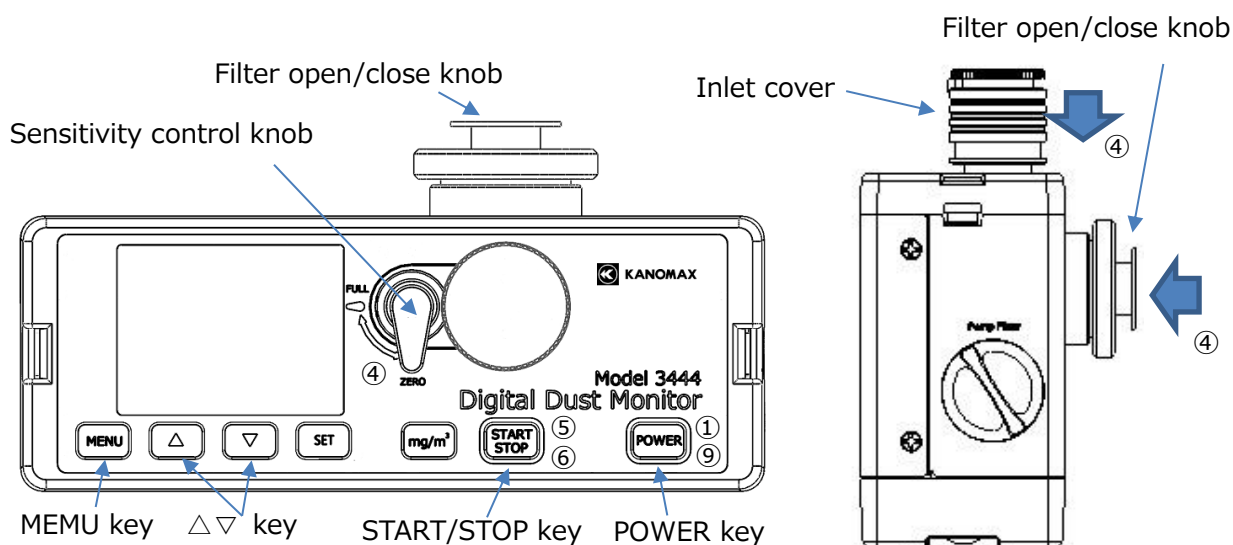

- ① Press the [POWER] key for at least 1 second to turn on the power, and after 10 seconds of aging operation, the unit is ready for operation.
Please do user calibration first (See "2.4 User Calibration."),
And set the K value. (See "3.4.4 Utility C" K Value Setting.)
- ② Set the measurement time. (See "3.4.1 Measurement Mode.")
- ③ Check the measurement time display in the bottom left corner of the LCD screen is normal and the measurement mode is correct.
- ④ Push in (Close) the filter open/close knob and lower the inlet cover.
Set the sensitivity control knob to "ZERO".
- ⑤ Press the [START/STOP] key to start measurement.
The measurement is automatically terminated after the measurement time ended.
Measurement can be terminated by pressing the [START/STOP] key.
If want to stop measurement in manual mode, press the [START/STOP] key to exit.
The measurement result will be calculated and displayed during measurement.
- ⑥ After measurement, press the [mg/m³] key to display the mass concentration.
To make the next measurement, press the [START/STOP] key again
- ⑦ After all measurements have been taken, raise the inlet cover up.
- ⑧ Cleaning. (See "2.3 Cleaning.")
- ⑨ Press the [POWER] key for more than 2 seconds to turn off the power.

4. Replacement of Consumables

4.1 Replacing the filter

If errors keeps occurring when doing calibration, or if the purge filter is obviously damaged or extremely dirty, please replace the purge filter.

The time to replace the pump filter depends on the measured concentration and the time of use. If the flow rate decreases, replace the pump filter.

4.1.1 Purge filter replacement

<Preparation of replacement parts>

Use the replacement purge filter included with the product or purchase the optional purge filter (10 sheets included) (3442-03).

<How to change the filter>

- ① Remove the filter fixing ring at the cleaning air opening on the side by rotating it in the direction shown in the figure.
- ② Remove the rubber seal and purge filter from the filter holder with tweezers.
- ③ Prepare a replacement purge filter and put it into the holder, be careful not to damage the purge filter. Next, set the rubber seal on top of the purge filter. Last, tighten and put the filter fixing ring back to complete the replacement.
- ④ After replacement, please do the cleaning process. (See "2.3 Cleaning.")

*If the rubber seal is not inserted or the filter fixing ring is not tightened, it may cause leakage and affect measurement. Make sure each part is installed correctly when replacing.

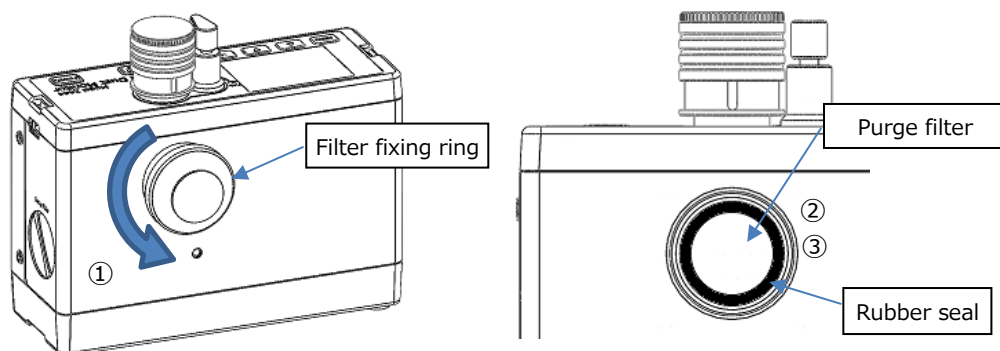

4.1.2 Pump filter replacement

<Preparation of replacement parts>

Use the replacement pump filter included with the product or purchase the optional pump filter (3444-60).

<Filter Replacement>

- ① Turn the pump filter cap counterclockwise in the direction shown in figure and pull it out.
- ② Remove the pump filter attached to the pump filter cap.
- ③ Prepare a replacement pump filter and insert it to the bottom of the pump filter cap.
*When inserting the pump filter into the pump filter cap, please insert it straight down, not at an angle.
- ④ Insert the pump filter cap back and turn it clockwise to attach it.
- ⑤ After replacement, please do the cleaning process. (See "2.3 Cleaning.")

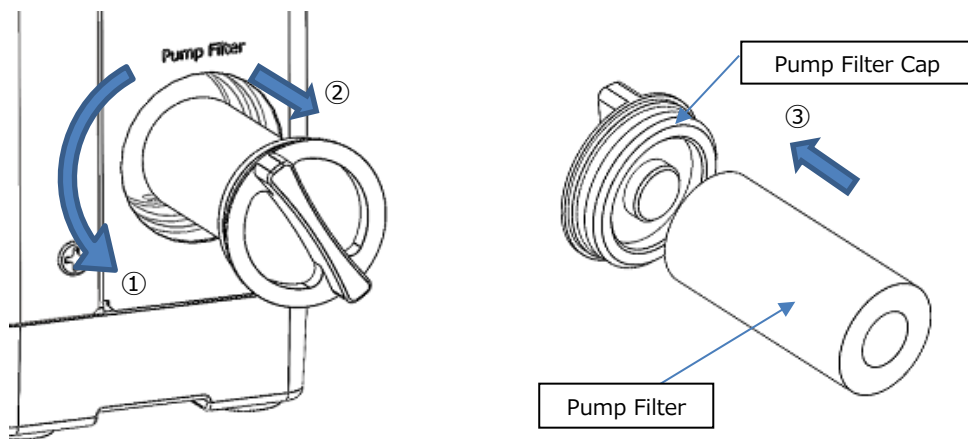

4.2 Replacing the LCD protective sheet

If the LCD protective sheet is dirty or scratched, please replace the LCD protective sheet.

* The LCD protective sheet is not installed when shipping.

Attach the LCD protective sheet if necessary.

<Preparation of replacement parts>

Please use the LCD protective sheet included with the product or purchase the optional LCD protective sheet (3444-61).

<LCD protective sheet replacement>

- ① Remove the LCD protective sheet to be replaced.
(The LCD protective sheet is not installed when shipping.)
- ② Wipe off any dirt, dust, etc. on the display screen and surrounding area.
- ③ Prepare a replacement LCD protective sheet, tear off the release film, and paste the LCD protective sheet on the display screen.

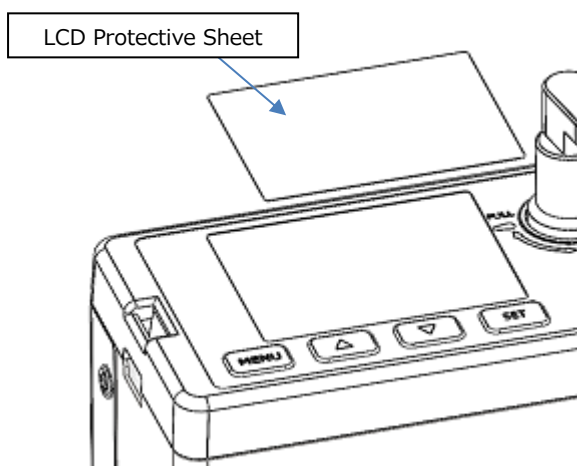

5. Optional Products

5.1 Tube connection inlet adapter

Tube can be attached to the inlet of the dust monitor by installing the Tubing Connection Inlet Adapter (3444-73). Please use flexible tube with an inner diameter of 6 to 7 mm.

* This product does not include the tube.

<Mounting Method>

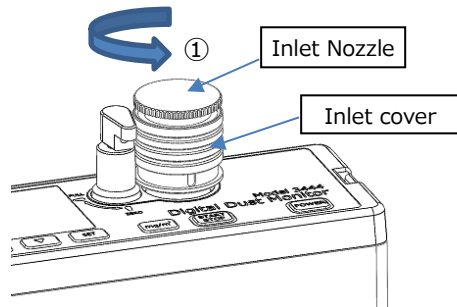

- ① Hold the inlet nozzle and turn it counterclockwise as left shown.

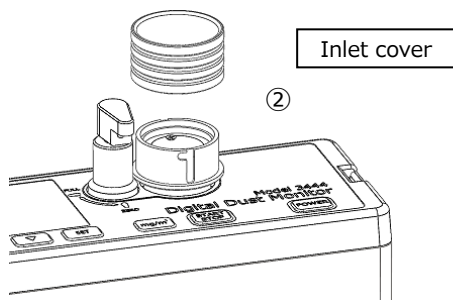

- ② Remove the inlet cover.

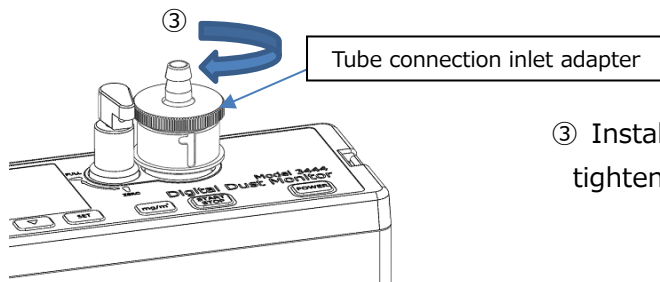

- ③ Install the tube connection inlet adapter and tighten the threaded part clockwise.

5.2 Cyclone connection adapter

The Cyclone Connection Adapter (3444-74) is a dedicated connection adapter for Traditional 10 mm Nylon Cyclone (made by SENSIDYNE).

By installing a cyclone connection adapter and connecting a cyclone, particles with a diameter of 4 μm or less can be classified and measured. For more information about the cyclone, please contact our customer support or distributor.

*Traditional 10 mm Nylon Cyclone (manufactured by SENSIDYNE) cyclone is not included.

<Mounting Instructions>

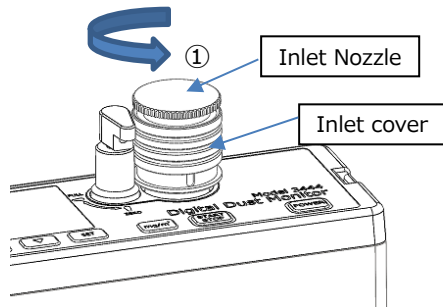

- ① Hold the inlet nozzle and turn it counterclockwise as left shown.

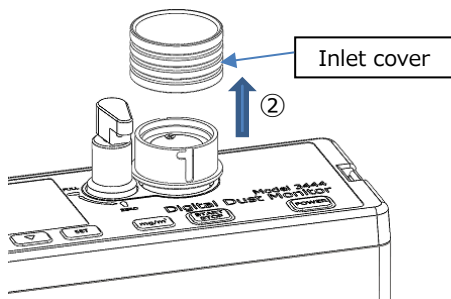

- ② Remove the inlet cover.

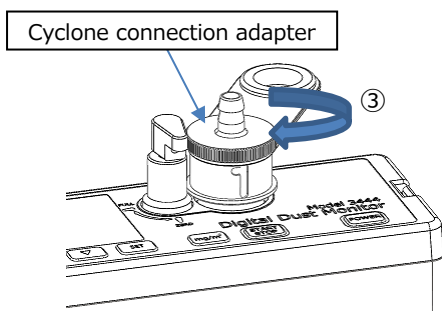

- ③ Install the cyclone connection adapter and tighten the screw part clockwise to install. Fix the cyclone connection adapter, do not let the cyclone mounting hole overlap with the main body.

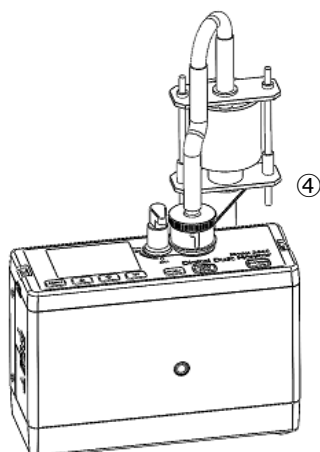

- ④ Install the cyclone by inserting it into the cyclone mounting hole of the cyclone connection adapter as shown in the figure.

5.3 Tripod Fixing L Angle

The tripod-fixing L-angle (3444-72) can be used to mount the dust monitor on a tripod with the inlet of the dust monitor facing up.

* Please prepare a tripod (able to withstand load of 3 kg or more).

<Mounting Instructions>

- ① Tighten the screw of the L-shaped angle for fixing the tripod to the tripod fixing screw hole on the side of the dust monitor.
 - ② Attach the tripod-fixed L-shaped angle with the dust monitor attached to the tripod head.
- *Tighten the screws firmly so that the dust monitor does not tilt.

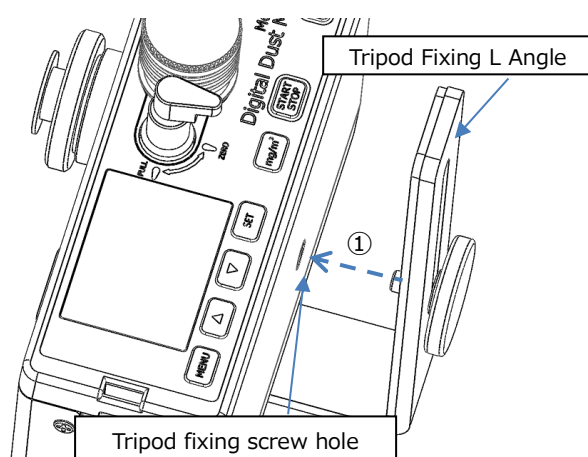

5.4 Protector

When the dust monitor is mounted on a tripod, a protector (3444-70) can be installed to cushion the impact on the dust monitor body when overturned.

<Mounting Instructions>

Align the tripod fixing screw hole on the side of the dust monitor with the hole on the protector, place the protector between the dust monitor and the L-shaped tripod fixing angle, and tighten the screw on the L-shaped tripod fixing angle.

- * To use the protector, an L-shaped angle is required for fixing.
- * Please prepare the tripod(able to withstand load of 3 kg or more).
- * Make sure the dust monitor is oriented correctly so that it can be mounted in the center of the protector.
- * Tighten the screws firmly so that the dust monitor does not tilt.

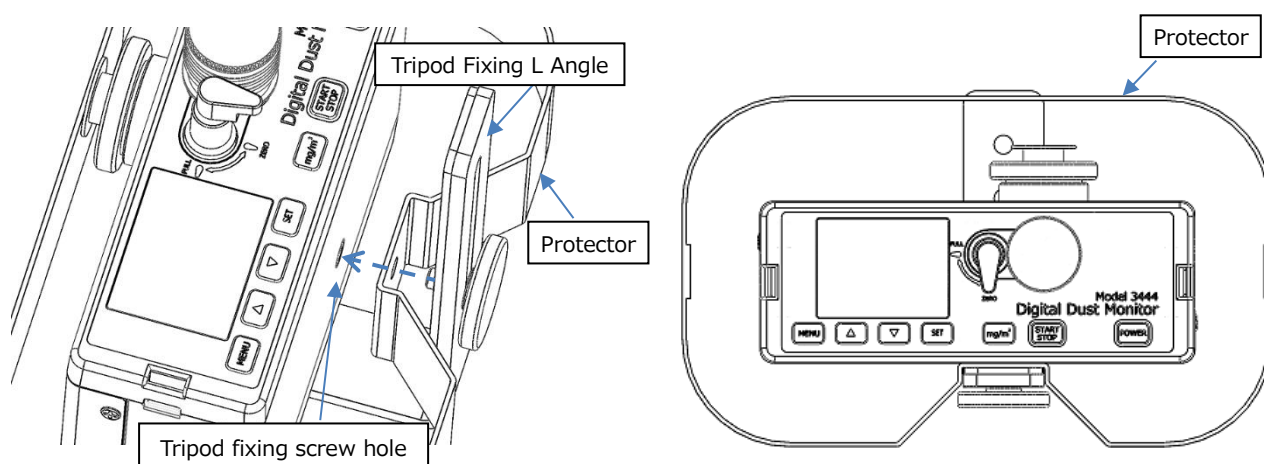

*The protector cannot completely protect the main body of the dust monitor. Depending on the operating environment and the degree of fall, the main unit may be damaged in the drop even with the protector attached.

*If the protector is deformed due to a fall, it cannot be reused.

*Be aware that the protector will get very hot if leave it in direct sunlight.

5.5 Dust monitor Cover

A dust monitor cover (3444-71) can protect the main unit from dust and dirt. The dust monitor can be operated while it is put in the dust monitor cover and can be used with the AC adapter, USB cable for communication, etc. connected.

<Mounting>

- ① Remove the filter fixing ring from the dust monitor body.
- ② Put the dust monitor body in the dust monitor cover.
- ③ Close the dust monitor cover lid.
- ④ Attach the filter fixing ring back to the dust monitor.

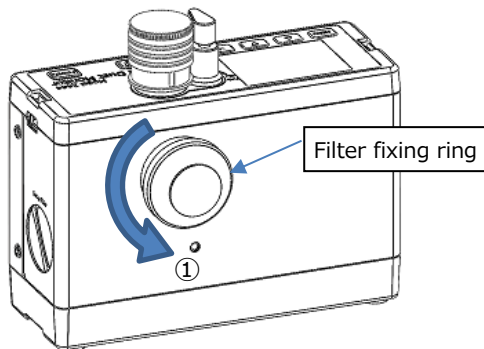

* Do not leave the dust monitor in the dust monitor cover for long periods of time in a hot environment.

* If the dust monitor cover becomes dirty, wipe it with water or a mild detergent. The sheer fabric may be damaged if rubbed hard, so please wipe carefully.

*If there is a possibility that asbestos measurements have been made, dispose of the product as "waste asbestos, etc." (dispersible asbestos waste), a specially controlled industrial waste stipulated in the Waste Disposal and Public Cleansing Law, in accordance with the disposal method.

5.6 Output cable (Analog)

The output cable (analog) (3444-30) is used for analog output, pulse output, and alarm output. Insert the plug of the output cable (analog) into the input/output connector on the side of the main unit.

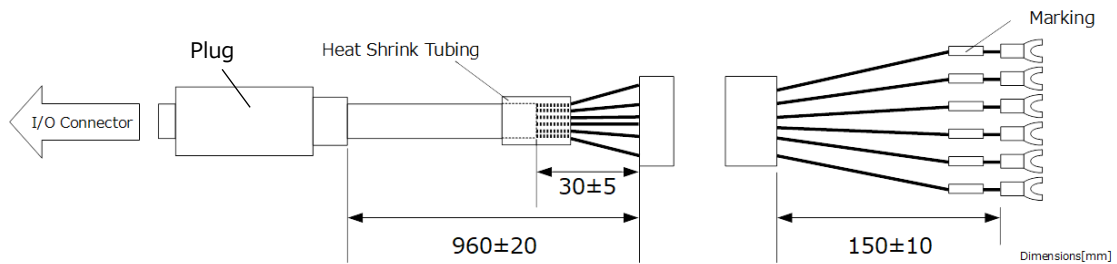
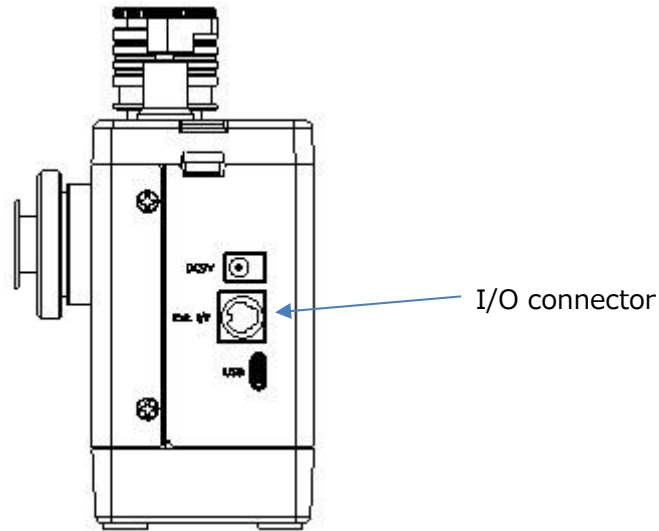

Signal table

Feature	Color	Signal
Analog output	Red	ANALOG +
	Black	ANALOG -
Alarm output	White	ALARM +
	Blue	ALARM -
Pulse output	Yellow	PULSE +
	Green	PULSE -

For signal details and settings, see Section 3.4.4 "E-Analog Output/Alarm Settings"

5.7 I/O cable (Communication)

The I/O cable (communication) (3444-21) is used for RS-232C communication and external power supply. Insert the plug of the I/O cable (communication) into the I/O connector on the side of the main unit.

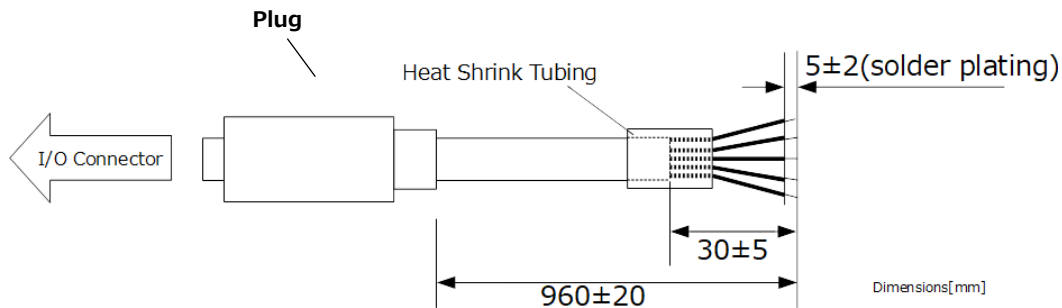

Signal table

Feature	Color	Signal
RS-232C	White-Red	TxD
	White-Black	RxD
	Gray-Black	GND
DC Input	Orange-Red	+9V
	Orange-Black	GND

PC D-Sub 9 pin

No	Signal
2	RD(RxD)
3	SD(TxD)
7	RS(RTS)
8	CS(CTS)
5	SG

DC input specifications

+9V \pm 5%



Note: When RS-232C or DC input is not used, wrap insulation tape around the wires to prevent short circuits.

6. Specifications

Name	Light scattering digital dust monitor
Model	Model 3444
Range	0.001~10.000 mg/m ³ (1 CPM=0.001 mg/m ³ at standard particles)
Accuracy	± (10% of indicated value+1) count
Linearity	±5% of indicated value
Measurement Mode	<ul style="list-style-type: none"> ① Standard mode (6,10,30 seconds, 1,2,3,5,10 minutes) ② Free mode (set from 1 to 59 seconds or from 1 to 99 minutes) ③ Manual mode (start and end measurement manually) ④ TWA mode (measurement time and alarm can be set for measurement) ⑤ Calculation mode (Measurement can be repeated by setting the measurement start time, measurement time, and number of measurements. Measurement data is stored in the main unit internal memory) ⑥ User calibration (background and sensitivity adjustment) ⑦ Cleaning
Light source	Semiconductor laser diode
Detector	Photodiode
Measurement method	Light scattering type
Display	Color LCD
Output	Analog output (The output range can be switched by setting) <ul style="list-style-type: none"> •0~1,000CPM 0~1V •0~10,000CPM 0~1V •0~1,000CPM 0~1V、1,000~10,000CPM 0.1~1V (AUTO) Pulse output (Photocoupler output) Alarm output (Photocoupler output)
Communication	USB port <ul style="list-style-type: none"> •Reading and writing stored data •Parameter setting •Remote measurement
K value (mass concentration conversion factor)	Setting range 0.1 to 9.9 0.1 step
Data Storage	100,000 stored data points Stored data readout and display
Power	AA dry cell batteries (6 pcs.) AC adapter (input 100-240V) (optional)
Main unit operating environment	Temperature: 5 to 40°C, Humidity: 95%RH or less (no condensation)
Main unit storage environment	Temperature 0 to 45°C Humidity 95%RH or less (no condensation)
External Dimensions	162×60×109mm (excluding protrusions)
Weight	About 1.3kg (includes 6 AA batteries)

Accessory	Shoulder strap, 6 AA size dry cell batteries (for testing), LCD protection sheet, USB cable for communication, measurement software, instruction manual.
Optional items	Output cable (analog), I/O cable (communication), USB cable for communication, tube connection inlet adapter, cyclone connection adapter, tripod fixing L angle, dust monitor cover, protector, pump filter, purge filter, AC adapter

7. Trouble Shooting

7.1 Check power

Problem	Possible cause(s) / Solution(s)	Reference
The screen display does not appear or turns off immediately after turning on the power switch.	•In case of batteries: Batteries are depleted. Turn off the power and replace the batteries.	13
	•For AC adapter: Make sure using a dedicated AC adapter.	14

7.2 Checking during measurement

Problem	Possible cause(s) / Solution(s)	Reference
The count value remains at 0.	The inlet cover is still on top (closed). Lower the inlet cover and push in (close) the filter open/close knob for measurement.	9, 51
	The exhaust vent is blocked. Remove any objects blocking the exhaust vent.	9, 51
The count value is too low.	The filter open/close knob is not closed. Push the filter open/close knob in to close it.	9, 51
	Compare the count value at the time of sensitivity check with the reference CPM value. If the value is lower than 5%, adjust the sensitivity by user calibration.	17, 36
The count value is too high.	The sensitivity control knob is set to "FULL" Set the sensitivity control knob back to "ZERO".	9, 51
	Compare the count value at the time of sensitivity check with the reference CPM value; if it is higher than 5%, adjust the sensitivity by user calibration.	17, 36

7.3 Background check

Problem	Possible cause(s) / Solution(s)	Reference
Background is not stable.	Inlet cover is not raised up or not fully raised. Raise up (close) inlet cover correctly.	9, 36
	The purge filter is clogged. Please replace with a new purge filter.	52
	The inside of the optical system is contaminated. Be aware that relatively light particles such as carbon and resin can enter the optics and cause elevated background readings. Please clean the optics thoroughly (at least 10 minutes). If the problem persists, the optics may need to be cleaned. Please contact our service center or distributor for repair.	41
	The product is used outside the operating ambient temperature range. The operating temperature range is 5 to 40°C (41 to 104°F) with a humidity of 95% RH or less.	62
Unable to perform background adjustment.	The sensitivity control knob is not set to the "ZERO" side. Turn it fully to the "ZERO" side.	9, 36
	The product is used outside the operating ambient temperature range. The operating temperature range is 5 to 40°C (41 to 104°F) with a humidity of 95%RH or less.	62

7.4 Sensitivity check

Problem	Possible cause(s) / Solution(s)	Reference
Value is lower than the reference CPM value. Poor reproducibility.	The sensitivity control knob is not set to the "FULL" side. Turn it fully to the "FULL" side.	9, 36
	The product is used outside the operating ambient temperature range. The operating temperature range is 5 to 40°C (41 to 104°F) with a humidity of 95%RH or less.	62
Unable to adjust sensitivity.	The inlet cover is still on top (closed). Lower the inlet cover and push in (close) the filter open/close knob for measurement.	9, 36
	The product is used outside the operating ambient temperature range. The operating temperature range is 5 to 40°C (41 to 104°F) with a humidity of 95%RH or less.	62
	The sensitivity may be out of the specified sensitivity adjustment range, or the light source may have deteriorated. Please contact our service center or distributor for repair.	9, 36

7.5 Calibration check

Problem	Possible cause(s) / Solution(s)	Reference
Unable to complete background adjustment. (BACKGROUND)	The specified background adjustment range is exceeded. If the background adjustment range exceeds ± 20 counts from the manufacturer's shipment, a calibration error has occurred. Please contact our service center or distributor for repair.	17, 36
Sensitivity cannot be adjusted. (SPAN)	The specified sensitivity adjustment range is exceeded. If the sensitivity adjustment range exceeds $\pm 20\%$ from the manufacturer's shipment, a calibration error will occur. Please contact our service center or distributor for repair.	17, 36
	The standard scattering plate may be defective, or the light source may be deteriorated. Please contact our service center or distributor for repair.	–

7.6 Analog output

Problem	Possible cause(s) / Solution(s)	Reference
No output.	The plug is not properly inserted to the output terminal. Make sure using a dedicated output cable.	45
Output value is incorrect.	The output cable is not connected correctly.	45
	The load impedance is set lower than the specified value. (Load impedance: 1 k Ω or more)	
The output value exceeds 1V.	The instantaneous value exceeds a concentration equivalent to 10,000 CPM.	45
Responsiveness is slow.	Output is updated every second.	45
Display and output voltage do not match.	The output range is not set correctly. • 0 – 1,000CPM range: 0 – 1V • 0 – 10,000CPM range: 0 – 1V • AUTO range: 0-1V for 0-1,000CPM, 0.1-1V for 1,000-10,000CPM	45
	CPM of analog output is an instantaneous value. It is different from the count (totalization) on the display screen.	45

7.7 Pulse output

Problem	Possible cause(s) / Solution(s)	Reference
No output.	The plug is not properly inserted to the output terminal. Make sure using a dedicated output cable.	48
Output signal levels are different.	Make sure to use the voltage and current within the rated range.	48
	Make sure the polarity (+, -) is correct.	
The output value is over	The instantaneous value exceeds a concentration equivalent to 10,000 CPM.	48

7.8 Alarm output

Problem	Possible cause(s) / Solution(s)	Reference
No output. Or the output timing is unknown.	The plug is not properly inserted to the output terminal. Make sure using a dedicated output cable. Make sure the alarm setpoint is set correctly. Make sure the alarm is set to ON.	45
	The alarm is only output during the start to the end of the measurement.	45
Output signal levels are different.	Make sure to use the voltage and current within the rated range.	45
	Make sure the polarity (+, -) is correct.	
Alarm is always output.	The instantaneous value exceeds a concentration equivalent to 10,000 CPM.	45

7.9 Date and Time Setting

Problem	Possible cause(s) / Solution(s)	Reference
Date/time is significantly off. Or reset continuously after setting.	The backup battery is going to run out. We recommend replacing the backup battery at the time of periodic calibration (1 year). Please contact our service center or distributor. The battery life varies depending on the frequency of use, operating environment. Since the backup battery is a primary battery, it cannot be charged when the main unit is powered on.	42

8. Warranty and After-Sales Service

The limited warranty set below is given by KANOMAX JAPAN, Inc. (hereafter referred to as "KJI") with respect to this instrument, its attachment parts including standard accessories (hereafter referred to as "PRODUCT") that you have purchased. PRODUCT you have purchased shall be the only one that the limited warranty stated herein applies to.

Your PRODUCT, when delivered to you in new condition in its original container, is warranted against defects in materials or workmanship as follows: for a period of one (1) year from the date of original purchase, defective parts or a defective PRODUCT returned to KJI, as applicable, and proven to be defective upon inspection, will be exchanged for a new or comparable rebuilt parts, or a refurbished PRODUCT as determined by KJI. Warranty for such replacements shall not extend the original warranty period of the defective PRODUCT.

To obtain service under this warranty, you must notify KJI on or before the expiration of the warranty period to obtain directions for returning the defective product. You are responsible for all return shipping charges to the authorized KANOMAX service center.

This limited warranty covers all defects encountered in normal use of the PRODUCT, and does not apply to the following cases:

- (1) Use of parts or supplies other than the PRODUCT sold by KJI, which cause damage to the PRODUCT or cause abnormally frequent service calls or service problems.
- (2) If any PRODUCT has its serial number or date altered or removed.
- (3) Loss or damage to the PRODUCT due to abuse, mishandling, improper packaging by the owner, alteration, accident, electrical current fluctuations, failure to follow operating, maintenance or environmental instructions prescribed in the PRODUCT's instruction manual provided by KJI, or service performed by other than KJI.

NO IMPLIED WARRANTY, INCLUDING ANY IMPLIED WARRANTY OF MERCHANTABILITY OR FITNESS FOR A PARTICULAR PURPOSE, APPLIES TO THE PRODUCT AFTER THE APPLICABLE PERIOD OF THE EXPRESS LIMITED WARRANTY STATED ABOVE, AND NO OTHER EXPRESS WARRANTY OR GUARANTY, EXCEPT AS MENTIONED ABOVE, GIVEN BY ANY PERSON OR ENTITY WITH RESPECT TO THE PRODUCT SHALL BIND KJI. KJI SHALL NOT BE LIABLE FOR LOSS OF STORAGE CHARGES, LOSS OR CORRUPTION OF DATA, OR ANY OTHER SPECIAL, INCIDENTAL OR CONSEQUENTIAL DAMAGES CAUSED BY THE USE OR MISUSE OF, OR INABILITY TO USE, THE PRODUCT, REGARDLESS OF THE LEGAL THEORY ON WHICH THE CLAIM IS BASED, AND EVEN IF KJI HAS BEEN ADVISED OF THE POSSIBILITY OF SUCH DAMAGES. IN NO EVENT SHALL RECOVERY OF ANY KIND AGAINST KJI BE GREATER IN AMOUNT THAN THE PURCHASE PRICE OF THE PRODUCT SOLD BY KJI AND CAUSING THE ALLEGED DAMAGE. WITHOUT LIMITING THE FOREGOING, THE OWNER ASSUMES ALL RISK AND LIABILITY FOR LOSS, DAMAGE OF, OR INJURY TO THE OWNER AND THE OWNER'S PROPERTY AND TO OTHERS AND THEIR PROPERTY ARISING OUT OF USE OR MISUSE OF, OR INABILITY TO USE, THE PRODUCT NOT CAUSED DIRECTLY BY THE NEGLIGENCE OF KJI. THIS LIMITED WARRANTY SHALL NOT EXTEND TO ANYONE OTHER THAN THE ORIGINAL PURCHASER OF THE PRODUCT, OR THE PERSON FOR WHOM IT WAS PURCHASED AS A GIFT, AND STATES THE PURCHASER'S EXCLUSIVE REMEDY.

9. Contact Information



If you have any questions or inquiries about this product, please check the contact information below, as it depends on the region where you purchased the product.

□ U.S.A.

KANOMAX USA, INC.

219 US Hwy 206, Andover, New Jersey 07821 U.S.A.

TEL: (800)-247-8887 / (973)-786-6386

FAX: (973)-786-7586

URL: <http://www.kanomax-usa.com/>

E-Mail: info@kanomax-usa.com

□ JAPAN

KANOMAX JAPAN INC.

2-1 Shimizu, Suita City, Osaka 565-0805, Japan

TEL: 81-6-6877-0183

FAX: 81-6-6879-5570

URL: <http://www.kanomax.co.jp>

E-Mail: sales@kanomax.co.jp

KANOMAX JAPAN INC. ©2023

Reprinting of part or the whole of the contents of this manual is strictly forbidden.

The contents of this manual are subject to change without notice.

01001/2303



KANOMAX
The Ultimate Measurements