

Keysight N1921A and N1922A P-Series Wideband Power Sensor

Operating and
Service Guide

Notices

Copyright Notice

© Keysight Technologies 2005 - 2021
No part of this manual may be reproduced in any form or by any means (including electronic storage and retrieval or translation into a foreign language) without prior agreement and written consent from Keysight Technologies as governed by United States and international copyright laws.

Manual Part Number

N1920-90007

Edition

Edition 12, November 1, 2021

Printed in:

Printed in Malaysia

Published by:

Keysight Technologies
Bayan Lepas Free Industrial Zone,
11900 Penang, Malaysia

Technology Licenses

The hardware and/or software described in this document are furnished under a license and may be used or copied only in accordance with the terms of such license.

Declaration of Conformity

Declarations of Conformity for this product and for other Keysight products may be downloaded from the Web. Go to <http://www.keysight.com/go/conformity>. You can then search by product number to find the latest Declaration of Conformity.

U.S. Government Rights

The Software is "commercial computer software," as defined by Federal Acquisition Regulation ("FAR") 2.101. Pursuant to FAR 12.212 and 27.405-3 and Department of Defense FAR Supplement ("DFARS") 227.7202, the U.S. government acquires commercial computer software under the same terms by which the software is customarily provided to the public. Accordingly, Keysight provides the Software to U.S. government customers under its standard commercial license, which is embodied in its End User License Agreement (EULA), a copy of which can be found at <http://www.keysight.com/find/sweula>. The license set forth in the EULA represents the exclusive authority by which the U.S. government may use, modify, distribute, or disclose the Software. The EULA and the license set forth therein, does not require or permit, among other things, that Keysight: (1) Furnish technical information related to commercial computer software or commercial computer software documentation that is not customarily provided to the public; or (2) Relinquish to, or otherwise provide, the government rights in excess of these rights customarily provided to the public to use, modify, reproduce, release, perform, display, or disclose commercial computer software or commercial computer software documentation. No additional government requirements beyond those set forth in the EULA shall apply, except to the extent that those terms, rights, or licenses are explicitly required from all providers of commercial computer software pursuant to the FAR and the DFARS and are set forth specifically in writing elsewhere in the EULA. Keysight shall be under no obligation to update, revise or otherwise modify the Software. With respect to any technical data as defined by FAR 2.101, pursuant to FAR 12.211 and 27.404.2 and DFARS 227.7102, the U.S. government acquires no greater than Limited Rights as defined in FAR 27.401 or DFAR 227.7103-5 (c), as applicable in any technical data.

Warranty

THE MATERIAL CONTAINED IN THIS DOCUMENT IS PROVIDED "AS IS," AND IS SUBJECT TO BEING CHANGED, WITHOUT NOTICE, IN FUTURE EDITIONS. FURTHER, TO THE MAXIMUM EXTENT PERMITTED BY APPLICABLE LAW, KEYSIGHT DISCLAIMS ALL WARRANTIES, EITHER EXPRESS OR IMPLIED, WITH REGARD TO THIS MANUAL AND ANY INFORMATION CONTAINED HEREIN, INCLUDING BUT NOT LIMITED TO THE IMPLIED WARRANTIES OF MERCHANTABILITY AND FITNESS FOR A PARTICULAR PURPOSE. KEYSIGHT SHALL NOT BE LIABLE FOR ERRORS OR FOR INCIDENTAL OR CONSEQUENTIAL DAMAGES IN CONNECTION WITH THE FURNISHING, USE, OR PERFORMANCE OF THIS DOCUMENT OR OF ANY INFORMATION CONTAINED HEREIN. SHOULD KEYSIGHT AND THE USER HAVE A SEPARATE WRITTEN AGREEMENT WITH WARRANTY TERMS COVERING THE MATERIAL IN THIS DOCUMENT THAT CONFLICT WITH THESE TERMS, THE WARRANTY TERMS IN THE SEPARATE AGREEMENT SHALL CONTROL.

Safety Information

CAUTION

A CAUTION notice denotes a hazard. It calls attention to an operating procedure, practice, or the like that, if not correctly performed or adhered to, could result in damage to the product or loss of important data. Do not proceed beyond a CAUTION notice until the indicated conditions are fully understood and met.

WARNING

A WARNING notice denotes a hazard. It calls attention to an operating procedure, practice, or the like that, if not correctly performed or adhered to, could result in personal injury or death. Do not proceed beyond a WARNING notice until the indicated conditions are fully understood and met.

General Warranty





The material contained in this document is provided "as is," and is subject to being changed, without notice, in future editions. Further, to the maximum extent permitted by applicable law, Keysight disclaims all warranties, either express or implied with regard to this manual and any information contained herein, including but not limited to the implied warranties of merchantability and fitness for a particular purpose. Keysight shall not be liable for errors or for incidental or consequential damages in connection with the furnishing, use, or performance of this document or any information contained herein. Should Keysight and the user have a separate written agreement with warranty terms covering the material in this document that conflict with these terms, the warranty terms in the separate agreement will control.

Certification

Keysight Technologies certifies that this product met its published specifications at the time of shipment from the factory. Keysight Technologies further certifies that its calibration measurements are traceable to the United States National Institute of Standards and Technology, to the extent allowed by the Institute's calibration facility, and to the calibration facilities of other International Standards Organization members.

Safety Symbols

The following symbols on the instrument and in the documentation indicate precautions which must be taken to maintain safe operation of the instrument.

	<p>The Instruction Documentation Symbol. The product is marked with this symbol when it is necessary for the user to refer to the instructions in the supplied documentation.</p>	 <p>The CE mark is a registered trademark of the European Community. This CE mark shows that the product complies with all the relevant European Legal Directives.</p>
 <p>ESD</p>	<p>This symbol indicates that a device, or part of a device, may be susceptible to electrostatic discharges (ESD) which can result in damage to the product. Observe ESD precautions given on the product, or its user documentation, when handling equipment bearing this mark.</p>	<p>ICES/NMB-001</p> <p>ICES/NMB-001 indicates that this ISM device complies with the Canadian ICES-001. Cet appareil ISM est conforme a la norme NMB-001 du Canada.</p>
<p>ISM GRP.1 CLASS A</p>	<p>This is the symbol of an Industrial Scientific and Medical Group 1 Class A product.</p>	 <p>The RCM mark is a registered trademark of the Spectrum Management Agency of Australia. This signifies compliance with the Australia EMC Framework regulations under the terms of the Radio Communication Act of 1992.</p>

Safety Notices

This guide uses warnings and cautions to denote hazards

WARNING

A warning calls attention to a procedure, practice or the like, which, if not correctly performed or adhered to, could result in injury or loss of life. Do not proceed beyond a warning until the indicated conditions are fully understood and met.

CAUTION

A caution calls attention to a procedure, practice or the like which, if not correctly performed or adhered to, could result in damage to or the destruction of part or all of the equipment. Do not proceed beyond a caution until the indicated conditions are fully understood and met.

General Safety Information

The following general safety precautions must be observed during all phases of operation, service, and repair of this instrument. Failure to comply with these precautions or with specific warnings elsewhere in this manual violates safety standards of design, manufacture, and intended use of the instrument. Keysight Technologies assumes no liability for the customer's failure to comply with these requirements.

WARNING

BEFORE CONNECTING THE POWER SENSOR TO OTHER INSTRUMENTS ensure that all instruments are connected to the protective (earth) ground. Any interruption of the protective earth grounding will cause a potential shock hazard that could result in personal injury.

Sound Emission

Herstellerbescheinigung

Diese Information steht im Zusammenhang mit den Anforderungen der Maschinenlarminformationsverordnung vom 18 Januar 1991.

- Sound Pressure LpA < 70 dB.
- Am Arbeitsplatz.
- Normaler Betrieb.
- Nach DIN 45635 T. 19 (Typprüfung).

Manufacturers Declaration

This statement is provided to comply with the requirements of the German Sound DIN 45635 T. 19 (Typprüfung).

- Sound Pressure LpA < 70 dB.
- At operator position.
- Normal operation.
- According to ISO 7779 (Type Test).

Waste Electrical and Electronic Equipment (WEEE) Directive

This instrument complies with the WEEE Directive marking requirement. This affixed product label indicates that you must not discard this electrical or electronic product in domestic household waste.

Product category:

With reference to the equipment types in the WEEE directive Annex 1, this instrument is classified as a “Monitoring and Control Instrument” product.

The affixed product label is as shown below.



Do not dispose in domestic household waste.

To return this unwanted instrument, contact your nearest Keysight Service Center, or visit <http://about.keysight.com/en/companyinfo/environment/takeback.shtml> for more information.

Sales and Technical Support

To contact Keysight for sales and technical support, refer to the support links on the following Keysight websites:

- www.keysight.com/find/powersensors
(product-specific information and support, software and documentation updates)
- www.keysight.com/find/assist
(worldwide contact information for repair and service)

Table of Contents

General Warranty	3
Certification	3
Safety Symbols	4
Safety Notices	5
General Safety Information	6
Sound Emission	7
Waste Electrical and Electronic Equipment (WEEE) Directive	8
Product category:	8
Sales and Technical Support	8
1 Introduction	
General Information	16
Initial inspection	16
Power meter and sensor cable requirements	17
Interconnections	17
Recommended calibration interval	18
Calibration	20
Overview of the P-Series Wideband Power Sensors	21
The Internal Zero and Calibration	21
2 Performance Tests and Adjustments	
Test Equipment	26
Voltage Standing Wave Ratio (VSWR) Performance Test	27
Power Accuracy Verification	29
System-Level Rise and Fall Time Performance Test	36
Zero Set Performance Test in System Level	39
Adjustment	42
3 Theory of Operation	
Theory of Operation	44

4 Characteristics and Specifications

5 Service

General Information	50
Cleaning	50
Connector cleaning	50
Performance test	50
Troubleshooting	51

List of Figures

Figure 1-1	P-Series Wideband Power Sensors	16
Figure 1-2	Connecting a sensor cable to a power meter	18
Figure 1-3	Simplified sensor block diagram	21
Figure 2-1	Sensor accuracy performance test setup for the N1921/2A (50 MHz to 18 GHz)	31
Figure 2-2	Sensor accuracy performance test setup for the N1921/2A (50 MHz to 18 GHz)	32
Figure 2-3	Sensor accuracy performance test setup for the N1922A (26.5 GHz to 40 GHz)	33
Figure 2-4	Sensor accuracy performance test setup for the N1922A (26.5 GHz to 40 GHz)	34
Figure 2-5	Measured rise time percentage error versus signal under test rise time	36
Figure 2-6	System-level rise and fall time performance test setup	37
Figure 2-7	Zero set performance test in system level setup	40
Figure 3-1	Simplified sensor block diagram	44
Figure 3-2	Measured rise time percentage error versus signal-under-test rise time	45

THIS PAGE HAS BEEN INTENTIONALLY LEFT BLANK.

List of Tables

Table 1-1	Cable length options	17
Table 1-2	Wrench size and torque values	19
Table 1-3	Adapter	23
Table 2-1	Voltage Standing Wave Ratio (VSWR) performance test	28
Table 2-2	Maximum Test System Uncertainty	29
Table 2-3	Power Accuracy Verification Specification (Sensor Calibration Uncertainty + Maximum Test System Uncertainty)	30

THIS PAGE HAS BEEN INTENTIONALLY LEFT BLANK.

1 Introduction

General Information	16
Calibration	20
Overview of the P-Series Wideband Power Sensors	21

General Information

Welcome to the P-Series Wideband Power Sensors Operating and Service Guide. This guide contains information about the initial inspection, connection, and specifications of the P-Series Wideband Power Sensors. You can also find a copy of this guide on the Documentation CD-ROM supplied with the P-series power meters.



Figure 1-1 P-Series Wideband Power Sensors

To make best use of your sensor refer to the chapter “Using P-Series Power Sensors” in the *P-Series Power Meter User’s Guide*.

Initial inspection

Inspect the shipping container for damage. If the shipping container or packaging material is damaged, it should be kept until the contents of the shipment have been checked mechanically and electrically. If there is mechanical damage, notify the nearest Keysight office. Keep the damaged shipping materials (if any) for inspection by the carrier and a Keysight representative. See “**Troubleshooting**” on page 51.

Power meter and sensor cable requirements

The P-Series Wideband Power Sensors are **ONLY** compatible with the P-Series Power Meters.

Table 1-1 lists the length of cable option, these have no interconnecting cable requirements, as the cable is permanently connected (hard-wired) to the P-Series Wideband power sensor.

Table 1-1 Cable length options

Option	Description
N1921A-105 N1922A-105	1.5m (5-ft) cable length
N1921A-106 N1922A-106	3m (10-ft) cable length
N1921A-107 N1922A-107	10m (31-ft) cable length

Interconnections

Connect the cable to the P-Series power meter's channel input. **Figure 1-2** shows that you **must** align the red dot on the sensor's cable and the meter's connector.

WARNING

BEFORE CONNECTING THE POWER SENSOR TO OTHER INSTRUMENTS ensure that all instruments are connected to the protective (earth) ground. Any interruption of the protective earth grounding will cause a potential shock hazard that could result in personal injury.

Recommended calibration interval

Keysight Technologies recommends a one-year calibration cycle for the P-Series power sensors.



Ensure you line up the red dots on the sensor cable and power meter's connector

Figure 1-2 Connecting a sensor cable to a power meter

Allow a few seconds for the power meter to read the data contained in the power sensor's EEPROM.

NOTE

Ensure power sensor cables are attached and removed in an indoor environment.

Torque

Table 1-2 shows the connector type (for connection to DUT) for the power sensor models. A torque wrench must be used to tighten these connectors. Only use a wrench set to the correct torque value.

Table 1-2 Wrench size and torque values

Model	Connector	Wrench size	Torque value
N1921A	Type-N (male)	3/4-inch open-end	12 in-lb (135 Ncm)
N1922A	2.4 mm (male)	5/16-inch open-end	8 in-lb (90 Ncm)

Calibration

When calibrating a P-Series Wideband Power Sensor, there is no need to disconnect it from the power source.

The power meter performs *Internal Zero* and Calibration routines. The process used for this *Internal Zero* and Calibration is explained in "[Overview of the P-Series Wideband Power Sensors](#)" on page 21.

The chapter "*Using P-Series Power Sensors*" in the *P-Series Power Meter User's Guide* explains in more detail the methods used to perform the zero and calibration of the power sensor.

Overview of the P-Series Wideband Power Sensors

The P-Series Wideband Power Sensors has two different models.

- The N1921A has a frequency range of 50 MHz to 18 GHz.
- The N1922A has a frequency range of 50 MHz to 40 GHz.

The *Internal Zero* and Calibration

The P-Series Wideband Power Sensor's *Internal Zero* and Calibration process is used to combine the power sensor and power meter to make accurate power measurements.

Referring to [Figure 1-3, "Simplified sensor block diagram"](#) the process for the *Internal Zero* and Calibration explains how three objectives in this process are achieved.

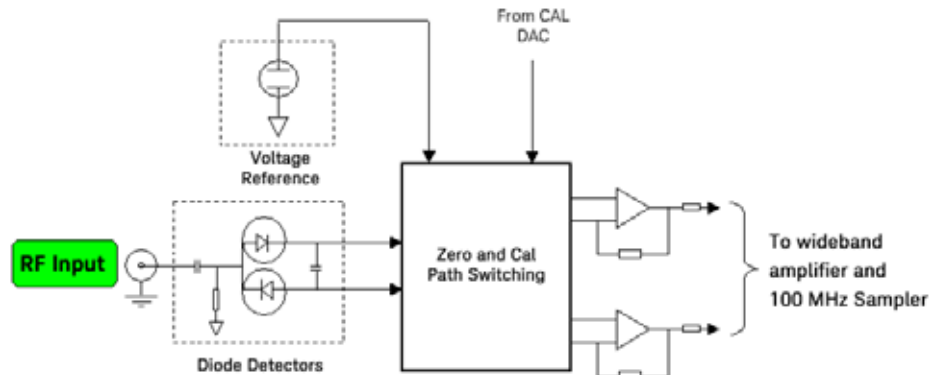

Figure 1-3 Simplified sensor block diagram

- 1 To account for the environment that the system is working in – the temperature and the presence of electromagnetic signals.

This is achieved during the *Internal Zero* process, where the Diode Detectors are isolated from the active amplifier circuitry. The process allows the zero measurement to be made, regardless of the RF input signal, thus allowing the sensor to remain connected to the DUT. The isolation is achieved by a network of transistor switches in the zero and calibration path switching.

- 2 To account for the combining of the sensor and meter, as these may never have been used together as a system.

This is achieved during the *Internal Calibration*, the Amplifier Circuitry is isolated from the Diode Detectors by a network of transistor switches and the sensor's voltage reference is routed to the Amplifier Circuitry.

- 3 To verify traceability to National Standards, hence, verifying your measurements are going to perform to specification.

To achieve traceable and accurate RF power measurements, each sensor is individually characterized during its production procedure. To achieve optimal accuracy, a 3-dimensional correction is generated across power, frequency and temperature. This uses advanced modeling techniques, and is superior in accuracy and speed of evaluation to the overlaying of linearity, temperature corrections and calibration factors.

As a *confidence check* of the connector integrity, the P-Series Wideband Power Sensor can be connected to any known good signal source (for example, the 50 MHz, 0 dBm reference) and a comparison made.

The calibration factors are stored in the EEPROM during the manufacturing process. All the compensation data is downloaded to the P-series power meter at power-on or when the power sensor is connected.

NOTE

Between 50 MHz and 500 MHz, the sensor is sensitive to the RF signal propagating through onto the Detector Amplifier Circuitry and resulting in distorted power measurements. To reduce this effect, additional filtering is switched into the measurement path, which results in a 15 MHz video bandwidth limitation for signals below 500 MHz.

The P-Series Wideband Power Sensor performs internal zero and calibration automatically upon AC power up. However, to perform a manual confidence check with an external reference power source (1 mW, 50 Mhz) a 2.4 mm (f) to N-type (m) adapter is needed as the P-Series Wideband Power Sensor is fitted with a 2.4 mm (m) connector. This adapter is not shipped together with the P-Series Wideband Power Sensor.

Table 1-3 Adapter

Part number	Description	Item
08487-60001	Adapter 50 MHz, 2.4 mm	

NOTE

The 2.4 mm (f) to N-type (m) adapter is intended for use only on the 1 mW, 50 MHz power reference of the power meter. Its function as a calibration reference may be compromised if used for other purposes.

THIS PAGE HAS BEEN INTENTIONALLY LEFT BLANK.

2 Performance Tests and Adjustments

Test Equipment	26
Voltage Standing Wave Ratio (VSWR) Performance Test	27
Power Accuracy Verification	29
System-Level Rise and Fall Time Performance Test	36
Zero Set Performance Test in System Level	39
Adjustment	42

Test Equipment

The following equipment are required for the performance tests:

Instrument	Critical specification	Recommended Keysight model number/part number
Signal generator (rise/fall time)	Power range: -50 dBm to +22 dBm at 1 GHz Output resistance: 50 Ω	EXG/MXG
Signal generator (zero set)	Power range: -50 dBm to +20 dBm at 1 GHz Output resistance: 50 Ω	N5172B
Pulse generator	400 MHz, 3.8 V, 50 Ω into 50 Ω	81130A
Network analyzer	Frequency range: 10 MHz to 40 GHz or above 94 dB of dynamic range <0.006 dB trace noise	E8361A/E8361C/E8363B/E8363C
Calibration kit	Frequency range: DC to 18 GHz or above	85054A/85054D/85056A/85056D
Power splitter	Two-resistor type power splitter, N-type (f) max Frequency: 18 GHz	11667A
Power meter	Dual channel peak power meter compatible with P Series and N8480 Series power sensor Absolute accuracy: $\pm 0.8\%$	N1912A
Power sensor	Frequency: 50 MHz or above Power range: -30 dBm to +20 dBm SWR: ≤ 1.15 at 50 MHz	N8481A/N8487A
Wideband power sensor	Power range: -30 dBm to +20 dBm SWR: ≤ 1.20 at 1 GHz	N1921A/N1922A
Amplifier	Frequency range: 26.5 GHz to 40 GHz Gain (min): 30 dB Pin (max): 0 dBm	KMA 265400B02 (KMIC)
Cable adapter	11730A sensor cable adapter	N1911A-200
N-type to SMA adapter	N-type (m) to 2.4 mm (f) SMA 50 Ω characteristic impedance	11903D

Voltage Standing Wave Ratio (VSWR) Performance Test

VSWR (Voltage Standing Wave Ratio) is a measure of how efficiently RF power is transmitted from an RF power source. In real systems, mismatched impedances between the RF source and load can cause some of the power to be reflected back towards the source and vary the VSWR.

Test equipment

- Network analyzer (E8361A/3B/4B)
- Keysight calibration kit (85054A/D or 85056A/D)

Test procedure

- 1 Turn on the network analyzer and allow it to warm up for approximately an hour.
- 2 Set the start frequency of the network analyzer to 50 MHz and the stop frequency to 18 GHz (for the N1921A) and 40 GHz (for the N1922A).
- 3 Calibrate the network analyzer using the appropriate calibration kit (85054A/D for the N1921A and 85056A/D for the N1922A). Perform calibration for the open, short, and load circuits of the network analyzer.
- 4 After calibration, connect the N1923/4A to the test port of the network analyzer. Turn on **Correction** on the network analyzer to perform the VSWR measurement.
- 5 Compare the measured results to the specifications in [Table 2-1](#).
- 6 If the test fails, refer to ["Adjustment"](#) on page 42.

Table 2-1 Voltage Standing Wave Ratio (VSWR) performance test

Sensor model	Frequency band	Maximum SWR
N1921A	50 MHz to 10 GHz	1.2
	10 GHz to 18 GHz	1.26
N1922A	50 MHz to 10 GHz	1.2
	10 GHz to 18 GHz	1.26
	18 GHz to 26.5 GHz	1.3
	26.5 GHz to 40 GHz	1.5

Power Accuracy Verification

The purpose of this test is to verify the compliance of calibration of N1921A and N1922A (DUT) after a period of usage to ensure that the N1921A and N1922A still works within its published calibration uncertainty specifications.

Power Accuracy Verification performance test is to compare sensor measurement against a calibrated test port signal where the system uncertainty should not be greater than the values stated in [Table 2-2](#). The specifications of the sensor are defined as the sum of Calibration Uncertainty and Maximum Test System Uncertainty for each frequency band, contributed by both N1921A and N1922A Power Sensor and test system used to conduct verification test. Since the test system used for Power Accuracy Verification is different from the characterization, therefore the uncertainty of test system should not be ignored.

Verification error (%) from Power Accuracy Verification during periodical calibration should meet the specifications stated in [Table 2-2](#) to confirm its compliance. Relative expanded uncertainty available in the data sheet (<https://www.keysight.com/my/en/assets/7018-01281/data-sheets/5989-2471.pdf>) should be taken as sensor's calibration uncertainty if compliance is confirmed.

Table 2-2 Maximum Test System Uncertainty

Frequency band	N1921A	N1922A
50 MHz to 500 MHz	3.5%	3.4%
>500 MHz to 1 GHz	2.7%	3.1%
>1 GHz to 10 GHz	2.9%	3.4%
>10 GHz to 18 GHz	3.3%	3.6%
>18 GHz to 26.5 GHz	–	3.8%
>26.5 GHz to 40 GHz	–	4.3%

Table 2-3 Power Accuracy Verification Specification (Sensor Calibration Uncertainty + Maximum Test System Uncertainty)

Frequency band	N1921A	N1922A
50 MHz to 500 MHz	8%	7.7%
>500 MHz to 1 GHz	6.7%	7.3%
>1 GHz to 10 GHz	6.9%	7.8%
>10 GHz to 18 GHz	8.3%	8.3%
>18 GHz to 26.5 GHz	–	9.7%
>26.5 GHz to 40 GHz	–	10.3%

The self-verification to verify the performance of N1921A and N1922A can be performed using the below methods. This performance verification requires the following equipment:

Test equipment

- Signal generator (E8257D)
- Power meter (N1912A)
- Wideband power sensor (N1921/2A)
- Power sensors (N8481A/N8487A)
- Cable adapter (N1911A-200)
- Power splitter (11667A/11667C)
- KMIC amplifier (KMA 265400B02)

Test procedure for the N1921/2A (50 MHz to 18 GHz)

- 1 Turn on the E8257D and N1912A. Allow them to warm up for approximately an hour.
- 2 Connect the standard sensor (N8481A/7A) to the N1912A channel A and the incident sensor (N1921/2A) to the N1912A channel B.
- 3 The test equipment setup is as shown in [Figure 2-1](#).

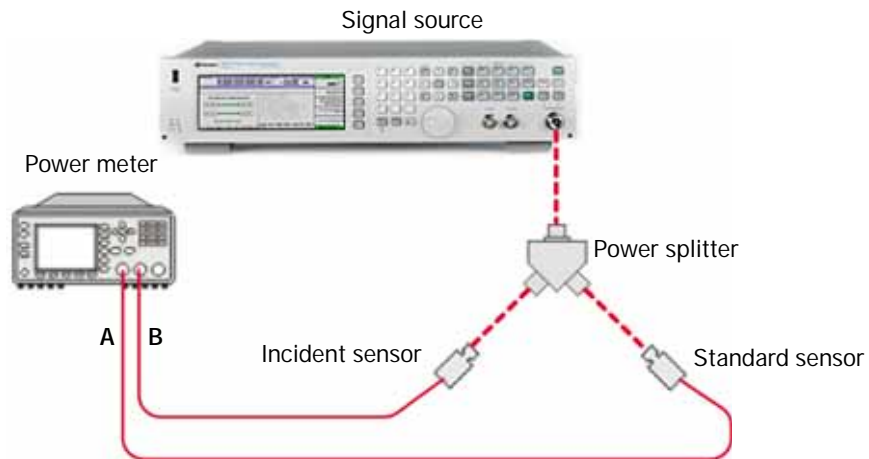

Figure 2-1 Sensor accuracy performance test setup for the N1921/2A (50 MHz to 18 GHz)

- 4 Zero and calibrate the standard and incident sensors on channels A and B respectively.
- 5 Set the frequency of the signal source to 50 MHz and power level to 0 dBm. Turn on the RF output.
- 6 Set the frequency of the N1912A channels A and B to the same frequency as the signal source.
- 7 Measure the standard power (P_{STD}) of channel A and incident power (P_{INC1}) of channel B. Compute and record the power ratio (P_{ratio}) of these channels for the current frequency and power level, based on the following equation:

$$P_{ratio}(dB) = P_{STD} - P_{INC1}$$
- 8 Repeat steps 5 to 7 for other frequencies with the same power level.
- 9 Turn off the RF output of the signal source.
- 10 Remove the standard sensor from the N1912A channel A.
- 11 Connect the device-under-test (DUT, N1921/2A) to the N1912A channel A.
- 12 The test equipment setup is as shown in [Figure 2-2](#).

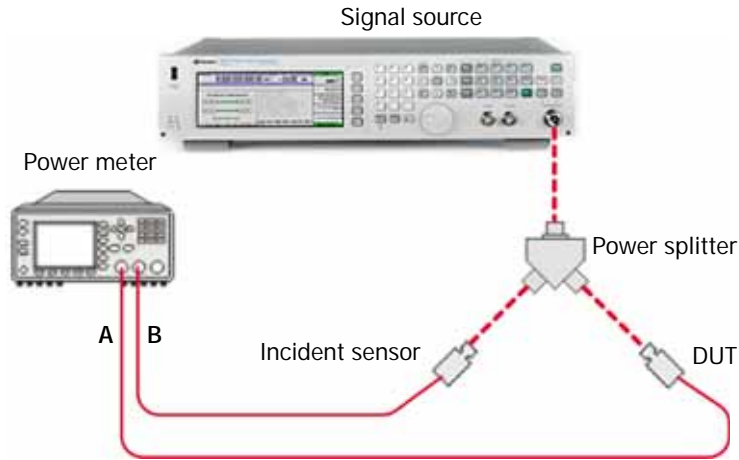

Figure 2-2 Sensor accuracy performance test setup for the N1921/2A (50 MHz to 18 GHz)

- 13 Zero and calibrate the DUT on the N1912A channel A.
- 14 Repeat steps 5 and 6.
- 15 Measure and record the power readings of channels A and B for the current frequency and power level, as P_{DUT} (for channel A) and P_{INC2} (for channel B).
- 16 Repeat steps 14 and 15 for other frequencies with the same power level.
- 17 Turn off the RF output of the signal source.
- 18 Compute the accuracy error of the DUT for each frequency being measured at the same power level, using the following equations:

$$Accuracy\ error\ (\%) \leq \pm \sqrt{(MU_{INC})^2 + (MU_{DUT})^2}$$

MU_{INC} and MU_{DUT} are the incident sensor combined uncertainty and DUT combined uncertainty values respectively.

NOTE

The measurement uncertainty values for incident sensor, standard sensor and DUT can be calculated using the Measurement Uncertainty Calculator tool available for each sensor under Resources tab on Keysight website.

- 19 Compare the computed accuracy errors to the calibration uncertainty values in [Table 2-3](#). If the test fails, refer to **“Adjustment”** on page 42.
- 20 Repeat steps 5 to 19 by sweeping through the power level from -25 dBm to 10 dBm with frequencies from 50 MHz to 18 GHz.

Extended test procedure for the N1922A (26.5 GHz to 40 GHz)

- 1 Turn on the E8257D and N1912A. Allow them to warm up for approximately an hour.
- 2 Connect the standard sensor (N8481A/7A) to the N1912A channel A and the incident sensor (N1922A) to the N1912A channel B.
- 3 The test equipment setup is as shown in [Figure 2-3](#).

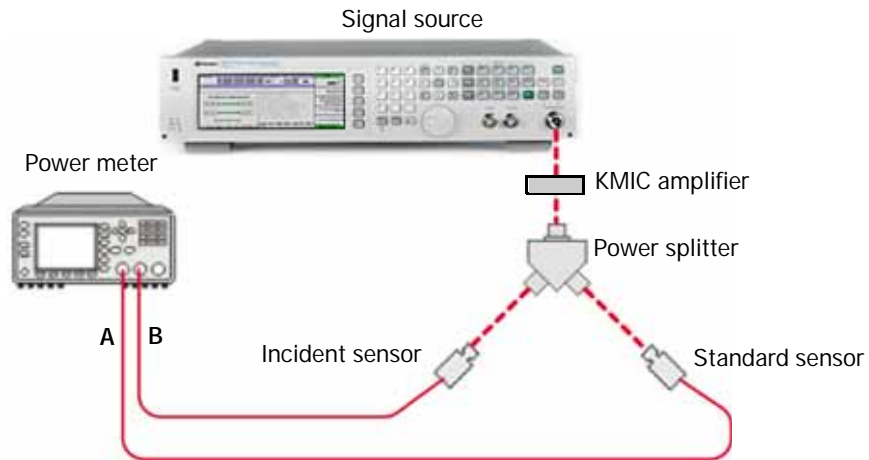

Figure 2-3 Sensor accuracy performance test setup for the N1922A (26.5 GHz to 40 GHz)

- 4 Zero and calibrate the standard and incident sensors on channels A and B respectively.
- 5 Set the frequency of the signal source to 26.5 GHz and power level to 10 dBm. Turn on the RF output.
- 6 Set the frequency of the N1912A channels A and B to the same frequency as the signal source.

- 7 Measure the standard power (P_{STD}) of channel A and incident power (P_{INC1}) of channel B. Compute and record the power ratio (P_{ratio}) of these channels for the current frequency and power level, based on the following equation:

$$P_{ratio}(dB) = P_{STD} - P_{INC1}$$

- 8 Repeat steps 5 to 7 for other frequencies with the same power level.
- 9 Turn off the RF output of the signal source.
- 10 Remove the standard sensor from the N1912A channel A.
- 11 Connect the device-under-test (DUT, N1922A) to the N1912A channel A.
- 12 The test equipment setup is as shown in **Figure 2-4**.

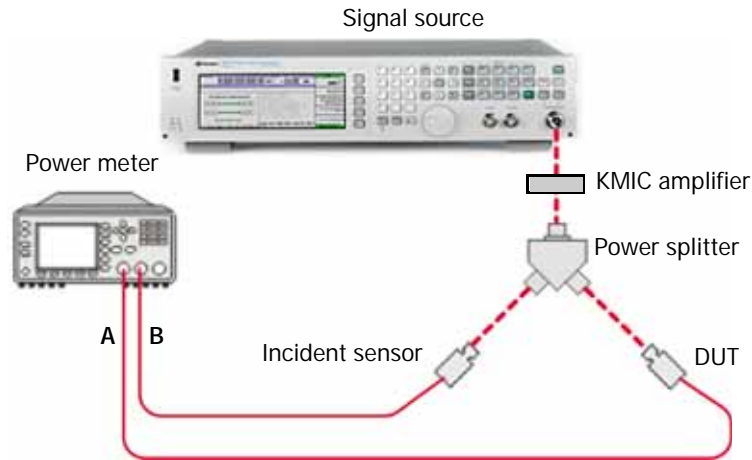

Figure 2-4 Sensor accuracy performance test setup for the N1922A (26.5 GHz to 40 GHz)

- 13 Zero and calibrate the DUT on the N1912A channel A.
- 14 Repeat steps 5 and 6.
- 15 Measure and record the power readings of channels A and B for the current frequency and power level, as P_{DUT} (for channel A) and P_{INC2} (for channel B).
- 16 Repeat steps 14 and 15 for other frequencies with the same power level.
- 17 Turn off the RF output of the signal source.
- 18 Compute the accuracy error of the DUT for each frequency being measured at the same power level, using the following equations:

$$\text{Accuracy error (\%)} \leq \pm\sqrt{(MU_{INC})^2 + (MU_{DUT})^2}$$

MU_{INC} and MU_{DUT} are the incident sensor combined uncertainty and DUT combined uncertainty values respectively.

NOTE

The measurement uncertainty values for incident sensor, standard sensor and DUT can be calculated using the Measurement Uncertainty Calculator tool available for each sensor under Resources tab on Keysight website.

- 19** Compare the computed accuracy errors to the calibration uncertainty values in [Table 2-3](#). If the test fails, refer to **"Adjustment"** on page 42.
- 20** Repeat steps 5 to 19 by sweeping through the power level from 10 dBm to 18 dBm with frequencies from 26.5 GHz to 40 GHz.

System-Level Rise and Fall Time Performance Test

The rise and fall time performance of the instrument path must be quantified accurately. This test however, is more of a system-level verification, validating the rise and fall time with the N1911/2A using an actual RF pulse.

Test equipment

- Signal generator (EXG/MXG)
- Pulse Generator (81130A)
- Power meter (N1911/2A)
- Trigger cable (U2032A)
- Wideband power sensor (N1921/2A)

System specification

- Rise/fall time: ≤ 13 ns
- *Overshoot*: $< 5\%$

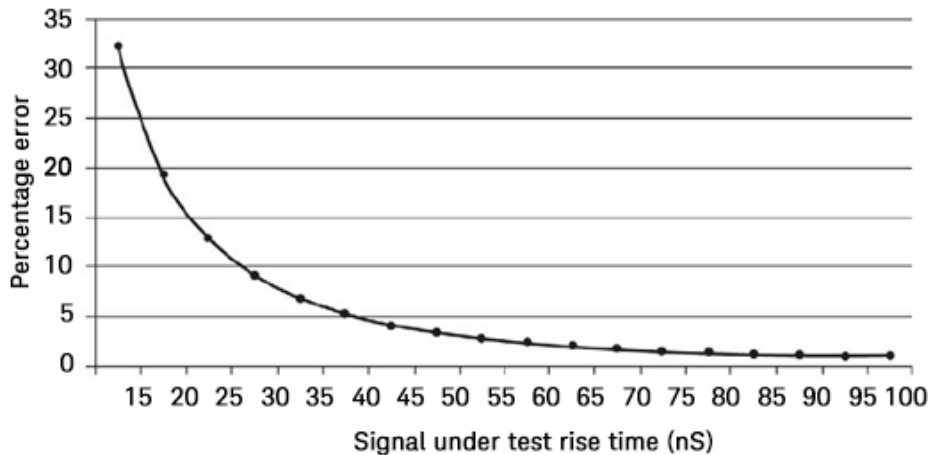

Figure 2-5 Measured rise time percentage error versus signal under test rise time

Test procedure

- 1 Turn on the 81131A, pulse generator and N1911/2A.
- 2 Allow the system to warm up for approximately an hour before starting the measurement.
- 3 Generate an RF pulse signal (with the following recommended signal profile) from the N5182A.
 - Frequency: 50 MHz
 - Power level: 10 dBm
 - Pulse period: 10 μ s
 - Duty cycle: 50%

The pulse signal is characterized using a diode detector which feeds to the oscilloscope. This is to verify that the rise/fall time of the RF pulse measured by the oscilloscope is <10 ns and its overshoot is <0.5%.

- 4 Set up the equipment as shown in the [Figure 2-6](#).

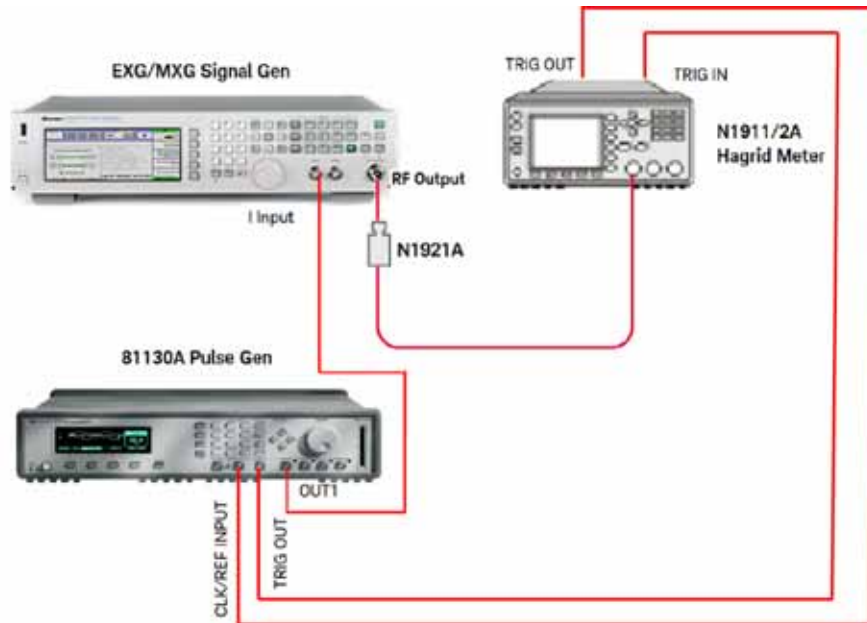

Figure 2-6 System-level rise and fall time performance test setup

2 Performance Tests and Adjustments

- 5 Download the Wideband Power Sensor System Rise Fall Time Verification Utility from the link below.

<http://www.keysight.com/main/redirector.jsp?action=ref&strnid=00&cname=EDITORIAL&ckey=2965131&cc=US&lc=eng&NEWCCLC=USeng>

- 6 Go through the readme file. Establish a GPIB connection between the signal generator, power meter, and the PC by using the USB/GPIB interface and a GPIB cable.
- 7 Go through the readme file.
- 8 Run the Wideband Power Sensor System Rise Fall Time Verification Utility and verify the Rise Time, Fall Time and Overshoot. Measure value against the system specification for the Off-bandwidth selection.
- 9 Compare the measure readings against the system specification for the Off-bandwidth selection. If the test fails, refer to **“Adjustment”** on page 42.

Zero Set Performance Test in System Level

Zero set is defined as the amount of residual offset error that is present following a zeroing operation. This offset error is caused by contamination from several sources, including circuit noise. This test is a system-level verification which requires N1911/2A.

Test equipment

- Signal generator (N5172B)
- Power meter (N1911/2A)
- Keysight USB/GPIB interface (82357B)
- GPIB cable
- Wideband power sensor (N1921/2A)
- PC

System specification

- No RF presence: ± 200 nW (frequency > 500 MHz and < 500 MHz)
- RF presence: ± 200 nW (frequency > 500 MHz)

Test procedure

- 1 Connect the N1921/2A to the N1911/2A.
- 2 Turn on N1911/2A and N5172B.
- 3 Set the GPIB address of the power meter (N1911/2A) and the signal generator (E4438C) to 13 and 19 respectively.
- 4 Connect the N1921/2A to the signal generator as shown in [Figure 2-7](#). Allow the system to warm up for approximately 30 minutes.

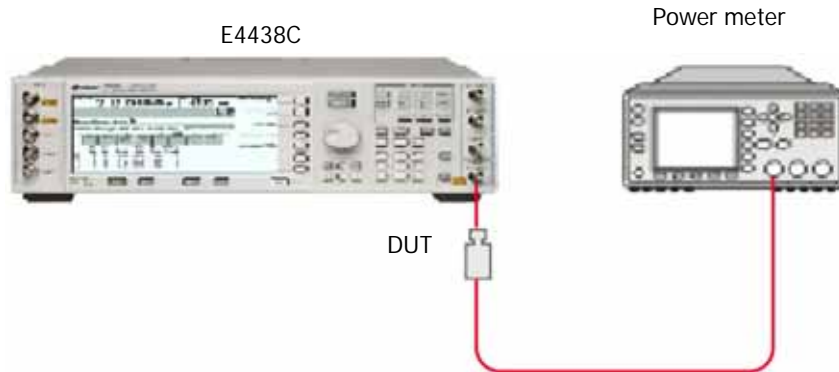

Figure 2-7 Zero set performance test in system level setup

- 5 Connect DUT to Power Meter Ref Osc, perform zero and cal.
- 6 Detach DUT from Power Meter Ref Osc and terminate the DUT with a load.
- 7 Launch Interactive IO on the Keysight IO Libraries Suite to send SCPI commands to the DUT.
- 8 Set the frequency of the DUT to 50 MHz by sending "FREQ 50 MHz".
- 9 Set the video bandwidth to OFF by sending "SENS:BAND:VID OFF".
- 10 Turn OFF the RF power of signal generator.
- 11 Enable auto-averaging for the DUT by sending "AVER:COUN:AUTO ON".
- 12 Change the power measurement unit of the DUT to watt by sending "UNIT:POW W".
- 13 Set the DUT to the single trigger mode by sending "INIT:CONT OFF".
- 14 Perform zeroing for the DUT by sending "CAL:ZERO:AUTO ONCE".

- 15 Read the noise level of the DUT by sending "READ?" and then record the reading.
- 16 Repeat [step 15](#) for 10 times, and then calculate the mean value of the readings.
- 17 Repeat [step 8](#) to [step 16](#) for frequency >500MHz.
- 18 For RF present, set the frequency of the DUT and signal generator to >500MHz.
- 19 Set the power level of signal generator to 20 dBm and turn ON the RF power.
- 20 Perform zeroing for the DUT by sending "CAL:ZERO:AUTO ONCE".
- 21 Turn OFF the RF power of signal generator.
- 22 Repeat [step 10](#) to [step 16](#).
- 23 Compare the calculated mean value to the system specification. If the verification fails, refer to "[Adjustment](#)" on page 42.

Adjustment

Adjustments are usually required on a yearly basis. They are normally performed only after a performance test has indicated that some parameters are out of specification. Performance tests must be completed after any repairs that may have altered the characteristics of the N1921/2A.

The N1921/2A is required to be returned to Keysight for adjustments. To arrange this, contact the Keysight Service Center. Refer to the last page of this guide for information.

3 Theory of Operation

Theory of Operation 44

Theory of Operation

The N1921/2A is integrated with the internal zeroing and calibration capability, which eliminates the need for sensor calibration using an external reference source.

Keysight's patented technology integrates a DC reference source and switching circuits into each N1921/2A, so you can zero and calibrate the N1921/2A while it is connected to a device-under-test. This feature removes the need for connection and disconnection from the calibration source, thereby reducing test times, measurement uncertainty, and wear and tear on connectors. It is especially useful in manufacturing and automated test environments where every second and every connection counts. The N1921/2A can be embedded within test fixtures without the need to switch in reference signals.

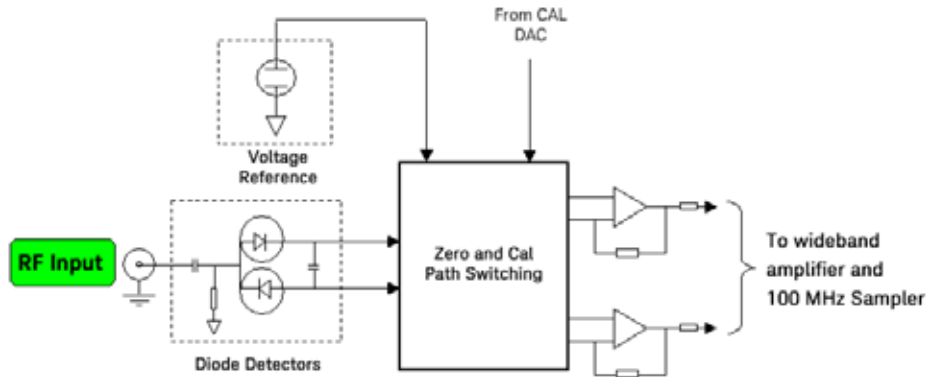

Figure 3-1 Simplified sensor block diagram

To ensure the accuracy of power measurements and improve measurement speed, the N1921/2A uses a four-dimensional (4-D) modeling technique that measures input power, frequency, temperature, and output voltage across the N1921/2A specified measurement ranges. Data from this 4-D model is generated during Keysight's initial factory calibration of the N1921/2A and stored in EEPROM.

All the compensation data is downloaded to the power meter/peak power analyzer at power-on or when the N1921/2A is connected. Advanced algorithms are used to quickly and accurately evaluate the N1921/2A against this model, without requiring the power meter/peak power analyzer to interpolate the calibration factors and linearity curves. If you run tests in which the frequency changes often, such as testing multi-carrier amplifiers on different bands, you will notice a marked improvement in measurement speed.

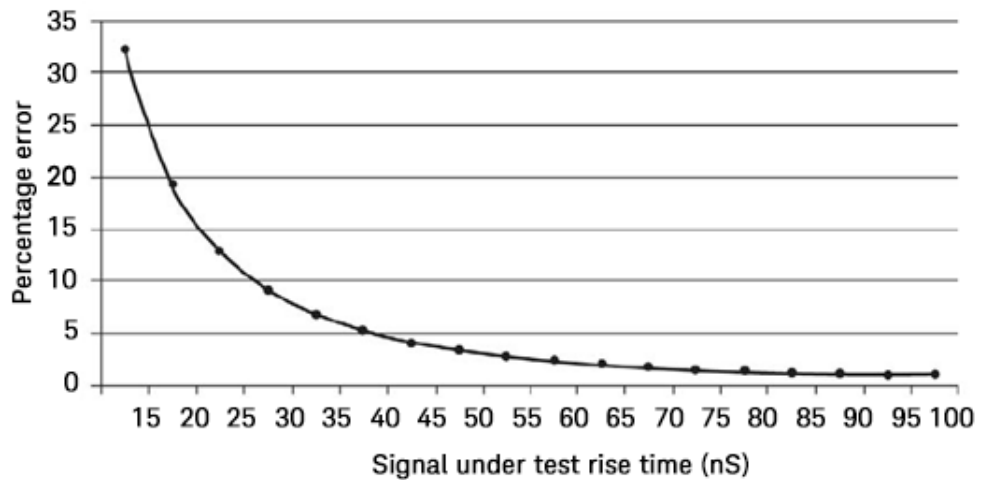

Figure 3-2 Measured rise time percentage error versus signal-under-test rise time

Although the rise time specification is ≤ 13 ns, this does not mean that the combination of P-Series power meter and power sensor can accurately measure a signal with a known rise time of 13 ns. The measured rise time is the root sum of the squares (RSS) of the signal-under-test rise time and the system rise time (13 ns):

$$\text{Measured rise time} = \sqrt{((\text{SignalUnderTestRiseTime})^2 + (\text{SystemRiseTime})^2)}$$

The % error is:

$$\% \text{Error} = \frac{(\text{MeasuredRiseTime} - \text{SignalUnderTestRiseTime})}{(\text{SignalUnderTestRiseTime})} \times 100$$

THIS PAGE HAS BEEN INTENTIONALLY LEFT BLANK.

4 Characteristics and Specifications

For the characteristics and specifications of the N1921A and N1922A P-Series Wideband Power Sensor, refer to the datasheet at <http://literature.cdn.keysight.com/litweb/pdf/5989-2471EN.pdf>.

THIS PAGE HAS BEEN INTENTIONALLY LEFT BLANK.

5 Service

General Information 50

General Information

This chapter contains information about general maintenance, performance tests, troubleshooting and repair of the P-Series Wideband Power Sensors.

Cleaning

Use a clean, damp cloth to clean the body of the P-Series Wideband Power Sensor.

Connector cleaning

The RF connector beads deteriorate when contacted by hydrocarbon compounds such as acetone, trichloroethylene, carbon tetrachloride, and benzene.

Clean the connector only at a static free workstation. Electrostatic discharge to the center pin of the connector will render the power sensor inoperative.

Keeping in mind its flammable nature; a solution of pure isopropyl or ethyl alcohol can be used to clean the connector.

Clean the connector face using a cotton swab dipped in isopropyl alcohol. If the swab is too big use a round wooden toothpick wrapped in a lint free cotton cloth dipped in isopropyl alcohol.

Performance test

The Performance and Calibration Tests require the sensor to be returned to the factory.

To arrange this contact the service centre. See [“Sales and Technical Support”](#) on page 8 for this information.

Repair of defective sensor

There are no serviceable parts inside the P-Series Wideband Power Sensors. If the sensor is defective, it needs to be returned to a Keysight service center.

Troubleshooting

The maximum measurable power of a power sensor varies depending on the sensor model. Incidentally, Keysight Technologies' service centers receive a high number of power sensor that have been damaged due to overpowering of the sensor bulkhead, resulting in the damage of the internal thin film circuit. Subjecting a power sensor module above its maximum allowable power rating is considered a misuse or self-abuse and is excluded from Keysight Technologies' standard warranty coverage.

For more details, refer to the *Power Sensor Overpower Failure Verification Guideline* at <https://literature.cdn.keysight.com/litweb/pdf/5992-4039EN.pdf>

THIS PAGE HAS BEEN INTENTIONALLY LEFT BLANK.



This information is subject to change without notice. Always refer to the Keysight website for the latest revision.

© Keysight Technologies 2005 - 2021
Edition 12, November 1, 2021

Printed in Malaysia



N1920-90007

www.keysight.com